

1.14. **KDBJ55K160W - Panel spacer**





• **Combination with the decoration panel**



Be sure to check the combination of panel spacer and decoration panel.

Panel spacer	KDBJ55K160W
Decoration panel	BYC125K-W1 BYC125KJW1

• **Contents of kit**

Prior to installation check whether you have the complete kit of parts as shown below including the installation manual.

Part	Panel spacer frame	Resin corner part	Fixing metal	Screws
Quantity	4 set	4 set	4 set	28 set
Shape-number	① 	② 	③ 	④ 

Part	Sealing material	Caution label
Quantity	2 set	2 set
Quantity	2 set	1 set
Shape-number	⑤ 	⑥ 
		⑦ 

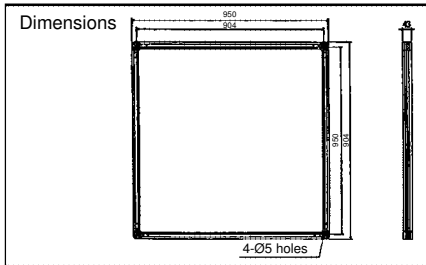
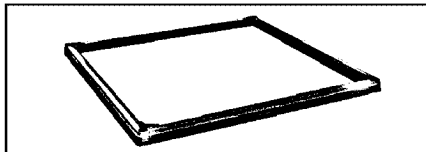

- Using the panel spacer in areas of the ceiling with limited space makes it possible to install the air conditioner.
- Hides the gap between the decoration panel and the ceiling.

Item	Model	KDBJ55K160W
Color		White
Materials		Outside frame: aluminium extrusion and resin Insulation: foam polyethylene
Component		Panel spacer, insulation, sealant, mounting screws, installation manual
Weight (kg)		1.8

Caution

- When the panel spacer is installed, it is not possible to have 2-way air outlet.
- Refer to the installation manual for both indoor unit and the panel spacer for its installation.

① **Preparation of decoration panel**

• **Handle the decoration panel with care**

Never place the panel face down, or lean the panel against wall or place on the projective object. (It causes dent or damage of the surface of the panel or damage of swing motor.)

- (1) Remove the suction grille from the decoration panel.
(Refer to the installation manual of the decoration panel how to remove)
- (2) Place the panel face down on the corrugated cardboard or the vinyl sheet to protect the surface of the panel.

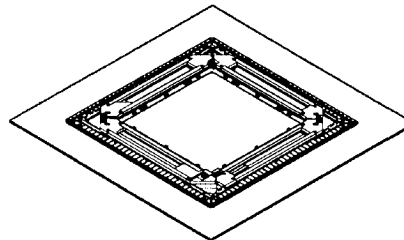

② **Installation of the indoor unit**

Adjust the height of the indoor unit.

Be sure piping will not contact with the ceiling joist etc. after adjusting the height.

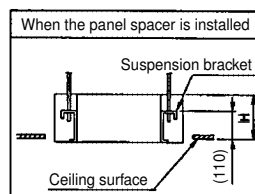
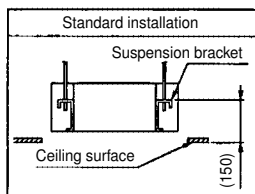

Indoor unit	H
25-63 type	200
80-125 type	260

(B0236)

③ Assembly of panel spacer

(1) Assemble the panel spacer frame ① and the plastic corner joint ② temporarily.

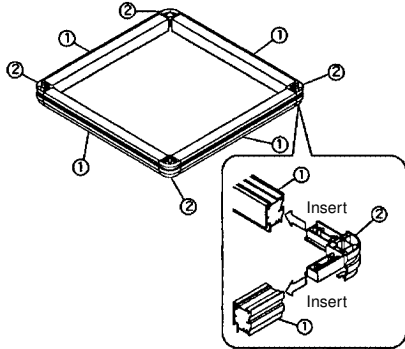

(2) Fix with the screws 4 from the top. (4 screws in each corner)

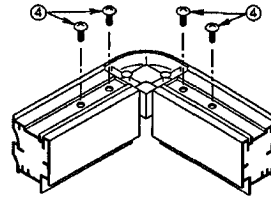

④ Fixing to the decoration panel

(1) Set the fixing metal ③ on each corner with screws ④.

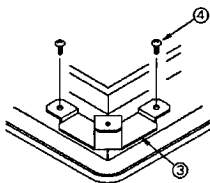

(2) Place the panel spacer assembled in item ③ of the above on the outer frame of the decoration panel.

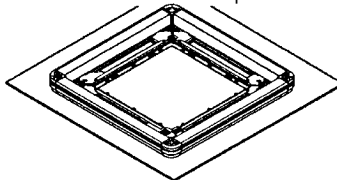

(3) Fix the panel spacer to the fixing metal ③ with screws ④ (4 portions).

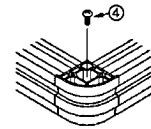

⑤ Adhesion of the sealing material

Adhere the sealing material ⑤ ⑥ on the upper face of the panel spacer in the order of ⑤ and ⑥.

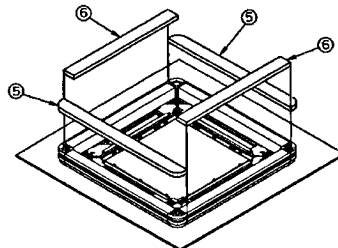

Sticking reference

(Adhere it along the inner rib.)

Sealing material

⑤ ⑥

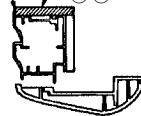

⑤ Installation of decoration panel

(1) Install the decoration panel to the indoor unit according to the installation manual of panel spacer.

The panel spacer is not firmly fixed to the decoration panel, so never hold the panel spacer directly or lean on the decoration panel extremely.

(2) After installing the decoration panel, adhere the caution sticker ⑦ next to the name plate of the indoor unit as shown on the right.

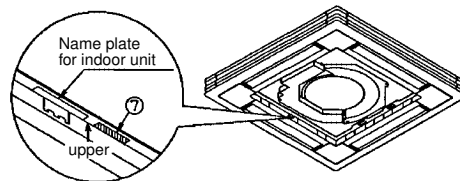

JC : 1P011178C