



IMPROPER INSTALLATION OR ATTACHMENT OF EQUIPMENT OR ACCESSORIES COULD RESULT IN ELECTRIC SHOCK, SHORT-CIRCUIT, LEAKS, FIRE OR OTHER DAMAGE TO THE EQUIPMENT. BE SURE ONLY TO USE ACCESSORIES MADE BY DAIKIN WHICH ARE SPECIFICALLY DESIGNED FOR USE WITH THE EQUIPMENT AND HAVE THEM INSTALLED BY A PROFESSIONAL.

IF UNSURE OF INSTALLATION PROCEDURES OR USE, ALWAYS CONTACT YOUR DAIKIN DEALER FOR ADVICE AND INFORMATION.

**THIS KIT INCLUDES THE FOLLOWING PARTS**

model	liquid header	discharge gas header	suction gas header	closing pipes	reducer/expander pipe	header heat insulation material	closing pipe heat insulation material	liquid header outlet heat insulation material
KHRQM22M29H8				13 pieces	3 pipes			
KHRQM22M64H8				13 pieces	6 pipes			
KHRQM22M75H8				13 pieces	11 pipes			
KHRQM23M29H8				19 pieces	5 pipes			
KHRQM23M64H8				19 pieces	12 pipes			
KHRQM23M75H8				19 pieces	26 pipes			

**DIMENSIONS OF THE PIPING**

Header dimensions

	liquid header	discharge gas header	suction gas header
KHRQM22M29H8	<p>closing pipes B, 6x E reducer or expander pipes 3</p>	—	<p>closing pipes 6x C reducer or expander pipes 10, 11</p>
KHRQM22M64H8	<p>closing pipes B, 6x E reducer or expander pipes 3, 2x 12, 15</p>	—	<p>closing pipes 6x C reducer or expander pipes 2x 11</p>
KHRQM22M75H8	<p>closing pipes A, 6x D reducer or expander pipes 5, 7, 4x 16</p>	—	<p>closing pipes 6x B reducer or expander pipes 4x 4, 9</p>
KHRQM23M29H8	<p>closing pipes B, 6x E reducer or expander pipes 3</p>	<p>closing pipes 6x D reducer or expander pipes 5, 15</p>	<p>closing pipes 6x C reducer or expander pipes 10, 11</p>

	liquid header	discharge gas header	suction gas header
KHRQM23M64H8	<p>closing pipes B, 6x E reducer or expander pipes 3, 2x 12, 15</p>	<p>closing pipes 6x D reducer or expander pipes 8, 2x 13, 3x 15</p>	<p>closing pipes 6x C reducer or expander pipes 2x 11</p>
KHRQM23M75H8	<p>closing pipes A, 6x D reducer or expander pipes 2, 5, 7, 4x 16</p>	<p>closing pipes 6x C reducer or expander pipes 5x 1, 14, 6x 15</p>	<p>closing pipes 6x B reducer or expander pipes 5x 4, 6, 9</p>

### Closing pipe dimensions

<b>A</b>		<b>B</b>		<b>C</b>	
<b>D</b>		<b>E</b>			

### Reducer/expander pipe dimensions

<b>1</b>		<b>2</b>		<b>3</b>	
<b>4</b>		<b>5</b>		<b>6</b>	
<b>7</b>		<b>8</b>		<b>9</b>	
<b>10</b>		<b>11</b>		<b>12</b>	
<b>13</b>		<b>14</b>		<b>15</b>	
<b>16</b>					

## INSTALLATION PROCEDURE

- For the outlet/inlet pipings which can be connected in several piping sizes, cut the connections of the required pipe diameter with a pipe cutter.

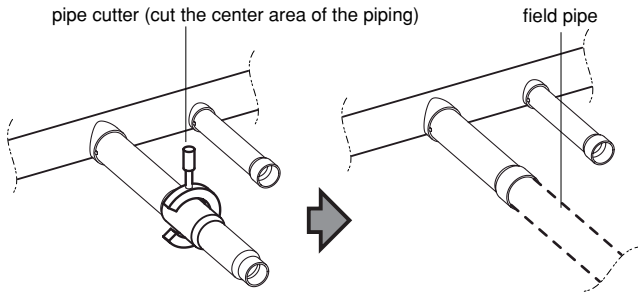

- Use the supplied reducer/expander pipes when necessary

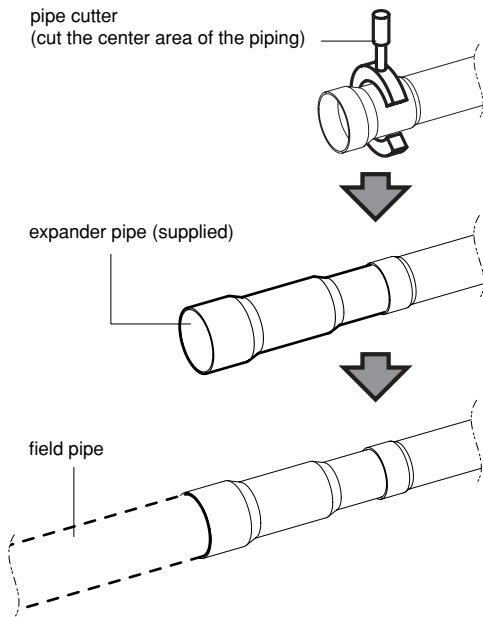

- For non-connected outlet pipes, close the connections with closing pipes (supplied).

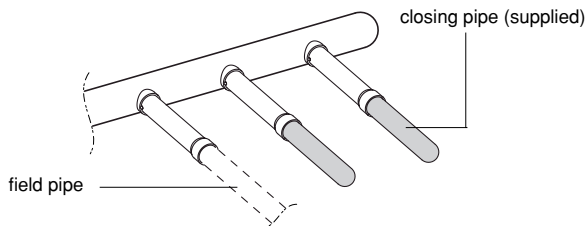

- For connecting the field piping to the inlet of the liquid header: Depending on the connection side, attach the expander pipe (supplied) and the closing pipe (supplied).

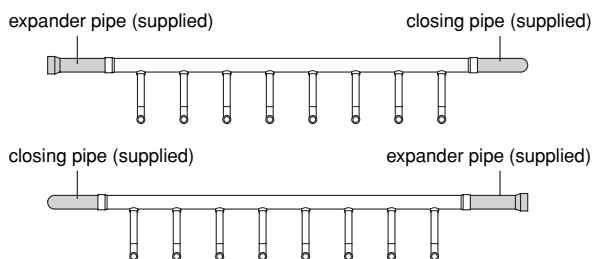

## INSTALLATION PRECAUTIONS

**!** Make sure to flow nitrogen gas through the pipe when brazing.

**!** Make sure to avoid stress on headers. Do not tighten fixations too hard. (Copper tube length changes considerably under temperature fluctuations.)

### Installation orientation

#### Liquid header

Suspend the header to the ceiling, and be sure to install it so that the outlet pipes are horizontal at the lower side.

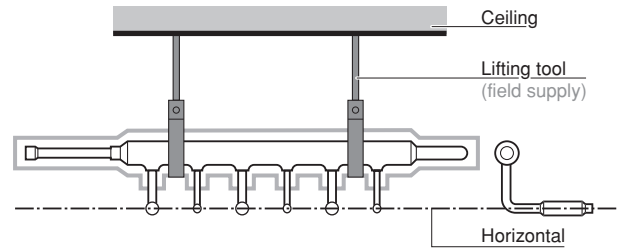

#### Gas header

Place the header on a pedestal and install it so that it is horizontal.

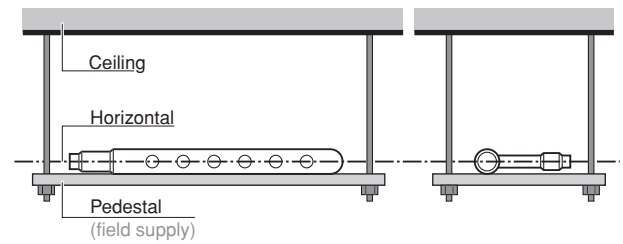

## Heat insulation

Be sure to insulate the header against heat.

### Liquid header

- Example of connected liquid header.

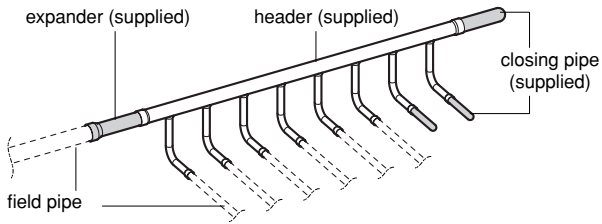

- Use the supplied heat insulation material to insulate the headers against heat.

cut the end parts to allow inserting the field piping

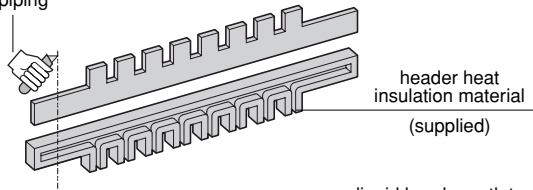

cut the end part to allow inserting the field piping (do not cut in case of closing pipes)

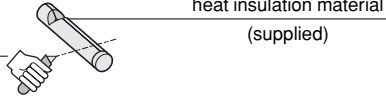

- Apply the heat insulation material and seal all connections with tape.

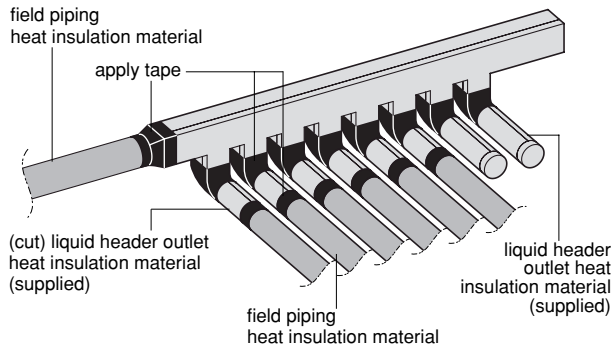

### Gas header

- Example of connected gas header.

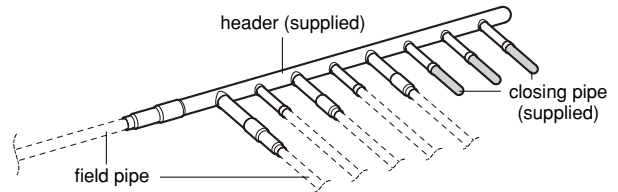

- Use the supplied heat insulation material to insulate the headers against heat.

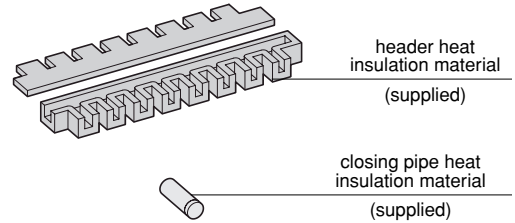

- Apply the heat insulation material and seal all connections with tape.

