

Service Manual

Sky Air
CMSQ200A7W1B, 250A7W1B
FMCQ50-125A7VEB
FMDQ50-125A7V3B
R-410A Heat Pump 50Hz



CMS R-410A Heat Pump 50Hz

1. Introduction	vi
1.1 Safety Cautions	vi
1.2 PREFACE	x

Part 1 General Information 1

1. Model Names of Indoor/Outdoor Units.....	2
2. External Appearance.....	3
2.1 Indoor Units	3
2.2 Outdoor Units	3
3. Combination	4
3.1 Combination Overview	4
3.2 Combination Matrix	4
4. Model Selection.....	5

Part 2 Specifications 7

1. Specifications	8
1.1 Outdoor Units	8
1.2 Indoor Units	11

Part 3 Refrigerant Circuit 15

1. Refrigerant Circuit	16
1.1 CMSQ200A7	16
1.2 CMSQ250A7	18
2. Functional Parts Layout	20
2.1 CMSQ200A7	20
2.2 CMSQ250A7	21
3. Refrigerant Flow for Each Operation Mode.....	22

Part 4 Function..... 31

1. Function General.....	32
1.1 Symbol	32
1.2 Operation Mode.....	33
2. Basic Control.....	34
2.1 Normal Operation	34
2.2 Compressor PI Control.....	35
2.3 Electronic Expansion Valve PI Control.....	37
2.4 Step Control of Outdoor Unit Fans	37
2.5 Outdoor Unit Fan Control in Cooling Operation	38
3. Special Control.....	39
3.1 Startup Control	39
3.2 Oil Return Operation	40
3.3 Defrosting Operation	42
3.4 Pump-down Residual Operation	43
3.5 Standby	44

3.6	Stopping Operation	45
4.	Protection Control	47
4.1	High Pressure Protection Control.....	47
4.2	Low Pressure Protection Control.....	48
4.3	Discharge Pipe Protection Control	49
4.4	Inverter Protection Control	50
4.5	Injection Control (only for CMSQ200A7).....	51
5.	Other Control.....	52
5.1	Demand Operation	52
5.2	Heating Operation Prohibition	52
6.	Outline of Control (Indoor Unit)	53
6.1	Drain Pump Control.....	53
6.2	Louver Control for Preventing Ceiling Dirt.....	55
6.3	Thermostat Sensor in remote control	56
6.4	Thermostat Control while in Normal Operation	58
6.5	Thermostat Control in Dry Operation	58
6.6	Electronic Expansion Valve Control	59
6.7	Hot Start Control (In Heating Operation Only).....	59
6.8	Freeze Prevention	60
6.9	Heater Control	60
6.10	List of Swing Flap Operations	61

Part 5 Test Operation 63

1.	Test Operation	64
1.1	Installation Process	64
1.2	Procedure and Outline	65
1.3	Operation when Power is Turned On	80
2.	Outdoor Unit PC Board Layout	81
3.	Field Setting	82
3.1	Field Setting from remote control	82
3.2	Field Setting from Outdoor Unit.....	96

Part 6 Troubleshooting 119

1.	Symptom-based Troubleshooting	121
2.	Troubleshooting by remote control.....	124
2.1	The INSPECTION / TEST Button.....	124
2.2	Self-diagnosis by Wired remote control.....	125
2.3	Self-diagnosis by infrared remote control.....	126
2.4	remote control Service Mode	129
2.5	remote control Self-Diagnosis Function	131
3.	Troubleshooting by Indication on the remote control	138
3.1	“R0” Indoor Unit: Error of External Protection Device	138
3.2	“R1” Indoor Unit: PC Board Defect.....	139
3.3	“R3” Indoor Unit: Malfunction of Drain Level Control System (S1L)	140
3.4	“R5” Indoor Unit: Fan Motor (M1F) Lock, Overload.....	142
3.5	“R9” Indoor Unit: Malfunction of Moving Part of Electronic Expansion Valve (Y1E).....	143
3.6	“RF” Indoor Unit: Drain Level above Limit.....	145
3.7	“RJ” Indoor Unit: Malfunction of Capacity Determination Device	146

3.8	“CY” Indoor Unit: Malfunction of Thermistor (R2T) for Heat Exchanger.....	147
3.9	“CS” Indoor Unit: Malfunction of Thermistor (R3T) for Gas Pipes.....	148
3.10	“CG” Indoor Unit: Malfunction of Thermistor (R1T) for Suction Air.....	149
3.11	“CL” Indoor Unit: Malfunction of Humidity Sensor System.....	150
3.12	“CJ” Indoor Unit: Malfunction of Thermostat Sensor in remote control	151
3.13	“E1” Outdoor Unit: PC Board Defect	152
3.14	“E3” Outdoor Unit: Actuation of High Pressure Switch	153
3.15	“E4” Outdoor Unit: Actuation of Low Pressure Sensor	155
3.16	“E5” Outdoor Unit: Inverter Compressor Motor Lock.....	157
3.17	“E7” Outdoor Unit: Malfunction of Outdoor Unit Fan Motor	159
3.18	“E9” Outdoor Unit: Malfunction of Moving Part of Electronic Expansion Valve (Y1E, Y2E).....	162
3.19	“F3” Outdoor Unit: Abnormal Discharge Pipe Temperature	164
3.20	“F5” Outdoor Unit: Refrigerant Overcharged.....	165
3.21	“H7” Outdoor Unit: Abnormal Outdoor Fan Motor Signal.....	166
3.22	“H9” Outdoor Unit: Malfunction of Thermistor (R1T) for Outdoor Air.....	167
3.23	“J3” Outdoor Unit: Malfunction of Discharge Pipe Thermistor (R3T)	168
3.24	“J5” Outdoor Unit: Malfunction of Thermistor (R2T, R7T) for Suction Pipe	169
3.25	“J6” Outdoor Unit: Malfunction of Thermistor (R4T) for Outdoor Unit Heat Exchanger	170
3.26	“J7” Outdoor Unit: Malfunction of Liquid Pipe Thermistor (R6T).....	171
3.27	“J9” Outdoor Unit: Malfunction of Subcooling Heat Exchanger Gas Pipe Thermistor (R5T).....	172
3.28	“JA” Outdoor Unit: Malfunction of High Pressure Sensor.....	173
3.29	“JC” Outdoor Unit: Malfunction of Low Pressure Sensor.....	174
3.30	“L4” Outdoor Unit: Malfunction of Inverter Radiating Fin Temperature Rise.....	175
3.31	“L5” Outdoor Unit: Inverter Compressor Abnormal	177
3.32	“LB” Outdoor Unit: Inverter Current Abnormal.....	179
3.33	“L9” Outdoor Unit: Inverter Start Up Error	181
3.34	“LC” Outdoor Unit: Malfunction of Transmission Between Inverter and Control PC Board	183
3.35	“P1” Outdoor Unit: Inverter Over-Ripple Protection	186
3.36	“P4” Outdoor Unit: Malfunction of Inverter Radiating Fin Temperature Rise Sensor.....	187
3.37	“PJ” Outdoor Unit: Faulty Field Setting after Replacing Main PC Board or Faulty Combination of PC Board	189
3.38	“UD” Outdoor Unit: Low Pressure Drop Due to Refrigerant Shortage or Electronic Expansion Valve Failure.....	190
3.39	“U1” Reverse Phase, Open Phase.....	191
3.40	“U2” Outdoor Unit: Power Supply Insufficient or Instantaneous Failure	192
3.41	“U3” Outdoor Unit: Check Operation not Executed	195
3.42	“U4” Malfunction of Transmission Between Indoor Units	196
3.43	“U5” Indoor Unit: Malfunction of Transmission Between remote control and Indoor Unit.....	198
3.44	“U7” Indoor Unit: Malfunction of Transmission Between Outdoor Units	199
3.45	“U8” Indoor Unit: Malfunction of Transmission Between Main and Sub remote controls	201

3.46	“UG” Indoor Unit: Malfunction of Transmission Between Indoor and Outdoor Units in the Same System.....	202
3.47	“UR” Improper Combination of Indoor and Outdoor Units, Indoor Units and remote control.....	203
3.48	“UL” Address Duplication of Centralized Controller.....	205
3.49	“UE” Malfunction of Transmission Between Centralized Controller and Indoor Unit.....	206
3.50	“UF” System is not Set yet.....	209
3.51	“UH” Malfunction of System, Refrigerant System Address Undefined.....	210
4.	Troubleshooting (OP: Central remote control).....	212
4.1	“m” PC Board Defect.....	212
4.2	“mB” Malfunction of Transmission Between Optional Controllers for Centralized Control.....	213
4.3	“mR” Improper Combination of Optional Controllers for Centralized Control.....	215
4.4	“mL” Address Duplication, Improper Setting.....	217
5.	Troubleshooting (OP: Unified ON/OFF Controller).....	220
5.1	Operation Lamp Blinks.....	220
5.2	Display “Under Centralized Control” Blinks (Repeats Single Blink).....	222
5.3	Display “Under Centralized Control” Blinks (Repeats Double Blink).....	225

Part 7 Appendix..... 229

1.	Piping Diagrams.....	230
1.1	Outdoor Unit.....	230
1.2	Indoor Unit.....	232
2.	Wiring Diagrams for Reference.....	233
2.1	Outdoor Unit.....	233
2.2	Field Wiring.....	235
2.3	Indoor Unit.....	236
3.	List of Electrical and Functional Parts.....	239
3.1	Outdoor Unit.....	239
3.2	Indoor Side.....	240
4.	Option List.....	241
4.1	Option List of Controllers.....	241
4.2	Option Lists (Outdoor Unit).....	243
5.	Example of connection (R-410A Type).....	245
6.	Thermistor Resistance / Temperature Characteristics.....	247
7.	Pressure Sensor.....	249
8.	Method of Checking the Inverter’s Power Transistors and Diode Modules.....	250
8.1	Method of Checking the Inverter’s Power Transistors and Diode Modules.....	250

Part 8 Precautions for New Refrigerant (R-410A)..... 253

1.	Precautions for New Refrigerant (R-410A).....	254
1.1	Outline.....	254
1.2	Refrigerant Cylinders.....	256
1.3	Service Tools.....	257







Index i

Drawings & Flow Charts v







1. Introduction







1.1 Safety Cautions

Cautions and Warnings

- Be sure to read the following safety cautions before conducting repair work.
- The caution items are classified into “ **Warning**” and “ **Caution**”. The “ **Warning**” items are especially important since they can lead to death or serious injury if they are not followed closely. The “ **Caution**” items can also lead to serious accidents under some conditions if they are not followed. Therefore, be sure to observe all the safety caution items described below.
- About the pictograms
 -  This symbol indicates an item for which caution must be exercised.
The pictogram shows the item to which attention must be paid.
 -  This symbol indicates a prohibited action.
The prohibited item or action is shown inside or near the symbol.
 -  This symbol indicates an action that must be taken, or an instruction.
The instruction is shown inside or near the symbol.
- After the repair work is complete, be sure to conduct a test operation to ensure that the equipment operates normally, and explain the cautions for operating the product to the customer



1.1.1 Caution in Repair



 Warning	
Be sure to disconnect the power cable plug from the plug socket before disassembling the equipment for a repair. Working on the equipment that is connected to a power supply can cause an electrical shock. If it is necessary to supply power to the equipment to conduct the repair or inspecting the circuits, do not touch any electrically charged sections of the equipment.	
If the refrigerant gas discharges during the repair work, do not touch the discharging refrigerant gas. The refrigerant gas can cause frostbite.	
When disconnecting the suction or discharge pipe of the compressor at the welded section, release the refrigerant gas completely at a well-ventilated place first. If there is a gas remaining inside the compressor, the refrigerant gas or refrigerating machine oil discharges when the pipe is disconnected, and it can cause injury.	
If the refrigerant gas leaks during the repair work, ventilate the area. The refrigerant gas can generate toxic gases when it contacts flames.	
The step-up capacitor supplies high-voltage electricity to the electrical components of the outdoor unit. Be sure to discharge the capacitor completely before conducting repair work. A charged capacitor can cause an electrical shock.	
Do not start or stop the air conditioner operation by plugging or unplugging the power cable plug. Plugging or unplugging the power cable plug to operate the equipment can cause an electrical shock or fire.	

 Caution	
Do not repair the electrical components with wet hands. Working on the equipment with wet hands can cause an electrical shock.	
Do not clean the air conditioner by splashing water. Washing the unit with water can cause an electrical shock.	
Be sure to provide the grounding when repairing the equipment in a humid or wet place, to avoid electrical shocks.	
Be sure to turn off the power switch and unplug the power cable when cleaning the equipment. The internal fan rotates at a high speed, and cause injury.	
Do not tilt the unit when removing it. The water inside the unit can spill and wet the furniture and floor.	
Be sure to check that the refrigerating cycle section has cooled down sufficiently before conducting repair work. Working on the unit when the refrigerating cycle section is hot can cause burns.	
Use the welder in a well-ventilated place. Using the welder in an enclosed room can cause oxygen deficiency.	





1.1.2 Cautions Regarding Products after Repair



 Warning	
Be sure to use parts listed in the service parts list of the applicable model and appropriate tools to conduct repair work. Never attempt to modify the equipment. The use of inappropriate parts or tools can cause an electrical shock, excessive heat generation or fire.	
When relocating the equipment, make sure that the new installation site has sufficient strength to withstand the weight of the equipment. If the installation site does not have sufficient strength and if the installation work is not conducted securely, the equipment can fall and cause injury.	
Be sure to install the product correctly by using the provided standard installation frame. Incorrect use of the installation frame and improper installation can cause the equipment to fall, resulting in injury.	For integral units only
Be sure to install the product securely in the installation frame mounted on a window frame. If the unit is not securely mounted, it can fall and cause injury.	For integral units only
Be sure to use an exclusive power circuit for the equipment, and follow the technical standards related to the electrical equipment, the internal wiring regulations and the instruction manual for installation when conducting electrical work. Insufficient power circuit capacity and improper electrical work can cause an electrical shock or fire.	

 Warning	
Be sure to use the specified cable to connect between the indoor and outdoor units. Make the connections securely and route the cable properly so that there is no force pulling the cable at the connection terminals. Improper connections can cause excessive heat generation or fire.	
When connecting the cable between the indoor and outdoor units, make sure that the terminal cover does not lift off or dismount because of the cable. If the cover is not mounted properly, the terminal connection section can cause an electrical shock, excessive heat generation or fire.	
Do not damage or modify the power cable. Damaged or modified power cable can cause an electrical shock or fire. Placing heavy items on the power cable, and heating or pulling the power cable can damage the cable.	
Do not mix air or gas other than the specified refrigerant (R-410A) in the refrigerant system. If air enters the refrigerating system, an excessively high pressure results, causing equipment damage and injury.	
If the refrigerant gas leaks, be sure to locate the leak and repair it before charging the refrigerant. After charging refrigerant, make sure that there is no refrigerant leak. If the leak cannot be located and the repair work must be stopped, be sure to perform pump-down and close the service valve, to prevent the refrigerant gas from leaking into the room. The refrigerant gas itself is harmless, but it can generate toxic gases when it contacts flames, such as fan and other heaters, stoves and ranges.	
When replacing the coin battery in the remote control, be sure to disposed of the old battery to prevent children from swallowing it. If a child swallows the coin battery, see a doctor immediately.	

 Caution	
Installation of a leakage breaker is necessary in some cases depending on the conditions of the installation site, to prevent electrical shocks.	
Do not install the equipment in a place where there is a possibility of combustible gas leaks. If a combustible gas leaks and remains around the unit, it can cause a fire.	
Be sure to install the packing and seal on the installation frame properly. If the packing and seal are not installed properly, water can enter the room and wet the furniture and floor.	For integral units only

1.1.3 Inspection after Repair





 Warning	
Check to make sure that the power cable plug is not dirty or loose, then insert the plug into a power outlet all the way. If the plug has dust or loose connection, it can cause an electrical shock or fire.	
If the power cable and lead wires have scratches or deteriorated, be sure to replace them. Damaged cable and wires can cause an electrical shock, excessive heat generation or fire.	
Do not use a joined power cable or extension cable, or share the same power outlet with other electrical appliances, since it can cause an electrical shock, excessive heat generation or fire.	

 Caution	
Check to see if the parts and wires are mounted and connected properly, and if the connections at the soldered or crimped terminals are secure. Improper installation and connections can cause excessive heat generation, fire or an electrical shock.	
If the installation platform or frame has corroded, replace it. Corroded installation platform or frame can cause the unit to fall, resulting in injury.	
Check the grounding, and repair it if the equipment is not properly grounded. Improper grounding can cause an electrical shock.	
Be sure to measure the insulation resistance after the repair, and make sure that the resistance is 1 Mohm or higher. Faulty insulation can cause an electrical shock.	
Be sure to check the drainage of the indoor unit after the repair. Faulty drainage can cause the water to enter the room and wet the furniture and floor.	

1.1.4 Using Icons

Icons are used to attract the attention of the reader to specific information. The meaning of each icon is described in the table below:

1.1.5 Using Icons List

Icon	Type of Information	Description
 Note:	Note	A “note” provides information that is not indispensable, but may nevertheless be valuable to the reader, such as tips and tricks.
 Caution	Caution	A “caution” is used when there is danger that the reader, through incorrect manipulation, may damage equipment, lose data, get an unexpected result or has to restart (part of) a procedure.
 Warning	Warning	A “warning” is used when there is danger of personal injury.
	Reference	A “reference” guides the reader to other places in this binder or in this manual, where he/she will find additional information on a specific topic.

1.2 PREFACE

Thank you for your continued patronage of Daikin products.

This is the new service manual for Daikin's Year 2008 CMSQ-A series Heat Pump System. Daikin offers a wide range of models to respond to building and office air conditioning needs. We are confident that customers will be able to find the models that best suit their needs.

This service manual contains information regarding the servicing of CMSQ-A series R-410A Heat Pump System.

November, 2008

After Sales Service Division

Part 1

General Information

1. Model Names of Indoor/Outdoor Units.....	2
2. External Appearance.....	3
2.1 Indoor Units.....	3
2.2 Outdoor Units.....	3
3. Combination.....	4
3.1 Combination Overview.....	4
3.2 Combination Matrix.....	4
4. Model Selection.....	5

1. Model Names of Indoor/Outdoor Units

Indoor Units

Type		Model Name					Power Supply
Ceiling Mounted Cassette Type (Round Flow)	FMCQ	50A	60A	71A	100A	125A	VE
Ceiling Mounted Built-In Type	FMDQ	50A	60A	71A	100A	125A	V3

Outdoor Units

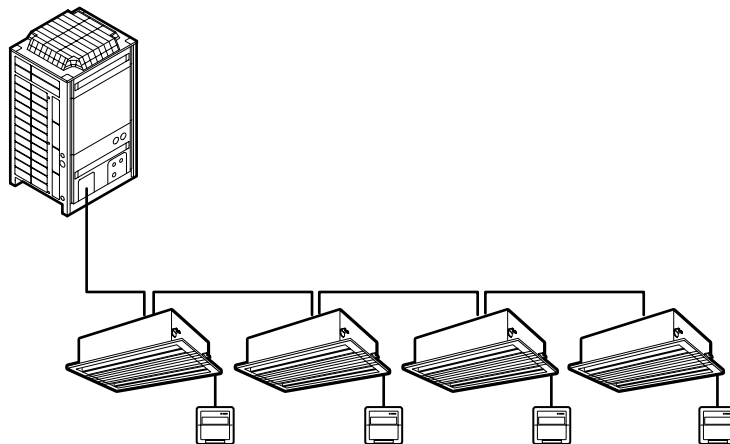

Series	Model Name						Power Supply	
Heat Pump	CMSQ	-	-	-	-	200A7	250A7	W1

*Power Supply
 VE : 1 phase 220~240V, 50Hz
 V3 : 1 phase 230V, 50Hz
 W1 : 3 phase 400V, 50Hz



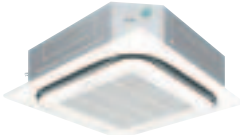

2. External Appearance

2.1 Indoor Units

<p>Ceiling Mounted Cassette Type (Round Flow)</p> <p>FMCQ50A FMCQ60A FMCQ71A FMCQ100A FMCQ125A</p> 	<p>Ceiling Mounted Built-In Type</p> <p>FMDQ50A FMDQ60A FMDQ71A FMDQ100A FMDQ125A</p> 
--	---

2.2 Outdoor Units

CMSQ200A7	CMSQ250A7
	

3. Combination

3.1 Combination Overview

Model Name	FMCQ50A7VEB	FMCQ60A7VEB	FMCQ71A7VEB	FMCQ100A7VEB	FMCQ125A7VEB	FMDQ50A7V3B	FMDQ60A7V3B	FMDQ71A7V3B	FMDQ100A7V3B	FMDQ125A7V3B
CMSQ200A7W1B	4	3		2		4	3		2	
CMSQ250A7W1B			3		2			3		2

Notes: Explanation of connection (2~4)
 2: Twin
 3: Triple
 4: Double twin

3.2 Combination Matrix

Outdoor models	Possible indoor combination		
	Simultaneous operation		
	Twin	Triple	Double Twin
CMSQ200A7W1B	100-100(71)	71-60-50(60) 60-60-60 100-50-50	50-50-50-50
CMSQ250A7W1B	125-125(100)	71-71-71 100-100(71)-50(60)	60-60-60-60 71-60-60-50 71-71-50-50

Notes: Possible indoor types:
 FMCQ50A7VEB-125A7VEB
 FMDQ50A7V3B-125A7V3B

4. Model Selection

Connectable Indoor Unit

Type		Model Name					Power Supply
Ceiling Mounted Cassette Type (Multi Flow)	FMCQ	50A	60A	71A	100A	125A	VE
Ceiling Mounted Built-In Type	FMDQ	50A	60A	71A	100A	125A	V3

Indoor unit capacity

New refrigerant model code	P50 type	P60 type	P71 type	P100 type	P125 type
Selecting model capacity	5.0~5.6kW	6.0~7.0kW	7.1~8.0kW	10.0~11.2kW	12.5~14.0kW
Equivalent output	2.0HP	2.3HP	2.5HP	4HP	5HP

Use the above tables to determine the capacities of indoor units to be connected. Make sure the total capacity of indoor units connected to each outdoor unit is within the specified value (kW).

- The total capacity of connected indoor units must be within a range of 50 to 100% of the rated capacity of the outdoor unit.
- In some models, it is not possible to connect the maximum number of connectable indoor units. Select models so the total capacity of connected indoor units conforms to the specification.

Part 2

Specifications

1. Specifications	8
1.1 Outdoor Units	8
1.2 Indoor Units	11

1. Specifications

1.1 Outdoor Units

CMSQ200, 250A7W1B Heat Pump 50Hz

TECHNICAL SPECIFICATIONS				CMSQ200A7W1B		CMSQ250A7W1B		
Capacity	Cooling	kW		20.0		25.0		
	Heating	kW		22.4		28.0		
COP	Cooling			3.03		3.71		
	Heating			3.86		4.10		
Capacity Range			HP	8		10		
Power Input (nominal)(50Hz)	Cooling	kW		6.60		6.74		
	Heating	kW		5.80		6.83		
PED Category				Category II				
Max No of Indoor Units to be Connected				4				
Indoor Index Connection	Minimum			100		125		
	Maximum			200		250		
Casing	Colour			Daikin White				
	Material			Painted Galvanised Steel				
Dimensions	Packing	Height	mm	1,855				
		Width	mm	796		1,055		
		Depth	mm	860				
	Unit	Height	mm	1,680				
		Width	mm	635		930		
		Depth	mm	765				
Weight	Unit		kg	159		187		
	Packed Unit		kg	182		217		
Packing	Material			Carton				
	Weight		kg	3.80		4.02		
	Material			Wood				
	Weight		kg	19.15		20.85		
	Material			Plastic				
	Weight		kg	0.215		0.265		
Heat Exchanger	Dimensions	Length	mm	1,483		1,778		
		Nr of Rows			54			
		Fin Pitch	mm	2.00				
		Nr of Passes			8		18	
		Face Area	m ²	1.762		2.112		
		Nr of Stages			2			
	Tube Type			Hi-XSS (8)				
	Fin	Fin Type			Non-symmetric Waffle Louvre			
		Treatment			Hydrophilic and Anti Corrosion Resistant			
	Fan	Type			Propeller			
Quantity			1					
Air Flow Rate (nominal at 230V)	Cooling	m ³ /min		95		171		
	Heating	m ³ /min		95		171		
Fan	External Static Pressure		Pa	50 Pa in High Static Pressure				
	Discharge Direction			Vertical				
	Motor	Quantity			1		1	
		Model			Brushless DC			
		Output Motor	W	350		750		
Compressor	Quantity			1				
	Motor	Quantity			1			
		Model			Inverter			
		Type			Hermetically Sealed Scroll Compressor			
		Speed	rpm	6,300		7,980		
		Motor Output	kW	2.8		3.8		
Crankcase Heater	W	33						
Cooling	Standard	Min	°CDB	-5.0				
Operation Range	Cooling	Max	°CDB	43.0				
		Heating	Min	°CWB	-20.0			
	Max		°CWB	15.0				

TECHNICAL SPECIFICATIONS				CMSQ200A7W1B	CMSQ250A7W1B
Sound level	Cooling	Sound Power (Nominal)	dBA	78	81
		Sound Pressure (Nominal)	dBA	57	59
	Night Quiet	Level 1 / Level 2 / Level 3	dBA	55 / 50 / 45	
Refrigerant	Name			R-410A	
	Charge		kg	6.2	7.7
	Control			Expansion Valve (Electronic Type)	
	Nr of Circuits			1	
Refrigerant Oil	Name			Synthetic (ether) Oil	
	Charged Volume		l	1.7	2.1
Piping connections	Liquid (OD)	Type		Braze Connection	
		Diameter (OD)	mm	9.52	
	Gas	Type		Braze Connection	
		Diameter (OD)	mm	15.9	19.1
	Heat Insulation			Both Liquid and Gas Pipes	
Max Total Length			m	200	
Defrost Method				Reversed Cycle	
Defrost Control				Sensor for Outdoor Heat Exchanger Temperature	
Capacity Control Method				Inverter Controlled	
Capacity Control				~ 100	
Safety Devices				HPS	
				Fan Motor Driver Overload Protector	
				Over Current Relay	
				Inverter Overload Protector	
				PC Board Fuse	
Standard Accessories	Standard Accessories			Installation Manual	
	Quantity			1	
	Standard Accessories			Operation Manual	
	Quantity			1	
	Standard Accessories			Connection Pipes	
Quantity			4		
Notes	Nominal cooling capacities are based on : indoor temperature : 27°CDB, 19°CWB, outdoor temperature : 35°CDB, equivalent refrigerant piping : 7.5m, level difference : 0m.				
	Nominal heating capacities are based on : indoor temperature : 20°CDB, outdoor temperature : 7°CDB, 6°CWB, equivalent refrigerant piping : 7.5m, level difference : 0m				
	Sound Pressure				
	Sound Values				
Sound values are measured in a semi-anechoic room.					

ELECTRICAL SPECIFICATIONS				CMSQ200A7W1B		CMSQ250A7W1B	
Power Supply	Name			W1			
	Phase			3N~			
	Frequency		Hz	50			
	Voltage		V	400			
Current	Nominal Running Current (RLA)	Cooling	A	9.53	9.73		
		Heating	A	8.38	9.86		
	Minimum Ssc Value		kVa			1,218	
	Minimum Circuit Amps (MCA)		A	11.9	18.5		
	Maximum Fuse Amps (MFA)		A	16	25		
	Total Overcurrent Amps (TOCA)		A	15.6	16.5		
Voltage Range	Full Load Amps (FLA)		A	0.4	0.7		
	Minimum		V	360			
Maximum		V	440				
Wiring Connections	For Power Supply	Quantity		5			
		Remark		Earth Wire Include			
	For connection with Indoor	Quantity		2			
		Remark		F1 - F2			
Power Supply Intake				Both Indoor and Outdoor Unit			
Notes	MFA is used to select the circuit breaker and the ground fault circuit interrupter (earth leakage circuit breaker)						
	MSC means the maximum current during start up of the compressor						
	Maximum allowable voltage range variation between phases is 2%						
	RLA is based on following conditions : indoor temperature : 27°CDB/19°CWB , outdoor temperature : 35°CDB						
	Select wire size based on the value of MCA or TOCA						
	TOCA means the total value of each OC set						
Voltage range : units are suitable for use on electrical systems where voltage supplied to unit terminal is not below or above listed range limits							

1.2 Indoor Units

FMCQ50-125A7VEB

FOR INDOOR UNITS ONLY			FMCQ50A7VEB	FMCQ60A7VEB	FMCQ71A7VEB	FMCQ100A7VEB	FMCQ125A7VEB
Nominal Input (Indoor only)	Cooling	kW	5.0	6.0	7.1	10.0	12.5
	Heating	kW	5.6	6.7	8.0	11.2	14.0

TECHNICAL SPECIFICATIONS				FMCQ50A7VEB	FMCQ60A7VEB	FMCQ71A7VEB	FMCQ100A7VEB	FMCQ125A7VEB
Casing	Material			Galvanised Steel Plate				
Dimensions	Packing	Height	mm	220	220	262	262	304
		Width	mm	882	882	882	882	882
		Depth	mm	882	882	882	882	882
	Unit	Height	mm	204	204	246	246	288
		Width	mm	840	840	840	840	840
		Depth	mm	840	840	840	840	840
Weight	Unit		kg	21	21	24	24	26
	Packed Unit		kg	26	26	28	28	31
Heat Exchanger	Dimensions	Length	mm	Inside: 2096, Outside: 2152				
		Nr of Rows		2	2	2	2	2
		Fin Pitch	mm	1.2	1.2	1.2	1.2	1.2
		Nr of Passes		7	7	9	9	11
		Face Area	m ²	0.357	0.357	0.446	0.446	0.535
		Nr of Stages		8	8	10	10	12
	Tube Type			Cross Fin Coil (Multi Louver Fins and Hi-XSS Tubes)				
Fan	Type			Turbo Fan				
	Quantity			1	1	1	1	1
Air Flow Rate	Cooling	High	m ³ /min	15.5	16.5	23.5	26.5	33.0
		Low	m ³ /min	10.0	11.0	14.5	17.0	20.0
	Heating	High	m ³ /min	15.0	17.5	23.5	28.0	33.0
		Low	m ³ /min	9.5	12.0	14.5	17.5	20.0
Fan	Motor	Model		QTS48D11M	QTS48D11M	QTS48C15M	QTS48C15M	QTS48C15M
		Number of Steps		2	2	2	2	2
		Output (high)	W	56	56	120	120	120
Cooling	Sound Power	High	dBA	51	52	55	58	61
		Low	dBA	28	29	32	33	34
	Sound Pressure	High	dBA	33	34	38	41	44
Low		dBA	28	29	32	33	34	
Heating	Sound Pressure	High	dBA	33	36	38	42	44
		Low	dBA	28	30	32	34	34
Sound Level	Sound Absorbing Insulation			Foamed Polyurethane				
Refrigerant	Type			R-410A				
Piping Connections	Liquid (OD)	Type		Flare Connection				
		Diameter (OD)	mm	6.35	9.52	9.52	9.52	9.52
	Gas	Type		Flare Connection				
		Diameter (OD)	mm	12.7	15.9	15.9	15.9	15.9
	Drain	Diameter (OD)		mm				
Heat Insulation	Foamed Polystyrene/Foamed Polyethylene							
Decoration Panel	Model			BYCQ140CW1				
	Colour			Pure White(RAL 9010)				
	Dimensions	H	mm	50	50	50	50	50
		W	mm	950	950	950	950	950
		D	mm	950	950	950	950	950
Weight		kg	5.5	5.5	5.5	5.5	5.5	
Air Filter	Resin Net with Mold Resistance							

TECHNICAL SPECIFICATIONS		FMCQ50A7VEB	FMCQ60A7VEB	FMCQ71A7VEB	FMCQ100A7VEB	FMCQ125A7VEB
Standard Accessories	Item	Operation Manual				
	Quantity	1	1	1	1	1
	Item	Installation Manual				
	Quantity	1	1	1	1	1
	Item	Drain Hose				
		Clamp for Drain Hose				
		Washer for Hanging Bracket				
		Screws				
		Installation Guide				
		Insulation for Fitting				
Sealing Pads						
Notes	Drain Sealing Pad					
	The sound pressure values are mentioned for a unit installed with rear suction					
	The sound power level is an absolute value indicating the power which a sound source generates.					
	Nominal cooling capacities are based on : indoor temperature : 27°CDB, 19°CWB, outdoor temperature : 35°CDB, equivalent refrigerant piping : 5m, level difference : 0m.					
	Nominal heating capacities are based on : indoor temperature : 20°CDB, outdoor temperature : 7°CDB, 6°CWB, equivalent refrigerant piping : 5m, level difference : 0m					
Capacities are net, including a deduction for cooling (an addition for heating) for indoor fan motor heat.						

ELECTRICAL SPECIFICATIONS		FMCQ50A7VEB	FMCQ60A7VEB	FMCQ71A7VEB	FMCQ100A7VEB	FMCQ125A7VEB
Power Supply	Name	VE				
	Phase	1~				
	Frequency	Hz	50/60			
	Voltage	V	220-240/220			

FMDQ50-125A7V3B

FOR INDOOR UNITS ONLY			FMDQ50A7V3B	FMDQ60A7V3B	FMDQ71A7V3B	FMDQ100A7V3B	FMDQ125A7V3B
Nominal Input (Indoor only)	Cooling	kW	5.0	6.0	7.1	10.0	12.5
	Heating	kW	5.6	6.7	8.0	11.2	14.0
Nominal Total Input Power	Cooling	kW	0.143	0.189	0.234	0.242	0.321
	Heating	kW	0.123	0.169	0.214	0.222	0.301

TECHNICAL SPECIFICATIONS				FMDQ50A7V3B	FMDQ60A7V3B	FMDQ71A7V3B	FMDQ100A7V3B	FMDQ125A7V3B	
Casing	Material			Unpainted Galvanised Steel					
Dimensions	Packing	Height	mm	355	355	355	355	355	
		Width	mm	892	1,192	1,592	1,592	1,592	
		Depth	mm	936	936	936	936	936	
	Unit	Height	mm	300	300	300	300	300	
		Width	mm	700	1,000	1,400	1,400	1,400	
		Depth	mm	800	800	800	800	800	
Weight	Unit	kg	31	41	51	51	52		
	Packed Unit	kg	37	48	59	59	60		
Required Ceiling Void			mm	>350					
Heat Exchanger	Dimensions	Length	mm	450	750	1,150	1,150	1,150	
		Nr of Rows		3	3	3	3	3	
		Fin Pitch	mm	1.75	1.75	1.75	1.75	1.75	
		Nr of Passes		4	7	10	10	10	
		Face Area	m ²	0.123	0.221	0.338	0.338	0.338	
		Nr of Stages		14	14	14	14	14	
	Tube Type	Hi-XSS (7)							
Fin	Type	Symmetric Waffle Louvre							
	Treatment	Hydrophilic							
Fan	Type	Sirocco Fan							
	Quantity		1	2	3	3	3		
Air Flow Rate	Cooling	High	m ³ /min	15	21	27	28	38	
		Low	m ³ /min	11	15.5	20	20.5	28	
	Heating	High	m ³ /min	15	21	27	28	38	
		Low	m ³ /min	11	15.5	20	20.5	28	
Fan	Max	High	Pa	136	123	141	141	109	
		Standard	Pa	114	111	125	125	93	
		Low	Pa	99	98				
	Motor	Quantity		1	1	1	1	1	
		Model		D18H2AB1V1	2D18H2AB1V1	3D18H2AH1V1	3D18H2AH1V1	3D18H2AG1V1	
		Number of Steps		Step Motor					
		Output (high)	W	85	125	135	135	225	
Drive		Direct drive							
Cooling	Sound Power	Medium	dBA	58	56	55	56	65	
	Sound Pressure	High	dBA	35	35	37	38	40	
		Low	dBA	31	30	31	33	35	
Heating	Sound Pressure	High	dBA	35	35	37	38	40	
		Low	dBA	31	30	31	33	35	
Refrigerant	Type	R-410A							
Piping Connections	Liquid (OD)	Type	Flare Connection						
		Diameter (OD)	mm	6.35	9.52	9.52	9.52	9.52	
	Gas	Type	Flare Connection						
		Diameter (OD)	mm	12.7	15.9	15.9	15.9	15.9	
	Drain	Diameter (OD)	mm	VP25 (O.D. 32 / I.D. 25)					
Heat Insulation	Both Liquid and Gas Pipes								
Drain-up Height				mm	600	600	600	600	600
Decoration Panel	Model				BYBS45DJW1	BYBS71DJW1	BYBS125DJW1	BYBS125DJW1	BYBS125DJW1
	Colour	White (10Y9/0,5)							
	Dimensions	H	mm	55	55	55	55	55	
		W	mm	800	1,100	1,500	1,500	1,500	
		D	mm	500	500	500	500	500	
Weight				kg	3.5	4.5	6.5	6.5	6.5

TECHNICAL SPECIFICATIONS		FMDQ50A7V3B	FMDQ60A7V3B	FMDQ71A7V3B	FMDQ100A7V3B	FMDQ125A7V3B
Air Filter	Resin net with Mold Resistance					
Air Direction Control	Up and Downwards					
Temperature Control	Microprocessor Thermostat for Cooling and Heating					
Safety Devices	PC Board Fuse					
	Drain Pump Fuse					
	Fan Motor Thermal Protector					
Notes	Nominal cooling capacities are based on : indoor temperature : 27°CDB, 19°CWB, outdoor temperature : 35°CDB, equivalent refrigerant piping : 8m, level difference : 0m.					
	Nominal heating capacities are based on : indoor temperature : 20°CDB, outdoor temperature : 7°CDB, 6°CWB, equivalent refrigerant piping : 8m, level difference : 0m					
	The external static pressure is changeable : change the connectors inside the electrical box, this pressure means : High static pressure - standard - low static pressure					
	The external static pressure is changeable : change the connectors inside the electrical box, this pressure means : High static pressure - standard					
	Capacities are net, including a deduction for cooling (an addition for heating) for indoor fan motor heat.					
The sound pressure values are mentioned for a unit installed with rear suction						

ELECTRICAL SPECIFICATIONS		FMDQ50A7V3B	FMDQ60A7V3B	FMDQ71A7V3B	FMDQ100A7V3B	FMDQ125A7V3B	
Power Supply	Name	V3					
	Phase	1~					
	Frequency	Hz	50	50	50	50	50
	Voltage	V	230	230	230	230	230

Part 3

Refrigerant Circuit

1. Refrigerant Circuit	16
1.1 CMSQ200A7	16
1.2 CMSQ250A7	18
2. Functional Parts Layout	20
2.1 CMSQ200A7	20
2.2 CMSQ250A7	21
3. Refrigerant Flow for Each Operation Mode.....	22

1. Refrigerant Circuit

1.1 CMSQ200A7

No. in refrigerant system diagram	Symbol	Name	Major Function
A	M1C	Inverter compressor (INV)	Inverter compressor is operated on frequencies between 52Hz and 188Hz by using the inverter. The number of operating steps is as follows when Inverter compressor is operated. CMSQ200A7 : 18 steps
D	M1F	Inverter fan	Since the system is of air heat exchanging type, the fan is operated at 9-step rotation speed by using the inverter.
E	Y1E	Electronic expansion valve (Main: EV1)	While in heating operation, PI control is applied to keep the outlet superheated degree of air heat exchanger constant.
G	Y1S	Solenoid valve (Hot gas: SVP)	Used to prevent the low pressure from transient falling.
J	Y2S	Solenoid valve (Oil return: SVO)	Used to return oil from the accumulator to the compressor.
K	Y4S	Solenoid valve (Injection) SVT	Used to cool the compressor by injecting refrigerant when the compressor discharge temperature is high.
M	Y3S	4-way valve	Used to switch the operation mode between cooling and heating.
N	S1NPH	High pressure sensor	Used to detect high pressure.
O	S1NPL	Low pressure sensor	Used to detect low pressure.
P	S1PH	HP pressure switch (For INV compressor)	In order to prevent the increase of high pressure when a malfunction occurs, this switch is activated at high pressure of 4.0 MPa or more to stop the compressor operation.
T	—	Pressure regulating valve 1	This valve opens at a pressure of 4.0 MPa for prevention of pressure increase, thus resulting in no damage of functional parts due to the increase of pressure in transportation or storage.
W	—	Capillary tube	Used to return the refrigerating oil separated through the oil separator to the compressor.
1	R1T	Thermistor (Outdoor air: Ta)	Used to detect outdoor temperature, correct discharge pipe temperature, and others.
2	R2T	Thermistor (Suction pipe: Ts)	Used to detect suction pipe temperature.
3	R3T	Thermistor (INV discharge pipe: Tdi)	Used to detect discharge pipe temperature, make the temperature protection control of compressor, and others.
4	R4T	Thermistor (Heat exchanger deicer: Tb)	Used to detect liquid pipe temperature of air heat exchanger, determine defrosting operation, and others.
5	R6T	Thermistor (Liquid pipe TI)	Used to detect liquid pipe temperature.
6	R7T	Thermistor (Accumulator inlet Ts1)	Used to detect gas pipe temperature at the accumulator inlet. Keep the suction superheated degree constant in heating operation, and others.

CMSQ200A7

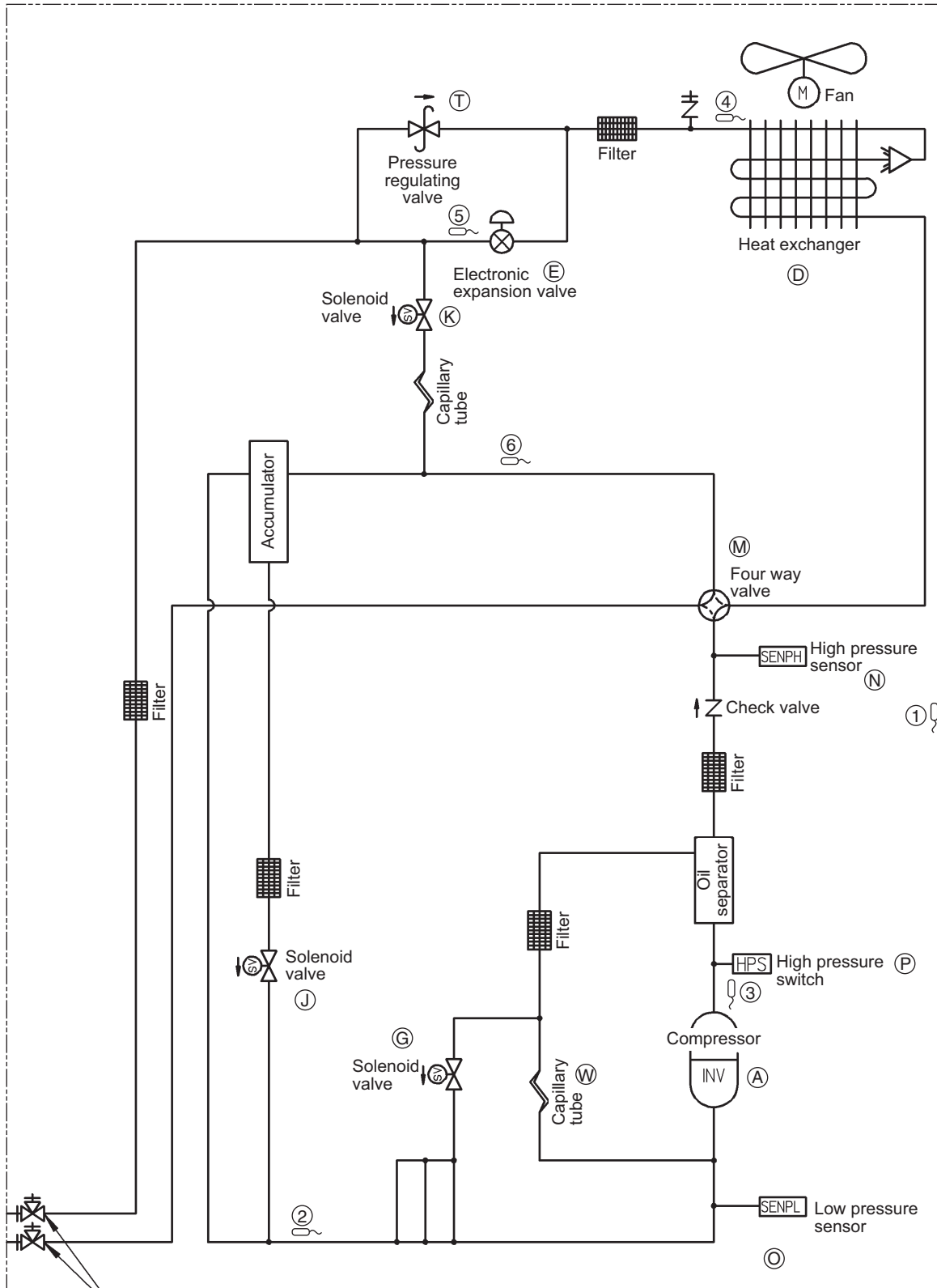

Stop valve
(With service port on on-site piping side Ø7.9mm flare connection)

4TW31345-1

1.2 CMSQ250A7

No. in refrigerant system diagram	Symbol	Name	Major Function
A	M1C	Inverter compressor (INV)	Inverter compressor is operated on frequencies between 52Hz and 266Hz by using the inverter, while Standard compressor is operated with commercial power supply only. The number of operating steps is as follows when Inverter compressor is operated in combination with Standard compressor. CMSQ250A7 : 24 steps
D	M1F	Inverter fan	Since the system is of air heat exchanging type, the fan is operated at 9-step rotation speed by using the inverter.
E	Y1E	Electronic expansion valve (Main: EV1)	While in heating operation, PI control is applied to keep the outlet superheated degree of air heat exchanger constant.
F	Y2E	Electronic expansion valve (Subcool: EV2)	PI control is applied to keep the outlet superheated degree of subcooling heat exchanger constant.
G	Y1S	Solenoid valve (Hot gas: SVP)	Used to prevent the low pressure from transient falling.
J	Y2S	Solenoid valve (Oil return: SVO)	Used to return oil from the accumulator to the compressor.
M	Y3S	4-way valve	Used to switch the operation mode between cooling and heating.
N	S1NPH	High pressure sensor	Used to detect high pressure.
O	S1NPL	Low pressure sensor	Used to detect low pressure.
P	S1PH	HP pressure switch (For INV compressor)	In order to prevent the increase of high pressure when a malfunction occurs, this switch is activated at high pressure of 4.0 MPa or more to stop the compressor operation.
T	—	Pressure regulating valve (Liquid pipe)	This valve opens at a pressure of 4.0 MPa for prevention of pressure increase, thus resulting in no damage of functional parts due to the increase of pressure in transportation or storage.
V	—	Subcooling heat exchanger	Used to subcool liquid refrigerant from the electronic expansion valve (cooling) or indoor units (heating).
W	—	Capillary tube	Used to return the refrigerating oil separated through the oil separator to the INV compressor.
1	R1T	Thermistor (Outdoor air: Ta)	Used to detect outdoor temperature, correct discharge pipe temperature, and others.
2	R2T	Thermistor (Suction pipe: Ts)	Used to detect suction pipe temperature.
3	R3T	Thermistor (INV discharge pipe: Tdi)	Used to detect discharge pipe temperature, make the temperature protection control of compressor, and others.
4	R4T	Thermistor (Heat exchanger deicer: Tb)	Used to detect liquid pipe temperature of air heat exchanger, determine defrosting operation, and others.
5	R5T	Thermistor (Subcooling heat exchanger gas pipe: Tsh)	Used to detect gas pipe temperature on the evaporation side of subcooling heat exchanger, keep the superheated degree at the outlet of subcooling heat exchanger constant, and others.
6	R6T	Thermistor (Receiver outlet liquid pipe: Tl)	Used to detect receiver outlet liquid pipe temperature.
7	R7T	Thermistor (Accumulator inlet)	Used to detect gas pipe temperature at the accumulator inlet. Keep the suction superheated degree constant in heating operation, and others.

CMSQ250A7

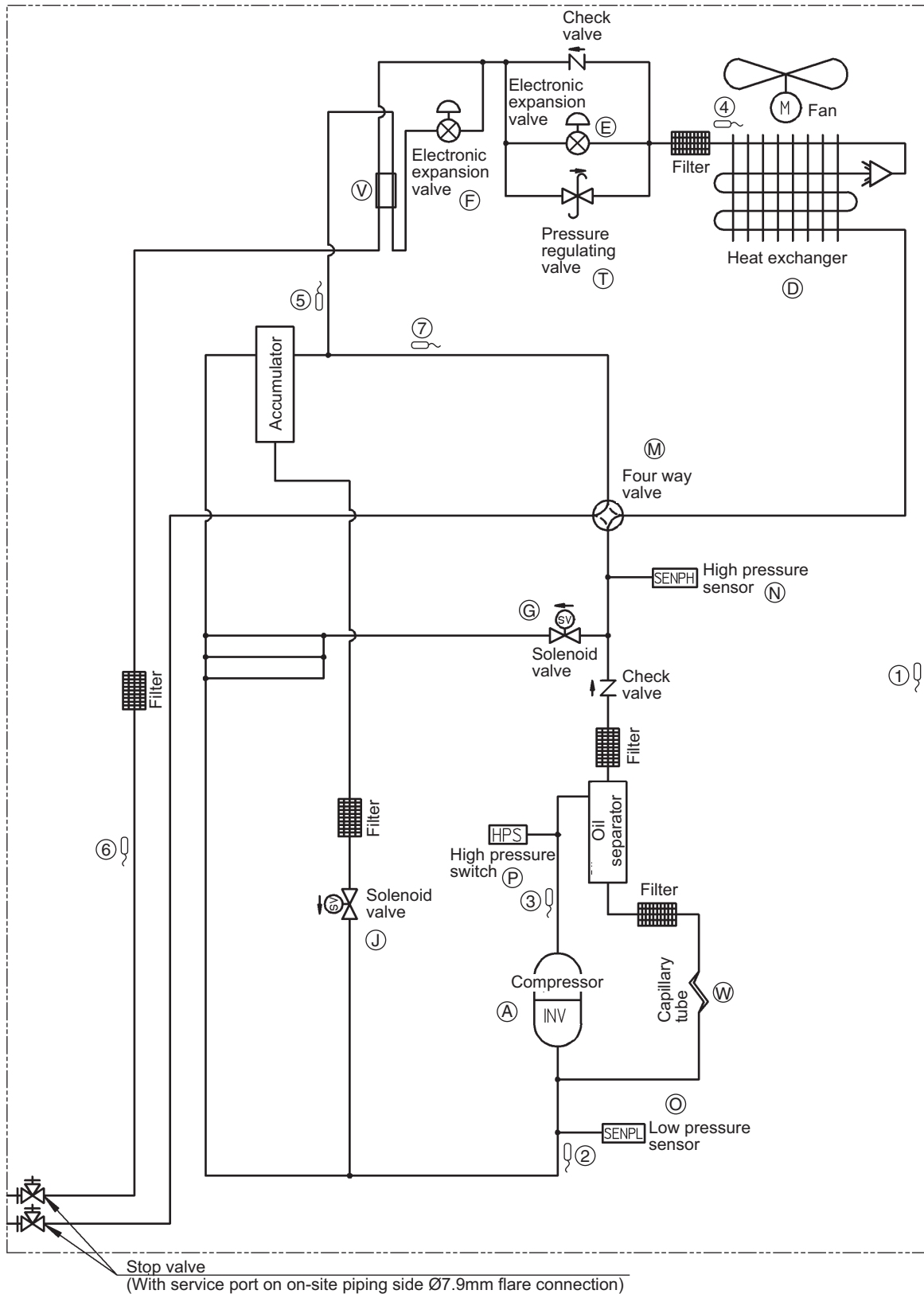

4TW31355-1

2. Functional Parts Layout

2.1 CMSQ200A7

Plan

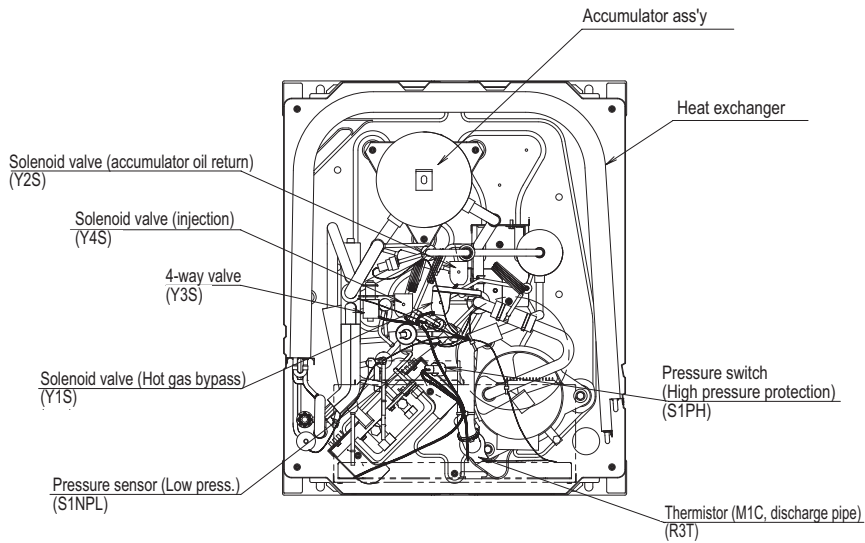

Front View

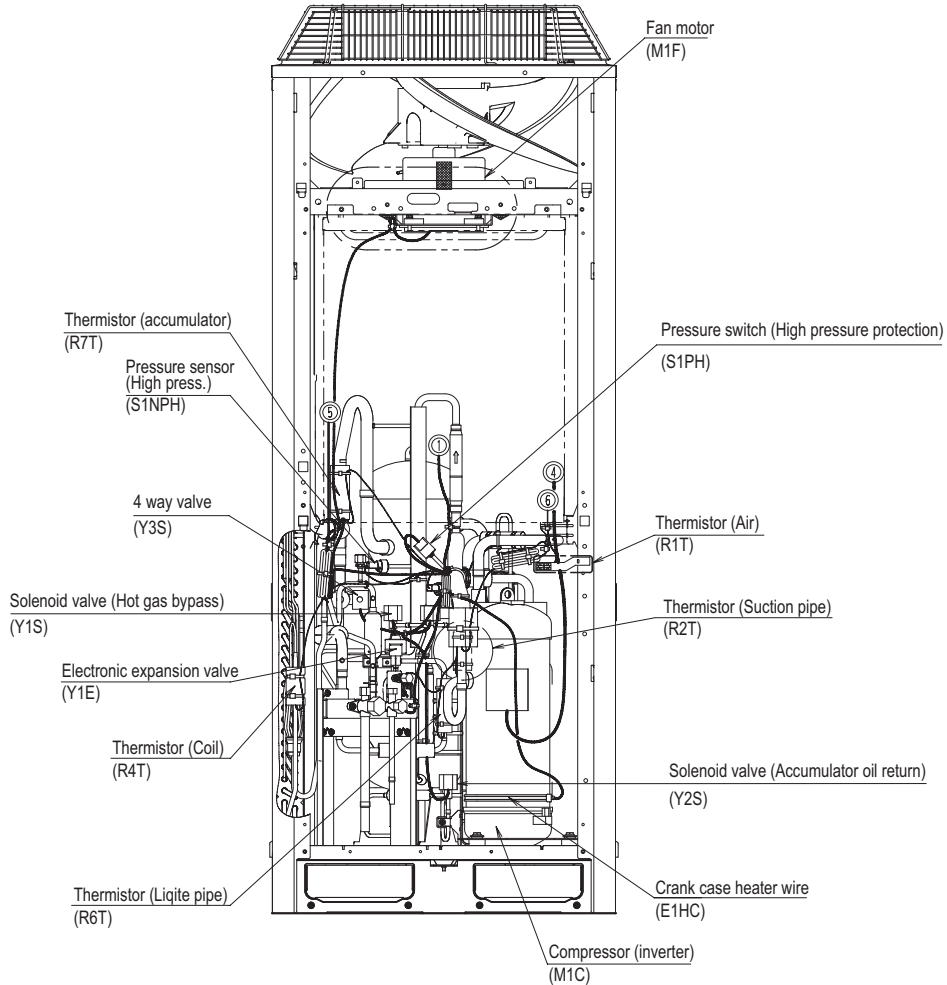

2.2 CMSQ250A7

Plan

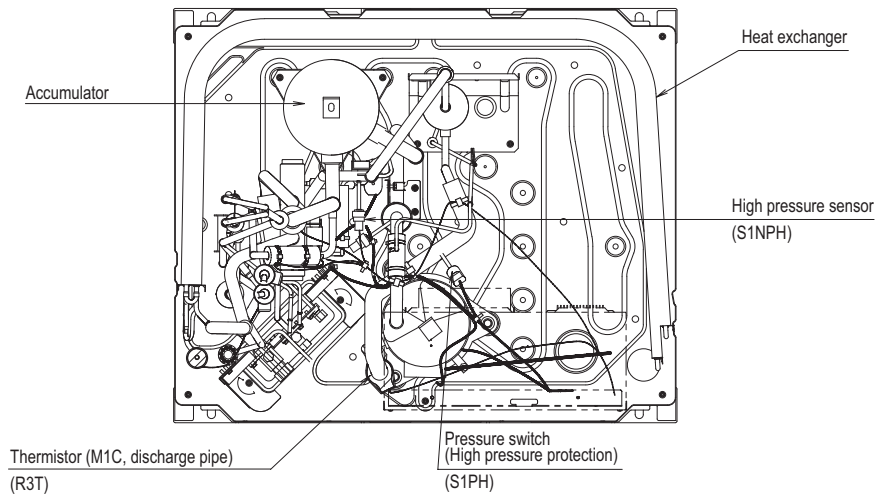

Front View

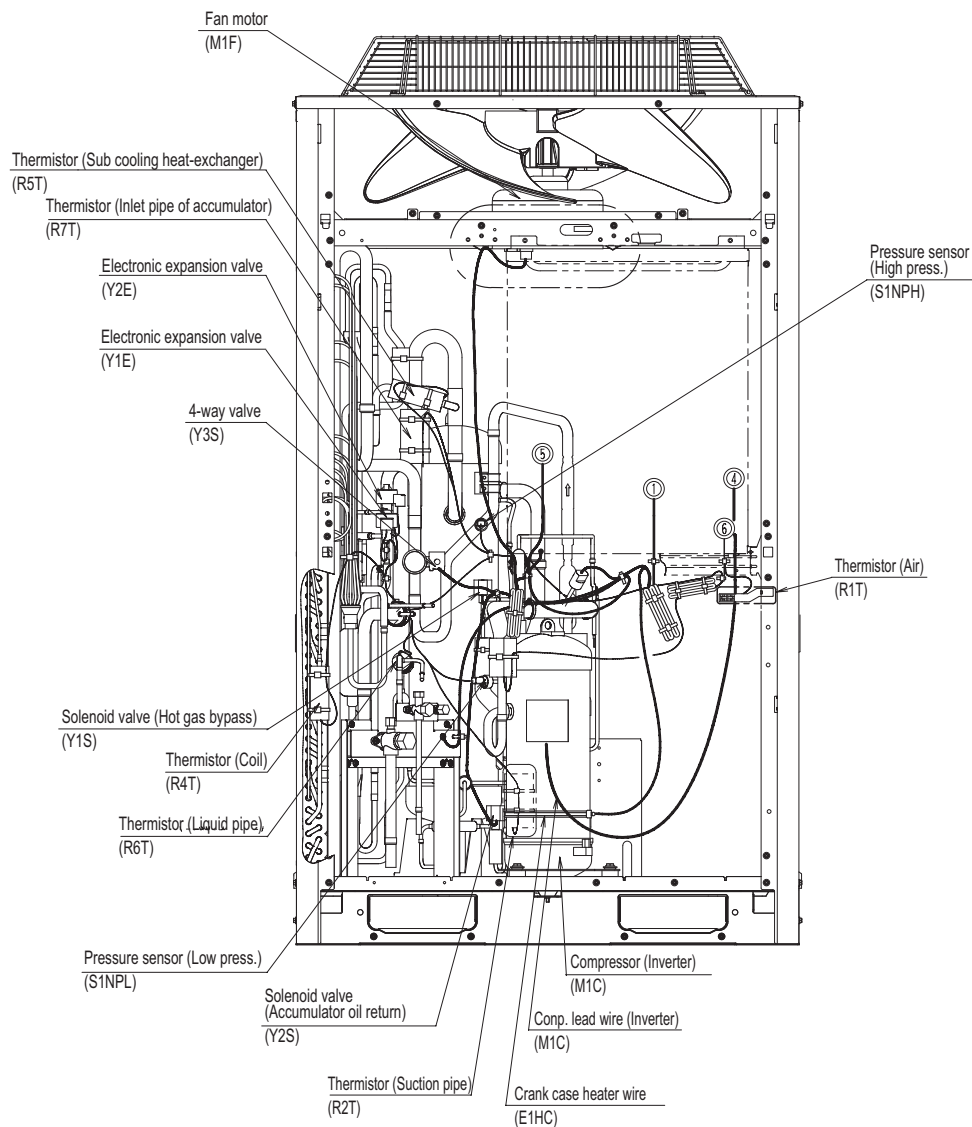

3. Refrigerant Flow for Each Operation Mode

CMSQ200A7
Cooling Operation

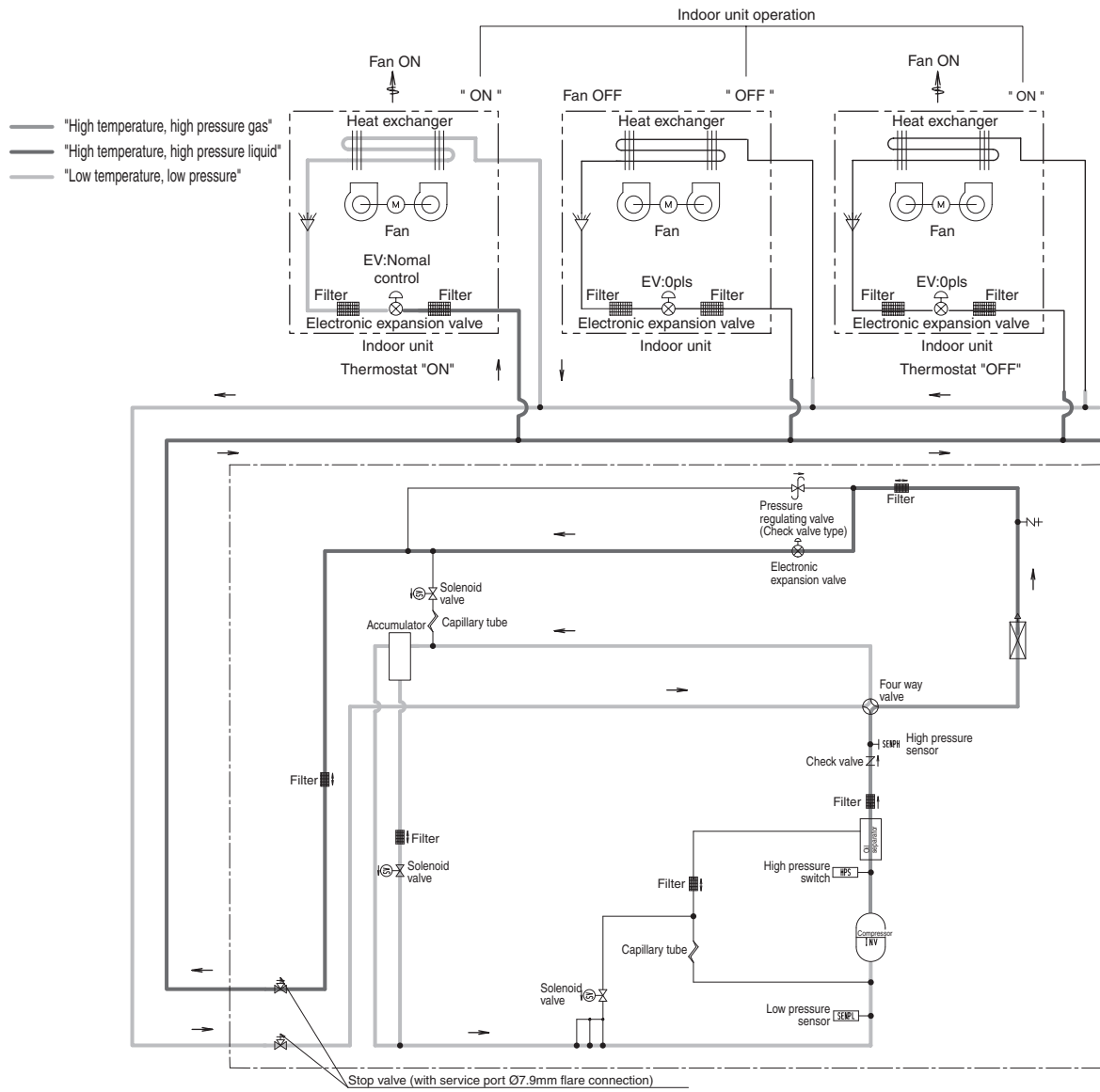

Cooling Oil Return Operation

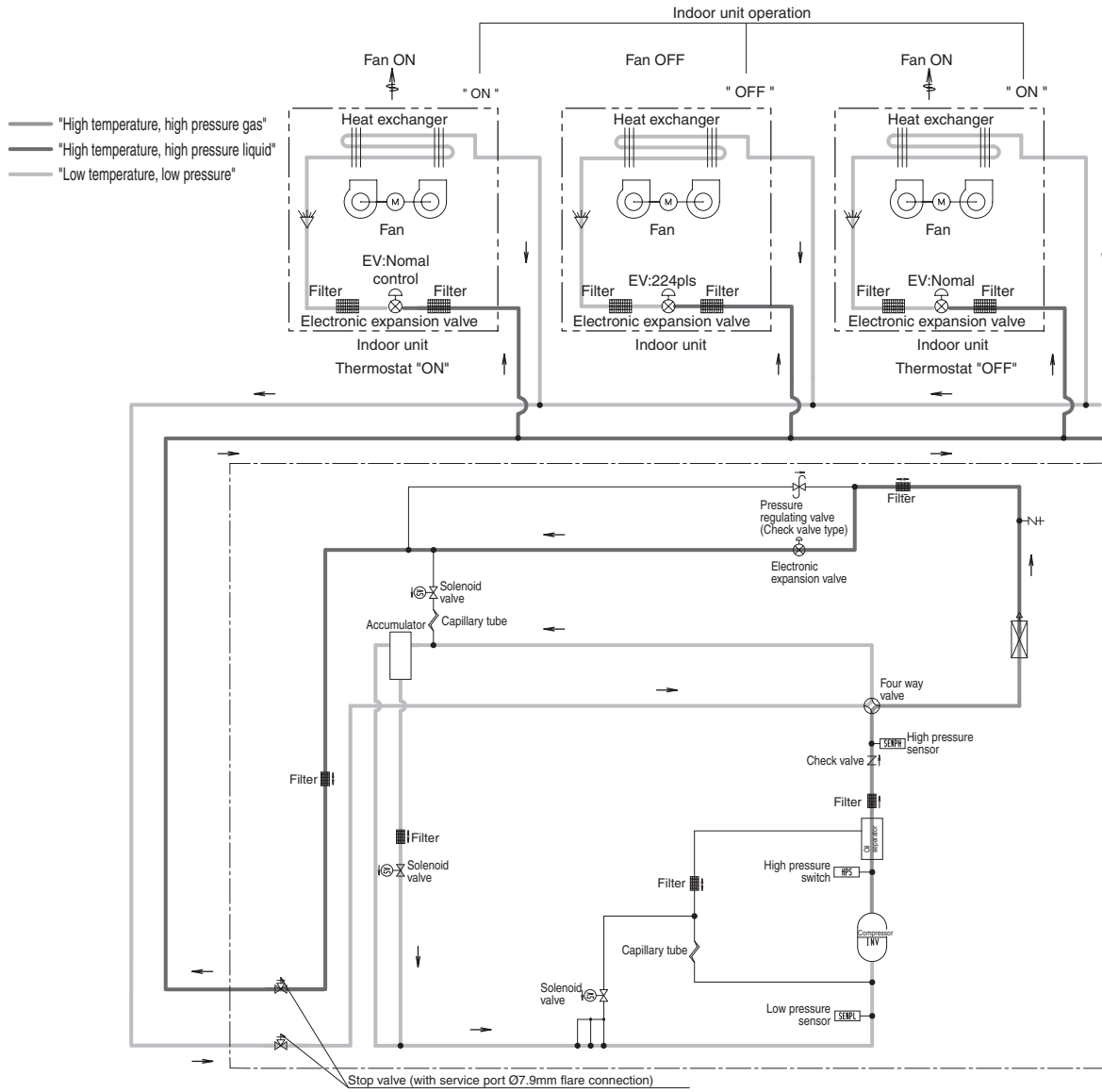

Heating Oil Return & Defrost Operation

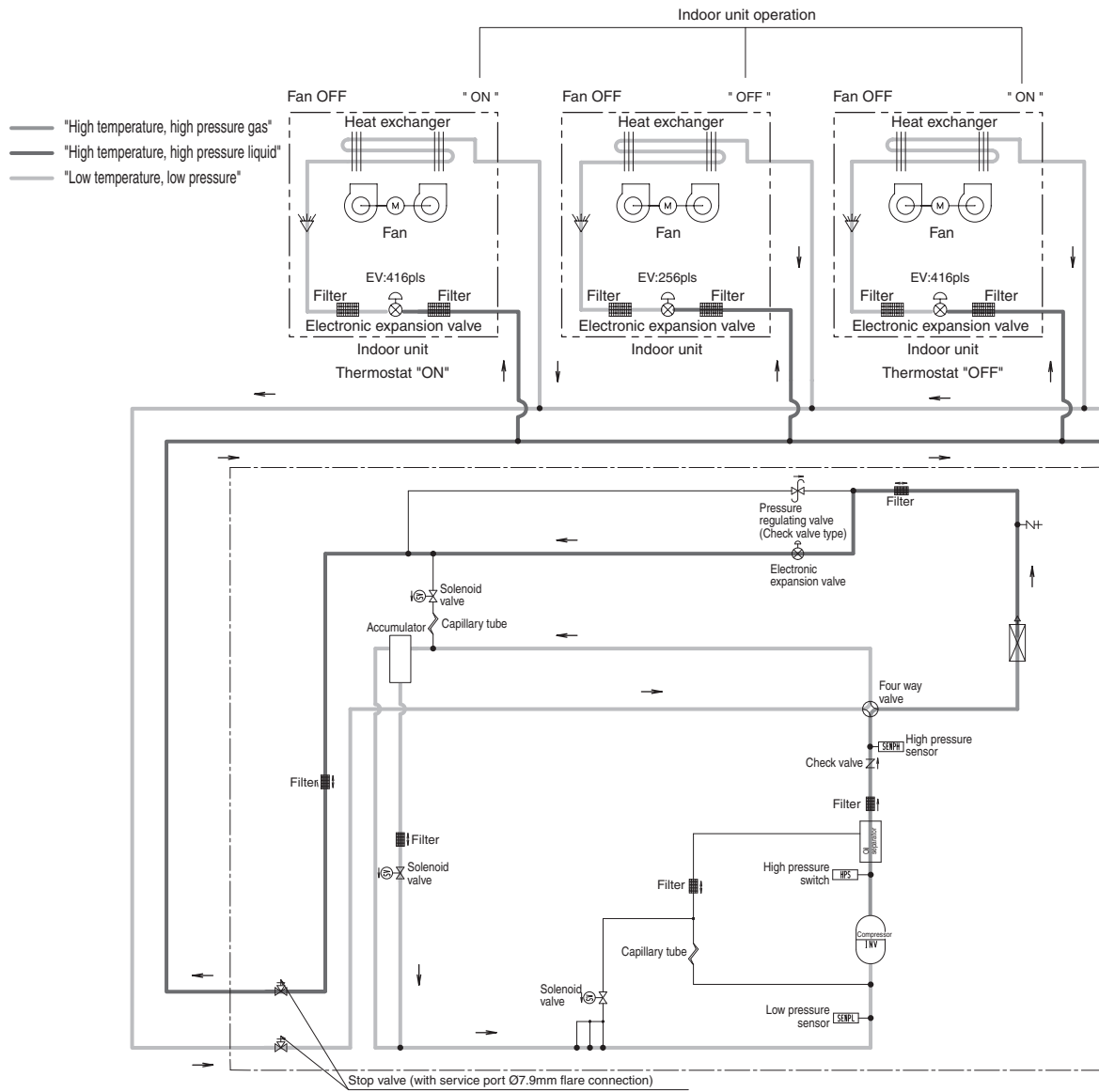

Heating Operation

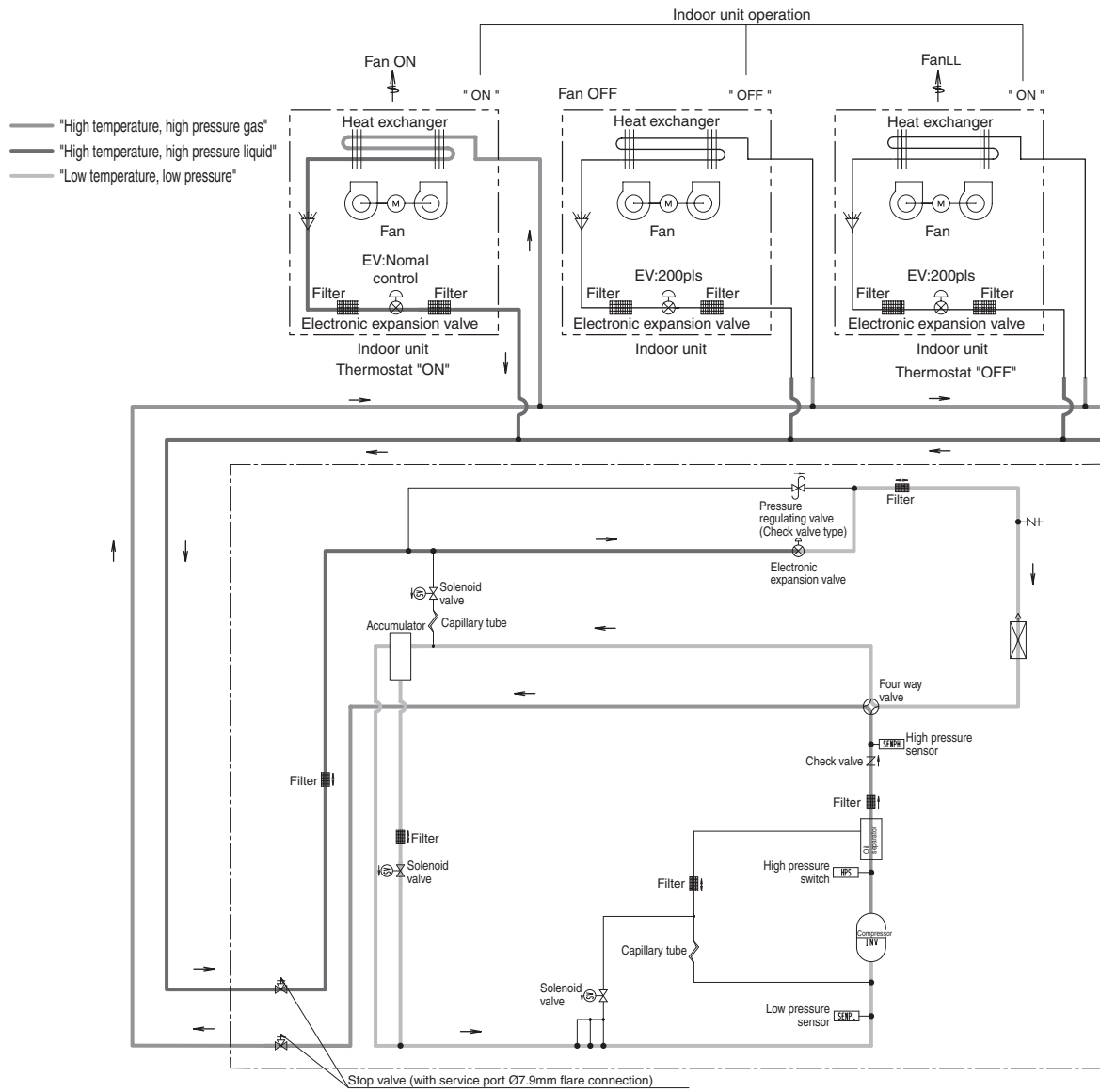

CMSQ250A7
Cooling Operation

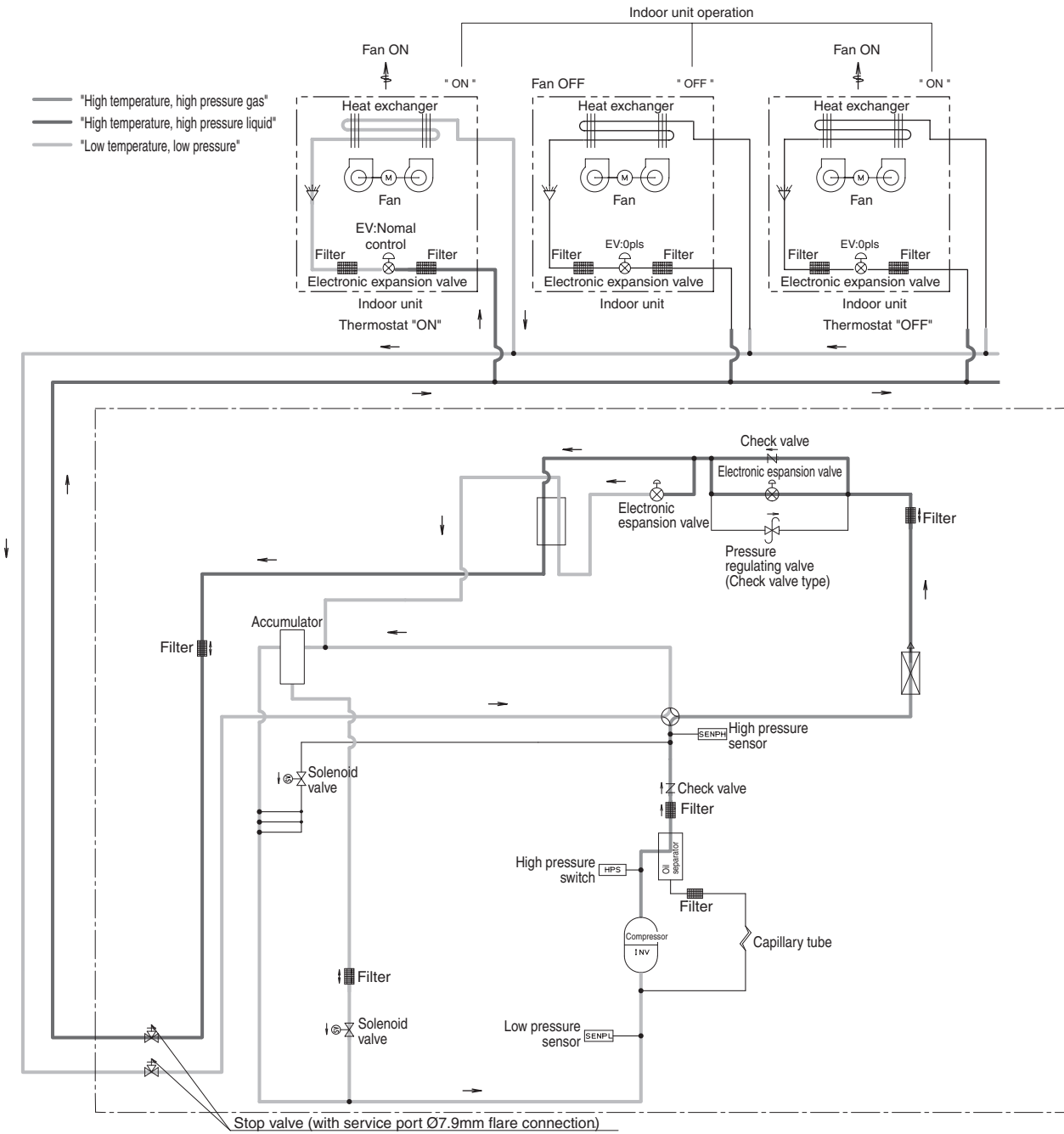

Cooling Oil Return Operation

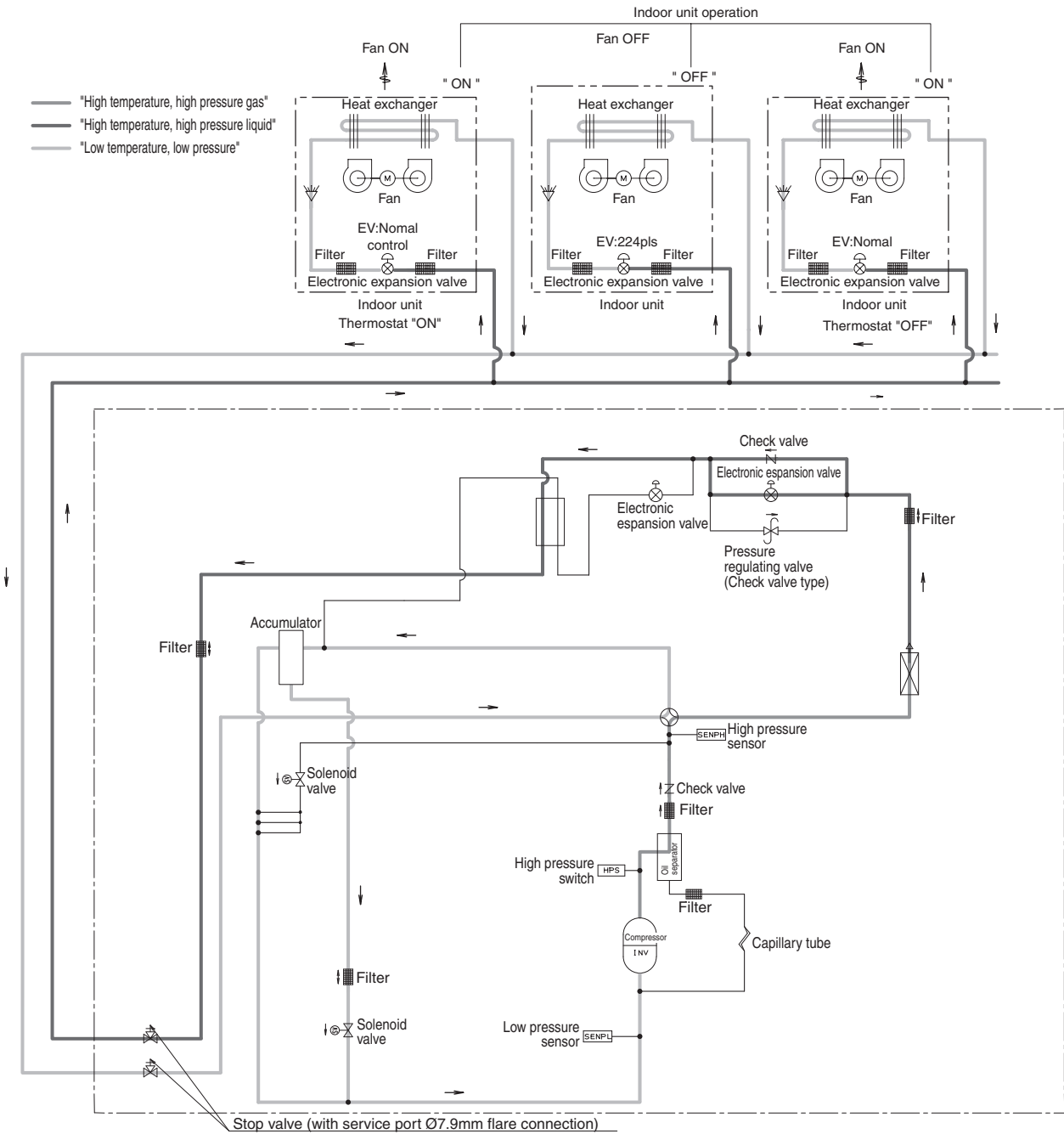

Heating Oil Return & Defrost Operation

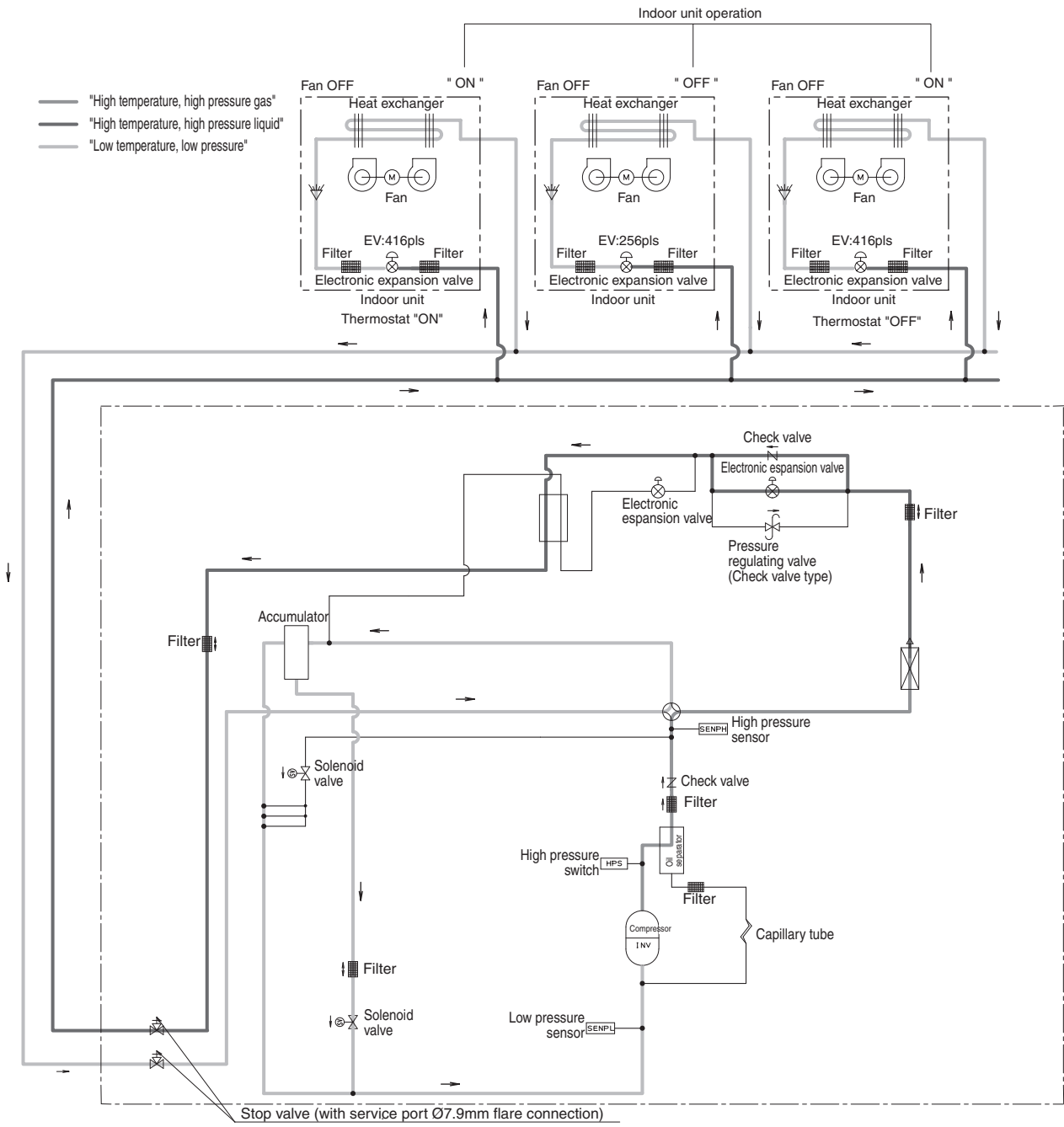

Heating Operation

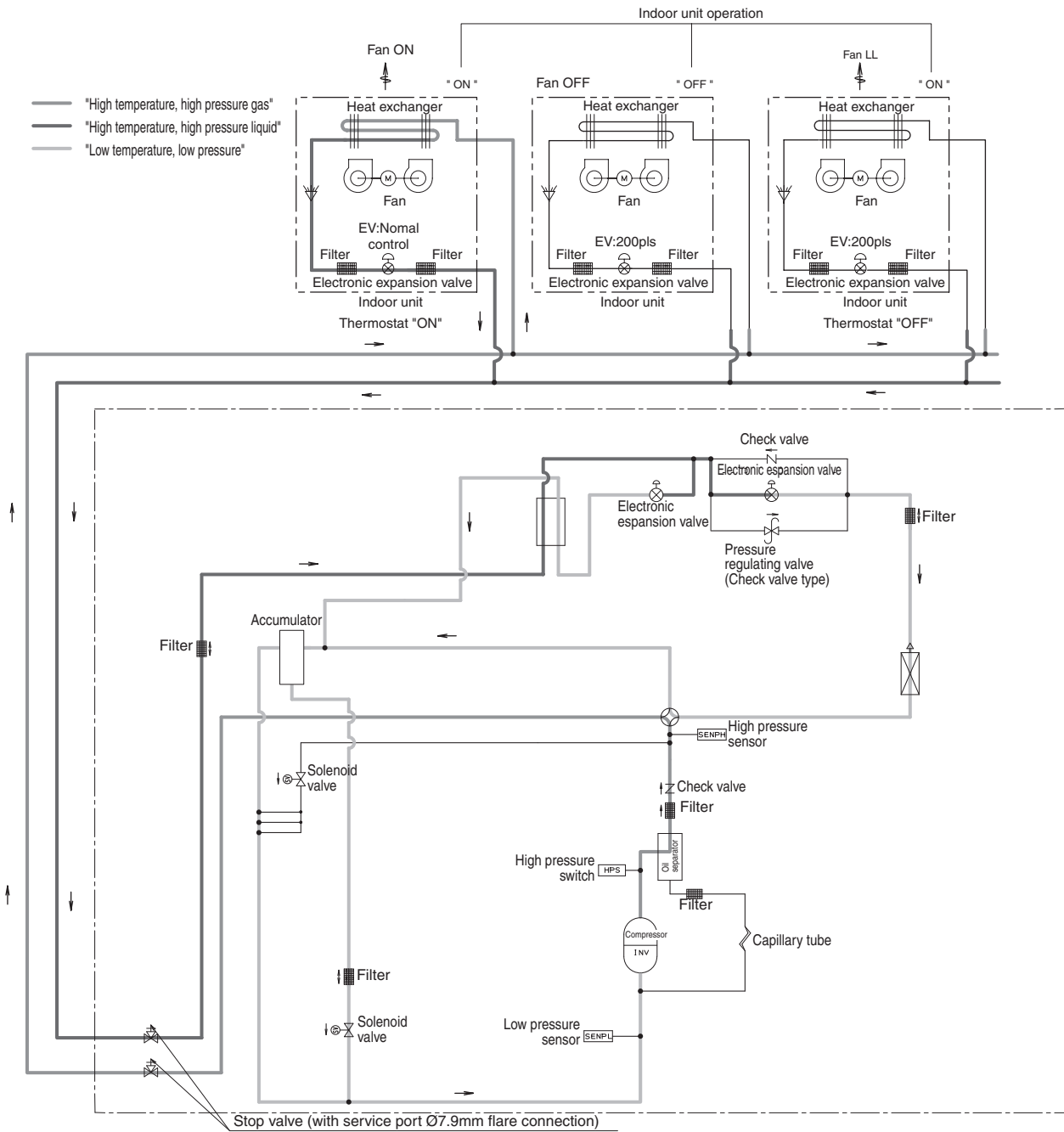

Part 4

Function

1. Function General.....	32
1.1 Symbol	32
1.2 Operation Mode.....	33
2. Basic Control.....	34
2.1 Normal Operation	34
2.2 Compressor PI Control.....	35
2.3 Electronic Expansion Valve PI Control.....	37
2.4 Step Control of Outdoor Unit Fans	37
2.5 Outdoor Unit Fan Control in Cooling Operation	38
3. Special Control.....	39
3.1 Startup Control	39
3.2 Oil Return Operation	40
3.3 Defrosting Operation	42
3.4 Pump-down Residual Operation	43
3.5 Standby	44
3.6 Stopping Operation	45
4. Protection Control	47
4.1 High Pressure Protection Control.....	47
4.2 Low Pressure Protection Control.....	48
4.3 Discharge Pipe Protection Control	49
4.4 Inverter Protection Control	50
4.5 Injection Control (only for CMSQ200A7).....	51
5. Other Control.....	52
5.1 Demand Operation	52
5.2 Heating Operation Prohibition	52
6. Outline of Control (Indoor Unit)	53
6.1 Drain Pump Control.....	53
6.2 Louver Control for Preventing Ceiling Dirt.....	55
6.3 Thermostat Sensor in remote control	56
6.4 Thermostat Control while in Normal Operation	58
6.5 Thermostat Control in Dry Operation	58
6.6 Electronic Expansion Valve Control	59
6.7 Hot Start Control (In Heating Operation Only).....	59
6.8 Freeze Prevention	60
6.9 Heater Control	60
6.10 List of Swing Flap Operations	61

1. Function General

1.1 Symbol

Symbol	Electric symbol	Description or function
20S1	Y3S	Four way valve (Energize during heating)
DSH	–	Discharge pipe superheated degree
DSHi	–	Discharge pipe superheat of inverter compressor
DSHs	–	Discharge pipe superheat of standard compressor
EV	–	Opening of electronic expansion valve
EV1	Y1E	Electronic expansion valve for main heat exchanger
EV2	Y2E	Electronic expansion valve for sub coolig heat exchanger
HTDi	–	Value of INV compressor discharge pipe temperature (R31T) compensated with outdoor air temperature
HTDs	–	Value of STD compressor discharge pipe temperature (R32T, R33T) compensated with outdoor air temperature
Pc	S1NPH	Value detected by high pressure sensor
Pe	S1NPL	Value detected by low pressure sensor
SH	–	Evaporator outlet superheat
SHS	–	Target evaporator outlet superheat
SVO	Y2S	Solenoid valve for oil return
SVP	Y1S	Solenoid valve for hot gas bypass
SVT	Y4S	Solenoid valve for injection
Ta	R1T (A1P)	Outdoor air temperature
Tb	R4T	Heat exchanger outlet temperature at cooling
Ts2	R2T	Suction pipe temperature detected with the suction pipe thermistor (R2T)
Tsh	R5T (–)	Temperature detected with the subcooling heat exchanger outlet thermistor (R5T)
Tc	–	High pressure equivalent saturation temperature
TcS	–	Target temperature of Tc
Te	–	Low pressure equivalent saturation temperature
TeS	–	Target temperature of Te
Tfin	R1T	Inverter fin temperature
TI	R6T	Liquid pipe temperature detected with the liquid pipe thermistor (R6T)
Tp	–	Calculated value of compressor port temperature
Ts1	R7T	Suction pipe temperature detected with the accumulator inlet thermistor

1.2 Operation Mode

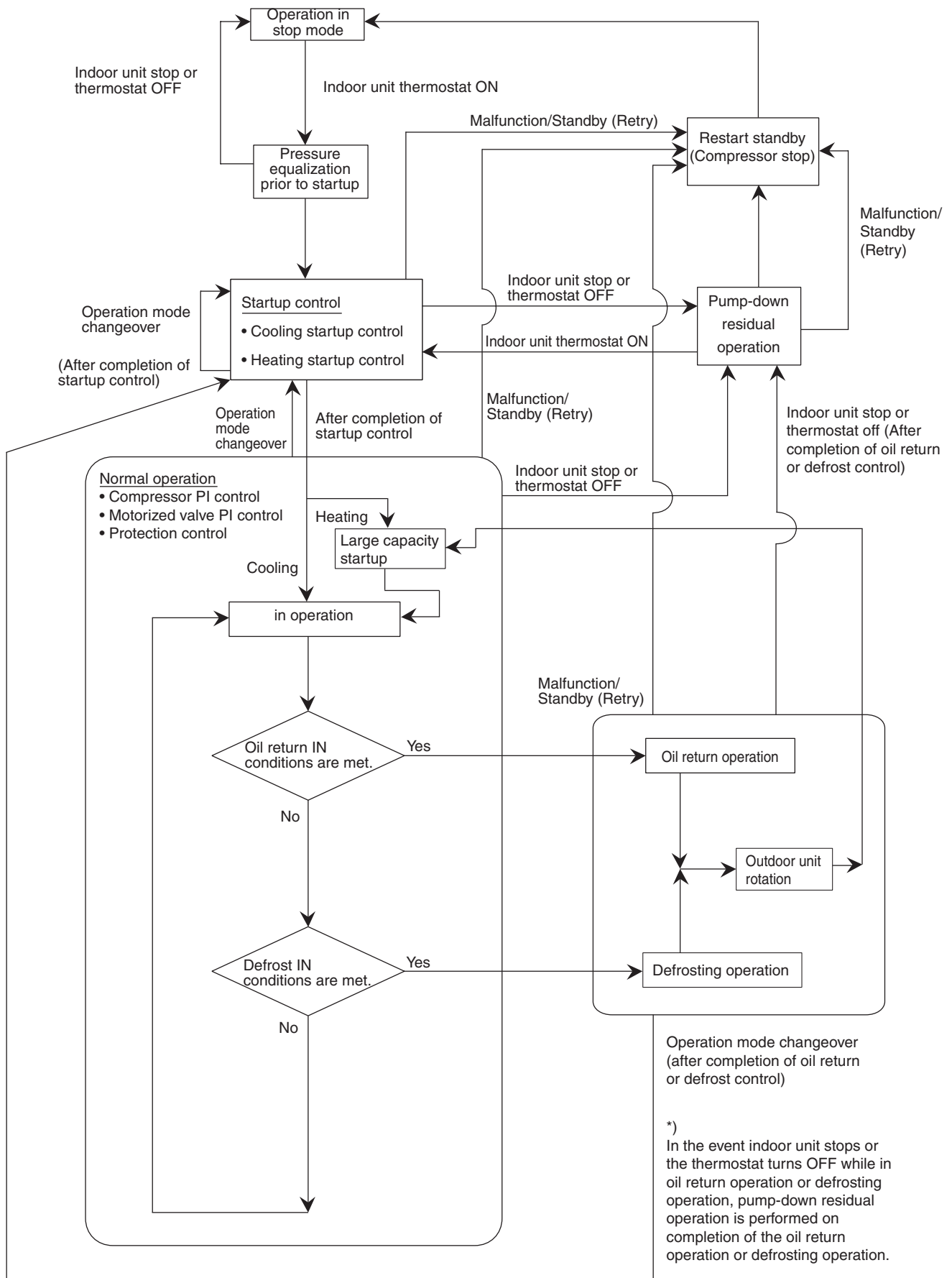

2. Basic Control

2.1 Normal Operation

2.1.1 List of Functions in Normal Operation

Part Name	Symbol	(Electric Symbol)	Function of Functional Part	
			Normal Cooling	Normal Heating
Compressor	—	(M1C)	PI control, High pressure protection, Low pressure protection, Td protection, INV protection,	PI control, High pressure protection, Low pressure protection, Td protection, INV protection,
Outdoor unit fan		(M1F)	Cooling fan control	Step 7 or 8
Four way valve	20S1	(Y1R)	OFF	ON
Main motorized valve	EV1	(Y1E)	480 pls	PI control
Subcool heat exchanger electronic expansion valve	EV2	(Y2E)	PI control	PI control
Hot gas bypass valve	SVP	(Y1S)	OFF	Energized when the system is set to low pressure control mode
Accumulator oil return valve	SV0	(Y2S)	ON	ON

Indoor unit actuator		Normal cooling	Normal heating
Fan	Thermostat ON unit	remote control setting	remote control setting
	Stopping unit	OFF	OFF
	Thermostat OFF unit	remote control setting	LL
Electronic expansion valve	Thermostat ON unit	Normal opening *1	Normal opening *2
	Stopping unit	0 pls	200 pls
	Thermostat OFF unit	0 pls	200 pls

*1. PI control : Evaporator outlet superheated degree (SH) constant.

*2. PI control : Condenser outlet subcooled degree (SC) constant.

*1 and 2 : Refer "6.6 Electronic expansion valve control" on page 59.

2.2 Compressor PI Control

Compressor PI Control

Carries out the compressor capacity PI control to maintain Te at constant during cooling operation and Tc at constant during heating operation to ensure stable unit performance.

[Cooling operation]

Controls compressor capacity to adjust Te to achieve target value (TeS).

Te set value (Make this setting while in Setting mode 2.)

Te setting

L	M (Normal) (factory setting)	H
3	6	9

Te : Low pressure equivalent saturation temperature (°C)

TeS : Target Te value
(Varies depending on Te setting, operating frequency, etc.)

*On multi-outdoor-unit systems, this control is made according to values of the first-priority unit, which is detected with the pressure sensor.

[Heating operation]

Controls compressor capacity to adjust Tc to achieve target value (TcS).

Tc set value (Make this setting while in Setting mode 2.)

Tc setting

L	M (Normal) (factory setting)	H
43	46	49

Tc : High pressure equivalent saturation temperature (°C)

TcS : Target Tc value
(Varies depending on Tc setting, operating frequency, etc.)

*On multi-outdoor-unit systems, this control is made according to values of the first-priority unit, which is detected with the pressure sensor.

■ Compressor Step Control

Compressor operations vary with the following steps according to information in "2.2 Compressor PI Control".

50Hz

Stand-alone installation

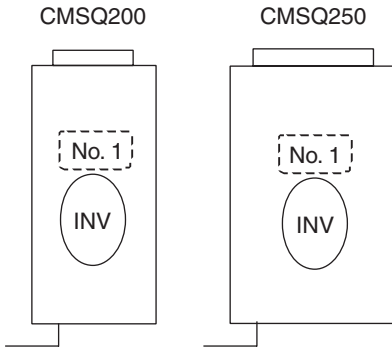

STEP No.	INV
1	52 Hz
2	56 Hz
3	62 Hz
4	68 Hz
5	74 Hz
6	80 Hz
7	88 Hz
8	96 Hz
9	104 Hz
10	110 Hz
11	116 Hz
12	124 Hz
13	132 Hz
14	144 Hz
15	158 Hz
16	166 Hz
17	176 Hz
18	188 Hz

STEP No.	INV
1	52 Hz
2	56 Hz
3	62 Hz
4	68 Hz
5	74 Hz
6	80 Hz
7	88 Hz
8	96 Hz
9	104 Hz
10	110 Hz
11	116 Hz
12	124 Hz
13	132 Hz
14	144 Hz
15	158 Hz
16	166 Hz
17	176 Hz
18	188 Hz
19	202 Hz
20	210 Hz
21	218 Hz
22	232 Hz
23	248 Hz
24	266 Hz

Notes:

1. INV : Inverter compressor
2. Depending on the operating conditions of compressors, the compressors may run in patterns other than those aforementioned.

2.3 Electronic Expansion Valve PI Control

Main Motorized Valve EV1 Control

Carries out the motorized valve (Y1E) PI control to maintain the evaporator outlet superheated degree (SH) at constant during heating operation to make maximum use of the outdoor unit heat exchanger (evaporator).

$$SH = Ts1 - Te$$

SH : Evaporator outlet superheated degree (°C)

Ts1: Suction pipe temperature detected by thermistor R6T (R7T) (°C)

Te : Low pressure equivalent saturation temperature (°C)

The optimum initial value of the evaporator outlet superheated degree is 5°C, but varies depending on the discharge pipe superheated degree of inverter compressor.

Subcooling Motorized Valve EV2 Control

Makes PI control of the motorized valve (Y2E) to keep the superheated degree of the outlet gas pipe on the evaporator side for the full use of the subcooling heat exchanger.

$$SH = Tsh - Te$$

SH : Outlet superheated degree of evaporator (°C)

Tsh : Suction pipe temperature detected with the thermistor R5T (°C)

Te : Low pressure equivalent saturation temperature (°C)

2.4 Step Control of Outdoor Unit Fans

Used to control the revolutions of outdoor unit fans in the steps listed in table below, according to condition changes.

STEP No.	Fan revolutions (rpm)	
	CMSQ200A7	CMSQ250A7
0	0	0
1	285	350
2	315	370
3	360	400
4	450	450
5	570	540
6	710	670
7	Cooling: 951 Heating: 941	760
8	Cooling: 951 Heating: 941	Cooling: 796 Heating: 780

* Figures listed above are all those controlled while in standard mode, which vary when the system is set to high static pressure or capacity precedence mode.

2.5 Outdoor Unit Fan Control in Cooling Operation

While in cooling operation, if the outdoor temperature is low, this mode provides high-pressure control using the outdoor unit fan to retain appropriate liquid pressure, thus ensuring refrigerant circulation rate to be supplied to indoor units.

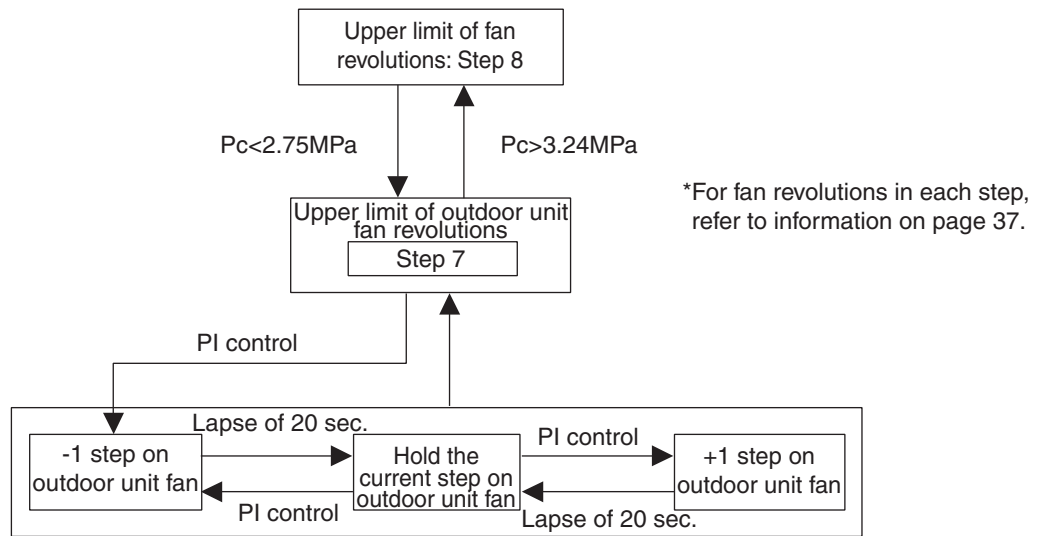

3. Special Control

3.1 Startup Control

This control is used to equalize the pressure in the front and back of the compressor prior to the startup of the compressor, thus reducing startup loads. Furthermore, the inverter is turned ON to charge the capacitor.

In addition, to avoid stresses to the compressor due to oil return or else after the startup, the following control is made and the position of the four way valve is also determined. To position the four way valve, the master and slave units simultaneously start up.

3.1.1 Startup Control in Cooling Operation

		Thermostat ON	
	Pressure equalization control prior to startup	Startup control	
		STEP1	STEP2
Compressor	0 Hz	52 Hz	124 Hz +2 steps/20 sec. (until $P_c - P_e > 0.39\text{MPa}$ is achieved)
Outdoor unit fan	STEP4	$T_a < 20^\circ\text{C}$: OFF $T_a \geq 20^\circ\text{C}$: STEP4	+1 step/15 sec. (when $P_c > 2.16\text{MPa}$) -1 step/15 sec. (when $P_c < 1.77\text{MPa}$)
Four way valve (20S1)	Holds	OFF	OFF
Main motorized valve (EV1)	0 pls	480 pls	480 pls
Subcooling motorized valve (EV2) (CMSQ250A7)	0 pls	0 pls	0 pls
Hot gas bypass valve (SVP)	OFF	OFF	OFF
Accumulator oil return valve (SVO)	OFF	OFF	OFF
Injection (SVT) (CMSQ200A7 model)	OFF	OFF	OFF
Ending conditions	A lapse of one minute	A lapse of 10 sec.	OR <ul style="list-style-type: none"> • A lapse of 130 sec. • $P_c - P_e > 0.39\text{MPa}$

3.1.2 Startup Control in Heating Operation

		Thermostat ON	
	Pressure equalization control prior to startup	Startup control	
		STEP1	STEP2
Compressor	0 Hz	52 Hz	124 Hz +2 steps/20 sec. (until $P_c - P_e > 0.39\text{MPa}$ is achieved)
Outdoor unit fan	STEP4	STEP8	STEP8
Four way valve	Holds	ON	ON
Main motorized valve (EV1)	0 pls	0 pls	0 pls
Subcooling motorized valve (EV2) (CMSQ250A7)	0 pls	0 pls	0 pls
Hot gas bypass valve (SVP)	OFF	OFF	OFF
Accumulator oil return valve (SVO)	OFF	OFF	OFF
Injection (SVT) (CMSQ200A7 model)	OFF	OFF	OFF
Ending conditions	A lapse of one minute	A lapse of 10 sec.	OR <ul style="list-style-type: none"> • A lapse of 130 sec. • $P_c > 2.70\text{MPa}$ • $P_c - P_e > 0.39\text{MPa}$

3.2 Oil Return Operation

In order to prevent the compressor from running out of oil, the oil return operation is conducted to recover oil flown out from the compressor to the system side.

3.2.1 Oil Return Operation in Cooling Operation

[Start conditions]

Referring to the set conditions for the following items, start the oil return operation in cooling.

- Cumulative oil feed rate
- Timer setting (Make this setting so as to start the oil return operation when the initial cumulative operating time reaches two hours after power supply is turned ON and then every eight hours.)

Furthermore, the cumulative oil feed rate is computed from Tc, Te, and compressor loads.

Outdoor unit actuator	Oil return preparation operation	Oil return operation	Post-oil-return operation
Compressor	Take the current step as the upper limit.	CMSQ200A7: 52 Hz (→ Low pressure constant control) CMSQ250A7: 52 Hz (→ Low pressure constant control) ↓ Maintain number of compressors in oil return preparation operation ON	Same as the "oil return operation" mode.
Outdoor unit fan	Fan control (Normal cooling)	Fan control (Normal cooling)	Fan control (Normal cooling)
Four way valve	OFF	OFF	OFF
Main motorized valve (EV1)	480 pls	480 pls	480 pls
Subcooling motorized valve (EV2)	SH control	0 pls	0 pls
Hot gas bypass valve (SVP)	OFF	OFF	OFF
Accumulator oil return valve (SVO)	ON	ON	ON
Ending conditions	20 sec.	or [<ul style="list-style-type: none"> • 3 min. • $T_s - T_e < 5^\circ\text{C}$ 	or [<ul style="list-style-type: none"> • 3 min. • $P_e < 0.6\text{MPa}$ • $HT_{di} > 110^\circ\text{C}$

Indoor unit actuator		Cooling oil return operation
Fan	Thermostat ON unit	remote control setting
	Stopping unit	OFF
	Thermostat OFF unit	remote control setting
Electronic expansion valve	Thermostat ON unit	Normal opening
	Stopping unit	224 pls
	Thermostat OFF unit	Normal opening with forced thermostat ON

3.2.2 Oil Return Operation in Heating Operation

Outdoor Unit Actuator	Oil return preparation operation	Oil return operation	Post-oil-return operation
Compressor	Upper limit control	176 Hz	124 Hz 2-steps increase/20sec. till $P_c - P_e > 0.4 \text{ MPa}$
Outdoor unit fan	STEP7 or STEP8	OFF	STEP8
Four way valve	ON	OFF	ON
Main motorized valve (EV1)	SH control → 480 pls	480 pls	55 pls
Subcooling motorized valve (EV2)	SH control	0 pls	0 pls
Hot gas bypass valve (SVP)	OFF	OFF	OFF
Accumulator oil return valve (SVO)	ON	ON	ON
Injection (SVT) (CMSQ200A7 model only)	OFF	OFF	OFF
Ending conditions	170 sec.	or $\left[\begin{array}{l} \bullet 4 \text{ min.} \\ \bullet T_s - T_e < 5^\circ\text{C} \end{array} \right.$	or $\left[\begin{array}{l} \bullet 10 \text{ sec.} \\ \bullet P_c - P_e > 0.4 \text{ MPa} \end{array} \right.$

Indoor unit actuator		Heating oil return operation
Fan	Thermostat ON unit	OFF
	Stopping unit	OFF
	Thermostat OFF unit	OFF
Electronic expansion valve	Thermostat ON unit	Oil return EV opening degree
	Stopping unit	256 pls
	Thermostat OFF unit	Oil return EV opening degree

3.3 Defrosting Operation

To defrost the outdoor unit heat exchanger while in Evaporator, the defrost operation is conducted to recover the heating capacity.

[Start conditions]

Referring to the set conditions for the following items, start the defrosting operation.

- Heat transfer coefficient of the outdoor unit heat exchanger
- Heat exchange temperature (Tb)
- Timer (Set to two hours at minimum.)

Furthermore, the heat transfer coefficient of the outdoor unit Evaporator is computed from Tc, Te, and compressor loads.

Outdoor unit actuator	Defrost preparation operation	Defrost operation	Post Defrost operation
Compressor	Upper limit control	176 Hz	124 Hz 2-steps increase/20sec. till Pc - Pe>0.4 MPa
Outdoor unit fan	STEP7 or STEP8	OFF	STEP8
Four way valve	ON	OFF	ON
Main motorized valve (EV1)	SH control → 480 pls	480 pls	55 pls
Subcooling motorized valve (EV2)	0 pls	0 pls	0 pls
Hot gas bypass valve (SVP)	OFF	OFF	OFF
Accumulator oil return valve (SVO)	ON	ON	ON
Injection (SVT) (CMSQ200A7 model only)	OFF	OFF	OFF
Ending conditions	170 sec.	or [<ul style="list-style-type: none"> • 10 min. • Tb>11°C 	or [<ul style="list-style-type: none"> • 10 sec. • Pc - Pe>0.4MPa

Indoor unit actuator		During defrost
Fan	Thermostat ON unit	OFF
	Stopping unit	OFF
	Thermostat OFF unit	OFF
Electronic expansion valve	Thermostat ON unit	Defrost EV opening degree
	Stopping unit	256 pls
	Thermostat OFF unit	Defrost EV opening degree

3.4 Pump-down Residual Operation

3.4.1 Pump-down Residual Operation in Cooling Operation

If the liquid refrigerant stays in the Evaporator at the startup of a compressor, this liquid refrigerant enters the compressor, thus resulting in diluted oil in the compressor and then degraded lubrication performance.

Consequently, in order to recover the refrigerant in the Evaporator while the compressor stops, the pump-down residual operation is conducted.

Actuator	Master unit operation	Slave unit operation
Compressor	124 Hz	OFF
Outdoor unit fan	Fan control	OFF
Four way valve	OFF	OFF
Main motorized valve (EV1)	480 pls	0 pls
Subcooling motorized valve (EV2)	0 pls	0 pls
Hot gas bypass valve (SVP)	OFF	OFF
Accumulator oil return valve (SVO)	ON	ON
Ending conditions	or [• 5 min.	

3.4.2 Pump-down Residual Operation in Heating Operation

Actuator	Master unit operation	Slave unit operation
Compressor	124 Hz	OFF
Outdoor unit fan	STEP7	STEP4
Four way valve	ON	ON
Main motorized valve (EV1)	0 pls	0 pls
Subcooling motorized valve (EV2)	0 pls	0 pls
Hot gas bypass valve (SVP)	OFF	OFF
Accumulator oil return valve (SVO)	ON	ON
Ending conditions	or [• 3 min.	

3.5 Standby

3.5.1 Restart Standby

Used to forcedly stop the compressor for a period of 3 minutes, in order to prevent the frequent ON/OFF of the compressor and equalize the pressure within the refrigerant system.

Actuator	Operation
Compressor	OFF
Outdoor unit fan	Ta>30°C: STEP4 Ta≤30°C: OFF
Four way valve	Holds
Main motorized valve (EV1)	0 pls
Subcooling motorized (EV2)	0 pls
Hot gas bypass valve (SVP)	OFF
Accumulator oil return valve (SVO)	OFF
Injection (SVT) (CMSQ200A7 model)	OFF
Ending conditions	2 min.

3.5.2 Crankcase Heater Control

In order to prevent the refrigerant from melting in the compressor oil in the stopped mode, this mode is used to control the crankcase heater.

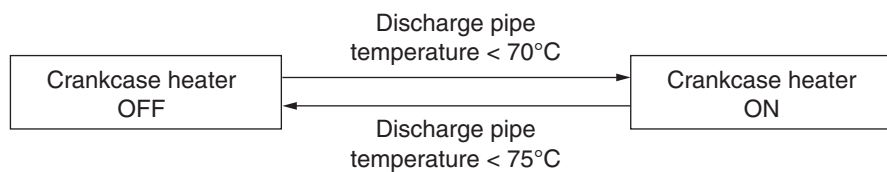

3.6 Stopping Operation

3.6.1 When System is in Stop Mode (Normal operation stop)

This mode is used to define actuator operations when the system stops.

Actuator	Operation
Compressor	OFF
Outdoor unit fan	OFF
Four way valve	Holds
Main motorized valve (EV1)	0 pls
Subcooling motorized valve (EV2)	0 pls
Hot gas bypass valve (SVP)	OFF
Accumulator oil return valve (SVO)	OFF
Injection (SVT) (CMSQ200A7 model only)	OFF
Ending conditions	Indoor unit thermostat is turned ON.

3.6.2 Stop due to Malfunction

In order to protect compressors, if any of the following items has an abnormal value, the system will make "stop with thermostat OFF" and the malfunction will be determined according to the number of retry times.

Item	Judgment Criteria	Malfunction Code
1. Abnormal low pressure level	0.07MPa	E4
2. Abnormal high pressure level	4.0MPa	E3
3. Abnormal discharge pipe temperature level	135°C	F3
4. Abnormal power supply voltage	Reverse-phase power supply	U1
5. Abnormal inverter current level	16.1A: 260 sec.	L8
6. Abnormal radiator fin temperature level	93°C	L4

3.6.3 Stopping Operation of Slave Units During Master Unit is in Operation with Multi-Outdoor-Unit System

While the master unit is in operation, this mode is used to set the refrigerant flow rate to a required level using a slave unit in the stopped mode.

In cooling operation: Same as that of normal operation stop.

In heating operation: The system operates with following mode.

Actuator	Operation
Compressor	OFF
Outdoor unit fan	OFF
Four way valve	ON
Main motorized valve (EV1)	0 pls
Subcooling motorized valve (EV2)	0 pls
Hot gas bypass valve (SVP)	OFF
Accumulator oil return valve (SVO)	OFF
Injection valve (SVT CMSQ200A7 only)	OFF
Ending conditions	Slave units are required to operate.

4. Protection Control

4.1 High Pressure Protection Control

This high pressure protection control is used to prevent the activation of protection devices due to abnormal increase of high pressure and to protect compressors against the transient increase of high pressure.

[In cooling operation]

- ★ In the case of multi-outdoor-unit system, each outdoor unit performs this control individually in the following sequence.

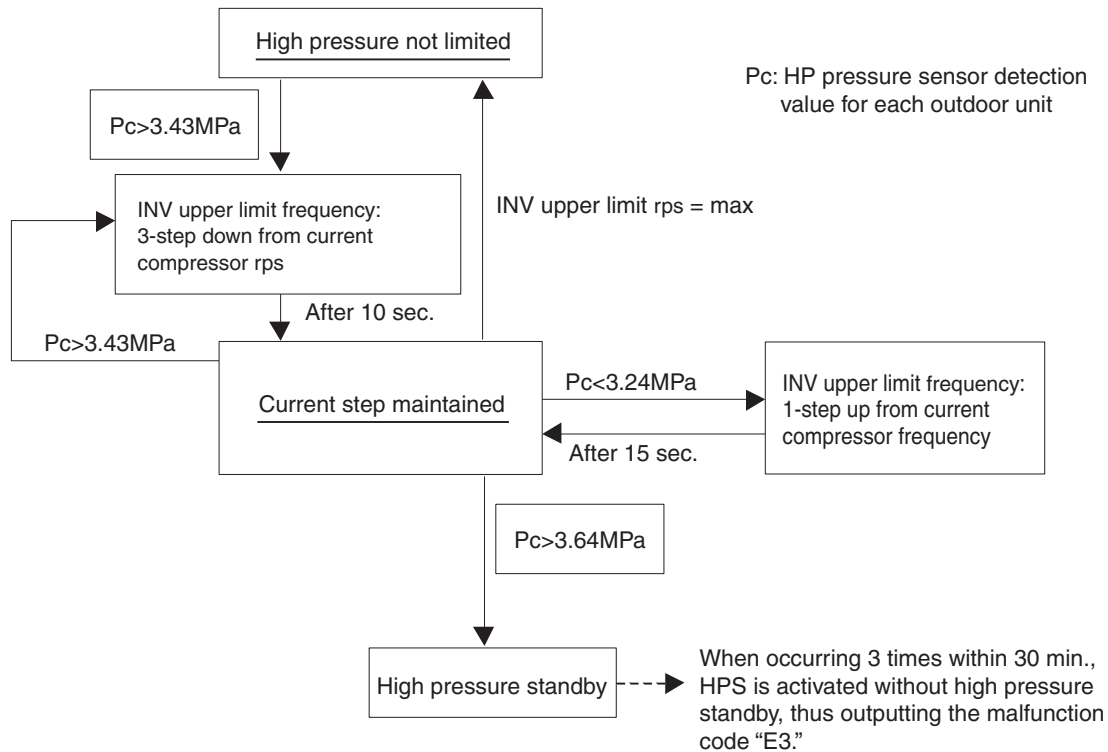

[In heating operation]

- ★ In the case of multi-outdoor-unit system, the entire system performs this control in the following sequence.

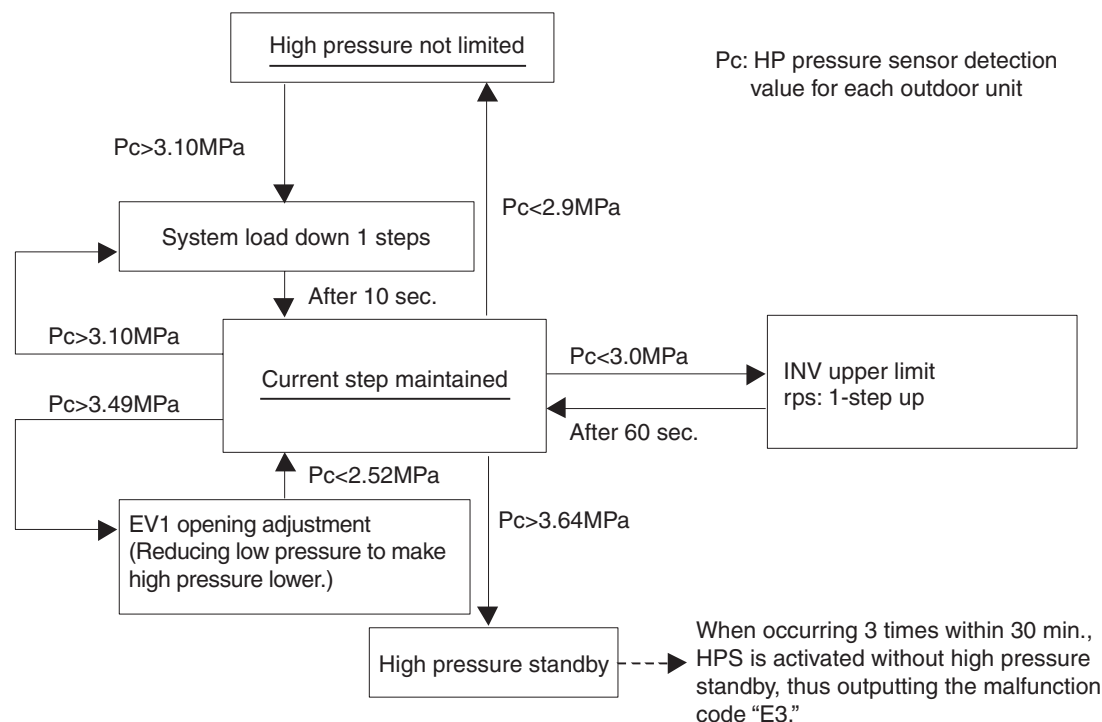

4.2 Low Pressure Protection Control

This low pressure protection control is used to protect compressors against the transient decrease of low pressure.

[In cooling operation]

★ In the case of multi-outdoor-unit system, the entire system performs this control in the following sequence.

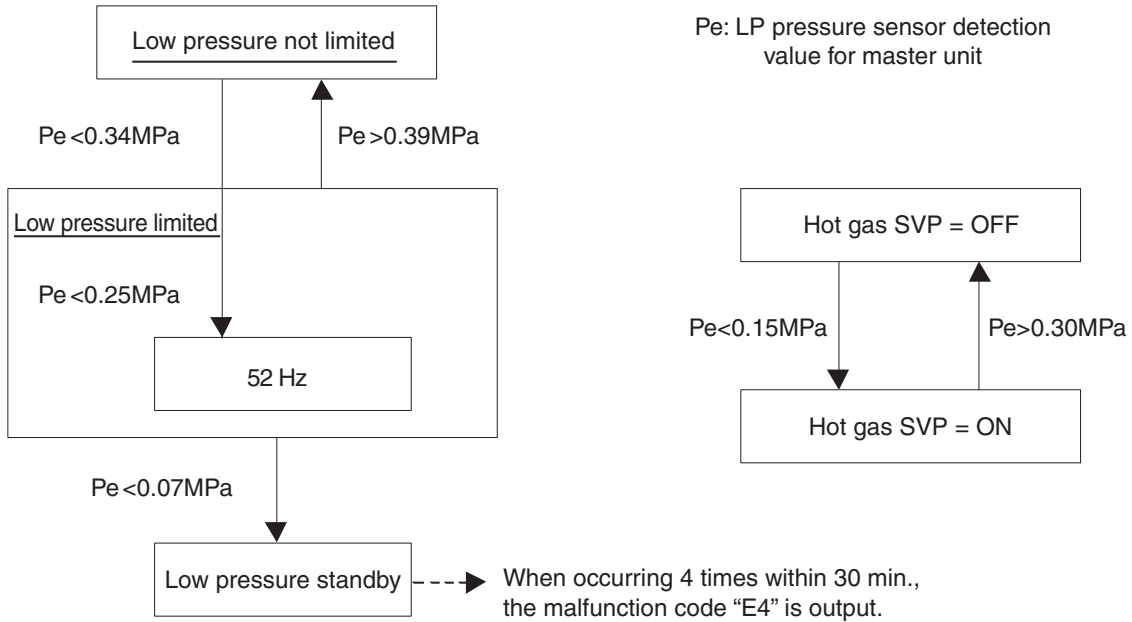

[In heating operation]

★ In the case of multi-outdoor-unit system, each outdoor unit performs this control individually in the following sequence.

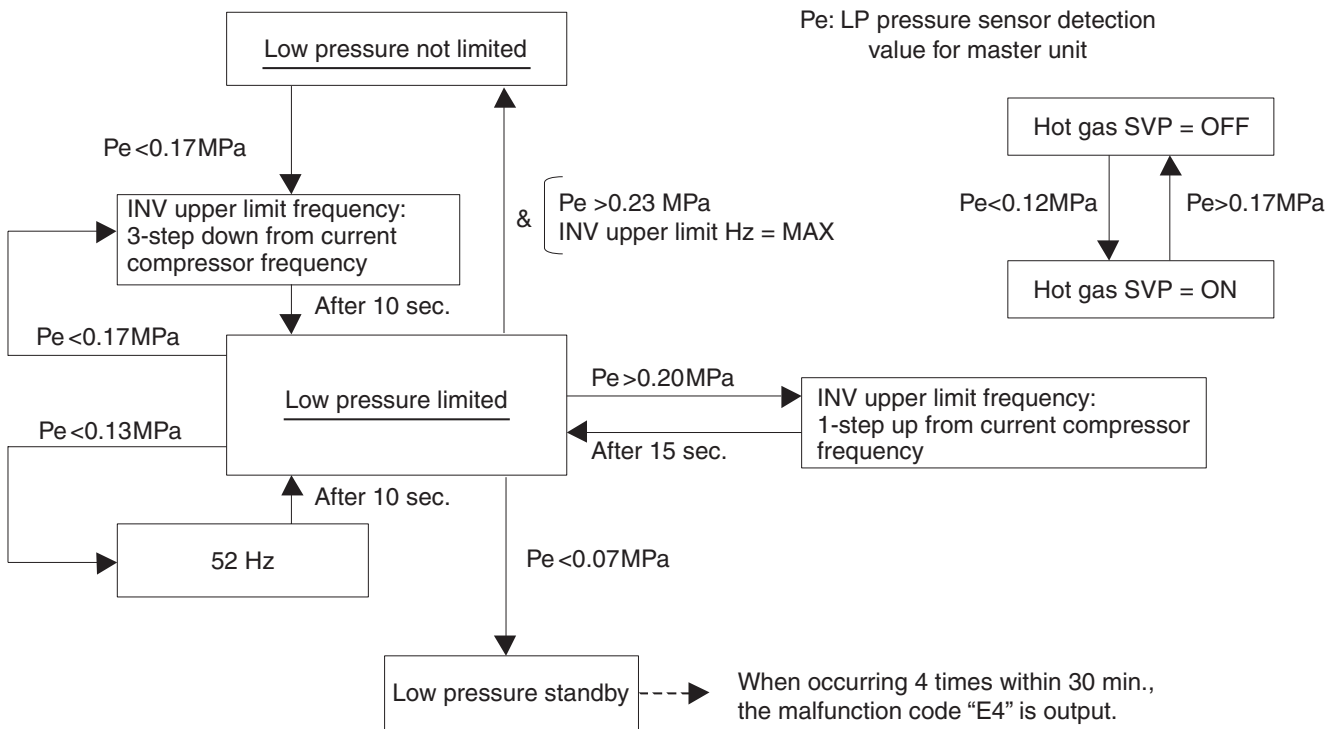

4.3 Discharge Pipe Protection Control

This discharge pipe protection control is used to protect the compressor internal temperature against a malfunction or transient increase of discharge pipe temperature.

- ★ Each compressor performs the discharge pipe temperature protection control individually in the following sequence.

[INV compressor]

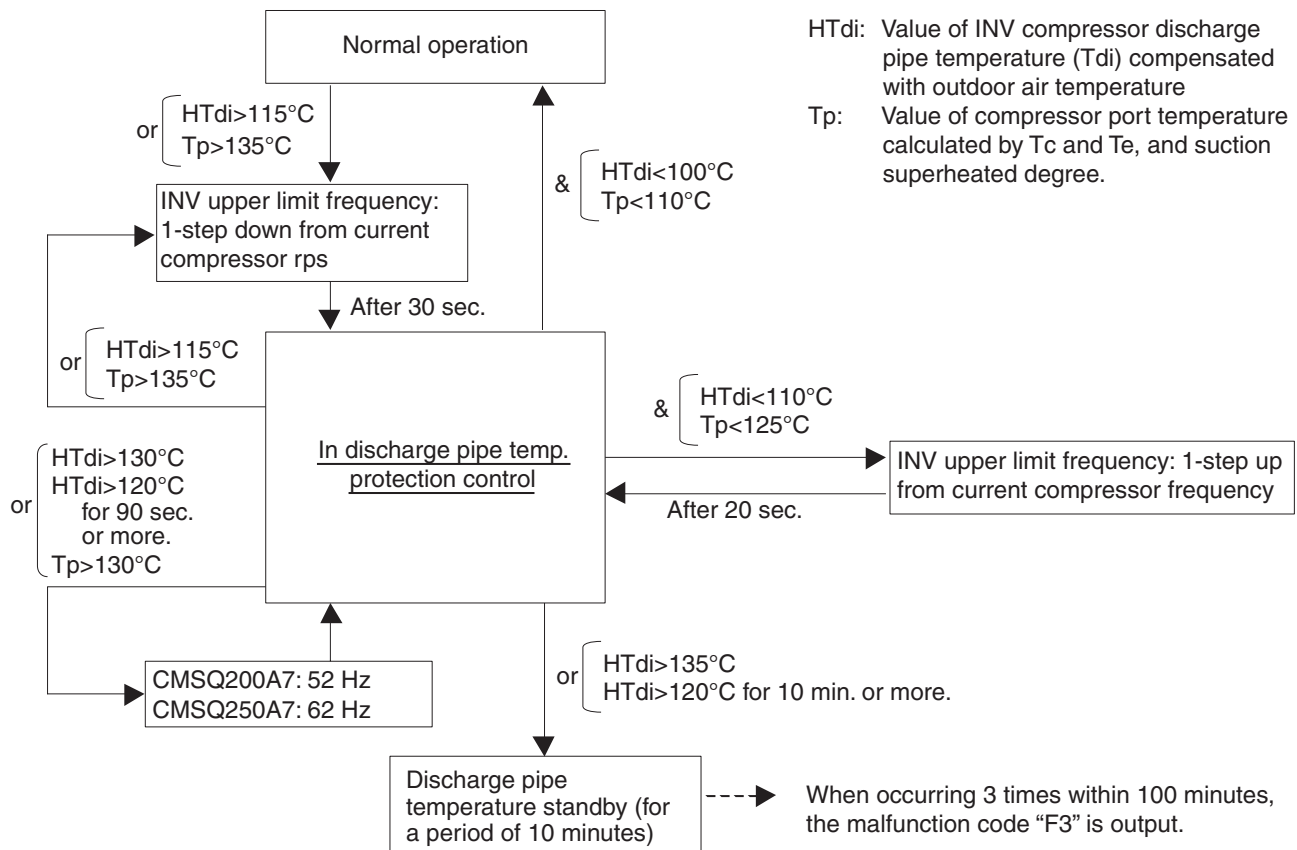

4.4 Inverter Protection Control

Inverter current protection control and inverter fin temperature control are performed to prevent tripping due to a malfunction, or transient inverter overcurrent, and fin temperature increase.

- ★ In the case of multi-outdoor-unit system, each INV compressor performs these controls in the following sequence.

[Inverter overcurrent protection control]

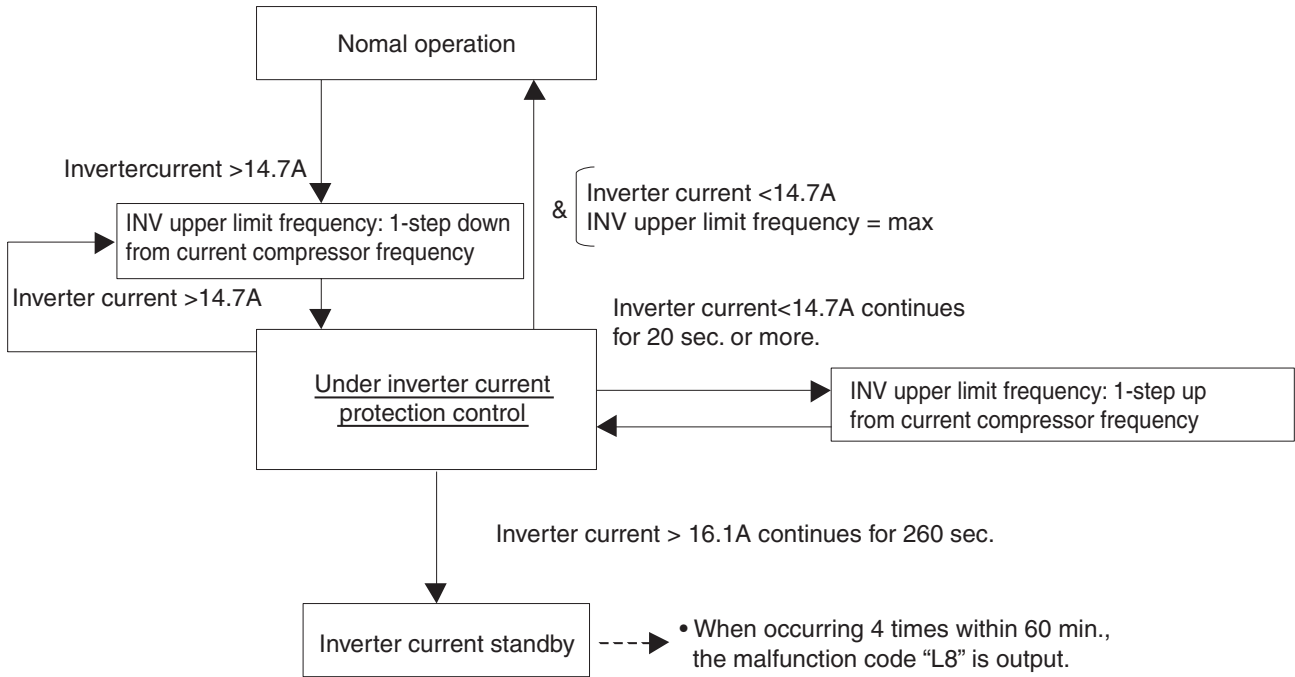

[Inverter fin temperature control]

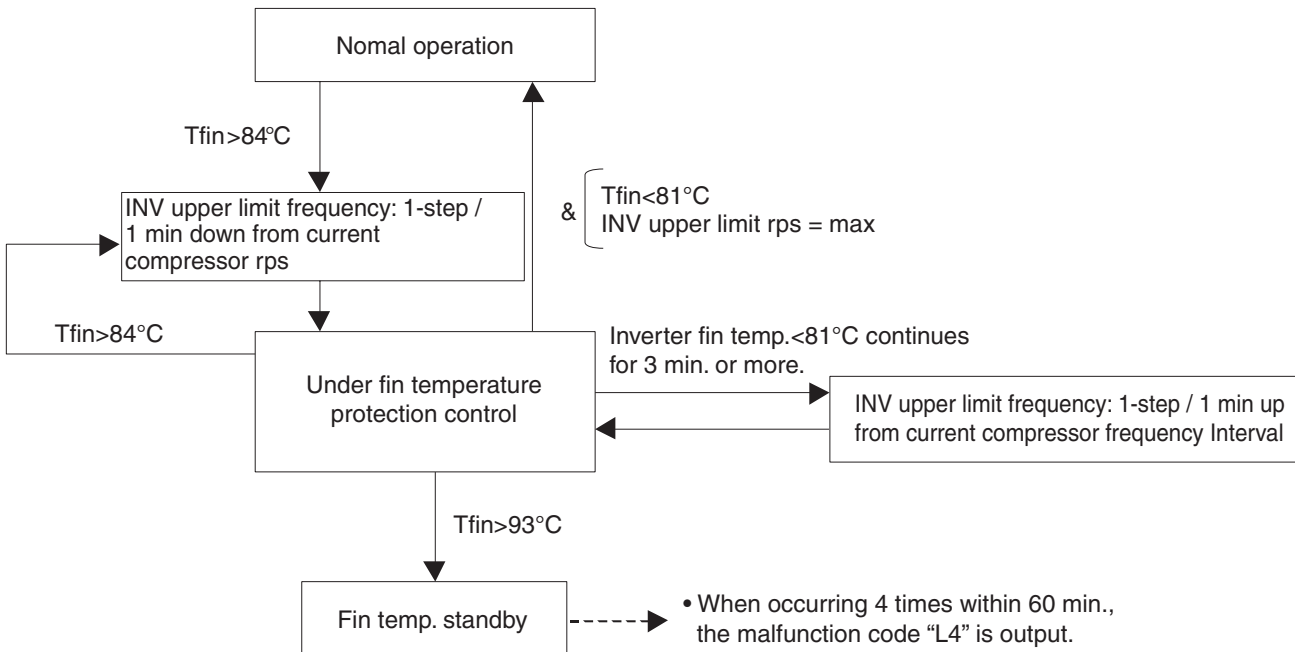

4.5 Injection Control (only for CMSQ200A7)

For transitional rise in discharge pipe temperature, have the liquid refrigerant flow into the suction side to reduce the discharge pipe temperature for the compressor protection.

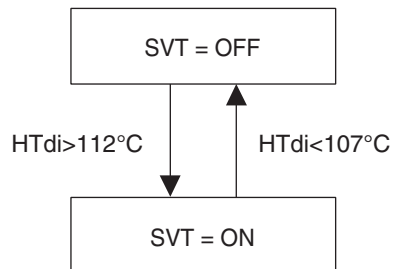

HTdi: Correction value of the discharge pipe temperature on the INV compressor.

5. Other Control

5.1 Demand Operation

In order to save the power consumption, the capacity of outdoor unit is saved with control forcibly by using "Demand 1 Setting" or "Demand 2 Setting".

To operate the unit with this mode, additional setting of "Continuous Demand Setting" or external input by external control adapter is required.

Set item	Condition	Content
Demand 1	Mode 1	The compressor operates at approx. 60% or less of rating.
	Mode 2	The compressor operates at approx. 70% or less of rating.
	Mode 3	The compressor operates at approx. 80% or less of rating.
Demand 2	—	The compressor operates at approx. 40% or less of rating.

5.2 Heating Operation Prohibition

Heating operation is prohibited above 24°C ambient temperature.

6. Outline of Control (Indoor Unit)

6.1 Drain Pump Control

- The drain pump is controlled by the ON/OFF buttons (4 button (1) - (4) given in the figure below).

6.1.1 When the Float Switch is Tripped while the Cooling Thermostat is ON:

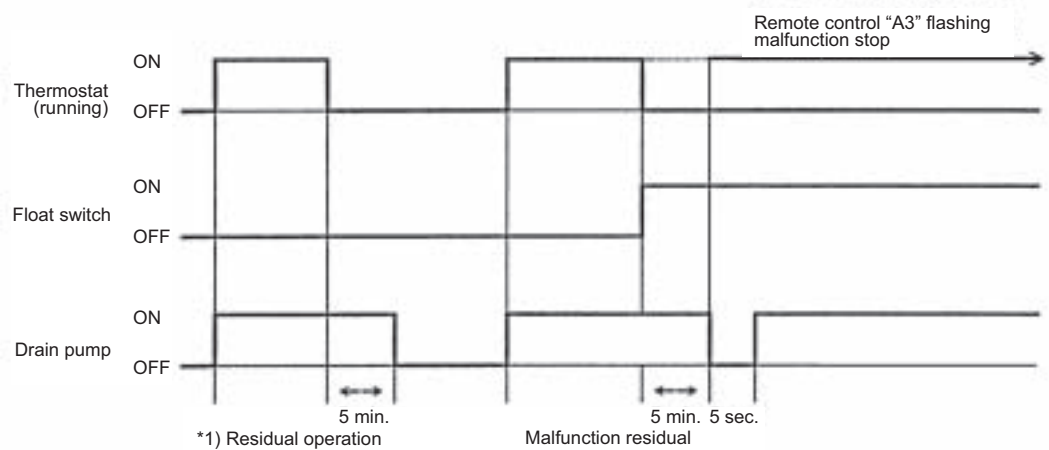

- * 1. The objective of residual operation is to completely drain any moisture adhering to the fin of the indoor unit heat exchanger when the thermostat goes off during cooling operation.

6.1.2 When the Float Switch is Tripped while the Cooling Thermostat is OFF:

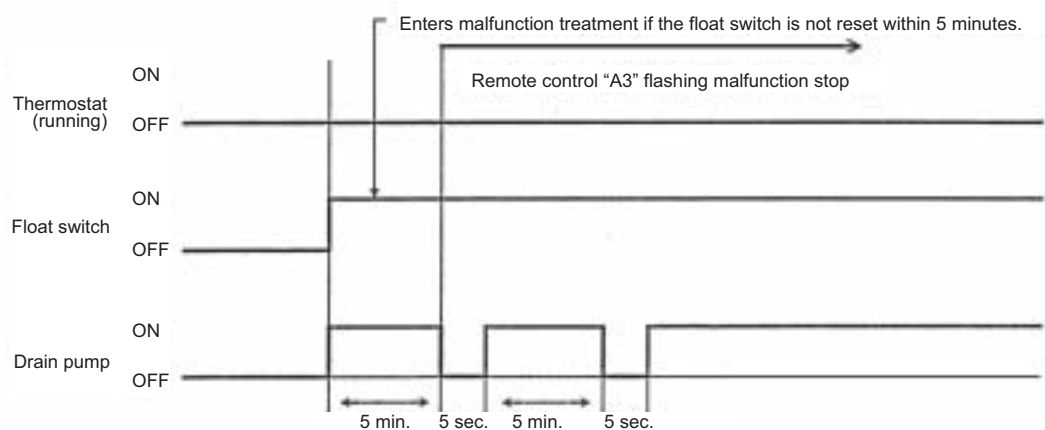

6.1.3 When the Float Switch is Tripped During Heating Operation:

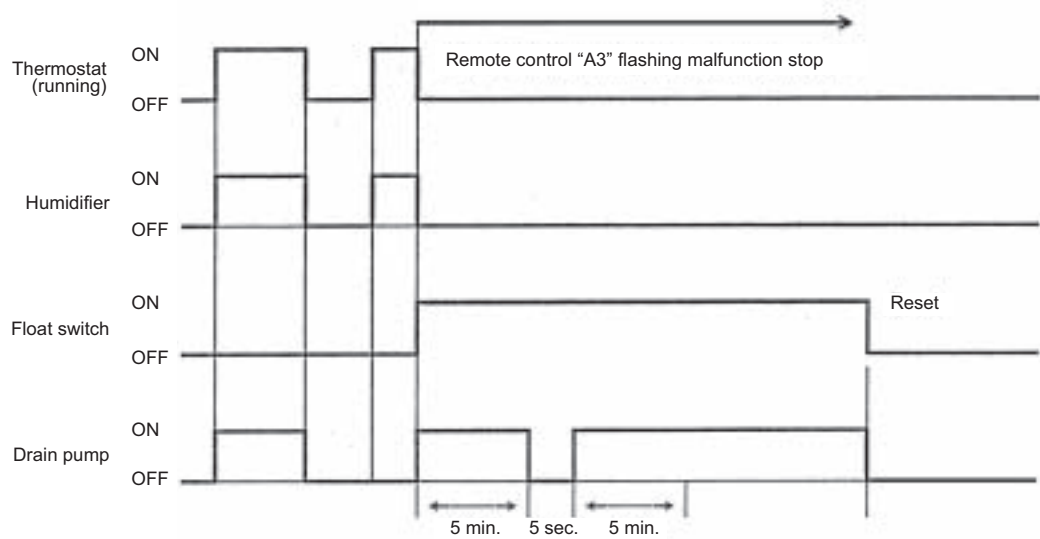

During heating operation, if the float switch is not reset even after the 5 minutes operation, 5 seconds stop, 5 minutes operation cycle ends, operation continues until the switch is reset.

6.1.4 When the Float Switch is Tripped and “AF” is Displayed on the Remote Control:

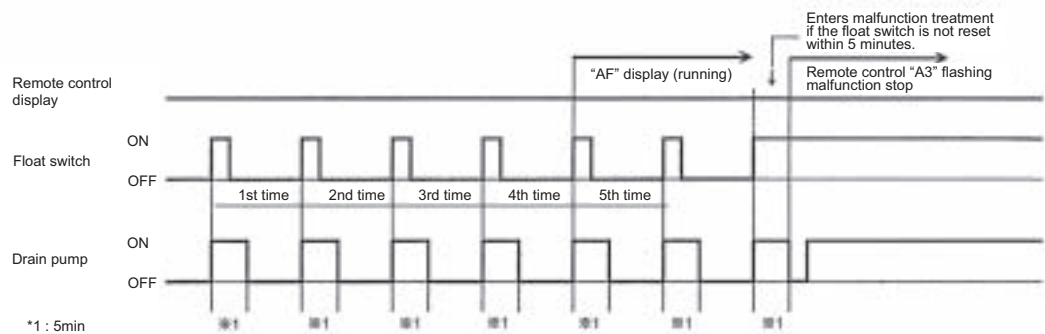

Note: If the float switch is tripped five times in succession, a drain malfunction is determined to have occurred. “AF” is then displayed as operation continues.

6.2 Louver Control for Preventing Ceiling Dirt

We have added a control feature that allows you to select the range of in which air direction can be adjusted in order to prevent the ceiling surrounding the air discharge outlet of ceiling mounted cassette type units from being soiled. (This feature is available on double flow, multi-flow and corner types.)

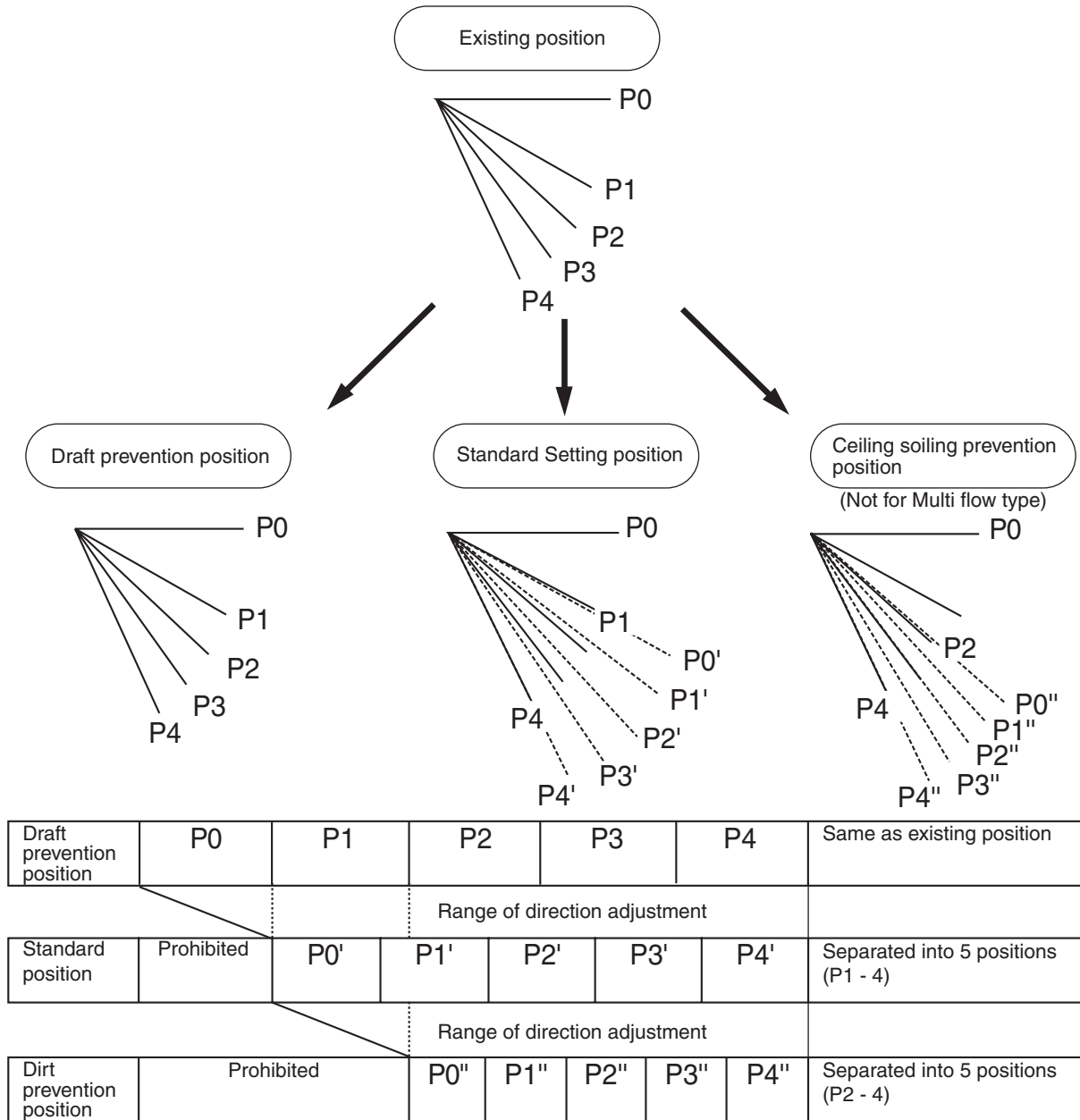

The factory set position is standard position.

6.3 Thermostat Sensor in remote control

Temperature is controlled by both the thermostat sensor in remote control and air suction thermostat in the indoor unit. (This is however limited to when the field setting for the thermostat sensor in remote control is set to "Use".)

Cooling

If there is a significant difference in the preset temperature and the suction temperature, fine adjustment control is carried out using a body thermostat sensor, or using the sensor in the remote control near the position of the user when the suction temperature is near the preset temperature.

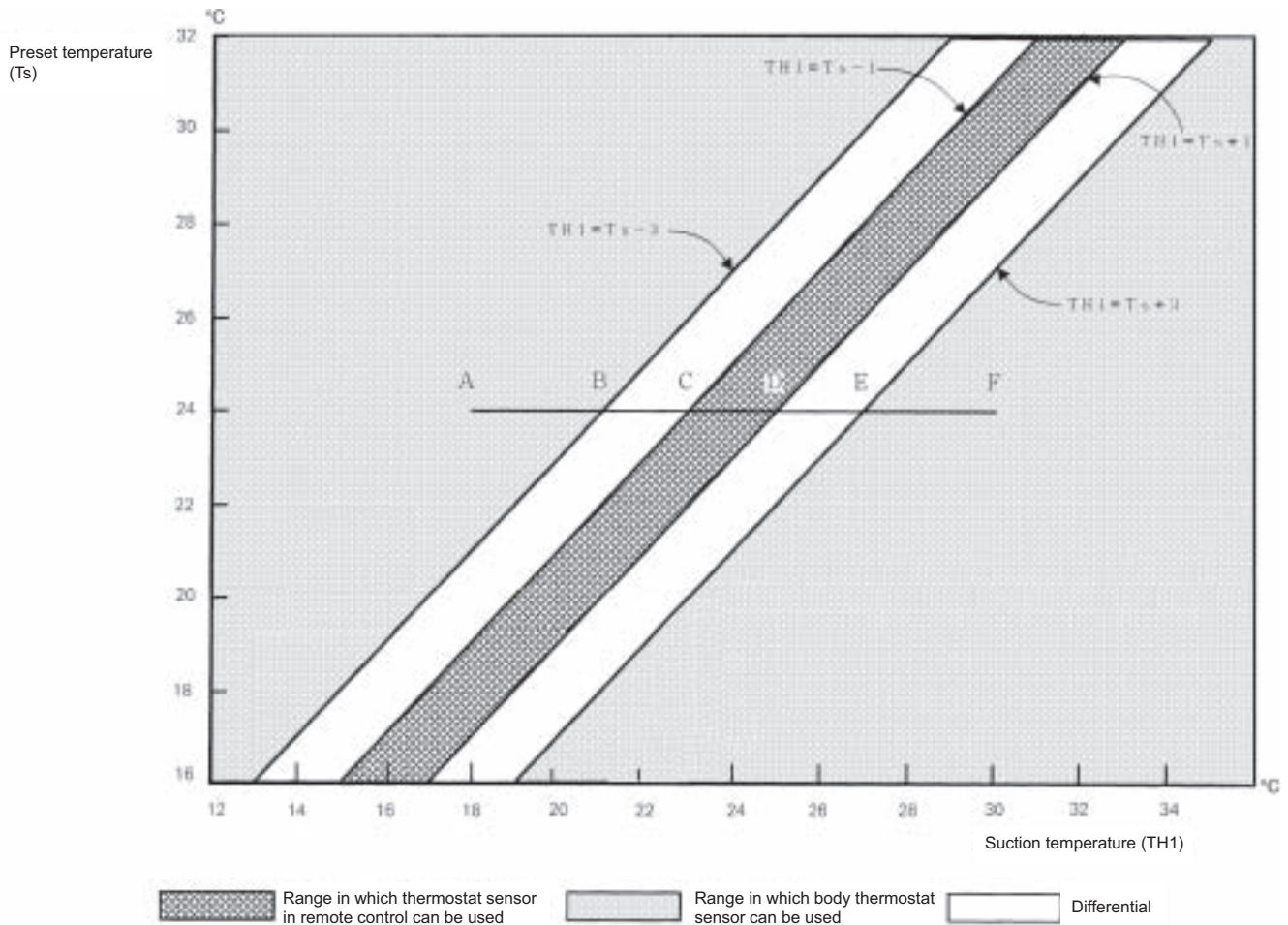

■ Ex: When cooling

Assuming the preset temperature in the figure above is 24°C, and the suction temperature has changed from 18°C to 30°C (A → F):

(This example also assumes there are several other air conditioners, the system is off, and that temperature changes even when the thermostat sensor is off.)

Body thermostat sensor is used for temperatures from 18°C to 23°C (A → C).

remote control thermostat sensor is used for temperatures from 23°C to 27°C (C → E).

Body thermostat sensor is used for temperatures from 27°C to 30°C (E → F).

And, assuming suction temperature has changed from 30°C to 18°C (F → A):

Body thermostat sensor is used for temperatures from 30°C to 25°C (F → D).

remote control thermostat sensor is used for temperatures from 25°C to 21°C (D → B).

Body thermostat sensor is used for temperatures from 21°C to 18°C (B → A).

Heating

When heating, the hot air rises to the top of the room, resulting in the temperature being lower near the floor where the occupants are. When controlling by body thermostat sensor only, the unit may therefore be turned off by the thermostat before the lower part of the room reaches the preset temperature. The temperature can be controlled so the lower part of the room where the occupants are doesn't become cold by widening the range in which thermostat sensor in remote control can be used so that suction temperature is higher than the preset temperature.

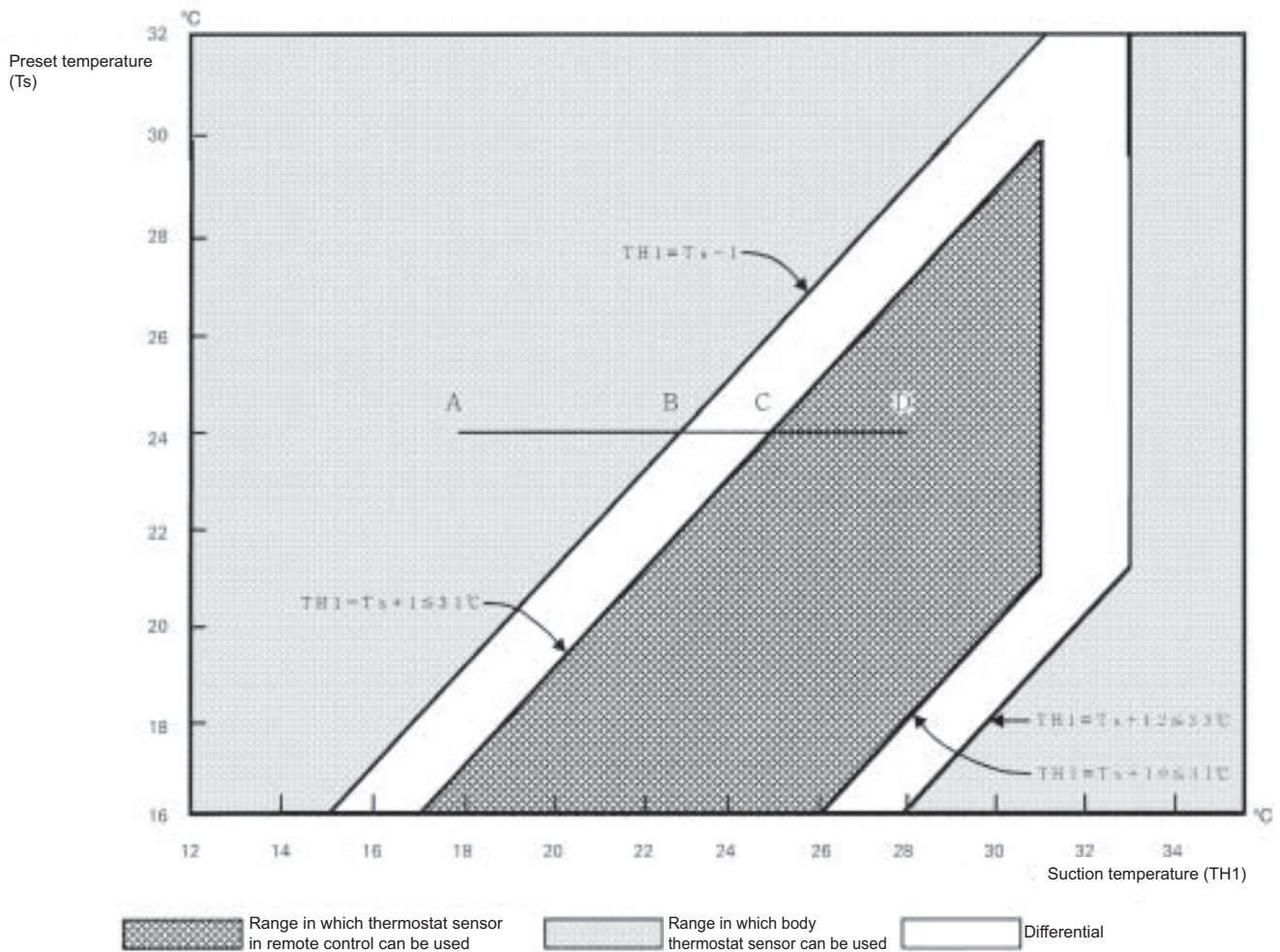

■ **Ex: When heating Assuming the preset temperature in the figure above is 24°C, and the suction temperature has changed from 18°C to 28°C (A → D):**

(This example also assumes there are several other air conditioners, the system is off, and that temperature changes even when the thermostat sensor is off.)

Body thermostat sensor is used for temperatures from 18°C to 25°C (A → C).

remote control thermostat sensor is used for temperatures from 25°C to 28°C (C → D).

And, assuming suction temperature has changed from 28°C to 18°C (D → A):

remote control thermostat sensor is used for temperatures from 28°C to 23°C (D → B).

Body thermostat sensor is used for temperatures from 23°C to 18°C (B → A).

6.4 Thermostat Control while in Normal Operation

The systems are set at factory to thermostat control mode using the remote control. While in normal thermostat differential control mode (i.e., factory set mode), the thermostat turns OFF when the system reaches a temperature of -1°C from the set temperature while in cooling operation or of $+1^{\circ}\text{C}$ from that while in heating operation.

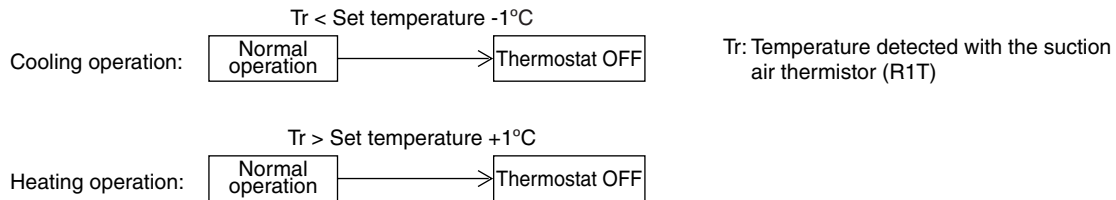

While in a single remote control group control, the body thermostat is only used for this control. Furthermore, while in heating operation, cassette-mounted indoor units conduct the thermostat control by a value compensated by -2°C for the value detected with the body thermostat. (Through field settings, the thermostat differential setting can be changed from 1°C to 0.5°C . For details on the changing procedure, refer to information on page onward.)

6.5 Thermostat Control in Dry Operation

While in dry operation, the thermostat control is conducted according to a suction temperature at the time of starting the dry operation.

Assuming that the suction air temperature at the time of starting the dry operation is Tro and the suction air temperature in operation is Tr ,

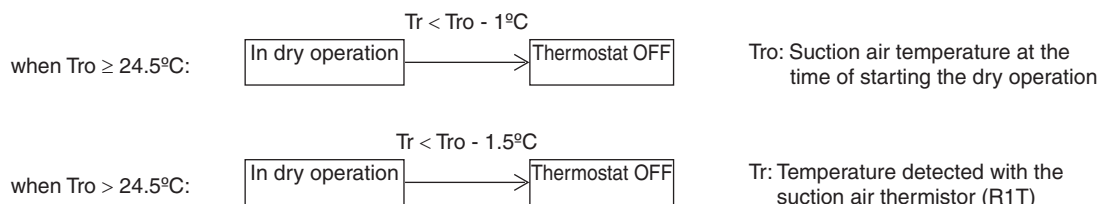

Furthermore, while in dry operation mode, fans operate at L flow rate, stop for a period of six minutes while the thermostat is OFF, and then return to operation at L flow rate. (This control is used to prevent a rise in indoor humidity while in thermostat OFF mode.)

6.6 Electronic Expansion Valve Control

- Electronic expansion Valve Control

In cooling, to maximize the capacity of indoor unit heat exchanger (evaporator), operate the electronic expansion valve under PI control so that the evaporator outlet superheated degree (SH) will become constant.

In heating, to maximize the capacity of indoor unit heat exchanger (condenser), operate the electronic expansion valve under PI control so that the evaporator outlet superheated degree (Condenser outlet subcooled degree) will become constant.

Cooling $SH=TH_2-TH_1$
 (Heating $SC=TC-TH_1$)

- SH : Evaporator outlet superheated degree
- TH₁: Temperature (°C) detected with the liquid thermistor
- TH₂: Temperature (°C) detected with the gas thermistor
- SC : Condenser outlet subcooled degree
- TC : High pressure equivalent saturated temperature

Furthermore, the default value of the optimal evaporator outlet superheated degree (condenser outlet subcooled degree) is 5 deg. However, this default value varies with the operating performance.

6.7 Hot Start Control (In Heating Operation Only)

At startup with thermostat ON or after the completion of defrosting in heating operation, the indoor unit fan is controlled to prevent cold air from blasting out and ensure startup capacity.

[Detail of operation]

When either the **start condition 1** or the **start condition 2** is established, the operations shown below will be conducted.

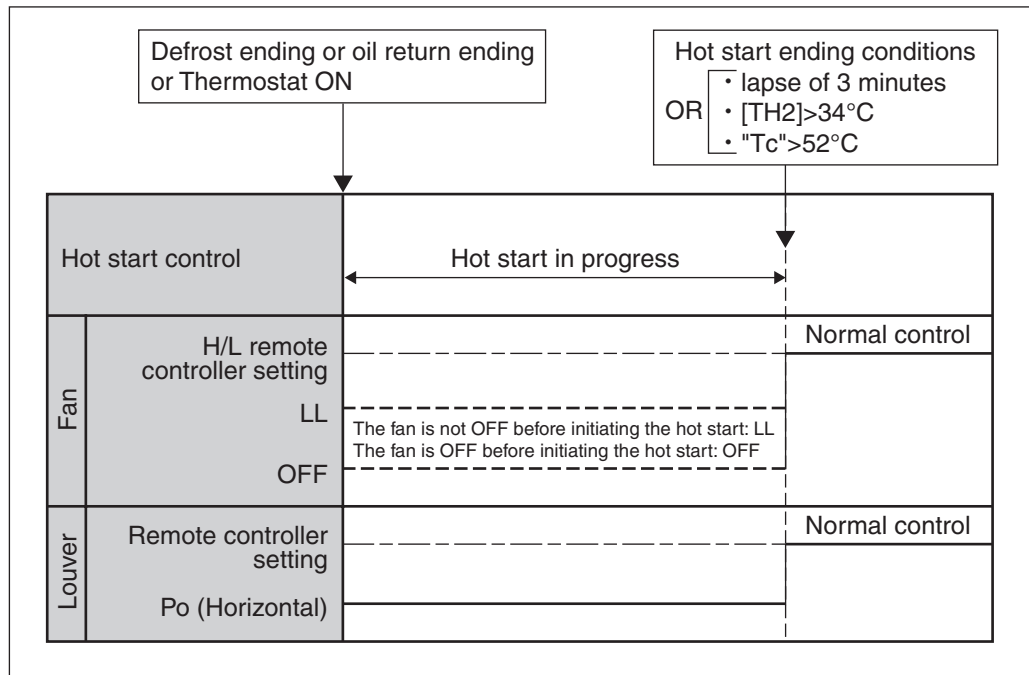

- TH₂: Temperature (°C) detected with the gas thermistor
- TC : High pressure equivalent saturated temperature

6.8 Freeze Prevention

Freeze Prevention by Off Cycle (Indoor Unit)

When the temperature detected by liquid pipe temperature thermistor (R2T) of the indoor unit heat exchanger drops too low, the unit enters freeze prevention operation in accordance with the following conditions, and is also set in accordance with the conditions given below.

Conditions for starting freeze prevention: Temperature is -1°C or less for total of 40 min., or temperature is -5°C or less for total of 10 min.

Conditions for stopping freeze prevention: Temperature is $+7^{\circ}\text{C}$ or more for 10 min. continuously

Ex: Case where temperature is -5°C or less for total of 10 min.

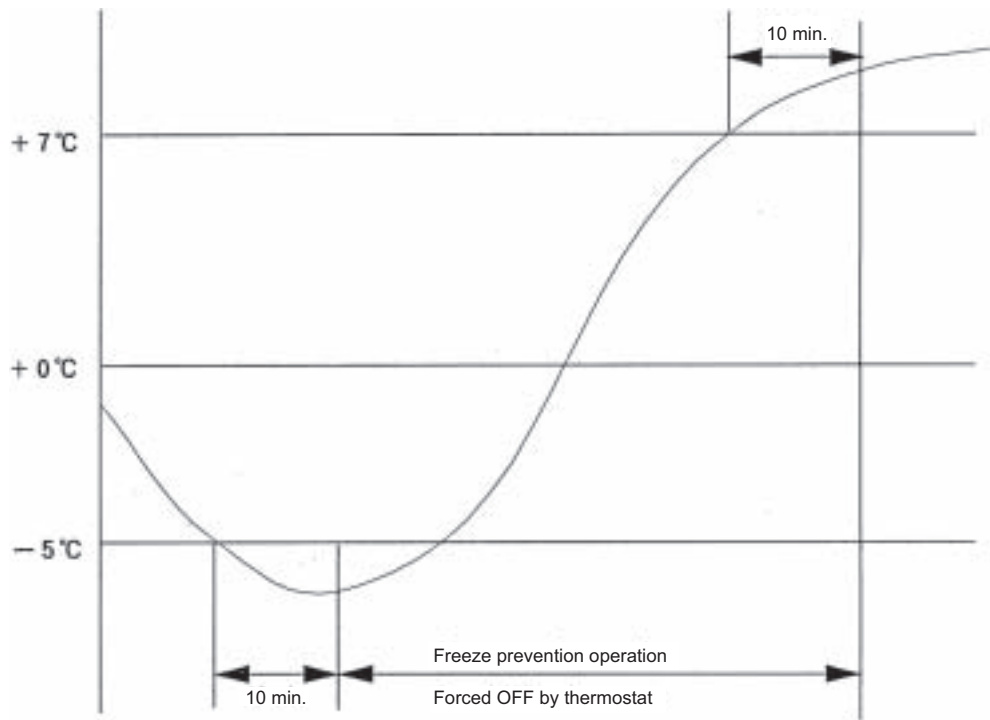

6.9 Heater Control

The heater control is conducted in the following manner.

[Normal control]

While in heating operation, the heater control (ON/OFF) is conducted as shown on the right.

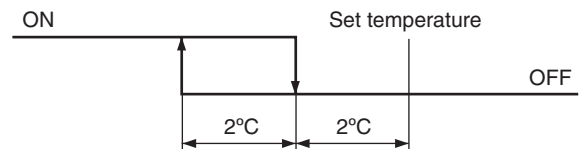

[Overload control]

When the system is overloaded in heating operation, the heater will be turned OFF in the following two manners.

- (1) The heater control (ON/OFF) is conducted through the liquid pipe temperature (R2T) of the indoor unit.

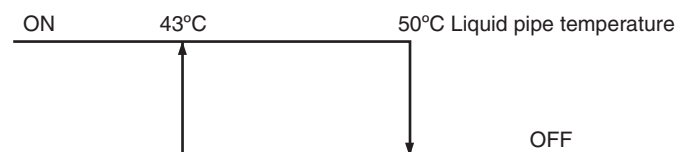

(2) The heater control (ON/OFF) is conducted by converting the heater temperature into the condensing pressure equivalent saturated temperature (T_c) according to the temperature detection through the high pressure sensor (SINPH) of the outdoor unit.

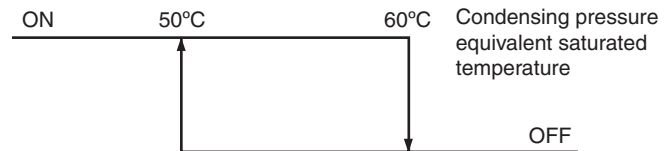

[Fan residual operation]

While the heater turns OFF, in order to prevent the activation of the thermal protector, the fan conducts residual operation for a given period of time after the heater turns OFF. (This operation is conducted regardless of with or without heater equipped.)

Residual operation time = 100 seconds on ceiling suspended type or 60 seconds on other types

6.10 List of Swing Flap Operations

Swing flaps operate as shown in table below.

			Fan	Flap FMCQ
Heating	Hot start from defrosting operation	Swing	OFF	Horizontal
		Wind direction set	OFF	Horizontal
	Defrosting operation	Swing	OFF	Horizontal
		Wind direction set	OFF	Horizontal
	Thermostat OFF	Swing	LL	Horizontal
		Wind direction set	LL	Horizontal
	Hot start from thermostat OFF mode (for prevention of cold air)	Swing	LL	Horizontal
		Wind direction set	LL	Horizontal
	Stop	Swing	OFF	Horizontal
		Wind direction set	OFF	Horizontal
Cooling	Thermostat ON in dry operation using micro computer	Swing	L* ¹	Swing
		Wind direction set	L* ¹	Set
	Thermostat OFF in dry operation using micro computer	Swing	OFF or L	Swing
		Wind direction set		Horizontal or Set
	Thermostat OFF in cooling	Swing	Set	Swing
		Wind direction set	Set	Set
	Stop	Swing	OFF	Horizontal
		Wind direction set	OFF	Horizontal
	Micro computer control (including cooling operation)	Swing	L	Swing
		Wind direction set	L	Set

*1. L or LL only on FMCQ models

Part 5

Test Operation

1. Test Operation	64
1.1 Installation Process	64
1.2 Procedure and Outline	65
1.3 Operation when Power is Turned On	80
2. Outdoor Unit PC Board Layout	81
3. Field Setting	82
3.1 Field Setting from remote control	82
3.2 Field Setting from Outdoor Unit.....	96

1. Test Operation

1.1 Installation Process

Below figure shows the installation process. Install in the order of the steps shown.

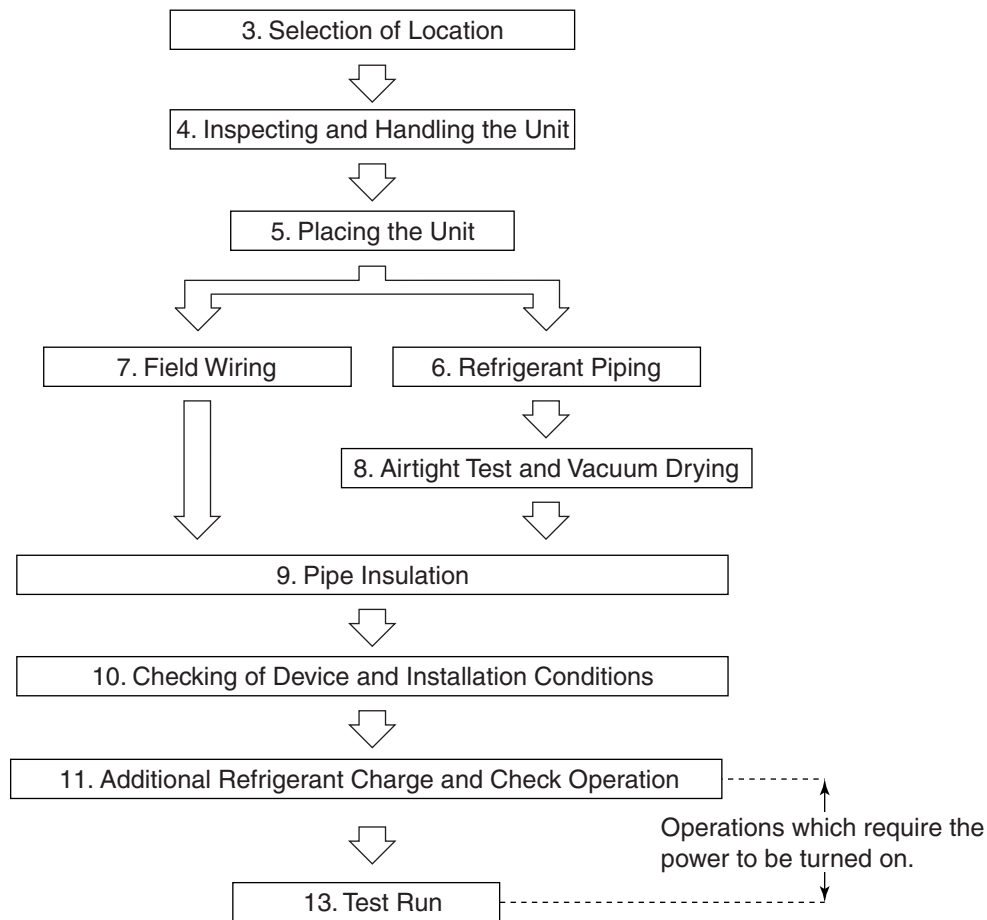

1.2 Procedure and Outline

Follow the following procedure to conduct the initial test operation after installation.

1.2.1 Check Work Prior to Turn Power Supply On

Check the below items.

- Power wiring
- Control transmission wiring between units
- Earth wire



- Is the wiring performed as specified?
- Is the designated wire used?
- Is the wiring screw of wiring not loose?
- Is the grounding work completed?
- Is the insulation of the main power supply circuit deteriorated?
Use a 500V megger tester to measure the insulation. (*1)
- Do not use a megger tester for other circuits than 200V (or 240V) circuit.

*1: Measure to be taken against decreased insulation resistance in the compressor

If the compressor is left to stand for an extended period of time after the refrigerant charge with the stop valve open and the power supply OFF, the refrigerant may be mixed in the compressor, thus decreasing the insulation resistance.

Heat the compressor as shown on the right and then recheck the insulation.

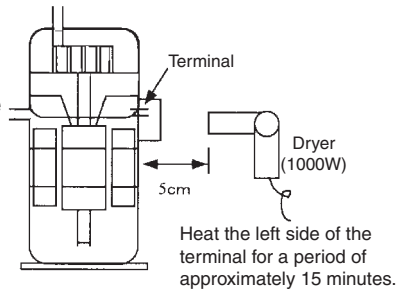

Check on refrigerant piping / insulation materials



Check airtight test and vacuum drying.



Check on amount of refrigerant charge



- Is the pipe size proper?
- Is the pipe insulation material installed securely?
Liquid and gas pipes need to be insulated. (Otherwise causes water leak.)
- Have the airtight test and the vacuum drying been conducted according to the procedure in the Installation Manual?
- Is a proper quantity of refrigerant refilled?
The following two methods are available for refilling of the refrigerant.
 - (1) Use the automatic refrigerant refilling function.
 - (2) Calculate a refrigerant refilling quantity.

Check the stop valves for conditions.

- Check to be sure the stop valves are under the following conditions.

Liquid-side stop valve	Gas-side stop valve
Open	Open

1.2.2 Turn Power On

Turn outdoor unit and indoor unit power on.



Check the LED display of the outdoor unit PC board.



Make field settings with outdoor unit PC board.



Conduct check operations.



Check for normal operation.

- Be sure to turn the power on 6 hours before starting operation to protect compressors. (to power on crankcase heater)

- Check to be sure the transmission is normal. The transmission is normal if the LEDs display conditions as shown in table below.

LED display ○ ON ● OFF ◐ Blinking

Micro-computer operation monitor	Mode	Ready /Error	Cooling/Heating changeover			Low noise	Demand	Multi
			Individual	Bulk (master)	Bulk (slave)			
HAP	H1P	H2P	H3P	H4P	H5P	H6P	H7P	H8P
◐	●	●	○	●	●	●	●	●

- Make field settings if needed. (For the setting procedure, refer to information in "3.2. Field Setting from Outdoor Unit" on page 96 onward.) For the outdoor-multi system, make field settings with the master unit. (Field settings made with the slave unit will be all invalid.)

The check operations shown below will be automatically initiated.

- Check for erroneous wirings
- Check for failure to open stop valves
- Check for excessive refrigerant refilling
- Automatic judgment of piping length

- Before starting the normal operation after the completion of check operations, make sure indoor and outdoor units normally operate.

1.2.3 Leak Test and Vacuum Drying

The units were checked for leaks by the manufacturer.
After connecting the field piping, perform the following inspections.

1.2.3.1 Preparations

Referring to figure 19, connect a nitrogen tank, a cooling tank, and a vacuum pump to the outdoor unit and perform the airtightness test and the vacuum drying. The stop valve and valve A in figure 19 should be open and closed as shown in the table below when performing the airtightness test and vacuum drying.

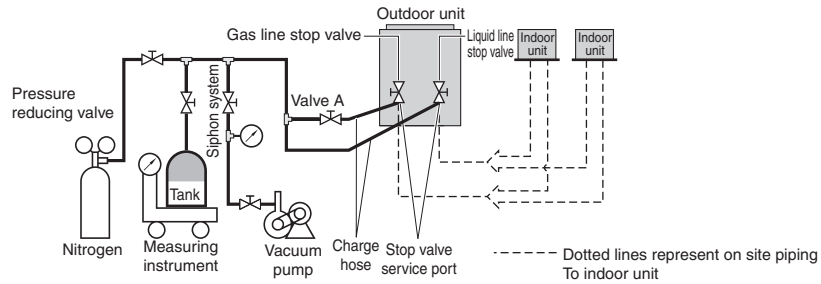

fig. 19

State of the valve A and the stop valve	Valve A	Liquid side stop valve	Gas side stop valve
Performing the airtightness test and vacuum drying	Open	Close	Close

1.2.3.2 Airtightness Test and Vacuum Drying

Note:

Make sure to perform airtightness test and vacuum drying using the service ports of the stop valves of the liquid side and of the gas side. (For the service port location, refer to the "Caution" label attached on the front panel of the outdoor unit.)

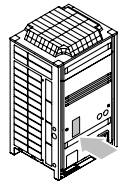

- See "1.2.5.3 Stop valve operation procedure" on page 70 for details on handling the stop valve.
- To prevent entry of any contamination and to prevent insufficient pressure resistance, always use the special tools dedicated for working with R-410A refrigerant.

■ Airtightness test:

Note:

Make sure to use nitrogen gas.

Pressurize the liquid and gas pipes to 4.0 MPa (40 bar) (do not pressurize more than 4.0 MPa (40 bar)). If the pressure does not drop within 24 hours, the system passes the test. If the pressure drops, check where the nitrogen leaks from.

- Vacuum drying: Use a vacuum pump which can evacuate to -100.7 kPa (5 Torr, -755 mm Hg)
 1. Evacuate the system from the liquid and gas pipes by using a vacuum pump for more than 2 hours and bring the system to -100.7 kPa. After keeping the system under that condition for more than 1 hour, check if the vacuum gauge rises or not. If it rises, the system may either contain moisture inside or have leaks.

2. Following should be executed if there is a possibility of moisture remaining inside the pipe (if piping work is carried out during the raining season or over a long period of time, rainwater may enter the pipe during work).

After evacuating the system for 2 hours, pressurize the system to 0.05 MPa (vacuum break) with nitrogen gas and evacuate the system again using the vacuum pump for 1 hour to -100.7 kPa (vacuum drying). If the system can not be evacuated to -100.7 kPa within 2 hours, repeat the operation of vacuum break and vacuum drying.

Then, after leaving the system in vacuum for 1 hour, confirm that the vacuum gauge does not rise.

1.2.4 Pipe Insulation

After finishing the leak test and vacuum drying, the piping must be insulated. Take into account the following points:

- Make sure to insulate the connection piping and refrigerant branch kits entirely.
- Be sure to insulate liquid and gas piping (for all units).
- Use heat resistant polyethylene foam which can withstand a temperature of 70°C for liquid side piping and polyethylene foam which can withstand a temperature of 120°C for gas side piping.
- Reinforce the insulation on the refrigerant piping according to the installation environment.

Ambient temperature	Humidity	Minimum thickness
≤30°C	75% to 80% RH	15 mm
>30°C	≥80 RH	20 mm

Condensation might form on the surface of the insulation.

- If there is a possibility that condensation on the stop valve might drip down into the indoor unit through gaps in the insulation and piping because the outdoor unit is located higher than the indoor unit this must be prevented by sealing up the connections. See figure 10.

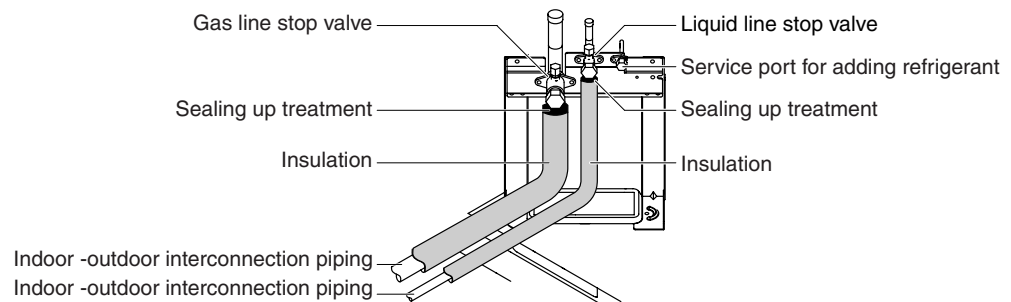

fig. 10



Be sure to insulate local pipes, as touching them can cause burns.

1.2.5 Charging Refrigerant

The outdoor unit is factory charged, but depending on the length of the piping when installed, the outdoor unit may require additional charging.

For charging the additional refrigerant follow the procedure as described in this chapter.



Refrigerant can not be charged until all field wiring and field piping has been completed. Refrigerant may only be charged after performing the leak test and the vacuum drying.

1.2.5.1 Important Information Regarding the Refrigerant Used

This product contains fluorinated greenhouse gases covered by the Kyoto Protocol. Do not vent gases into the atmosphere.

Refrigerant type: R-410A

GWP⁽¹⁾ value: 1975

⁽¹⁾GWP = global warming potential

Please fill in with indelible ink,

- ① the factory refrigerant charge of the product,
- ② the additional refrigerant amount charged in the field and
- ① + ② the total refrigerant charge

on the fluorinated greenhouse gases label supplied with the product.

The filled out label must be adhered on the inside of the product and in the proximity of the product charging port (e.g. on the inside of the service cover).

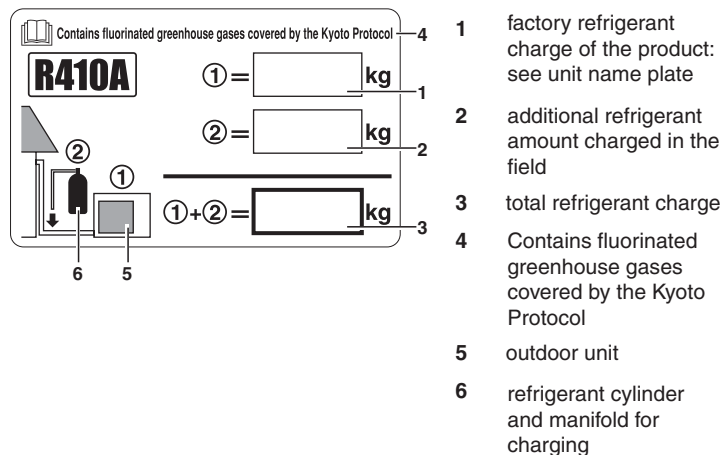

Note:

National implementation of EU regulation on certain fluorinated greenhouse gases may require to provide the appropriate official national language on the unit.

Therefore an additional multilingual fluorinated greenhouse gases label is supplied with the unit. Sticking instructions are illustrated on the backside of that label.

1.2.5.2 Precautions when Adding R-410A

Be sure to charge the specified amount of refrigerant in liquid state to the liquid pipe.

Since this refrigerant is a mixed refrigerant, adding it in gas form may cause the refrigerant composition to change, preventing normal operation.

- Before charging, check whether the refrigerant cylinder is equipped with a siphon tube or not.

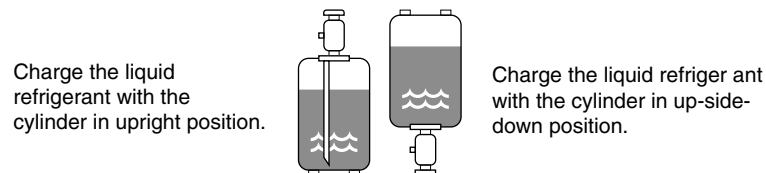

- Be sure to use tools exclusively for R-410A to ensure required pressure resistance and to prevent foreign materials from mixing into the system.



Charging with an unsuitable substance may cause explosions and accidents, so always make sure that the appropriate refrigerant (R-410A) is charged.

Refrigerant containers must be opened slowly.

1.2.5.3 Stop Valve Operation Procedure



- Do not open the stop valve until all piping and electrical steps of "1.2.1. Check Work Prior to Turn Power Supply On" on page 65 are completed. If the stop valve is left open without turning on the power, it may cause refrigerant to build up in the compressor, leading to insulation degradation.
- Always use a charge hose for service port connection.
- After tightening the cap, check that no refrigerant leaks are present.

Size of stop valve

The sizes of the stop valves connected to the system are as listed in the table below.

Type	CMSQ200	CMSQ250
Liquid line stop valve	φ9.5	
Gas line stop valve	φ15.9	φ19.1

Opening stop valve (See figure 15)

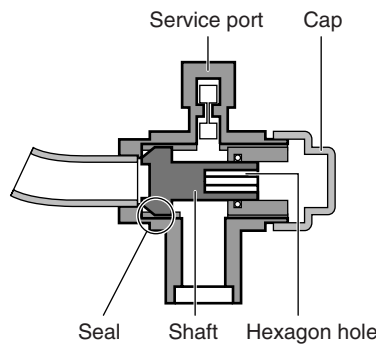

fig. 15

1. Remove the cap and turn the valve counterclockwise with the hexagon wrench.
2. Turn it until the shaft stops.



Do not apply excessive force to the stop valve. Doing so may break the valve body, as the valve is not a backseat type. Always use the special tool.

3. Make sure to tighten the cap securely. Refer to the table below

Stop valve size	Tightening torque N•m (Turn clockwise to close)			
	Shaft		Cap (valve lid)	Service port
	Valve body	Hexagonal wrench		
φ9.5	5.4~6.6	4 mm	13.5~16.5	11.5~13.9
φ15.9	13.5~16.5	6 mm	23.0~27.0	
φ19.1	27.0~33.0	8 mm	22.5~27.5	

Closing stop valve (See figure 15)

1. Remove the cap and turn the valve clockwise with the hexagon wrench.
2. Securely tighten the valve until the shaft contacts the main body seal.
3. Make sure to tighten the cap securely.
For the tightening torque, refer to the table above.

1.2.5.5 Additional Refrigerant Charge

Follow the procedures below.



- When charging a system, charging over the permissible quantity can cause liquid hammer.
- Always use protective gloves and protect your eyes when charging refrigerant.
- When the refrigerant charging procedure is done or when pausing, close the valve of the refrigerant tank immediately. If the tank is left with the valve open, the amount of refrigerant which is properly charged may get off point. More refrigerant may be charged by any remaining pressure after the unit has stopped.



Electric shock warning

- Close the electric box lid before turning on the main power.
- Perform the settings on the circuit board (A1P) of the outdoor unit and check the LED display after the power is on via the service lid which is in the lid of the electric box. Operate switches with an insulated stick (such as a ball-point pen) to avoid touching the life parts.
Make sure to re-attach the inspection cover into the switch box cover after the job is finished.



- If the power of some units is turned off, the charging procedure can not be finished properly.
- Make sure to turn ON the power 6 hours before starting the operation. This is necessary to warm the crankcase by the electric heater.
- If operation is performed within 12 minutes after the indoor and outdoor units are turned on, the H2P-LED will be lit and the compressor will not operate.

Note:

- See "1.2.5.3 Stop Valve Operation Procedure" on page 70 for details on how to handle stop valves.
- The refrigerant charging port is connected to the piping inside the unit. The unit's internal piping is already factory charged with refrigerant, so be careful when connecting the charge hose.
- After adding the refrigerant, do not forget to close the lid of the refrigerant charging port. The tightening torque for the lid is 11.5 to 13.9 N·m.
- In order to ensure uniform refrigerant distribution, it may take the compressor ± 10 minutes to start up after the unit has started operation. This is not a malfunction.

■ Charge with the outdoor unit at standstill

1. Calculate how much refrigerant to be added.
2. Valve A and the stop valves must be left closed, charge the required amount of refrigerant through the liquid side stop valve service port.
 - When the required amount of refrigerant is fully charged.
Record the amount of refrigerant that was added on the additional refrigerant charge label provided with the unit and attach it on the back side of the front panel. Perform the test procedure as described in "Test operation" on page 77.



If the total refrigerant cannot be charged while the outdoor unit is at standstill, it is possible to charge the refrigerant by operating the outdoor unit using the refrigerant charge function (refer to "Setting mode 2" on page 76).

Charging while the outdoor unit is operating

1. Completely open the gas line stop valve.
Valve A must be left fully closed.
Make sure the liquid stop valve is totally shut. If it is open, the refrigerant cannot be charged.
Charge the additional refrigerant in its liquid state through the service port of the liquid line stop valve.
2. While the unit is at standstill and under setting mode 2 (refer to Checks before initial start-up, "Setting the mode" on page 76), set the required function A (additional refrigerant charging operation) to **ON** (ON). Then operation starts. The blinking H2P led indicates test operation and the remote control indicates **TEST** (test operation) and  (external control).
3. When the specified amount of refrigerant is charged, push the **BS1 MODE** button. Then operation stops.
 - The operation automatically stops within 30 minutes.
 - If the refrigerant charge cannot be finished within 30 minutes, repeat step 2.
 - If the operation stops immediately after restart, there is a possibility that the system is overcharged.
The refrigerant cannot be charged more than this amount.
4. After the refrigerant charge hose is removed, make sure to fully open the liquid stop valve. Otherwise the piping may burst due to blocked liquid.
5. After the refrigerant is charged, turn on the power for the indoor units and for the outdoor unit.

1.2.5.6 Checks after Adding Refrigerant

- Are the stop valves for both liquid and gas open?
- Is the amount of refrigerant, that has been added, recorded?



Make sure to open the stop valves after charging the refrigerant.
Operating with the stop valves closed will damage the compressor.

1.2.6 Before Operation

1.2.6.1 Service Precautions



Warning : **ELECTRIC SHOCK** 

Caution when performing service to inverter equipment

1. Do not open the electric box cover for 10 minutes after the power supply is turned off.
2. Measure the voltage between terminals on the terminal block for power supply with a tester and confirm that the power supply is shut off.
In addition, measure the points, as shown in the figure below, with a tester and confirm that the voltage of the capacitor in the main circuit is less than 50 V DC.

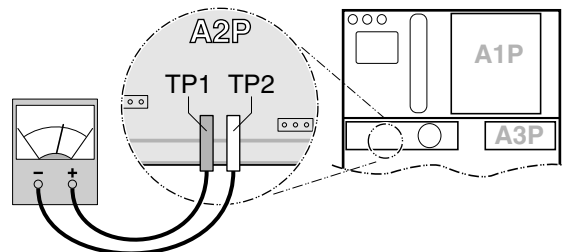

3. To prevent damaging the PC board, touch a non-coated metal part to eliminate static electricity before pulling out or plugging in connectors.
4. The performing of the service to the inverter equipment must be started after the junction connectors X1A and X2A for the fan motors in the outdoor unit are been pulled out. Be carefull not to touch the live parts.
(If a fan rotates due to strong wind, it may store electricity in the capacitor or in the main circuit and cause electric shock.)
5. After the service is finished, plug the junction connector back in. Otherwise the error code *E7* will be displayed on the remote control and normal operation will not be performed.
For details refer to the wiring diagram labeled on the back of the electric box cover.

Pay attention to the fan. It is dangerous to inspect the unit while the fan is running. Be sure to turn off the main switch and to remove the fuses from the control circuit located in the outdoor unit.

Note:

Play it safe!

For protection of the PC board, touch the switch box casing by hand in order to eliminate static electricity from your body before performing service.

1.2.6.2 Checks before Initial Start-up

Note:

Remark that during the first running period of the unit, required power input may be higher than stated on the nameplate of the unit. This phenomenon originates from the compressor that needs elapse of a 50 hours run in period before reaching smooth operation and stable power consumption.



- Make sure that the circuit breaker on the power supply panel of the installation is switched off.
- Attach the power wire securely.
- Introducing power with a missing N-phase or with a mistaken N-phase will break the equipment.

After the installation, check the following before switching on the circuit breaker:

1. The position of the switches that require an initial setting
Make sure that switches are set according to your application needs before turning the power supply on.
2. Power supply wiring and transmission wiring
Use a designated power supply and transmission wiring and make sure that it has been carried out according to the instructions described in this manual, according to the wiring diagrams and according to local and national regulations.
3. Pipe sizes and pipe insulation
Make sure that correct pipe sizes are installed and that the insulation work is properly executed.
4. Air tight test and vacuum drying
Make sure the air tight test and vacuum drying were completed.
5. Additional refrigerant charge
The amount of refrigerant to be added to the unit should be written on the included "Added Refrigerant" plate and attached to the rear side of the front cover.
6. Insulation test of the main power circuit
Using a megatester for 500 V, check that the insulation resistance of 2 MΩ. or more is attained by applying a voltage of 500 V DC between power terminals and earth. Never use the megatester for the transmission wiring.
7. Installation date and field setting
Be sure to keep record of the installation date on the sticker on the rear of the upper front panel according to EN60335-2-40. and keep record of the contents of the field setting.

1.2.6.3 Field Setting

If required, carry out field settings according to the following instructions. Refer to the service manual for more details.

Opening the switch box and handling the switches

When carrying out field settings, remove the inspection cover (1). Operate the switches with an insulated stick (such as a ball-point pen) to avoid touching live parts.

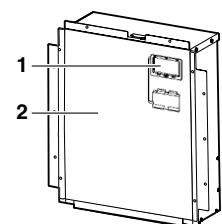
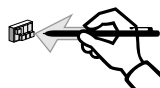

Make sure to re-attach the inspection cover (1) into the switch box cover (2) after the job is finished.

Note:

Make sure that all outside panels, except for the panel on the electric box, are closed while working.

Close the lid of the electric box firmly before turning on the power.

Location of the dip switches, LEDs and buttons

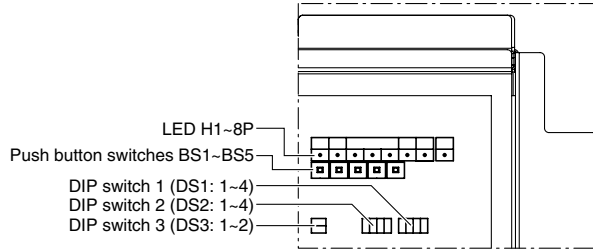

Do not change the factory setting of the DIP switches.

LED state

Throughout the manual the state of the LEDs is indicated as follows:

- OFF
- ON
- ◐ Blinking

Setting the push button switch (BS1~5)

Function of the push button switch which is located on the outdoor unit PC board (A1P):

MODE	TEST: ○	C/H SELECT			L.N.O.P	DEMAND	MULTI
	HWL: ○	IND	MASTER	SLAVE			
● H1P	● H2P	○ H3P	● H4P	● H5P	● H6P	● H7P	● H8P

BS1 MODE	BS2 SET	BS3 RETURN	BS4 TEST	BS5 RESET
-------------	------------	---------------	-------------	--------------

- BS1 MODE** For changing the set mode
- BS2 SET** For field setting
- BS3 RETURN** For field setting
- BS4 TEST** For test operation
- BS5 RESET** For resetting the address when the wiring is changed or when an additional indoor unit is installed

The figure shows state of the LED indications when the unit is shipped from the factory.

Check operation procedure

1. Turn the power on for the outdoor unit and the indoor unit.
Be sure to turn the power on at least 6 hours before operation in order to have power running to the crank case heater.
2. Make sure that transmission is normal by checking the LED display on the outdoor unit circuit board (A1P). (If transmission is normal, each LED will be displayed as shown below.)

Micro-computer operation monitor	Mode	Ready /Error	Cooling/Heating changeover			Low noise	Demand	Multi
			Individual	Bulk (master)	Bulk (slave)			
HAP	H1P	H2P	H3P	H4P	H5P	H6P	H7P	H8P
◐	●	●	○	●	●	●	●	●

Setting the mode

The set mode can be changed with the **BS1 MODE** button according to the following procedure:

- **For setting mode 1:** Press the **BS1 MODE** button once, the H1P LED is off ●.
 - **For setting mode 2:** Press the **BS1 MODE** button for 5 seconds, the H1P LED is on ○.
- If the H1P LED is blinking ◐ and the **BS1 MODE** button is pushed once, the setting mode will change to setting mode 1.

Note:

If you get confused in the middle of the setting process, push the **BS1 MODE** button. Then it returns to setting mode 1 (H1P LED is off).

Setting mode 1

The H1P LED is off (COOL/HEAT selection setting).

Setting procedure

1. Push the **BS2 SET** button and adjust the LED indication to either one of the possible settings as shown below in the field marked :

In case of COOL/HEAT setting by each individual outdoor unit circuit.

H1P	H2P	H3P	H4P	H5P	H6P	H7P
●	●	◐	●	●	●	●

2. Push the **BS3 RETURN** button and the setting is defined.

Setting mode 2

The H1P LED is on.

Setting procedure

1. Push the **BS2 SET** button according to the required function (A~H). The LED indication that matches the required function is shown below in the field marked :

Possible functions

- A** additional refrigerant charging operation.
- B** refrigerant recovery operation/vacuuming operation.
- C** setting of high static pressure.
- D** automatic low noise operation setting at nighttime.
- E** low noise operation level setting (**L.N.O.P**) via the external control adapter.
- F** power consumption limitation setting (**DEMAND**) via the external control adapter.
- G** enabling function of the low noise operation level setting (**L.N.O.P**) and/or power consumption limitation setting (**DEMAND**) via the external control adapter (DTA104A61/62).
- G** check operation (without initial refrigerant decision)

	H1P	H2P	H3P	H4P	H5P	H6P	H7P
A	○	●	○	●	○	●	●
B	○	●	○	●	○	●	○
C	○	●	○	●	●	○	●
D	○	●	○	●	○	○	●
E	○	●	○	○	●	●	○
F	○	●	○	○	○	○	●
G	○	●	●	○	○	●	●
H	○	●	●	●	●	○	○

2. When the **BS3 RETURN** button is pushed, the current setting is defined.
3. Push the **BS2 SET** button according to the required setting possibility as shown below in the field marked .

3.1 Possible settings for function A, B, C, G and H are **ON (ON)** or **OFF (OFF)**.

	H1P	H2P	H3P	H4P	H5P	H6P	H7P
ON	○	●	●	●	●	◐	●
OFF (a)	○	●	●	●	●	●	◐

(a) This setting = factory setting

3.2 Possible settings for function D

The noise of level 3 < level 2 < level 1 (◀ 1).

	H1P	H2P	H3P	H4P	H5P	H6P	H7P
OFF (a)	○	●	●	●	●	●	●
◀1	○	●	●	●	●	●	◐
◀2	○	●	●	●	●	◐	●
◀3	○	●	●	●	●	◐	◐

(a) This setting = factory setting

3.3 Possible settings for function E and F

For function E (L.N.O.P) only: the noise of level 3 < level 2 < level 1 (◀ 1).

For function F (DEMAND) only: the power consumption of level 1 < level 2 < level 3 (▶ 3).

	H1P	H2P	H3P	H4P	H5P	H6P	H7P
◀1	○	●	●	●	●	●	◐
▶2 (a)	○	●	●	●	●	◐	●
▶3	○	●	●	●	◐	●	●

(a) This setting = factory setting

4. Push the **BS3 RETURN** button and the setting is defined.
 5. When the **BS3 RETURN** button is pushed again, the operation starts according to the setting.
- Refer to the service manual for more details and for other settings.

Confirmation of the set mode

The following items can be confirmed by setting mode 1 (H1P LED is off)

Check the LED indication in the field marked .

1. Indication of the present operation state

- ● normal
- ○ abnormal
- ◐ under preparation or under test operation

H1P	H2P	H3P	H4P	H5P	H6P	H7P
●	●	○	●	●	●	●

2. Indication of COOL/HEAT selection setting

When set to COOL/HEAT change-over by each individual outdoor unit circuit (= factory setting).

H1P	H2P	H3P	H4P	H5P	H6P	H7P
●	●	○	●	●	●	●

3. Indication of low noise operation state L.N.O.P

- ● standard operation (= factory setting)
- ○ L.N.O.P operation

H1P	H2P	H3P	H4P	H5P	H6P	H7P
●	●	○	●	●	●	●

4. Indication of power consumption limitation setting DEMAND

- ● standard operation (= factory setting)
- ○ DEMAND operation

1.2.6.4 Test Operation



Do not insert fingers, rods or other objects into the air inlet or outlet. When the fan is rotating at high speed, it will cause injury.



Do not perform the test operation while working on the indoor units.

When performing the test operation, not only the outdoor unit, but the connected indoor unit will operate as well.

Working on a indoor unit while performing a test operation is dangerous.

- In the check operation, the following checks and judgement will be performed:
 - Check of the stop valve opening
 - Check for wrong wiring
 - Check of refrigerant overcharge
 - Judgement of piping length
- It takes ±40 minutes to complete the check operation.

Perform the test operation as described in the paragraph "Test operation procedure" on page 77.

Test operation procedure

1. Close all front panels except the front panel of the electric box.
2. Turn ON the power to all outdoor units and the connected indoor units.
Be sure to turn on the power 6 hours before operation in order to have power running to the crank case heater and to protect the compressor.
3. Make the field setting as described in the paragraph "1.2.6.3 Field setting" on page 74.
4. Press the **BS1 MODE** button once, and set to the SETTING MODE (H1P LED = OFF).
5. Press and hold the **BS4 TEST** button down for 5 seconds or more. The unit will start the test operation.
 - The test operation is automatically carried out in cooling mode, the H2P LED will light up and the messages "Test operation" and "Under centralized control" will display on the remote control.
 - It may take 10 minutes to bring the state of the refrigerant uniform before the compressor starts.
 - During the test operation, the refrigerant running sound or the magnetic sound of a solenoid valve may become loud and the LED display may change, but these are not malfunctions.
 - During the test operation, it is not possible to stop the unit operation from a remote control. To abort the operation, press the **BS3 RETURN** button. The unit will stop after ±30 seconds.
6. Close the front panel in order to let it not be the cause of misjudgement.
7. Check the test operation results by the LED display on the outdoor unit.

	H1P	H2P	H3P	H4P	H5P	H6P	H7P
Normal completion	●	●	○	●	●	●	●
Abnormal completion	●	○	○	●	●	●	●

8. When the test operation is fully completed, normal operation will be possible after 5 minutes. Otherwise, refer to "Correcting after abnormal completion of the test operation" on page 79 to take actions for correcting the abnormality.

Correcting after abnormal completion of the test operation

The test operation is only completed if there is no malfunction code displayed on the remote control. In case of a displayed malfunction code, perform the following actions to correct the abnormality:

- Confirm the malfunction code on the remote control

Installation error	Error code	Remedial action
The stop valve of an outdoor unit is left closed.	E3 E4 F3 UF	Check referring to the table in "1.2.5.5 Additional refrigerant charge" on page 72
The phases of the power to the outdoor units are reversed.	U1	Exchange two of the three phases (L1, L2, L3) to make a positive phase connection.
No power is supplied to an outdoor or indoor unit (including phase interruption).	U1 U4	Check if the power wiring for the outdoor units are connected correctly. (If the power wire is not connected to L2 phase, no malfunction display will appear and the compressor will not work.)
Incorrect interconnections between units	UF	Check if the refrigerant line piping and the unit wiring are consistent with each other.
Refrigerant overcharge	E3 F6 UF	Recalculate the required amount of refrigerant from the piping length and correct the refrigerant charge level by recovering any excessive refrigerant with a refrigerant recovery machine.
The wiring is connected to the Q1/Q2 (Out Multi)	U7 UF	Remove the wiring from the Q1/Q2 (Out Multi).
Insufficient refrigerant	E4 F3	Check if the additional refrigerant charge has been finished correctly. Recalculate the required amount of refrigerant from the piping length and add an adequate amount of refrigerant.

- After correcting the abnormality, press the button and reset the **BS3 RETURN** malfunction code.
- Carry out the test operation again and confirm that the abnormality is properly corrected.

1.2.7 Service Mode Operation

Vacuuming method

At the first installation, this vacuuming is not required. It is required only for repair purposes.

1. When the unit is at standstill and under the setting mode 2, set the required function B (refrigerant recovery operation / vacuuming operation) to **ON** (ON).
 - After this is set, do not reset the setting mode 2 until the vacuuming is finished.
 - The H1P LED is on and the remote control indicates **TEST** (test operation) and  (external control) and the operation will be prohibited.
2. Evacuate the system with a vacuum pump.
3. Press the **BS1 MODE** button and reset the setting mode 2.

Refrigerant recovery operation method

by a refrigerant reclaimer

1. When the unit is at standstill and under the setting mode 2, set the required function B (refrigerant recovery operation / vacuuming operation) to **ON** (ON).
 - The indoor unit and the outdoor unit expansion valves will fully open and some solenoid valves will be turned on.
 - The H1P LED is on and the remote control indicates **TEST** (test operation) and  (external control) and the operation will be prohibited.
2. Cut off the power supply to the indoor units and the outdoor unit with the circuit breaker. After the power supply to one side is cut off, cut off the power supply to the other side within 10 minutes.
Otherwise, the communication between the indoor and outdoor unit may become abnormal and the expansion valves will be completely closed again.
3. Recover the refrigerant by a refrigerant reclaimer. For details, see the operation manual delivered with the refrigerant reclaimer.

1.3 Operation when Power is Turned On

1.3.1 When Turning On Power First Time

The unit cannot be run for up to 12 minutes to automatically set the master power and address (indoor-outdoor address, etc.).

Status

Outdoor unit Test lamp H2P Blinks
Can also be set during operation described above.

Indoor unit If ON button is pushed during operation described above, the "UH" malfunction indicator blinks.
(Returns to normal when automatic setting is complete.)

1.3.2 When Turning On Power the Second Time and Subsequent

Tap the RESET button on the outdoor unit PC board. Operation becomes possible for about 2 minutes. If you do not push the RESET button, the unit cannot be run for up to 10 minutes to automatically set master power.

Status

Outdoor unit Test lamp H2P Blinks
Can also be set during operation described above.

Indoor unit If ON button is pushed during operation described above, the operation lamp lights but the compressor does not operate. (Returns to normal when automatic setting is complete.)

1.3.3 When an Indoor Unit or Outdoor Unit has been Added, or Indoor or Outdoor Unit PC Board has been Changed

Be sure to push and hold the RESET button for 5 seconds. If not, the addition cannot be recognized. In this case, the unit cannot be run for up to 12 minutes to automatically set the address (indoor-outdoor address, etc.)

Status

Outdoor unit Test lamp H2P ON
Can also be set during operation described above.

Indoor unit If ON button is pushed during operation described above, the "UH" or "U4" malfunction indicator blinks. (Returns to normal when automatic setting is complete.)

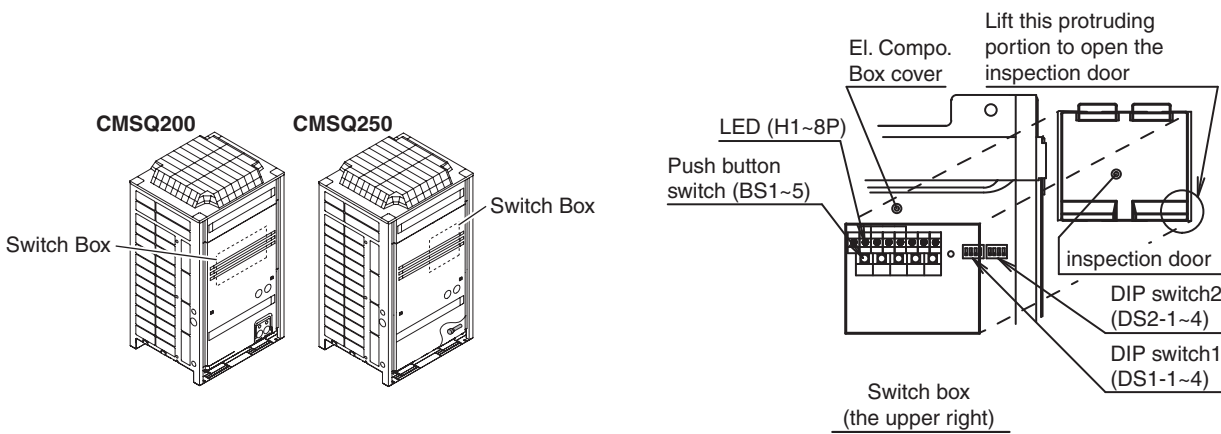

Caution When the 400 volt power supply is applied to "N" phase by mistake, replace Inverter PC board (A2P) and control transformer (T1R, T2R) in switch box together.

2. Outdoor Unit PC Board Layout

Outdoor unit PC board

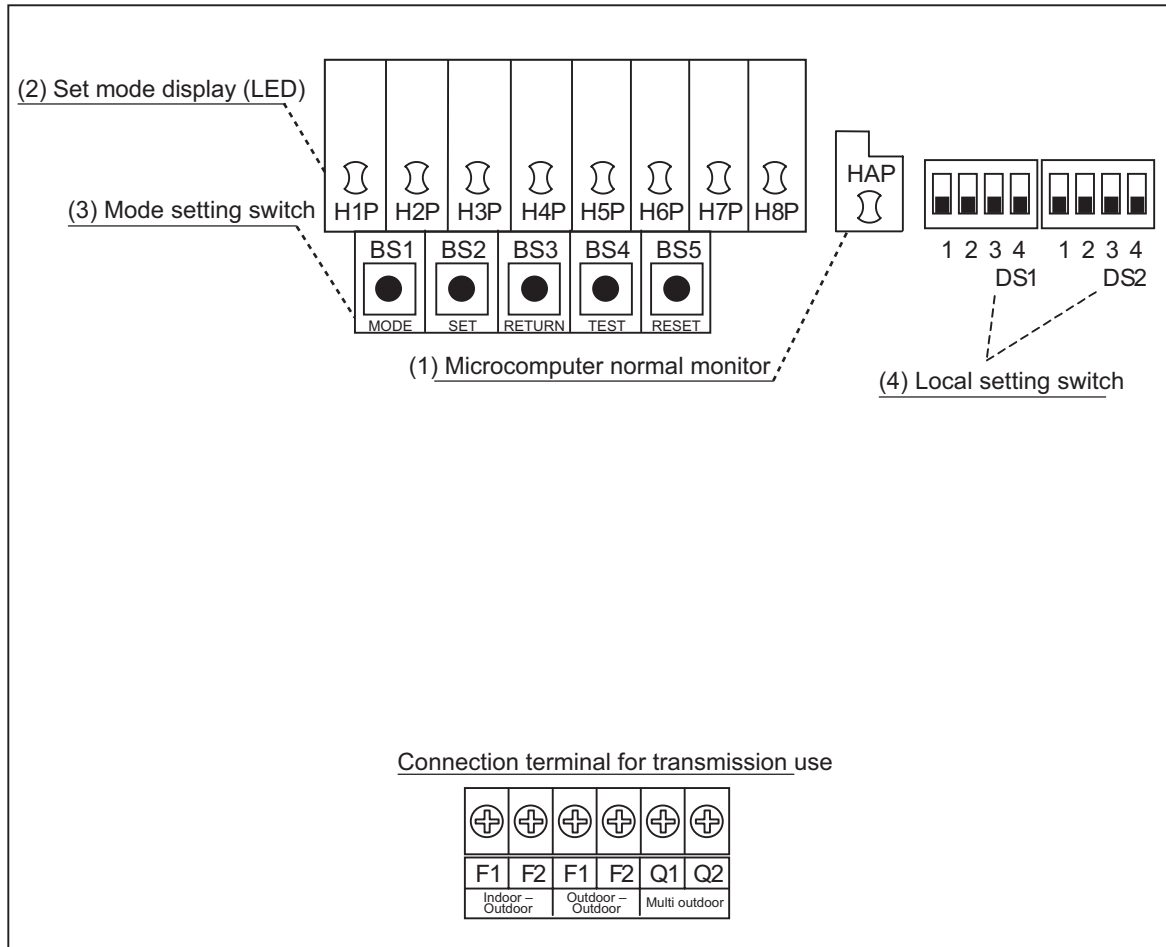

(1) Microcomputer normal monitor

This monitor blinks while in normal operation, and turns on or off when a malfunction occurs.

(2) Set mode display (LED)

LEDs display mode according to the setting.

(3) Mode setting switch

Used to change mode.

(4) Local setting switch

Used to make field settings.

3. Field Setting

3.1 Field Setting from remote control





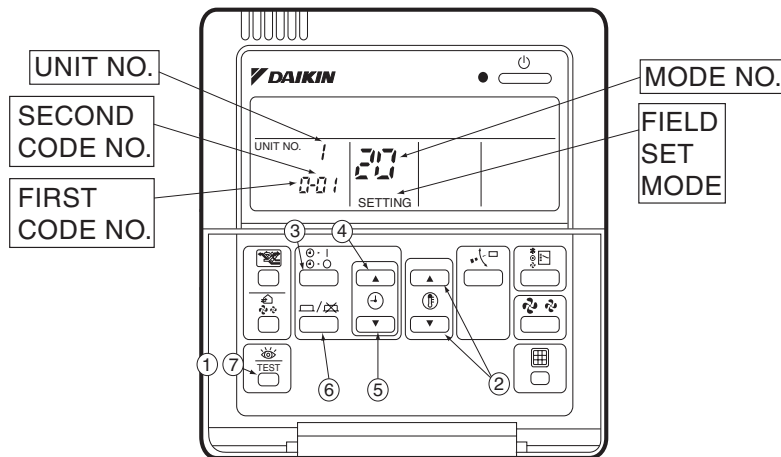

Individual function of indoor unit can be changed from the remote control. At the time of installation or after service inspection / repair, make the local setting in accordance with the following description.

Wrong setting may cause malfunction.

(When optional accessory is mounted on the indoor unit, setting for the indoor unit may be required to change. Refer to information in the option handbook.)

3.1.1 Wired remote control <BRC1C61, 62>



1. When in the normal mode, press the “” button for a minimum of four seconds, and the FIELD SET MODE is entered.
2. Select the desired MODE NO. with the “” button (②).
3. During group control, when setting by each indoor unit (mode No. 20, 22 and 23 have been selected), push the “” button (③) and select the INDOOR UNIT NO. to be set. (This operation is unnecessary when setting by group.)
4. Push the “” upper button (④) and select FIRST CODE NO.
5. Push the “” lower button (⑤) and select the SECOND CODE NO.
6. Push the “” button (⑥) once and the present settings are SET.
7. Push the “” button (⑦) to return to the NORMAL MODE.





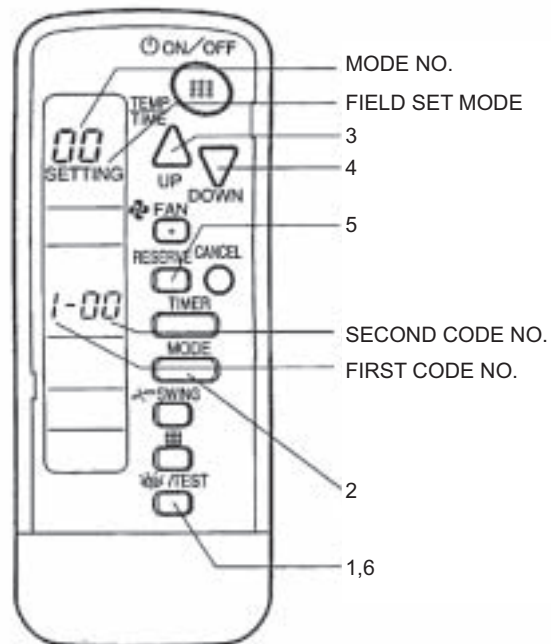

(Example)

If during group setting and the time to clean air filter is set to FILTER CONTAMINATION, HEAVY, SET MODE NO. to “10” FIRST CODE NO. to “0”, and SECOND CODE NO. to “02”.

3.1.2 infrared remote control - Indoor Unit

BRC7F type
BRC4C type



1. When in the normal mode, push the “ TEST ” button for 4 seconds or more, and operation then enters the “field set mode.”
2. Select the desired “mode No.” with the “ MODE ” button.
3. Pushing the “ UP ” button, select the first code No.
4. Pushing the “ DOWN ” button, select the second code No.
5. Push the timer “ RESERVE ” button and check the settings.
6. Push the “ TEST ” button to return to the normal mode.

(Example)

When setting the filter sign time to “Filter Dirtiness-High” in all group unit setting, set the Mode No. to “10”, Mode setting No. to “0” and setting position No. to “02”.

3.1.3 Simplified remote control

BRC2A51
BRC2C51

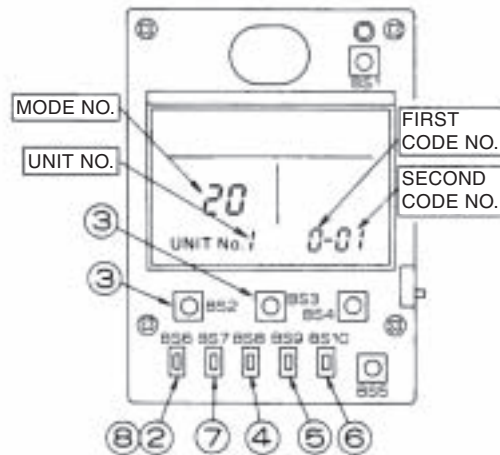

1. Remove the upper part of remote control.
2. When in the normal mode, press the [BS6] BUTTON (②) (field set), and the FIELD SET MODE is entered.
3. Select the desired MODE No. with the [BS2] BUTTON (③) (temperature setting ▲) and the [BS3] BUTTON (③) (temperature setting ▼).
4. During group control, when setting by each indoor unit (mode No. 20, 22, and 23 have been selected), push the [BS8] (④) BUTTON (unit No.) and select the INDOOR UNIT NO. to be set. (This operation is unnecessary when setting by group.)
5. Push the [BS9] BUTTON (⑤) (set A) and select FIRST CODE NO.
6. Push the [BS10] BUTTON (⑥) (set B) and select SECOND CODE NO.
7. Push the [BS7] BUTTON (⑦) (set/cancel) once and the present settings are SET.
8. Push the [BS6] BUTTON (⑧) (field set) to return to the NORMAL MODE.
9. (Example) If during group setting and the time to clean air filter is set to FILTER CONTAMINATION - HEAVY, SET MODE NO. to "10", FIRST CODE NO. to "0", and SECOND CODE NO. to "02".

3.1.4 Setting Contents and Code No. – Indoor unit

Mode No. Note 2	Setting Switch No.	Setting Contents	Second Code No.(Note 3)								Details No.
			01		02		03		04		
10 (20)	0	Filter contamination heavy/light (Setting for display time to clean air filter) (Sets display time to clean air filter to half when there is heavy filter contamination.)	Super long life filter	Light	Approx. 10,000 hrs.	Heavy	Approx. 5,000 hrs.	—	—	(1)	
			Long life filter		Approx. 2,500 hrs.		Approx. 1,250 hrs.				
			Standard filter		Approx. 200 hrs.		Approx. 100 hrs.				
	1	Long life filter type	Long life filter		Super long life filter		—		(2)		
	2	Thermostat sensor in remote control	Use		No use		—		(3)		
	3	Display time to clean air filter calculation (Set when filter sign is not to be displayed.)	Display		No display		—		(4)		
5	Information to i-Manager, i-Touch Controller	Only unit sensor value (or remote sensor value if installed).		Sensor value as set by 10-2-0X or 10-6-0X.		—		—			
6	Thermostat sensor in group control	Use unit sensor only (or remote sensor if installed). (See note 7)		Use both the unit sensor (or remote sensor if installed) AND the remote control sensor. (See note 4+5+6)		—		—			
Indoor unit settings 12 (22)	0	Optional accessories output selection (field selection of output for adapter for wiring)	Indoor unit turned ON by thermostat		—		Operation output		Malfunction output		(5)
	1	ON/OFF input from outside (Set when ON/OFF is to be controlled from outside.)	Forced OFF		ON/OFF control		External protection device input		—		(6)
	2	Thermostat differential changeover (Set when remote sensor is to be used.)	1°C		0.5°C		—		—		(7)
	3	OFF by thermostat fan speed	LL		Set fan speed		OFF (See note 8)		—		(8)
	4	Automatic mode differential (automatic temperature differential setting for system heat recovery series cool/heat)	01:0	02:1	03:2	04:3	05:4	06:5	07:6	08:7	(9)
	5	Power failure automatic reset	Not equipped		Equipped		—		—		(10)
	6	Airflow When Cooling Thermostat is OFF	LL airflow		Preset airflow		—		—		(11)
	9	Fixed cool/heat master	Disabled		Enabled		—		—		—
13 (23)	0	High air outlet velocity (Set when installed in place with ceiling higher than 2.7 m.)	N		H		S		—		(12)
	1	Selection of airflow direction (Set when a blocking pad kit has been installed.)	F (4 directions)		T (3 directions)		W (2 directions)		—		(13)
	4	Field set airflow position setting	Draft prevention		Standard		Ceiling Soiling prevention		—		(14)
	6	Setting the external static pressure (To be set in function of the connected duct resistance)	Normal		High static pressure		Low static pressure		—		(15)
15 (25)	1	Thermostat OFF excess humidity	Not equipped		Equipped		—		—		(16)
	2	Direct duct connection (when the indoor unit and heat reclaim ventilation unit are connected by duct directly.) *Note 6	Not equipped		Equipped		—		—		(17)
	3	Drain pump humidifier interlock selection	Not equipped		Equipped		—		—		(18)
	5	Field set selection for individual ventilation setting by remote control	Not equipped		Equipped		—		—		(19)



Notes :

- Settings are made simultaneously for the entire group, however, if you select the mode No. inside parentheses, you can also set by each individual unit. Setting changes however cannot be checked except in the individual mode for those in parentheses.
- The mode numbers inside parentheses cannot be used by infrared remote controls, so they cannot be set individually. Setting changes also cannot be checked.
- Marked are factory set.
- Do not make settings other than those described above. Nothing is displayed for functions the indoor unit is not equipped with.
- “88” may be displayed to indicate the remote control is resetting when returning to the normal mode.
- If the setting mode to “Equipped”, heat reclaim ventilation fan conducts the fan residual operation by linking to indoor unit.
- If setting 10-6-01 + 10-2-01 or 10-2-02 or 10-2-03 are set at the same time, then setting for group connection, 10-6-01 has priority and for individual connection, 10-2-01, 10-2-02 or 10-2-03 have priority.
- Only use in combination with optional remote sensor or when setting 10-2-03 is used.

3.1.5 Applicable Range of Field Setting

	Ceiling mounted cassette type		Ceiling mounted built-in type	Details No.
	Round flow			
	FMCQ	FMDQ		
Filter sign	○	○		(1)
Ultra long life filter sign	○	—		(2)
remote control thermostat sensor	○	○		(3)
Set fan speed when thermostat OFF	○	○		(8) (11)
Airflow adjustment Ceiling height	○	—		(12)
Airflow direction	○	—		(13)
Airflow direction adjustment range	○	—		(14)
Field set fan speed selection	○	—		(15)

3.1.6 Detailed Explanation of Setting Modes

(1) Filter Sign Setting

If switching the filter sign ON time, set as given in the table below.

Set Time

Setting	Filter Specs.	Standard	Long Life	Ultra Long Life Filter
Contamination Light		200 hrs.	2,500 hrs.	10,000 hrs.
Contamination Heavy		100 hrs.	1,250 hrs.	5,000 hrs.

(2) Ultra-Long-Life Filter Sign Setting

When a Ultra-long-life filter is installed, the filter sign timer setting must be changed.

Setting Table

Mode No.	Setting Switch No.	Setting Position No.	Setting
10 (20)	1	01	Long-Life Filter
		02	Ultra-Long-Life Filter (1)
		03	—

(3) Selection of Thermistor

Select the thermistor to control room temperature.

Mode No.	First Code No.	Second Code No.	Thermistor that controls room temperature
10 (20)	2	01	Indoor air thermistor for remote control and suction air thermistor for indoor unit
		02	Suction air thermistor for indoor unit
		03	Thermistor for remote control

The factory setting for the Second Code No. is "01" and room temperature is controlled by the indoor unit suction air thermistor and remote control thermistor.

When the Second Code No. is set to "02", room temperature is controlled by the suction air thermistor.

When the Second Code No. is set to "03", room temperature is controlled by the remote control thermistor.

(4) "Filter Cleaning" Displayed or Not Displayed

Whether or not to display "Filter Cleaning" after operation of certain duration can be selected.

Mode No.	First Code No.	Second Code No.	"Filter Cleaning" display
10 (20)	3	01	Display
		02	No display

(5) Optional Output Switching

Using this setting, "operation output signal" and "abnormal output signal" can be provided.

Output signal is output between terminals K1 and K2 of "customized wiring adapter," an optional accessory.

Mode No.	First Code No.	Second Code No.	Remarks
12 (22)	0	01	Indoor unit thermostat ON/OFF signal is provided.
		03	Output linked with "Start/Stop" of remote control is provided.
		04	In case of "Malfunction Display" appears on the remote control, output is provided.

(6) External ON/OFF Input

This input is used for "ON / OFF operation" and "Protection device input" from the outside. The input is performed from the T1-T1 terminal of the operation terminal block (X1A) in the electric component box.

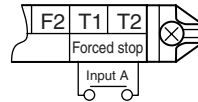

Setting Table

Mode No.	Setting Switch No.	Setting Position No.	Operation by input of the signal A
12 (22)	1	01	ON: Forced stop (prohibition of using the remote control) OFF: Permission of using the remote control
		02	OFF → ON: Permission of operation ON → OFF: Stop
		03	ON: Operation OFF: The system stops, then the applicable unit indicates "A0". The other indoor units indicate "U9".

(7) Thermostat Switching

Differential value during thermostat ON/OFF control can be changed. (For details, refer to "6.4 Thermostat Control while in Normal Operation" on page 58.)

Mode No.	First Code No.	Second Code No.	Differential value
12(22)	2	01	1°C
		02	0.5°C

(8) Airflow Setting when Heating Thermostat is OFF

This setting is used to set airflow when heating thermostat is OFF.

- * When thermostat OFF airflow volume up mode is used, careful consideration is required before deciding installation location. During heating operation, this setting takes precedence over "Fan Stop When Thermostat is OFF."

Mode No.	First Code No.	Second Code No.	Contents
12 (22)	3	01	LL airflow
		02	Preset airflow

(9) Setting of Operation Mode to "AUTO"

This setting makes it possible to change differential values for mode selection while in automatic operation mode.

Mode No.	Setting switch No.	Setting position No.							
		01	02	03	04	05	06	07	08
12 (22)	4	0°C	1°C	2°C	3°C	4°C	5°C	6°C	7°C

The automatic operation mode setting is made by the use of the "Operation Mode Selector" button.

(10) Auto Restart after Power Failure Reset

For the air conditioners with no setting for the function (same as factory setting), the units will be left in the stop condition when the power supply is reset automatically after power failure reset or the main power supply is turned on again after once turned off. However, for the air conditioners with the setting, the units may start automatically after power failure reset or the main power supply turned on again (return to the same operation condition as that of before power failure).

For the above reasons, when the unit is set enabling to utilize "Auto restart function after power failure reset", utmost care should be paid for the occurrence of the following situation.



- Caution**
- 1. The air conditioner starts operation suddenly after power failure reset or the main power supply turned on again. Consequently, the user might be surprised (with question for the reason why).**
 - 2. In the service work, for example, turning off the main power switch during the unit is in operation, and turning on the switch again after the work is completed start the unit operation (the fan rotates).**

(11) Airflow when Cooling Thermostat is OFF

This is used to set airflow to "LL airflow" when cooling thermostat is OFF.

Mode No.	First Code No.	Second Code No.	Contents
12 (22)	6	01	LL airflow
		02	Preset airflow

(12) Setting of Normal Airflow

Make the following setting according to the ceiling height. The setting position No. is set to "01" at the factory.

■ **In the Case of FMCQ50~71 (All round outlet)**

Mode No.	First code No.	Second code No.	Setting	Ceiling height (m)
13 (23)	0	01	Standard • All round outlet	≤2.7
		02	High Ceiling (1)	2.7-3
		03	Higher Ceiling (2)	3-3.5

■ **In the Case of FMCQ100~125 (All round outlet)**

Mode No.	First code No.	Second code No.	Setting	Ceiling height (m)
13 (23)	0	01	Standard • All round outlet	≤3.2
		02	High Ceiling (1)	3.2-3.6
		03	Higher Ceiling (2)	3.6-4.2

■ **In the Case of FMCQ50~71 (*24-Way, 3-Way, 2-Way Outlets)**

Mode No.	First code No.	Second code No.	Setting	Ceiling height		
				4-way Outlets	3-way Outlets	2-way Outlets
13 (23)	0	01	Standard (N)	Lower than 3.1 m	Lower than 3.0 m	Lower than 3.5 m
		02	High Ceiling (H)	Lower than 3.4 m	Lower than 3.3 m	Lower than 3.8 m
		03	Higher Ceiling (S)	Lower than 4.0 m	Lower than 3.5 m	—

■ In the Case of FMCQ100~125 (*24-Way, 3-Way, 2-Way Outlets)

Mode No.	First code No.	Second code No.	Setting	Ceiling height		
				4-way Outlets	3-way Outlets	2-way Outlets
13 (23)	0	01	Standard (N)	Lower than 3.4 m	Lower than 3.6 m	Lower than 4.2 m
		02	High Ceiling (H)	Lower than 3.9 m	Lower than 4.0 m	Lower than 4.2 m
		03	Higher Ceiling (S)	Lower than 4.5 m	Lower than 4.2 m	—

*1 "Mode No." setting is done in a batch for the group. To make or confirm settings for an individual unit, set the internal mode number in parentheses.

*2 The figure of the ceiling height is for the all round outlet. For the settings for four-direction (part of corner closed off), three-direction and two-direction outlets, see the installation manual and technical guide supplied with the separately sold closure material kit.

(13) Airflow Direction Setting

Set the airflow direction of indoor units as given in the table below. (Set when optional air outlet blocking pad has been installed.) The second code No. is factory set to "01."

Setting Table

Mode No.	First Code No.	Second Code No.	Setting
13 (23)	1	01	F : 4-direction airflow
		02	T : 3-direction airflow
		03	W : 2-direction airflow

(14) Setting of Airflow Direction Adjustment Range

Make the following airflow direction setting according to the respective purpose.

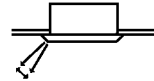

(S2537)

Setting Table

Mode No.	First Code No.	Second Code No.	Setting
13 (23)	4	01	Upward (Draft prevention)
		02	Standard
		03	Downward (Ceiling soiling prevention)

* Some indoor unit models are not equipped with draft prevention (upward) function.

(15) Setting of the Static Pressure Selection

Model No.	First Code No.	Second Code No.	External static pressure
13 (23)	6	01	Standard
		02	High static pressure
		03	Low static pressure

(16) Humidification when Heating Thermostat is OFF

Setting to "Humidification Setting" turns ON the humidifier if suction temperature is 20°C or above and turns OFF the humidifier if suction temperature is 18°C or below when the heating thermostat is OFF.

Mode No.	First Code No.	Second Code No.	Setting
15 (25)	1	01	—
		02	Setting of humidifier

(17) Setting of Direct Duct Connection

This is used when "fresh air intake kit equipped with fan" is connected. The indoor fan carries out residual operation for one minute after the thermostat is stopped. (For the purpose of preventing dust on the air filter from falling off.)

Mode No.	First Code No.	Second Code No.	Contents
15 (25)	2	01	Without direct duct connection
		02	With direct duct connection equipped with fan

(18) Interlocked Operation between Humidifier and Drain Pump

This is used to interlock the humidifier with the drain pump. When water is drained out of the unit, this setting is unnecessary.

Mode No.	First Code No.	Second Code No.	Contents
15 (25)	3	01	Individual operation of humidifier
		02	Interlocked operation between humidifier and drain pump

(19) Individual Setting of Ventilation

This is set to perform individual operation of heat reclaim ventilation using the remote control/central unit when heat reclaim ventilation is built in.

(Switch only when heat reclaim ventilation is built in.)







Mode No.	First Code No.	Second Code No.	Contents
15 (25)	5	01	—
		02	Individual operation of ventilation

3.1.7 Centralized Control Group No. Setting

BRC1C Type

In order to conduct the central remote control using the central remote control and the unified ON/OFF controller, Group No. settings should be made by group using the operating remote control.

Make Group No. settings for central remote control using the operating remote control.

1. Turn ON the power of the indoor unit and unified ON/OFF controller. (Unless the power is ON, no setting can be made.)
Check that the installation and electrical wiring are correct before turning the power supply ON.
When the power supply is turned ON, all LCD appear once and the unit may not accept the operation for about one minute with the display of "  " flashing (an interval of ON, ON, and OFF).
2. While in normal mode, press and hold the "  " switch for a period of four seconds or more to set the system to "Field Setting Mode".
3. Select the MODE No. "00" with the "  " button.
4. Use the "  " button to select the group No. for each group.
(Group numbers increase in the order of 1-00, 1-01, ... 1-15, 2-00, ... 4-15.)
5. Press "  " to set the selected group No.
6. Press "  " to return to the NORMAL MODE.

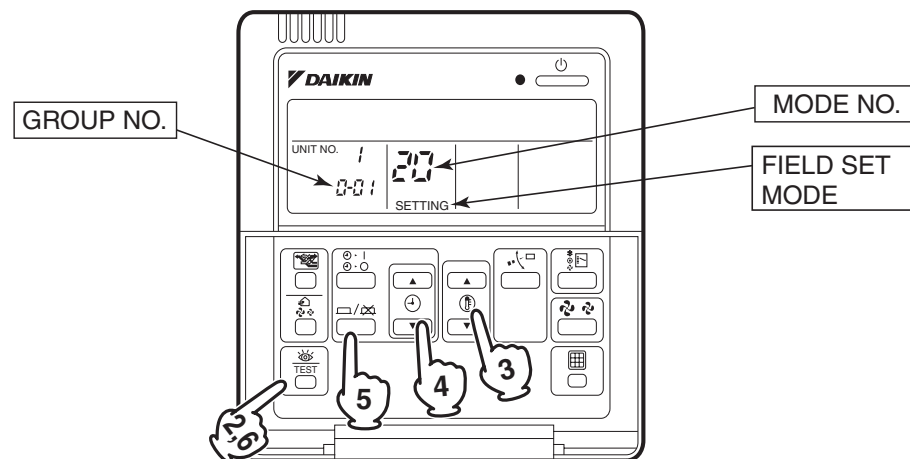







Note:

- For infrared remote control, see the following.
- For setting group No. of HRV and wiring adapter for other air conditioners, etc., refer to the instruction manual attached.

NOTICE

Enter the group No. and installation place of the indoor unit into the attached installation table. Be sure to keep the installation table with the operation manual for maintenance.

**BRC7F Type
BRC4C Type**

- Group No. setting by infrared remote control for centralized control
- 1. When in the normal mode, push “  ” button for 4 seconds or more, and operation then enters the “field set mode.”
- 2. Set mode No. “00” with “  ” button.
- 3. Set the group No. for each group with “  ” “  ” button (advance/backward).
- 4. Enter the selected group numbers by pushing “  ” button.
- 5. Push “  ” button and return to the normal mode.

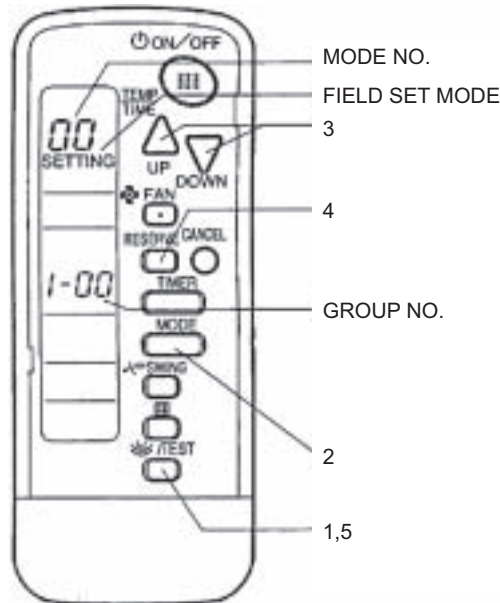

**Group No. Setting
Example**

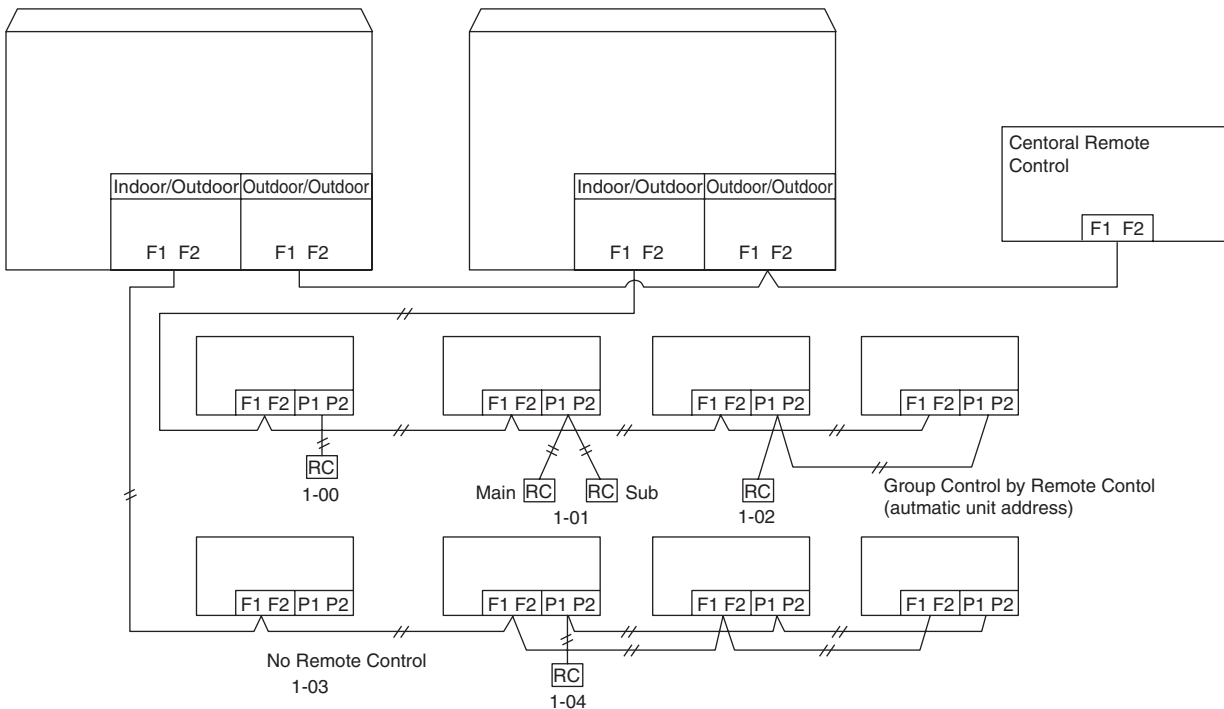

Caution When turning the power supply on, the unit may often not accept any operation while "88" is displaying after all indications were displayed once for about 1 minute on the liquid crystal display. This is not an operative fault.

3.1.8 Setting of Operation Control Mode from remote control (Local Setting)

The operation control mode is compatible with a variety of controls and operations by limiting the functions of the operation remote control. Furthermore, operations such as remote control ON/OFF can be limited in accordance with the combination conditions. (Refer to information in the next page.)

Central remote control is normally available for operations. (Except when centralized monitor is connected)

3.1.9 Contents of Control Modes

Twenty modes consisting of combinations of the following five operation modes with temperature and operation mode setting by remote control can be set and displayed by operation modes 0 through 19.

- ◆ ON/OFF control impossible by remote control
Used when you want to turn on/off by central remote control only.
(Cannot be turned on/off by remote control.)
- ◆ OFF control only possible by remote control
Used when you want to turn on by central remote control only, and off by remote control only.
- ◆ Centralized
Used when you want to turn on by central remote control only, and turn on/off freely by remote control during set time.
- ◆ Individual
Used when you want to turn on/off by both central remote control and remote control.
- ◆ Timer operation possible by remote control
Used when you want to turn on/off by remote control during set time and you do not want to start operation by central remote control when time of system start is programmed.

How to Select Operation Mode

Whether operation by remote control will be possible or not for turning on/off, controlling temperature or setting operation mode is selected and decided by the operation mode given on the right edge of the table below.

Example

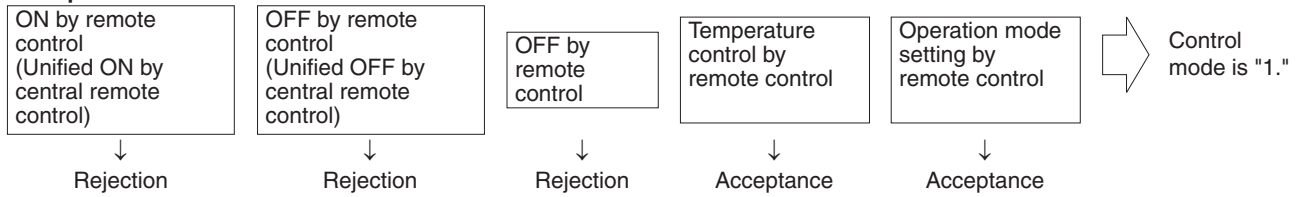

Control mode	Control by remote control					Control mode	
	Operation		OFF	Temperature control	Operation mode setting		
	Unified operation, individual operation by central remote control, or operation controlled by timer	Unified OFF, individual stop by central remote control, or timer stop					
ON/OFF control impossible by remote control	Rejection (Example)	Rejection (Example)	Rejection (Example)	Rejection	Acceptance	0	
OFF control only possible by remote control				Acceptance	Acceptance (Example)	Acceptance (Example)	1(Example)
	Rejection		Rejection		11		
Centralized	Acceptance		Acceptance	Acceptance	Rejection	Acceptance	2
					Rejection	Rejection	12
Individual	Acceptance		Acceptance	Acceptance	Acceptance	Acceptance	3
		Rejection			Rejection	13	
Timer operation possible by remote control	Acceptance (During timer at ON position only)	Acceptance (During timer at ON position only)	Acceptance	Rejection	Acceptance	4	
				Rejection	Rejection	14	
				Acceptance	Acceptance	5	
				Rejection	Rejection	15	
				Acceptance	Acceptance	6	
				Rejection	Rejection	16	
				Acceptance	Acceptance	7 *1	
				Rejection	Rejection	17	
				Acceptance	Acceptance	8	
				Rejection	Rejection	18	
				Acceptance	Acceptance	9	
				Rejection	Rejection	19	

Do not select "timer operation possible by remote control" if not using a remote control. Operation by timer is impossible in this case.

*1. Factory setting

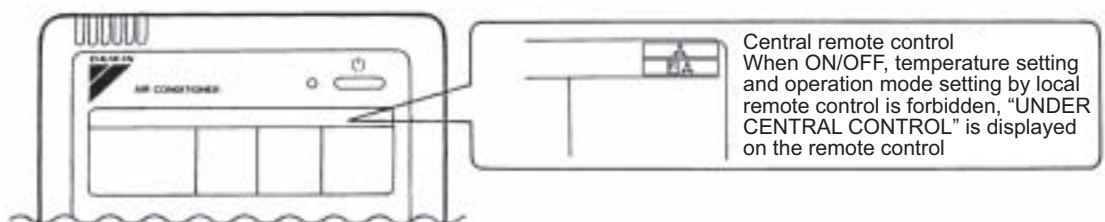

3.2 Field Setting from Outdoor Unit

3.2.1 Field Setting from Outdoor Unit

■ List of Field Setting Items

This following section indicates the list of field setting items. For the lists of dip switch contents, Setting mode 1, and Setting mode 2, refer to information in tables shown on the following page onward.

For setting items of (*1), refer to detailed information provided on page 108 onward.

Setting item		Content and objective of setting	Overview of setting procedure	
Function setting	1	Setting of COOL/HEAT selection (*1)	<ul style="list-style-type: none"> ■ COOL/HEAT selection methods are possible to select from the following <ol style="list-style-type: none"> (1) Control by each outdoor unit using the indoor unit remote control (2) Control by each outdoor unit using the COOL/HEAT selection remote control (3) Batch control by outdoor unit group using the indoor unit remote control (4) Batch control by outdoor unit group using the COOL/HEAT selection remote control 	<ul style="list-style-type: none"> ■ In order to use the COOL/HEAT selection remote control, set the DS1-1 on the outdoor unit PC board to OUT. ■ For outdoor unit group control, set the system to "BATCH MASTER" or "SLAVE" while in "Setting mode 1". Then, make setting of COOL/HEAT batch address.
	2	Setting of low noise operation (*1)	A. Use external input to step down the upper limit of the fan (factory set to Step 8), providing low noise level. <ol style="list-style-type: none"> (1) Mode 1: Step 6 or lower (2) Mode 2: Step 5 or lower (3) Mode 3: Step 4 or lower 	<ul style="list-style-type: none"> ■ Use the "External control adapter for outdoor unit". Set to "External control adapter for outdoor unit" with No. 12 of "Setting mode 2" and select the mode with No. 25. If necessary, set the "Capacity priority setting" to ON with No. 29.
			B. The low noise operation aforementioned is enabled in nighttime automatic low noise operation mode. Start time: Possible to select in the range of 20:00 to 24:00 hours. End time: Possible to select in the range of 06:00 to 08:00 hours. (Use the said time as a guide since the start time and the end time are estimated according to outdoor temperatures.)	<ul style="list-style-type: none"> ■ Make this setting while in "Setting mode 2". Select a mode with No. 22 of "Setting mode 2". Select the start time with No. 26 and the end time with No. 27. If necessary, set the "Capacity priority setting" to ON with No. 29.
	3	Setting of demand operation (*1)	<ul style="list-style-type: none"> ■ Used to place limits on the compressor operating frequency to control the upper limit of power consumption. <ol style="list-style-type: none"> (1) Mode 1 of Demand 1: 60% or less of rating (2) Mode 2 of Demand 1: 70% or less of rating (3) Mode 3 of Demand 1: 80% or less of rating (4) Demand 2: 40% or less of rating 	<ul style="list-style-type: none"> ■ For setting with the use of "external control adapter": Set the system to "External control adapter for outdoor unit" with No. 12 of Setting mode 2" and select the mode with No. 30. ■ For setting only in "Setting mode 2": Set the system to Normal demand mode with No. 32 of "Setting mode 2" and select the mode with No. 30.
	4	Setting of AirNet address	<ul style="list-style-type: none"> ■ Used to make address setting with AirNet connected. 	<ul style="list-style-type: none"> ■ Set the AirNet to an intended address using binary numbers with No. 13 of "Setting mode 2".
	5	Setting of hot water heater	<ul style="list-style-type: none"> ■ Make this setting to conduct heating operation using the hot water heater. 	<ul style="list-style-type: none"> ■ Set No. 16 of "Setting mode 2" to ON.
6	Setting of high static pressure	<ul style="list-style-type: none"> ■ Make this setting to operate a system with diffuser duct while in high static pressure mode. (Use this setting mode when shields are installed on upper floors or balconies.) <p>* In order to mount the diffuser duct, remove the cover from the outdoor unit fan.</p>	<ul style="list-style-type: none"> ■ Set No. 18 of "Setting mode 2" to ON. 	

Setting item		Content and objective of setting	Overview of setting procedure	
Service setting	1	Indoor unit fan forced H operation	<ul style="list-style-type: none"> Used to operate the indoor unit in the stopped state in forced H operation mode. 	<ul style="list-style-type: none"> Set No. 5 of "Setting mode 2" to indoor unit forced fan H.
	2	Indoor unit forced operation	<ul style="list-style-type: none"> Used to operate the indoor unit in forced operation mode. 	<ul style="list-style-type: none"> Set No. 6 of "Setting mode 2" to indoor unit forced operation mode.
	3	Change of targeted evaporating temperature (in cooling)	<ul style="list-style-type: none"> In cooling operation, used to change the targeted evaporating temperature for compressor capacity control. 	<ul style="list-style-type: none"> Select high side or low side with No. 8 of "Setting mode 2".
	4	Change of targeted condensing temperature (in heating)	<ul style="list-style-type: none"> In heating operation, used to change the targeted condensing temperature for compressor capacity control. 	<ul style="list-style-type: none"> Select high side or low side with No. 9 of "Setting mode 2".
	5	Setting of defrost selection	<ul style="list-style-type: none"> Used to change a temperature at which the defrost operation is initiated, thus making the initiation easy or hard. 	<ul style="list-style-type: none"> Select fast side or slow side with No. 10 of "Setting mode 2".
	6	Setting of sequential startup	<ul style="list-style-type: none"> Used to start units not in sequence but simultaneously. 	<ul style="list-style-type: none"> Set No. 11 of "Setting mode 2" to NONE.
	7	Emergency operation (*1)	<ul style="list-style-type: none"> If the compressor has a failure, used to prohibit the operation of compressor(s) concerned or outdoor unit(s) concerned and to conduct emergency operation of the system only with operable compressor(s) or outdoor unit(s). 	<ul style="list-style-type: none"> Make this setting while in "Setting mode 2". For system with a single outdoor unit: Set with No. 19 or 42. For system with multiple outdoor units: Set with No. 38, 39, or 40.
	8	Additional refrigerant charging (*1)	<ul style="list-style-type: none"> If a necessary amount of refrigerant cannot be charged due to the stop of outdoor unit, operate the outdoor unit and then refill refrigerant. 	<ul style="list-style-type: none"> Set No. 20 of "Setting mode 2" to ON and then charge refrigerant.
	9	Refrigerant recovery mode (*1)	<ul style="list-style-type: none"> Used to recover refrigerant on site. With operations of indoor and outdoor units prohibited, fully open the expansion valve of the indoor and outdoor units. 	<ul style="list-style-type: none"> Set No. 21 of "Setting mode 2" to ON.
	10	Vacuumping mode (*1)	<ul style="list-style-type: none"> Used to conduct vacuuming on site. Fully open the expansion valves of the indoor and outdoor units, and energize part of solenoid valves. Use a vacuum pump to conduct vacuuming. 	<ul style="list-style-type: none"> Set No. 21 of "Setting mode 2" to ON.
	11	ENECUT test operation	<ul style="list-style-type: none"> Used to forcedly turn ON the ENECUT. (Be noted this mode is not functional with the indoor unit remote control turned ON.) 	<ul style="list-style-type: none"> Set No. 24 of "Setting mode 2" to ON.
	12	Power transistor check mode	<ul style="list-style-type: none"> Used for the troubleshooting of DC compressors. Inverter waveform output makes it possible to judge whether a malfunction results from the compressor or the PC board. 	<ul style="list-style-type: none"> Set No. 28 of "Setting mode 2" to ON.
	13	Setting of model with spare PC board	<ul style="list-style-type: none"> In order to replace the PC board by a spare one, be sure to make model setting. 	<ul style="list-style-type: none"> For this setting, set the DS2-2, -3, and-4 switches on the PC board to the model concerned.

For setting items of (*1), refer to detailed information provided on page 108 onward.

■ **Setting by dip switches**

Using dip switches on the PC board enables field setting shown below. However, make no changes of factory settings except for DS1-1.

Dip switch		Setting item	Description
No.	Setting		
DS1-1	ON	Cool / Heat select	Used to set cool / heat select by Cool/Heat selector equipped with outdoor unit.
	OFF (Factory set)		
DS1-2 ~DS1-4	ON	Not used	Do not change the factory settings.
	OFF (Factory set)		
DS2-1 ~4	ON	Not used	Do not change the factory settings.
	OFF (Factory set)		

Setting at replacement by spare PC board



Caution

DIP switch Setting after changing the main PC board(A1P) to spare parts PC board

After the replacement by the spare PC board, be sure to make settings shown below. When you change the main PC board(A1P) to spare parts PC board, please carry out the following setting.



DIP Switch Detail



DS No.	Item	Contents													
DS1-1	Cool/Heat change over setting	ON	COOL/HEAT setting is made with the use of a Cool/Heat selector mounted to the outdoor unit.												
		OFF (Factory setting of spare PC board)	COOL/HEAT setting is not made with the use of a Cool/Heat selector mounted to the outdoor unit.												
DS1-2	Power supply specification	ON	200V class (220V)												
		OFF (Factory setting of spare PC board)	400V class (380V)												
DS1-3	Cooling only/Heat-pump setting	ON	Cooling only setting												
		OFF (Factory setting of spare PC board)	Heat Pump setting												
DS1-4	Unit allocation setting	ON	Make the following settings according to allocation of unit. (All models are set to OFF at factory.)												
DS2-1		OFF (Factory setting of spare PC board)													
			<table border="1"> <thead> <tr> <th></th> <th>Domestic Japan</th> <th>Overseas General</th> <th>Europe</th> </tr> </thead> <tbody> <tr> <td>DS1-4</td> <td>OFF</td> <td>OFF</td> <td>ON</td> </tr> <tr> <td>DS2-1</td> <td>OFF</td> <td>ON</td> <td>OFF</td> </tr> </tbody> </table>		Domestic Japan	Overseas General	Europe	DS1-4	OFF	OFF	ON	DS2-1	OFF	ON	OFF
	Domestic Japan	Overseas General	Europe												
DS1-4	OFF	OFF	ON												
DS2-1	OFF	ON	OFF												
DS2-2	Model setting	Make the following settings according to models of outdoor units. (All models are set to OFF at factory.)													
DS2-3		<table border="1"> <thead> <tr> <th></th> <th>CMSQ200A7</th> <th>CMSQ250A7</th> </tr> </thead> <tbody> <tr> <td>DS2-2</td> <td>OFF</td> <td>OFF</td> </tr> <tr> <td>DS2-3</td> <td>OFF</td> <td>ON</td> </tr> <tr> <td>DS2-4</td> <td>OFF</td> <td>OFF</td> </tr> </tbody> </table>			CMSQ200A7	CMSQ250A7	DS2-2	OFF	OFF	DS2-3	OFF	ON	DS2-4	OFF	OFF
		CMSQ200A7	CMSQ250A7												
DS2-2	OFF	OFF													
DS2-3	OFF	ON													
DS2-4	OFF	OFF													
DS2-4															

* If the DS1-1~1-4, DS2-2~2-4 setting has not been carried out, error code "UA" are displayed and unit can not be operated.



Refer "DS1-1~4, DS2-1~4 setting detail" on next page.

“Detail of DS1-1~4, DS2-1~4 setting” (for Overseas general)

Unit	Setting method (■ represents the position of switches)	
Heat Pump CMSQ200A7		Set DS2-1 to ON.
Heat Pump CMSQ250A7		Set DS2-1 and DS2-3 to ON.

■ **Setting by push button switches**

The following settings are made by pushbutton switches on PC board.

LED display

	MODE H1P	TEST H2P	COOL/HEAT select			Low noise H6P	Demand H7P	Multi; H8P
			IND H3P	MASTER H4P	SLAVE H5P			
Single-outdoor-unit system	●	●	○	●	●	●	●	●

(Factory setting)

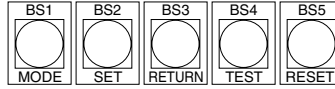

There are the following three setting modes.

① **Setting mode 1 (H1P off)**

Initial status (when normal): Used to select the cool/heat setting. Also indicates during “abnormal”, “low noise control” and “demand control”.

② **Setting mode 2 (H1P on)**

Used to modify the operating status and to set program addresses, etc. Usually used in servicing the system.

③ **Monitor mode (H1P blinks)**

Used to check the program made in Setting mode 2.

■ **Mode changing procedure 1**

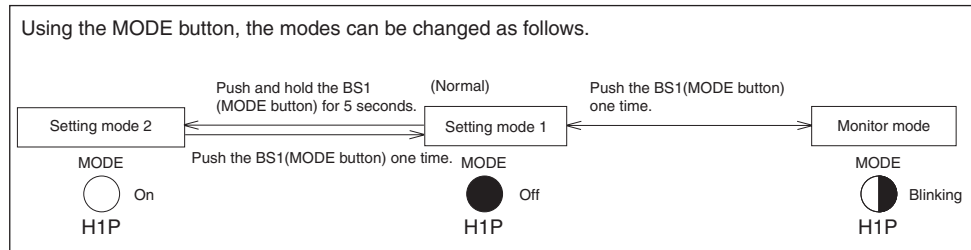

■ **Mode changing procedure 2**

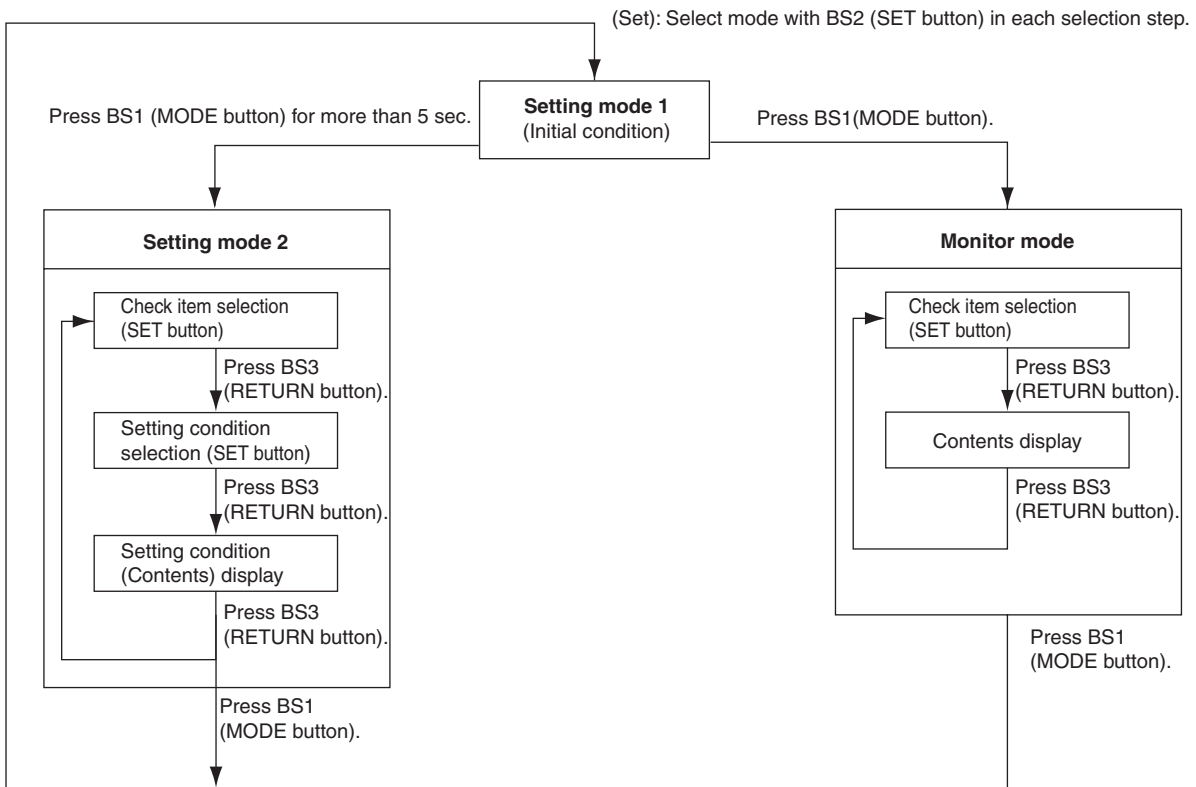

a. "Setting mode 1"

This mode is used to set and check the following items.

1. Set items In order to make COOL/HEAT selection in a batch of outdoor unit group, change the setting.
 - COOL/HEAT selection (IND) Used to select COOL or HEAT by individual outdoor unit (factory set).
2. Check items The following items can be checked.
 - (1) Current operating conditions (Normal / Abnormal / In check operation)
 - (2) Setting conditions of COOL/HEAT selection (Individual / Batch master / Batch slave)
 - (3) Low noise operating conditions (In normal operation / In low noise operation)
 - (4) Demand operating conditions (In normal operation / In demand operation)

Procedure for changing COOL/HEAT selection setting

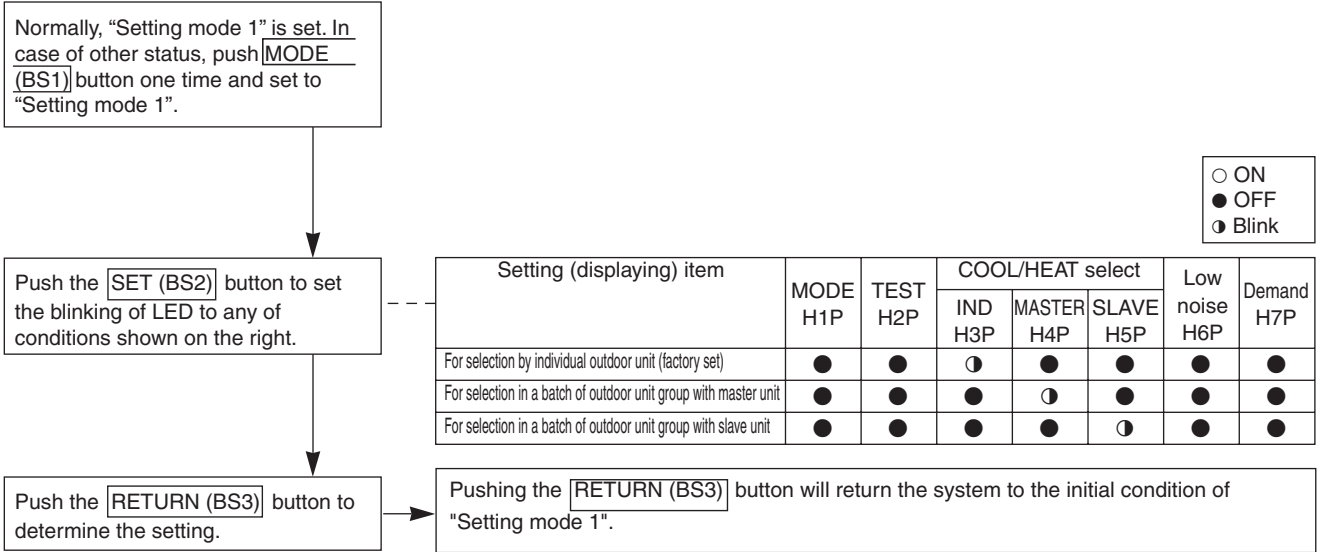

Procedure for checking check items

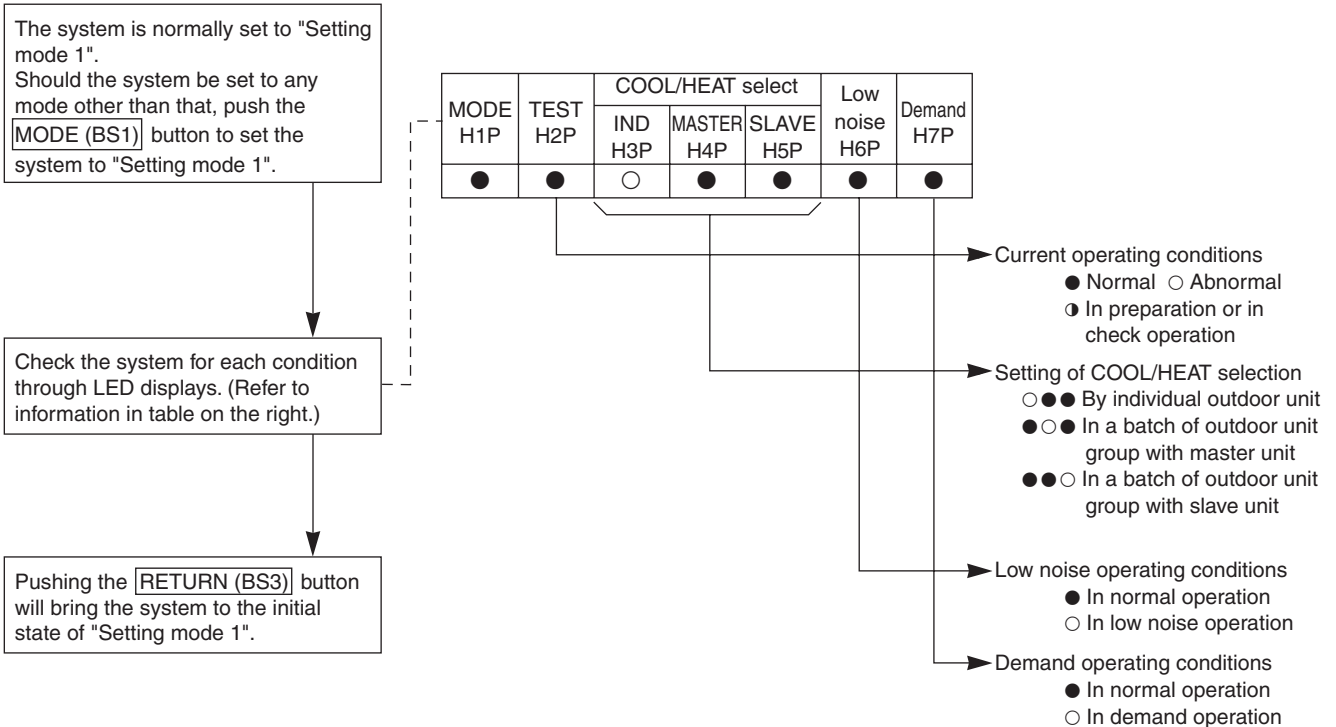

b. "Setting mode 2"

Push and hold the **MODE (BS1)** button for 5 seconds and set to "Setting mode 2".

<Selection of setting items>

Push the **SET (BS2)** button and set the LED display to a setting item shown in the table on the right.

↓
Push the **RETURN (BS3)** button and decide the item. (The present setting condition is blinked.)

<Selection of setting conditions>

Push the **SET (BS2)** button and set to the setting condition you want.

↓
Push the **RETURN (BS3)** button and decide the condition.

Push the **RETURN (BS3)** button and set to the initial status of "Setting mode 2".

* If you become unsure of how to proceed, push the **MODE (BS1)** button and return to setting mode 1.

No.	Setting item	Description
0	Digital pressure gauge kit display	Used to make setting of contents to display on the digital pressure gauges (e.g. pressure sensors and temperature sensors)
1	Cool/heat unified address	Sets address for cool/heat unified operation.
2	Low noise/demand address	Address for low noise/demand operation
3	Test operation settings	Used to conduct test operation without making changes to the PC board and replacing the refrigerant, after the completion of maintenance.
5	Indoor unit forced fan H	Allows forced operation of indoor unit fan while unit is stopped. (H tap)
6	Indoor unit forced operation	Allows forced operation of indoor unit.
8	Te setting	Target evaporation temperature for cooling
9	Tc setting	Target condensation temperature for heating
10	Defrost changeover setting	Changes the temperature condition for defrost and sets to quick defrost or slow defrost.
11	Sequential operation setting	Sets sequential operation (Factory set to ON)
12	External low noise setting / Demand setting	Reception of external low noise or demand signal
13	AIRNET address	Set address for AIRNET.
16	Setting of hot water	Make this setting to conduct heating operation with hot water heater.
18	High static pressure setting	Make this setting in the case of operating in high static pressure mode with diffuser duct mounted. (In order to mount the diffuser duct, remove the cover from the outdoor unit fan.)
19	Emergency operation (STD compressor operation prohibited)	Used to operate system only with inverter compressor when STD compressor malfunctions. This is a temporary operation extremely impairing comfortable environment. Therefore, prompt replacement of the compressor is required. (This operation, however, is not set with CMSQ.)
20	Additional refrigerant charge operation setting	Carries out additional refrigerant charge operation.
21	Refrigerant recovery/vacuumping mode setting	Sets to refrigerant recovery or vacuumping mode.
22	Night-time low noise setting	Sets automatic nighttime low noise operation in a simple way. The operating time is based on "Starting set" and "Ending set".
24	ENECUT test operation	Used to forcibly turn ON the ENECUT. (Be noted that the ENECUT is only functional with outdoor unit in the stopped state - Japanese domestic model only.)
25	Setting of external low noise level	Sets low noise level when the low noise signal is input from outside.
26	Night-time low noise operation start setting	Sets starting time of nighttime low noise operation. (Night-time low noise setting is also required.)
27	Night-time low noise operation end setting	Sets ending time of nighttime low noise operation. (Night-time low noise setting is also required.)
28	Power transistor check mode *Check after disconnection of compressor wires	Used for trouble diagnosis of DC compressor. Since the waveform of inverter is output without wiring to the compressor, it is convenient to probe whether the trouble comes from the compressor or PC board.
29	Capacity precedence setting	If the capacity control is required, the low noise control is automatically released by this setting during carrying out low noise operation and nighttime low noise operation.
30	Demand setting 1	Changes target value of power consumption when demand control 1 is input.
32	Normal demand setting	Normally enables demand control 1 without external input. (Effective to prevent a problem that circuit breaker of small capacity is shut down due to large load.)

No.	Setting item	Description
35	Setting of difference in elevation for the outdoor unit	Make the setting when the outdoor unit is installed 40 m or more below the indoor unit.

No.	Setting item display								Setting condition display			
	Setting item	MODE H1P	TEST H2P	C/H selection			Low noise H6P	Demand H7P				
				IND H3P	Master H4P	Slave H5P						
0	Digital pressure gauge kit display	○	●	●	●	●	●	●	●	Address	0	○ ● ● ● ● ● ● ● *
										Binary number	1	○ ● ● ● ● ● ● ○
										(4 digits)	~	
1	Cool / Heat Unified address	○	●	●	●	●	●	●	○	Address	0	○ ● ● ● ● ● ● ● *
										Binary number	1	○ ● ● ● ● ● ● ○
										(6 digits)	~	
2	Low noise/demand address	○	●	●	●	●	○	●	●	Address	0	○ ● ● ● ● ● ● ● *
										Binary number	1	○ ● ● ● ● ● ● ○
										(6 digits)	~	
3	Test operation	○	●	●	●	●	○	○	○	Test operation: OFF	○ ● ● ● ● ● ● ○ *	
										Test operation: ON	○ ● ● ● ● ● ● ●	
5	Indoor forced fan H	○	●	●	●	○	●	○	○	Normal operation	○ ● ● ● ● ● ● ○ *	
										Indoor forced fan H	○ ● ● ● ● ● ● ●	
6	Indoor forced operation	○	●	●	●	○	○	○	●	Normal operation	○ ● ● ● ● ● ● ○ *	
										Indoor forced operation	○ ● ● ● ● ● ● ●	
8	Te setting	○	●	●	○	●	●	●	●	Low (Level L)	○ ● ● ● ● ● ● ○	
										Normal (Level M)	○ ● ● ● ● ● ● ● *	
										High ^① High ^② High ^③ High ^④ High ^⑤ } (Level H)	○ ● ● ● ● ● ● ○	
											○ ● ● ● ● ● ● ○	
											○ ● ● ● ● ● ● ○	
											○ ● ● ● ● ● ● ○	
9	Tc setting	○	●	●	○	●	●	○	○	Low	○ ● ● ● ● ● ● ○	
										Normal (factory setting)	○ ● ● ● ● ● ● ○ *	
										High	○ ● ● ● ● ● ● ●	
10	Defrost changeover setting	○	●	●	○	●	○	●	●	Slow defrost	○ ● ● ● ● ● ● ○	
										Normal (factory setting)	○ ● ● ● ● ● ● ○ *	
										Quick defrost	○ ● ● ● ● ● ● ●	
11	Sequential operation setting	○	●	●	○	●	○	○	○	OFF	○ ● ● ● ● ● ● ○ *	
										ON	○ ● ● ● ● ● ● ●	
12	External low noise/demand setting	○	●	●	○	○	●	●	●	External low noise/demand: NO	○ ● ● ● ● ● ● ○ *	
										External low noise/demand: YES	○ ● ● ● ● ● ● ●	
13	Airnet address	○	●	●	○	○	●	○	○	Address	0	○ ● ● ● ● ● ● ● *
										Binary number	1	○ ● ● ● ● ● ● ○
										(6 digits)	~	
16	Setting of hot water heater	○	●	○	●	●	●	●	●	OFF	○ ● ● ● ● ● ● ○ *	
										ON	○ ● ● ● ● ● ● ●	
18	High static pressure setting	○	●	○	●	●	○	●	●	High static pressure setting: OFF	○ ● ● ● ● ● ● ○ *	
										High static pressure setting: ON	○ ● ● ● ● ● ● ●	
19	Emergency operation (STD compressor is inhibited to operate.)	○	●	○	●	●	○	○	○	OFF	○ ● ● ● ● ● ● ● *	
										STD 1, 2 operation: Inhibited	○ ● ● ● ● ● ● ○	
										STD 2 operation: Inhibited	○ ● ● ● ● ● ● ●	
20	Additional refrigerant charging operation setting	○	●	○	●	○	●	●	●	Refrigerant charging: OFF	○ ● ● ● ● ● ● ○ *	
										Refrigerant charging: ON	○ ● ● ● ● ● ● ●	
21	Refrigerant recovery/vacuuming mode setting	○	●	○	●	○	●	○	○	Refrigerant recovery / vacuuming: OFF	○ ● ● ● ● ● ● ○ *	
										Refrigerant recovery / vacuuming: ON	○ ● ● ● ● ● ● ●	

No.	Setting item display								Setting condition display * Factory set
	Setting item	MODE H1P	TEST H2P	C/H selection			Low noise H6P	Demand H7P	
				IND H3P	Master H4P	Slave H5P			
22	Night-time low noise setting	<input type="radio"/>	<input checked="" type="radio"/>	<input type="radio"/>	<input checked="" type="radio"/>	<input type="radio"/>	<input type="radio"/>	<input checked="" type="radio"/>	OFF <input type="radio"/> ● ● ● ● ● ● ● ● * Level 1 (outdoor fan with 6 step or lower) <input type="radio"/> ● ● ● ● ● ● ● ● Level 2 (outdoor fan with 5 step or lower) <input type="radio"/> ● ● ● ● ● ● ● ● Level 3 (outdoor fan with 4 step or lower) <input type="radio"/> ● ● ● ● ● ● ● ●
24	ENECUT test operation (Domestic Japan only)	<input type="radio"/>	<input checked="" type="radio"/>	<input type="radio"/>	<input type="radio"/>	<input checked="" type="radio"/>	<input checked="" type="radio"/>	<input checked="" type="radio"/>	ENECUT output OFF <input type="radio"/> ● ● ● ● ● ● ● ● * ENECUT output forced ON <input type="radio"/> ● ● ● ● ● ● ● ●
25	Low noise setting	<input type="radio"/>	<input checked="" type="radio"/>	<input type="radio"/>	<input type="radio"/>	<input checked="" type="radio"/>	<input checked="" type="radio"/>	<input type="radio"/>	Level 1 (outdoor fan with 6 step or lower) <input type="radio"/> ● ● ● ● ● ● ● ● Level 2 (outdoor fan with 5 step or lower) <input type="radio"/> ● ● ● ● ● ● ● ● * Level 3 (outdoor fan with 4 step or lower) <input type="radio"/> ● ● ● ● ● ● ● ●
26	Night-time low noise operation start setting	<input type="radio"/>	<input checked="" type="radio"/>	<input type="radio"/>	<input type="radio"/>	<input checked="" type="radio"/>	<input type="radio"/>	<input checked="" type="radio"/>	About 20:00 <input type="radio"/> ● ● ● ● ● ● ● ● About 22:00 (factory setting) <input type="radio"/> ● ● ● ● ● ● ● ● * About 24:00 <input type="radio"/> ● ● ● ● ● ● ● ●
27	Night-time low noise operation end setting	<input type="radio"/>	<input checked="" type="radio"/>	<input type="radio"/>	<input type="radio"/>	<input checked="" type="radio"/>	<input type="radio"/>	<input type="radio"/>	About 6:00 <input type="radio"/> ● ● ● ● ● ● ● ● About 7:00 <input type="radio"/> ● ● ● ● ● ● ● ● About 8:00 (factory setting) <input type="radio"/> ● ● ● ● ● ● ● ● *
28	Power transistor check mode	<input type="radio"/>	<input checked="" type="radio"/>	<input type="radio"/>	<input type="radio"/>	<input type="radio"/>	<input checked="" type="radio"/>	<input checked="" type="radio"/>	OFF <input type="radio"/> ● ● ● ● ● ● ● ● * ON <input type="radio"/> ● ● ● ● ● ● ● ●
29	Capacity precedence setting	<input type="radio"/>	<input checked="" type="radio"/>	<input type="radio"/>	<input type="radio"/>	<input type="radio"/>	<input checked="" type="radio"/>	<input type="radio"/>	OFF <input type="radio"/> ● ● ● ● ● ● ● ● * ON <input type="radio"/> ● ● ● ● ● ● ● ●
30	Demand setting 1	<input type="radio"/>	<input checked="" type="radio"/>	<input type="radio"/>	<input type="radio"/>	<input type="radio"/>	<input type="radio"/>	<input checked="" type="radio"/>	60 % demand <input type="radio"/> ● ● ● ● ● ● ● ● 70 % demand <input type="radio"/> ● ● ● ● ● ● ● ● * 80 % demand <input type="radio"/> ● ● ● ● ● ● ● ●
32	Normal demand setting	<input type="radio"/>	<input type="radio"/>	<input checked="" type="radio"/>	<input checked="" type="radio"/>	<input checked="" type="radio"/>	<input checked="" type="radio"/>	<input checked="" type="radio"/>	OFF <input type="radio"/> ● ● ● ● ● ● ● ● * ON <input type="radio"/> ● ● ● ● ● ● ● ●
35	Setting of difference in elevation for the outdoor unit	<input type="radio"/>	<input type="radio"/>	<input checked="" type="radio"/>	<input checked="" type="radio"/>	<input checked="" type="radio"/>	<input type="radio"/>	<input type="radio"/>	Normal <input type="radio"/> ● ● ● ● ● ● ● ● 65 m or less <input type="radio"/> ● ● ● ● ● ● ● ● 90 m or less <input type="radio"/> ● ● ● ● ● ● ● ●

c. Monitor mode

To enter the monitor mode, push the **MODE (BS1)** button when in "Setting mode 1".

<Selection of setting item>

Push the **SET (BS2)** button and set the LED display to a setting item.

<Confirmation on setting contents>

Push the **RETURN (BS3)** button to display different data of set items.

Push the **RETURN (BS3)** button and switches to the initial status of "Monitor mode".

* Push the **MODE (BS1)** button and returns to "Setting mode 1".

No.	Setting item	LED display							Data display
		H1P	H2P	H3P	H4P	H5P	H6P	H7P	
0	Various settings	●	●	●	●	●	●	●	Lower 4 digits
1	C/H unified address	●	●	●	●	●	●	○	Lower 6 digits
2	Low noise/demand address	●	●	●	●	●	○	●	
3	Not used	●	●	●	●	●	○	○	
4	Airnet address	●	●	●	●	○	●	●	
5	Number of connected indoor units *1	●	●	●	●	○	●	○	
6	Number of connected BS units *2	●	●	●	●	○	○	●	
7	Number of connected zone units (Fixed to "0")	●	●	●	●	○	○	○	Lower 4 digits: upper
8	Number of outdoor units *3	●	●	●	○	●	●	●	
9	Number of BS units *4	●	●	●	○	●	●	○	
10	Number of BS units *4	●	●	●	○	●	○	●	Lower 4 digits: lower
11	Number of zone units	●	●	●	○	●	○	○	Lower 6 digits
14	Contents of malfunction (the latest)	●	●	●	○	○	○	●	Malfunction code table Refer page 134.
15	Contents of malfunction (1 cycle before)	●	●	●	○	○	○	○	
16	Contents of malfunction (2 cycle before)	●	●	○	●	●	●	●	
20	Contents of retry (the latest)	●	●	○	●	○	●	●	
21	Contents of retry (1 cycle before)	●	●	○	●	○	●	○	
22	Contents of retry (2 cycle before)	●	●	○	●	○	○	●	Lower 6 digits
25	Number of multi connection outdoor units	●	●	○	○	●	●	○	

The numbers in the "No." column represent the number of times to press the SET (BS2) button.

- *1: Number of connected indoor units
Used to make setting of the number of indoor units connected to an outdoor unit.
- *2: Number of connected BS units
Used to make setting of the number of BS units connected to an outdoor unit.
- *3: Number of outdoor units
Used to make setting of the number of outdoor units connected to DIII-NET that is one of the communication lines.
- *4: Number of BS units
Used to make setting of the number of BS units connected to DIII-NET that is one of the communication lines.

Setting item 0 Display contents of “Number of units for various settings”

EMG operation / backup operation setting	ON	●	●	●	○	●	●	●
	OFF	●	●	●	●	●	●	●
Defrost select setting	Short	●	●	●	●	○	●	●
	Medium	●	●	●	●	●	○	●
	Long	●	●	●	●	●	●	●
Te setting	L	●	●	●	●	●	●	●
	M	●	●	●	●	●	○	●
	H ①~⑤	●	●	●	●	●	○	●
Tc setting	L	●	●	●	●	●	●	●
	M	●	●	●	●	●	●	○
	H	●	●	●	●	●	●	○

★ Data such as addresses and number of units is expressed as binary numbers; the two ways of expressing are as follows:

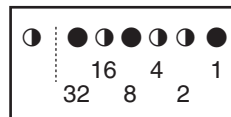

The No. 1 cool/heat unified address is expressed as a binary number consisting of the lower 6 digits. (0 - 63)

In ① the address is 010110 (binary number), which translates to $16 + 4 + 2 = 22$ (base 10 number). In other words, the address is 22.

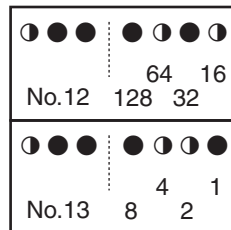

The number of terminal blocks for No. 12 and 13 is expressed as an 8-digit binary number, which is the combination of four upper, and four lower digits for No. 12 and 13 respectively. (0 - 128)

In ② the address for No. 12 is 0101, the address for No. 13 is 0110, and the combination of the two is 01010110 (binary number), which translates to $64 + 16 + 4 + 2 = 86$ (base 10 number). In other words, the number of terminal block is 86.

★ See the preceding page for a list of data, etc. for No. 0 - 25.

3.2.2 Cool / Heat Mode Switching

There are the following 4 cool/heat switching modes.

- ① Set cool/heat separately for each outdoor unit system by indoor unit remote control.
- ② Set cool/heat separately for each outdoor unit system by cool/heat selector.
- ③ Set cool/heat for more than one outdoor unit system simultaneously in accordance with unified master outdoor unit by indoor unit remote control.
- ④ Set cool/heat for more than one outdoor unit system simultaneously in accordance with unified master outdoor unit by cool/heat switching remote control.

① Set Cool / Heat Separately for Each Outdoor Unit System by Indoor Unit Remote Control

- ◆ It does not matter whether or not there is outdoor - outdoor unit wiring.
- ◆ Set outdoor unit PC board DS1-1 to IN (factory set).
- ◆ Set cool/heat switching to IND (individual) for "Setting mode 1" (factory set).
- ◆ Set the master unit (= indoor unit having the right to select the cooling/heating operation mode).

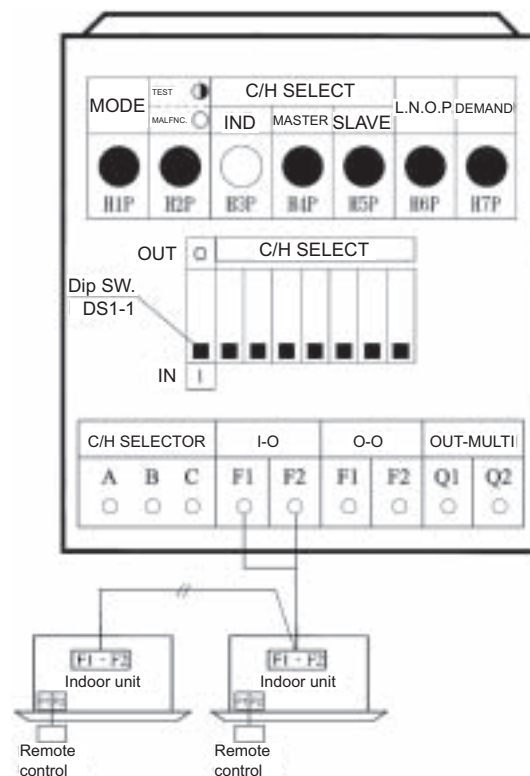

<Set the master unit (= indoor unit having the right to select the cooling/heating operation mode).>

In the case of wired remote controls

- After the check operation, "CHANGEOVER UNDER CONTROL" is flashing in all connected remote controls.
- Select an indoor unit to be used as the master unit in accordance with the request from the customer. (It is recommended to select an indoor unit which will be used most often as the master unit.)
- Press the operation mode selector button in the remote control of the indoor unit selected as the master unit.
- In that remote control, "CHANGEOVER UNDER CONTROL" disappears. That remote control will control changeover of the cooling/heating operation mode.
- In other remote controls, "CHANGEOVER UNDER CONTROL" lights.

For the details, refer to the installation manual supplied together with the indoor unit.

In the case of infrared remote controls

- After the check operation, the timer lamp is flashing in all connected indoor units.
- Select an indoor unit to be used as the master unit in accordance with the request from the customer. (It is recommended to select an indoor unit which will be used most often as the master unit.)
- Press the operation selector mode button in the remote control of the indoor unit selected as the master unit. A "peep" sound is emitted, and the timer lamp turns off in all indoor units.
- That indoor unit will control changeover of the cooling/heating operation mode.

② **Set Cool / Heat Separately for Each Outdoor Unit System by Cool / Heat Selector**

- ◆ It does not matter whether or not there is outdoor - outdoor unit wiring.
- ◆ Set outdoor unit PC board DS1-1 to OUT (factory set).
- ◆ Set cool/heat switching to IND (individual) for "Setting mode 1" (factory set).

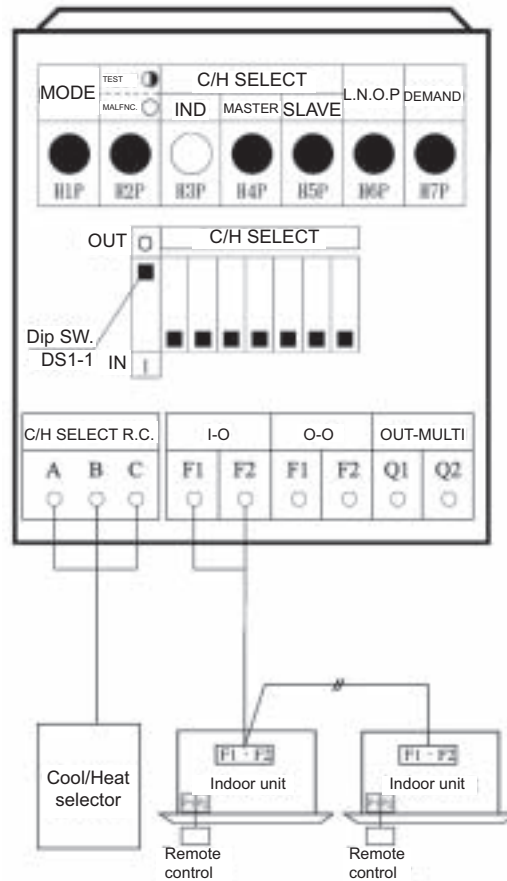

3.2.3 Setting of Low Noise Operation and Demand Operation

Setting of Low Noise Operation

By connecting the external contact input to the low noise input of the outdoor unit external control adapter (optional), you can lower operating noise by 2-3 dB.

Setting	Content
Mode 1	Set the outdoor unit fan to Step 6 or lower.
Mode 2	Set the outdoor unit fan to Step 5 or lower.
Mode 3	Set the outdoor unit fan to Step 4 or lower.

A. When the low noise operation is carried out by external instructions (with the use of the external control adapter for outdoor unit)

1. While in "Setting mode 2", set the setting condition for set item No. 12 (Setting of external low noise/demand operation) to "YES".
2. If necessary, while in "Setting mode 2", select the setting condition (i.e., "Mode 1", "Mode 2", or "Mode 3") for set item No. 25 (Setting of external low noise level).
3. If necessary, while in "Setting mode 2", set the setting condition for the set item No. 29 (Setting of capacity precedence) to "ON".
(If the condition is set to "ON", when the air-conditioning load reaches a high level, the low noise operation command will be ignored to put the system into normal operation mode.)

B. When the low noise operation is carried out automatically at night (The external control adapter for outdoor unit is not required)

1. While in "Setting mode 2", select the setting condition (i.e., "Mode 1", "Mode 2", or "Mode 3") for set item No. 22 (Setting of nighttime low noise level).
2. If necessary, while in "Setting mode 2", select the setting condition (i.e., "20:00", "22:00", or "24:00") for set item No. 26 (Setting of start time of nighttime low noise operation).
(Use the start time as a guide since it is estimated according to outdoor temperatures.)
3. If necessary, while in "Setting mode 2", select the setting condition (i.e., "06:00", "07:00", or "08:00") for set item No. 27 (Setting of end time of nighttime low noise operation).
(Use the end time as a guide since it is estimated according to outdoor temperatures.)
4. If necessary, while in "Setting mode 2", set the setting condition for set item No. 29 (Setting of capacity precedence) to "ON".
(If the condition is set to "ON", when the air-conditioning load reaches a high level, the system will be put into normal operation mode even during nighttime.)

Image of operation in the case of A

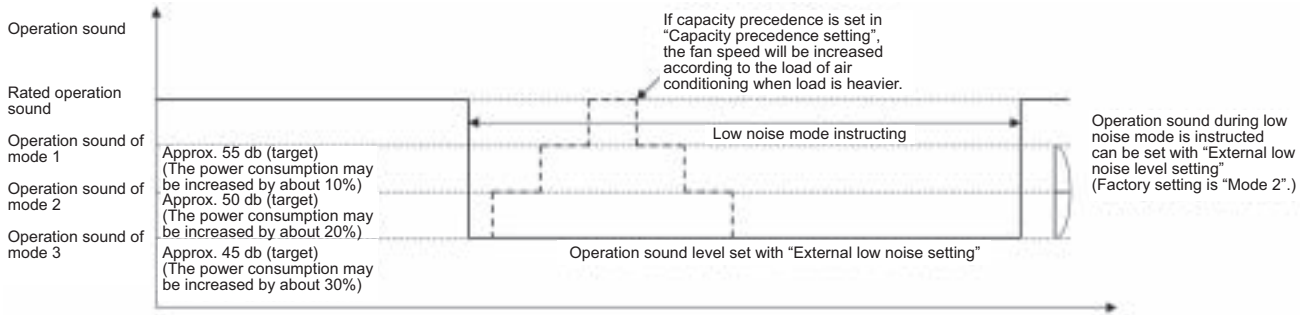

Image of operation in the case of B

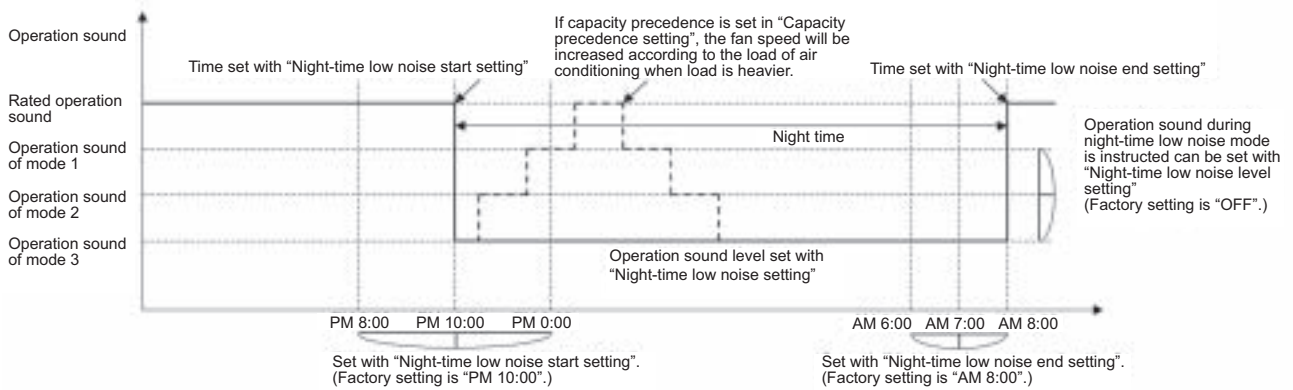
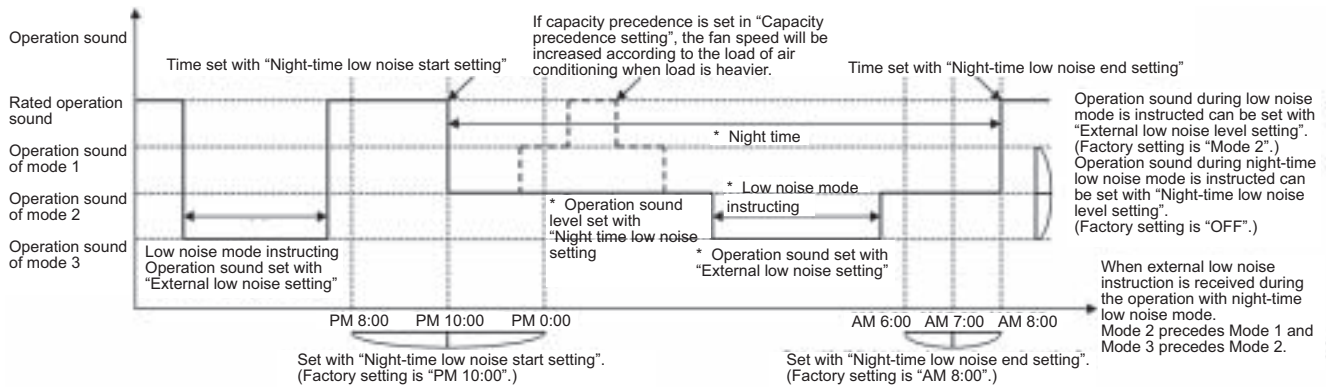

Image of operation in the case of A and B



Setting of Demand Operation

By connecting the external contact input to the demand input of the outdoor unit external control adapter (optional), the power consumption of unit operation can be saved suppressing the compressor operating condition.

Set item	Condition	Content
Demand 1	Mode 1	The compressor operates at approx. 60% or less of rating.
	Mode 2	The compressor operates at approx. 70% or less of rating.
	Mode 3	The compressor operates at approx. 80% or less of rating.
Demand 2	—	The compressor operates at approx. 40% or less of rating.

A. When the demand operation is carried out by external instructions (with the use of the external control adapter for outdoor unit).

1. While in "Setting mode 2", set the setting condition for set item No. 12 (Setting of external low noise/demand operation) to "YES".
2. If necessary, while in "Setting mode 2", select the set item No. 30 (Setting of Demand 1 level) and then set the setting condition to targeted mode.

B. When the normal demand operation is carried out. (Use of the external control adapter for outdoor unit is not required.)

1. While in "Setting mode 2", make setting of the set item No. 32 (Setting of constant demand) to "ON".
2. While in "Setting mode 2", select the set item No. 30 (Setting of Demand 1 level) and then set the setting condition to targeted mode.

Image of operation in the case of A

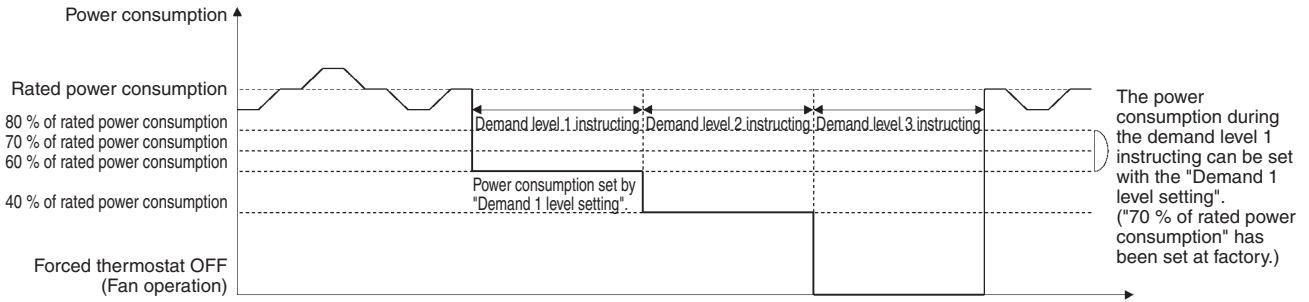

Image of operation in the case of B

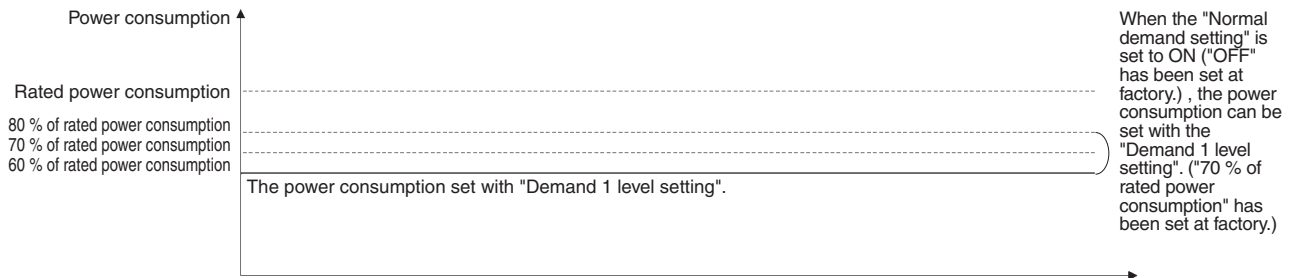
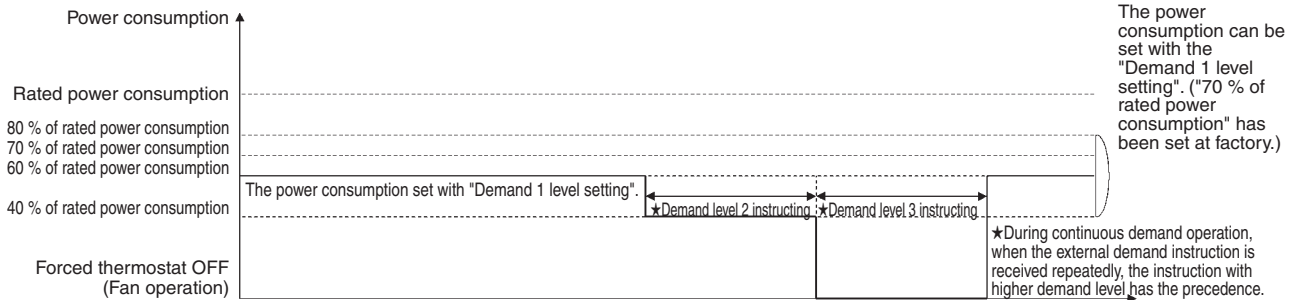

Image of operation in the case of A and B



Detailed Setting Procedure of Low Noise Operation and Demand Control

1. Setting mode 1 (H1P off)

- ① In setting mode 2, push the BS1 (MODE button) one time. → Setting mode 1 is entered and H1P lights off.
During the setting mode 1 is displayed, "In low noise operation" and "In demand control" are displayed.

2. Setting mode 2 (H1P on)

- ① In setting 1, push and hold the BS1 (MODE button) for more than 5 seconds. → Setting mode 2 is entered and H1P lights.
- ② Push the BS2 (SET button) several times and match the LED display with the Setting No. you want.
- ③ Push the BS3 (RETURN button) one time, and the present setting content is displayed.
→ Push the BS2 (SET button) several times and match the LED display with the setting content (as shown below) you want.
- ④ Push the BS3 (RETURN button) two times. → Returns to ①.
- ⑤ Push the BS1 (MODE button) one time. → Returns to the setting mode 1 and turns H1P off.

○: ON ●: OFF ◐: Blink

Setting No.	Setting contents	①							②							Setting contents	③							
		Setting No. indication							Setting No. indication								Setting contents indication (Initial setting)							
		H1P	H2P	H3P	H4P	H5P	H6P	H7P	H1P	H2P	H3P	H4P	H5P	H6P	H7P		H1P	H2P	H3P	H4P	H5P	H6P	H7P	
12	External low noise / Demand setting	○	●	●	●	●	●	●	○	●	●	○	○	●	●	NO (Factory setting)	○	●	●	●	●	●	●	◐
									○	●	●	○	○	●	●	YES	○	●	●	●	●	●	◐	●
22	Night-time low noise setting								○	●	○	●	○	○	●	OFF (Factory setting)	○	●	●	●	●	●	●	●
									○	●	●	●	●	●	●	Mode 1	○	●	●	●	●	●	●	◐
									○	●	●	●	●	●	●	Mode 2	○	●	●	●	●	●	◐	●
									○	●	●	●	●	●	●	Mode 3	○	●	●	●	●	●	◐	◐
25	External low noise setting								○	●	○	○	●	●	○	Mode 1	○	●	●	●	●	●	●	◐
									○	●	●	●	●	●	●	Mode 2 (Factory setting)	○	●	●	●	●	●	◐	●
									○	●	●	●	●	●	●	Mode 3	○	●	●	●	●	◐	●	●
26	Night-time low noise start setting								○	●	○	○	●	○	●	PM 8:00	○	●	●	●	●	●	●	◐
									○	●	●	●	●	●	●	PM 10:00 (Factory setting)	○	●	●	●	●	●	◐	●
									○	●	●	●	●	●	●	PM 0:00	○	●	●	●	●	◐	●	●
27	Night-time low noise end setting								○	●	○	○	●	○	○	AM 6:00	○	●	●	●	●	●	●	◐
									○	●	●	●	●	●	●	AM 7:00	○	●	●	●	●	●	◐	●
									○	●	●	●	●	●	●	AM 8:00 (Factory setting)	○	●	●	●	●	◐	●	●
29	Capacity precedence setting								○	●	○	○	○	●	○	Low noise precedence (Factory setting)	○	●	●	●	●	●	●	◐
									○	●	●	●	●	●	●	Capacity precedence	○	●	●	●	●	●	◐	●
30	Demand setting 1								○	●	○	○	○	○	●	60 % of rated power consumption	○	●	●	●	●	●	●	◐
									○	●	●	●	●	●	●	70 % of rated power consumption (Factory setting)	○	●	●	●	●	●	◐	●
									○	●	●	●	●	●	●	80 % of rated power consumption	○	●	●	●	●	◐	●	●
32	Normal demand setting								○	●	●	●	●	●	●	OFF (Factory setting)	○	●	●	●	●	●	●	◐
									○	●	●	●	●	●	●	ON	○	●	●	●	●	●	◐	●

Setting mode indication section

Setting No. indication section

Set contents indication section

3.2.4 Setting of Refrigerant Recovery Mode

When carrying out the refrigerant collection on site, fully open the respective expansion valve of indoor and outdoor units.

All indoor and outdoor unit's operation are prohibited.

[Operation procedure]

① In **setting mode 2** with units in stop mode, set "Refrigerant Recovery / Vacuuming mode" to ON. The respective expansion valve of indoor and outdoor units are fully opened. (H2P turns to display "TEST OPERATION" (blinks), "TEST OPERATION" and "UNDER CENTRALIZED CONTROL" are displayed on the remote control, and the all indoor / outdoor unit operation is prohibited.

After setting, do not cancel "Setting Mode 2" until completion of refrigerant recovery operation.

② Collect the refrigerant using a refrigerant recovery unit. (See the instruction attached to the refrigerant recovery unit for more detail.)

③ Press Mode button "BS1" once and reset "Setting Mode 2".

3.2.5 Setting of Vacuuming Mode

In order to perform vacuuming operation at site, fully open the expansion valves of indoor and outdoor units and turn on some solenoid valves.

[Operating procedure]

- ① With **Setting Mode 2** while the unit stops, set "Refrigerant recovery / Vacuuming mode" to ON. The expansion valves of indoor and outdoor units fully open and some of solenoid valves open.
(H2P blinks to indicate the test operation, and the remote control displays "Test Operation" and "Under centralized control", thus prohibiting operation.)
After setting, do not cancel "Setting Mode 2" until completion of Vacuuming operation.
- ② Use the vacuum pump to perform vacuuming operation.
- ③ Press Mode button "BS1" once and reset "Setting Mode 2".

3.2.6 Check Operation Detail

CHECK OPERATION FUNCTION

(Press the MODE button BS1 once and set to SETTING MODE 1 (H1P: OFF))

LED display (H1P~H7P) (○ :ON ● :OFF ◐ :BLINK)

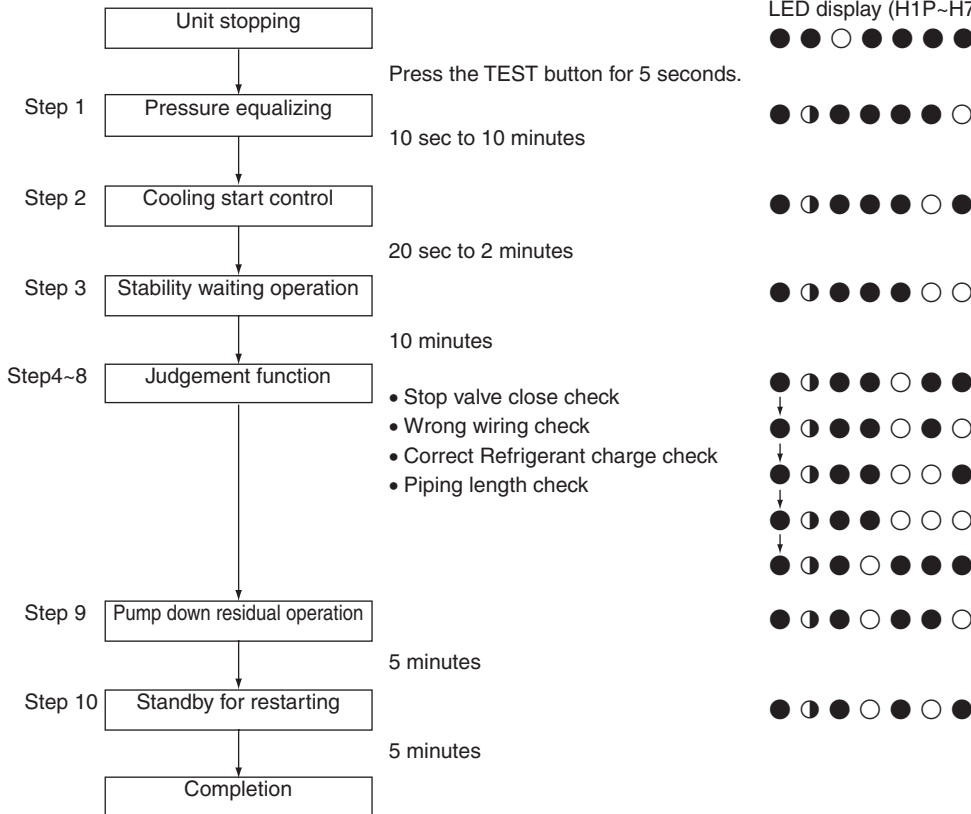

Part 6

Troubleshooting

1. Symptom-based Troubleshooting	121
2. Troubleshooting by remote control.....	124
2.1 The INSPECTION / TEST Button.....	124
2.2 Self-diagnosis by Wired remote control.....	125
2.3 Self-diagnosis by infrared remote control.....	126
2.4 remote control Service Mode	129
2.5 remote control Self-Diagnosis Function	131
3. Troubleshooting by Indication on the remote control	138
3.1 "R0" Indoor Unit: Error of External Protection Device	138
3.2 "R1" Indoor Unit: PC Board Defect.....	139
3.3 "R3" Indoor Unit: Malfunction of Drain Level Control System (S1L)	140
3.4 "R5" Indoor Unit: Fan Motor (M1F) Lock, Overload.....	142
3.5 "R9" Indoor Unit: Malfunction of Moving Part of Electronic Expansion Valve (Y1E).....	143
3.6 "RF" Indoor Unit: Drain Level above Limit.....	145
3.7 "RJ" Indoor Unit: Malfunction of Capacity Determination Device	146
3.8 "CY" Indoor Unit: Malfunction of Thermistor (R2T) for Heat Exchanger.....	147
3.9 "CS" Indoor Unit: Malfunction of Thermistor (R3T) for Gas Pipes.....	148
3.10 "CG" Indoor Unit: Malfunction of Thermistor (R1T) for Suction Air.....	149
3.11 "CL" Indoor Unit: Malfunction of Humidity Sensor System.....	150
3.12 "CU" Indoor Unit: Malfunction of Thermostat Sensor in remote control.....	151
3.13 "E1" Outdoor Unit: PC Board Defect	152
3.14 "E3" Outdoor Unit: Actuation of High Pressure Switch	153
3.15 "E4" Outdoor Unit: Actuation of Low Pressure Sensor	155
3.16 "E5" Outdoor Unit: Inverter Compressor Motor Lock.....	157
3.17 "E7" Outdoor Unit: Malfunction of Outdoor Unit Fan Motor	159
3.18 "E9" Outdoor Unit: Malfunction of Moving Part of Electronic Expansion Valve (Y1E, Y2E).....	162
3.19 "F3" Outdoor Unit: Abnormal Discharge Pipe Temperature	164
3.20 "F5" Outdoor Unit: Refrigerant Overcharged.....	165
3.21 "H7" Outdoor Unit: Abnormal Outdoor Fan Motor Signal.....	166
3.22 "H9" Outdoor Unit: Malfunction of Thermistor (R1T) for Outdoor Air.....	167
3.23 "J3" Outdoor Unit: Malfunction of Discharge Pipe Thermistor (R3T)	168
3.24 "J5" Outdoor Unit: Malfunction of Thermistor (R2T, R7T) for Suction Pipe	169
3.25 "J5" Outdoor Unit: Malfunction of Thermistor (R4T) for Outdoor Unit Heat Exchanger	170
3.26 "J7" Outdoor Unit: Malfunction of Liquid Pipe Thermistor (R6T).....	171
3.27 "J9" Outdoor Unit: Malfunction of Subcooling Heat Exchanger Gas Pipe Thermistor (R5T)	172
3.28 "JA" Outdoor Unit: Malfunction of High Pressure Sensor.....	173
3.29 "JC" Outdoor Unit: Malfunction of Low Pressure Sensor.....	174

3.30	“L4” Outdoor Unit: Malfunction of Inverter Radiating Fin Temperature Rise	175
3.31	“L5” Outdoor Unit: Inverter Compressor Abnormal	177
3.32	“L8” Outdoor Unit: Inverter Current Abnormal.....	179
3.33	“L9” Outdoor Unit: Inverter Start Up Error	181
3.34	“LC” Outdoor Unit: Malfunction of Transmission Between Inverter and Control PC Board	183
3.35	“P1” Outdoor Unit: Inverter Over-Ripple Protection	186
3.36	“P4” Outdoor Unit: Malfunction of Inverter Radiating Fin Temperature Rise Sensor	187
3.37	“PU” Outdoor Unit: Faulty Field Setting after Replacing Main PC Board or Faulty Combination of PC Board	189
3.38	“U0” Outdoor Unit: Low Pressure Drop Due to Refrigerant Shortage or Electronic Expansion Valve Failure.....	190
3.39	“U1” Reverse Phase, Open Phase.....	191
3.40	“U2” Outdoor Unit: Power Supply Insufficient or Instantaneous Failure	192
3.41	“U3” Outdoor Unit: Check Operation not Executed	195
3.42	“U4” Malfunction of Transmission Between Indoor Units	196
3.43	“U5” Indoor Unit: Malfunction of Transmission Between remote control and Indoor Unit.....	198
3.44	“U7” Indoor Unit: Malfunction of Transmission Between Outdoor Units	199
3.45	“U8” Indoor Unit: Malfunction of Transmission Between Main and Sub remote controls	201
3.46	“U9” Indoor Unit: Malfunction of Transmission Between Indoor and Outdoor Units in the Same System.....	202
3.47	“UR” Improper Combination of Indoor and Outdoor Units, Indoor Units and remote control	203
3.48	“UL” Address Duplication of Centralized Controller	205
3.49	“UE” Malfunction of Transmission Between Centralized Controller and Indoor Unit	206
3.50	“UF” System is not Set yet.....	209
3.51	“UH” Malfunction of System, Refrigerant System Address Undefined...	210
4.	Troubleshooting (OP: Central remote control)	212
4.1	“M1” PC Board Defect	212
4.2	“M8” Malfunction of Transmission Between Optional Controllers for Centralized Control.....	213
4.3	“MR” Improper Combination of Optional Controllers for Centralized Control.....	215
4.4	“ML” Address Duplication, Improper Setting	217
5.	Troubleshooting (OP: Unified ON/OFF Controller)	220
5.1	Operation Lamp Blinks	220
5.2	Display “Under Centralized Control” Blinks (Repeats Single Blink)	222
5.3	Display “Under Centralized Control” Blinks (Repeats Double Blink)	225

1. Symptom-based Troubleshooting

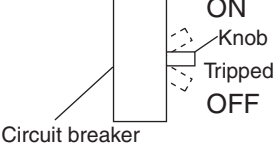
	Symptom	Supposed Cause	Countermeasure	
1	The system does not start operation at all.	Blowout of fuse(s)	Turn Off the power supply and then replace the fuse(s).	
		Cutout of breaker(s)	<ul style="list-style-type: none"> If the knob of any breaker is in its OFF position, turn ON the power supply. If the knob of any circuit breaker is in its tripped position, do not turn ON the power supply. 	
		Power failure	After the power failure is reset, restart the system.	
2	The system starts operation but makes an immediate stop.	Blocked air inlet or outlet of indoor or outdoor unit	Remove obstacle(s).	
		Clogged air filter(s)	Clean the air filter(s).	
3	The system does not cool or heat air well.	Blocked air inlet or outlet of indoor or outdoor unit	Remove obstacle(s).	
		Clogged air filter(s)	Clean the air filter(s).	
		Enclosed outdoor unit(s)	Remove the enclosure.	
		Improper set temperature	Set the temperature to a proper degree.	
		Airflow rate set to "LOW"	Set it to a proper airflow rate.	
		Improper direction of air diffusion	Set it to a proper direction.	
		Open window(s) or door(s)	Shut it tightly.	
		[In cooling] Direct sunlight received	Hang curtains or shades on windows.	
		[In cooling] Too many persons staying in a room		
[In cooling] Too many heat sources (e.g. OA equipment) located in a room				
4	The system does not operate.	The system stops and immediately restarts operation.	Normal operation. The system will automatically start operation after a lapse of five minutes.	
		Pressing the TEMP ADJUST button immediately resets the system.		
		The remote control displays "UNDER CENTRALIZED CONTROL", which blinks for a period of several seconds when the OPERATION button is depressed.	The system is controlled with centralized controller. Blinking display indicates that the system cannot be operated using the remote control.	Operate the system using the COOL/HEAT centralized remote control.
		The system stops immediately after turning ON the power supply.	The system is in preparation mode of micro computer operation.	Wait for a period of approximately one minute.
5	The system makes intermittent stops.	The remote control displays malfunction codes "U4" and "U5", and the system stops but restarts after a lapse of several minutes.	The system stops due to an interruption in communication between units caused by electrical noises coming from equipment other than air conditioners.	Remove causes of electrical noises. If these causes are removed, the system will automatically restart operation.
6	COOL-HEAT selection is disabled.	The remote control displays "UNDER CENTRALIZED CONTROL".	This remote control has no option to select cooling operation.	Use a remote control with option to select cooling operation.
		The remote control displays "UNDER CENTRALIZED CONTROL", and the COOL-HEAT selection remote control is provided.	COOL-HEAT selection is made using the COOL-HEAT selection remote control.	Use the COOL-HEAT selection remote control to select cool or heat.

	Symptom		Supposed Cause	Countermeasure
7	The system conducts fan operation but not cooling or heating operation.	This symptom occurs immediately after turning ON the power supply.	The system is in preparation mode of operation.	Wait for a period of approximately 10 minutes.
8	The airflow rate is not reproduced according to the setting.	Even pressing the AIRFLOW RATE SET button makes no changes in the airflow rate.	In heating operation, when the room temperature reaches the set degree, the outdoor unit will stop while the indoor unit is brought to fan LL operation so that no one gets cold air. Furthermore, if fan operation mode is selected when other indoor unit is in heating operation, the system will be brought to fan LL operation. (The fan LL operation is also enabled while in oil return mode in cooling operation.)	Normal operation.
9	The airflow direction is not reproduced according to the setting.	The airflow direction is not corresponding to that displayed on the remote control. The flap does not swing.	Automatic control	Normal operation.
10	A white mist comes out from the system.	<Indoor unit> In cooling operation, the ambient humidity is high. (This indoor unit is installed in a place with much oil or dust.)	Uneven temperature distribution due to heavy stain of the inside of the indoor unit	Clean the inside of the indoor unit.
		<Indoor unit> Immediately after cooling operation stopping, the ambient temperature and humidity are low.	Hot gas (refrigerant) flown in the indoor unit results to be vapor from the unit.	Normal operation.
		<Indoor and outdoor units> After the completion of defrosting operation, the system is switched to heating operation.	Defrosted moisture turns to be vapor and comes out from the units.	Normal operation.
11	The system produces sounds.	<Indoor unit> Immediately after turning ON the power supply, indoor unit produces "ringing" sounds.	These are operating sounds of the electronic expansion valve of the indoor unit.	Normal operation. This sound becomes low after a lapse of approximately one minute.
		<Indoor and outdoor units> "Hissing" sounds are continuously produced while in cooling or defrosting operation.	These sounds are produced from gas (refrigerant) flowing respectively through the indoor and outdoor units.	Normal operation.
		<Indoor and outdoor units> "Hissing" sounds are produced immediately after the startup or stop of the system, or the startup or stop of defrosting operation.	These sounds are produced when the gas (refrigerant) stops or changes flowing.	Normal operation.
		<Indoor unit> Faint sounds are continuously produced while in cooling operation or after stopping the operation.	These sounds are produced from the drain discharge device in operation.	Normal operation.
		<Indoor unit> "Creaking" sounds are produced while in heating operation or after stopping the operation.	These sounds are produced from resin parts expanding and contracting with temperature changes.	Normal operation.
		<Indoor unit> Sounds like "trickling" or the like are produced from indoor units in the stopped state.	On systems, these sounds are produced when other indoor units in operation. The reason is that the system runs in order to prevent oil or refrigerant from dwelling.	Normal operation.
		<Outdoor unit> Pitch of operating sounds changes.	The reason is that the compressor changes the operating frequency.	Normal operation.

	Symptom		Supposed Cause	Countermeasure
12	Dust comes out from the system.	Dust comes out from the system when it restarts after the stop for an extended period of time.	Dust, which has deposited on the inside of indoor unit, is blown out from the system.	Normal operation.
13	Odors come out from the system.	In operation	Odors of room, cigarettes or else adsorbed to the inside of indoor unit are blown out.	The inside of the indoor unit should be cleaned.
14	Outdoor unit fan does not rotate.	In operation	The reason is that fan revolutions are controlled to put the operation to the optimum state.	Normal operation.
15	LCD display "88" appears on the remote control.	Immediately after turning ON the power supply	The reason is that the system is checking to be sure the remote control is normal.	Normal operation. This code is displayed for a period of approximately one minute at maximum.
16	The outdoor unit compressor or the outdoor unit fan does not stop.	After stopping operation	It stops in order to prevent oil or refrigerant from dwelling.	Normal operation. It stops after a lapse of approximately 5 to 10 minutes.
17	The outdoor gets hot.	While stopping operation	The reason is that the compressor is warmed up to provide smooth startup of the system.	Normal operation.
18	Hot air comes out from the system even though it stops.	Hot air is felt while the system stops.	On systems, small quantity of refrigerant is fed to indoor units in the stopped state when other indoor units are in operation.	Normal operation.
19	The system does not cool air well.	The system is in dry operation.	The reason is that the dry operation serves not to reduce the room temperature where possible.	Change the system to cooling operation.

2. Troubleshooting by remote control

2.1 The INSPECTION / TEST Button

The following modes can be selected by using the [Inspection/Test Operation] button on the remote control.

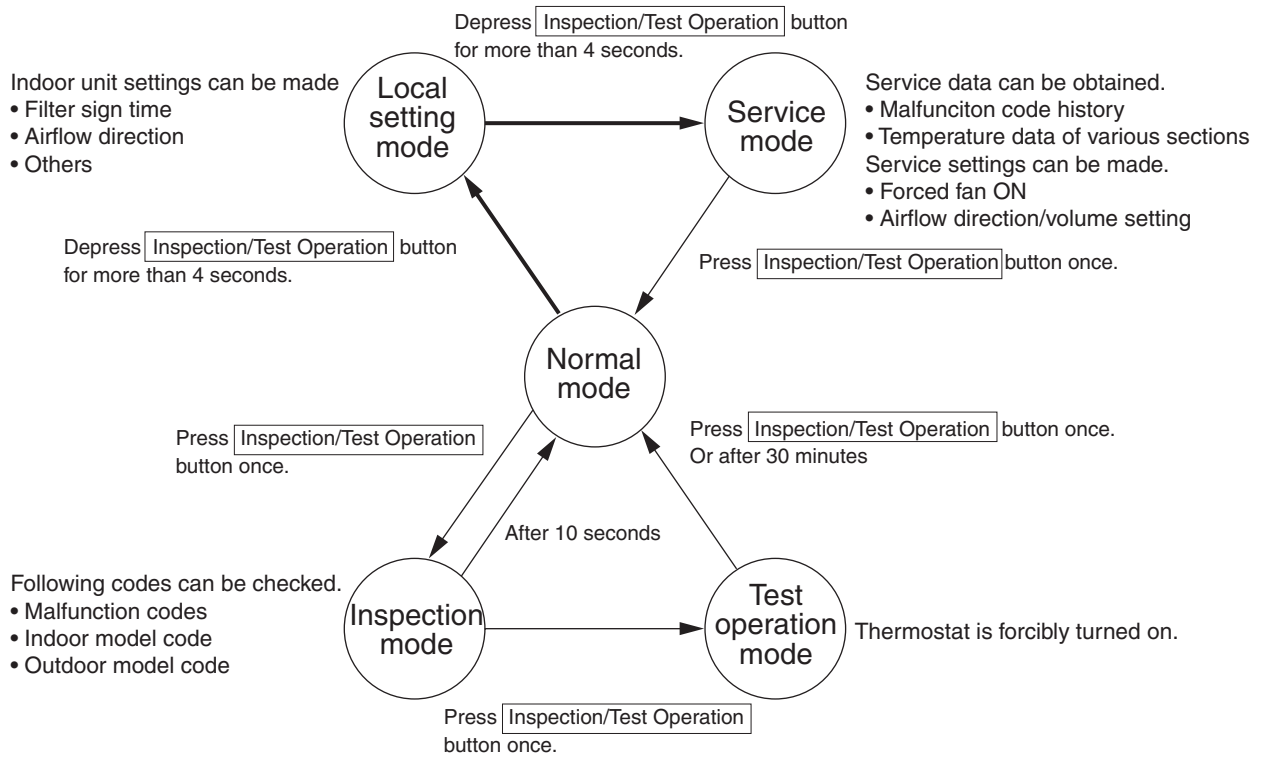

2.2 Self-diagnosis by Wired remote control

Explanation

If operation stops due to malfunction, the remote control's operation LED blinks, and malfunction code is displayed. (Even if stop operation is carried out, malfunction contents are displayed when the inspection mode is entered.) The malfunction code enables you to tell what kind of malfunction caused operation to stop. See page 132 for malfunction code and malfunction contents.

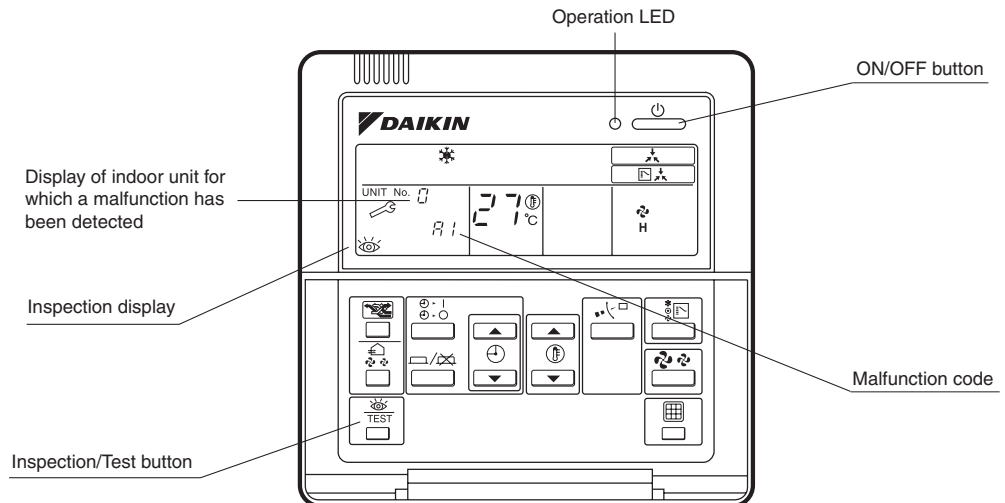

Note:

1. Pressing the INSPECTION/TEST button will blink the check indication.
2. While in check mode, pressing and holding the ON/OFF button for a period of five seconds or more will clear the failure history indication shown above. In this case, on the codes display, the malfunction code will blink twice and then change to "00" (=Normal), the Unit No. will change to "0", and the operation mode will automatically switch from check mode to normal mode (displaying the set temperature).

2.3 Self-diagnosis by infrared remote control

In the Case of BRC7F Type BRC4C Type

If equipment stops due to a malfunction, the operation indicating LED on the light reception section flashes.

The malfunction code can be determined by following the procedure described below. (The malfunction code is displayed when an operation error has occurred. In normal condition, the malfunction code of the last problem is displayed.)

1. Press the INSPECTION/TEST button to select "Inspection."
The equipment enters the inspection mode. The "Unit" indication lights and the Unit No. display shows flashing "0" indication.
 2. Set the Unit No.
Press the UP or DOWN button and change the Unit No. display until the buzzer (*1) is generated from the indoor unit.
*1 Number of beeps
3 short beeps : Conduct all of the following operations.
1 short beep : Conduct steps 3 and 4.
Continue the operation in step 4 until a buzzer remains ON. The continuous buzzer indicates that the malfunction code is confirmed.
Continuous beep : No abnormality.
 3. Press the MODE selector button.
The left "0" (upper digit) indication of the malfunction code flashes.
 4. Malfunction code upper digit diagnosis
Press the UP or DOWN button and change the malfunction code upper digit until the malfunction code matching buzzer (*2) is generated.
- The upper digit of the code changes as shown below when the UP and DOWN buttons are pressed.



⇒ "Advance" button ← "Backward" button

*2 Number of beeps

Continuous beep : Both upper and lower digits matched. (Malfunction code confirmed)

2 short beeps : Upper digit matched.

1 short beep : Lower digit matched.

5. Press the MODE selector button.
The right "0" (lower digit) indication of the malfunction code flashes.
6. Malfunction code lower digit diagnosis
Press the UP or DOWN button and change the malfunction code lower digit until the continuous malfunction code matching buzzer (*2) is generated.

- The lower digit of the code changes as shown below when the UP and DOWN buttons are pressed.

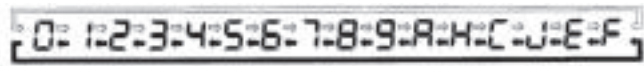

⇨ "Advance" button ⇩ "Backward" button

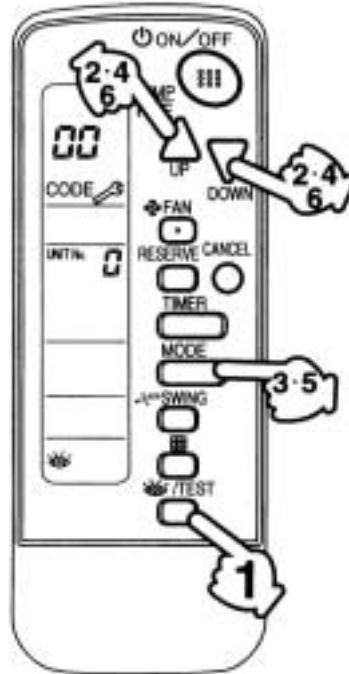

Normal status
 Enters inspection mode from normal status when the INSPECTION/TEST button is pressed.

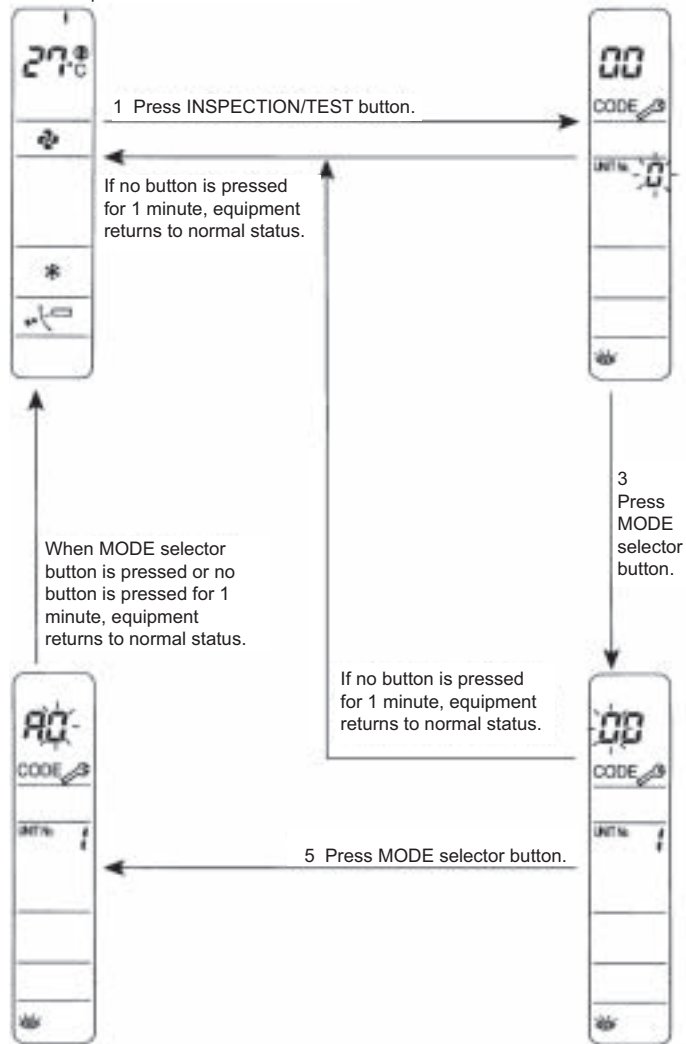

2.4 remote control Service Mode

How to Enter the Service Mode

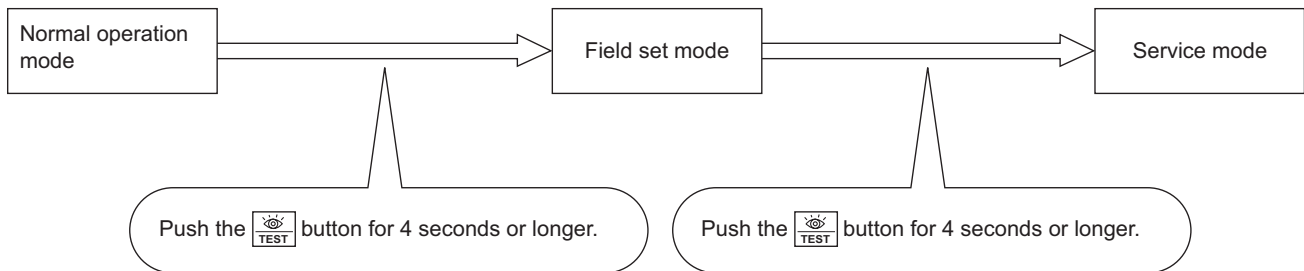



Service Mode Operation Method

1. Select the mode No.

Set the desired mode No. with the  button.
(For infrared remote control, Mode 43 only can be set.)

2. Select the unit No. (For group control only)

Select the indoor unit No. to be set with the time mode . (For infrared remote control,  button.)

3. Make the settings required for each mode. (Modes 41, 44, 45)

In case of Mode 44, 45, push  button to be able to change setting before setting work. (LCD "code" blinks.)









For details, refer to the table in next page.

4. Define the setting contents. (Modes 44, 45)

Define by pushing the timer  button.
After defining, LCD "code" changes blinking to ON.

5. Return to the normal operation mode.

Push the  button one time.

Mode No	Function	Contents and operation method	remote control display example
40	Malfunction hysteresis display	<p>Display malfunction hysteresis.</p> <p>The history No. can be changed with the  button.</p>	<p>Unit 1 Malfunction code 2-U4 40</p> <p>Malfunction code</p> <p>History No: 1 - 9 1: Latest</p>
41	Display of sensor and address data	<p>Display various types of data.</p> <p>Select the data to be displayed with the  button. Sensor data 0: Thermostat sensor in remote control. 1: Suction 2: Liquid pipe 3: Gas pipe</p> <p>Address data 4: Indoor unit address 5: Outdoor unit address 6: BS unit address 7: Zone control address 8: Cool/heat group address 9: Demand / low noise address</p>	<p>Sensor data display</p> <p>Unit No. Sensor type</p> <p>1 1 41</p> <p>2 7</p> <p>Temperature °C</p> <p>Address display</p> <p>Unit No. Address type</p> <p>1 8 41</p> <p>1</p> <p>Address</p>
43	Forced fan ON	<p>Manually turn the fan ON by each unit. (When you want to search for the unit No.)</p> <p>By selecting the unit No. with the  button, you can turn the fan of each indoor unit on (forced ON) individually.</p>	<p>Unit 1 43</p>
44	Individual setting	<p>Set the fan speed and airflow direction by each unit</p> <p>Select the unit No. with the time mode  button. Set the fan speed with the  button.</p> <p>Set the airflow direction with the  button.</p>	<p>Unit 1 Code 44</p> <p>Fan speed 1: Low 3: High</p> <p>Airflow direction P0 - P4</p>
45	Unit No. transfer	<p>Transfer unit No.</p> <p>Select the unit No. with the  button. Set the unit No. after transfer with the  button.</p>	<p>Present unit No.</p> <p>Unit 1 Code 45</p> <p>0 2</p> <p>Unit No. after transfer</p>
46	This function is not used by CMS R-410A Heat Pump 50Hz.		
47			

2.5 remote control Self-Diagnosis Function

The remote control switches are equipped with a self diagnosis function so that more appropriate maintenance can be carried out. If a malfunction occurs during operation, the operation lamp, malfunction code and display of malfunctioning unit No. let you know the contents and location of the malfunction.

When there is a stop due to malfunction, the contents of the malfunction given below can be diagnosed by a combination of operation lamp, INSPECTION display of the liquid crystal display and display of malfunction code. It also lets you know the unit No. during group control.

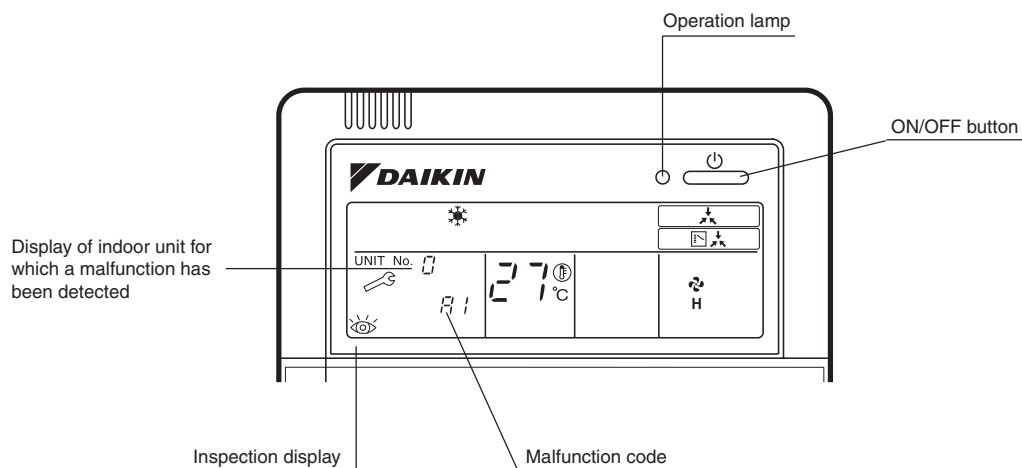

○ : ON ● : OFF ◐ : Blink

	Malfunction code	Operation lamp	Malfunction contents	Page Referred
Indoor Unit	A0	◐	Error of external protection device	138
	A1	◐	PC board defect	139
	A3	◐	Malfunction of drain level control system (S1L)	140
	A6	◐	Fan motor (M1F) lock, overload	142
	A9	◐	Malfunction of moving part of electronic expansion valve (Y1E)	143
	AF	○	Drain level above limit	145
	AH	○	Malfunction of air filter maintenance	—
	AJ	◐	Malfunction of capacity Determination Device	146
	C4	◐	Malfunction of thermistor (R2T) for heat exchange	147
	C5	◐	Malfunction of thermistor (R3T) for gas pipes	148
	C9	◐	Malfunction of thermistor (R1T) for suction air	149
	CC	○	Malfunction of humidity sensor system	150
	CJ	○	Malfunction of thermostat sensor in remote control	151
	Outdoor Unit	E1	◐	PC board defect
E3		◐	Actuation of high pressure switch	153
E4		◐	Actuation of low pressure sensor	155
E5		◐	Inverter compressor motor lock	157
E7		◐	Malfunction of outdoor unit fan motor	159
E9		◐	Malfunction of moving part of electronic expansion valve (Y1E, Y2E)	162
F3		◐	Abnormal discharge pipe temperature	164
F6		◐	Refrigerant overcharged	165
H7		◐	Abnormal outdoor fan motor signal	166
H9		◐	Malfunction of thermistor (R1T) for outdoor air	167
J3		◐	Malfunction of discharge pipe thermistor (R3T)	168
J5		◐	Malfunction of thermistor (R2T,R7T) for suction pipe	169
J6		◐	Malfunction of thermistor (R4T) for outdoor unit heat exchanger	170
J7		◐	Malfunction of liquid pipe thermistor (R6T)	171
J9		◐	Malfunction of subcooling heat exchanger gas pipe thermistor (R5T)	172
JA		◐	Malfunction of high pressure sensor	173
JC		◐	Malfunction of low pressure sensor	174
L0		◐	Inverter system error	—
L4		◐	Malfunction of inverter radiating fin temperature rise	175
L5		◐	Inverter compressor abnormal	177
L8		◐	Inverter current abnormal	179
L9		◐	Inverter start up error	181
LA		◐	Malfunction of power unit	—
LC		◐	Malfunction of transmission between inverter and control PC board	183
P1		◐	Inverter over-ripple protection	186
P4		◐	Malfunction of inverter radiating fin temperature rise sensor	187
PJ		◐	Faulty field setting after replacing main PC board or faulty combination of PC board	189

○ : ON ● : OFF ◐ : Blink

	Malfunction code	Operation lamp	Malfunction contents	Page Referred
System	U0	○	Low pressure drop due to refrigerant shortage or electronic expansion valve failure	190
	U1	◐	Reverse phase, open phase	191
	U2	◐	Power supply insufficient or instantaneous failure	192
	U3	◐	Check operation not executed	195
	U4	◐	Malfunction of transmission between indoor units	196
	U5	◐	Malfunction of transmission between remote control and indoor unit	198
	U5	●	Failure of remote control PC board or setting during control by remote control	198
	U7	◐	Malfunction of transmission between outdoor units	199
	U8	◐	Malfunction of transmission between main and sub remote controls	201
	U9	◐	Malfunction of transmission between indoor and outdoor units in the same system	202
	UA	◐	Improper combination of indoor and outdoor units, indoor units and remote control	203
	UC	○	Address duplication of centralized controller	205
	UE	◐	Malfunction of transmission between centralized controller and indoor unit	206
	UF	◐	System is not set yet	209
	UH	◐	Malfunction of system, refrigerant system address undefined	210
Central remote control and Schedule Timer	M1	○ or ●	PC board defect	212
	M8	○ or ●	Malfunction of transmission between optional controllers for centralized control	213
	MA	○ or ●	Improper combination of optional controllers for centralized control	215
	MC	○ or ●	Address duplication, improper setting	217
Heat Reclaim Ventilation	64	○	Indoor unit's air thermistor error	—
	65	○	Outside air thermistor error	—
	6A	○	Damper system alarm	—
	6A	◐	Damper system + thermistor error	—
	6F	○	Malfunction of simple remote control	—
	6H	○	Malfunction of door switch or connector	—
	94	◐	Internal transmission error	—

 The system operates for malfunction codes indicated in black squares, however, be sure to check and repair.

Malfunction code indication by outdoor unit PC board

<Monitor mode>

To enter the monitor mode, push the **MODE (BS1)** button when in "Setting mode 1".

* Refer to P.106 for Monitor mode.

<Selection of setting item>

Push the **SET (BS2)** button and set the LED display to a setting item.

* Refer to P.106 for Monitor mode.

<Confirmation of malfunction 1>

Push the **RETURN (BS3)** button once to display "First digit" of malfunction code.

<Confirmation of malfunction 2>

Push the **SET (BS2)** button once to display "Second digit" of malfunction code.

<Confirmation of malfunction 3>

Push the **SET (BS2)** button once to display "malfunction location".

<Confirmation of malfunction 4>

Push the **SET (BS2)** button once to display "master or slave 1 or slave 2" and "malfunction location".

Push the **RETURN (BS3)** button and switches to the initial status of "Monitor mode".

* Push the **MODE (BS1)** button and returns to "Setting mode 1".

Detail description on next page.

Contents of malfunction		Malfunction code
PC board malfunction	PC board malfunction	E1
	Faulty PC board	
Abnormal discharge pressure	HPS activated	E3
Abnormal suction pressure	Abnormal Pe	E4
Compressor lock	Detection of INV compressor lock	E5
Activation of OC	Detection of STD1 compressor lock	E6
	Detection of STD2 compressor lock	
Over load, over current, abnormal lock of outdoor unit fan motor	Instantaneous over current of DC fan 1 motor	E7
	Detection of DC fan 1 motor lock	
	Instantaneous over current of DC fan 2 motor	
Malfunction of electronic expansion valve	Detection of DC fan 2 motor lock	E9
	EV1	
	EV2	
Abnormal position signal of outdoor unit fan motor	EV3	H7
	Abnormal position signal of DC fan 1 motor	
Faulty sensor of outdoor air temperature	Abnormal position signal of DC fan 2 motor	H9
	Faulty Ta sensor (short)	
Abnormal discharge pipe temperature	Faulty Ta sensor (open)	F3
	Abnormal Td	
Abnormal heat exchanger temperature	Refrigerant over charge	F6
	Faulty CT1 sensor	
Faulty current sensor	Faulty CT2 sensor	J2
	Faulty Tdi sensor (short)	
Faulty sensor of discharge pipe temperature	Faulty Tds1 sensor (short)	J3
	Faulty Tds2 sensor (short)	
	Faulty Tdi sensor (open)	
	Faulty Tds1 sensor (open)	
	Faulty Tds2 sensor (open)	
Faulty sensor of suction pipe temperature	Faulty Ts1 sensor (short)	J5
	Faulty Ts1 sensor (open)	
	Faulty Ts2 sensor (short)	
	Faulty Ts2 sensor (open)	
Faulty sensor of heat exchanger temperature	Faulty Tb sensor (short)	J6
	Faulty Tb sensor (open)	
Malfunction of the liquid pipe temperature sensor	Faulty Tl sensor (short)	J7
	Faulty Tl sensor (open)	
Faulty sensor of subcool heat exchanger temperature	Faulty Tsh sensor (short)	J9
	Faulty Tsh sensor (open)	
Faulty sensor of discharge pressure	Faulty Pc sensor (short)	JA
	Faulty Pc sensor (open)	
Faulty sensor of suction pressure	Faulty Pe sensor (short)	JC
	Faulty Pe sensor (open)	
Instantaneous power failure	*NO display on remote control (Judge during compressor operation)	(L2)
Inverter radiation fin temperature rising	Over heating of inverter radiation fin temperature	L4
DC output over current	Inverter instantaneous over current	L5
	IGBT malfunction	
Electronic thermal	Electronic thermal switch 1	L8
	Electronic thermal switch 2	
	Out-of-step	
	Speed down after startup	
Stall prevention (Limit time)	Lightening detection	L9
	Stall prevention (Current increasing)	
	Stall prevention (Faulty start up)	
	Abnormal wave form in startup	
Transmission error between inverter and outdoor unit	Out-of-step	LC
	Inverter transmission error	

○ : ON ● : OFF ◐ :Blink

Malfunction code	Confirmation of malfunction 1							Confirmation of malfunction 2							Confirmation of malfunction 3							Confirmation of malfunction 4						
	H1P	H2P	H3P	H4P	H5P	H6P	H7P	H1P	H2P	H3P	H4P	H5P	H6P	H7P	H1P	H2P	H3P	H4P	H5P	H6P	H7P	H1P	H2P	H3P	H4P	H5P	H6P	H7P
E1	●			●	●	◐	◐	◐			●	●	●	◐	◐			●	●	●	●	◐			●	●	◐	◐
E3								◐			●	●	◐	◐	◐			●	●	●	●	◐			●	●		
E4								◐			●	◐	●	●	◐			●	●	●	●	◐			●	●		
E5								◐			●	◐	●	◐	◐			●	●	●	●	◐			●	●		
E6								◐			●	◐	◐	●	◐			●	●	●	●	◐			●	●		
E7								◐			●	◐	◐	◐	◐			●	●	●	●	◐			●	●		
E9								◐			◐	●	●	◐	◐			●	●	●	●	◐			●	●		
H7	◐			●	◐	●	●	◐			●	◐	◐	◐	◐			●	●	●	●	◐			●	●		
H9								◐			◐	●	●	◐	◐			●	●	●	●	◐			●	●		
F3	◐			●	◐	●	◐	◐			●	●	◐	◐	◐			●	●	●	●	◐			●	●		
F6								◐			●	◐	◐	●	◐			●	●	●	●	◐			●	●	◐	◐
J2	◐			●	◐	◐	●	◐			●	●	◐	●	◐			●	●	●	●	◐			●	●		
J3								◐			●	●	◐	◐	◐			●	●	●	●	◐			●	●		
J5								◐			●	◐	●	◐	◐			●	●	●	●	◐			●	●		
J6								◐			●	◐	◐	●	◐			●	●	●	●	◐			●	●		
J7								◐			●	◐	◐	◐	◐			●	●	●	●	◐			●	●		
J9								◐			◐	●	●	◐	◐			●	●	●	●	◐			●	●		
JA								◐			◐	●	◐	●	◐			●	●	●	●	◐			●	●		
JC								◐			◐	◐	●	●	◐			●	●	●	●	◐			●	●		
(L2)	◐			●	◐	◐	◐	◐			●	●	◐	●	◐			●	●	●	●	◐			●	●		
L4								◐			●	◐	●	●	◐			●	●	●	●	◐			●	●		
L5								◐			●	◐	●	◐	◐			●	●	●	●	◐			●	●		
L8								◐			◐	●	●	●	◐			●	●	●	●	◐			●	●		
L9								◐			◐	●	●	◐	◐			●	●	●	●	◐			●	●		
LC								◐			◐	◐	●	●	◐			●	●	●	●	◐			●	●		

Display of contents of malfunction (first digit)

Display of contents of malfunction (second digit)

Display 1 of malfunction in detail

*1

●	●	Master
●	◐	Slave1
◐	●	Slave2
◐	◐	System

<Monitor mode>

To enter the monitor mode, push the **MODE (BS1)** button when in "Setting mode 1".

* Refer to P.106 for Monitor mode.

<Selection of setting item>

Push the **SET (BS2)** button and set the LED display to a setting item.

* Refer to P.106 for Monitor mode.

<Confirmation of malfunction 1>

Push the **RETURN (BS3)** button once to display "First digit" of malfunction code.

<Confirmation of malfunction 2>

Push the **SET (BS2)** button once to display "Second digit" of malfunction code.

<Confirmation of malfunction 3>

Push the **SET (BS2)** button once to display "malfunction location".

<Confirmation of malfunction 4>

Push the **SET (BS2)** button once to display "master or slave 1 or slave 2" and "malfunction location".

Push the **RETURN (BS3)** button and switches to the initial status of "Monitor mode".

* Push the **MODE (BS1)** button and returns to "Setting mode 1".

Detail description on next page.

Contents of malfunction		Malfunction code
Open phase/Power supply imbalance	Imbalance of inverter power supply voltage	P1
Faulty temperature sensor inside switch box	Faulty thermistor of inverter box	P3
Faulty temperature sensor of inverter radiation fin	Faulty thermistor of inverter fin	P4
Incorrect combination of Inverter and fan driver	Incorrect combination of inverter	PJ
	Incorrect combination of fan driver 1	
	Incorrect combination of fan driver 2	
Gas shortage	Gas shortage alarm	U0
Reverse phase	Reverse phase error	U1
Abnormal power supply voltage	Insufficient Inverter voltage	U2
	Inverter open phase (phase T)	
	Charging error of capacitor in inverter main circuit	
No implementation of test-run		U3
Transmission error between indoor and outdoor unit	I/O transmission error	U4
	I/O transmission error	
Transmission error between outdoor units, transmission error between thermal storage units, duplication of IC address	Sequential startup ADP alarm	U7
	Sequential startup ADP malfunction	U7
	Malfunction of transmission between multi units (Multi 1)	
	Malfunction of transmission between multi units (Multi 2)	
	Abnormal multi horsepower setting	
	Abnormal multi address setting	
	Excessive multi connections	
Multi system malfunction		
Transmission error of other system	Indoor unit system abnormal in other system or other indoor unit system abnormal in own system	U9
Erroneous field setting	System transmission malfunction	UA
	Over connection malfunction of indoor units	
	Malfunction of field setting	
	Refrigerant abnormal	
	Multi-ID abnormal	
	Alarm of TSS field setting	UA
Faulty system malfunction	Wiring error (Auto-address error)	UH
Transmission error in accessory devices	Malfunction of multi-level connection	UJ
	Alarm of multi-level connection	UJ
Conflict in wiring and piping, no setting for system	Conflict in wiring and piping	UF

3. Troubleshooting by Indication on the remote control

3.1 “RD” Indoor Unit: Error of External Protection Device

remote control Display	RD
Applicable Models	All indoor unit models
Method of Malfunction Detection	Detect open or short circuit between external input terminals in indoor unit.
Malfunction Decision Conditions	When an open circuit occurs between external input terminals with the remote control set to "external ON/OFF terminal".
Supposed Causes	<ul style="list-style-type: none"> ■ Actuation of external protection device ■ Improper field set ■ Defect of indoor unit PC board

Troubleshooting



Caution

Be sure to turn off power switch before connect or disconnect connector, or parts damage may be occurred.

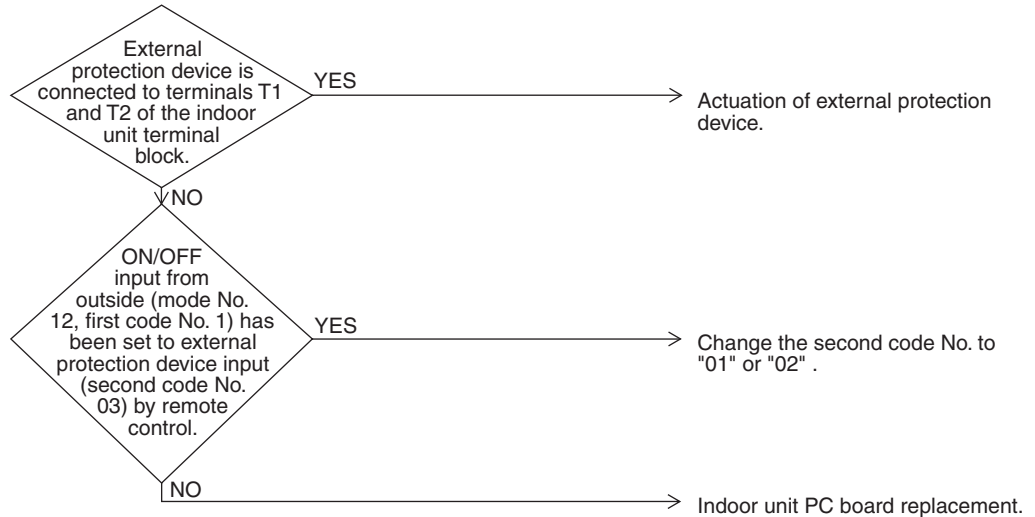

3.2 “A1” Indoor Unit: PC Board Defect

remote control Display	A1
Applicable Models	All indoor unit models
Method of Malfunction Detection	Check data from E ² PROM.
Malfunction Decision Conditions	When data could not be correctly received from the E ² PROM E ² PROM : Type of nonvolatile memory. Maintains memory contents even when the power supply is turned off.
Supposed Causes	<ul style="list-style-type: none"> ■ Defect of indoor unit PC board
Troubleshooting	<pre> graph TD Start[Turn power supply OFF, then power ON again.] --> Decision{Does the system return to normal?} Decision -- YES --> Normal[The indoor unit PC board is normal. External factor other than malfunction (for example, noise etc.)] Decision -- NO --> Replace[Replace the indoor unit PC board.] </pre>

3.3 “R3” Indoor Unit: Malfunction of Drain Level Control System (S1L)

remote control Display	<i>R3</i>
Applicable Models	FMCQ, FMDQ
Method of Malfunction Detection	By float switch OFF detection
Malfunction Decision Conditions	When rise of water level is not a condition and the float switch goes OFF.
Supposed Causes	<ul style="list-style-type: none"> ■ 220~240V power supply is not provided ■ Defect of float switch or short circuit connector ■ Defect of drain pump ■ Drain clogging, upward slope, etc. ■ Defect of indoor unit PC board ■ Loose connection of connector

Troubleshooting



Caution

Be sure to turn off power switch before connect or disconnect connector, or parts damage may be occurred.

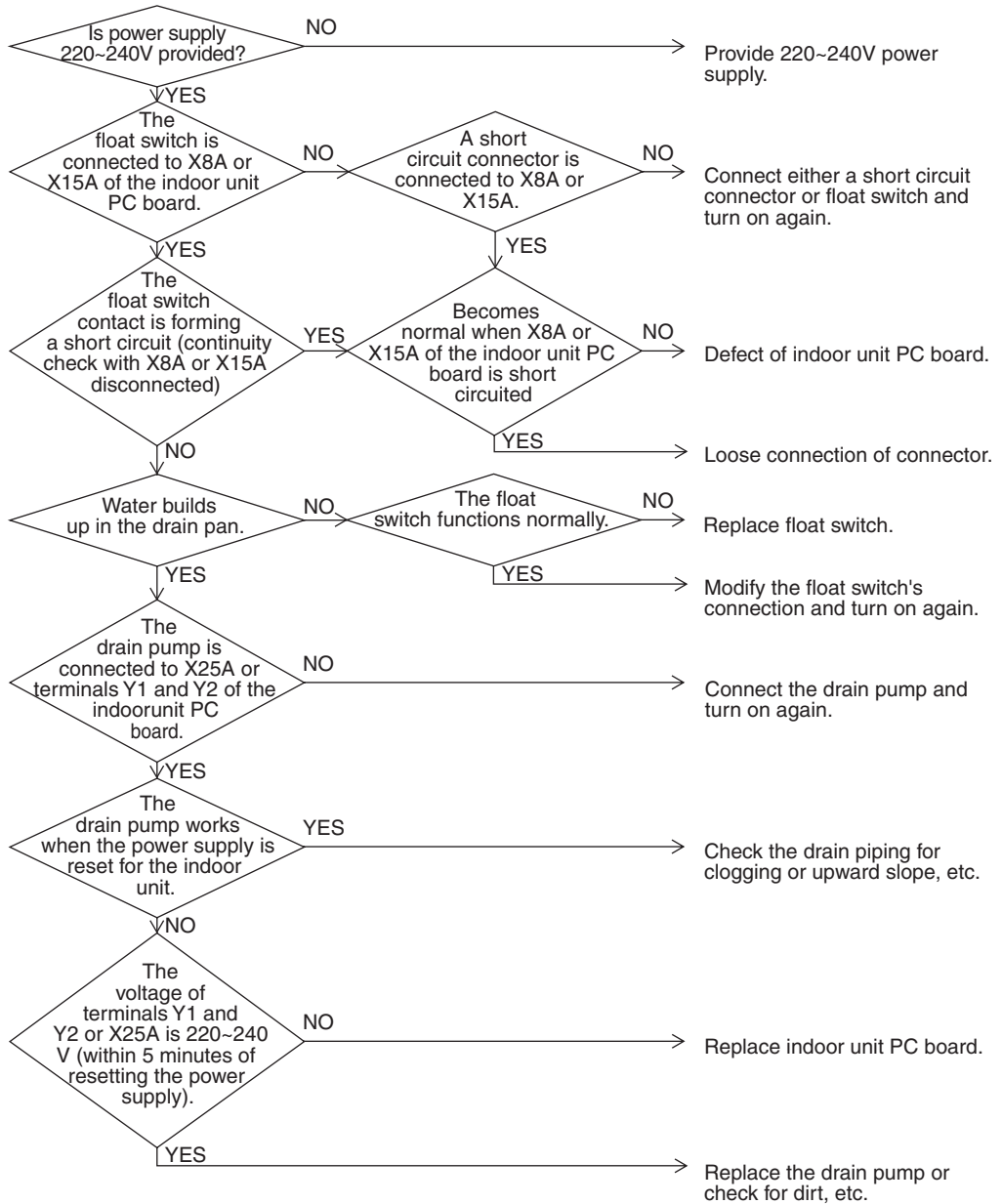

3.4 “A6” Indoor Unit: Fan Motor (M1F) Lock, Overload

remote control Display	A6
Applicable Models	All indoor units
Method of Malfunction Detection	Detection by failure of signal for detecting number of turns to come from the fan motor
Malfunction Decision Conditions	When number of turns can't be detected even when output voltage to the fan is maximum
Supposed Causes	<ul style="list-style-type: none"> ■ Fan motor lock ■ Disconnected or faulty wiring between fan motor and PC board

Troubleshooting



Caution Be sure to turn off power switch before connect or disconnect connector, or parts damage may be occurred.

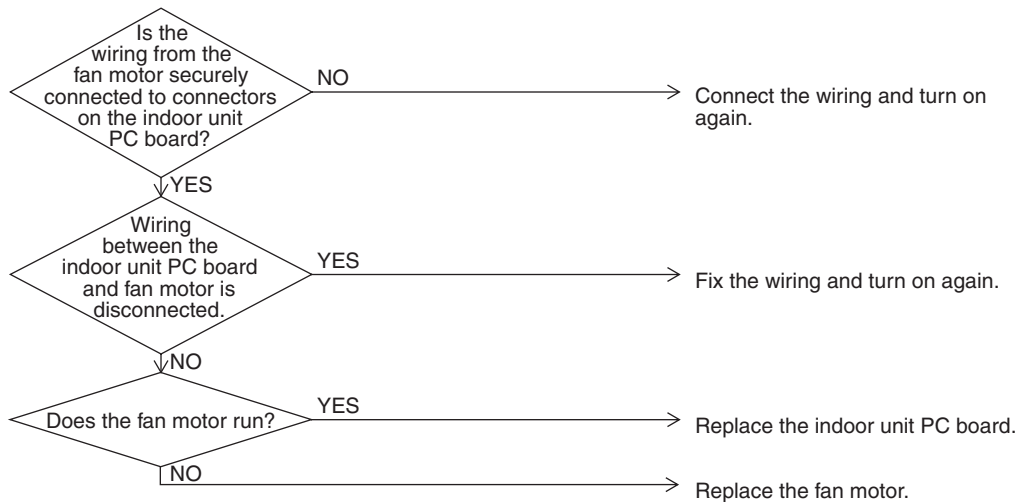

3.5 “R9” Indoor Unit: Malfunction of Moving Part of Electronic Expansion Valve (Y1E)

remote control
Display

R9

Applicable
Models

All indoor unit models

Method of
Malfunction
Detection

Use a microcomputer to check the electronic expansion valve for coil conditions.

Malfunction
Decision
Conditions

When the pin input of the electronic expansion valve is not normal while in the initialization of the microcomputer.

Supposed
Causes

- Malfunction of moving part of electronic expansion valve
- Defect of indoor unit PC board
- Defect of connecting cable

Troubleshooting



Caution

Be sure to turn off power switch before connect or disconnect connector, or parts damage may be occurred.

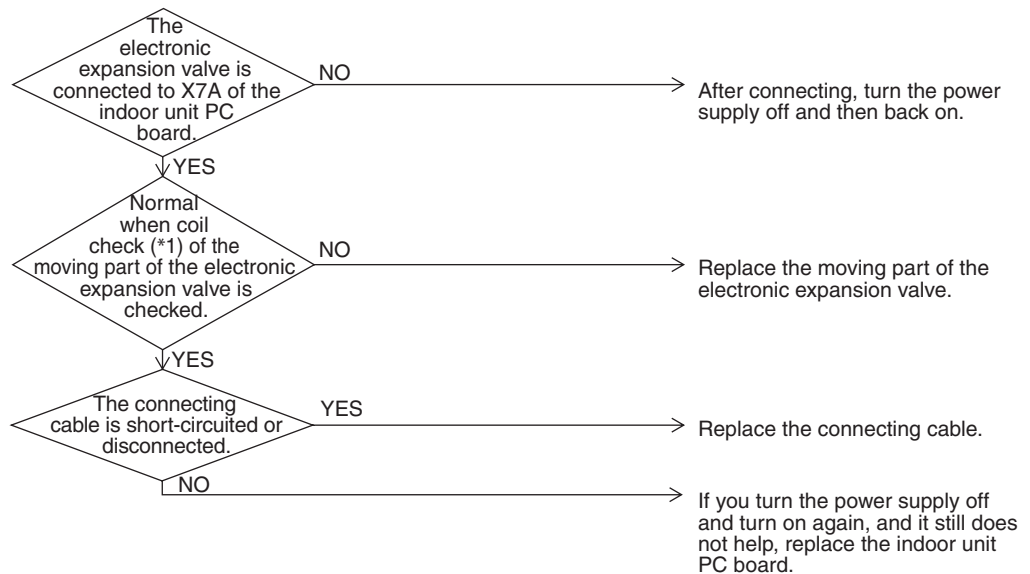

*1: Coil check method for the moving part of the electronic expansion valve
 Disconnect the electronic expansion valve from the PC board and check the continuity between the connector pins.

(Normal)

Pin No.	1. White	2. Yellow	3. Orange	4. Blue	5. Red	6. Brown
1. White		x	○ Approx. 300Ω	x	○ Approx. 150Ω	x
2. Yellow			x	○ Approx. 300Ω	x	○ Approx. 150Ω
3. Orange				x	○ Approx. 150Ω	x
4. Blue					x	○ Approx. 150Ω
5. Red						x
6. Brown						

○: Continuity

x: No continuity

3.6 “AF” Indoor Unit: Drain Level above Limit

remote control Display	<i>AF</i>
Applicable Models	FMCQ, FMDQ
Method of Malfunction Detection	Water leakage is detected based on float switch ON/OFF operation while the compressor is in non-operation.
Malfunction Decision Conditions	When the float switch changes from ON to OFF while the compressor is in non-operation.
Supposed Causes	<ul style="list-style-type: none"> ■ Humidifier unit (optional accessory) leaking ■ Defect of drain pipe (upward slope, etc.) ■ Defect of indoor unit PC board

Troubleshooting

Caution

Be sure to turn off power switch before connect or disconnect connector, or parts damage may be occurred.

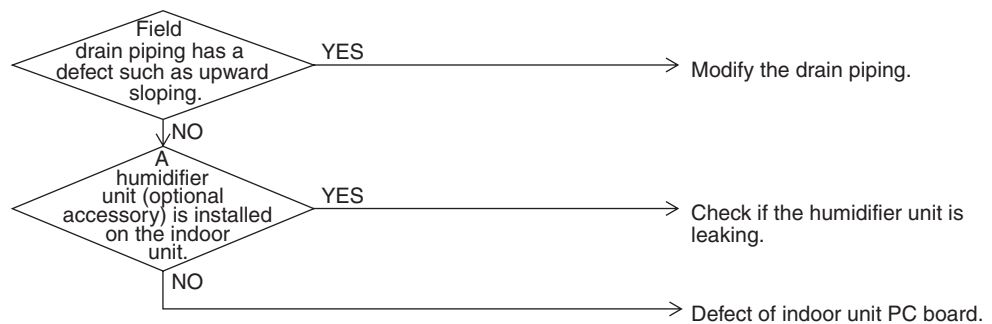

3.7 “AU” Indoor Unit: Malfunction of Capacity Determination Device

remote control Display	AU
Applicable Models	All indoor unit models
Method of Malfunction Detection	Capacity is determined according to resistance of the capacity setting adapter and the memory inside the IC memory on the indoor unit PC board, and whether the value is normal or abnormal is determined.
Malfunction Decision Conditions	Operation and: When the capacity code is not contained in the PC board's memory, and the capacity setting adapter is not connected.
Supposed Causes	<ul style="list-style-type: none"> ■ You have forgotten to install the capacity setting adapter. ■ Defect of indoor unit PC board

Troubleshooting



Caution

Be sure to turn off power switch before connect or disconnect connector, or parts damage may be occurred.

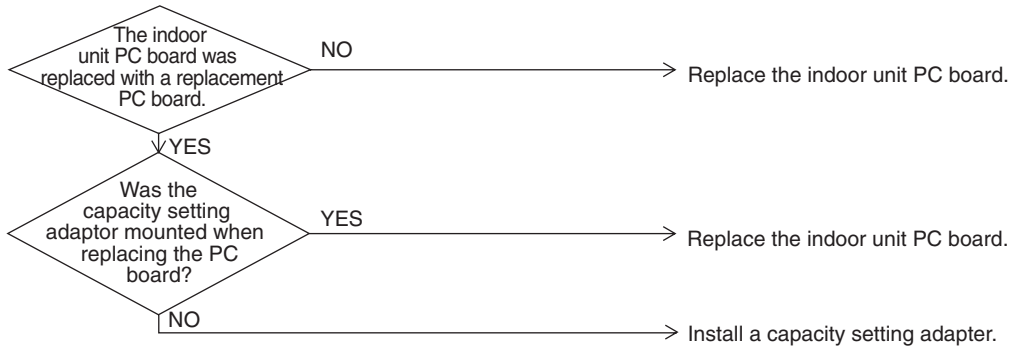

3.8 “[4]” Indoor Unit: Malfunction of Thermistor (R2T) for Heat Exchanger

remote control
Display

[4]

Applicable
Models

All indoor unit models

Method of
Malfunction
Detection

Malfunction detection is carried out by temperature detected by heat exchanger thermistor.

Malfunction
Decision
Conditions

When the heat exchanger thermistor becomes disconnected or shorted while the unit is running.

Supposed
Causes

- Defect of thermistor (R2T) for liquid pipe
- Defect of indoor unit PC board

Troubleshooting



Caution

Be sure to turn off power switch before connect or disconnect connector, or parts damage may be occurred.

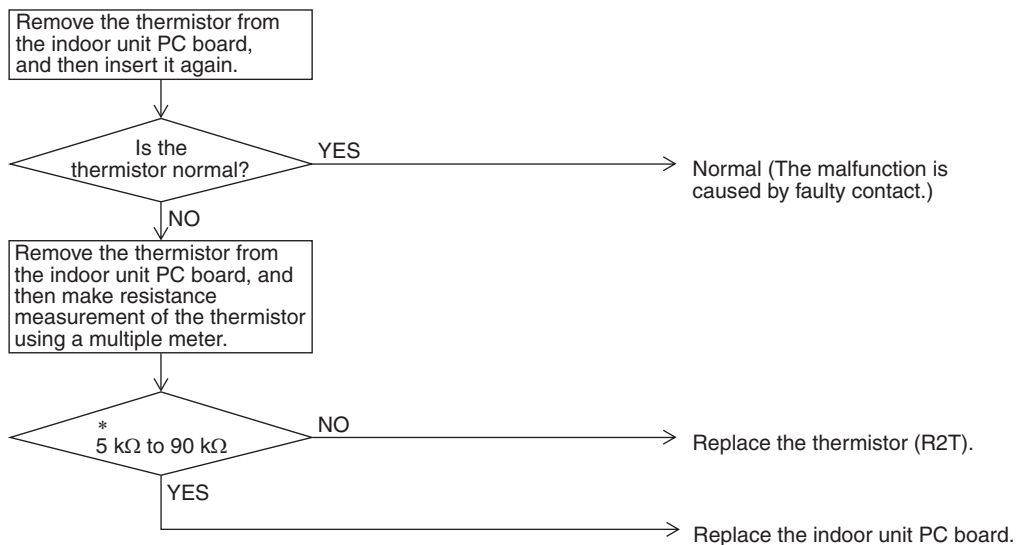

* Refer to “Thermistor Resistance / Temperature Characteristics” table on P.247.

3.9 “E5” Indoor Unit: Malfunction of Thermistor (R3T) for Gas Pipes

remote control Display	E5
Applicable Models	All indoor unit models
Method of Malfunction Detection	Malfunction detection is carried out by temperature detected by gas pipe thermistor.
Malfunction Decision Conditions	When the gas pipe thermistor becomes disconnected or shorted while the unit is running.
Supposed Causes	<ul style="list-style-type: none"> ■ Defect of indoor unit thermistor (R3T) for gas pipe ■ Defect of indoor unit PC board

Troubleshooting



Caution Be sure to turn off power switch before connect or disconnect connector, or parts damage may be occurred.

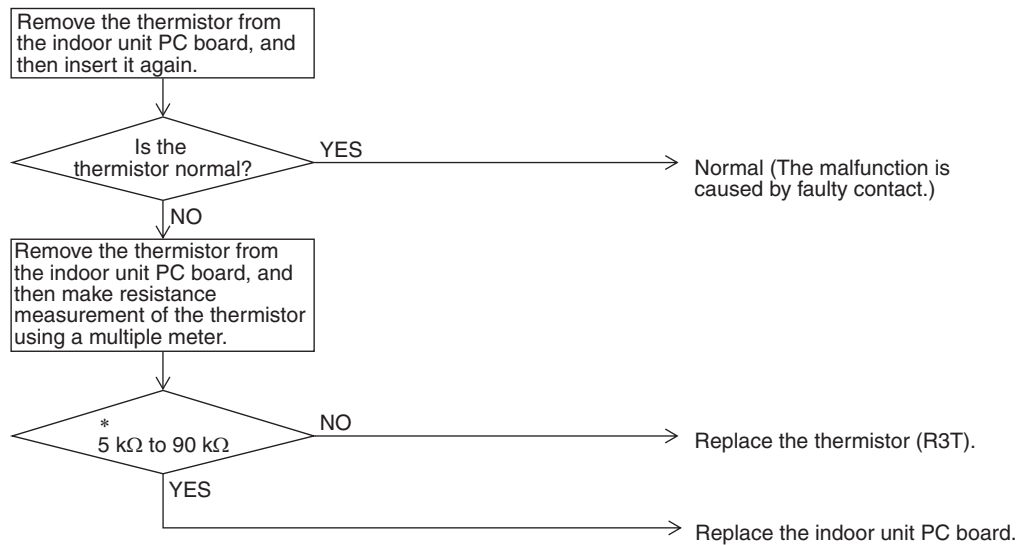

* Refer to “Thermistor Resistance / Temperature Characteristics” table on P.247.

3.10 “[9]” Indoor Unit: Malfunction of Thermistor (R1T) for Suction Air

remote control
Display

[9]

Applicable
Models

All indoor unit models

Method of
Malfunction
Detection

Malfunction detection is carried out by temperature detected by suction air temperature thermistor.

Malfunction
Decision
Conditions

When the suction air temperature thermistor becomes disconnected or shorted while the unit is running.

Supposed
Causes

- Defect of indoor unit thermistor (R1T) for air inlet
- Defect of indoor unit PC board

Troubleshooting



Caution

Be sure to turn off power switch before connect or disconnect connector, or parts damage may be occurred.

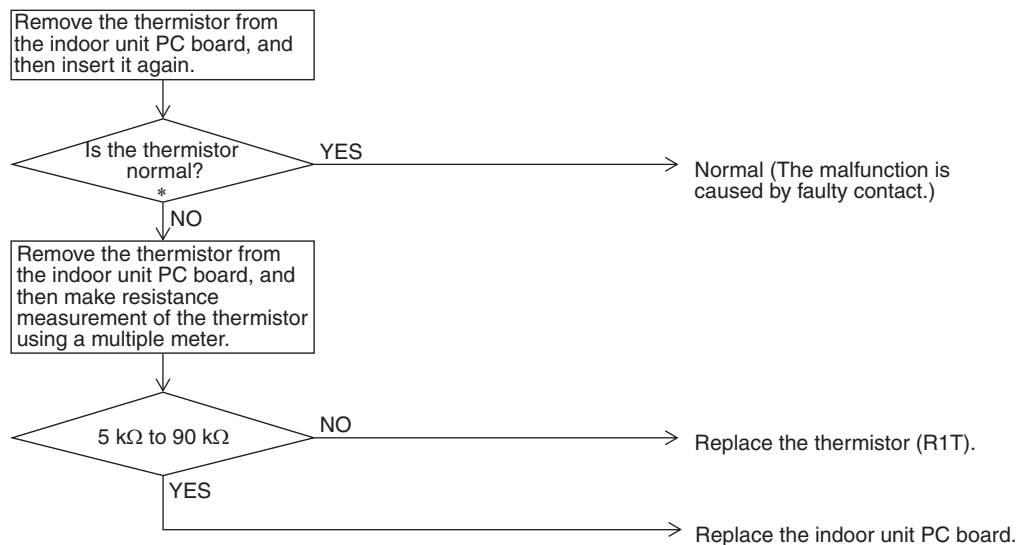

* Refer to “Thermistor Resistance / Temperature Characteristics” table on P.247.

3.11 “[[” Indoor Unit: Malfunction of Humidity Sensor System

remote control Display	[[
Applicable Models	FMCQ
Method of Malfunction Detection	Even if a malfunction occurs, operation still continues. Malfunction is detected according to the moisture (output voltage) detected by the moisture sensor.
Malfunction Decision Conditions	When the moisture sensor is disconnected or short-circuited
Supposed Causes	<ul style="list-style-type: none"> ■ Faulty sensor ■ Disconnection

Troubleshooting

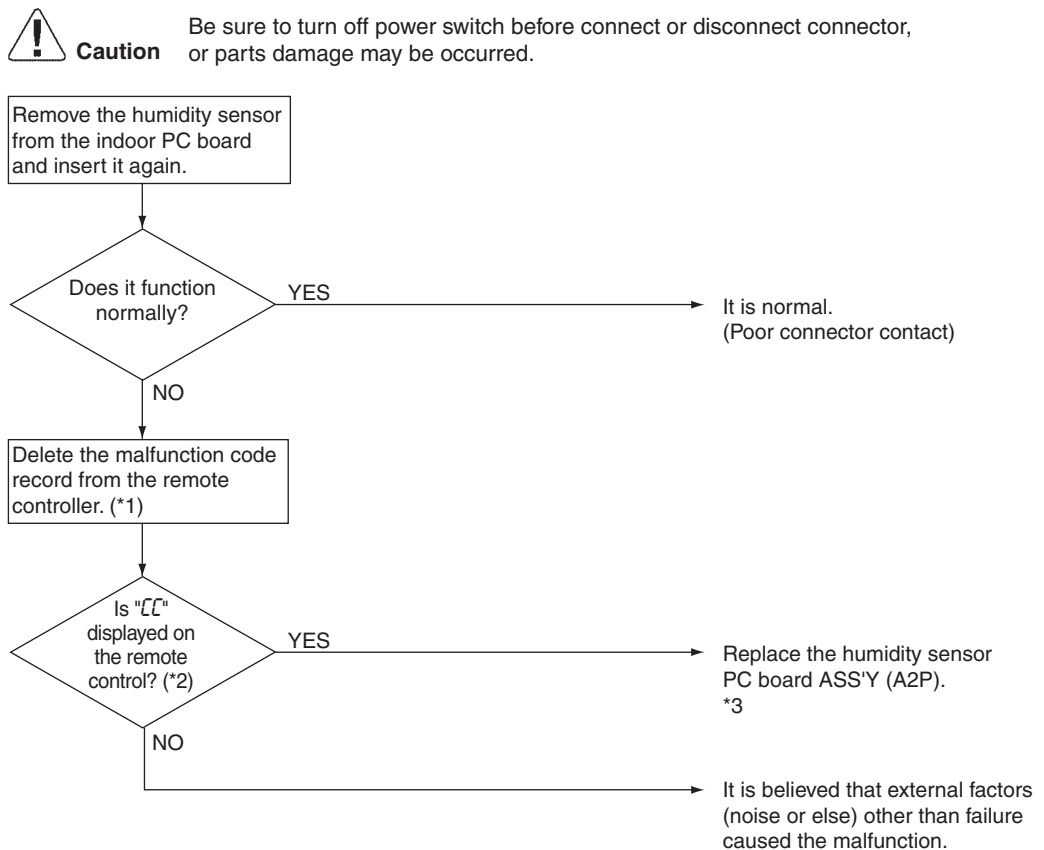

*1: To delete the record, the **ON/OFF** button of the remote control must be pushed and held for 5 seconds in the check mode.
 *2: To display the code, the **Inspection/Test Operation** button of the remote control must be pushed and held in the normal mode.
 *3: If "[[is displayed even after replacing the humidity sensor PC board ASS'Y (A2P) and taking the steps *1 and 2, replace the indoor PC board ASS'Y (A1P).

3.12 “EJ” Indoor Unit: Malfunction of Thermostat Sensor in remote control

remote control
Display

EJ

Applicable
Models

All indoor unit models

Method of
Malfunction
Detection

Malfunction detection is carried out by temperature detected by remote control air temperature thermistor. (Note:)

Malfunction
Decision
Conditions

When the remote control air temperature thermistor becomes disconnected or shorted while the unit is running.

Supposed
Causes

- Defect of remote control thermistor
- Defect of remote control PC board

Troubleshooting



Caution

Be sure to turn off power switch before connect or disconnect connector, or parts damage may be occurred.

Clear the malfunction code history. (While in inspection mode, press and hold the “ON/OFF” button for a period of five seconds or more.)

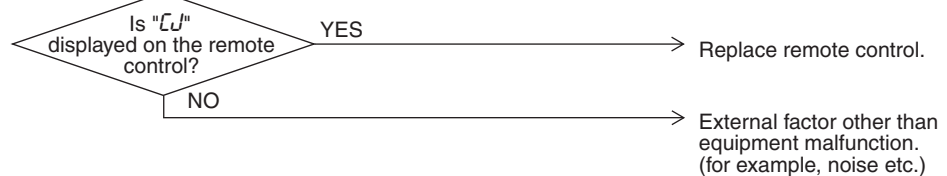

Note:

In case of remote control thermistor malfunction, unit is still operable by suction air thermistor on indoor unit.



* Refer to “Thermistor Resistance / Temperature Characteristics” table on P.247.

3.13 “E1” Outdoor Unit: PC Board Defect

remote control Display	E1
Applicable Models	CMSQ200A7, 250A7
Method of Malfunction Detection	Check data from E ² PROM
Malfunction Decision Conditions	When data could not be correctly received from the E ² PROM E ² PROM : Type of nonvolatile memory. Maintains memory contents even when the power supply is turned off.
Supposed Causes	<ul style="list-style-type: none"> Defect of outdoor unit PC board (A1P)

Troubleshooting



Caution

Be sure to turn off power switch before connect or disconnect connector, or parts damage may be occurred.



3.14 “E3” Outdoor Unit: Actuation of High Pressure Switch

remote control Display	E3
Applicable Models	CMSQ200A7, 250A7
Method of Malfunction Detection	Abnormality is detected when the contact of the high pressure protection switch opens.
Malfunction Decision Conditions	Error is generated when the HPS activation count reaches the number specific to the operation mode. (Reference) Operating pressure of high pressure switch Operating pressure: 4.0MPa Reset pressure: 2.85MPa
Supposed Causes	<ul style="list-style-type: none"> ■ Actuation of outdoor unit high pressure switch ■ Defect of High pressure switch ■ Defect of outdoor unit PC board ■ Instantaneous power failure ■ Faulty high pressure sensor

Troubleshooting



Caution

Be sure to turn off power switch before connect or disconnect connector, or parts damage may be occurred.

Check for the points shown below.
 ① Is the stop valve open?
 ② Is the HPS connector properly connected to the main PC board?
 ③ Does the high pressure switch have continuity?



· Mount a pressure gauge on the high-pressure service port.
 · Connect the Service Checker.
 · Reset the operation using the remote control, and then restart the operation.

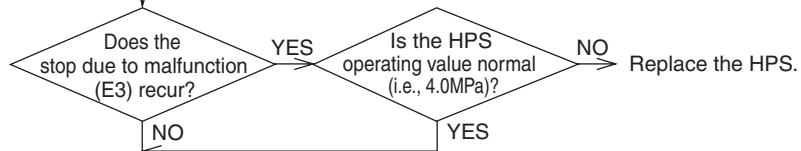

· The high pressure sensor is normal, and the pressure detected with the PC board is also normal.
 · The high pressure has really become high.

CHECK 3 Referring to information on page 227, remove the causes by which the high pressure has become high.

- *1: Make a comparison between the voltage of the pressure sensor and that read by the pressure gauge.
 (As to the voltage of the pressure sensor, make measurement of voltage at the connector, and then convert it to pressure according to information on page 249.)
- *2: Make a comparison between the high pressure value checked with the Service Checker and the voltage of the pressure sensor (see *1).
- *3: Make measurement of voltage of the pressure sensor.

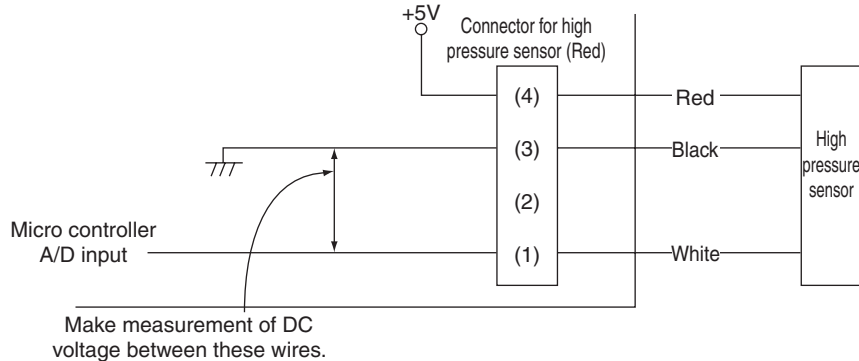

3.15 “E4” Outdoor Unit: Actuation of Low Pressure Sensor

remote control
Display

E4

Applicable
Models

CMSQ200A7, 250A7

Method of
Malfunction
Detection

Abnormality is detected by the pressure value with the low pressure sensor.

Malfunction
Decision
Conditions

Error is generated when the low pressure is dropped under specific pressure.
Operating pressure:0.07MPa

Supposed
Causes

- Abnormal drop of low pressure (Lower than 0.07MPa)
- Defect of low pressure sensor
- Defect of outdoor unit PC board
- Stop valve is not opened.

Troubleshooting



Caution

Be sure to turn off power switch before connect or disconnect connector, or parts damage may be occurred.

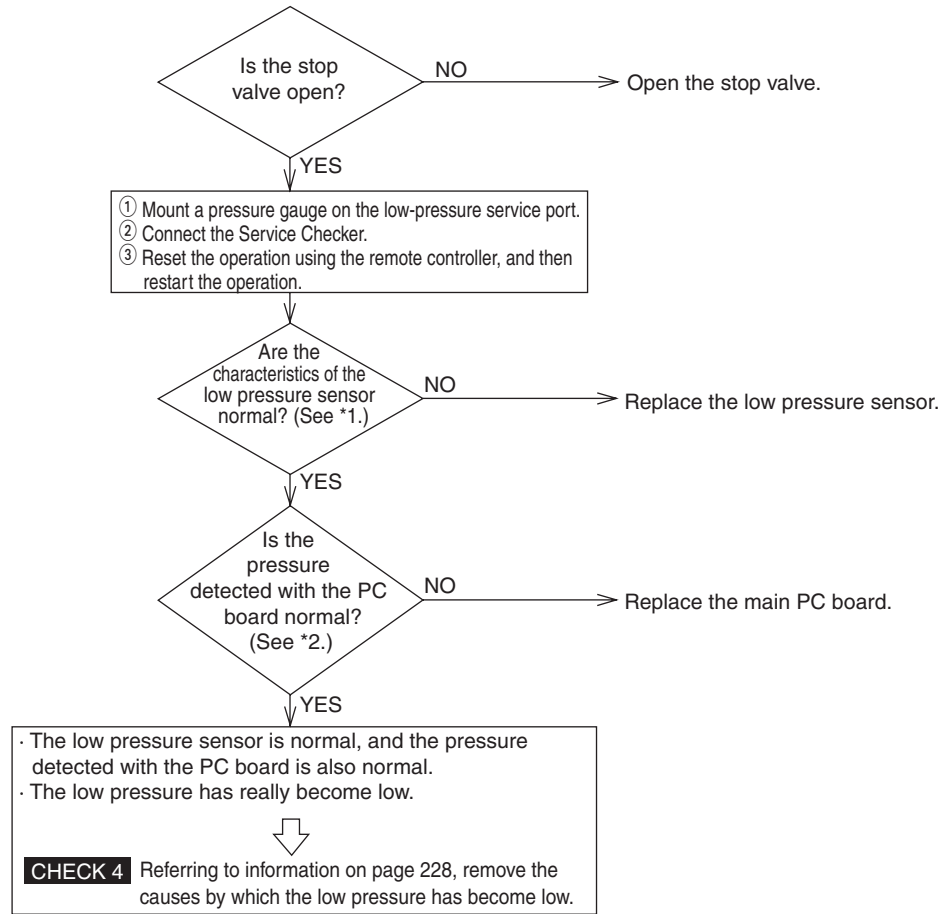

- *1: Make a comparison between the voltage of the pressure sensor and that read by the pressure gauge.
(As to the voltage of the pressure sensor, make measurement of voltage at the connector, and then convert it to pressure according to information on page 249.)
- *2: Make a comparison between the low pressure value checked with the Service Checker and the voltage of the pressure sensor (see *1).
- *3: Make measurement of voltage of the pressure sensor.

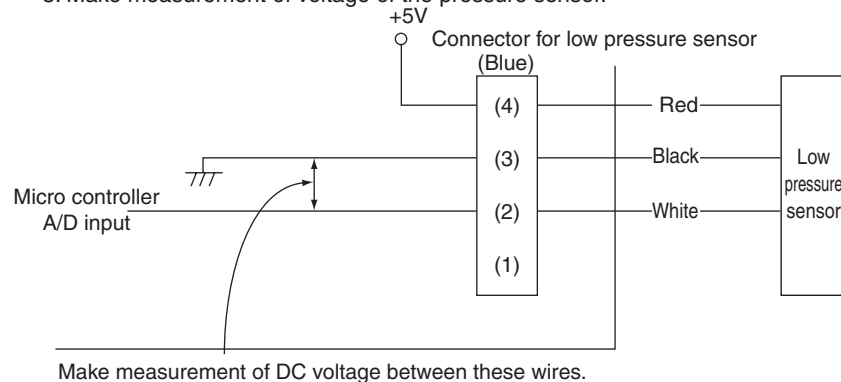

3.16 “E5” Outdoor Unit: Inverter Compressor Motor Lock

remote control Display	E5
Applicable Models	CMSQ200A7, 250A7
Method of Malfunction Detection	Inverter PC board takes the position signal from UVW line connected between the inverter and compressor, and the malfunction is detected when any abnormality is observed in the phase-current waveform.
Malfunction Decision Conditions	This malfunction will be output when the inverter compressor motor does not start up even in forced startup mode.
Supposed Causes	<ul style="list-style-type: none"> ■ Inverter compressor lock ■ High differential pressure (0.5MPa or more) ■ Incorrect UVW wiring ■ Faulty inverter PC board ■ Stop valve is left in closed.

Troubleshooting



Caution

Be sure to turn off power switch before connect or disconnect connector, or parts damage may be occurred.

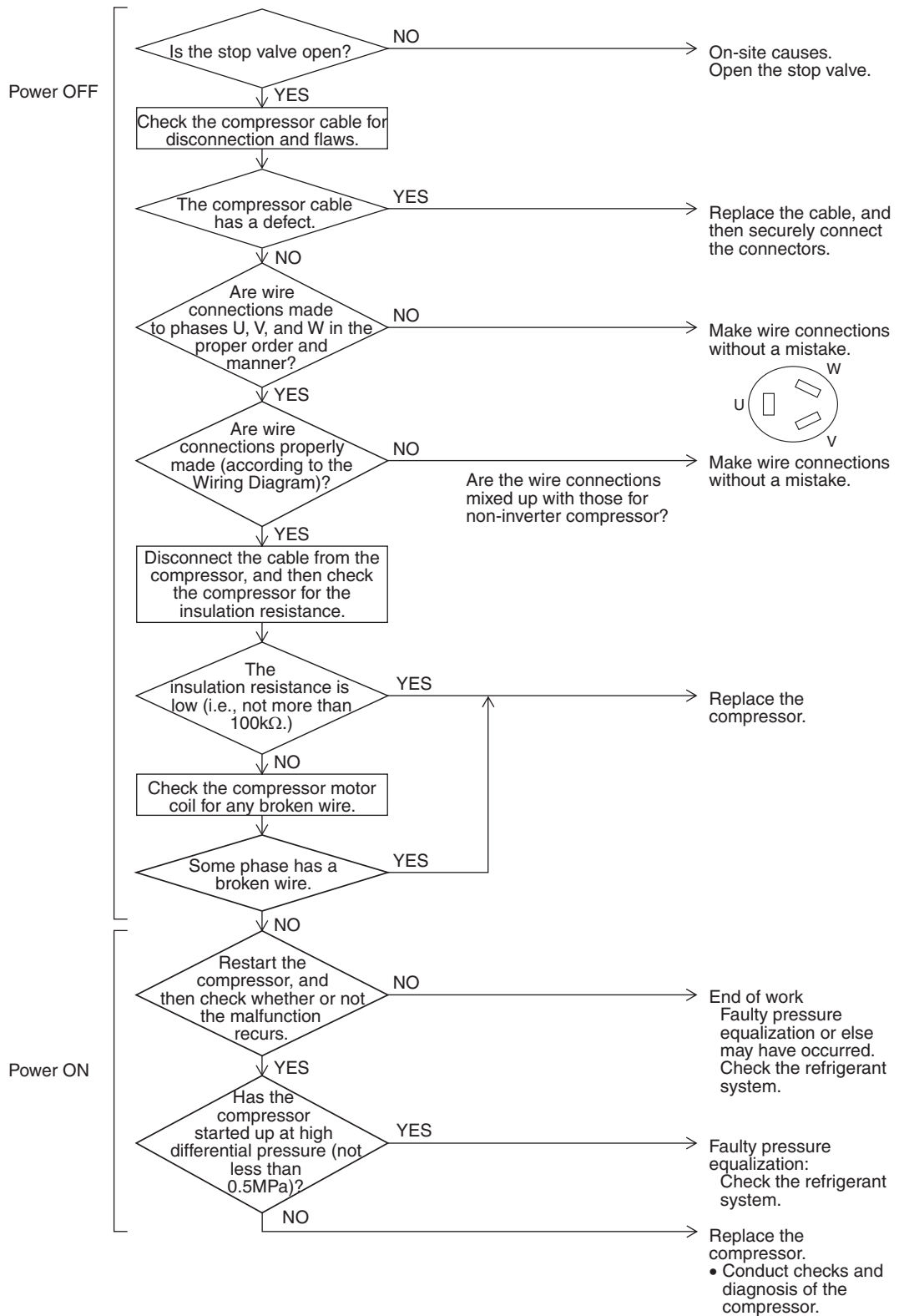

3.17 “E7” Outdoor Unit: Malfunction of Outdoor Unit Fan Motor

remote control Display	<i>E7</i>
Applicable Models	CMSQ200A7, 250A7
Method of Malfunction Detection	Malfunction of fan motor system is detected according to the fan speed detected by hall IC when the fan motor runs.
Malfunction Decision Conditions	<ul style="list-style-type: none"> ■ When the fan runs with speed less than a specified one for 6 seconds or more when the fan motor running conditions are met ■ When connector detecting fan speed is disconnected ■ When malfunction is generated 4 times, the system shuts down.
Supposed Causes	<ul style="list-style-type: none"> ■ Malfunction of fan motor ■ The harness connector between fan motor and PC board is left in disconnected, or faulty connector ■ Fan does not run due to foreign matters tangled ■ Clearing condition: Operate for 5 minutes (normal)

Troubleshooting



Caution

Be sure to turn off power switch before connect or disconnect connector, or parts damage may be occurred.

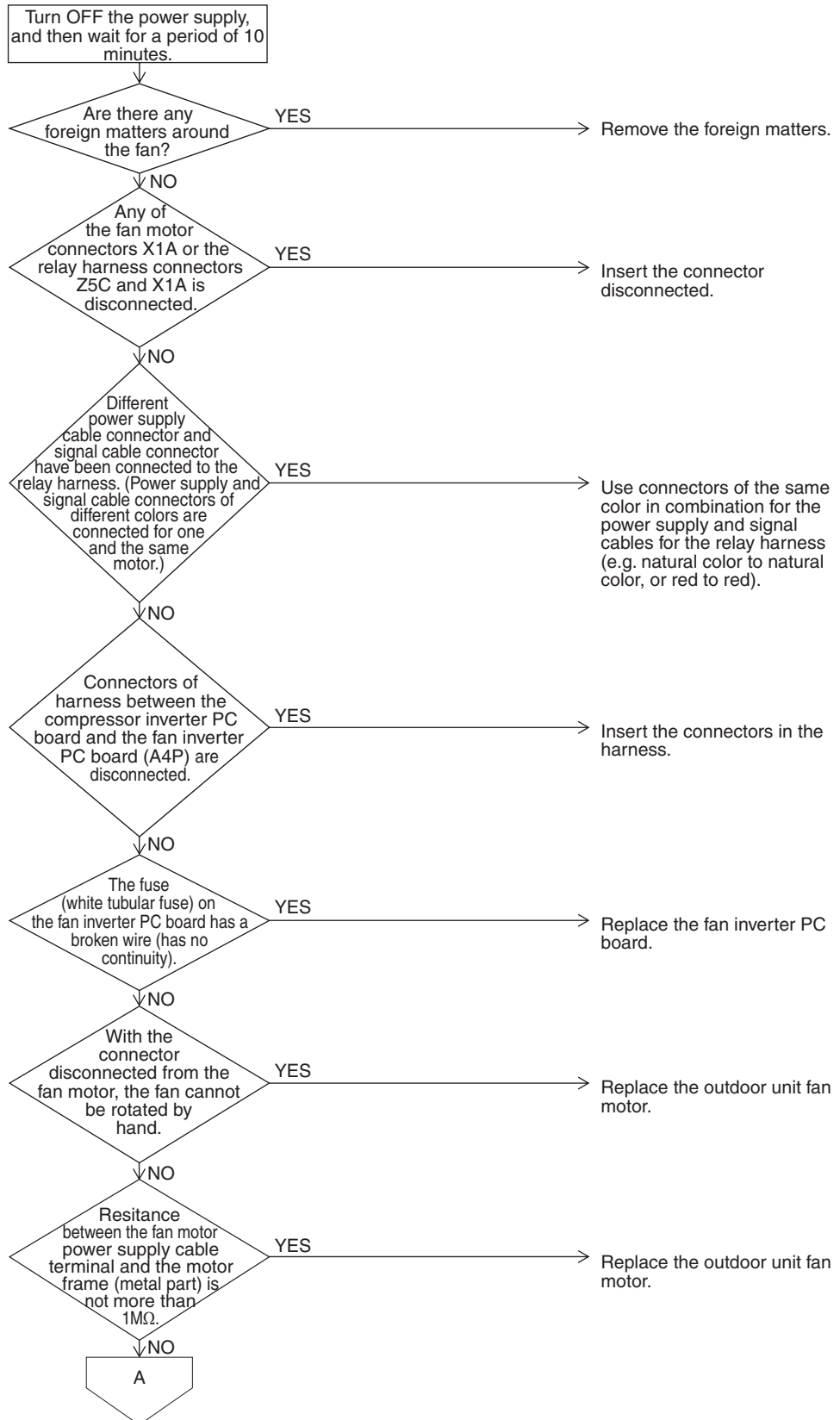

Troubleshooting

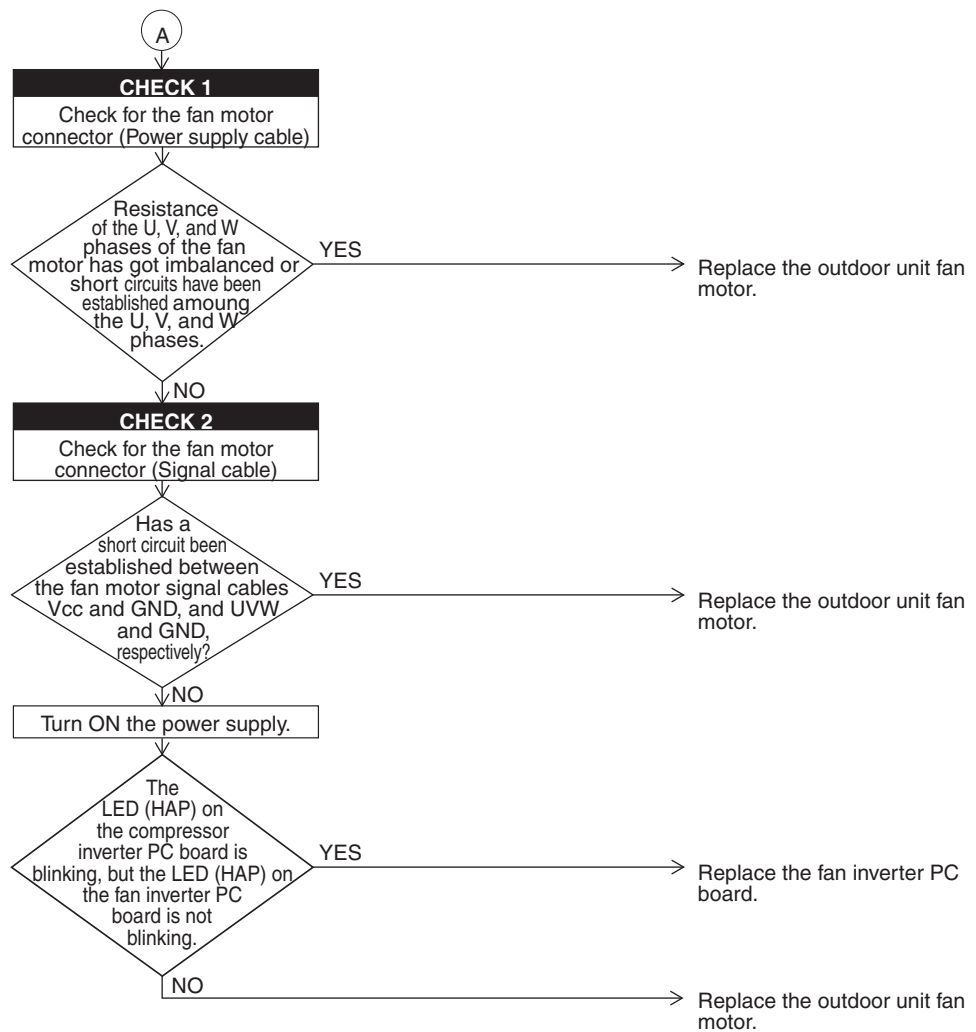

i **Note:** Refer to **CHECK 1** and **CHECK 2** on P.226.

3.18 “E9” Outdoor Unit: Malfunction of Moving Part of Electronic Expansion Valve (Y1E, Y2E)

remote control Display	E9
Applicable Models	CMSQ200A7, 250A7
Method of Malfunction Detection	Check disconnection of connector Check continuity of expansion valve coil
Malfunction Decision Conditions	Error is generated under no common power supply when the power is on.
Supposed Causes	<ul style="list-style-type: none"> ■ Defect of moving part of electronic expansion valve ■ Defect of outdoor unit PC board (A1P) ■ Defect of connecting cable

Troubleshooting



Caution

Be sure to turn off power switch before connect or disconnect connector, or parts damage may be occurred.

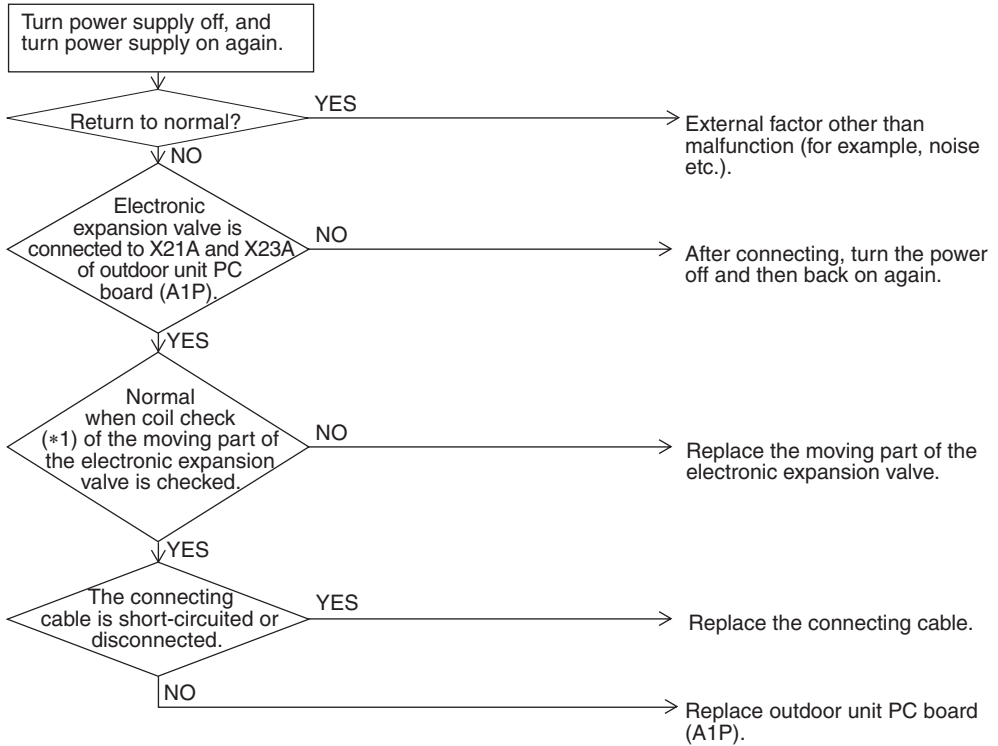

*Make measurement of resistance between the connector pins, and then make sure the resistance falls in the range of 40 to 50Ω.

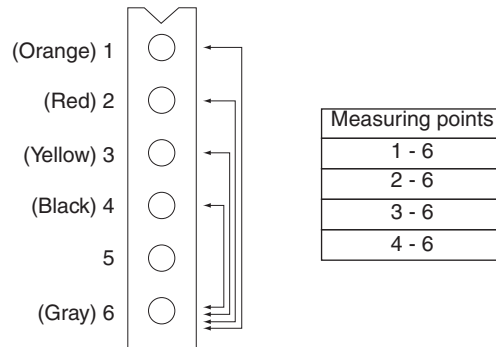

3.19 “F3” Outdoor Unit: Abnormal Discharge Pipe Temperature

remote control Display	F3
Applicable Models	CMSQ200A7, 250A7
Method of Malfunction Detection	Abnormality is detected according to the temperature detected by the discharge pipe temperature sensor.
Malfunction Decision Conditions	When the discharge pipe temperature rises to an abnormally high level When the discharge pipe temperature rises suddenly
Supposed Causes	<ul style="list-style-type: none"> ■ Faulty discharge pipe temperature sensor ■ Faulty connection of discharge pipe temperature sensor ■ Faulty outdoor unit PC board

Troubleshooting



Caution Be sure to turn off power switch before connect or disconnect connector, or parts damage may be occurred.

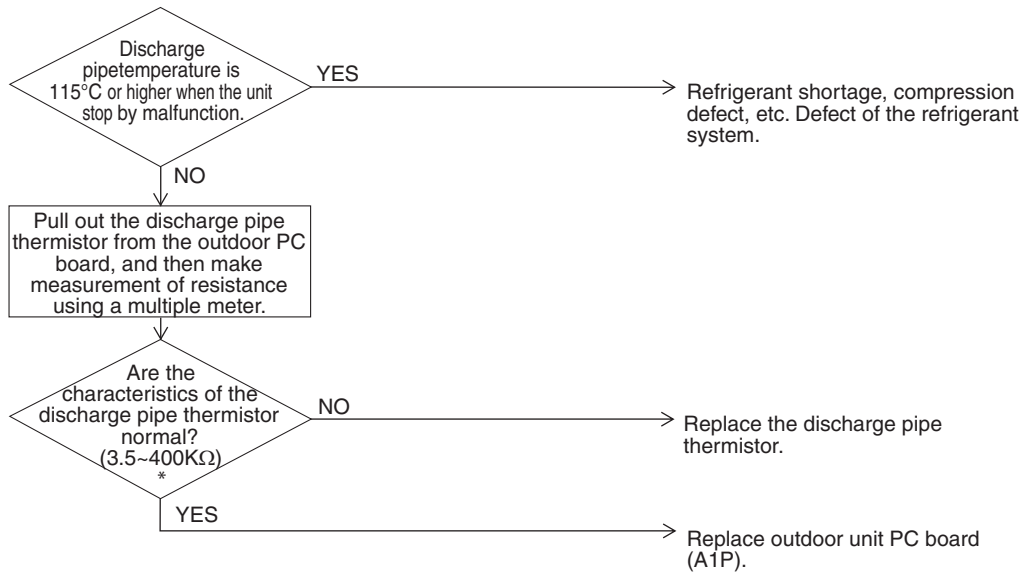

* Refer to “Thermistor Resistance / Temperature Characteristics” table on P.247.

3.20 “F6” Outdoor Unit: Refrigerant Overcharged

remote control Display	F6
Applicable Models	CMSQ200A7, 250A7
Method of Malfunction Detection	Excessive charging of refrigerant is detected by using the outside air temperature, heat exchanging deicer temperature and liquid pipe temperature during a check run.
Malfunction Decision Conditions	When the amount of refrigerant, which is calculated by using the outside air temperature, heat exchanging deicer temperature and liquid pipe temperature during a check run, exceeds the standard.
Supposed Causes	<ul style="list-style-type: none"> ■ Refrigerant overcharge ■ Misalignment of the outside air thermistor ■ Misalignment of the heat exchanging deicer thermistor ■ Misalignment of the liquid pipe thermistor

Troubleshooting

Caution

Be sure to turn off power switch before connect or disconnect connector, or parts damage may be occurred.

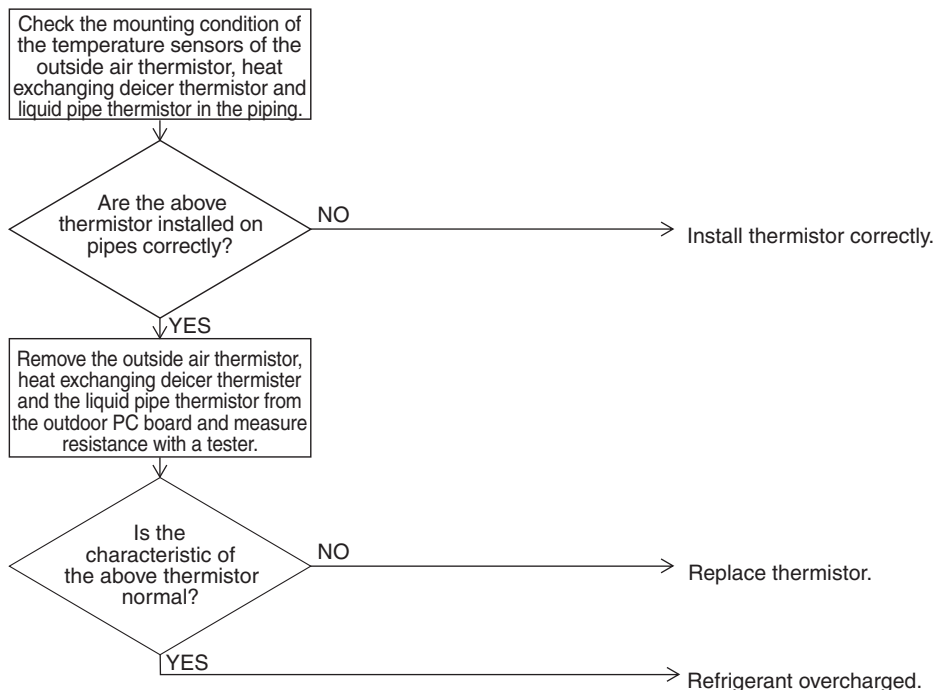

* Refer to “Thermistor Resistance / Temperature Characteristics” table on P.247.

3.21 “H7” Outdoor Unit: Abnormal Outdoor Fan Motor Signal

remote control Display	H7
Applicable Models	CMSQ200A7, 250A7
Method of Malfunction Detection	Detection of abnormal signal from fan motor.
Malfunction Decision Conditions	In case of detection of abnormal signal at starting fan motor.
Supposed Causes	<ul style="list-style-type: none"> ■ Abnormal fan motor signal (circuit malfunction) ■ Broken, short or disconnection connector of fan motor connection cable ■ Fan Inverter PC board malfunction

Troubleshooting

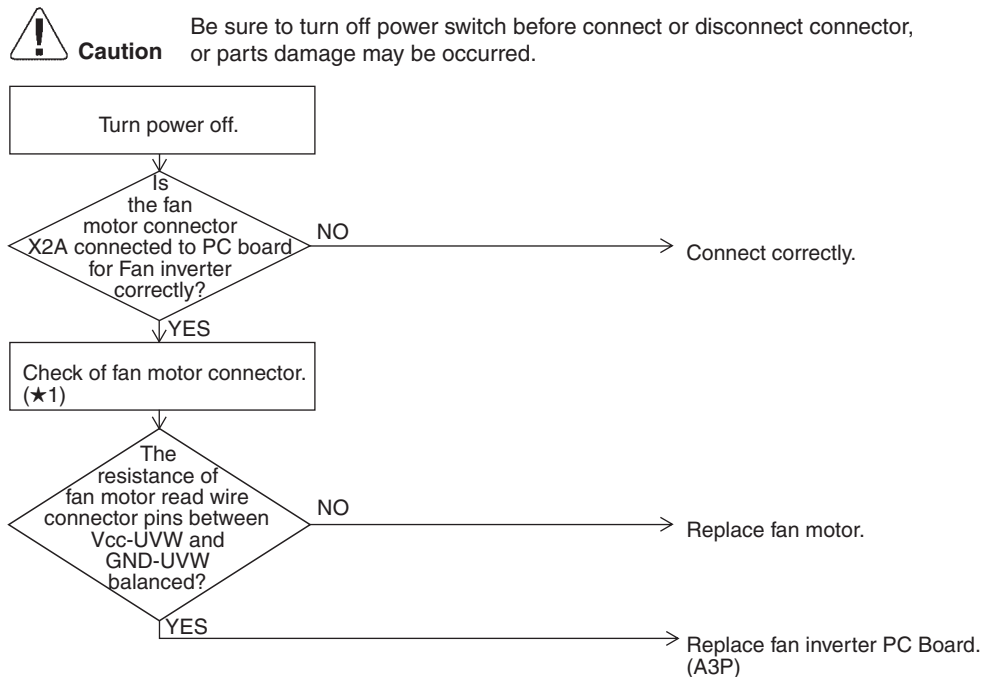

★1: Disconnect connector (X2A) and measure the following resistance.

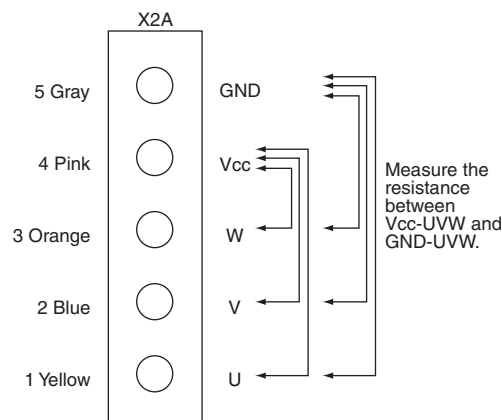

3.22 “H9” Outdoor Unit: Malfunction of Thermistor (R1T) for Outdoor Air

remote control
Display

H9

Applicable
Models

CMSQ200A7, 250A7

Method of
Malfunction
Detection

Malfunction is detected from the temperature detected by the outdoor air thermistor.

Malfunction
Decision
Conditions

When the outside air temperature thermistor has short circuit or open circuit.

Supposed
Causes

- Defect of thermistor (R1T) for outdoor air
- Defect of outdoor unit PC board (A1P)

Troubleshooting



Caution

Be sure to turn off power switch before connect or disconnect connector, or parts damage may be occurred.

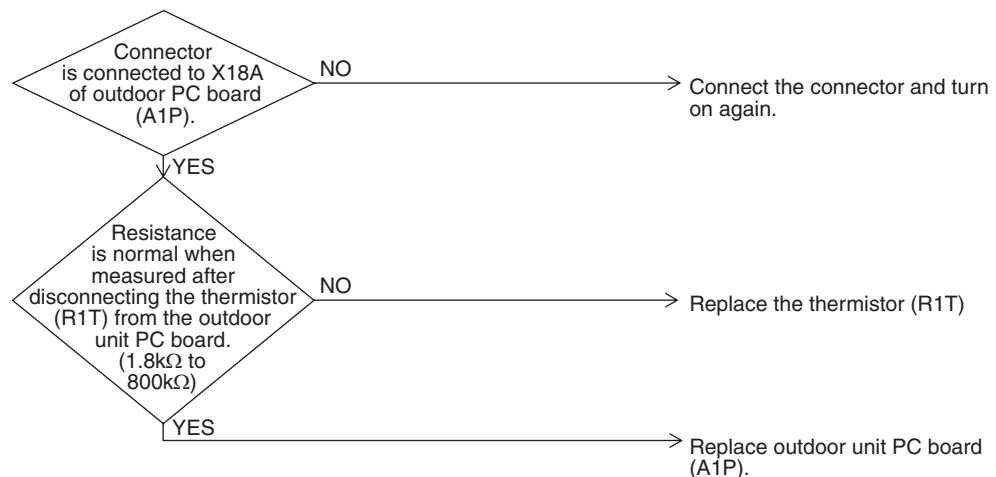

* Refer to “Thermistor Resistance / Temperature Characteristics” table on P.247.

3.23 “J3” Outdoor Unit: Malfunction of Discharge Pipe Thermistor (R3T)

remote control Display	J3
Applicable Models	CMSQ200A7, 250A7
Method of Malfunction Detection	Malfunction is detected from the temperature detected by discharge pipe temperature thermistor.
Malfunction Decision Conditions	When a short circuit or an open circuit in the discharge pipe temperature thermistor is detected.
Supposed Causes	<ul style="list-style-type: none"> ■ Defect of thermistor (R3T) for outdoor unit discharge pipe ■ Defect of outdoor unit PC board (A1P) ■ Defect of thermistor connection

Troubleshooting

 **Caution** Be sure to turn off power switch before connect or disconnect connector, or parts damage may be occurred.

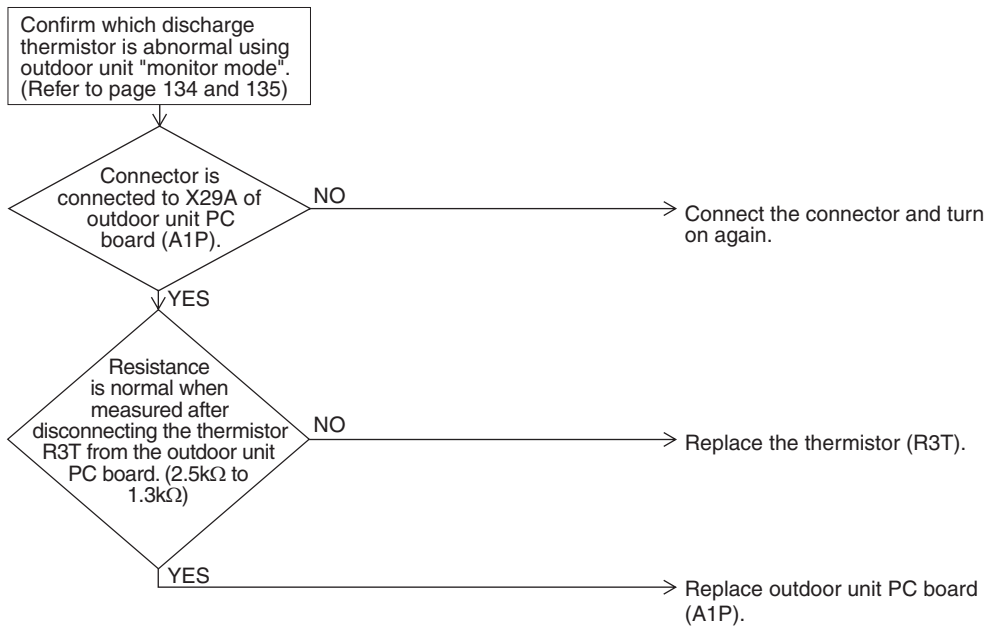

The alarm indicator is displayed when the fan is being used also.



* Refer to “Thermistor Resistance / Temperature Characteristics” table on P.248.

3.24 “J5” Outdoor Unit: Malfunction of Thermistor (R2T, R7T) for Suction Pipe

remote control
Display

J5

Applicable
Models

CMSQ200A7, 250A7

Method of
Malfunction
Detection

Malfunction is detected from the temperature detected by the suction pipe temperature thermistor.

Malfunction
Decision
Conditions

When a short circuit or an open circuit in the suction pipe temperature thermistor is detected.

Supposed
Causes

- Defect of thermistor (R2T), (R7T) for outdoor unit suction pipe
- Defect of outdoor unit PC board (A1P)
- Defect of thermistor connection

Troubleshooting



Caution

Be sure to turn off power switch before connect or disconnect connector, or parts damage may be occurred.

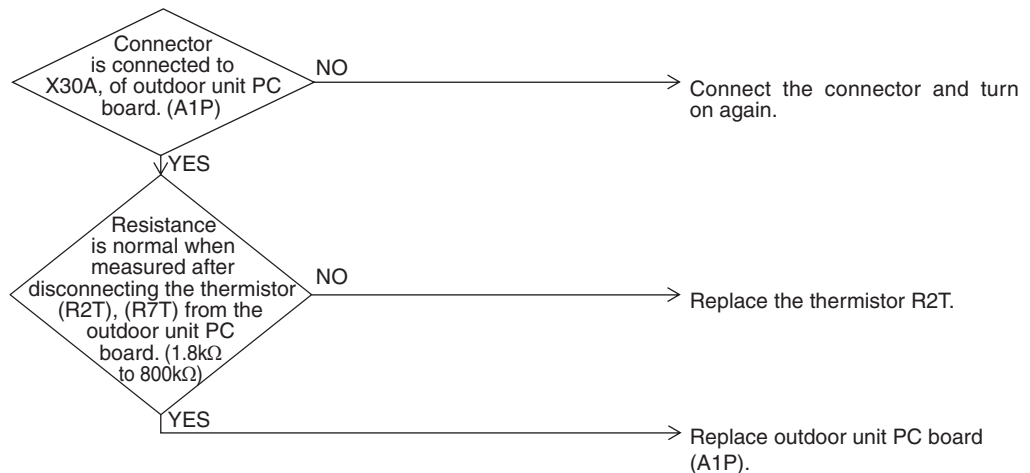

* Refer to “Thermistor Resistance / Temperature Characteristics” table on P.247.

3.25 “J5” Outdoor Unit: Malfunction of Thermistor (R4T) for Outdoor Unit Heat Exchanger

remote control Display	J5
Applicable Models	CMSQ200A7, 250A7
Method of Malfunction Detection	Malfunction is detected from the temperature detected by the heat exchanger thermistor.
Malfunction Decision Conditions	When a short circuit or an open circuit in the heat exchange thermistor is detected.
Supposed Causes	<ul style="list-style-type: none"> ■ Defect of thermistor (R4T) for outdoor unit coil ■ Defect of outdoor unit PC board (A1P) ■ Defect of thermistor connection

Troubleshooting

 **Caution** Be sure to turn off power switch before connect or disconnect connector, or parts damage may be occurred.

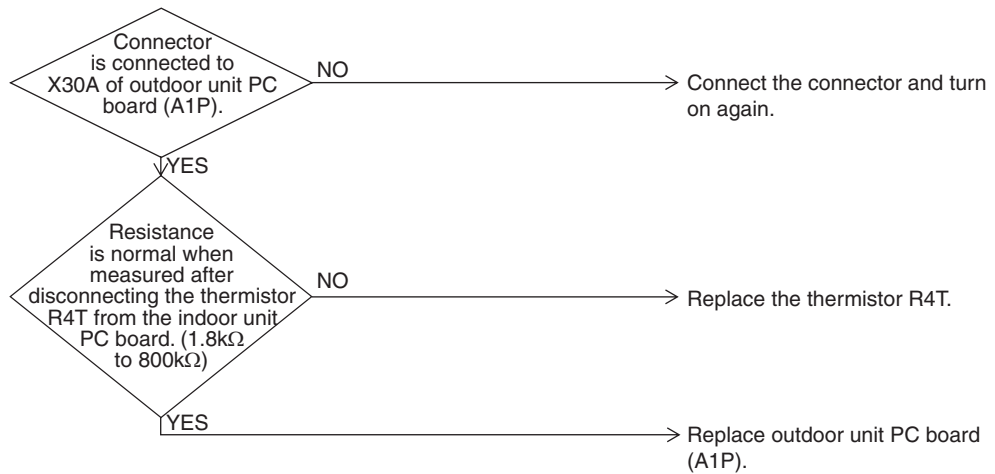

* Refer to “Thermistor Resistance / Temperature Characteristics” table on P.247.

3.26 “J7” Outdoor Unit: Malfunction of Liquid Pipe Thermistor (R6T)

remote control
Display

J7

Applicable
Models

CMSQ200A7, 250A7

Method of
Malfunction
Detection

Malfunction is detected according to the temperature detected by liquid pipe thermistor.

Malfunction
Decision
Conditions

When the liquid pipe thermistor is short circuited or open.

Supposed
Causes

- Faulty liquid pipe thermistor (R6T)
- Faulty outdoor unit PC board
- Defect of thermistor connection

Troubleshooting



Caution

Be sure to turn off power switch before connect or disconnect connector, or parts damage may be occurred.

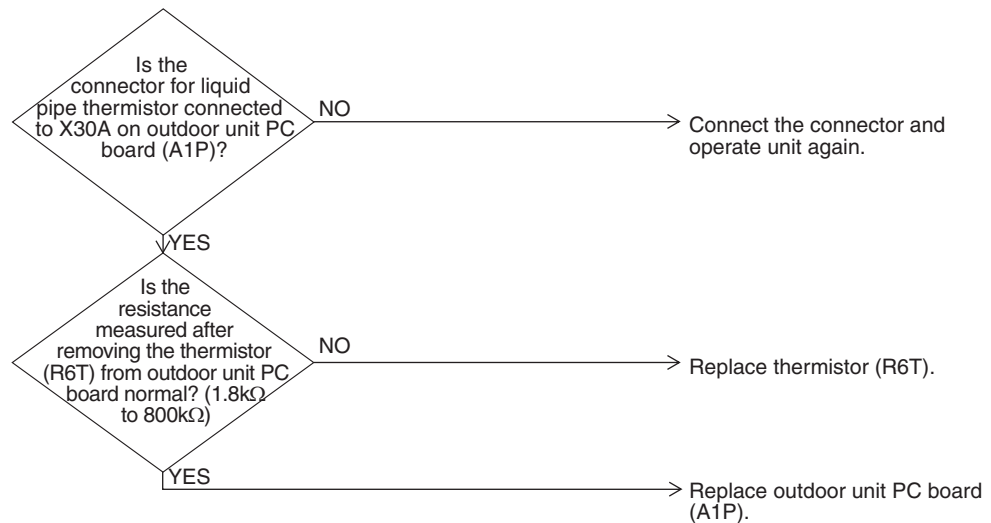

* Refer to “Thermistor Resistance / Temperature Characteristics” table on P.247.

3.27 “J9” Outdoor Unit: Malfunction of Subcooling Heat Exchanger Gas Pipe Thermistor (R5T)

remote control Display	J9
Applicable Models	CMSQ200A7, 250A7
Method of Malfunction Detection	Malfunction is detected according to the temperature detected by subcooling heat exchanger gas pipe thermistor.
Malfunction Decision Conditions	When the subcooling heat exchanger gas pipe thermistor is short circuited or open.
Supposed Causes	<ul style="list-style-type: none"> ■ Faulty subcooling heat exchanger gas pipe thermistor (R5T) ■ Faulty outdoor unit PC board

Troubleshooting

 **Caution** Be sure to turn off power switch before connect or disconnect connector, or parts damage may be occurred.

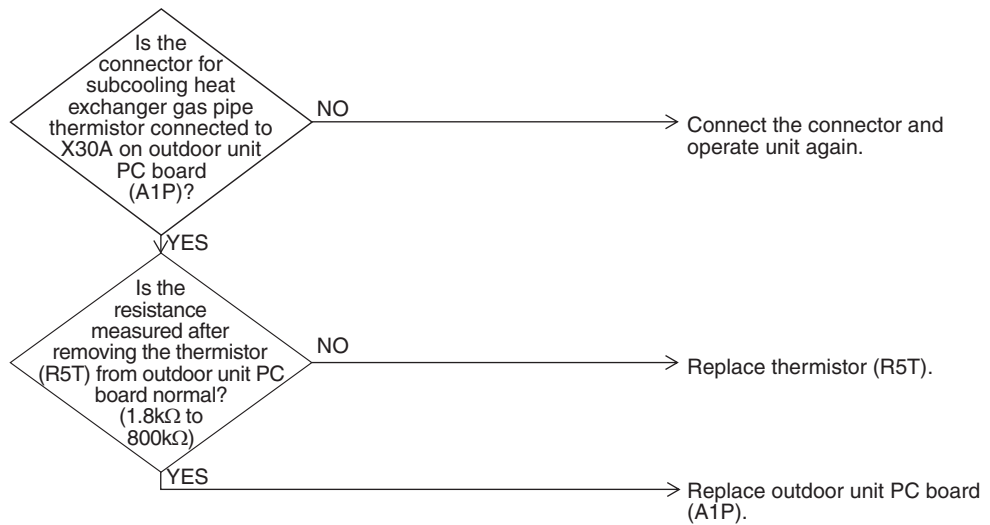

* Refer to “Thermistor Resistance / Temperature Characteristics” table on P.247.

3.28 “JA” Outdoor Unit: Malfunction of High Pressure Sensor

remote control
Display

JA

Applicable
Models

CMSQ200A7, 250A7

Method of
Malfunction
Detection

Malfunction is detected from the pressure detected by the high pressure sensor.

Malfunction
Decision
Conditions

When the high pressure sensor is short circuit or open circuit.

Supposed
Causes

- Defect of high pressure sensor system
- Connection of low pressure sensor with wrong connection.
- Defect of outdoor unit PC board.

Troubleshooting



Caution

Be sure to turn off power switch before connect or disconnect connector, or parts damage may be occurred.

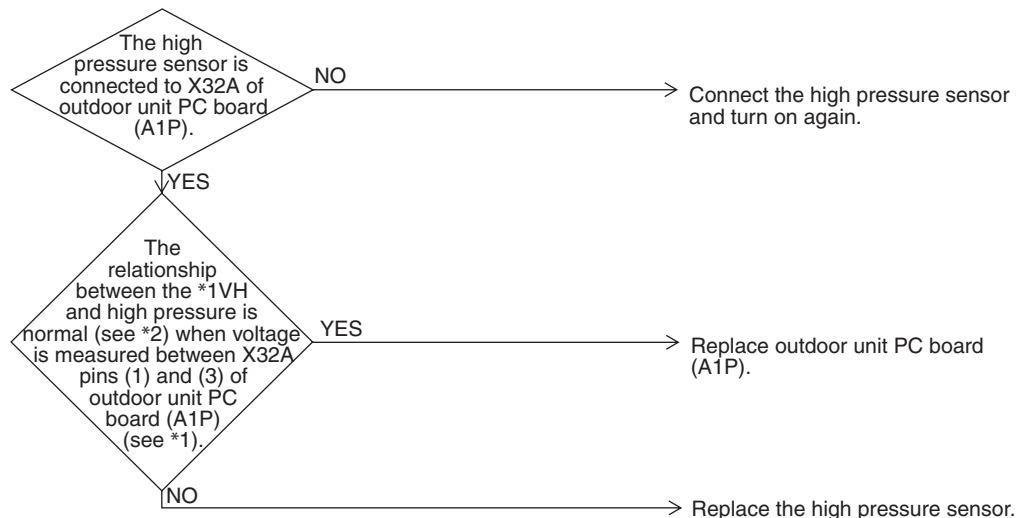

*1: Voltage measurement point

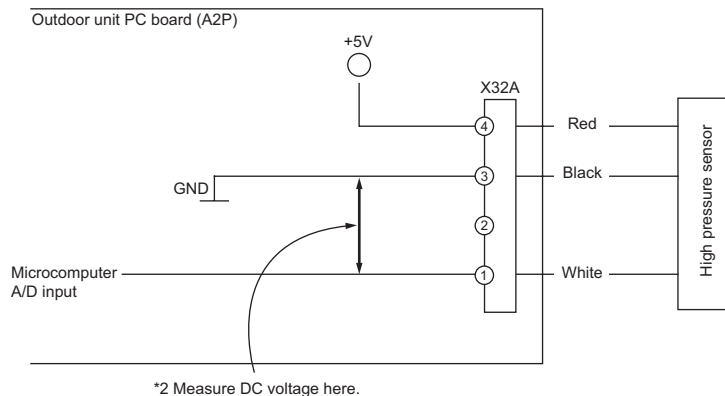

*2: Refer to “Pressure Sensor, Pressure / Voltage Characteristics” table on P.249.

3.29 “JL” Outdoor Unit: Malfunction of Low Pressure Sensor

remote control Display	JL
Applicable Models	CMSQ200A7, 250A7
Method of Malfunction Detection	Malfunction is detected from pressure detected by low pressure sensor.
Malfunction Decision Conditions	When the low pressure sensor is short circuit or open circuit.
Supposed Causes	<ul style="list-style-type: none"> ■ Defect of low pressure sensor system ■ Connection of high pressure sensor with wrong connection. ■ Defect of outdoor unit PC board.

Troubleshooting

 **Caution** Be sure to turn off power switch before connect or disconnect connector, or parts damage may be occurred.

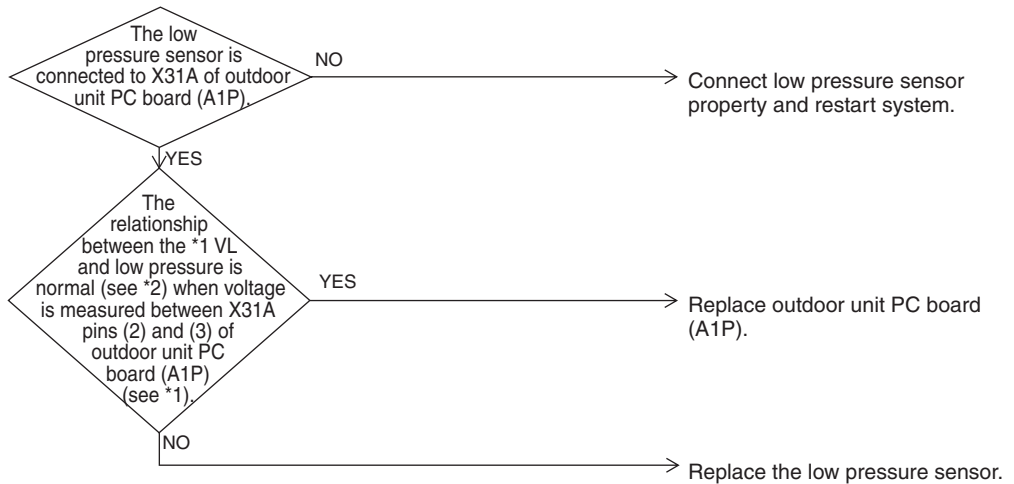

*1: Voltage measurement point

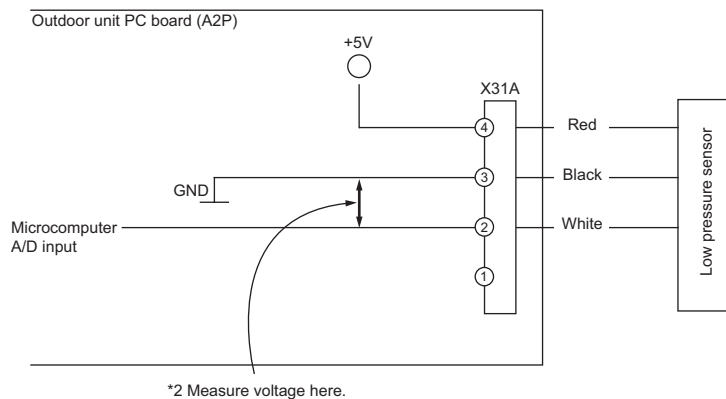

*2: Refer to “Pressure Sensor, Pressure / Voltage Characteristics” table on P.249.

3.30 “L4” Outdoor Unit: Malfunction of Inverter Radiating Fin Temperature Rise

remote control
Display

L4

Applicable
Models

CMSQ200A7, 250A7

Method of
Malfunction
Detection

Fin temperature is detected by the thermistor of the radiation fin.

Malfunction
Decision
Conditions

When the temperature of the inverter radiation fin increases above 93°C.

Supposed
Causes

- Actuation of fin thermal (Actuates above 93°C)
- Defect of inverter PC board
- Defect of fin thermistor

Troubleshooting



Caution

Be sure to turn off power switch before connect or disconnect connector, or parts damage may be occurred.

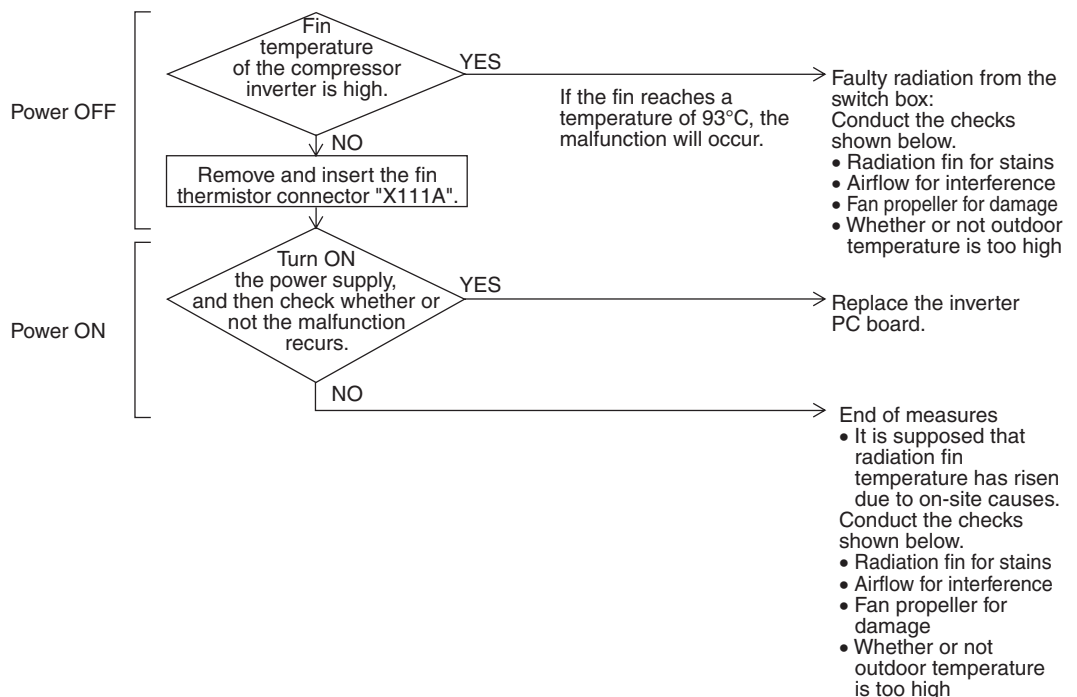

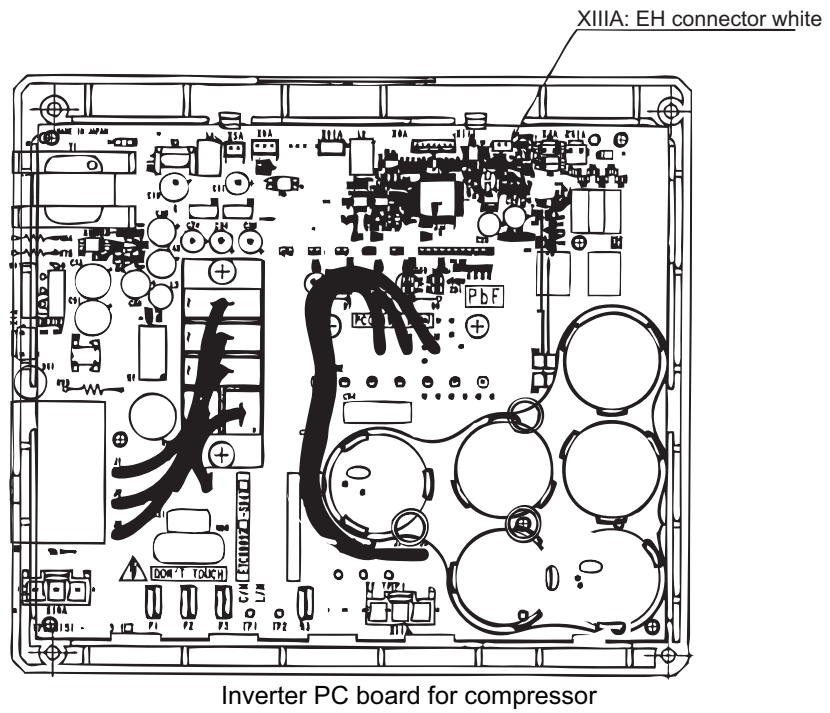

* Refer to "Thermistor Resistance / Temperature Characteristics" table on P.247.

3.31 “L5” Outdoor Unit: Inverter Compressor Abnormal

remote control Display	L5
Applicable Models	CMSQ200A7, 250A7
Method of Malfunction Detection	Malfunction is detected from current flowing in the power transistor.
Malfunction Decision Conditions	When an excessive current flows in the power transistor. (Instantaneous overcurrent also causes activation.)
Supposed Causes	<ul style="list-style-type: none"> ■ Defect of compressor coil (disconnected, defective insulation) ■ Compressor start-up malfunction (mechanical lock) ■ Defect of inverter PC board

Troubleshooting

Compressor inspection



Caution

Be sure to turn off power switch before connect or disconnect connector, or parts damage may be occurred.

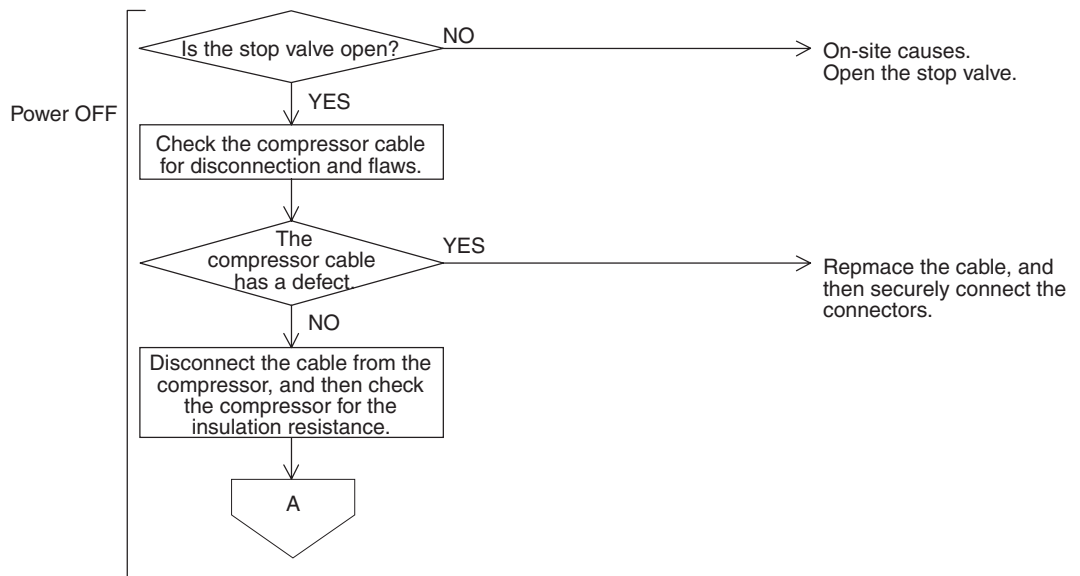

Troubleshooting

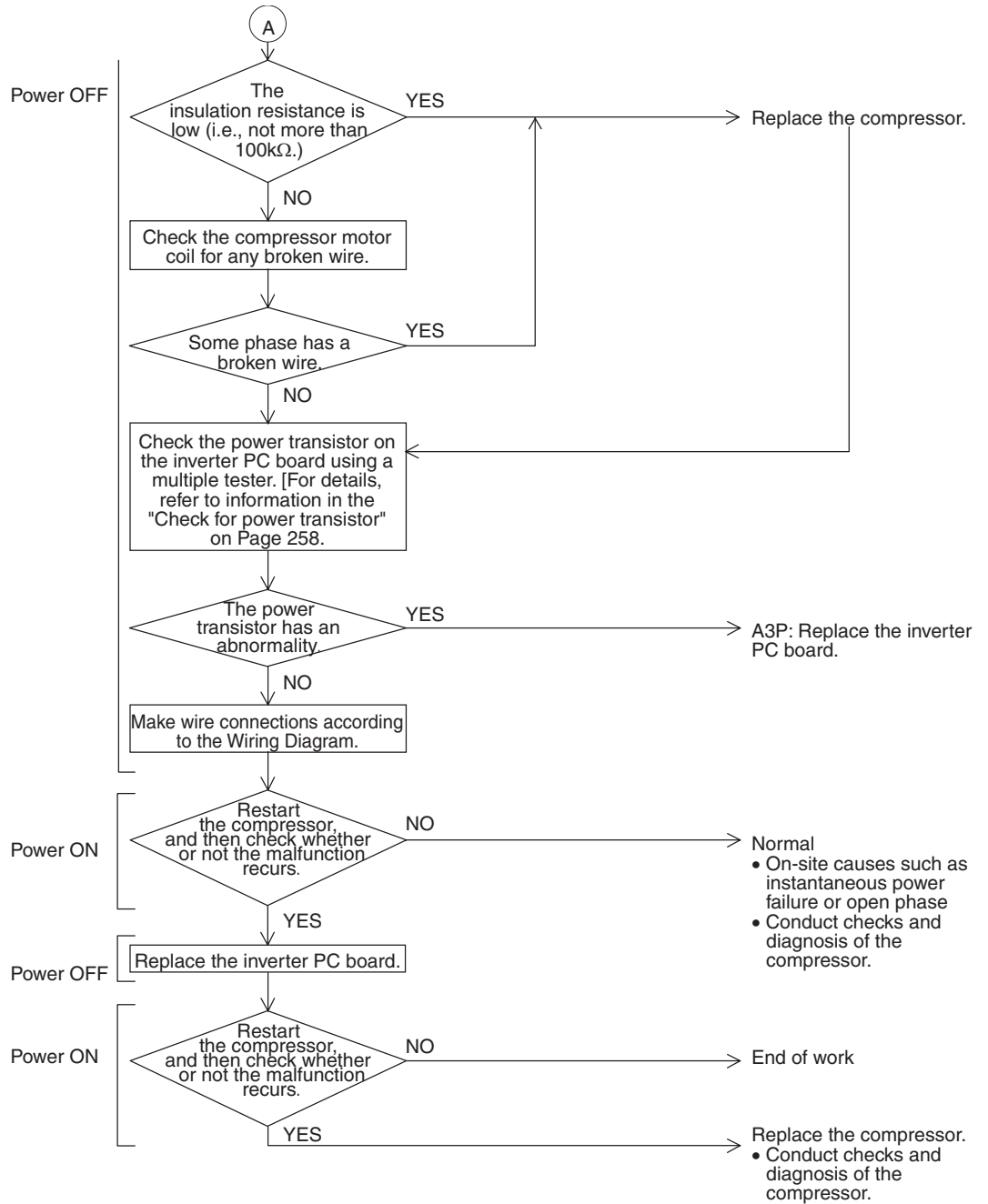

3.32 “L8” Outdoor Unit: Inverter Current Abnormal

remote control Display	L8
Applicable Models	CMSQ200A7, 250A7
Method of Malfunction Detection	Malfunction is detected by current flowing in the power transistor.
Malfunction Decision Conditions	When overload in the compressor is detected. (Inverter secondary current 16.1A)
Supposed Causes	<ul style="list-style-type: none"> ■ Compressor overload ■ Compressor coil disconnected ■ Defect of inverter PC board ■ Faulty compressor

Troubleshooting Output current check

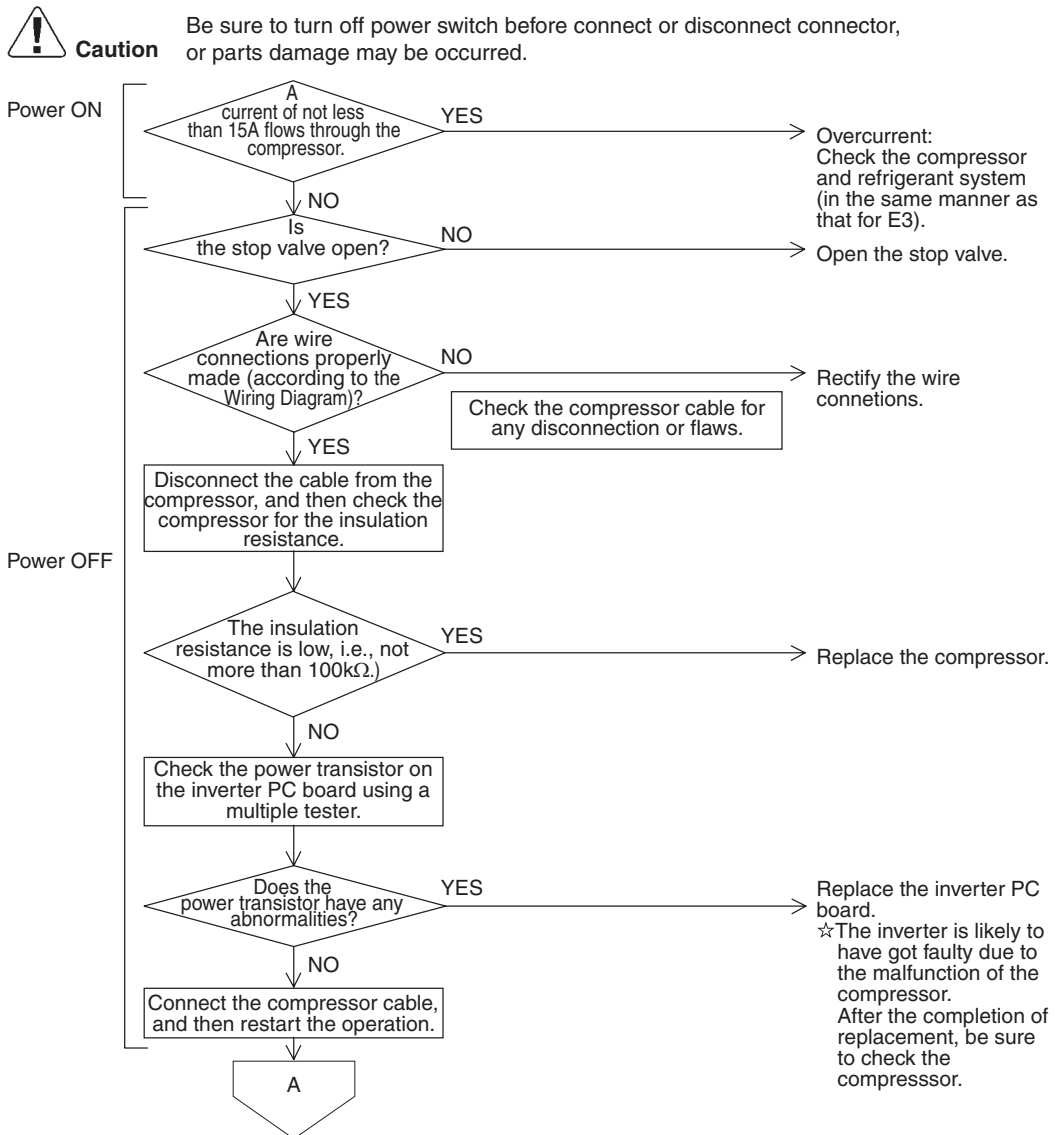

Troubleshooting

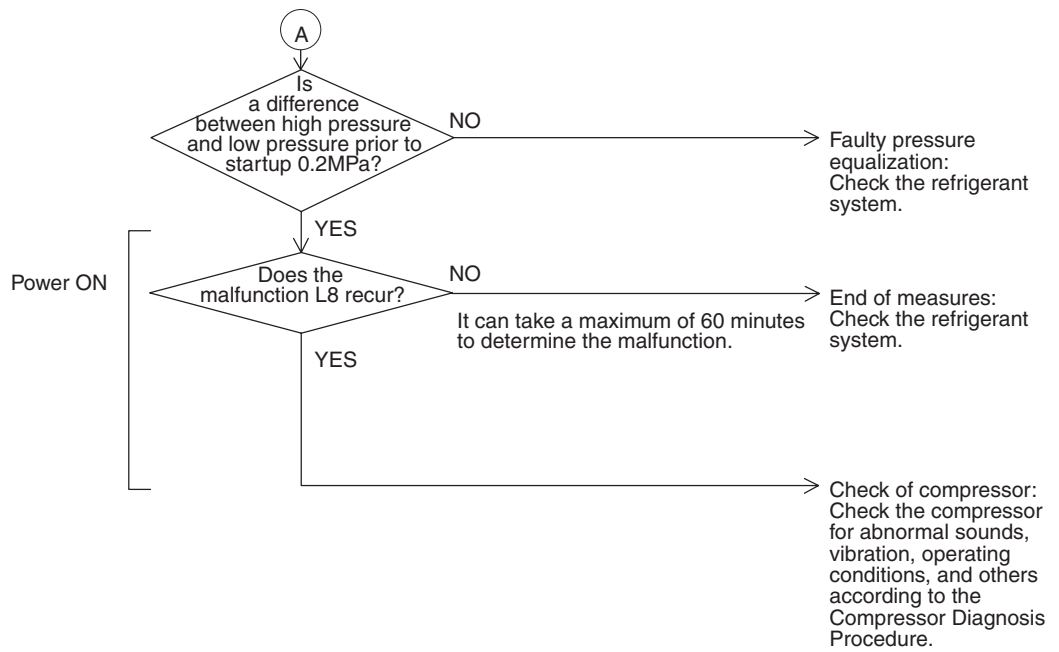

3.33 “L9” Outdoor Unit: Inverter Start Up Error

remote control Display	L9
Applicable Models	CMSQ200A7, 250A7
Method of Malfunction Detection	This malfunction code will be output if overcurrent occurs at the time of startup.
Malfunction Decision Conditions	When the startup control is failed. When an overcurrent is passed to the inverter due to the malfunction of a compressor or electrical system.
Supposed Causes	<ul style="list-style-type: none"> ■ Defect of compressor ■ Pressure differential start ■ Defect of inverter PC board ■ Failure to open the stop valve ■ Faulty compressor connection

Troubleshooting

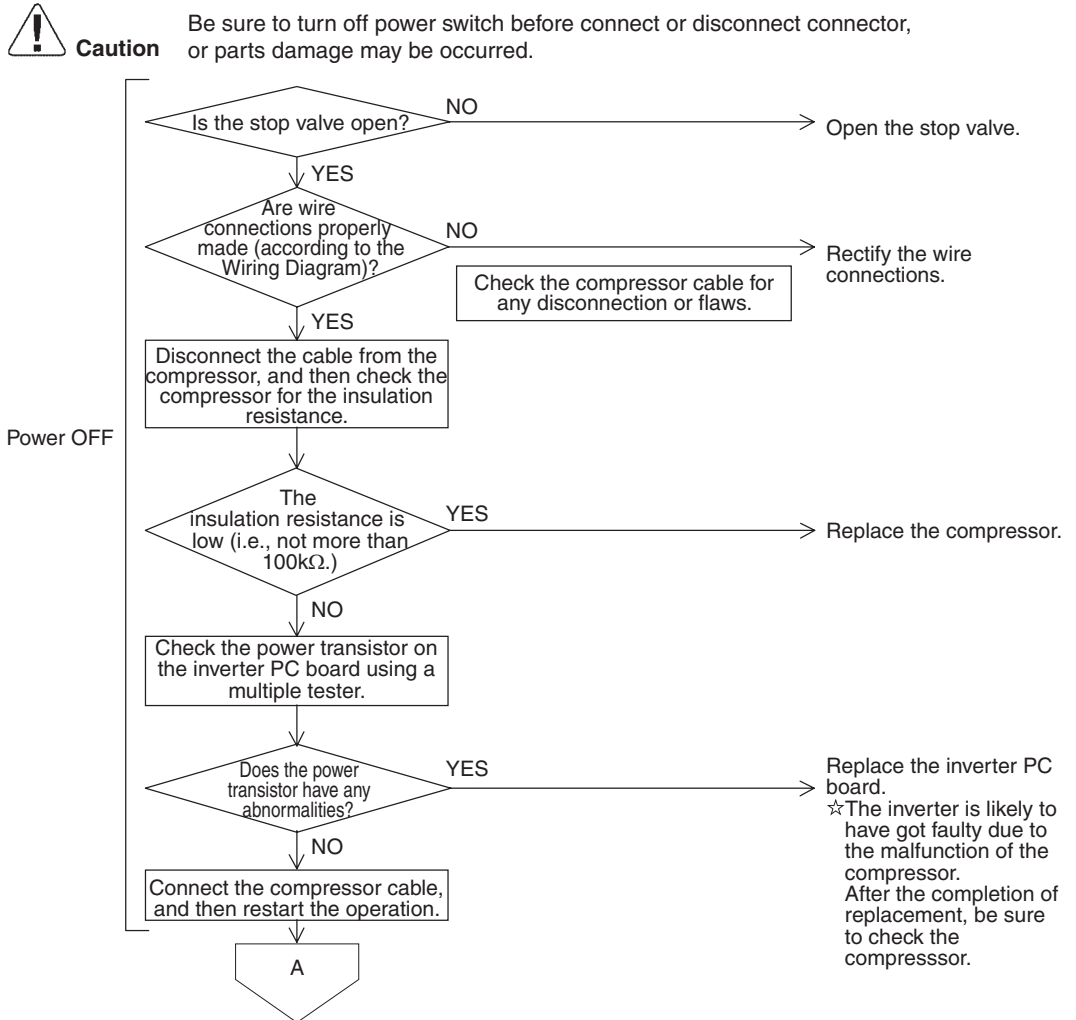

Troubleshooting

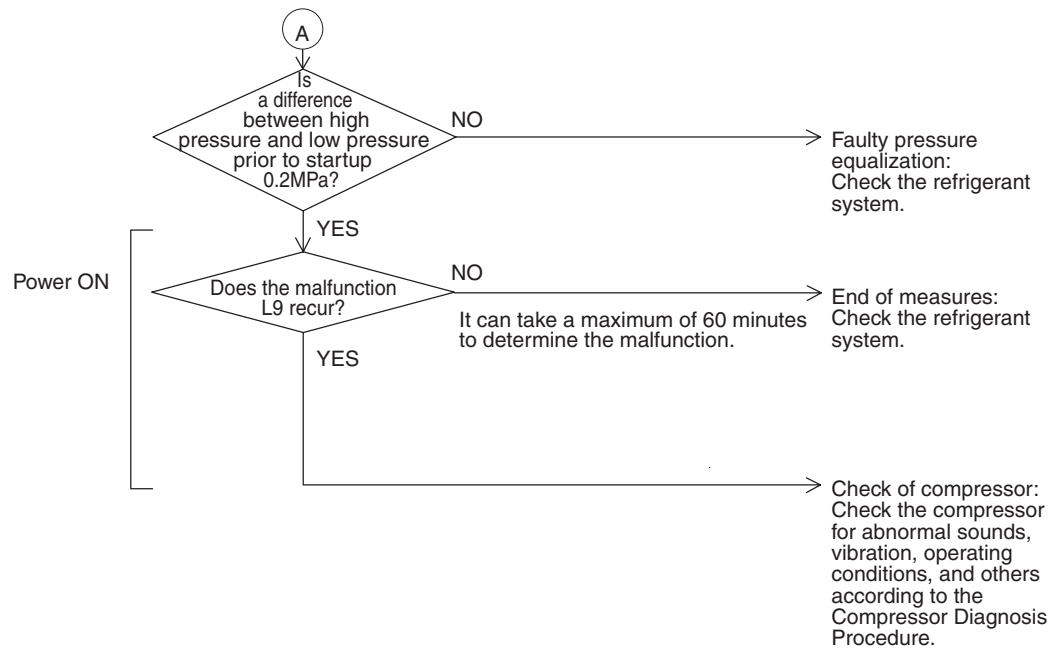

3.34 “LC” Outdoor Unit: Malfunction of Transmission Between Inverter and Control PC Board

remote control Display	LC
Applicable Models	CMSQ200A7, 250A7
Method of Malfunction Detection	Check the communication state between inverter PC board and control PC board by micro-computer.
Malfunction Decision Conditions	When the correct communication is not conducted in certain period.
Supposed Causes	<ul style="list-style-type: none"> ■ Malfunction of connection between the inverter PC board and outdoor control PC board ■ Defect of outdoor control PC board (transmission section) ■ Defect of inverter PC board ■ Defect of noise filter ■ Faulty fan inverter ■ Incorrect type of fan inverter ■ Faulty compressor ■ Faulty fan motor

Troubleshooting



Caution

Be sure to turn off power switch before connect or disconnect connector, or parts damage may be occurred.

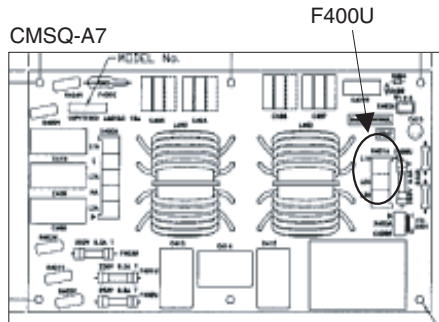
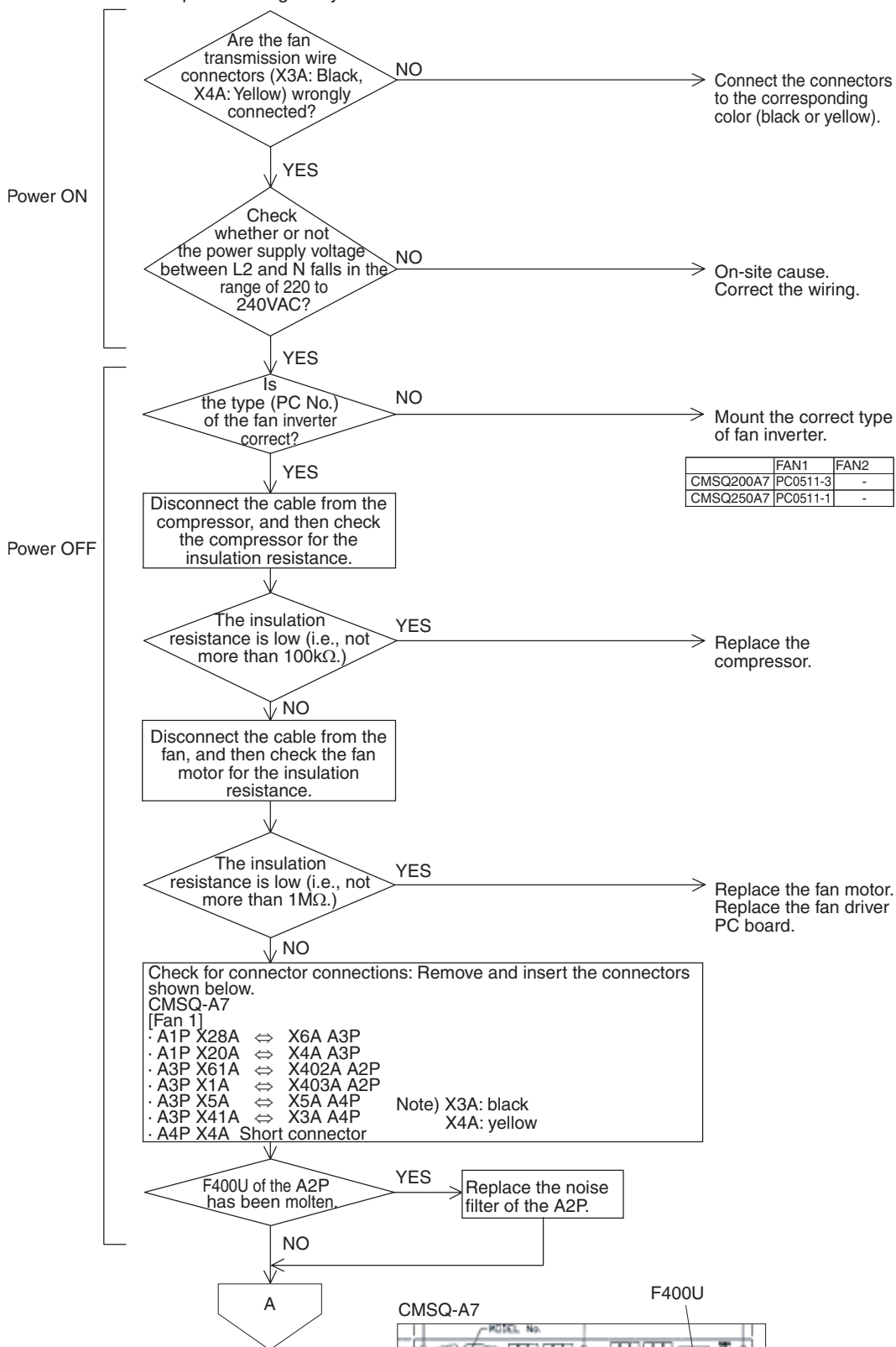

Troubleshooting

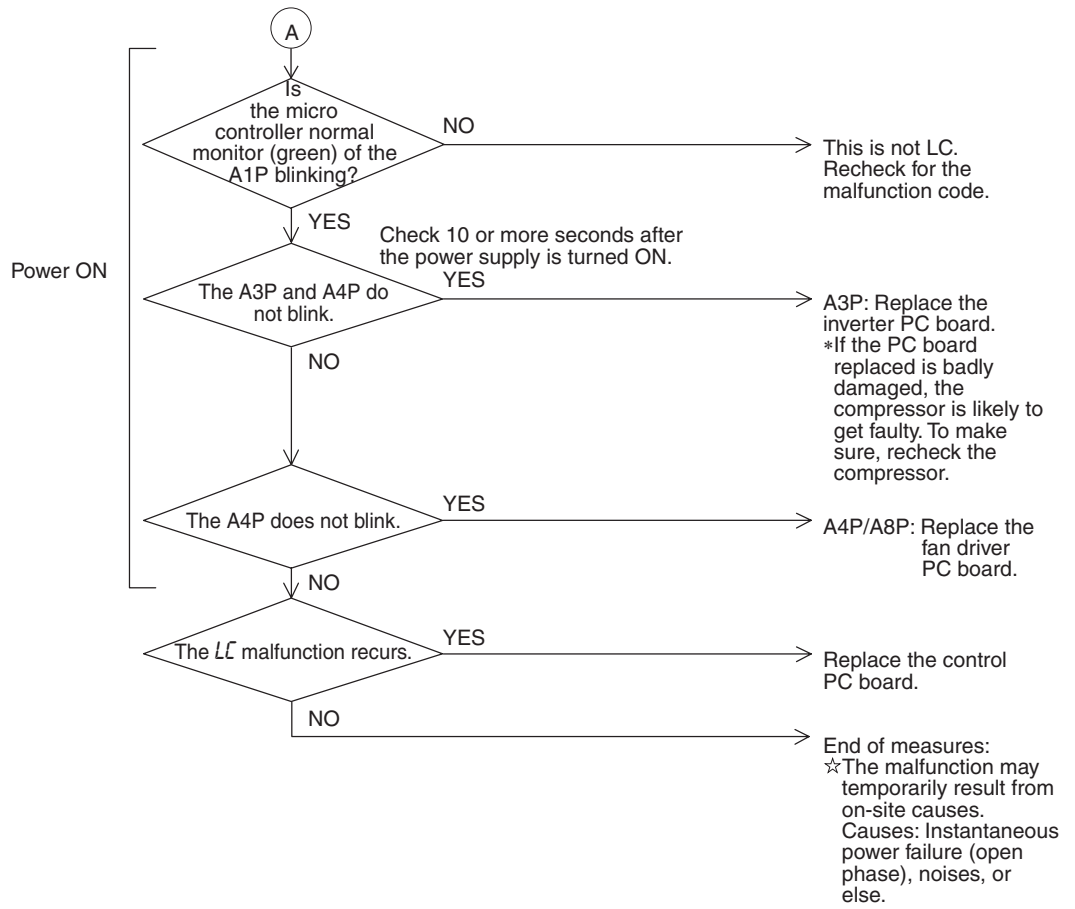

3.35 "P1" Outdoor Unit: Inverter Over-Ripple Protection

remote control Display	P1
Applicable Models	CMSQ200A7, 250A7
Method of Malfunction Detection	Imbalance in supply voltage is detected in PC board. Imbalance in the power supply voltage causes increased ripple of voltage of the main circuit capacitor in the inverter. Consequently, the increased ripple is detected.
Malfunction Decision Conditions	When the resistance value of thermistor becomes a value equivalent to open or short circuited status. ★ Malfunction is not decided while the unit operation is continued. "P1" will be displayed by pressing the inspection button. When the amplitude of the ripple exceeding a certain value is detected for consecutive 4 minutes.
Supposed Causes	<ul style="list-style-type: none"> ■ Open phase ■ Voltage imbalance between phases ■ Defect of main circuit capacitor ■ Defect of inverter PC board ■ Defect of K2 relay in inverter PC board ■ Improper main circuit wiring

Troubleshooting

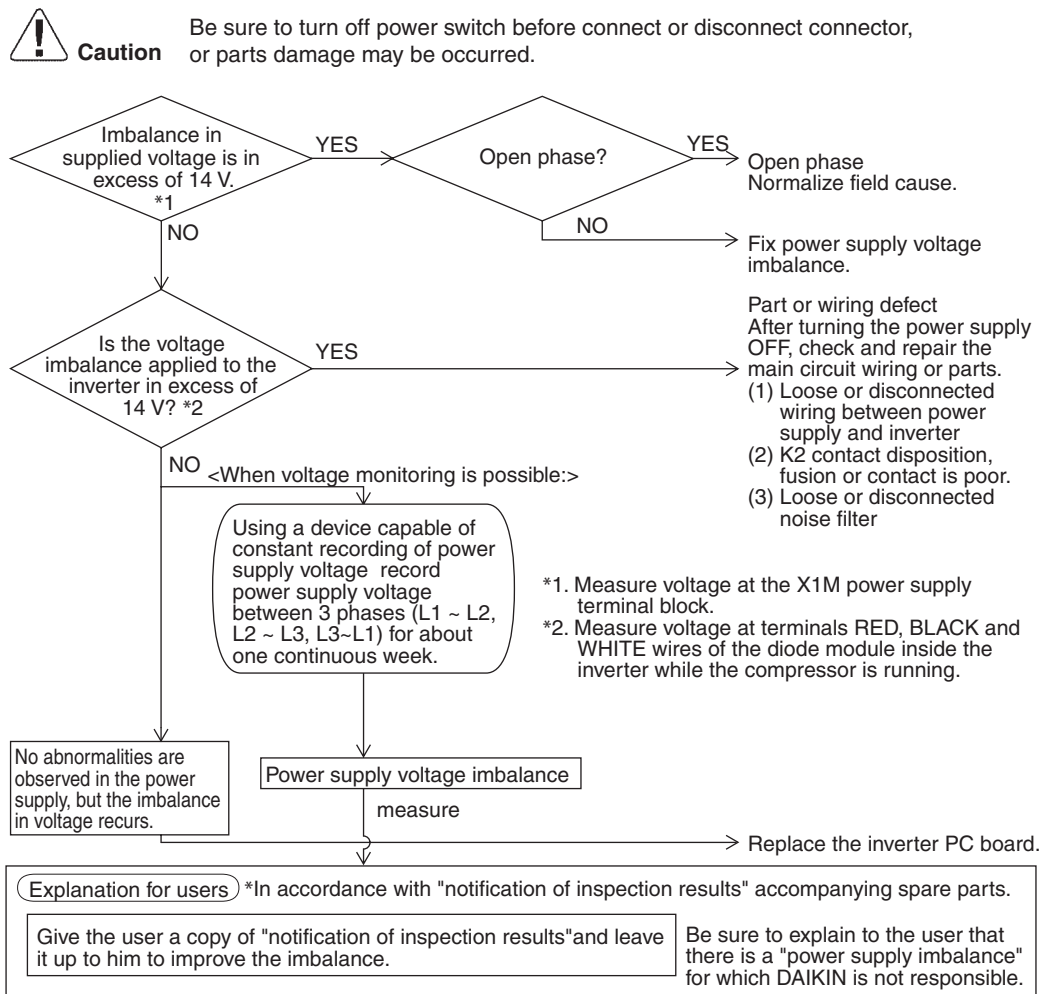

3.36 "P4" Outdoor Unit: Malfunction of Inverter Radiating Fin Temperature Rise Sensor

remote control
Display

P4

Applicable
Models

CMSQ200A7, 250A7

Method of
Malfunction
Detection

Resistance of radiation fin thermistor is detected when the compressor is not operating.

Malfunction
Decision
Conditions

When the resistance value of thermistor becomes a value equivalent to open or short circuited status.

- ★ Malfunction is not decided while the unit operation is continued.
- "P4" will be displayed by pressing the inspection button.

Supposed
Causes

- Defect of radiator fin temperature sensor
- Defect of inverter PC board

Troubleshooting



Caution

Be sure to turn off power switch before connect or disconnect connector, or parts damage may be occurred.

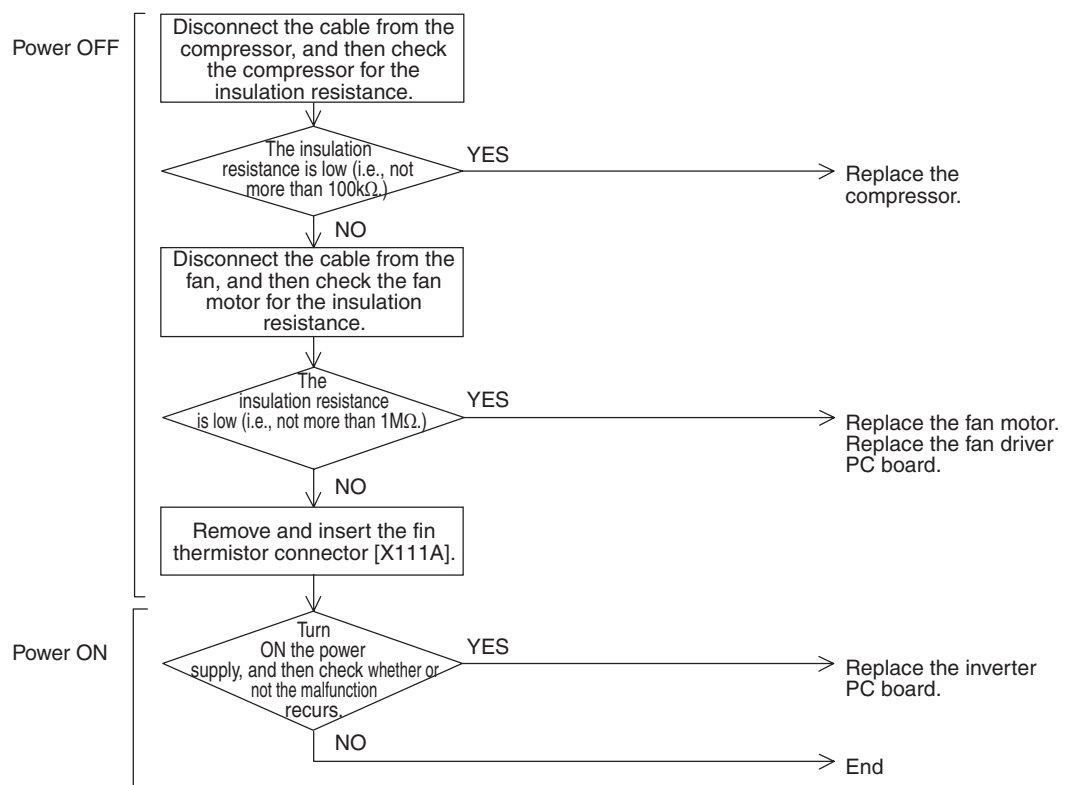

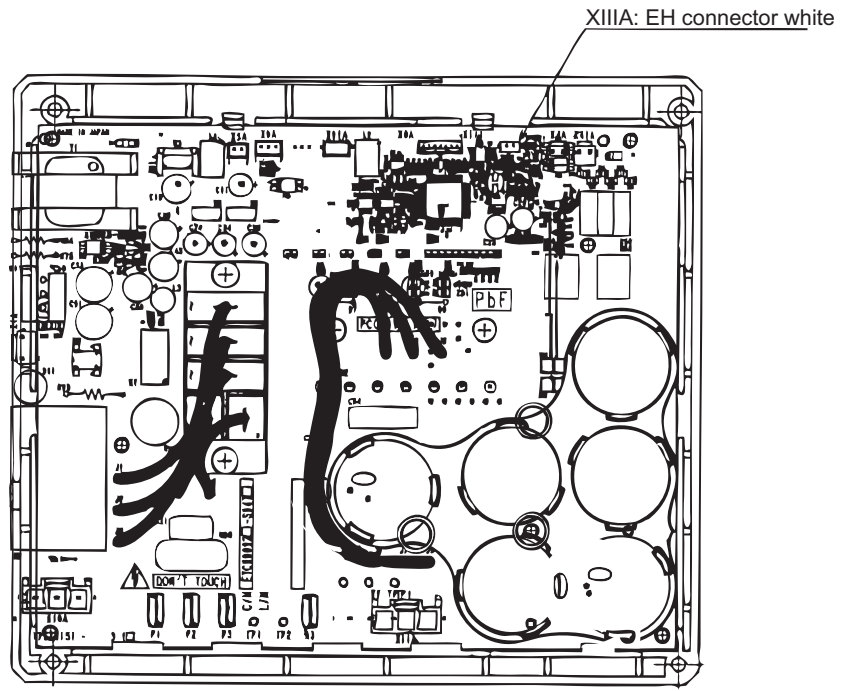

Inverter PC board for compressor



* Refer to "Thermistor Resistance / Temperature Characteristics" table on P.247.

3.37 “PU” Outdoor Unit: Faulty Field Setting after Replacing Main PC Board or Faulty Combination of PC Board

remote control Display	PU
Applicable Models	CMSQ200A7, 250A7
Method of Malfunction Detection	The faulty (or no) field setting after replacing PC board or faulty PC board combination is detected through communications with the inverter.
Malfunction Decision Conditions	Whether or not the field setting or the type of the PC board is correct through the communication data is judged.
Supposed Causes	<ul style="list-style-type: none"> ■ Faulty (or no) field setting after replacing main PC board ■ Mismatching of type of PC board

Troubleshooting

Caution

Be sure to turn off power switch before connect or disconnect connector, or parts damage may be occurred.

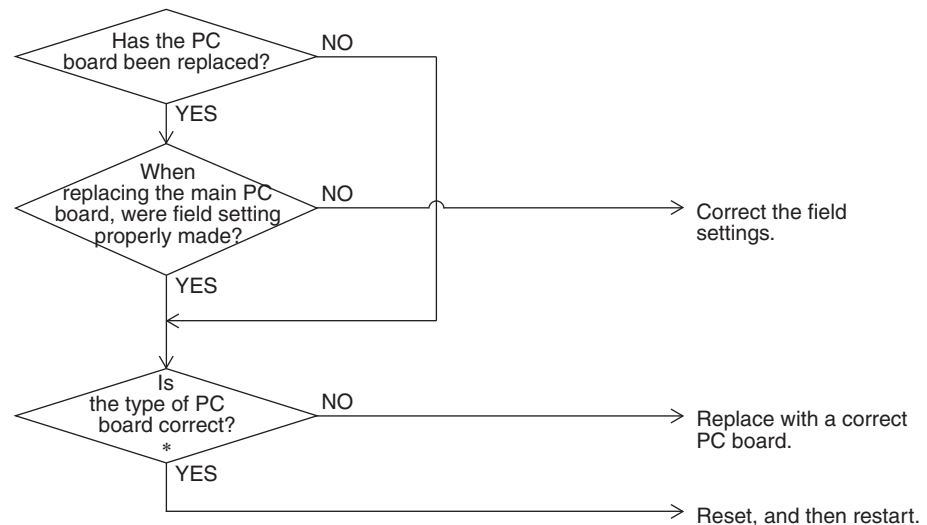

*Note) Type of PC board mismatching includes;
 Main PC board
 Inverter PC board (for compressor)
 Fan driver PC board

3.38 “U0” Outdoor Unit: Low Pressure Drop Due to Refrigerant Shortage or Electronic Expansion Valve Failure

remote control Display	U0
Applicable Models	CMSQ200A7, 250A7
Method of Malfunction Detection	Short of gas malfunction is detected by discharge pipe temperature thermistor.
Malfunction Decision Conditions	Microcomputer judge and detect if the system is short of refrigerant. ★Malfunction is not decided while the unit operation is continued.
Supposed Causes	<ul style="list-style-type: none"> ■ Out of gas or refrigerant system clogging (incorrect piping) ■ Defect of pressure sensor ■ Defect of outdoor unit PC board (A1P) ■ Defect of thermistor R7T or R4T

Troubleshooting



Caution

Be sure to turn off power switch before connect or disconnect connector, or parts damage may be occurred.

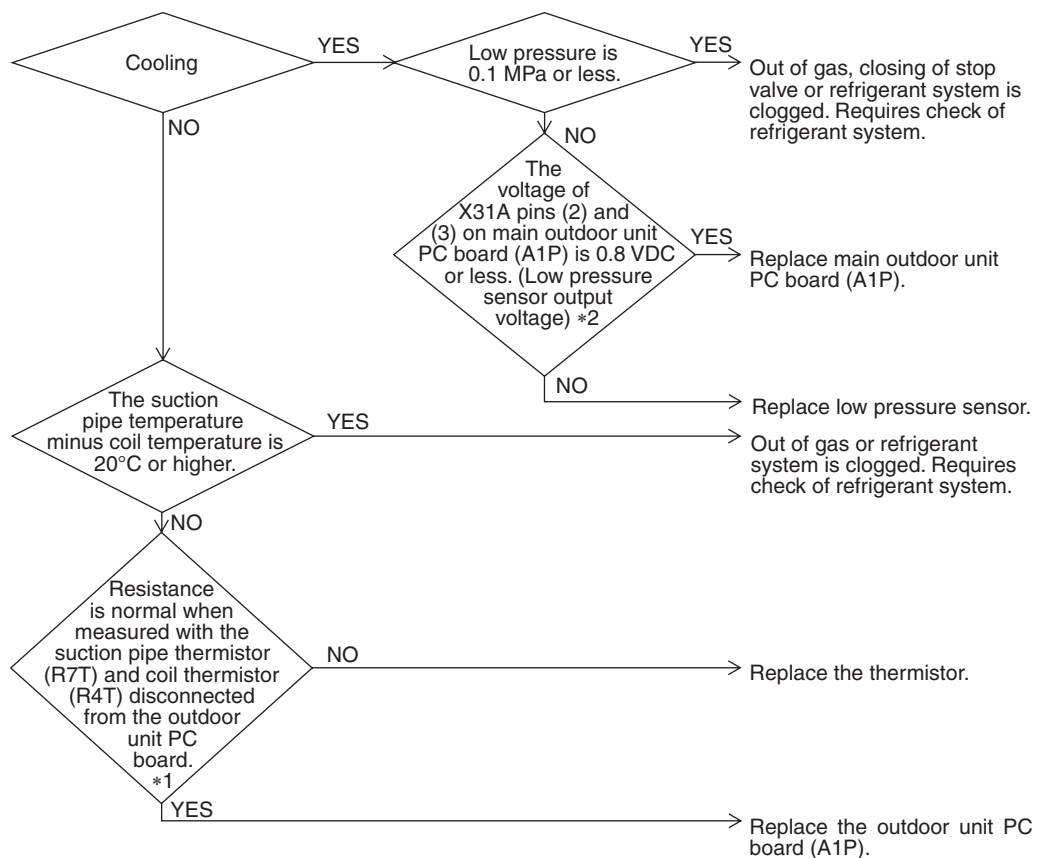

*1: Refer to “Thermistor Resistance / Temperature Characteristics” table on P.247.

*2: Refer to “Pressure Sensor, Pressure / Voltage Characteristics” table on P.249.

3.39 “U1” Reverse Phase, Open Phase

remote control Display	U1
Applicable Models	CMSQ200A7, 250A7
Method of Malfunction Detection	The phase of each phase are detected by reverse phase detection circuit and right phase or reverse phase are judged.
Malfunction Decision Conditions	When a significant phase difference is made between phases.
Supposed Causes	<ul style="list-style-type: none"> ■ Power supply reverse phase ■ Power supply open phase ■ Defect of outdoor PC board (A1P)
Troubleshooting	

**Caution**

Be sure to turn off power switch before connect or disconnect connector, or parts damage may be occurred.

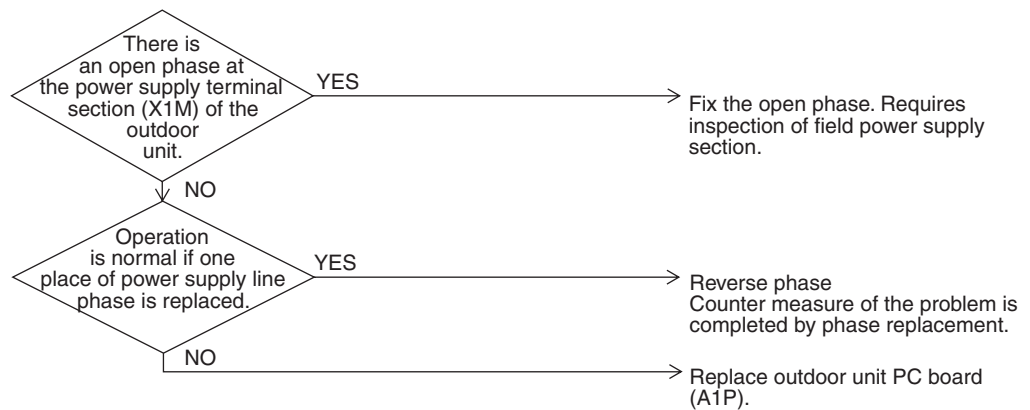

3.40 “U2” Outdoor Unit: Power Supply Insufficient or Instantaneous Failure

remote control Display	U2
Applicable Models	CMSQ200A7, 250A7
Method of Malfunction Detection	Detection of voltage of main circuit capacitor built in the inverter and power supply voltage.
Malfunction Decision Conditions	When the voltage aforementioned is not less than 780V or not more than 320V, or when the current-limiting voltage does not reach 200V or more or exceeds 740V.
Supposed Causes	<ul style="list-style-type: none"> ■ Power supply insufficient ■ Instantaneous power failure ■ Open phase ■ Defect of inverter PC board ■ Defect of outdoor control PC board ■ Main circuit wiring defect ■ Faulty compressor ■ Faulty fan motor ■ Faulty connection of signal cable

Troubleshooting



Caution Be sure to turn off power switch before connect or disconnect connector, or parts damage may be occurred.

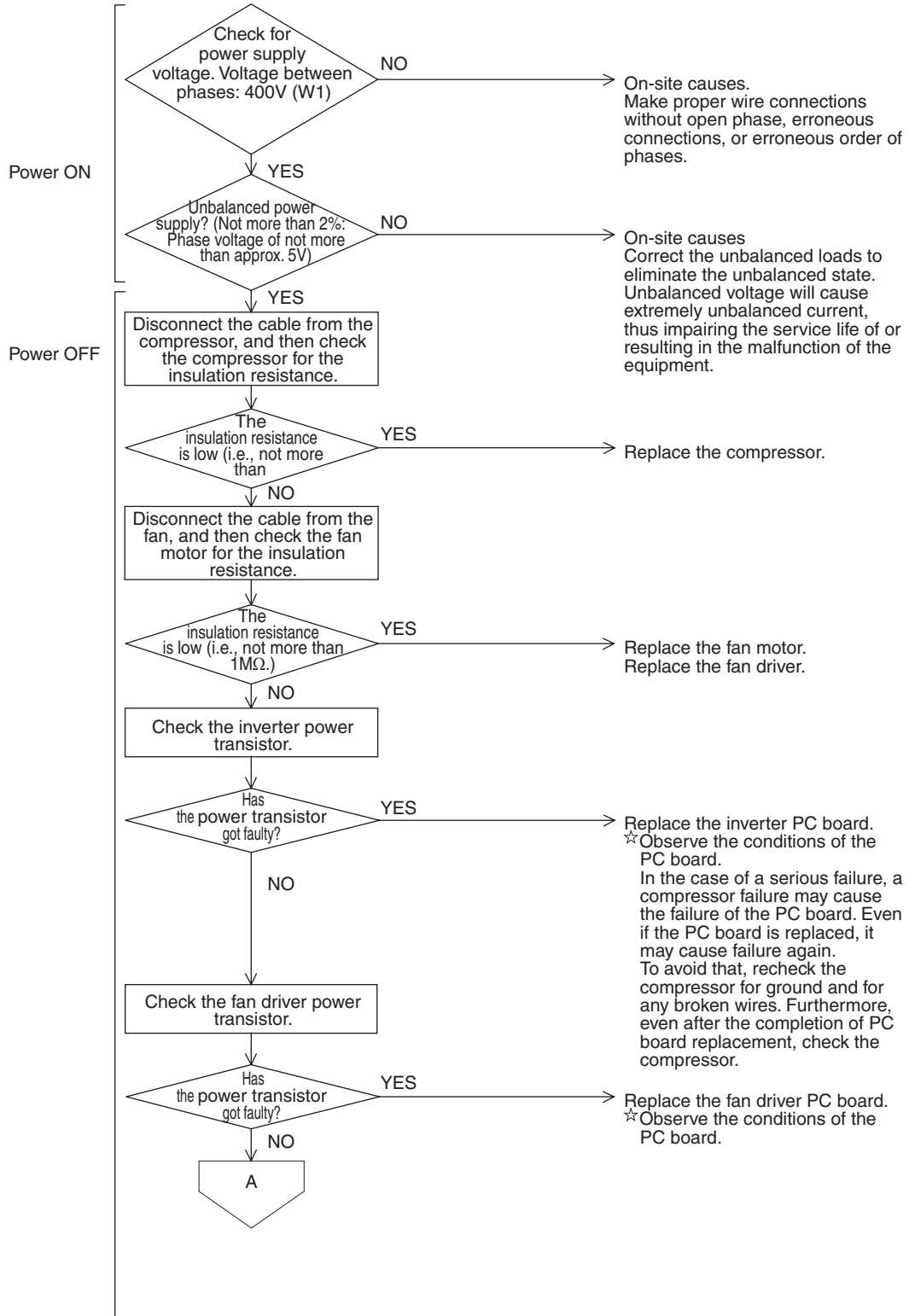

Troubleshooting

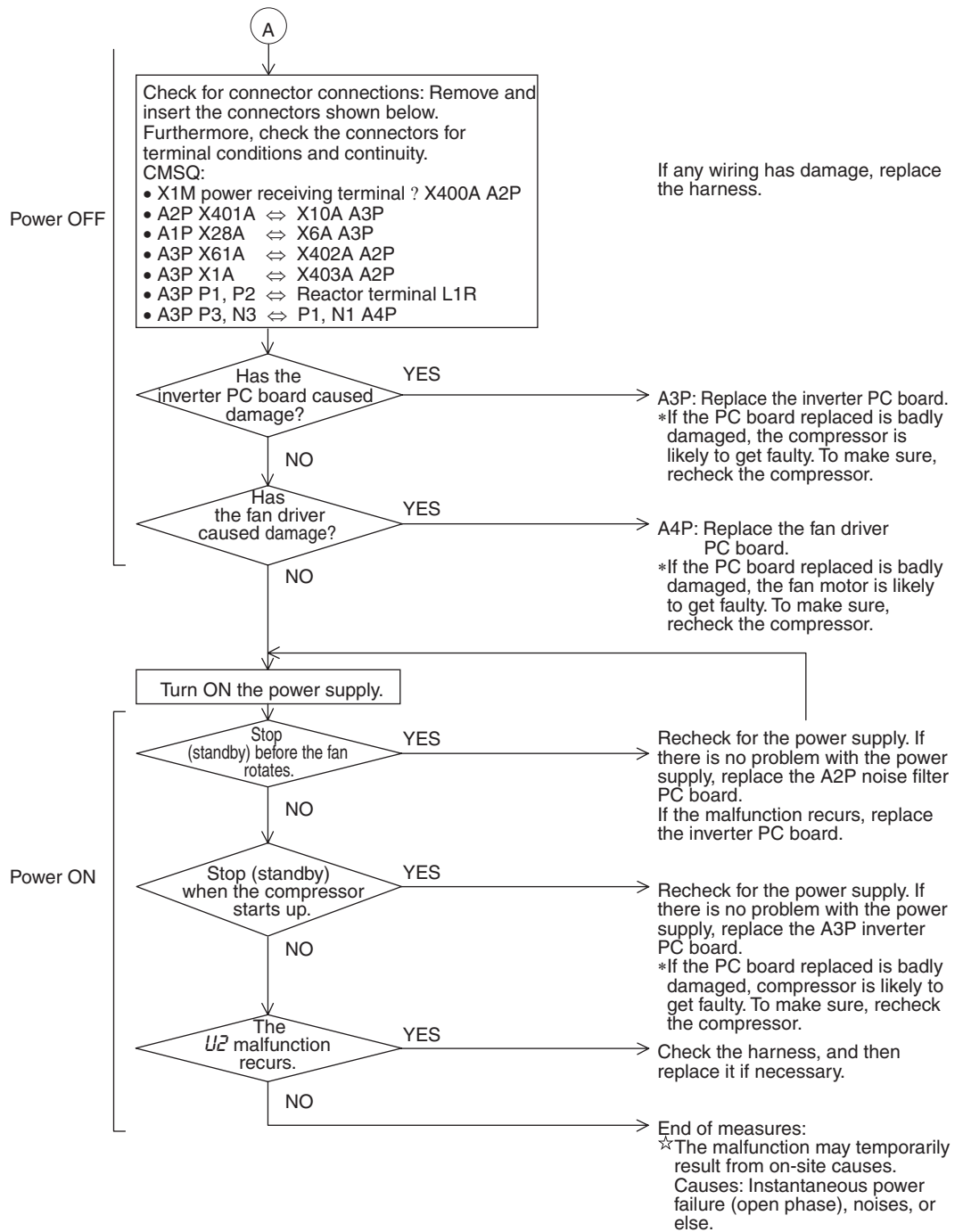

3.41 “U3” Outdoor Unit: Check Operation not Executed

remote control Display	U3
Applicable Models	CMSQ200A7, 250A7
Method of Malfunction Detection	Check operation is executed or not
Malfunction Decision Conditions	Malfunction is decided when the unit starts operation without check operation.
Supposed Causes	<ul style="list-style-type: none"> ■ Check operation is not executed.
Troubleshooting	

**Caution**

Be sure to turn off power switch before connect or disconnect connector, or parts damage may be occurred.

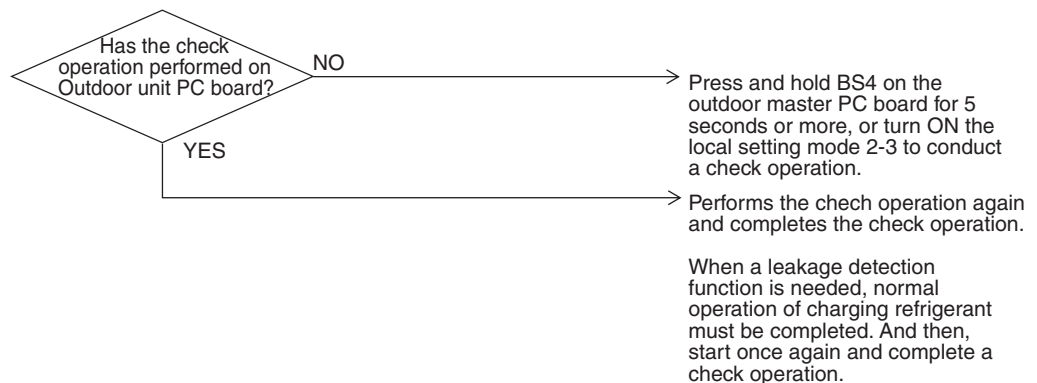

3.42 “U4” Malfunction of Transmission Between Indoor Units

remote control Display	U4
Applicable Models	All model of indoor unit CMSQ200A7, 250A7
Method of Malfunction Detection	Microcomputer checks if transmission between indoor and outdoor units is normal.
Malfunction Decision Conditions	When transmission is not carried out normally for a certain amount of time
Supposed Causes	<ul style="list-style-type: none"> ■ Indoor to outdoor, outdoor to outdoor transmission wiring F1, F2 disconnection, short circuit or wrong wiring ■ Outdoor unit power supply is OFF ■ System address doesn't match ■ Defect of indoor unit PC board ■ Defect of outdoor unit PC board

Troubleshooting

**Caution**

Be sure to turn off power switch before connect or disconnect connector, or parts damage may be occurred.

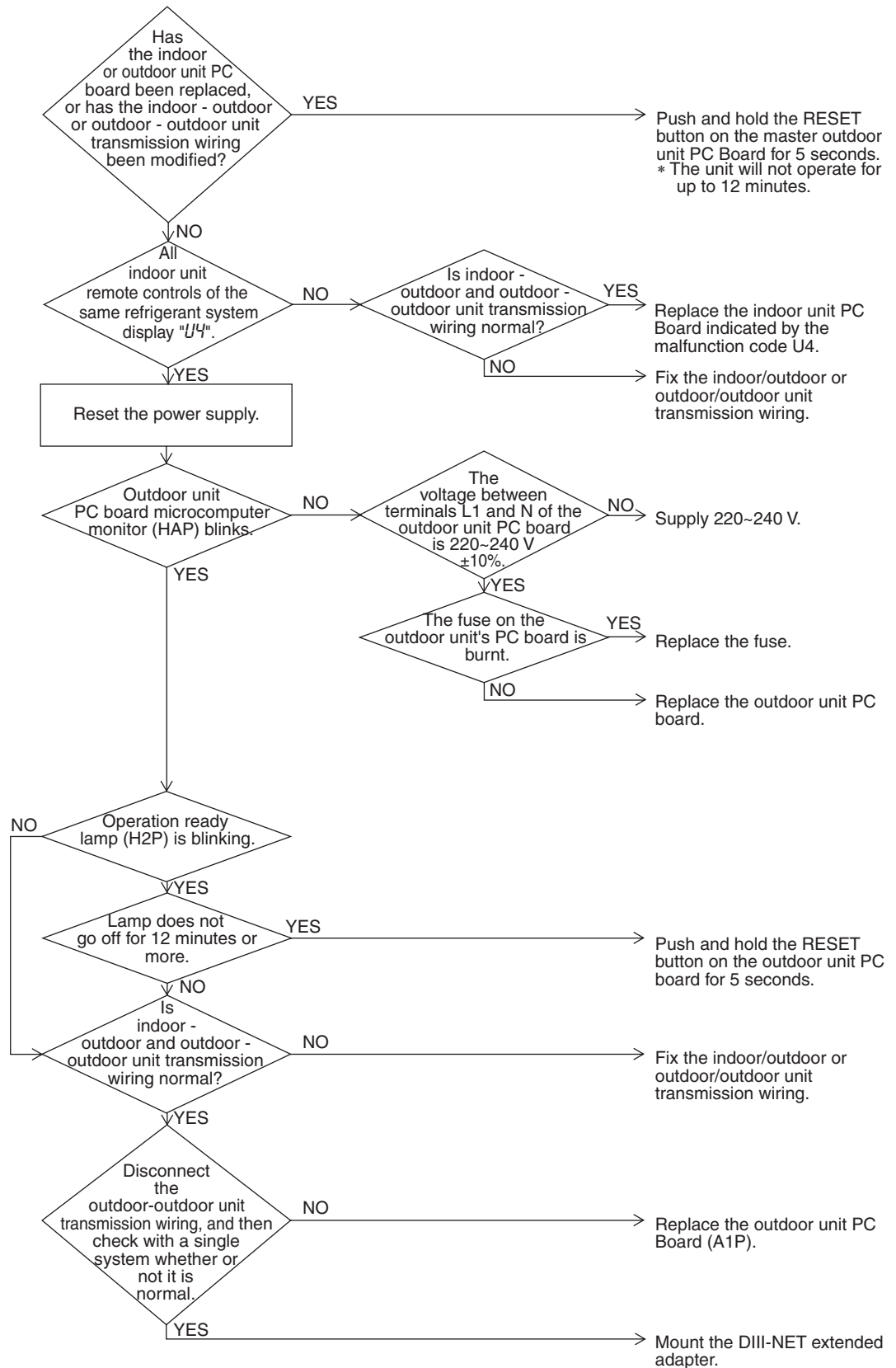

3.43 “U5” Indoor Unit: Malfunction of Transmission Between remote control and Indoor Unit

remote control Display

U5

Applicable Models

All models of indoor units

Method of Malfunction Detection

In case of controlling with 2-remote control, check the system using microcomputer is signal transmission between indoor unit and remote control (main and sub) is normal.

Malfunction Decision Conditions

Normal transmission does not continue for specified period.

Supposed Causes

- Malfunction of indoor unit remote control transmission
- Connection of two main remote controls (when using 2 remote controls)
- Defect of indoor unit PC board
- Defect of remote control PC board
- Malfunction of transmission caused by noise

Troubleshooting



Caution Be sure to turn off power switch before connect or disconnect connector, or parts damage may be occurred.

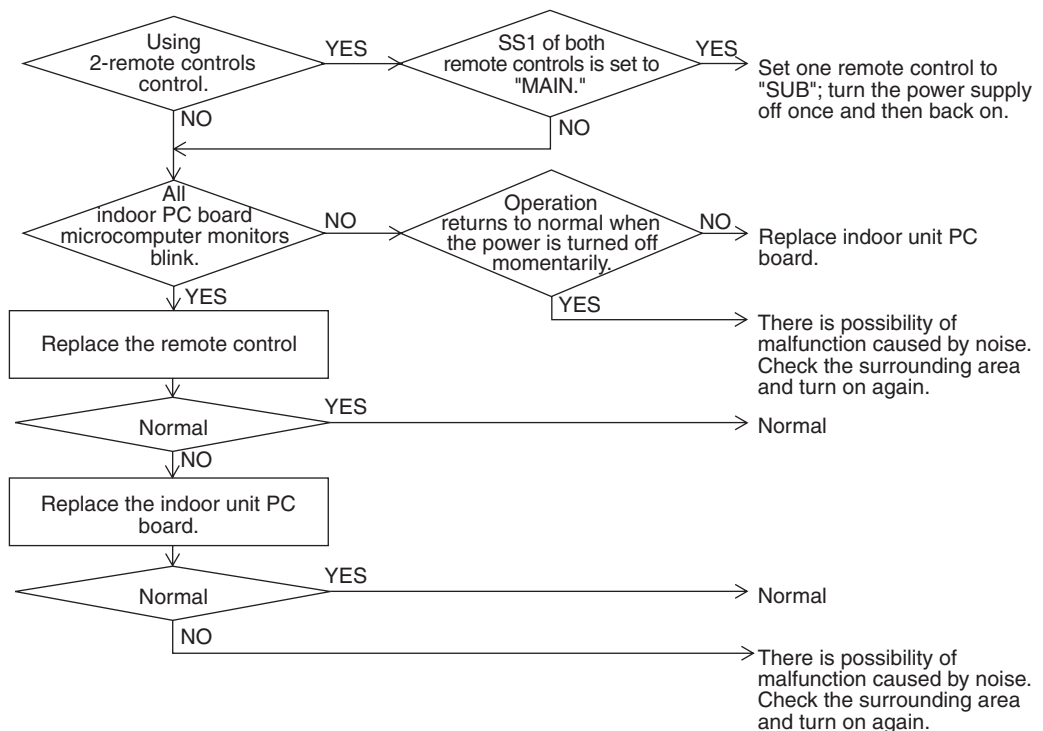

3.44 “U7” Indoor Unit: Malfunction of Transmission Between Outdoor Units

remote control Display	U7
Applicable Models	All models of indoor units
Method of Malfunction Detection	Microcomputer checks if transmission between outdoor units.
Malfunction Decision Conditions	When transmission is not carried out normally for a certain amount of time
Supposed Causes	<ul style="list-style-type: none"> ■ Improper connection of transmission wiring between outdoor unit and external control adapter for outdoor unit ■ Improper connection of transmission wiring between outdoor units. ■ Improper cool/heat selection ■ Improper cool/heat unified address (outdoor unit, external control adapter for outdoor unit) ■ Defect of outdoor unit PC board (A1P) ■ Defect of external control adapter for outdoor unit

Troubleshooting



Caution

Be sure to turn off power switch before connect or disconnect connector, or parts damage may be occurred.

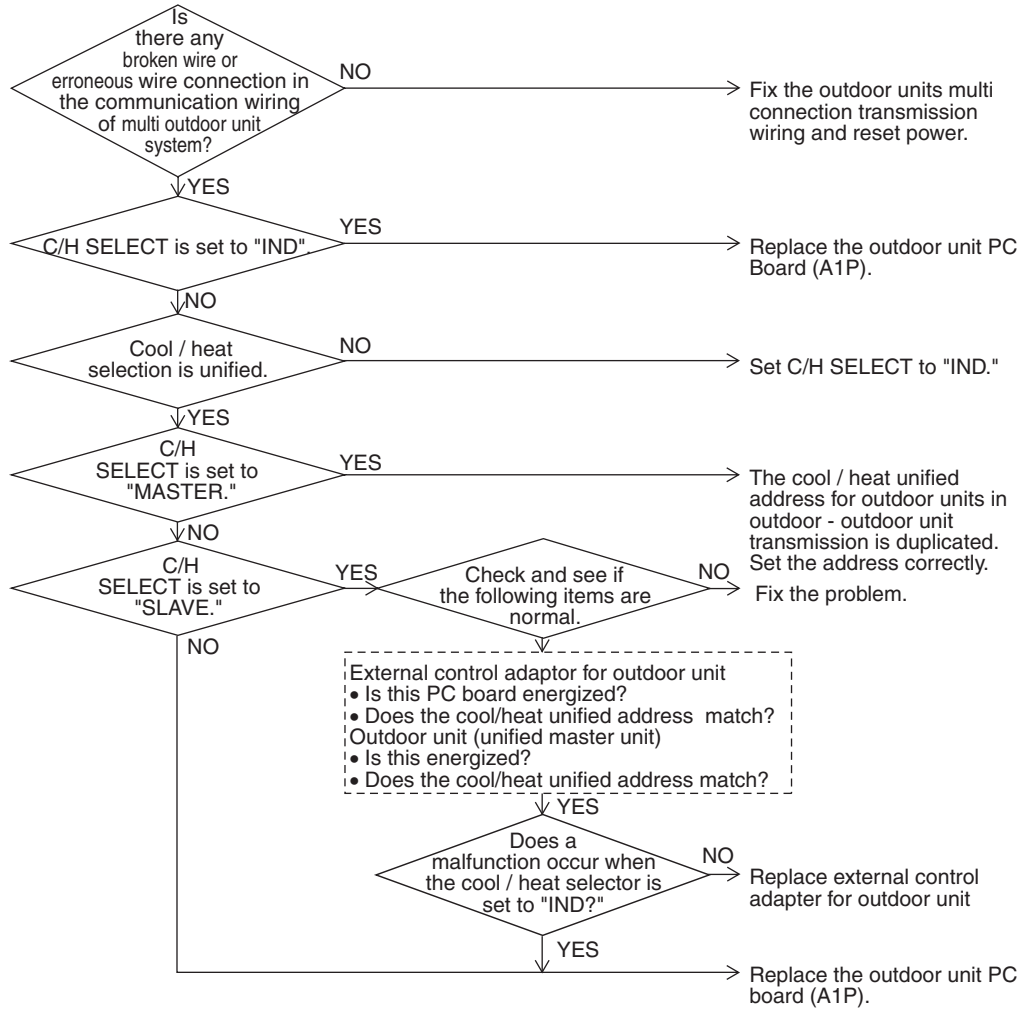

3.45 “U8” Indoor Unit: Malfunction of Transmission Between Main and Sub remote controls

remote control
Display

U8

Applicable
Models

All models of indoor units

Method of
Malfunction
Detection

In case of controlling with 2-remote control, check the system using microcomputer if signal transmission between indoor unit and remote control (main and sub) is normal.

Malfunction
Decision
Conditions

Normal transmission does not continue for specified period.

Supposed
Causes

- Malfunction of transmission between main and sub remote control
- Connection between sub remote controls
- Defect of remote control PC board

Troubleshooting



Caution

Be sure to turn off power switch before connect or disconnect connector, or parts damage may be occurred.

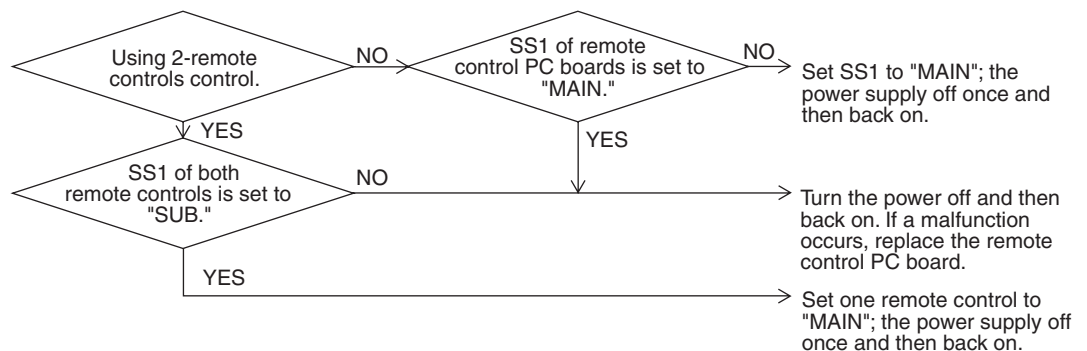

3.46 “U9” Indoor Unit: Malfunction of Transmission Between Indoor and Outdoor Units in the Same System

remote control Display	U9
Applicable Models	All models of indoor units
Method of Malfunction Detection	Detect the malfunction signal of any other indoor unit within the system concerned.
Malfunction Decision Conditions	When the malfunction decision is made on any other indoor unit within the system concerned.
Supposed Causes	<ul style="list-style-type: none"> ■ Malfunction of transmission within or outside of other system ■ Malfunction of electronic expansion valve in indoor unit of other system ■ Defect of PC board of indoor unit in other system ■ Improper connection of transmission wiring between indoor and outdoor unit

Troubleshooting



Caution

Be sure to turn off power switch before connect or disconnect connector, or parts damage may be occurred.

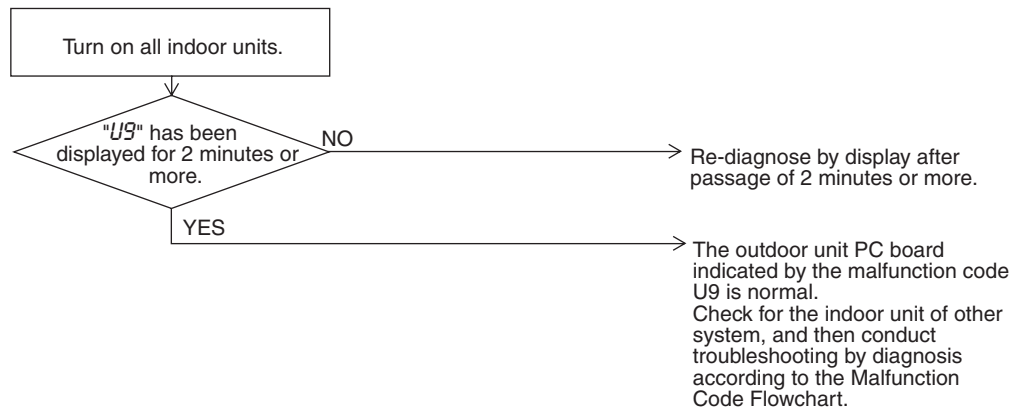

3.47 “UR” Improper Combination of Indoor and Outdoor Units, Indoor Units and remote control

remote control Display	<i>UR</i>
Applicable Models	All models of indoor unit CMSQ200A7, 250A7
Method of Malfunction Detection	A difference occurs in data by the type of refrigerant between indoor and outdoor units. The number of indoor units is out of the allowable range.
Malfunction Decision Conditions	The malfunction decision is made as soon as either of the abnormalities aforementioned is detected.
Supposed Causes	<ul style="list-style-type: none"> ■ Excess of connected indoor units ■ Defect of outdoor unit PC board (A1P) ■ Mismatching of the refrigerant type of indoor and outdoor unit. ■ Setting of outdoor PC board was not conducted after replacing to spare parts PC board.

Troubleshooting



Caution

Be sure to turn off power switch before connect or disconnect connector, or parts damage may be occurred.

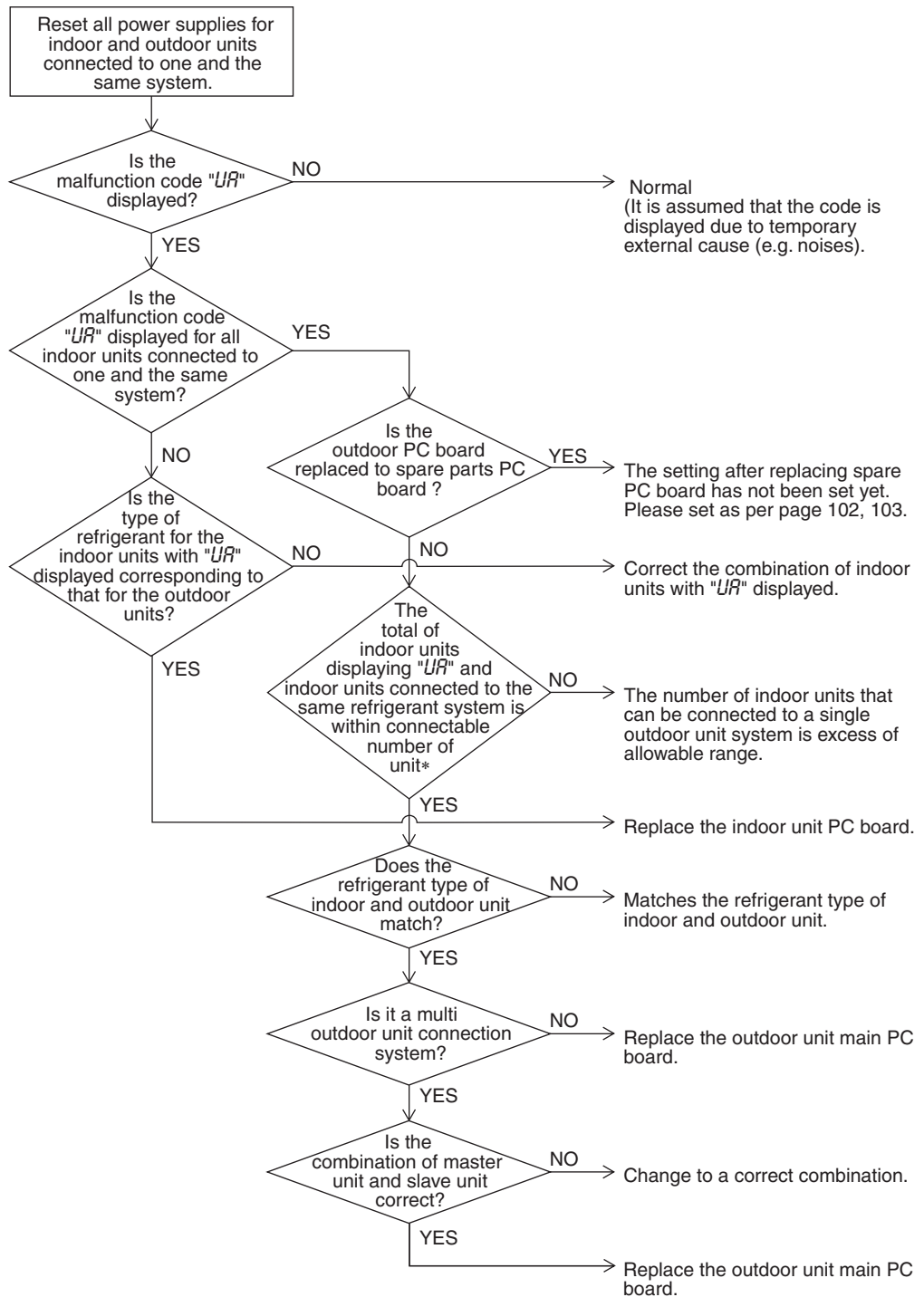

* The number of indoor units that can be connected to a single outdoor unit system depends on the model of outdoor unit.

3.48 “UC” Address Duplication of Centralized Controller

remote control Display	UC
Applicable Models	All models of indoor unit Centralized controller
Method of Malfunction Detection	The principal indoor unit detects the same address as that of its own on any other indoor unit.
Malfunction Decision Conditions	The malfunction decision is made as soon as the abnormality aforementioned is detected.
Supposed Causes	<ul style="list-style-type: none"> ■ Address duplication of centralized controller
Troubleshooting	<div style="display: flex; align-items: flex-start;"> <div style="margin-right: 20px;">  <p>Caution</p> </div> <div> <p>Be sure to turn off power switch before connect or disconnect connector, or parts damage may be occurred.</p> </div> </div> <div style="display: flex; align-items: center; margin-top: 10px;"> <div style="border: 1px solid black; padding: 5px; margin-right: 20px;"> <p>The centralized address is duplicated.</p> </div> <div style="flex-grow: 1; border-bottom: 1px solid black; position: relative;"> <div style="position: absolute; right: -10px; top: -5px;">→</div> </div> <div style="margin-left: 20px;"> <p>Make setting change so that the centralized address will not be duplicated.</p> </div> </div>

3.49 “UE” Malfunction of Transmission Between Centralized Controller and Indoor Unit

remote control Display	<i>UE</i>
Applicable Models	All models of indoor units intelligent Touch Controller Centralized controller Schedule timer
Method of Malfunction Detection	Microcomputer checks if transmission between indoor unit and centralized controller is normal.
Malfunction Decision Conditions	When transmission is not carried out normally for a certain amount of time
Supposed Causes	<ul style="list-style-type: none"> ■ Malfunction of transmission between optional controllers for centralized control and indoor unit ■ Connector for setting master controller is disconnected. (or disconnection of connector for independent / combined use changeover switch.) ■ Failure of PC board for central remote control ■ Defect of indoor unit PC board

Troubleshooting



Caution

Be sure to turn off power switch before connect or disconnect connector, or parts damage may be occurred.

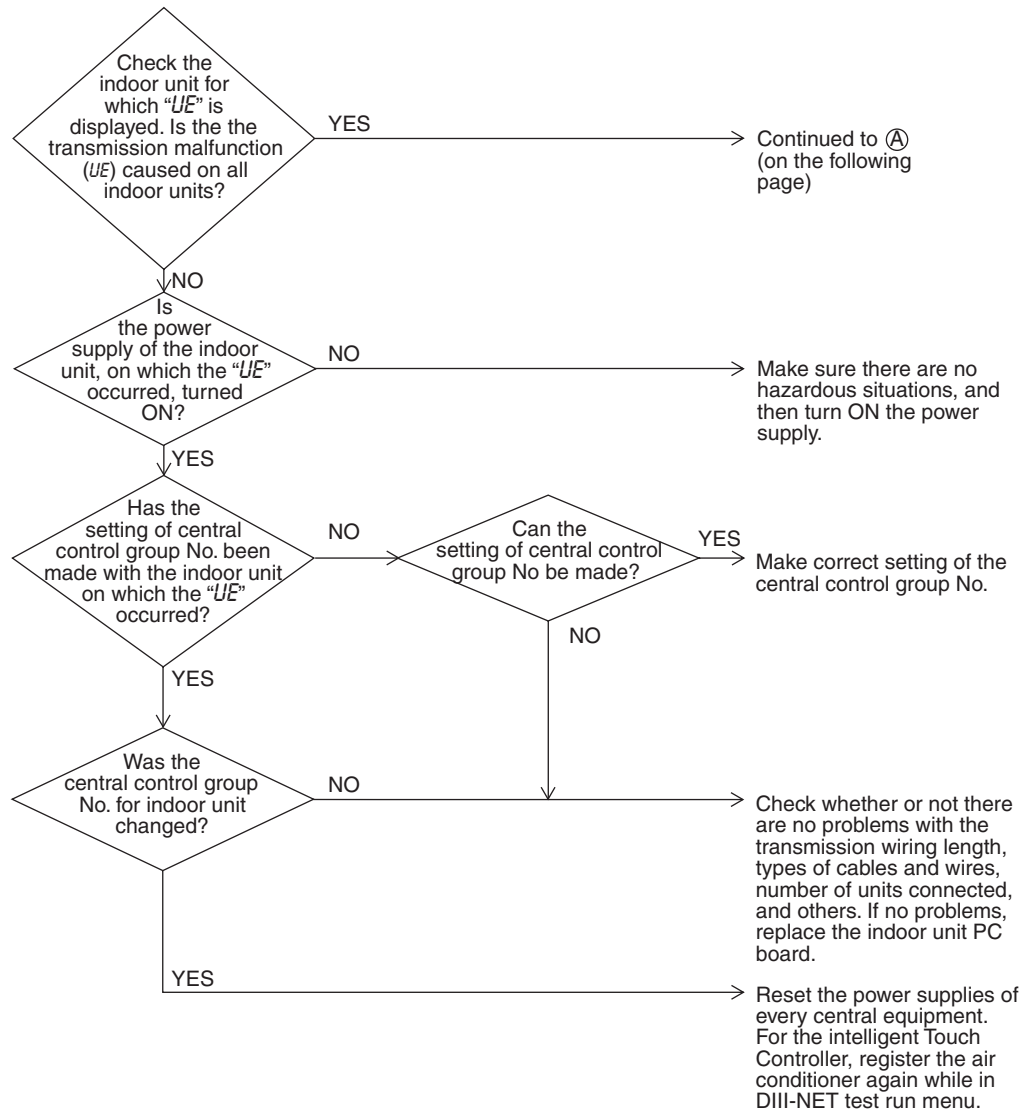

Troubleshooting

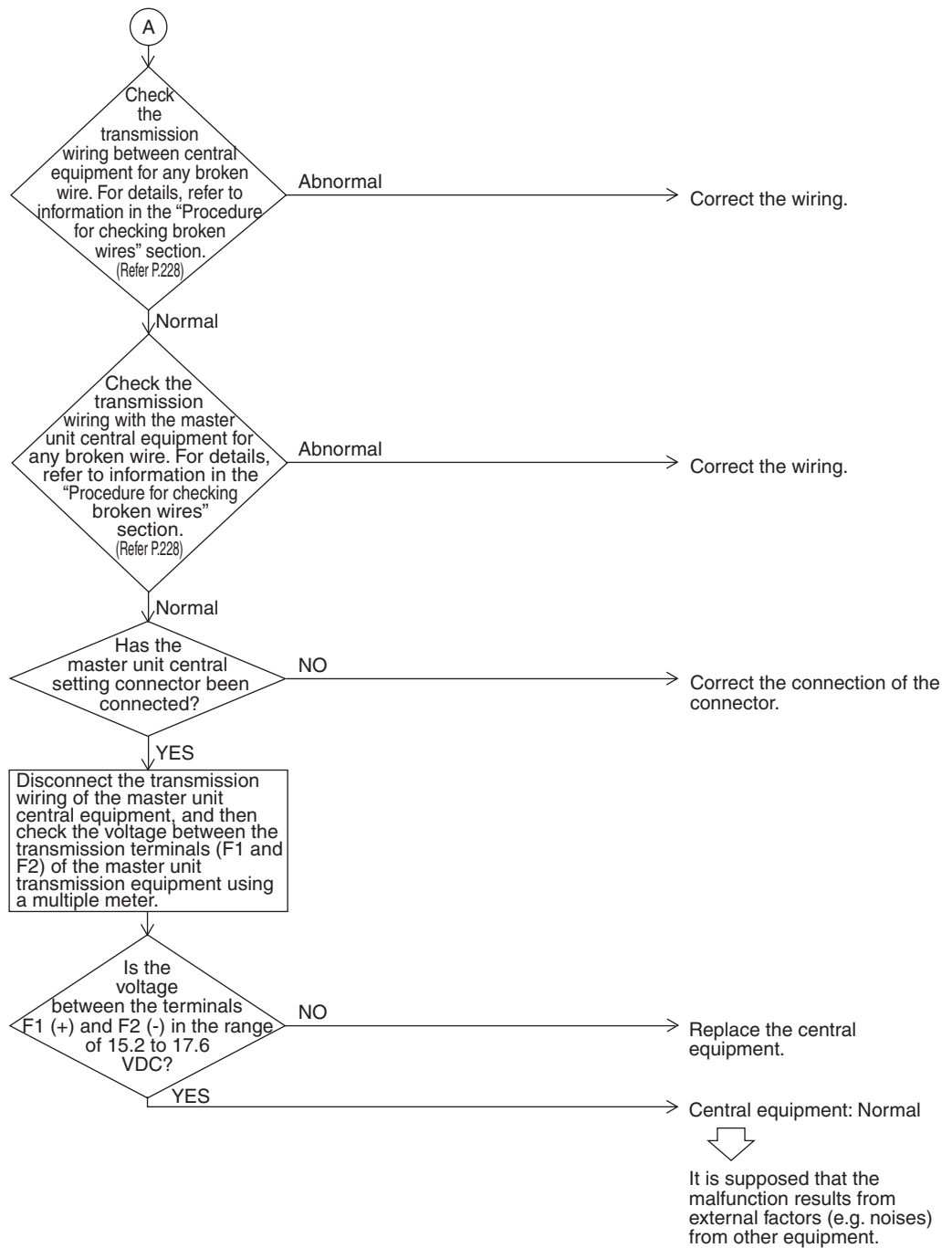



3.50 “UF” System is not Set yet

remote control Display	UF
Applicable Models	All models of indoor units CMSQ200A7, 250A7
Method of Malfunction Detection	On check operation, the number of indoor units in terms of transmission is not corresponding to that of indoor units that have made changes in temperature.
Malfunction Decision Conditions	The malfunction is determined as soon as the abnormality aforementioned is detected through checking the system for any erroneous connection of units on the check operation.
Supposed Causes	<ul style="list-style-type: none"> ■ Improper connection of transmission wiring between indoor-outdoor units and outdoor-outdoor units ■ Failure to execute check operation ■ Defect of indoor unit PC board ■ Stop valve is left in closed

Troubleshooting

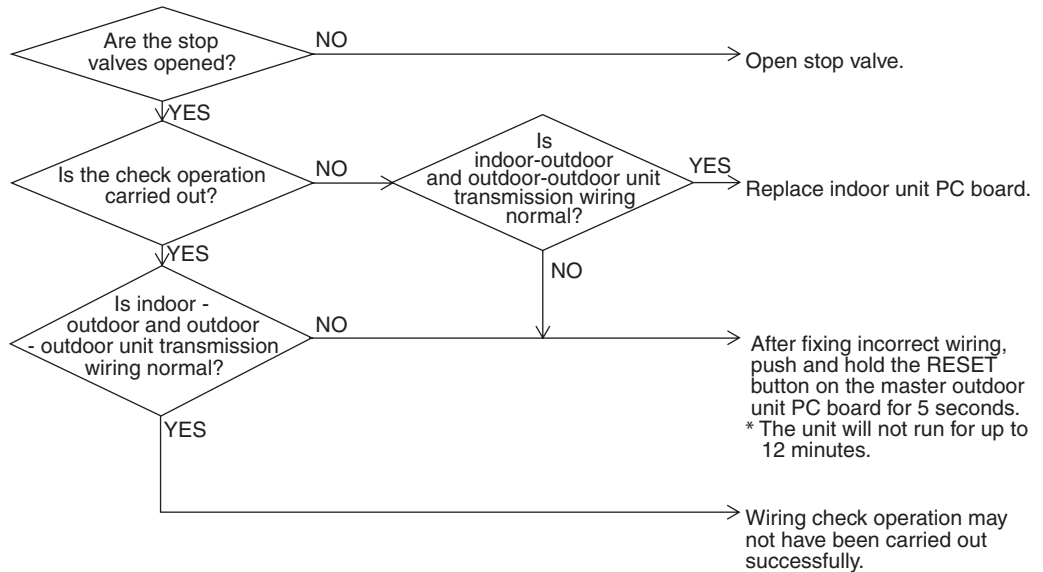
 **Caution** Be sure to turn off power switch before connect or disconnect connector, or parts damage may be occurred.



 **Note:** Wiring check operation may not be successful if carried out after the outdoor unit has been off for more than 12 hours, or if it is not carried out after running all connected indoor units in the fan mode for at least an hour.

3.51 “UH” Malfunction of System, Refrigerant System Address Undefined

remote control Display	<i>UH</i>
Applicable Models	All models of indoor units CMSQ200A7, 250A7
Method of Malfunction Detection	Detect an indoor unit with no address setting.
Malfunction Decision Conditions	The malfunction decision is made as soon as the abnormality aforementioned is detected.
Supposed Causes	<ul style="list-style-type: none"> ■ Improper connection of transmission wiring between indoor-outdoor units and outdoor-outdoor units ■ Defect of indoor unit PC board ■ Defect of outdoor unit PC board (A1P)

Troubleshooting



Caution Be sure to turn off power switch before connect or disconnect connector, or parts damage may be occurred.

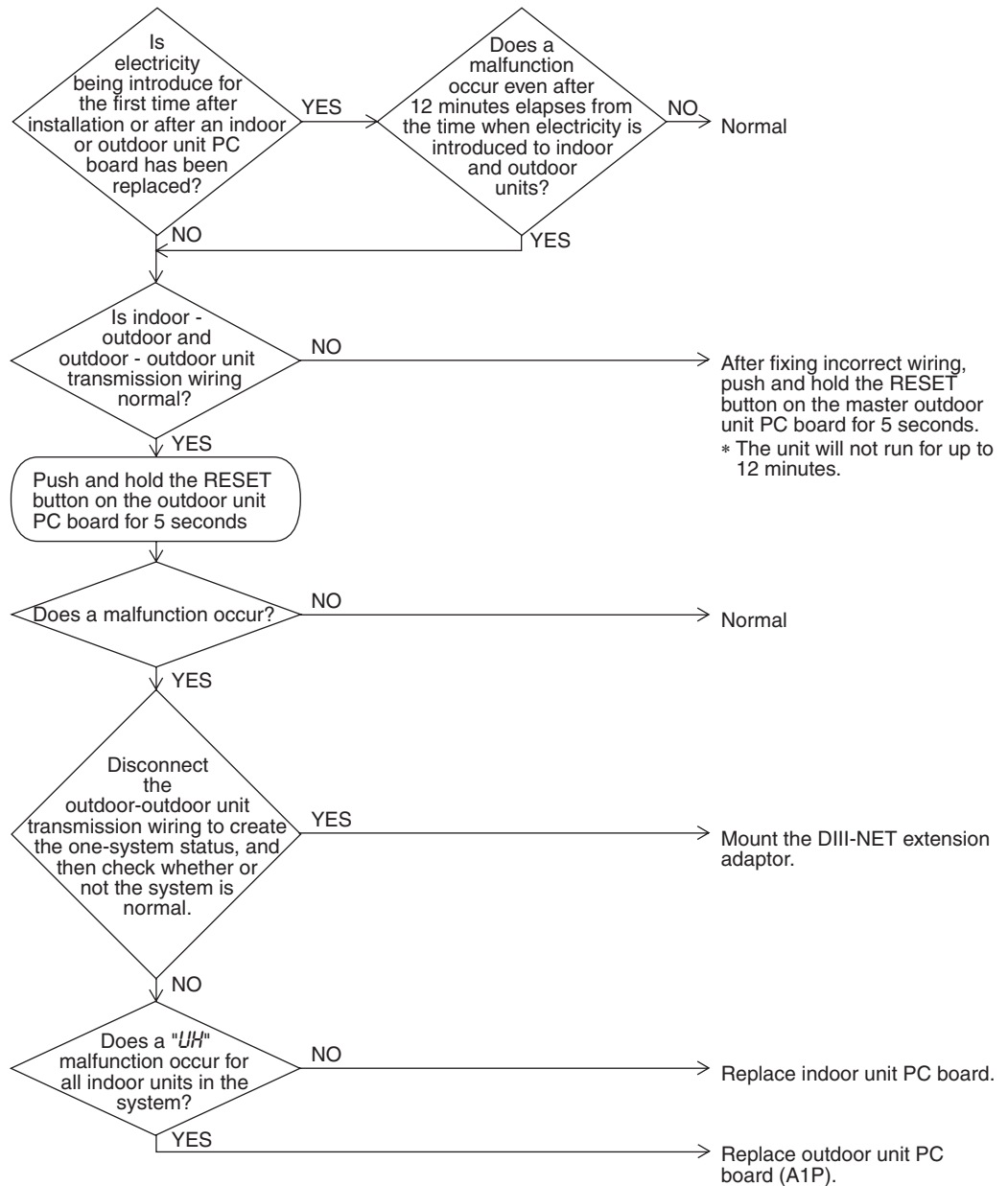

4. Troubleshooting (OP: Central remote control)

4.1 “*m1*” PC Board Defect

remote control Display	<i>m1</i>
Applicable Models	Central remote control Schedule timer
Method of Malfunction Detection	Detect an abnormality in the DIII-NET polarity circuit.
Malfunction Decision Conditions	When + polarity and - polarity are detected at the same time.
Supposed Causes	<ul style="list-style-type: none"> ■ Defect of central remote control PC board ■ Defect of Schedule timer PC board
Troubleshooting	Replace the central remote control.

 **Caution** Be sure to turn off power switch before connect or disconnect connector, or parts damage may be occurred.

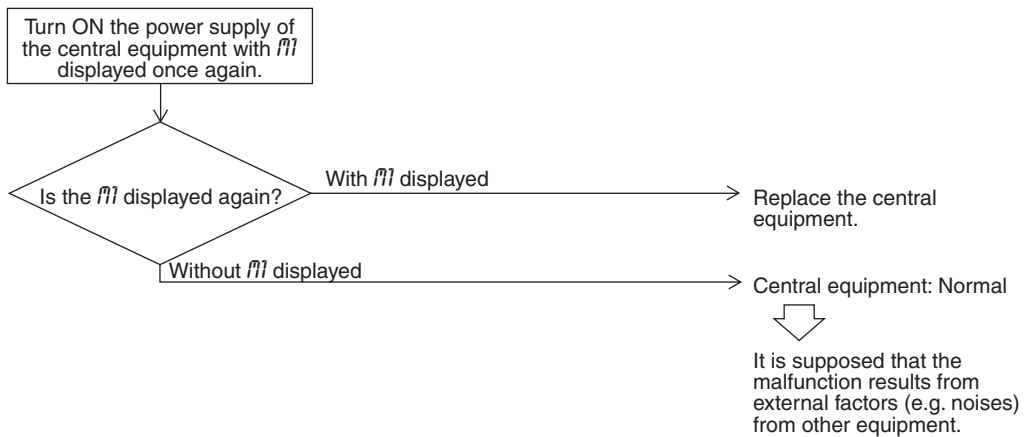

4.2 “M8” Malfunction of Transmission Between Optional Controllers for Centralized Control

remote control Display	M8
Applicable Models	Central remote control intelligent Touch Controller Schedule timer
Method of Malfunction Detection	Detect the malfunction according to DIII-NET transmission data. (The system will be automatically reset.)
Malfunction Decision Conditions	When no master controller is present at the time of the startup of slave controller. When the centralized controller, which was connected once, shows no response.
Supposed Causes	<ul style="list-style-type: none"> ■ Malfunction of transmission between optional controllers for centralized control ■ Defect of PC board of optional controllers for centralized control

Troubleshooting



Caution

Be sure to turn off power switch before connect or disconnect connector, or parts damage may be occurred.

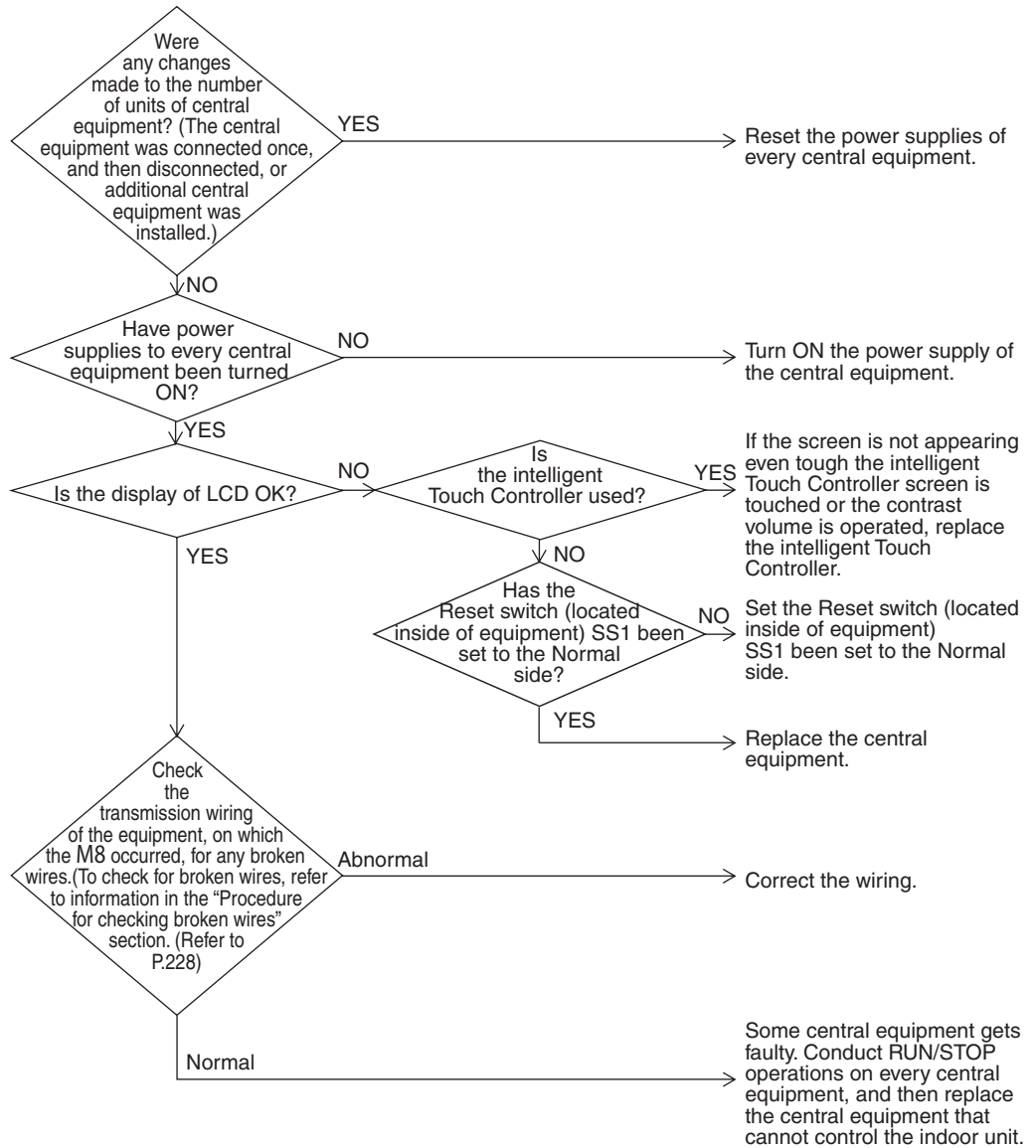

4.3 “*MR*” Improper Combination of Optional Controllers for Centralized Control

remote control Display	<i>MR</i>
Applicable Models	Central remote control intelligent Touch Controller Schedule timer
Method of Malfunction Detection	Detect the malfunction according to DIII-NET transmission data.
Malfunction Decision Conditions	When the schedule timer is set to individual use mode, other central component is present. When multiple master controller are present. When the remote control adapter is present.
Supposed Causes	<ul style="list-style-type: none"> ■ Improper combination of optional controllers for centralized control ■ More than one master controller is connected ■ Defect of PC board of optional controller for centralized control

Troubleshooting



Caution

Be sure to turn off power switch before connect or disconnect connector, or parts damage may be occurred.

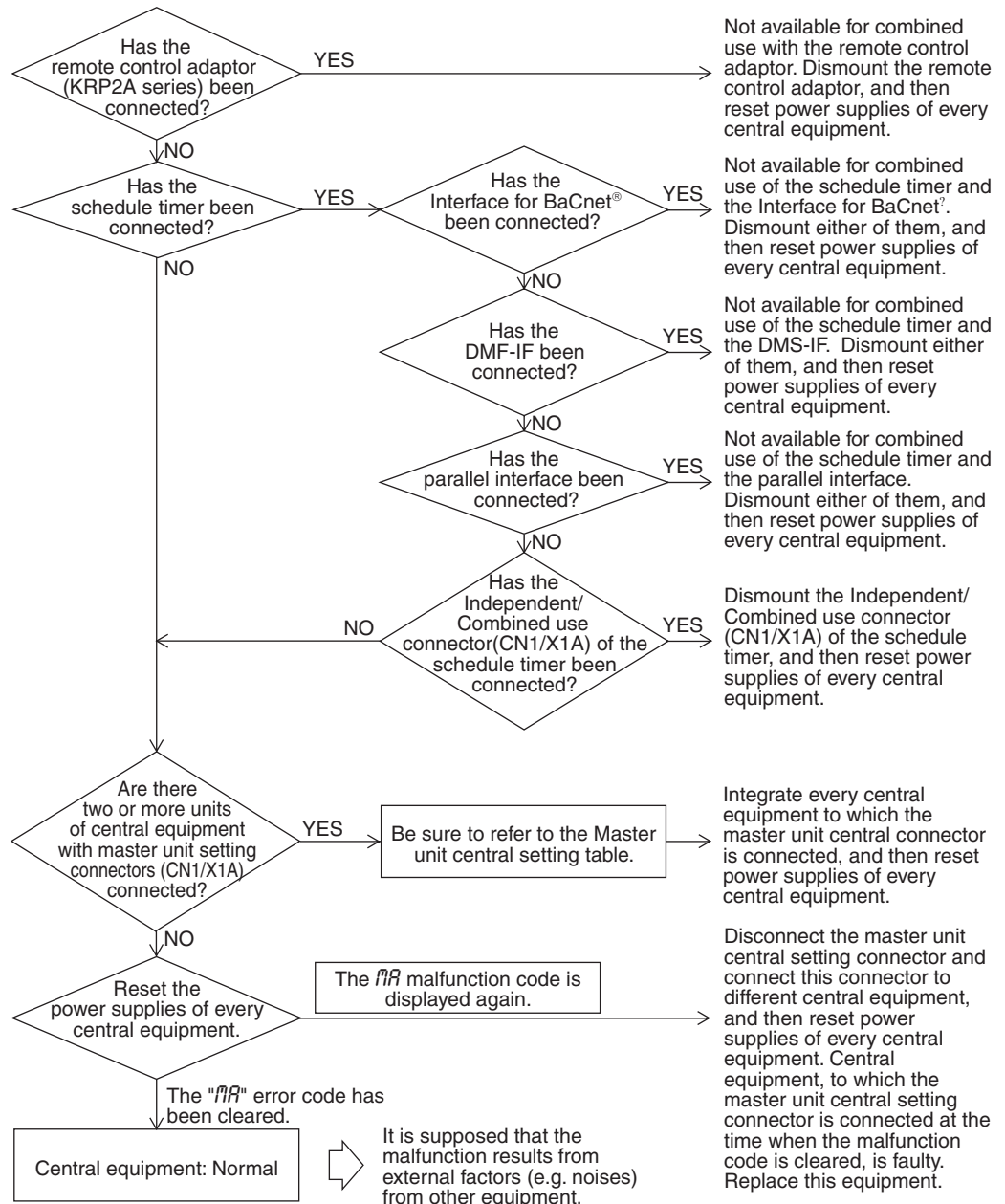

4.4 "MC" Address Duplication, Improper Setting

remote control
Display



Applicable Models

Central remote control intelligent Touch Controller
Schedule timer

Method of Malfunction Detection

Detect the malfunction according to DIII-NET transmission data.

Malfunction Decision Conditions

- Two or more units of central remote controls and intelligent Touch Controllers are connected, and all of them are set to master unit central setting or slave unit central setting.
- Two units of schedule timers are connected.

Supposed Causes

- Address duplication of centralized controller

Troubleshooting



Caution

Be sure to turn off power switch before connect or disconnect connector, or parts damage may be occurred.

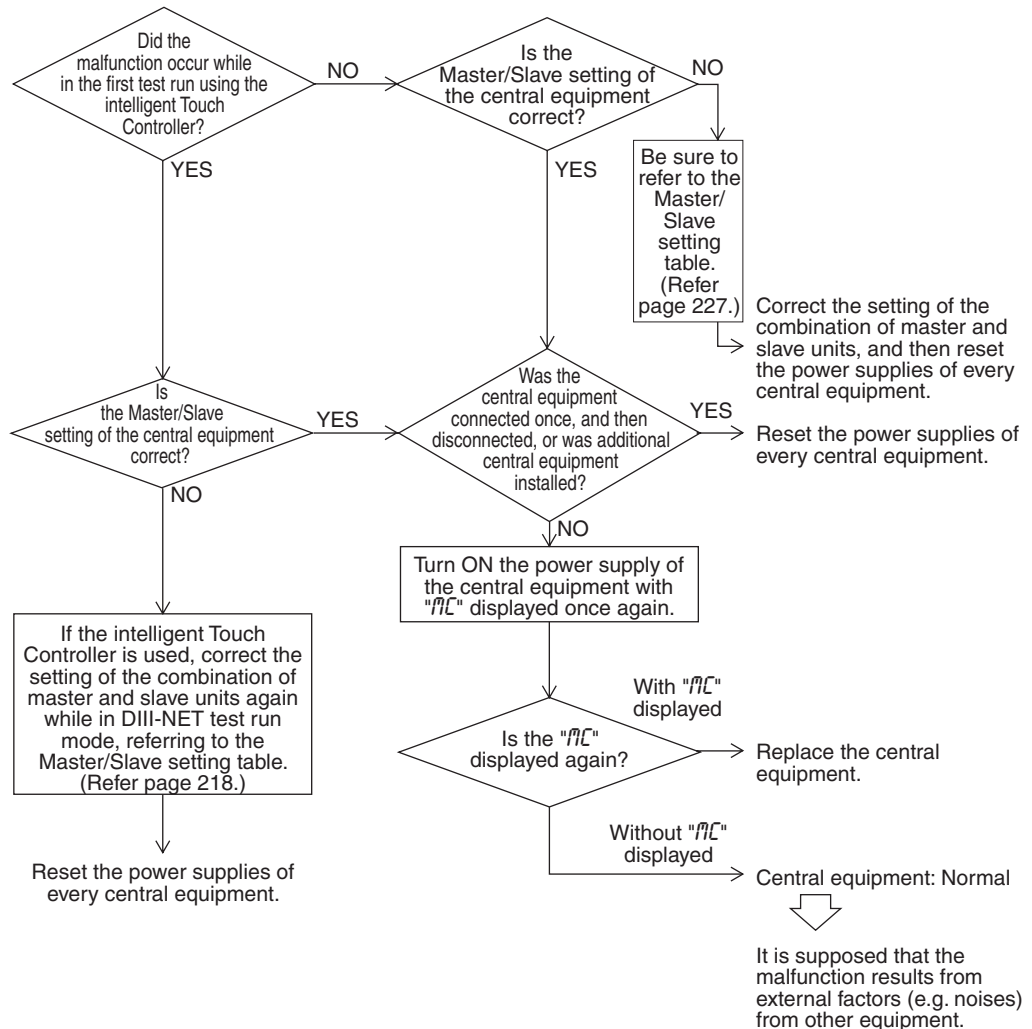

Master-Slave Unit Setting Table

Combination of intelligent Touch Controller and Central remote control



* Pattern	#1		#2		#3		#4	
	1-00~4-15	Master/Slave	5-00~8-15	Master/Slave	1-00~4-15	Master/Slave	5-00~8-15	Master/Slave
①	CRC	Master	CRC	Master	CRC	Slave	CRC	Slave
②	CRC	Master	—	—	CRC	Slave	—	—
③	intelligent Touch Controller	Master	—	—	intelligent Touch Controller	Slave	—	—
④	CRC	Master	—	—	intelligent Touch Controller	Slave	—	—
⑤	intelligent Touch Controller	Master	—	—	CRC	Slave	—	—
⑥	CRC	Master	—	—	—	—	—	—
⑦	intelligent Touch Controller	Master	—	—	—	—	—	—

CRC: Central remote control <DCS302C1>

intelligent Touch Controller: <DCS601C51>

The patterns marked with "" have nothing to do with those described in the list of Setting of master unit central setting connector.

Master Unit Central Connector Setting Table

The master unit central setting connector (CN1/X1A) is mounted at the factory.

- To independently use a single unit of the intelligent Touch Controller or a single unit of the central remote control, do not dismount the master unit central setting connector (i.e., use the connector with the factory setting unchanged).
- To independently use the schedule timer, insert an independent-use setting connector. No independent-use setting connector has been mounted at the factory. Insert the connector, which is attached to the casing of the main unit, in the PC board (CN1/X1A). (Independent-use connector=Master unit central setting connector)
- To use two or more central equipment in combination, make settings according to the table shown below.

Pattern	Central equipment connection pattern				Setting of master unit central setting connector(*2)					
	intelligent Touch Controller	Central remote controller	Unified ON/OFF controller	Schedule timer	intelligent Touch Controller	Central remote controller	Unified ON/OFF controller	Schedule timer		
①	1 to 2 units	/	/	× (*1)	Only a single unit: "Provided", Others: "Not provided"	/	/	/		
②	1 unit	1 unit	/	× (*1)	Provided	Not provided	/	/		
③				× (*1)						
④	1 to 2 units	/	1 to 8 units	× (*1)	Only a single unit: "Provided", Others: "Not provided"	/	All "Not provided"	/		
⑤	/	1 to 4 units	/	/	Only a single unit: "Provided", Others: "Not provided"	/	All "Not provided"	/		
⑥				1 unit				1 to 16 units	1 unit	Not provided
⑦				1 unit				1 to 16 units	1 unit	Not provided
⑧				1 unit				1 to 16 units	1 unit	Not provided
⑨	/	/	/	/	/	/	Only a single unit: "Provided", Others: "Not provided"	/		
⑩	/	/	1 to 16 units	1 unit	/	/	Only a single unit: "Provided", Others: "Not provided"	Not provided		
⑪	/	/	/	1 unit	/	/	/	Provided		

(*1) The intelligent Touch Controller and the schedule timer are not available for combined use.

(*2) The intelligent Touch Controller, central remote control, and the unified ON/OFF controller have been set to "Provided with the master unit central setting connector" at the factory. The schedule timer has been set to "Not provided with the master unit central setting connector" at the factory, which is attached to the casing of the main unit.

Procedures for Detecting Broken Wires in Transmission Wiring for Control

1. Procedure for checking outdoor-outdoor unit transmission wiring for broken wires

On the system shown below, turn OFF the power supply to all equipment, short-circuit between the outdoor-outdoor unit terminal parts F1 and F2 in the "Outdoor Unit A" that is farthest from the central remote control, and then conduct continuity checks between the transmission wiring terminal blocks F1 and F2 of the central remote control using a multiple meter. If there is continuity between the said terminal blocks, the outdoor-outdoor unit transmission wiring has no broken wires in it.

If there is no continuity, the transmission wiring may have broken wires. With the outdoor-outdoor unit terminal parts of the "Outdoor Unit A" short-circuited, conduct continuity checks between the transmission wiring terminal blocks F1 and F2 of the unified ON/OFF controller. If there is no continuity as well, conduct continuity checks between the outdoor-outdoor unit terminal parts of the "Outdoor Unit E", between the outdoor-outdoor unit terminal parts of the "Outdoor Unit D", between the outdoor-outdoor unit terminal parts of the "Outdoor Unit C", ... in the order described, thus identifying the place with continuity.

If the place with continuity can be identified, there may be broken wires in places before the said place with continuity.
2. Procedure for checking indoor-outdoor unit transmission wiring for broken wires (for checking the indoor-outdoor unit transmission wiring of the "Outdoor Unit C" for broken wires)

Turn OFF the power supply to all equipment, short-circuit between the indoor-outdoor unit terminal parts F1 and F2 in the "Outdoor Unit C, and then conduct continuity checks between the transmission wirings F1 and F2 of the "Indoor Unit a" that is farthest from the "Outdoor Unit C" using a multiple meter. If there is continuity between the said transmission wirings, the indoor-outdoor unit transmission wiring has no broken wires in it.

If there is no continuity, the transmission wiring may have broken wires. With the indoor-outdoor unit terminal parts of the "Outdoor Unit C" short-circuited, identify the place with continuity in the transmission wiring of the "Indoor Unit b", transmission wiring of the "Indoor Unit c", and transmission wiring of the "Indoor Unit d" in the order described.

If the place with continuity can be identified, there may be broken wires in places before the said place with continuity.

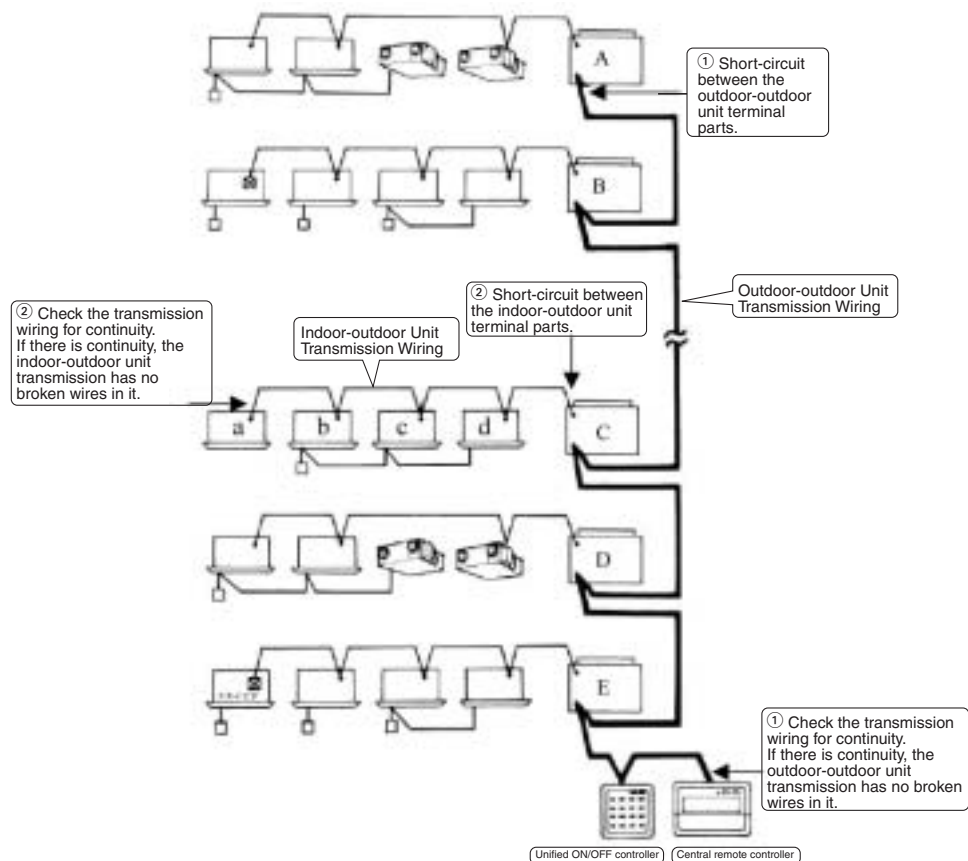

5. Troubleshooting (OP: Unified ON/OFF Controller)

5.1 Operation Lamp Blinks

remote control Display	Operation lamp blinks
Applicable Models	All model of indoor units Unified ON/OFF controller
Method of Malfunction Detection	Detect the malfunction according to DIII-NET transmission data.
Malfunction Decision Conditions	
Supposed Causes	<ul style="list-style-type: none"> ■ Malfunction of transmission between optional central controller and indoor unit ■ Connector for setting master controller is disconnected ■ Defect of unified ON/OFF controller PC board ■ Defect of indoor unit PC board ■ Malfunction of air conditioner

Troubleshooting



Caution

Be sure to turn off power switch before connect or disconnect connector, or parts damage may be occurred.

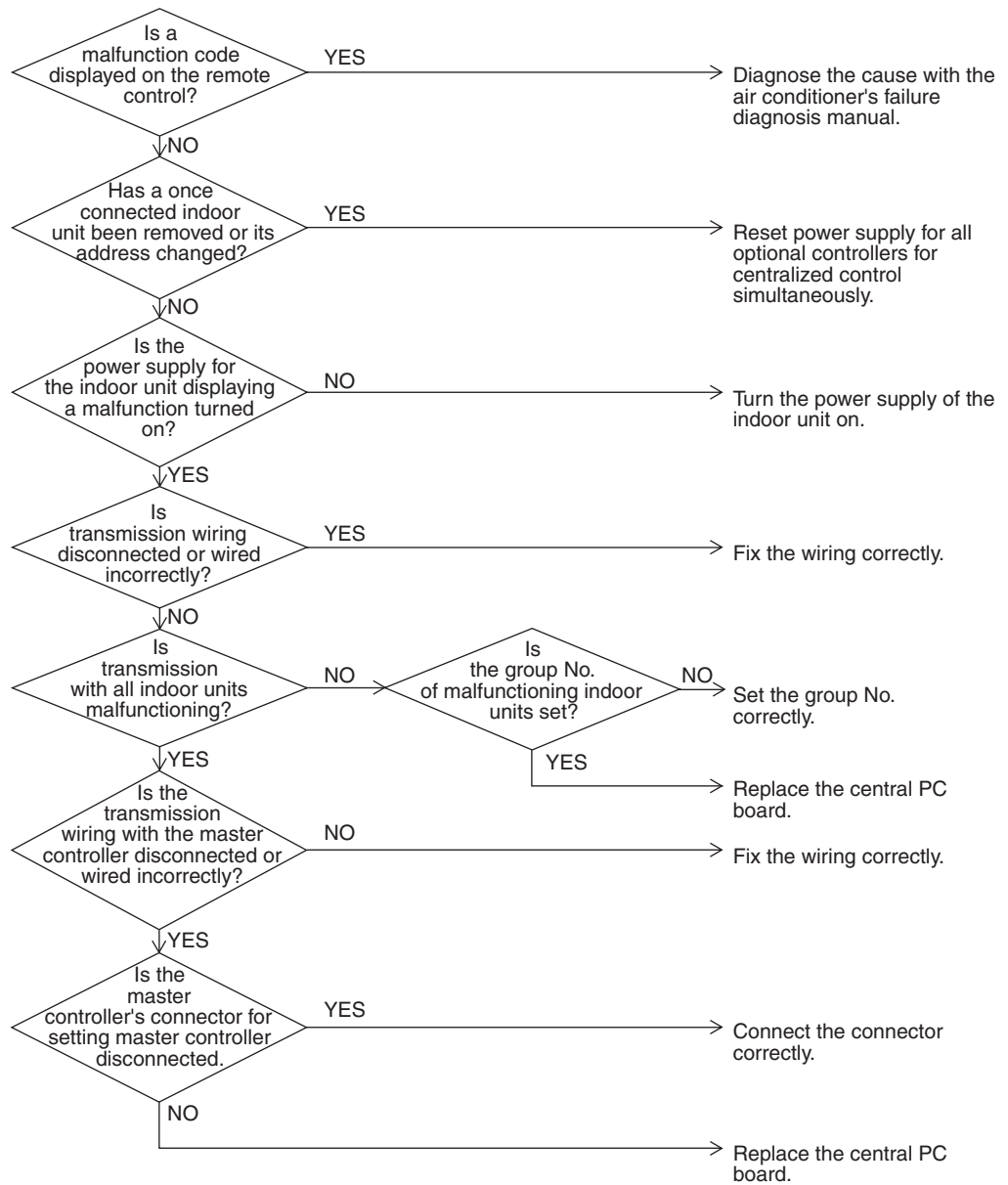

5.2 Display “Under Centralized Control” Blinks (Repeats Single Blink)

remote control Display	 “under centralized control” (Repeats single blink)
Applicable Models	Unified ON/OFF controller Central remote control, Schedule timer
Method of Malfunction Detection	Detect the malfunction according to DIII-NET transmission data.
Malfunction Decision Conditions	When the centralized controller, which was connected once, shows no response. The control ranges are overlapped. When multiple master central controller are present. When the schedule timer is set to individual use mode, other central controller is present. When the wiring adapter for electrical appendices is present.
Supposed Causes	<ul style="list-style-type: none"> ■ Address duplication of optional controllers for centralized control ■ Improper combination of optional controllers for centralized control ■ Connection of more than one master controller ■ Malfunction of transmission between optional controllers for centralized control ■ Defect of PC board of optional controllers for centralized control

Troubleshooting

**Caution**

Be sure to turn off power switch before connect or disconnect connector, or parts damage may be occurred.

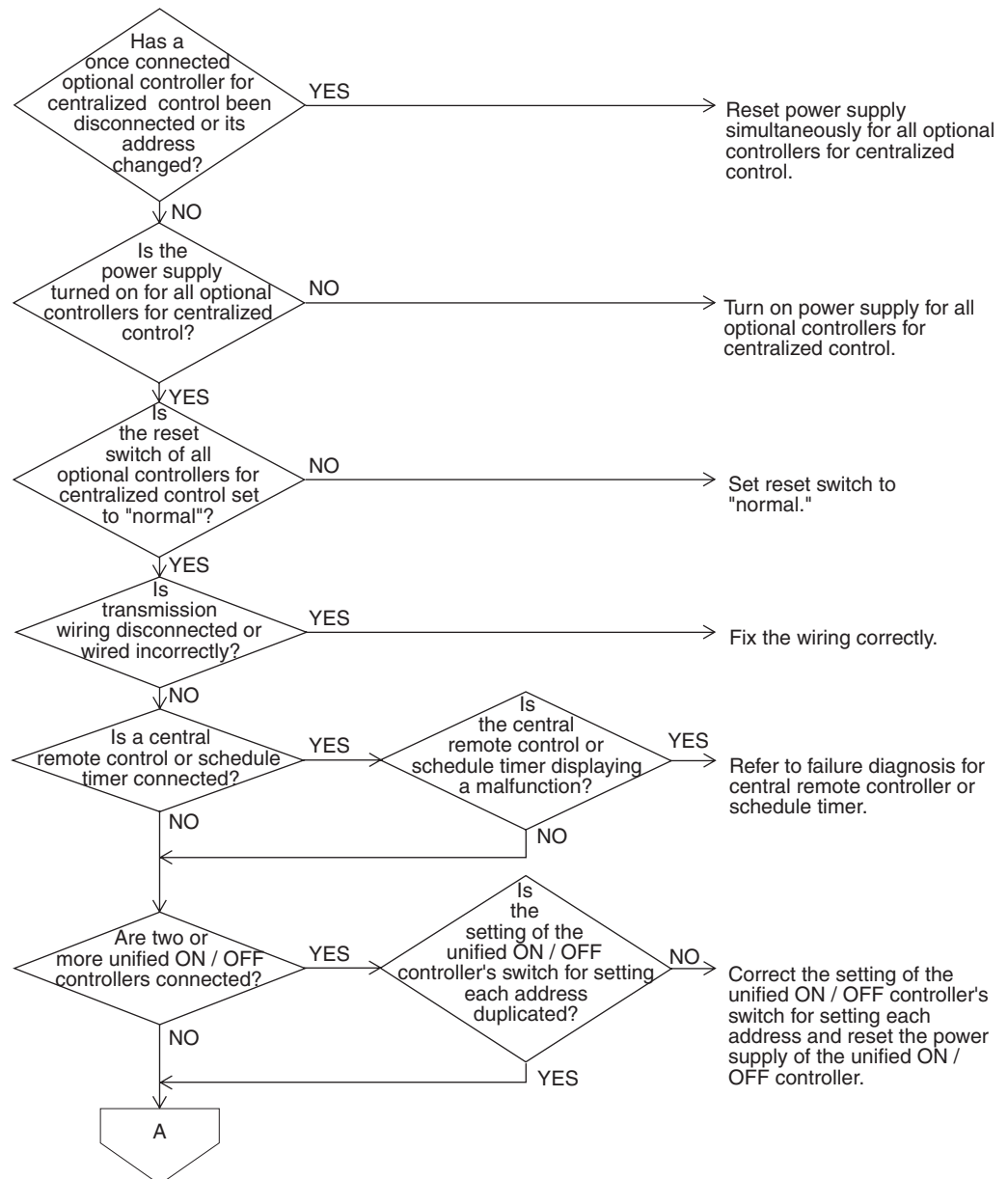

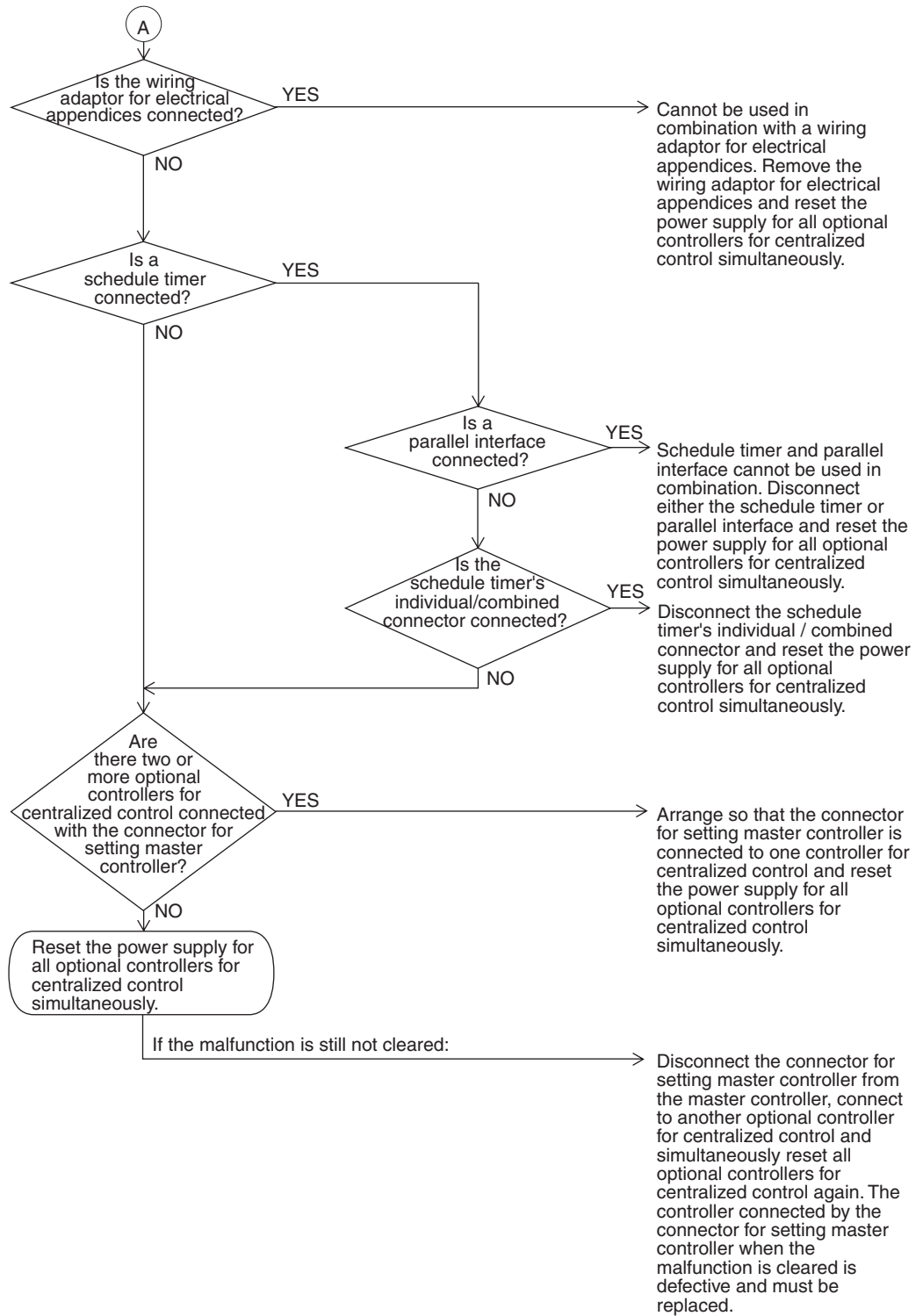

5.3 Display “Under Centralized Control” Blinks (Repeats Double Blink)

remote control Display	 “under centralized control” (Repeats double blink)
Applicable Models	Unified ON/OFF controller
Method of Malfunction Detection	Detect the malfunction according to DIII-NET transmission data.
Malfunction Decision Conditions	When no central control addresses are set to indoor units. When no indoor units are connected within the control range.
Supposed Causes	<ul style="list-style-type: none"> ■ Central control address (group No.) is not set for indoor unit. ■ Improper control range setting switch ■ Improper wiring of transmission wiring

Troubleshooting

Caution

Be sure to turn off power switch before connect or disconnect connector, or parts damage may be occurred.

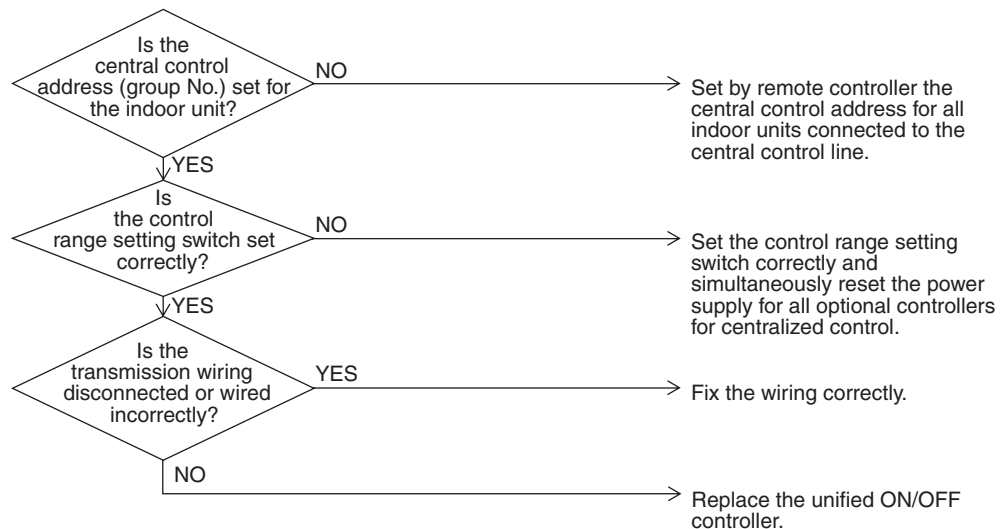

CHECK 1

Check on connector of fan motor (Power supply cable)

(1) Turn off the power supply.

Measure the resistance between phases of U,V,W at the motor side connectors (three-core wire) to check that the values are balanced and there is no short circuiting, while connector or relay connector is disconnected.

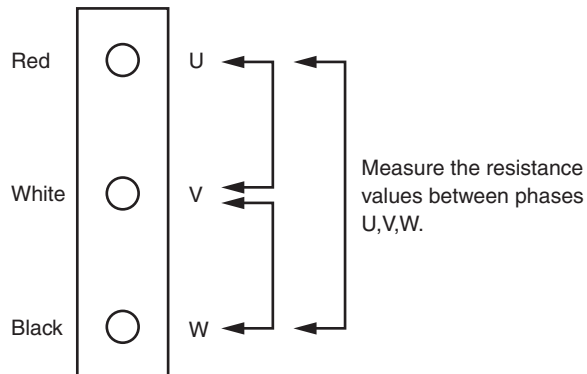

CHECK 2

(1) Turn off the power supply.

(2) Measure the resistance between Vcc and each phase of U,V,W, and GND and each phase at the motor side connectors (five-core wire) to check that the values are balanced within the range of $\pm 20\%$, while connector or relay connector is disconnected.

Furthermore, to use a multiple meter for measurement, connect the probe of negative pole to Vcc and that of positive pole to GND.

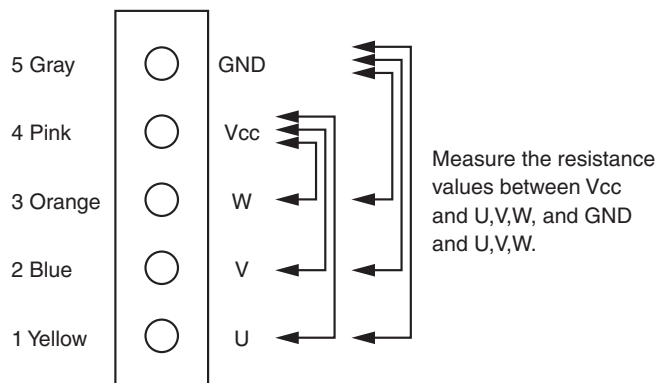

CHECK 3 Check for causes of rise in high pressure

Referring to the Fault Tree Analysis (FTA) shown below, probe the faulty points.

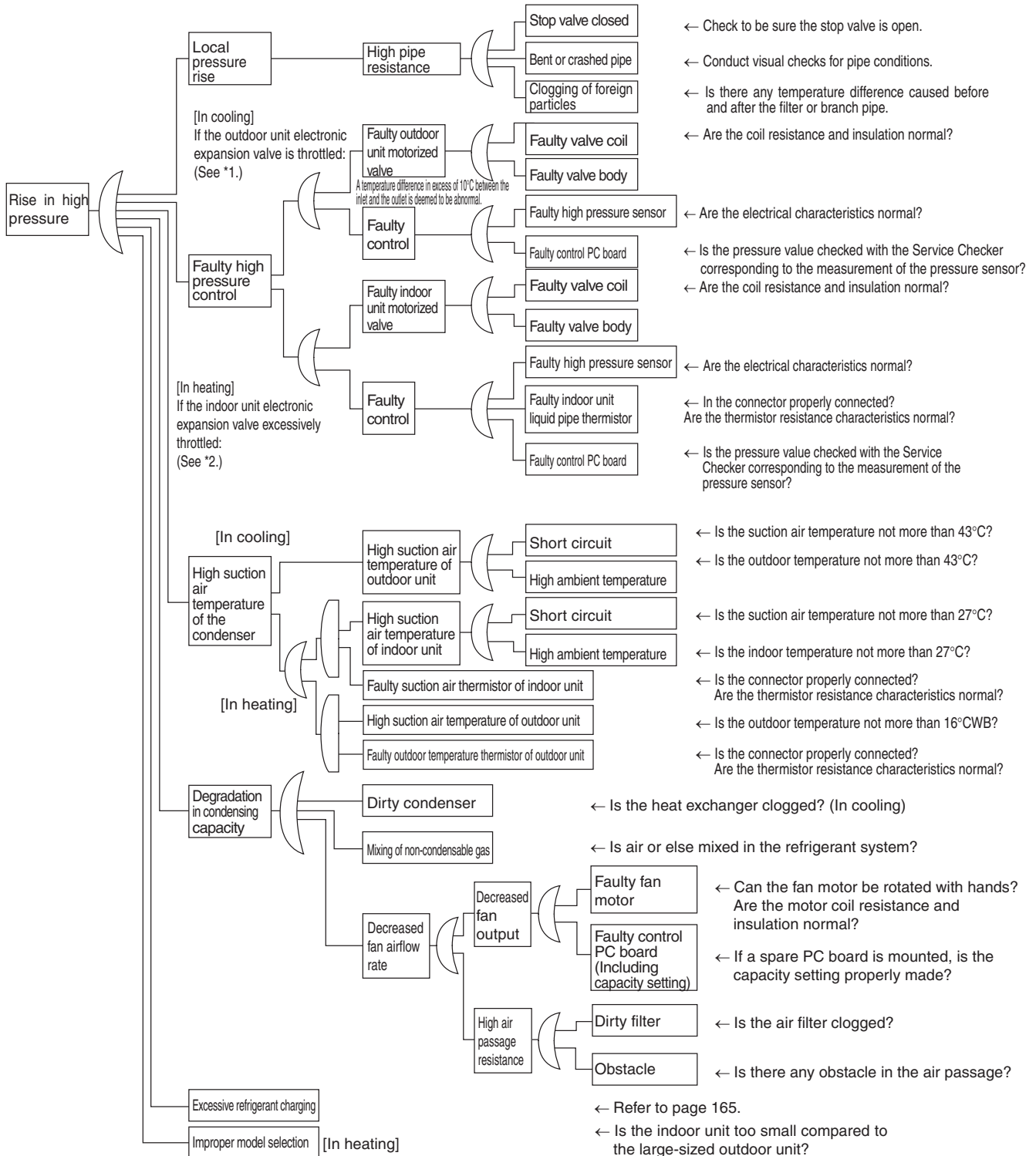

*1: In cooling, it is normal if the outdoor unit electronic expansion valve (EV1) is fully open.
 *2: In heating, the indoor unit electronic expansion valve is used for "subcooled degree control".
 (For details, refer to "Electronic Expansion Valve Control" on page 59.)

SDK04009

CHECK 4 Check for causes of drop in low pressure

Referring to the Fault Tree Analysis (FTA) shown below, probe the faulty points.

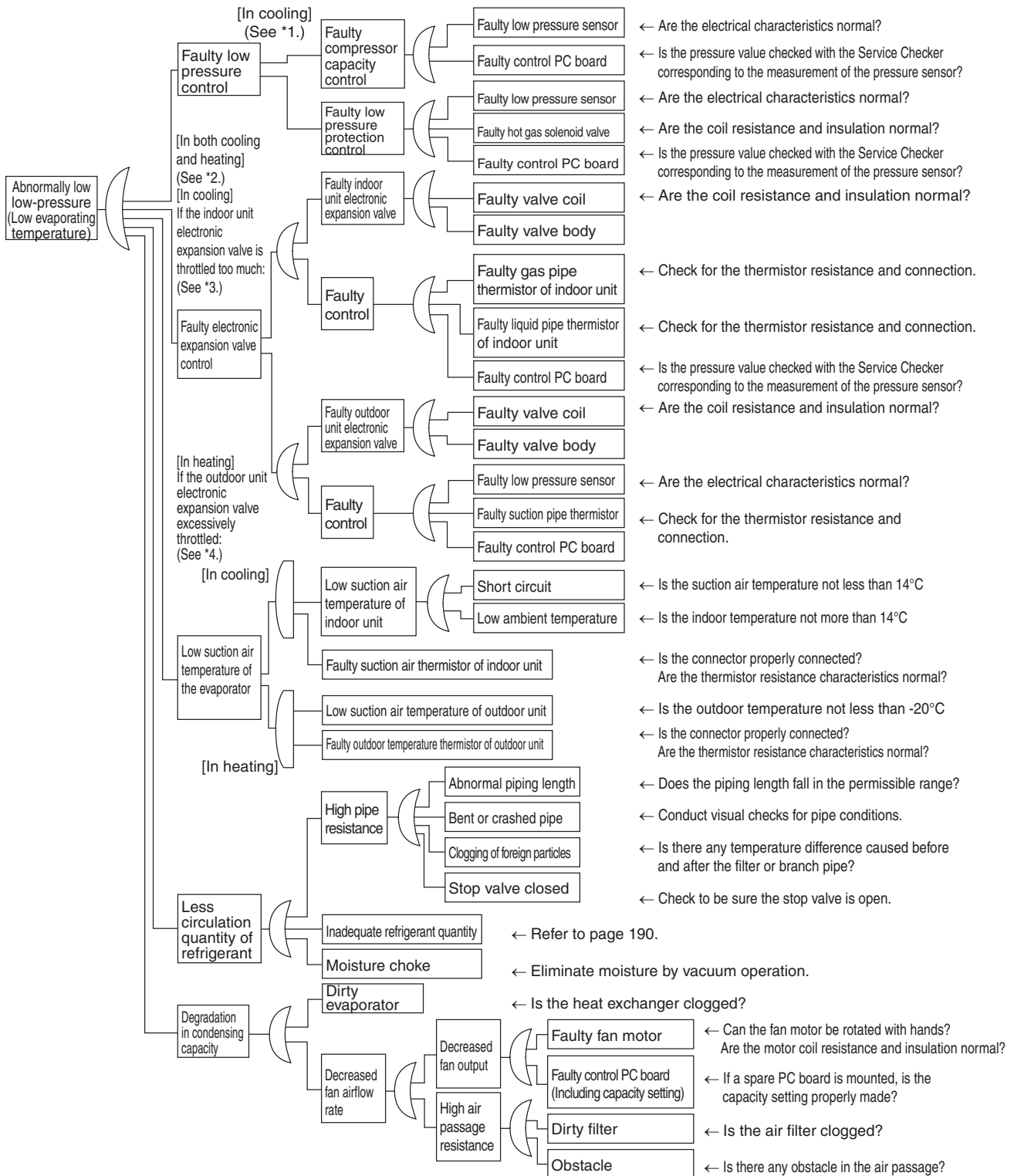

*1: For details of the compressor capacity control while in cooling, refer to "Compressor PI Control" on page 35.

*2: The "low pressure protection control" includes low pressure protection control and hot gas bypass control. For details, refer to page 48.

*3: In cooling, the indoor unit electronic expansion valve is used for "superheated degree control". (For details, refer to page 59.)

*4: In heating, the outdoor unit electronic expansion valve (EV1) is used for "superheated degree control of outdoor unit heat exchanger". (For details, refer to page 37.)

Part 7

Appendix

1. Piping Diagrams	230
1.1 Outdoor Unit	230
1.2 Indoor Unit	232
2. Wiring Diagrams for Reference	233
2.1 Outdoor Unit	233
2.2 Field Wiring	235
2.3 Indoor Unit	236
3. List of Electrical and Functional Parts	239
3.1 Outdoor Unit	239
3.2 Indoor Side	240
4. Option List	241
4.1 Option List of Controllers	241
4.2 Option Lists (Outdoor Unit)	243
5. Example of connection (R-410A Type)	245
6. Thermistor Resistance / Temperature Characteristics	247
7. Pressure Sensor	249
8. Method of Checking the Inverter's Power Transistors and Diode Modules	250
8.1 Method of Checking the Inverter's Power Transistors and Diode Modules	250

1. Piping Diagrams

1.1 Outdoor Unit

CMSQ200A

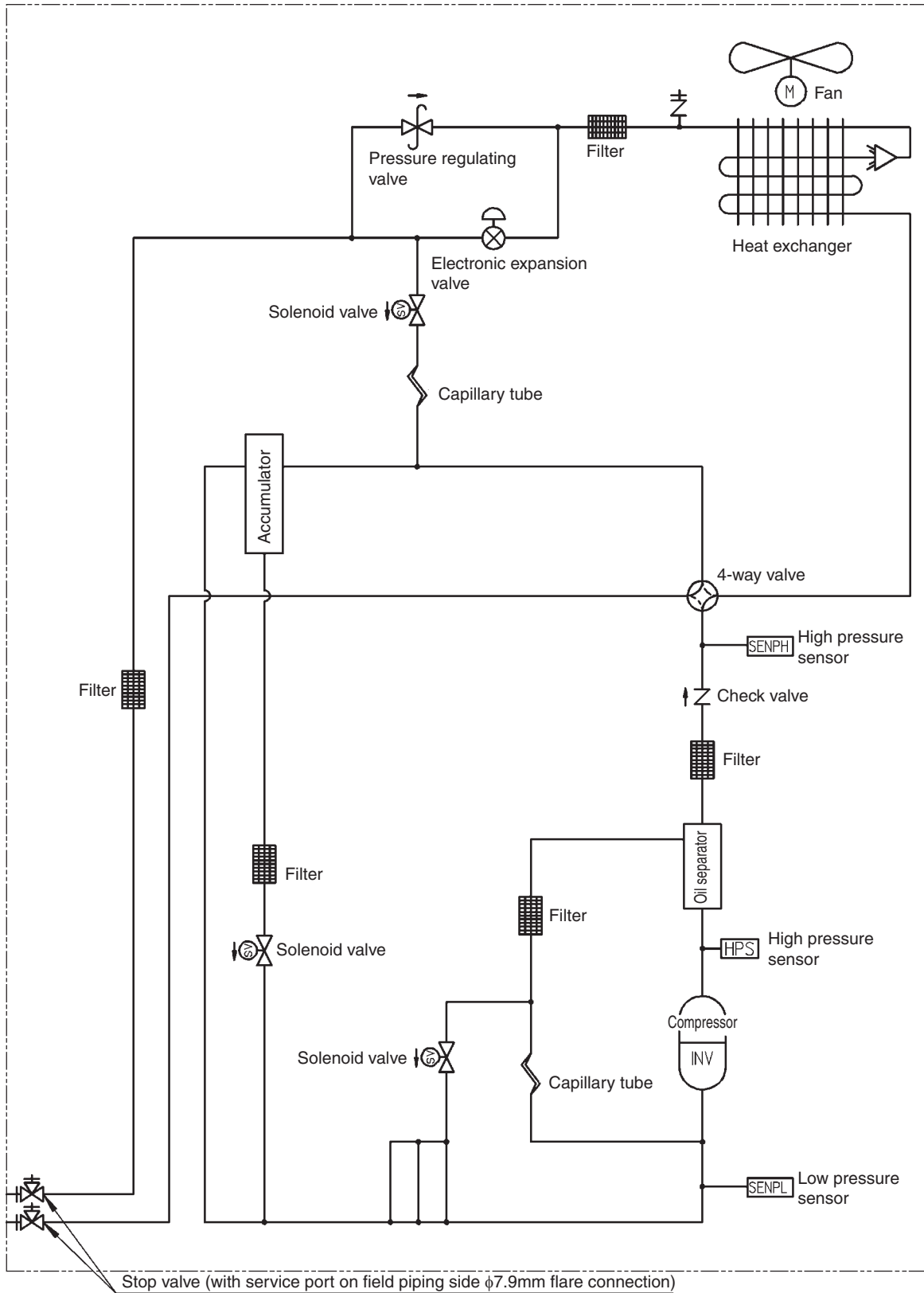

4TW31345-1

CMSQ250A

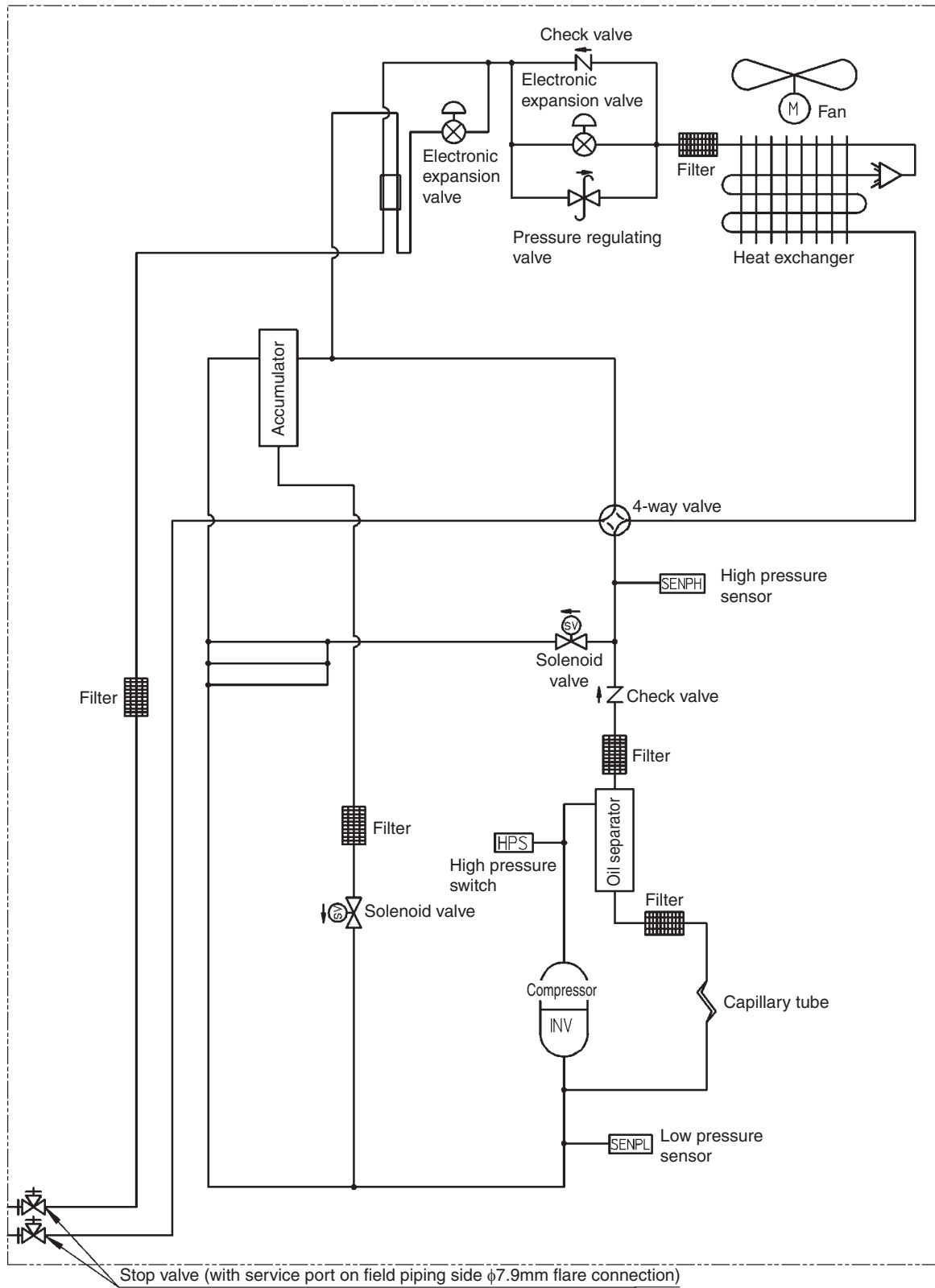

4TW31355-1

1.2 Indoor Unit

FMCQ, FMDQ

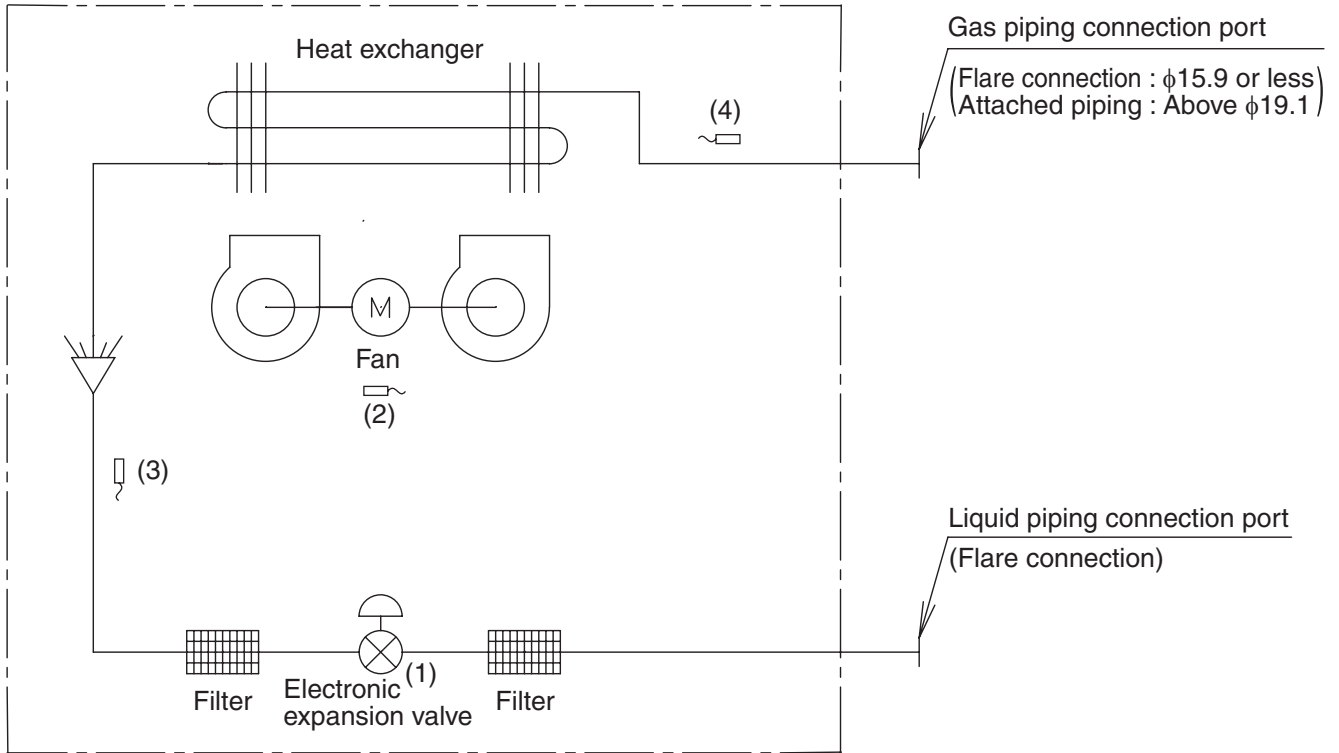

C : 3TW25515-1
C : 3TW31365-1

Code	Name	Code	Main function
(1)	Electronic expansion valve	Y1E	Used for gas superheated degree control while in cooling operation or subcooled degree control while in heating operation.
(2)	Suction air temperature thermistor	R1T	Used for thermostat control.
(3)	Liquid pipe	R2T	Used for gas superheated degree control while in cooling operation or subcooled degree control while in heating operation.
(4)	Gas pipe	R3T	Used for gas superheated degree control while in cooling operation.

(mm)

Model	GAS	Liquid
FMDQ50	φ12.70	φ6.35
FMDQ60, 71, 100, 125	φ15.90	φ9.52
FMCQ50	φ12.70	φ6.35
FMCQ60, 71, 100, 125	φ15.90	φ9.52

CMSQ250A7W1B

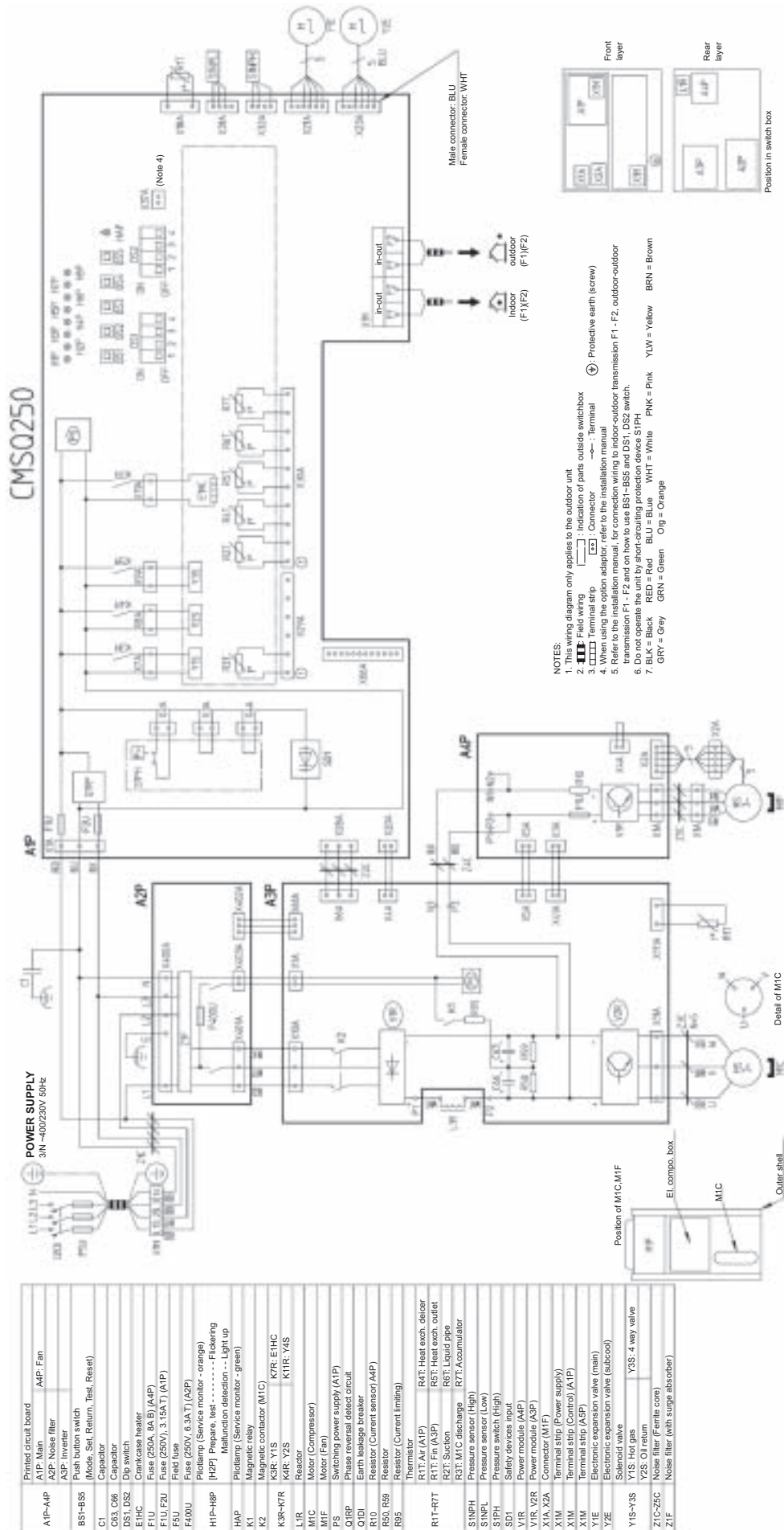

2.2 Field Wiring

CMSQ200A7, 250A7W1B

- 6) Unit shall be grounded in compliance with the applicable local and national codes.
 - 7) Wiring shown are general points-of-connection guides only and are not intended for or to include all details for a specific installation.
 - 8) Be sure to install the switch and the fuse to the power line of each equipment.
 - 9) Install the main switch that can interrupt all the power sources in an integrated manner because this system consists of the equipment utilizing the multiple power sources.
 - 10) If there exists the possibility of reversed phase, lose phase, momentary blackout or the power goes on and off while the product is operating, attach a reversed phase protection circuit locally.
- Running the product in reversed phase may break the compressor and other parts.

- Notes 1) All wiring, components and materials to be procured on the site must comply with the applicable local and national codes.
- 2) Use copper conductors only.
- 3) As for details, see wiring diagram.
- 4) Install circuit breaker for safety.
- 5) All field wiring and components must be provided by licensed electrician.

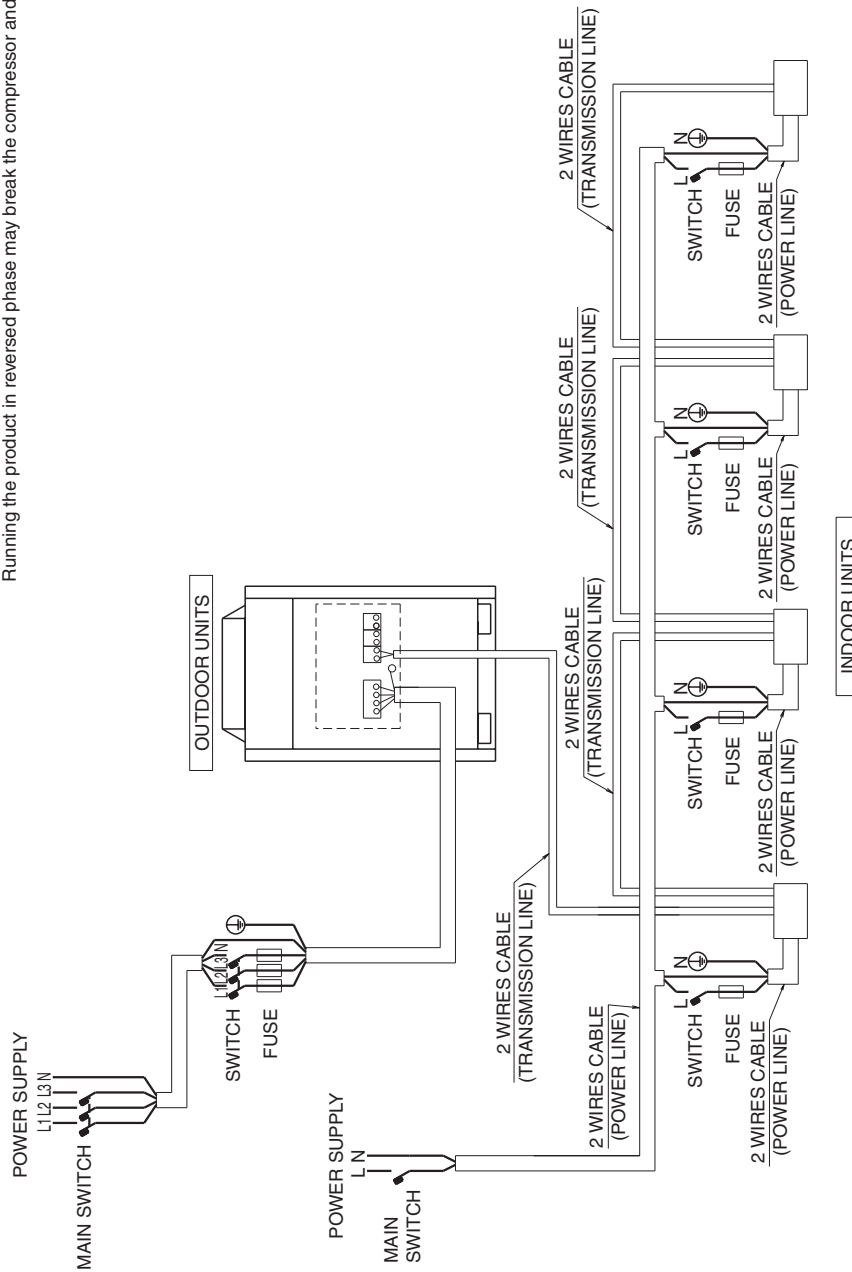

3D051452G

2.3 Indoor Unit

FMCQ50-125A7VEB

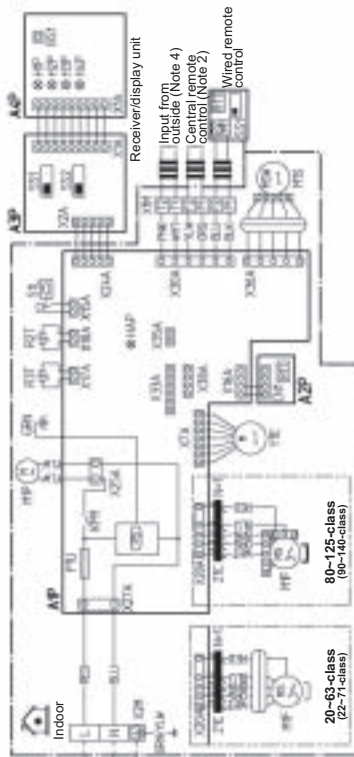

20~25-class (22~140-class)

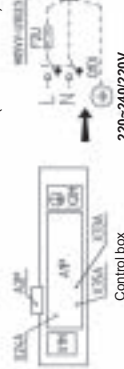

Control box

- Notes:
- Terminal Connector
 - In case of using a central remote control, connect it to the unit in accordance with the attached installation manual.
 - X24A, X33A, X35A and X38A are connected when the optional accessories are being used.
 - When connecting the input wires from outside, forced off or on/off control operation can be selected by the remote control. See installation manual for more details.
 - Confirm the method of setting the selector switch (SS1, SS2) by installation manual and engineering data, etc.
 - Colour legend: BLK: black WHT: white YLW: yellow GRN: green RED: red BLU: blue BRN: brown GRY: grey

Indoor unit		Receiver/display unit (Attached to wireless remote control)	
A1P	Printed circuit board	A3P	Printed circuit board
A2P	Printed circuit board	A4P	Printed circuit board
C1	Capacitor	BST	Push button (On/Off)
F1U	Fuse (T. 5A, 250V)	H1P	Light emitting diode (On - red)
F2U	Field fuse	H2P	Light emitting diode (Timer - green)
HAP	Light emitting diode (Service monitor green)	H3P	Light emitting diode (Filter sign - red)
KPR	Magnetic relay (M1P)	H4P	Light emitting diode
L1	Coil	SS1	Selector switch (Main/sub)
M1F	Motor (Indoor fan)	SS2	Selector switch (Main/sub)
M1E	Motor (Drain pump)		Wireless address set
M1S	Motor (Wiring loop)		Connector for optional parts
PS	Power supply circuit	X24A	Connector (Wireless remote control)
O1D	Earth leakage breaker	X33A	Connector (Adapter for wiring)
R1T	Thermistor (A1)	X35A	Connector (Group control adapter)
R2T	Thermistor (A2)	X38A	Connector (Multi tenant)
R3T	Thermistor (Header)		Wired remote control
S1L	Float switch	R1T	Thermistor (A1)
X1M	Terminal strip	SS1	Selector switch (Main/Sub)
X2M	Terminal strip		
Y1E	Electronic expansion valve		
Z1C	Ferrite core		

3TWD1056-1

FMDQ50-60A7V3B

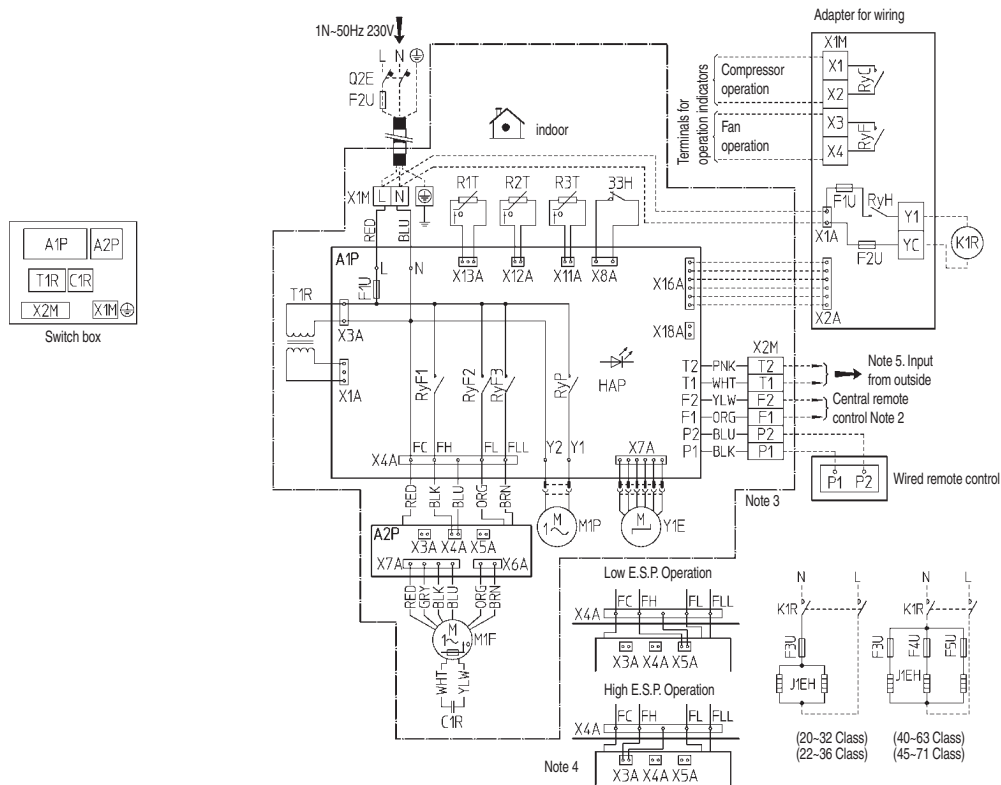

33H	Float switch	R2T,R3T	Thermistor (Refrigerant)	K1R	Magnetic relay (J1EH)
A1P	Printed circuit board	RyF1-3	Magnetic relay (M1F)	Adapter for wiring	
A2P	Terminal board	RyP	Magnetic relay (Drain pump)	RyC,RyF	Magnetic relay
C1R	Capacitor (M1F)	Q2E	Earth leak detector	RyH	Magnetic relay (J1EH)
F1U	Fuse (250V, 5A)	RyA	Magnetic relay (M1S)	F1U, F2U	Fuse (250V, 5A)
F2U	Field fuse	T1R	Transformer (220-240V/22V)	X1A,X2A	Connector (Wiring adapter)
HAP	Light emitting diode (Service monitor-green)	X1M	Terminal strip (Power)	X1M	Terminal strip
M1F	Motor (Fan)	X2M	Terminal strip (Control)	Connector for optional parts	
M1P	Motor (Drain pump)	Y1E	Electronic expansion valve	X16A	Connector (Wiring adapter)
Q2E	Earth leak detector	Optional parts		X18A	Connector (Wiring adapter for electrical appendices)
R1T	Thermistor (Air)	F3-5U	Fuse (250V, 16A)		
		J1EH	Electric heater		

- : Field wiring
- L : Live
- N : Neutral
- : Connector
- : Wire clamp
- : Protective earth (screw)

- Colors:
- BLK: Black
 - BLU: Blue
 - BRN: Brown
 - ORG: Orange
 - PNK: Pink
 - RED: Red
 - WHT: White
 - YLW: Yellow

2TW23686-1C

NOTES

- 1 Use copper conductors only.
- 2 When using the central remote control, see manual for connection to the unit.
- 3 When installing the electric heater, change the wiring for the heater circuit. The main powersupply has to be supplied independently.
- 4 For high or low E.S.P. operation, change the wiring connection of X4A as shown on the wiring diagram.
- 5 When connecting the input wires from outside, forced off or on/off operation can be selected by remote controller. See installation manual for more details.

FMDQ71-125A7V3B

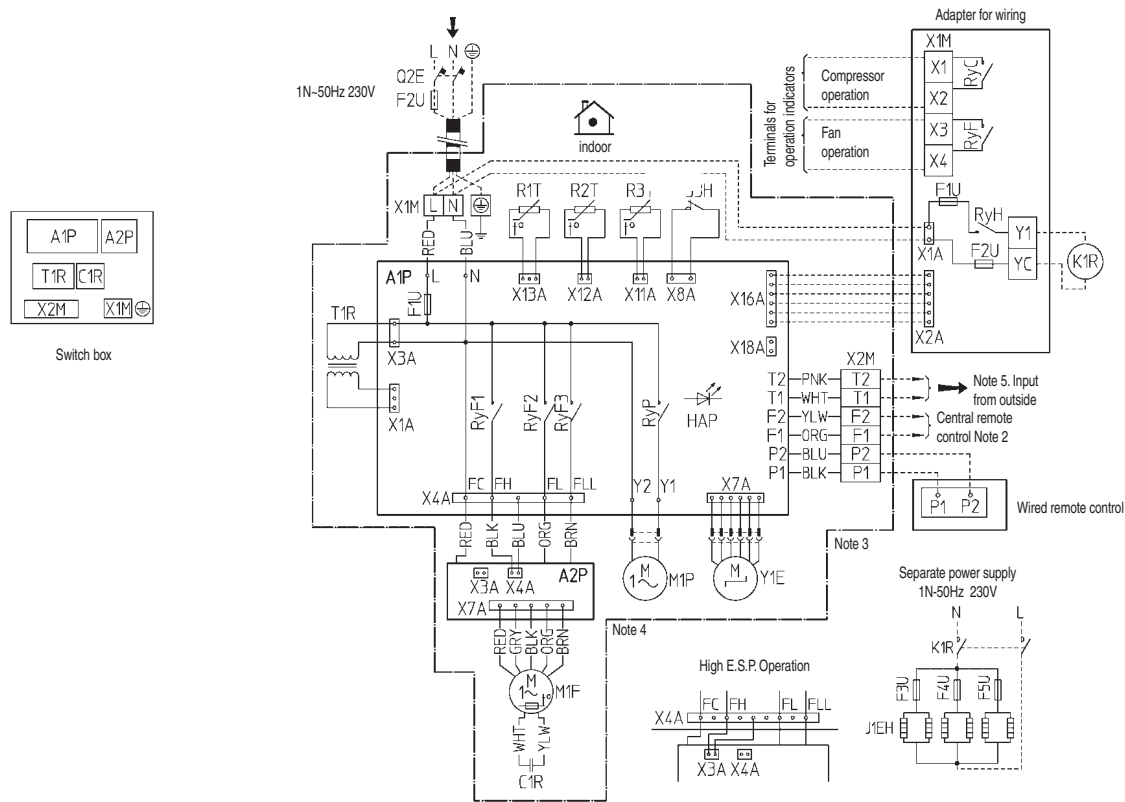

33H	Float switch	R2T,R3T	Thermistor (Refrigerant)	K1R	Magnetic relay (J1EH)
A1P	Printed circuit board	RyF1-3	Magnetic relay (M1F)	Adapter for wiring	
A2P	Terminal board	RyP	Magnetic relay (M1P)	RyC,RyF	Magnetic relay
C1R	Capacitor (M1F)	Q2E	Earth leak detector	RyH	Magnetic relay (J1EH)
F1U	Fuse (250V, 5A)	RyA	Magnetic relay (M1S)	F1U, F2U	Fuse (250V, 5A)
F2U	Field fuse	T1R	Transformer (220-240V/220V)	X1A,X2A	Connector (Wiring adapter)
HAP	Light emitting diode (Service monitor-green)	X1M	Terminal strip (Power)	X1M	Terminal strip
M1F	Motor (Fan)	X2M	Terminal strip (Control)	Connector for optional parts	
M1P	Motor (Drain pump)	Y1E	Electronic expansion valve	X16A	Connector (Wiring adapter)
Q2E	Earth leak detector	Optional parts		X18A	Connector (Wiring adapter for electrical appendices)
R1T	Thermistor (Air)	F3-5U	Fuse (250V, 16A)		
		J1EH	Electric heater		

- : Field wiring
- L : Live
- N : Neutral
- : Connector
- : Wire clamp
- : Protective earth (screw)

- Colors:
- BLK: Black
 - BLU: Blue
 - BRN: Brown
 - ORG: Orange
 - PNK: Pink
 - RED: Red
 - WHT: White
 - YLW: Yellow

2TW23736-1C

NOTES

- 1 Use copper conductors only.
- 2 When using the central remote control, see manual for connection to the unit.
- 3 When installing the electric heater, change the wiring for the heater circuit. The main powersupply has to be supplied independently.
- 4 For high or low E.S.P. operation, change the wiring connection of X4A as shown on the wiring diagram.
- 5 When connecting the input wires from outside, forced off or on/off operation can be selected by remote controller. See installation manual for more details.

3. List of Electrical and Functional Parts

3.1 Outdoor Unit

3.1.1 CMSQ200A7W1B~250A7W1B

Item	Name		Symbol	Model	
				CMSQ200A7W1B	CMSQ250A7W1B
Compressor	Inverter	Type	M1C	JT1GCVDKYR@TA	
		OC Protection Device		14.7A	
	STD 1	Type	M2C	—	
		OC Protection Device		—	
	STD 2	Type	M3C	—	
		OC Protection Device		—	
Fan Motor		OC Protection Device	M1F	1.15A	3A
Electronic Expansion Valve (Main)			Y1E	Fully Closed: 0pls	Fully Open: 480pls
Electronic Expansion Valve (Subcool)			Y2E	—	Fully Closed: 0pls Fully Open: 480pls
Pressure Protection	High Pressure Switch	For M1C	S1PH	OFF: $4.0^{+0}_{-0.12}$ MPa ON: 3.0 ± 0.15 MPa	
		For M2C	S2PH	—	
		For M3C	S3PH	—	
	Low Pressure Sensor		SENPL	OFF: 0.07MPa	
Temperature Protection	Discharge Gas Temperature Protection (Discharge Pipe Thermistor)		R3T	OFF: 135°C	
	Inverter Fin Temperature Protection (Radiator Fin Thermistor)		R1T	OFF: 93°C	
Others	Fuse	For Main PC Board	A1P	250V, 15A	
			A2P	250V, 3A	
		For Noise Filter PC Board	F1U	250V AC 5A Class B	

3.2 Indoor Side

3.2.1 Indoor Unit

Parts Name		Symbol	Model					Remark
			FMCQ50A7VEB	FMCQ60A7VEB	FMCQ71A7VEB	FMCQ100A7VEB	FMCQ125A7VEB	
Remote Controller	Wired remote control		BRC1C62					Option
	infrared remote control		BRC7F634F					
Motors	Fan Motor	M1F	DC280V 56W 8P			DC 320V 120W 8P		
	Drain Pump	M1P	AC220-240V (50Hz) PLD-12230DM Thermal Fuse 145°C					
	Swing Motor	M1S	MP35HCA[3P080801-1] Stepping Motor DC12V					
Thermistors	Thermistor (Suction Air)	R1T	In PC board A2P or wired remote control					
	Thermistor (for Heat Exchanger High Temp.)	R3T	ST8605-14 ϕ 8 L1000 20k Ω (25°C)					
	Thermistor (Heat Exchanger)	R2T	ST8602A-15 ϕ 6 L1000 20k Ω (25°C)					
Others	Float Switch	S1L	FS-0211B					
	Fuse	F1U	250V 5A ϕ 5.2					
	Thermal Fuse	TFu	—					
	Transformer	T1R	—					

Parts Name		Symbol	Model					Remark
			FMDQ50A7V3B	FMDQ60A7V3B	FMDQ71A7V3B	FMDQ100A7V3B	FMDQ125A7V3B	
Remote Controller	Wired remote control		BRC1C62					Option
	infrared remote control		BRC4C62					
Motors	Fan Motor	M1F	AC 220~240V 50Hz					
			1 ϕ 65W	1 ϕ 85W	1 ϕ 125W	1 ϕ 225W		
	Drain Pump	M1P	Thermal Fuse 152°C			Thermal protector 135°C : OFF 87°C : ON		
Thermistors	Thermistor (Suction Air)	R1T	ST8601-4 ϕ 4 L800 20k Ω (25°C)					
	Thermistor (for Heat Exchanger High Temp.)	R3T	ST8605-7 ϕ 8 L1600 20k Ω (25°C)					
	Thermistor (Heat Exchanger)	R2T	ST8602A-6 ϕ 6 L1250 20k Ω (25°C)					
Others	Float Switch	S1L	FS-0211B					
	Fuse	F1U	250V 5A ϕ 5.2					
	Transformer	T1R	TR22H21R8					

4. Option List

4.1 Option List of Controllers

Operation Control System Optional Accessories

No.	Item	Type	FMCQ-A7	FMDQ-A7
			Wireless	BRC7F634F
1	remote control	Wired		BRC1C62
2	Wired remote control with weekly schedule timer			BRC1D61
3	Simplified remote control		—	Note 8 BRC2C51
4	remote control for hotel use		—	BRC3A61
5	adapter for wiring		★KRP1C63	KRP1B61
6-1	Wiring adapter for electrical appendices (1)		★KRP2A62	KRP2A61
6-2	Wiring adapter for electrical appendices (2)		★KRP4AA53	KRP4A51
7	Remote sensor		KRCS01-4B	KRCS01-1
8	Installation box for adapter PC board		Note 2, 3 KRP1H98	Note 5 KRP4A91
9	Central remote control			DCS302CA61
9-1	Electrical box with earth terminal (3 blocks)			KJB311AA
10	Unified on/off controller			DCS301BA61
10-1	Electrical box with earth terminal (2 blocks)			KJB212AA
10-2	Noise filter (for electromagnetic interface use only)			KEK26-1A
11	Schedule timer			DST301BA61
12	External control adapter for outdoor unit (Must be installed on indoor units)		★DTA104A62	DTA104A61
13	Interface adapter for SkyAir-series			—

Note:

1. Installation box (No.8) is necessary for each adapter marked ★.
2. Up to 2 adapters can be fixed for each installation box.
3. Only one installation box can be installed for each indoor unit.
4. Up to 2 installation boxes can be installed for each indoor unit.
5. Installation box (No. 8) is necessary for second adapter.
6. Installation box (No. 8) is necessary for each adapter.
7. This adapter is required when connecting with optional controller for centralized control.
8. BRC2A51 is also available.

Various PC Boards

No.	Part name	Model No.	Function
1	adapter for wiring	KRP1B56 KRP1B57 KRP1B59 KRP1B61 KRP1C3	■ PC board when equipped with auxiliary electric heater in the indoor unit.
2	DIII-NET Expander adapter	DTA109A51	■ Up to 1024 units can be centrally controlled in 64 different groups. ■ Wiring restrictions (max. length: 1000m, total wiring length: 2000m, max. number of branches: 16) apply to each adapter.

System Configuration

No.	Item	Model No.	Function
1	Residential central remote control	Note *2 DCS303A51	■ Up to 16 groups of indoor units (128 units) can be easily controlled using the large LCD panel. ON/OFF, temperature settings and scheduling can be controlled individually for indoor units.
2	Central remote control	DCS302CA61	■ Up to 64 groups of indoor units(128 units) can be connected, and ON/OFF, temperature setting and monitoring can be accomplished individually or simultaneously. Connectable up to 2 controllers in one system.
2-1	Electrical box with earth terminal (3 blocks)	KJB311AA	
3	Unified ON/OFF controller	DCS301BA61	■ Up to 16 groups of indoor units(128 units) can be turned, ON/OFF individually or simultaneously, and operation and malfunction can be displayed. Can be used in combination with up to 8 controllers.
3-1	Electrical box with earth terminal (2 blocks)	KJB212AA	
3-2	Noise filter (for electromagnetic interface use only)	KEK26-1A	
4	Schedule timer	DST301BA61	■ Programmed time weekly schedule can be controlled by unified control for up to 64 groups of indoor units (128 units). Can turn units ON/OFF twice per day.
5	Interface adapter for SkyAir-series	For SkyAir, FD(Y)M-FA, FDY-KA, FDYB-KA, FVY(P)J-A *DTA102A52	■ adapters required to connect products other than those of the System to the high-speed DIII-NET communication system adopted for the System. * To use any of the above optional controllers, an appropriate adapter must be installed on the product unit to be controlled.
6	Central control adapter kit	For UAT(Y)-K(A),FD-K *DTA107A55	
7	Wiring adapter for other air-conditioner	*DTA103A51	■ Up to 1024 units can be centrally controlled in 64 different groups. ■ Wiring restrictions (max. length : 1,000m, total wiring length : 2,000m, max. number of branches : 16) apply to each adapter.
8	DIII-NET Expander adapter	DTA109A51	
8-1	Mounting plate	KRP4A92	■ Fixing plate for DTA109A51

Note:

1. Installation box for * adapter must be obtained locally.
2. For residential use only. Cannot be used with other centralized control equipment.

Building Management System

No.	Part name				Model No.	Function	
1	intelligent Touch Controller	Basic	Hardware	intelligent Touch Controller	DCS601C51	■ Air-Conditioning management system that can be controlled by a compact all-in-one unit.	
1-1		Option	Hardware	DIII-NET plus adapter	DCS601A52	■ Additional 64 groups (10 outdoor units) is possible.	
1-2			Software	P.P.D.	DCS002C51	■ P. P. D.: Power Proportional Distribution function	
1-3			Web	DCS004A51	■ Monitors and controls the air conditioning system using the Internet and a Web browser application on a PC.		
1-4	Electrical box with earth terminal (4 blocks)				KJB411A	■ Wall embedded switch box.	
2	intelligent Manager III	Basic	Hardware	Number of units to be connected	128 units	DAM602B52	■ Air conditioner management system that can be controlled by personal computers.
					256 units	DAM602B51	
					512 units	DAM602B51x2	
					768 units	DAM602B51x3	
					1024 units	DAM602B51x4	
2-1	Option	Software	P.P.D.	DAM002A51	■ Power Proportional Distribution function		
2-2			Web	DAM004A51	■ Monitors and controls the air conditioning system using the Internet and a Web browser application on a PC.		
2-3			Eco	DAM003A51	■ ECO (Energy saving functions.)		
2-4	Optional DIII Ai unit				DAM101A51	■ External temperature sensor for intelligent Manager III.	
2-5	Di unit				DEC101A51	■ 8 pairs based on a pair of On/Off input and abnormality input.	
2-6	Dio unit				DEC102A51	■ 4 pairs based on a pair of On/Off input and abnormality input.	
3	Communication line	*1 Interface for use in BACnet®			DMS502B51	■ Interface unit to allow communications between system and BMS. Operation and monitoring of air-conditioning systems through BACnet® communication.	
3-1		Optional DIII board			DAM411B51	■ Expansion kit, installed on DMS502B51, to provide 2 more DIII-NET communication ports. Not usable independently.	
3-2		Optional Di board			DAM412B51	■ Expansion kit, installed on DMS502B51, to provide 16 more wattmeter pulse input points. Not usable independently.	
4		*2 Interface for use in LONWORKS®			DMS504B51	■ Interface unit to allow communications between system and BMS. Operation and monitoring of air-conditioning systems through LONWORKS® communication.	
5	Contact/analog signal	Parallel interface Basic unit			DPF201A51	■ Enables ON/OFF command, operation and display of malfunction; can be used in combination with up to 4 units.	
6		Temperature measurement units			DPF201A52	■ Enables temperature measurement output for 4 groups; 0-5VDC.	
7		Temperature setting units			DPF201A53	■ Enables temperature setting input for 16 groups; 0-5VDC.	
8		Unification adapter for computerized control			* DCS302A52	■ Interface between the central monitoring board and central control units.	

Note:

- *1. BACnet® is a registered trademark of American Society of Heating, Refrigerating and Air-Conditioning Engineers (ASHRAE).
- *2. LONWORKS® is a registered trade mark of Echelon Corporation.
- *3. Installation box for * adapter must be procured on site.

4.2 Option Lists (Outdoor Unit)

No	Item	CMSQ200	CMSQ250
1	REFNET Header	KHRQ22M29H	
2	REFNET Joint	KHRQ22M20T	
			KHRQ22M29T9
3	Central Drain Pan Kit	KWC26B160	KWC26B280

Notes:

1. All options are kits.
2. The option should be installed inside the outdoor unit.

4TW31341-1

4.3 Example of connection (R-410A Type)

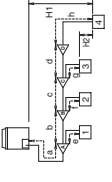
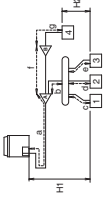
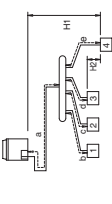
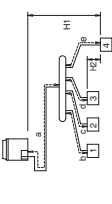
Example of connection (Connection of 4 indoor units Heat Pump system) 		One outdoor unit installed	Branch with refnet joint	Branch with refnet joint and refnet header	Branch with refnet header										
															
Maximum allowable length	Between outdoor and indoor units	Actual pipe length	Pipe length between outdoor and indoor units ≤165m [Example] unit 4: a+b+e ≤165m	[Example] unit 3: a+b+e ≤165m, unit 4: a+f+g ≤165m	[Example] unit 4: a+e ≤165m										
	Between outdoor and indoor units	Equivalent length	Equivalent pipe length between outdoor and indoor units ≤190 m (Assume equivalent pipe length of refnet joint to be 0.5 m and of the refnet header to be 1.0 m. (for calculation purposes))												
Allowable height	Between outdoor and indoor units	Total extension length	Total piping length from outdoor unit to all indoor units ≤200 m												
	Between indoor and indoor units	Difference in height	Difference in height between adjacent indoor units (H1) ≤30 m												
Allowable length after the branch	Between indoor and indoor units	Difference in height	Difference in height between adjacent indoor units (H2) ≤4 m												
		Actual pipe length	Pipe length from first refrigerant branch kit (either refnet joint or refnet header) to indoor unit ≤40 m (See note on next page) [Example] unit 4: b+c+d+h ≤40 m	[Example] unit 3: b+e ≤40 m, unit 4: f+g ≤40 m	[Example] unit 4: e ≤40 m										
Refrigerant branch kit selection Refrigerant branch kits can only be used with R-410A.			How to select the refnet joint <ul style="list-style-type: none"> When using refnet joints at the first branch counted from the outdoor unit side. Choose from the following table in accordance with the capacity of the outdoor unit. <table border="1"> <thead> <tr> <th>Outdoor unit capacity type</th> <th>Refrigerant branch kit name</th> </tr> </thead> <tbody> <tr> <td>CMSQ200</td> <td>KHRQ22M20T</td> </tr> <tr> <td>CMSQ250</td> <td>KHRQ22M29T9</td> </tr> </tbody> </table> <ul style="list-style-type: none"> For refnet joints other than the first branch, select the proper branch kit model based on the total capacity index. 	Outdoor unit capacity type	Refrigerant branch kit name	CMSQ200	KHRQ22M20T	CMSQ250	KHRQ22M29T9	How to select the refnet header <ul style="list-style-type: none"> Choose from the following table in accordance with the total capacity of all the indoor units connected below the refnet header. <table border="1"> <thead> <tr> <th>Indoor capacity type</th> <th>Refrigerant branch kit name</th> </tr> </thead> <tbody> <tr> <td>50~125</td> <td>KHRQ22M29H</td> </tr> </tbody> </table>	Indoor capacity type	Refrigerant branch kit name	50~125	KHRQ22M29H	
	Outdoor unit capacity type	Refrigerant branch kit name													
CMSQ200	KHRQ22M20T														
CMSQ250	KHRQ22M29T9														
Indoor capacity type	Refrigerant branch kit name														
50~125	KHRQ22M29H														
Example of downstream indoor units			[Example] in case of refnet joint C; indoor units 3+4	[Example] in case of refnet joint B; indoor unit 4, in case of refnet header; indoor units 1+2+3+4	[Example] in case of refnet header; indoor units 1+2+3+4										

<p>Pipe size selection</p> <p>A,B,C. Piping between outdoor unit and refrigerant branch kit</p> <ul style="list-style-type: none"> Choose from the following table in accordance with the outdoor unit total capacity type, connected downstream. <p>Outdoor unit connection piping size</p> <table border="1"> <thead> <tr> <th rowspan="2">Outdoor unit capacity type</th> <th colspan="2">Piping size (outer diameter) (mm)</th> </tr> <tr> <th>Gas pipe</th> <th>Liquid pipe</th> </tr> </thead> <tbody> <tr> <td>CMSQ200</td> <td>Ø15.9</td> <td>Ø9.5</td> </tr> <tr> <td>CMSQ250</td> <td>Ø19.1</td> <td>Ø9.5</td> </tr> </tbody> </table>	Outdoor unit capacity type	Piping size (outer diameter) (mm)		Gas pipe	Liquid pipe	CMSQ200	Ø15.9	Ø9.5	CMSQ250	Ø19.1	Ø9.5	<p>D. Piping between refrigerant branch kits</p> <ul style="list-style-type: none"> Choose from the following table in accordance with the total capacity of all the indoor units connected below this. Do not let the connection piping exceed the refrigerant piping size chosen by general system model name. <table border="1"> <thead> <tr> <th rowspan="2">Indoor or outdoor unit total capacity</th> <th colspan="2">Piping size (outer diameter) (mm)</th> </tr> <tr> <th>Gas pipe</th> <th>Liquid pipe</th> </tr> </thead> <tbody> <tr> <td><150</td> <td>Ø15.9</td> <td>Ø9.5</td> </tr> <tr> <td>150≤x<200</td> <td>Ø19.1</td> <td>Ø9.5</td> </tr> <tr> <td>200≤x<250</td> <td>Ø22.2</td> <td>Ø9.5</td> </tr> </tbody> </table>	Indoor or outdoor unit total capacity	Piping size (outer diameter) (mm)		Gas pipe	Liquid pipe	<150	Ø15.9	Ø9.5	150≤x<200	Ø19.1	Ø9.5	200≤x<250	Ø22.2	Ø9.5	<p>E. Piping between refrigerant branch kit and indoor unit</p> <ul style="list-style-type: none"> Pipe size for direct connection to indoor unit must be the same as the connection size of indoor unit. <table border="1"> <thead> <tr> <th rowspan="2">Indoor capacity type</th> <th colspan="2">Piping size (outer diameter) (mm)</th> </tr> <tr> <th>Gas pipe</th> <th>Liquid pipe</th> </tr> </thead> <tbody> <tr> <td>50</td> <td>Ø12.7</td> <td>Ø6.4</td> </tr> <tr> <td>60-125</td> <td>Ø15.9</td> <td>Ø9.5</td> </tr> </tbody> </table>	Indoor capacity type	Piping size (outer diameter) (mm)		Gas pipe	Liquid pipe	50	Ø12.7	Ø6.4	60-125	Ø15.9	Ø9.5
Outdoor unit capacity type		Piping size (outer diameter) (mm)																																				
	Gas pipe	Liquid pipe																																				
CMSQ200	Ø15.9	Ø9.5																																				
CMSQ250	Ø19.1	Ø9.5																																				
Indoor or outdoor unit total capacity	Piping size (outer diameter) (mm)																																					
	Gas pipe	Liquid pipe																																				
<150	Ø15.9	Ø9.5																																				
150≤x<200	Ø19.1	Ø9.5																																				
200≤x<250	Ø22.2	Ø9.5																																				
Indoor capacity type	Piping size (outer diameter) (mm)																																					
	Gas pipe	Liquid pipe																																				
50	Ø12.7	Ø6.4																																				
60-125	Ø15.9	Ø9.5																																				
<p>When the equivalent pipe length between outdoor and indoor units is 90 m or more, the size of the main pipes (both gas side and liquid side) must be increased. Depending on the length of the piping, the capacity may drop, but even in a case it is possible to increase the size of the main pipes.</p>	<p>Gas side</p> <table border="1"> <tbody> <tr> <td>CMSQ200</td> <td>Ø15.9 → Ø19.1</td> </tr> <tr> <td>CMSQ250</td> <td>Ø19.1 → Ø22.2</td> </tr> </tbody> </table> <p>Liquid side</p> <table border="1"> <tbody> <tr> <td>CMSQ200</td> <td>Ø9.5</td> </tr> <tr> <td>CMSQ250</td> <td>Ø9.5 → Ø12.7</td> </tr> </tbody> </table> <p>— Increase is not allowed</p>	CMSQ200	Ø15.9 → Ø19.1	CMSQ250	Ø19.1 → Ø22.2	CMSQ200	Ø9.5	CMSQ250	Ø9.5 → Ø12.7																													
CMSQ200	Ø15.9 → Ø19.1																																					
CMSQ250	Ø19.1 → Ø22.2																																					
CMSQ200	Ø9.5																																					
CMSQ250	Ø9.5 → Ø12.7																																					
<p>How to calculate the additional refrigerant to be charged</p> <p>Additional refrigerant to be charged R (kg) R should be rounded off in units of 0.1 kg</p>	$R = [(X1 \times \text{Ø}22.2) \times 0.37] + [(X2 \times \text{Ø}19.1) \times 0.26] + [(X3 \times \text{Ø}15.9) \times 0.18] + [(X4 \times \text{Ø}12.7) \times 0.12] + [(X5 \times \text{Ø}9.5) \times 0.059] + [(X6 \times \text{Ø}6.4) \times 0.022]$ <p>X₁₋₆ = Total length (m) of liquid piping size at Ø a</p> <p>Example for refrigerant branch using refnet joint and refnet header for CMSQ250</p> <p>If the outdoor unit is CMSQ250 and the piping lengths are as below</p> <p>a.: Ø19.1 x 30 m b.: Ø15.9 x 10 m c.: Ø9.5 x 10 m d.: Ø9.5 x 10 m e.: Ø9.5 x 10 m f.: Ø12.7 x 10 m g.: Ø6.4 x 10 m</p> <p>R = [30 x 0.26] + [10 x 0.18] + [10 x 0.12] + [10 x 0.059] + [10 x 0.022] = 12.79 ⇒ R = 12.8 kg</p>	<p>Note</p>																																				
<p>Required conditions</p> <p>It is necessary to increase the pipe size of the liquid and the gas pipe if the pipe length between the first and the final branch kit is over 40 m (reducers must be procured on site). If the increased pipe size is larger than the pipe size of the main pipe, then the pipe size of the main pipe needs to be increased as well.</p> <p>For calculation of total extension length, the actual length of above pipes must be doubled (except main pipe and the pipes that not increase the pipe size). Indoor unit to the nearest branch kit ≤40 m. The difference between the distance of the outdoor unit to the farthest indoor unit and the distance of the outdoor unit to the nearest indoor unit ≤40 m.</p>	<p>Example drawings</p> <p>Indoor unit 4; b+c+d≤90 m Increase the pipe size of b, c, d</p> <p>a+b*2+c*2+d*2≤200 m</p> <p>e, f, g, h≤40 m</p> <p>The farthest indoor unit 4 The nearest indoor unit 1 (a+b+c+d)-(a+e)≤40 m</p>	<p>Increase the pipe size as follows</p> <p>Ø9.5 → Ø12.7 Ø15.9 → Ø19.1 Ø22.2 → Ø25.4*</p> <p>Ø12.7 → Ø15.9 Ø19.1 → Ø22.2</p> <p>* If available on the site. Otherwise it can not be increased.</p>																																				

6. Thermistor Resistance / Temperature Characteristics

Indoor unit For air suction R1T
 For liquid pipe R2T
 For gas pipe R3T

Outdoor unit for fin thermistor R1T

Outdoor unit For outdoor air R1T
 For coil R2T
 For suction pipe R4T
 For Receiver gas pipe R5T
 For Receiver outlet liquid pipe R6T

(kΩ)

T°C	0.0
-10	-
-8	-
-6	88.0
-4	79.1
-2	71.1
0	64.1
2	57.8
4	52.3
6	47.3
8	42.9
10	38.9
12	35.3
14	32.1
16	29.2
18	26.6
20	24.3
22	22.2
24	20.3
26	18.5
28	17.0
30	15.6
32	14.2
34	13.1
36	12.0
38	11.1
40	10.3
42	9.5
44	8.8
46	8.2
48	7.6
50	7.0
52	6.7
54	6.0
56	5.5
58	5.2
60	4.79
62	4.46
64	4.15
66	3.87
68	3.61
70	3.37
72	3.15
74	2.94
76	2.75
78	2.51
80	2.41
82	2.26
84	2.12
86	1.99
88	1.87
90	1.76
92	1.65
94	1.55
96	1.46
98	1.38

T°C	0.0	0.5
-20	197.81	192.08
-19	186.53	181.16
-18	175.97	170.94
-17	166.07	161.36
-16	156.80	152.38
-15	148.10	143.96
-14	139.94	136.05
-13	132.28	128.63
-12	125.09	121.66
-11	118.34	115.12
-10	111.99	108.96
-9	106.03	103.18
-8	100.41	97.73
-7	95.14	92.61
-6	90.17	87.79
-5	85.49	83.25
-4	81.08	78.97
-3	76.93	74.94
-2	73.01	71.14
-1	69.32	67.56
0	65.84	64.17
1	62.54	60.96
2	59.43	57.94
3	56.49	55.08
4	53.71	52.38
5	51.09	49.83
6	48.61	47.42
7	46.26	45.14
8	44.05	42.98
9	41.95	40.94
10	39.96	39.01
11	38.08	37.18
12	36.30	35.45
13	34.62	33.81
14	33.02	32.25
15	31.50	30.77
16	30.06	29.37
17	28.70	28.05
18	27.41	26.78
19	26.18	25.59
20	25.01	24.45
21	23.91	23.37
22	22.85	22.35
23	21.85	21.37
24	20.90	20.45
25	20.00	19.56
26	19.14	18.73
27	18.32	17.93
28	17.54	17.17
29	16.80	16.45
30	16.10	15.76

T°C	0.0	0.5
30	16.10	15.76
31	15.43	15.10
32	14.79	14.48
33	14.18	13.88
34	13.59	13.31
35	13.04	12.77
36	12.51	12.25
37	12.01	11.76
38	11.52	11.29
39	11.06	10.84
40	10.63	10.41
41	10.21	10.00
42	9.81	9.61
43	9.42	9.24
44	9.06	8.88
45	8.71	8.54
46	8.37	8.21
47	8.05	7.90
48	7.75	7.60
49	7.46	7.31
50	7.18	7.04
51	6.91	6.78
52	6.65	6.53
53	6.41	6.53
54	6.65	6.53
55	6.41	6.53
56	6.18	6.06
57	5.95	5.84
58	5.74	5.43
59	5.14	5.05
60	4.96	4.87
61	4.79	4.70
62	4.62	4.54
63	4.46	4.38
64	4.30	4.23
65	4.16	4.08
66	4.01	3.94
67	3.88	3.81
68	3.75	3.68
69	3.62	3.56
70	3.50	3.44
71	3.38	3.32
72	3.27	3.21
73	3.16	3.11
74	3.06	3.01
75	2.96	2.91
76	2.86	2.82
77	2.77	2.72
78	2.68	2.64
79	2.60	2.55
80	2.51	2.47

**Outdoor Unit
Thermistors for
Discharge Pipe
(R3T, R31~33T)**

						(kΩ)		
T°C	0.0	0.5	T°C	0.0	0.5	T°C	0.0	0.5
0	640.44	624.65	50	72.32	70.96	100	13.35	13.15
1	609.31	594.43	51	69.64	68.34	101	12.95	12.76
2	579.96	565.78	52	67.06	65.82	102	12.57	12.38
3	552.00	538.63	53	64.60	63.41	103	12.20	12.01
4	525.63	512.97	54	62.24	61.09	104	11.84	11.66
5	500.66	488.67	55	59.97	58.87	105	11.49	11.32
6	477.01	465.65	56	57.80	56.75	106	11.15	10.99
7	454.60	443.84	57	55.72	54.70	107	10.83	10.67
8	433.37	423.17	58	53.72	52.84	108	10.52	10.36
9	413.24	403.57	59	51.98	50.96	109	10.21	10.06
10	394.16	384.98	60	49.96	49.06	110	9.92	9.78
11	376.05	367.35	61	48.19	47.33	111	9.64	9.50
12	358.88	350.62	62	46.49	45.67	112	9.36	9.23
13	342.58	334.74	63	44.86	44.07	113	9.10	8.97
14	327.10	319.66	64	43.30	42.54	114	8.84	8.71
15	312.41	305.33	65	41.79	41.06	115	8.59	8.47
16	298.45	291.73	66	40.35	39.65	116	8.35	8.23
17	285.18	278.80	67	38.96	38.29	117	8.12	8.01
18	272.58	266.51	68	37.63	36.98	118	7.89	7.78
19	260.60	254.72	69	36.34	35.72	119	7.68	7.57
20	249.00	243.61	70	35.11	34.51	120	7.47	7.36
21	238.36	233.14	71	33.92	33.35	121	7.26	7.16
22	228.05	223.08	72	32.78	32.23	122	7.06	6.97
23	218.24	213.51	73	31.69	31.15	123	6.87	6.78
24	208.90	204.39	74	30.63	30.12	124	6.69	6.59
25	200.00	195.71	75	29.61	29.12	125	6.51	6.42
26	191.53	187.44	76	28.64	28.16	126	6.33	6.25
27	183.46	179.57	77	27.69	27.24	127	6.16	6.08
28	175.77	172.06	78	26.79	26.35	128	6.00	5.92
29	168.44	164.90	79	25.91	25.49	129	5.84	5.76
30	161.45	158.08	80	25.07	24.66	130	5.69	5.61
31	154.79	151.57	81	24.26	23.87	131	5.54	5.46
32	148.43	145.37	82	23.48	23.10	132	5.39	5.32
33	142.37	139.44	83	22.73	22.36	133	5.25	5.18
34	136.59	133.79	84	22.01	21.65	134	5.12	5.05
35	131.06	128.39	85	21.31	20.97	135	4.98	4.92
36	125.79	123.24	86	20.63	20.31	136	4.86	4.79
37	120.76	118.32	87	19.98	19.67	137	4.73	4.67
38	115.95	113.62	88	19.36	19.05	138	4.61	4.55
39	111.35	109.13	89	18.75	18.46	139	4.49	4.44
40	106.96	104.84	90	18.17	17.89	140	4.38	4.32
41	102.76	100.73	91	17.61	17.34	141	4.27	4.22
42	98.75	96.81	92	17.07	16.80	142	4.16	4.11
43	94.92	93.06	93	16.54	16.29	143	4.06	4.01
44	91.25	89.47	94	16.04	15.79	144	3.96	3.91
45	87.74	86.04	95	15.55	15.31	145	3.86	3.81
46	84.38	82.75	96	15.08	14.85	146	3.76	3.72
47	81.16	79.61	97	14.62	14.40	147	3.67	3.62
48	78.09	76.60	98	14.18	13.97	148	3.58	3.54
49	75.14	73.71	99	13.76	13.55	149	3.49	3.45
50	72.32	70.96	100	13.35	13.15	150	3.41	3.37

7. Pressure Sensor

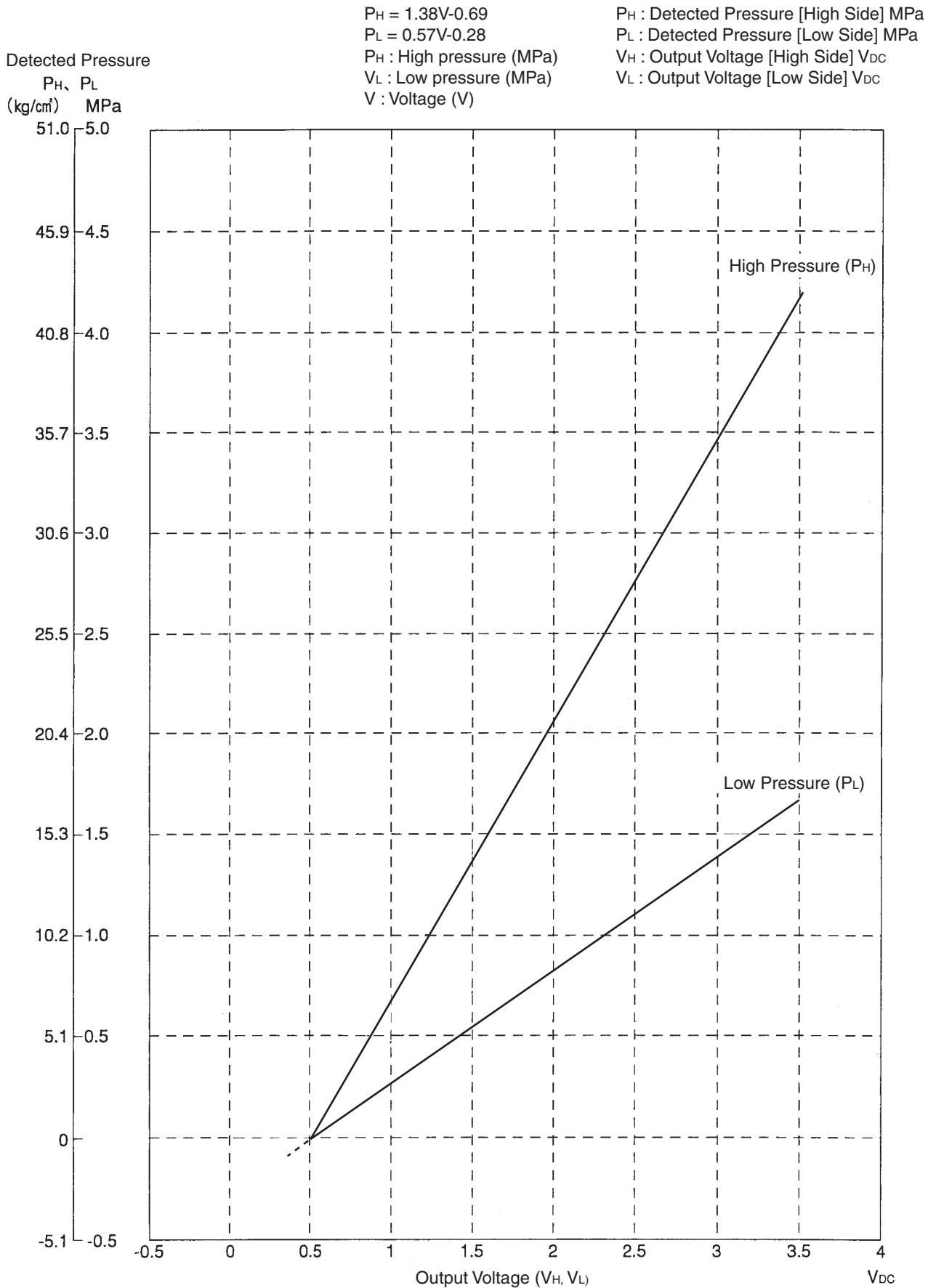

8. Method of Checking the Inverter's Power Transistors and Diode Modules

8.1 Method of Checking the Inverter's Power Transistors and Diode Modules

Checking failures in power semiconductors mounted on inverter PC board

Check the power semiconductors mounted on the inverter PC board by the use of a multiple tester.

<Items to be prepared>

- Multiple tester : Prepare the analog type of multiple tester.
For the digital type of multiple tester, those with diode check function are available for the checking.

<Test points>

- Turn OFF the power supply. Then, after a lapse of 10 minutes or more, make measurement of resistance.

<Preparation>

- To make measurement, disconnect all connectors and terminals.

Inverter PC board

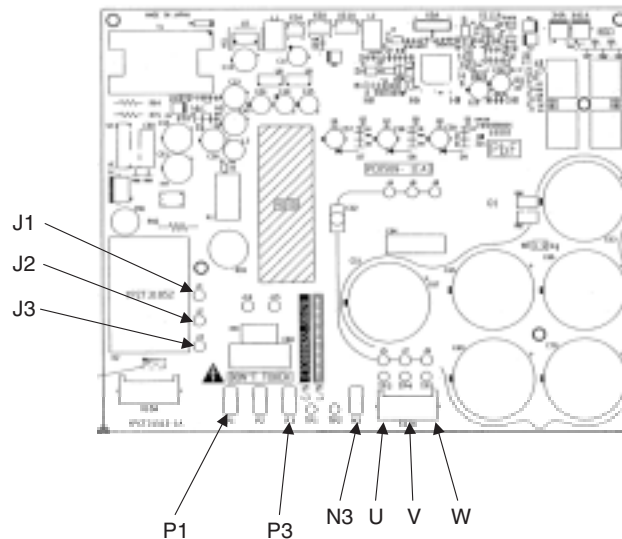

Electronic circuit

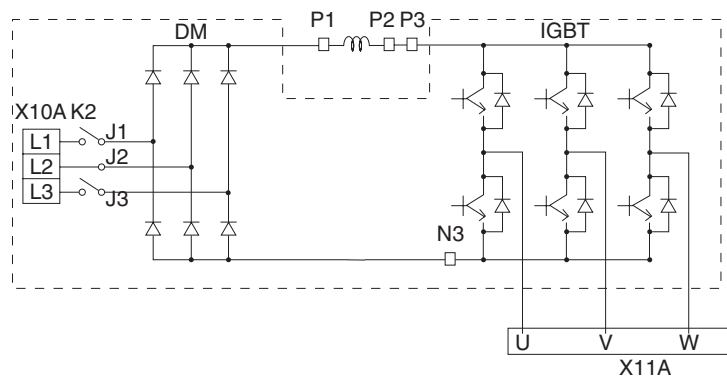

■ According to the checking aforementioned, it is probed that the malfunction results from the faulty inverter. The following section describes supposed causes of the faulty inverter.

- Faulty compressor (ground leakage)
- Faulty fan motor (ground leakage)
- Entry of conductive foreign particles
- Abnormal voltage (e.g. overvoltage, surge (thunder), or unbalanced voltage)

In order to replace the faulty inverter, be sure to check for the points aforementioned.

1. Power module checking

When using the analog type of multiple tester, make measurement in resistance measurement mode in the x1k Ω range.

No.	Measuring point		Criterion	Remark
	+	-		
1	P3	U	2 to 15k Ω	It may take time to determine the resistance due to capacitor charge or else.
2	P3	V		
3	P3	W		
4	U	P3	Not less than 15k Ω (including)	
5	V	P3		
6	W	P3		
7	N3	U		
8	N3	V		
9	N3	W		
10	U	N3	2 to 15k Ω	
11	V	N3		
12	W	N3		

When using the digital type of multiple tester, make measurement in diode check mode ($\rightarrow|$).

No.	Measuring point		Criterion	Remark
	+	-		
1	P3	U	Not less than 1.2V (including)	It may take time to determine the voltage due to capacitor charge or else.
2	P3	V		
3	P3	W		
4	U	P3	0.3 to 0.7V	
5	V	P3		
6	W	P3		
7	N3	U		
8	N3	V		
9	N3	W		
10	U	N3	Not less than 1.2V (including)	
11	V	N3		
12	W	N3		

2. Diode module checking

When using the analog type of multiple tester, make measurement in resistance measurement mode in the x1k Ω range.

No.	Measuring point		Criterion	Remark
	+	-		
1	P1	J1	2 to 15k Ω	It may take time to determine the resistance due to capacitor charge or else.
2	P1	J2		
3	P1	J3		
4	J1	P1	Not less than 15k Ω (including)	
5	J2	P1		
6	J3	P1		
7	N3	J1		
8	N3	J2		
9	N3	J3		
10	J1	N3	2 to 15k Ω	
11	J2	N3		
12	J3	N3		

When using the digital type of multiple tester, make measurement in diode check mode ($\rightarrow|$).

No.	Measuring point		Criterion	Remark
	+	-		
1	P1	J1	Not less than 1.2V (including)	It may take time to determine the voltage due to capacitor charge or else.
2	P1	J2		
3	P1	J3		
4	J1	P1	0.3 to 0.7V	
5	J2	P1		
6	J3	P1		
7	N3	J1		
8	N3	J2		
9	N3	J3		
10	J1	N3	Not less than 1.2V (including)	
11	J2	N3		
12	J3	N3		

Part 8

Precautions for New Refrigerant (R-410A)

1. Precautions for New Refrigerant (R-410A)	254
1.1 Outline	254
1.2 Refrigerant Cylinders.....	256
1.3 Service Tools.....	257

1. Precautions for New Refrigerant (R-410A)

1.1 Outline

1.1.1 About Refrigerant R-410A

- Characteristics of new refrigerant, R-410A
 1. Performance
Almost the same performance as R-22 and R-407C
 2. Pressure
Working pressure is approx. 1.4 times more than R-22 and R-407C.
 3. Refrigerant composition
Few problems in composition control, since it is a Quasi-azeotropic mixture refrigerant.

	HFC units (Units using new refrigerants)		HCFC units
Refrigerant name	R-407C	R-410A	R-22
Composing substances	Non-azeotropic mixture of HFC32, HFC125 and HFC134a (*1)	Quasi-azeotropic mixture of HFC32 and JFC125 (*1)	Single-component refrigerant
Design pressure	3.2 MPa (gauge pressure) = 32.6 kgf/cm ²	4.0 MPa (gauge pressure) = 40.8 kgf/cm ²	2.75MPa (gauge pressure) = 28.0 kgf/cm ²
Refrigerant oil	Synthetic oil (Ether)		Mineral oil (Suniso)
Ozone destruction factor (ODP)	0	0	0.05
Combustibility	None	None	None
Toxicity	None	None	None

- ★1. Non-azeotropic mixture refrigerant: mixture of two or more refrigerants having different boiling points.
- ★2. Quasi-azeotropic mixture refrigerant: mixture of two or more refrigerants having similar boiling points.
- ★3. The design pressure is different at each product. Please refer to the installation manual for each product.
(Reference) 1 MPa ≒ 10.19716 kgf / cm²

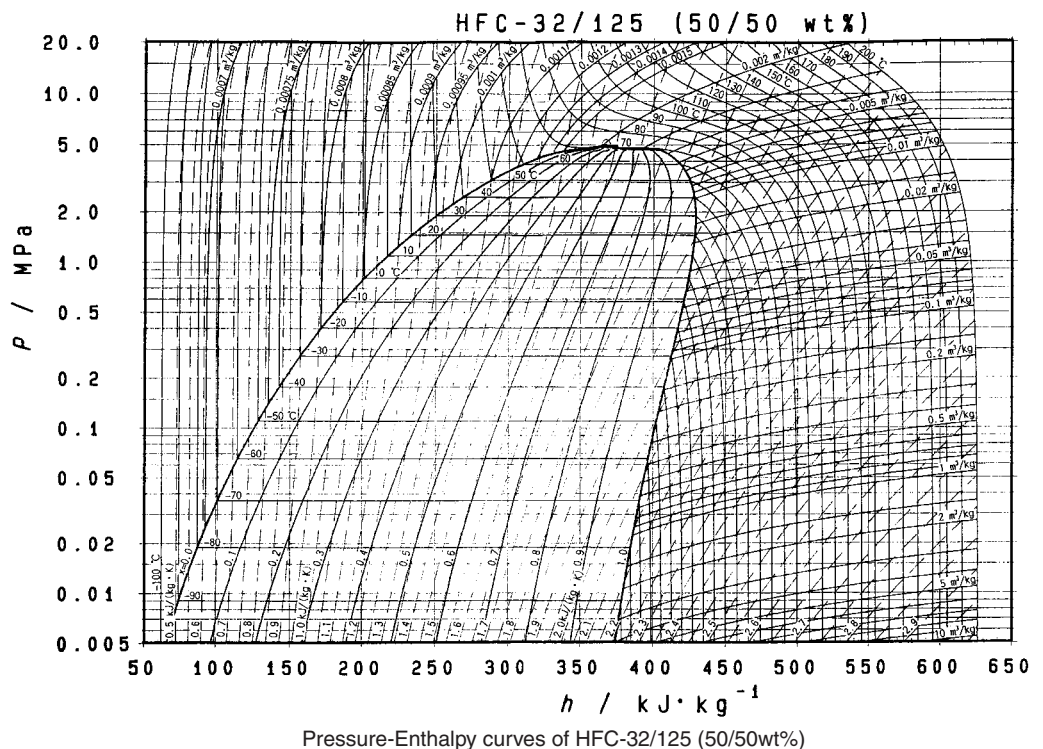

■ Thermodynamic characteristic of R-410A

DAIREP ver2.0

Temperature (°C)	Steam pressure (kPa)		Density (kg/m ³)		Specific heat at constant pressure (kJ/kgK)		Specific enthalpy (kJ/kg)		Specific entropy (kJ/KgK)	
	Liquid	Vapor	Liquid	Vapor	Liquid	Vapor	Liquid	Vapor	Liquid	Vapor
-70	36.13	36.11	1410.7	1.582	1.372	0.695	100.8	390.6	0.649	2.074
-68	40.83	40.80	1404.7	1.774	1.374	0.700	103.6	391.8	0.663	2.066
-66	46.02	45.98	1398.6	1.984	1.375	0.705	106.3	393.0	0.676	2.058
-64	51.73	51.68	1392.5	2.213	1.377	0.710	109.1	394.1	0.689	2.051
-62	58.00	57.94	1386.4	2.463	1.378	0.715	111.9	395.3	0.702	2.044
-60	64.87	64.80	1380.2	2.734	1.379	0.720	114.6	396.4	0.715	2.037
-58	72.38	72.29	1374.0	3.030	1.380	0.726	117.4	397.6	0.728	2.030
-56	80.57	80.46	1367.8	3.350	1.382	0.732	120.1	398.7	0.741	2.023
-54	89.49	89.36	1361.6	3.696	1.384	0.737	122.9	399.8	0.754	2.017
-52	99.18	99.03	1355.3	4.071	1.386	0.744	125.7	400.9	0.766	2.010
-51.58	101.32	101.17	1354.0	4.153	1.386	0.745	126.3	401.1	0.769	2.009
-50	109.69	109.51	1349.0	4.474	1.388	0.750	128.5	402.0	0.779	2.004
-48	121.07	120.85	1342.7	4.909	1.391	0.756	131.2	403.1	0.791	1.998
-46	133.36	133.11	1336.3	5.377	1.394	0.763	134.0	404.1	0.803	1.992
-44	146.61	146.32	1330.0	5.880	1.397	0.770	136.8	405.2	0.816	1.987
-42	160.89	160.55	1323.5	6.419	1.401	0.777	139.6	406.2	0.828	1.981
-40	176.24	175.85	1317.0	6.996	1.405	0.785	142.4	407.3	0.840	1.976
-38	192.71	192.27	1310.5	7.614	1.409	0.792	145.3	408.3	0.852	1.970
-36	210.37	209.86	1304.0	8.275	1.414	0.800	148.1	409.3	0.864	1.965
-34	229.26	228.69	1297.3	8.980	1.419	0.809	150.9	410.2	0.875	1.960
-32	249.46	248.81	1290.6	9.732	1.424	0.817	153.8	411.2	0.887	1.955
-30	271.01	270.28	1283.9	10.53	1.430	0.826	156.6	412.1	0.899	1.950
-28	293.99	293.16	1277.1	11.39	1.436	0.835	159.5	413.1	0.911	1.946
-26	318.44	317.52	1270.2	12.29	1.442	0.844	162.4	414.0	0.922	1.941
-24	344.44	343.41	1263.3	13.26	1.448	0.854	165.3	414.9	0.934	1.936
-22	372.05	370.90	1256.3	14.28	1.455	0.864	168.2	415.7	0.945	1.932
-20	401.34	400.06	1249.2	15.37	1.461	0.875	171.1	416.6	0.957	1.927
-18	432.36	430.95	1242.0	16.52	1.468	0.886	174.1	417.4	0.968	1.923
-16	465.20	463.64	1234.8	17.74	1.476	0.897	177.0	418.2	0.980	1.919
-14	499.91	498.20	1227.5	19.04	1.483	0.909	180.0	419.0	0.991	1.914
-12	536.58	534.69	1220.0	20.41	1.491	0.921	182.9	419.8	1.003	1.910
-10	575.26	573.20	1212.5	21.86	1.499	0.933	185.9	420.5	1.014	1.906
-8	616.03	613.78	1204.9	23.39	1.507	0.947	189.0	421.2	1.025	1.902
-6	658.97	656.52	1197.2	25.01	1.516	0.960	192.0	421.9	1.036	1.898
-4	704.15	701.49	1189.4	26.72	1.524	0.975	195.0	422.6	1.048	1.894
-2	751.64	748.76	1181.4	28.53	1.533	0.990	198.1	423.2	1.059	1.890
0	801.52	798.41	1173.4	30.44	1.543	1.005	201.2	423.8	1.070	1.886
2	853.87	850.52	1165.3	32.46	1.552	1.022	204.3	424.4	1.081	1.882
4	908.77	905.16	1157.0	34.59	1.563	1.039	207.4	424.9	1.092	1.878
6	966.29	962.42	1148.6	36.83	1.573	1.057	210.5	425.5	1.103	1.874
8	1026.5	1022.4	1140.0	39.21	1.584	1.076	213.7	425.9	1.114	1.870
10	1089.5	1085.1	1131.3	41.71	1.596	1.096	216.8	426.4	1.125	1.866
12	1155.4	1150.7	1122.5	44.35	1.608	1.117	220.0	426.8	1.136	1.862
14	1224.3	1219.2	1113.5	47.14	1.621	1.139	223.2	427.2	1.147	1.859
16	1296.2	1290.8	1104.4	50.09	1.635	1.163	226.5	427.5	1.158	1.855
18	1371.2	1365.5	1095.1	53.20	1.650	1.188	229.7	427.8	1.169	1.851
20	1449.4	1443.4	1085.6	56.48	1.666	1.215	233.0	428.1	1.180	1.847
22	1530.9	1524.6	1075.9	59.96	1.683	1.243	236.4	428.3	1.191	1.843
24	1615.8	1609.2	1066.0	63.63	1.701	1.273	239.7	428.4	1.202	1.839
26	1704.2	1697.2	1055.9	67.51	1.721	1.306	243.1	428.6	1.214	1.834
28	1796.2	1788.9	1045.5	71.62	1.743	1.341	246.5	428.6	1.225	1.830
30	1891.9	1884.2	1034.9	75.97	1.767	1.379	249.9	428.6	1.236	1.826
32	1991.3	1983.2	1024.1	80.58	1.793	1.420	253.4	428.6	1.247	1.822
34	2094.5	2086.2	1012.9	85.48	1.822	1.465	256.9	428.4	1.258	1.817
36	2201.7	2193.1	1001.4	90.68	1.855	1.514	260.5	428.3	1.269	1.813
38	2313.0	2304.0	989.5	96.22	1.891	1.569	264.1	428.0	1.281	1.808
40	2428.4	2419.2	977.3	102.1	1.932	1.629	267.8	427.7	1.292	1.803
42	2548.1	2538.6	964.6	108.4	1.979	1.696	271.5	427.2	1.303	1.798
44	2672.2	2662.4	951.4	115.2	2.033	1.771	275.3	426.7	1.315	1.793
46	2800.7	2790.7	937.7	122.4	2.095	1.857	279.2	426.1	1.327	1.788
48	2933.7	2923.6	923.3	130.2	2.168	1.955	283.2	425.4	1.339	1.782
50	3071.5	3061.2	908.2	138.6	2.256	2.069	287.3	424.5	1.351	1.776
52	3214.0	3203.6	892.2	147.7	2.362	2.203	291.5	423.5	1.363	1.770
54	3361.4	3351.0	875.1	157.6	2.493	2.363	295.8	422.4	1.376	1.764
56	3513.8	3503.5	856.8	168.4	2.661	2.557	300.3	421.0	1.389	1.757
58	3671.3	3661.2	836.9	180.4	2.883	2.799	305.0	419.4	1.403	1.749
60	3834.1	3824.2	814.9	193.7	3.191	3.106	310.0	417.6	1.417	1.741
62	4002.1	3992.7	790.1	208.6	3.650	3.511	315.3	415.5	1.433	1.732
64	4175.7	4166.8	761.0	225.6	4.415	4.064	321.2	413.0	1.450	1.722

1.2 Refrigerant Cylinders

- Cylinder specifications
 - The cylinder is painted refrigerant color (pink).
 - The cylinder valve is equipped with a siphon tube.

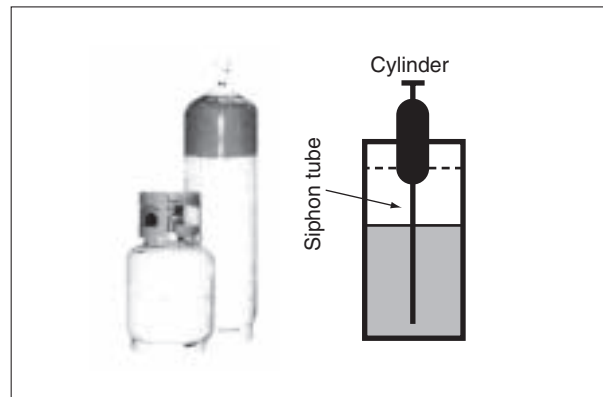

Refrigerant can be charged in liquid state with cylinder in upright position.

Caution: Do not lay cylinder on its side during charging, since it cause refrigerant in gas state to enter the system.

■ Handling of cylinders

(1) Laws and regulations

R-410A is liquefied gas, and the High-Pressure Gas Safety Law must be observed in handling them. Before using, refer to the High-Pressure Gas Safety Law.

The Law stipulates standards and regulations that must be followed to prevent accidents with high-pressure gases. Be sure to follow the regulations.

(2) Handling of vessels

Since R-410A is high-pressure gas, it is contained in high-pressure vessels.

Although those vessels are durable and strong, careless handling can cause damage that can lead to unexpected accidents. Do not drop vessels, let them fall, apply impact or roll them on the ground.

(3) Storage

Although R-410A is not flammable, it must be stored in a well-ventilated, cool, and dark place in the same way as any other high-pressure gases.

It should also be noted that high-pressure vessels are equipped with safety devices that releases gas when the ambient temperature reaches more than a certain level (fusible plug melts) and when the pressure exceeds a certain level (spring-type safety valve operates).

1.3 Service Tools

R-410A is used under higher working pressure, compared to previous refrigerants (R-22,R-407C). Furthermore, the refrigerating machine oil has been changed from Suniso oil to Ether oil, and if oil mixing is occurred, sludge results in the refrigerants and causes other problems. Therefore, gauge manifolds and charge hoses that are used with a previous refrigerant (R-22,R-407C) can not be used for products that use new refrigerants.

Be sure to use dedicated tools and devices.

■ Tool compatibility

Tool	Compatibility			Reasons for change
	HFC		HCFC	
	R-410A	R-407C	R-22	
Gauge manifold Charge hose	×			<ul style="list-style-type: none"> Do not use the same tools for R-22 and R-410A. Thread specification differs for R-410A and R-407C.
Charging cylinder	×		○	<ul style="list-style-type: none"> Weighting instrument used for HFCs.
Gas detector	○		×	<ul style="list-style-type: none"> The same tool can be used for HFCs.
Vacuum pump (pump with reverse flow preventive function)		○		<ul style="list-style-type: none"> To use existing pump for HFCs, vacuum pump adapter must be installed.
Weighting instrument		○		
Charge mouthpiece		×		<ul style="list-style-type: none"> Seal material is different between R-22 and HFCs. Thread specification is different between R-410A and others.
Flaring tool (Clutch type)		○		<ul style="list-style-type: none"> For R-410A, flare gauge is necessary.
Torque wrench		○		<ul style="list-style-type: none"> Torque-up for 1/2 and 5/8
Pipe cutter		○		
Pipe expander		○		
Pipe bender		○		
Pipe assembling oil		×		<ul style="list-style-type: none"> Due to refrigerating machine oil change. (No Suniso oil can be used.)
Refrigerant recovery device	Check your recovery device.			
Refrigerant piping	See the chart below.			<ul style="list-style-type: none"> Only $\phi 19.1$ is changed to 1/2H material while the previous material is "O".

As for the charge mouthpiece and packing, 1/2UNF20 is necessary for mouthpiece size of charge hose.

■ Copper tube material and thickness

Pipe size	R-407C		R-410A	
	Material	Thickness t (mm)	Material	Thickness t (mm)
$\phi 6.4$	O	0.8	O	0.8
$\phi 9.5$	O	0.8	O	0.8
$\phi 12.7$	O	0.8	O	0.8
$\phi 15.9$	O	1.0	O	1.0
$\phi 19.1$	O	1.0	1/2H	1.0
$\phi 22.2$	1/2H	1.0	1/2H	1.0
$\phi 25.4$	1/2H	1.0	1/2H	1.0
$\phi 28.6$	1/2H	1.0	1/2H	1.0
$\phi 31.8$	1/2H	1.2	1/2H	1.1
$\phi 38.1$	1/2H	1.4	1/2H	1.4
$\phi 44.5$	1/2H	1.6	1/2H	1.6

* O: Soft (Annealed)
H: Hard (Drawn)

1. Flaring tool



Flare gauge

■ Specifications

- Dimension A

Unit:mm

Nominal size	Tube O.D. Do	A ⁺⁰ _{-0.4}	
		Class-2 (R-410A)	Class-1 (Conventional)
1/4	6.35	9.1	9.0
3/8	9.52	13.2	13.0
1/2	12.70	16.6	16.2
5/8	15.88	19.7	19.4
3/4	19.05	24.0	23.3

■ Differences

- Change of dimension A

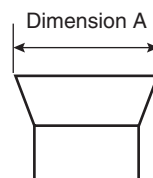

For class-1: R-407C
For class-2: R-410A

Conventional flaring tools can be used when the work process is changed.
(change of work process)

Previously, a pipe extension margin of 0 to 0.5mm was provided for flaring. For R-410A air conditioners, perform pipe flaring with a pipe extension margin of 1.0 to 1.5mm.
(For clutch type only)

Conventional tool with pipe extension margin adjustment can be used.

2. Torque wrench



■ Specifications

• Dimension B

Unit:mm

Nominal size	Class-1	Class-2	Previous
1/2	24	26	24
5/8	27	29	27

No change in tightening torque

No change in pipes of other sizes

■ Differences

• Change of dimension B

Only 1/2", 5/8" are extended

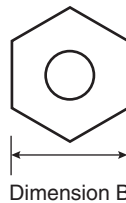

For class-1: R-407C
For class-2: R-410A

3. Vacuum pump with check valve

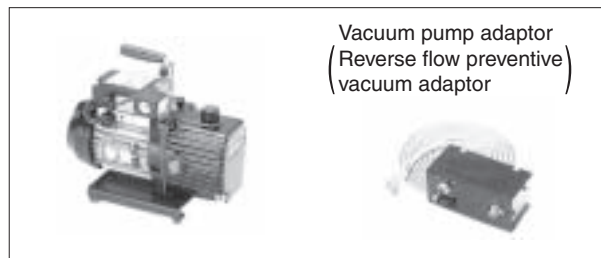

Vacuum pump adaptor
(Reverse flow preventive)
vacuum adaptor

■ Specifications

• Discharge speed

50 l/min (50Hz)

60 l/min (60Hz)

• Suction port UNF7/16-20(1/4 Flare)

UNF1/2-20(5/16 Flare) with adapter

● Maximum degree of vacuum

Select a vacuum pump which is able to keep the vacuum degree of the system in excess of -100.7 kPa (5 torr - 755 mmHg).

■ Differences

- Equipped with function to prevent reverse oil flow
- Previous vacuum pump can be used by installing adapter.

4. Leak tester



- Specifications
 - Hydrogen detecting type, etc.
 - Applicable refrigerants
R-410A, R-407C, R-404A, R-507A, R-134a, etc.
- Differences
 - Previous testers detected chlorine. Since HFCs do not contain chlorine, new tester detects hydrogen.

5. Refrigerant oil (Air compal)



- Specifications
 - Contains synthetic oil, therefore it can be used for piping work of every refrigerant cycle.
 - Offers high rust resistance and stability over long period of time.
- Differences
 - Can be used for R-410A and R-22 units.

6. Gauge manifold for R-410A

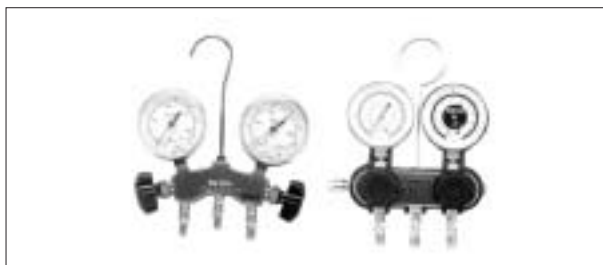

- Specifications
 - High pressure gauge
- 0.1 to 5.3 MPa (-76 cmHg to 53 kg/cm²)
 - Low pressure gauge
- 0.1 to 3.8 MPa (-76 cmHg to 38 kg/cm²)
 - 1/4" → 5/16" (2min → 2.5min)
 - No oil is used in pressure test of gauges.
→ For prevention of contamination

- Temperature scale indicates the relationship between pressure and temperature in gas saturated state.
- Differences
 - Change in pressure
 - Change in service port diameter

7. Charge hose for R-410A

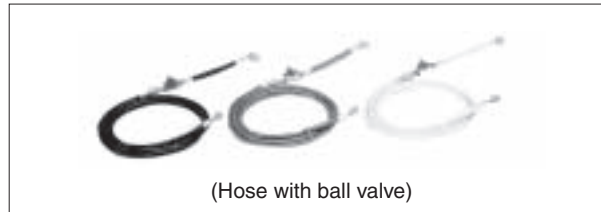

- Specifications
 - Working pressure 5.08 MPa (51.8 kg/cm²)
 - Rupture pressure 25.4 MPa (259 kg/cm²)
 - Available with and without hand-operate valve that prevents refrigerant from outflow.
- Differences
 - Pressure proof hose
 - Change in service port diameter
 - Use of nylon coated material for HFC resistance

8. Charging cylinder



- Specifications
 - Use weigher for refrigerant charge listed below to charge directly from refrigerant cylinder.
- Differences
 - The cylinder can not be used for mixed refrigerant since mixing ratio is changed during charging.

When R-410A is charged in liquid state using charging cylinder, foaming phenomenon is generated inside charging cylinder.

9. Weigher for refrigerant charge



■ Specifications

- High accuracy
TA101A (for 10-kg cylinder) = ± 2 g
TA101B (for 20-kg cylinder) = ± 5 g
- Equipped with pressure-resistant sight glass to check liquid refrigerant charging.
- A manifold with separate ports for HFCs and previous refrigerants is equipped as standard accessories.

■ Differences

- Measurement is based on weight to prevent change of mixing ratio during charging.

10. Charge mouthpiece



■ Specifications

- For R-410A, 1/4" → 5/16" (2min → 2.5min)
- Material is changed from CR to H-NBR.

■ Differences

- Change of thread specification on hose connection side (For the R-410A use)
- Change of sealer material for the HFCs use.

Index

A	
A0	138
A1	139
A3	140
A6	142
A9	143
Abnormal Discharge Pipe Temperature	164
Abnormal Outdoor Fan Motor Signal	166
Actuation of High Pressure Switch	153
Actuation of Low Pressure Sensor	155
Address Duplication of Centralized Controller	205
Address Duplication, Improper Setting	217
AF	145
Airflow Direction Setting	90
Airflow Setting when Heating Thermostat is OFF	88
Airflow when Cooling Thermostat is OFF	89
AJ	146
Applicable Range of Field Setting	86
Applicable range of Field setting	86
Auto Restart after Power Failure Reset	89
C	
C4	147
C5	148
C9	149
CC	150
CHECK 1	226
CHECK 2	226
CHECK 3	227
CHECK 4	228
Check for causes of drop in low pressure	228
Check for causes of rise in high pressure	227
Check on connector of fan motor (Power supply cable)	226
Check Operation not Executed	195
CJ	151
Cool / Heat Mode Switching	108
D	
Detailed Explanation of Setting Modes	87
Display "Under Centralized Control" Blinks (Repeats Double Blink)	225
Display "Under Centralized Control" Blinks (Repeats Single Blink)	222
Drain Level above Limit	145
E	
E1	152
E3	153
E4	155
E5	157
E7	159
E9	162
Error of External Protection Device	138
External ON/OFF Input	88
F	
F3	164
F6	165
Fan Motor (M1F) Lock, Overload	142
Faulty Field Setting after Replacing Main PC Board or Faulty Combination of PC Board	189
Field Setting	82
Filter Sign Setting	87
"Filter Cleaning" Displayed or Not Displayed	87
Functional Parts Layout	20
CMSQ200A7	20
CMSQ250A7	21
H	
H7	166
H9	167
Humidification when Heating Thermostat is OFF	90
I	
Improper Combination of Indoor and Outdoor Units, Indoor Units and remote control	203
Improper Combination of Optional Controllers for Centralized Control	215
Individual	91
Individual Setting of Ventilation	91
Injection Control (only for CMSQ200A7)	51
Interlocked Operation between Humidifier and Drain Pump	91
Inverter Compressor Abnormal	177
Inverter Compressor Motor Lock	157
Inverter Current Abnormal	179
Inverter Over-Ripple Protection	186
Inverter Start Up Error	181
J	
J3	168
J5	169
J6	170
J7	171
J9	172
JA	173
JC	174
L	
L4	175
L5	177
L8	179
L9	181
LC	183
List of Electrical and Functional Parts	239
Indoor Unit	240
Outdoor Unit	239

Local setting switch	81	Malfunction of Transmission Between remote control and Indoor Unit	198
Low Pressure Drop Due to Refrigerant Shortage or Electronic Expansion Valve Failure	190	MC	217
M		Microcomputer normal monitor	81
M1	212	Mode setting switch	81
M8	213	Monitor Mode	106
MA	215	Motor side connectors	226
Malfunction code indication by outdoor unit PC board	134	O	
Malfunction of Capacity Determination Device	146	Operation Lamp Blinks	220
Malfunction of Discharge Pipe Thermistor (R3T)	168	Optional Output Switching	87
Malfunction of Drain Level Control System (S1L)	140	Outdoor Unit PC Board Layout	81
Malfunction of High Pressure Sensor	173	P	
Malfunction of Humidity Sensor System	150	P1	186
Malfunction of Inverter Radiating Fin Temperature Rise	175	P4	187
Malfunction of Inverter Radiating Fin Temperature Rise Sensor	187	PC Board Defect	139, 152, 212
Malfunction of Liquid Pipe Thermistor (R6T)	171	PJ	189
Malfunction of Low Pressure Sensor	174	Power Supply Insufficient or Instantaneous Failure	192
Malfunction of Moving Part of Electronic Expansion Valve (Y1E)	143	Procedure and Outline	65
Malfunction of Moving Part of Electronic Expansion Valve (Y1E, Y2E)	162	R	
Malfunction of Outdoor Unit Fan Motor	159	Refrigerant Circuit	16
Malfunction of Subcooling Heat Exchanger Gas Pipe Thermistor (R5T)	172	CMSQ200A7	16
Malfunction of System, Refrigerant System Address Undefined	210	CMSQ250A7	18
Malfunction of Thermistor (R1T) for Outdoor Air	167	Refrigerant Flow for Each Operation Mode	22
Malfunction of Thermistor (R1T) for Suction Air	149	CMSQ200A7	22
Malfunction of Thermistor (R2T) for Heat Exchanger	147	CMSQ250A7	26
Malfunction of Thermistor (R2T, R7T) for Suction Pipe	169	Refrigerant Overcharged	165
Malfunction of Thermistor (R3T) for Gas Pipes	148	Reverse Phase, Open Phase	191
Malfunction of Thermistor (R4T) for Outdoor Unit Heat Exchanger	170	S	
Malfunction of Thermostat Sensor in remote control 151		Selection of Thermistor	87
Malfunction of Transmission Between Centralized Controller and Indoor Unit	206	Set mode display (LED)	81
Malfunction of Transmission Between Indoor and Outdoor Units in the Same System	202	Setting by push button switches	100
Malfunction of Transmission Between Indoor Units	196	Setting of Airflow Direction Adjustment Range	90
Malfunction of Transmission Between Inverter and Control PC Board	183	Setting of Direct Duct Connection	91
Malfunction of Transmission Between Main and Sub remote controls	201	Setting of Normal Airflow	89
Malfunction of Transmission Between Optional Controllers for Centralized Control	213	Setting of Operation Mode to "AUTO"	88
Malfunction of Transmission Between Outdoor Units	199	Setting of the Static Pressure Selection	90
		System is not Set yet	209
		T	
		Thermostat Switching	88
		Troubleshooting (OP: Central remote control)	212
		Troubleshooting (OP: Unified ON/OFF Controller)	220
		U	
		U0	190
		U1	191
		U2	192
		U3	195
		U4	196
		U5	198
		U7	199
		U8	201
		U9	202

UA203
UC205
UE206
UF209
UH210
Ultra-Long-Life Filter Sign Setting87

Drawings & Flow Charts

A			
Abnormal Discharge Pipe Temperature	164	Setting by dip switches	98
Abnormal Outdoor Fan Motor Signal	166	Freeze Prevention	60
Actuation of High Pressure Switch	153	Functional Parts Layout	20
Actuation of Low Pressure Sensor	155	CMSQ200A7	20
Address Duplication of Centralized Controller	205	CMSQ250A7	21
Address Duplication, Improper Setting	217		
C		H	
Centralized Control Group No. Setting	92	Heater Control	60
BRC1C Type	92	High Pressure Protection Control	47
BRC4C Type	93		
BRC7F Type	93	I	
Group No. Setting Example	93	Improper Combination of Indoor and Outdoor Units, Indoor Units and remote control	203
CHECK 1	226	Improper Combination of Optional Controllers for Centralized Control	215
CHECK 2	226	Injection Control	51
CHECK 3	227	Inverter Compressor Abnormal	177
CHECK 4	228	Inverter Compressor Motor Lock	157
Check for causes of drop in low pressure	228	Inverter Current Abnormal	179
Check for causes of rise in high pressure	227	Inverter Over-Ripple Protection	186
Check on connector of fan motor (Power supply cable)	226	Inverter Protection Control	50
Check Operation not Executed	195	Inverter Start up Error	181
Compressor Step Control	36		
Contents of Control Modes	94	L	
How to Select Operation Mode	95	Louver Control for Preventing Ceiling Dirt	55
D		Low Pressure Drop Due to Refrigerant Shortage or Electronic Expansion Valve Failure	190
Discharge Pipe Protection Control	49	Low Pressure Protection Control	48
Display "Under Centralized Control" Blinks (Repeats Double Blink)	225		
Display "Under Centralized Control" Blinks (Repeats Single Blink)	222	M	
Drain Level above Limit	145	Malfunction of Capacity Determination Device ...	146
Drain Pump Control	53	Malfunction of Discharge Pipe Thermistor (R3T)	168
When the Float Switch is Tripped and "AF" is Displayed on the remote control	54	Malfunction of Drain Level Control System (S1L)	140
When the Float Switch is Tripped During Heating Operation	54	Malfunction of High Pressure Sensor	173
When the Float Switch is Tripped while the Cooling Thermostat is OFF	53	Malfunction of Humidity Sensor System	150
When the Float Switch is Tripped while the Cooling Thermostat is ON	53	Malfunction of Inverter Radiating Fin Temperature Rise	175
E		Malfunction of Inverter Radiating Fin Temperature Rise Sensor	187
Error of External Protection Device	138	Malfunction of Liquid Pipe Thermistor (R6T)	171
Example of connection (R-410A Type)	244	Malfunction of Low Pressure Sensor	174
External Appearance	3	Malfunction of Moving Part of Electronic Expansion Valve (Y1E)	143
F		Malfunction of Moving Part of Electronic Expansion Valve (Y1E, Y2E)	162
Fan Motor (M1F) Lock, Overload	142	Malfunction of Outdoor Unit Fan Motor	159
Faulty Field Setting after Replacing Main PC Board or Faulty Combination of PC Board	189	Malfunction of Subcooling Heat Exchanger Gas Pipe Thermistor (R5T)	172
Field Setting from Outdoor Unit	96	Malfunction of System, Refrigerant System Address Undefined	210
Mode changing procedure	100	Malfunction of Thermistor (R1T) for Outdoor Air .	167
		Malfunction of Thermistor (R1T) for Suction Air ..	149
		Malfunction of Thermistor (R2T) for Heat Exchanger	147
		Malfunction of Thermistor (R2T, R7T) for Suction Pipe	

.....	169	Setting of Low Noise Operation and Demand	
Malfunction of Thermistor (R3T) for Gas Pipes	148	Operation	110
Malfunction of Thermistor (R4T) for Outdoor Unit Heat Exchanger	170	Image of operation in the case of A	111, 113
Malfunction of Thermostat Sensor in remote control .	151	Image of operation in the case of A and B ...	111, 113
Malfunction of Transmission Between Centralized Controller and Indoor Unit	206	Image of operation in the case of B	111, 113
Malfunction of Transmission Between Indoor and Outdoor Units in the Same System	202	Simplified remote control	84
Malfunction of Transmission Between Indoor Units ...	196	BRC2A51	84
Malfunction of Transmission Between Inverter and Control PC Board	183	BRC2C51	84
Malfunction of Transmission Between Main and Sub remote controls	201	System is not Set yet	209
Malfunction of Transmission Between Optional Controllers for Centralized Control	213	T	
Malfunction of Transmission Between Outdoor Units	199	Test Operation	64
Malfunction of Transmission Between remote control and Indoor Unit	198	Thermostat Sensor in remote control	56
Method of Checking the Inverter's Power Transistors and Diode Modules	250	Cooling	56
Mode changing procedure	100	Heating	57
Monitor Mode	106	Troubleshooting (OP: Central remote control)	212
motor side connectors	226	Troubleshooting (OP: Unified ON/OFF Controller) ...	220
O		Troubleshooting by remote control	124
Operation Lamp Blinks	220	W	
Outdoor Unit Fan Control in Cooling Operation	38	Wired remote control	82
Outdoor Unit PC Board Layout	81	infrared remote control - Indoor Unit	83
P		BRC4C type	83
PC Board Defect	139, 152, 212	BRC7F type	83
Piping Diagrams	230	Wiring Diagrams for Reference	233
Indoor Unit	232	Field Wiring	235
Outdoor Unit	230	Indoor Unit	236
Power Supply Insufficient or Instantaneous Failure ...	192	Outdoor Unit	233
Pressure Sensor	249		
Procedure for changing COOL/HEAT selection setting	101		
Procedures for Detecting Broken Wires in Transmission Wiring for Control	219		
R			
Refrigerant Circuit	16		
CMSQ200A7	17		
CMSQ250A7	19		
Refrigerant Flow for Each Operation Mode	22		
CMSQ200A7	22		
CMSQ250A7	26		
Refrigerant Overcharged	165		
remote control Self-Diagnosis Function	131		
remote control Service Mode	129		
Reverse Phase, Open Phase	191		
S			
Self-diagnosis by Wired remote control	125		
Self-diagnosis by infrared remote control	126		

In all of us,
a green heart



Daikin's unique position as a manufacturer of air conditioning equipment, compressors and refrigerants has led to its close involvement in environmental issues. For several years Daikin has had the intension to become a leader in the provision of products that have limited impact on the environment. This challenge demands the eco design and development of a wide range of products and an energy management system, resulting in energy conservation and a reduction of waste.



Daikin Europe N.V. is approved by LRQA for its Quality Management System in accordance with the ISO9001 standard. ISO9001 pertains to quality assurance regarding design, development, manufacturing as well as to services related to the product.



ISO14001 assures an effective environmental management system in order to help protect human health and the environment from the potential impact of our activities, products and services and to assist in maintaining and improving the quality of the environment.



Daikin units comply with the European regulations that guarantee the safety of the product.



Daikin Europe N.V. is participating in the EUROVENT Certification Programme. Products are as listed in the EUROVENT Directory of Certified Products.

"The present publication is drawn up by way of information only and does not constitute an offer binding upon Daikin Europe N.V.. Daikin Europe N.V. has compiled the content of this publication to the best of its knowledge. No express or implied warranty is given for the completeness, accuracy, reliability or fitness for particular purpose of its content and the products and services presented therein. Specifications are subject to change without prior notice. Daikin Europe N.V. explicitly rejects any liability for any direct or indirect damage, in the broadest sense, arising from or related to the use and/or interpretation of this publication. All content is copyrighted by Daikin Europe N.V.."

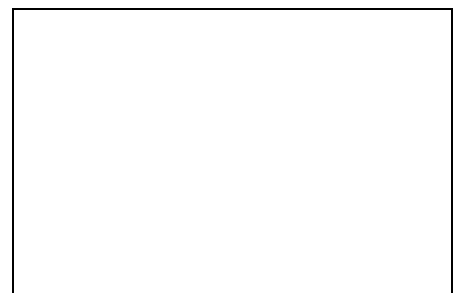

DAIKIN EUROPE N.V.
Naamloze Vennootschap
Zandvoordestraat 300
B-8400 Oostende - Belgium
www.daikin.eu
BTW: BE 0412 120 336
RPR Oostende



SIENBE28-805