

## 14. Unified ON/OFF Controller

### 14.1 DCS301BA61

Turns up to 16 groups of indoor units (max. 128 units) on/off (operation/stop) by individual group or all at once, and lets you check display of operation/malfunction at the same time.

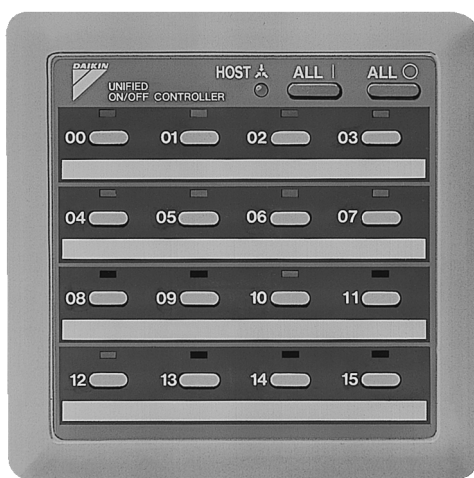

- For a maximum of 16 groups of indoor units (max. 128 units), unified operation/stop or individual operation/stop can be performed with this optional accessory. Also allows you check operation/error display at a glance.
- By combining with a central remote controller and schedule timer, you can construct a system that matches the size and use of the building.
- Up to 8 units connectable within 1 system.  
Up to 16 units in the double central control mode.
- Features thin design of a mere 16mm in thickness. (Uses JIS recessed box for 2.)
- Wiring can be up to 1km in length. Applicable wiring methods include bus and star in addition to crossover type.
- Can be used in combination with other D-BACS equipment.

#### Dimensions

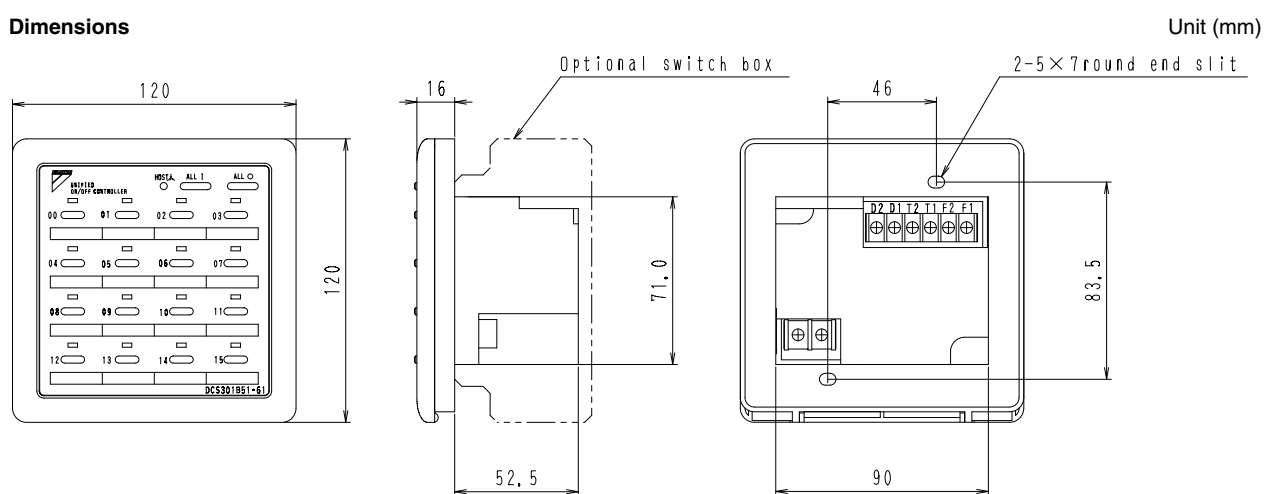

3D050339

2

13.1 KJB212A / KJB311A / KJB411A / 14.1 DCS301BA61

14.1.1 Installation

**1 COMPONENTS**

Check the following components are included in this optional accessory before installation.

Body

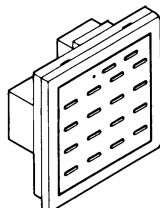

Installation screw (M4 x 16)	2
Operation manual	1
Installation manual	2
Installation table	2
Switch display sticker	1

For installation, a steel electrical box to be embedded is necessary.

**2 SYSTEM CONFIGURATION**

This unified ON/OFF controller enables individual and unified operation/stop for a maximum of 16 groups of indoor units. With 2 to 8 unified ON/OFF controllers, individual and unified control is possible with up to a maximum 128 groups of indoor units.

- When using 1 unified ON/OFF controller

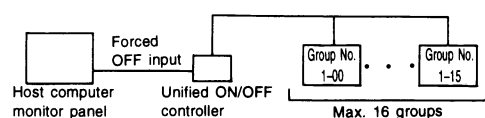

- When using 2 to 8 unified ON/OFF controllers

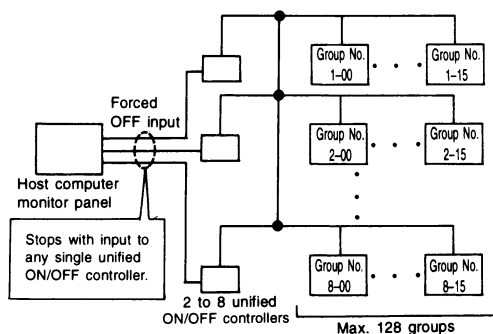

(This optional accessory can not be used in conjunction with wiring adaptor for electrical appendices (optional accessory).)

The groups of indoor units are as follows:

- ① One indoor unit without remote controller
- ② One indoor unit controlled by one or two remote controllers

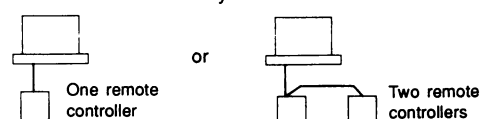

- ③ A maximum of 16 indoor units controlled in groups by one or two remote controllers

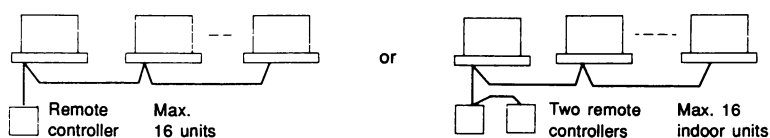

1P162827

**3 ELECTRIC WIRING**

**2**

**14.1 DCSS301BA61**

**GENERAL INSTRUCTIONS**

- All wiring, components and materials to be procured on the site must comply with the applicable local and national codes.
- Use copper conductors only.
- All field wiring and components must be provided by licensed electrician.
- Unit shall be grounded in compliance with the applicable local and national codes.
- Fit the power supply wiring with a fuse and a switch.
- After wiring work, check power to the equipment shuts OFF when switch is shut OFF.

**WIRING OUTLINE**

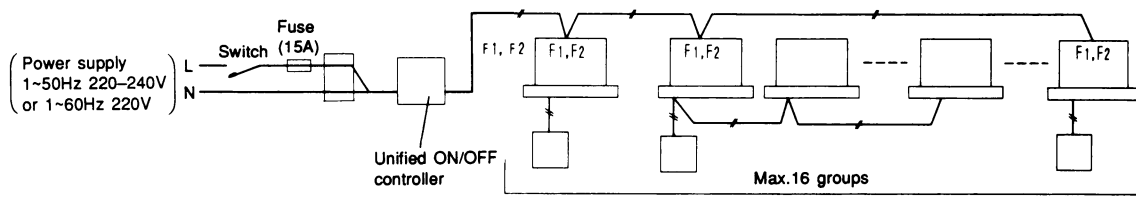

**Wiring specification**

	Type	Size
Power supply wiring	, H05VV-U3G	(NOTE 1)
Transmission wiring	Sheathed wire (2 wire) (NOTE 2)	0.75 - 1.25 mm <sup>2</sup>

- NOTES) 1. The size of power supply wiring must comply with the applicable national and local codes.  
 2. Allowable length of transmission wiring is as follows.  
 Max. 1000m (Total wiring length: 2000m)

Connect the wiring between indoor and outdoor units, indoor/outdoor units and power supply, and indoor units and remote controllers.  
 For details, refer to the installation manuals of indoor and outdoor units.

**EXAMPLES OF WIRING FOR TRANSMISSION**

① Series wiring

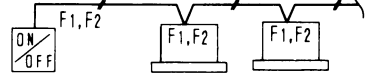

1P162827

② Bus type wiring (Can be branched up to 16 branchings)

Example of 3 branchings

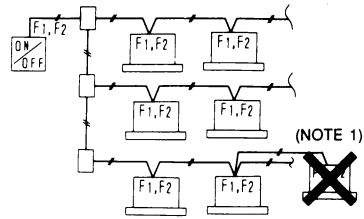

③ Star type wiring (Can be branched up to 16 branchings)

Example of 3 branchings

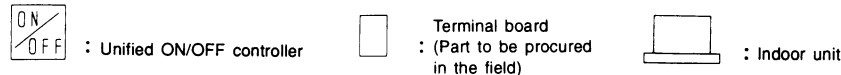
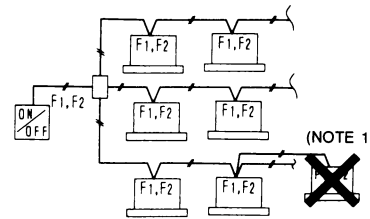

- NOTES) 1. No branching is allowed after branching.  
 2. Use a relay terminal board (part to be procured in the field) to branch more than 3 control wirings from the same terminal board.

**WIRING TO THE INDOOR UNIT AND OUTDOOR UNIT**

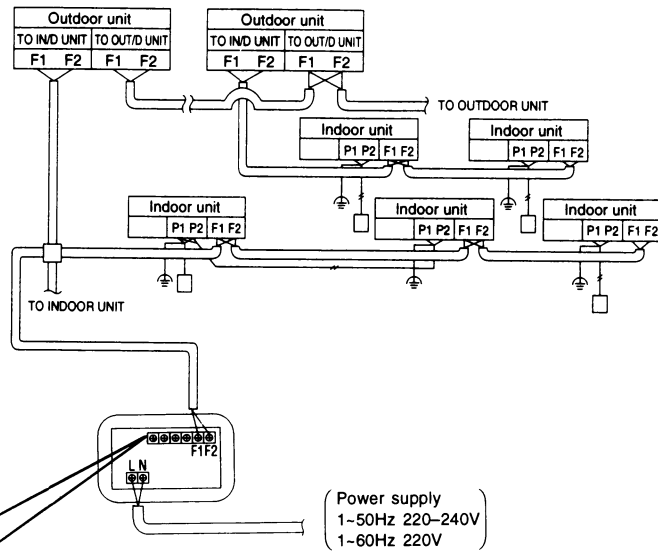

**CONTROL TERMINAL STRIP**

- \* 1 For connecting indoor unit (F1, F2)
- \* 2 Forced OFF input (T1, T2)  
 While the forced OFF input (no voltage contactor, for micro current) is ON (energized), all the connected indoor units are stopped and can not be operated.  
 Use only contactors which guarantee the minimum applicable load  $\approx 16V, 10mA$ .  
 $T1 \text{ --- } 16V$   
 $T2 \text{ --- } 16V$
- \* 3 For schedule timer (D1, D2)  
 Power can be supplied to the schedule timer (DST301B61/optional accessory). For details, refer to the installation manual of the schedule timer.  
 Wire \* 2 and \* 3 only when necessary.

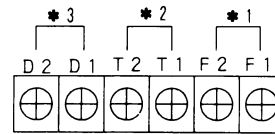

(NOTE)  
 Do not connect the power supply wiring (220 to 240V) to the control terminal strip. If connected by mistake, it may damage or burn electrical parts of optional controllers for centralized control and indoor unit. It may result in serious danger. Be sure to check wirings before turning the power ON.

## 4 INSTALLATION

- ① Open the upper part of remote controller. Insert a ⊖ screwdriver (2 locations) into the recess between the upper part and the lower part of remote controller and twist the screwdriver lightly.

PC board is attached with both the upper and lower part of remote controller. Do not damage the board with the screwdriver.

- ② Open the upper part of remote controller and install the electrical box (part to be procured in the field) with the attached installation screws (M4 x 16).

NOTE) Suitable length of the electric wire is about 160mm from the inlet of the electrical box. If it is difficult to contain a long wiring, strip the sheathed part of the wiring.

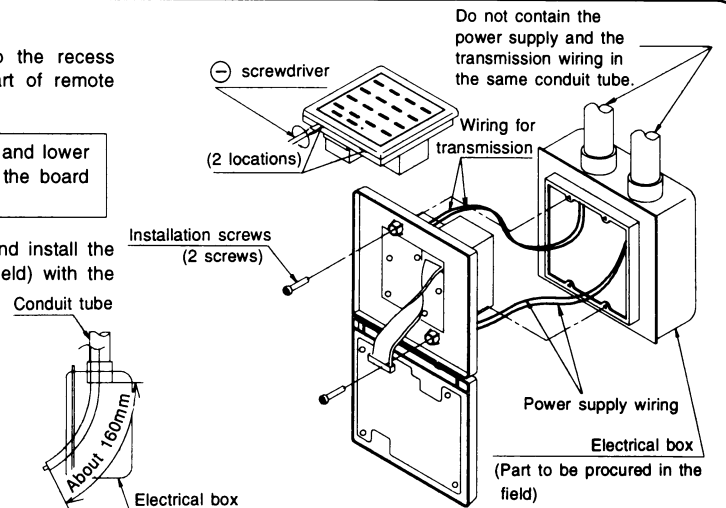

## 5 INITIAL SETTING

Setting ① through ③ are initialized when power is turned ON, therefore complete settings BEFORE activating the power.

- ① Connector for setting master controller (X1A) (Provided with connector at factory set)
- When using 1 unified ON/OFF controller, do not disconnect the connector for setting master controller. (Use the unit with the connector in the state in which it was delivered.)
  - When using multiple unified ON/OFF controllers, or using the unified ON/OFF controller in conjunction with other optional controllers for centralized control, makes settings as indicated in the right table.

2

14.1 DCS301BA61

1P162827

Pattern of connection of optional controllers for centralized control			Connector for setting master controller (X1A) Settings		
Unified ON/OFF controller	Central remote controller	Schedule timer	Unified ON/OFF controller	Central remote controller	Schedule timer
1 to 16	1 to 4	1	Set one to "Used" and all the rest to "Not used".	(Note)	"Not used"
			Set all to "Not used".		
	1 to 4	1	Set one to "Used" and all the rest to "Not used".	(Note)	"Not used"
			Set all to "Not used".		

(Note) For instructions on how to set the connector for setting master controller on the central remote controller, see the installation manual provided with the central remote controller.

② Switch for setting each address (DS1)

These switches are used to set group control address.

Groups Nos. 1-00 through 1-15 are grouped in the same control group when the unit is shipped from the factory.

Each Address	1-00-1-15	2-00-2-15	3-00-3-15	4-00-4-15	5-00-5-15	6-00-6-15	7-00-7-15	8-00-8-15
DS1 setting								
	(Factory setting)							

After setting, attach the number seal applicable to respective control range of the attached switch display sticker, as shown in the diagram below.

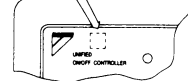

(Example)  
In the case of 1-00 to 1-15, attach 1

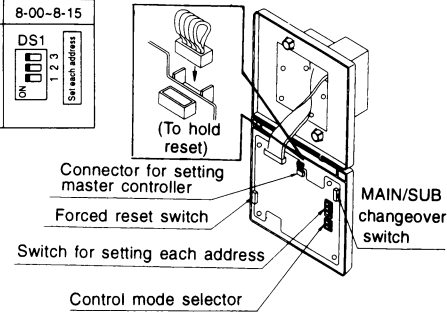

③ MAIN/SUB changeover switch setting

With two unified ON/OFF controllers, centralized control (indoor units) is possible from different locations. In this kind of set-up, it is necessary to set the MAIN/SUB changeover switch.

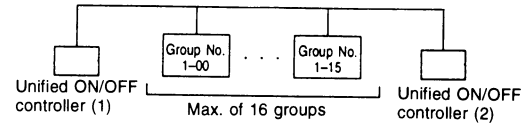

One of the two unified ON/OFF controllers (1)•(2) is set to "MAIN" while the other is set to "SUB".

④ Setting of the sequential operation function

The unified ON/OFF controller is equipped with a sequential operation function that sequentially turns indoor units on in 2-second intervals during unified operation. (Sequential operation is factory set to "ON.") To switch sequential operation ON or OFF, set as follows.

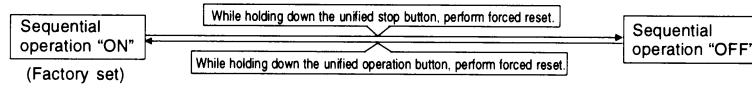

NOTE: The sequential operation function is designed to reduce the load on the power supply equipment, but does not guarantee that compressors will not be started simultaneously. You cannot therefore count on a capacity reduction effect by power supply equipment breaker selection.

⑤ Control mode selector (DS2)

The following four patterns of control mode can be set.

Control mode	Individual	Centralized	Timer operation possible by remote controller	ON/OFF control impossible by remote controller
Content	Operation/stop is controlled by both unified ON/OFF controller and remote controller.	After operated by unified ON/OFF controller, operation/stop is freely controlled by remote controller until stopped by unified ON/OFF controller.	When used in conjunction with schedule timer, operation/stop is controlled freely by remote controller during the set time but operation is not available when schedule timer is ON.	Operation/stop is controlled by unified ON/OFF controller only. (This unit can not be operated/stopped by remote controller.)
DS2 setting				
	(Factory set)			

- NOTES)
- indicates the position of switches.
  - Set control mode before turning power supply ON.
  - When used in conjunction with central remote controller, the control modes of the central remote controller has the priority.

⑥ Forced reset switch (SS1)

When changing the setting of the connector for setting master controller, etc., you can reset simply by setting it to the reset side once and returning to the normal side, without turning the power OFF.

(For normal operation, set the switch to the normal side.)

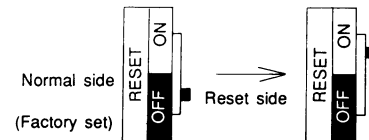

## 6 SETTING GROUP NO. FOR CENTRALIZED CONTROL

Set the group number of each group of the indoor unit from the remote controller. (In case of no remote controller, also connect the remote controller and set the group No. Then, remove the remote controller.)

- ① Turn ON the power of the indoor unit and unified ON/OFF controller. (Unless the power is ON, no setting can be made.)  
Check that the installation and electrical wiring are correct before turning the power supply ON.  
When the power supply is turned ON, all LCD appear once and the unit may not accept the operation for about one minute with the display of "HOST\_A" flashing (an interval of ON, ON, and OFF).
- ② While in the normal mode, hold down the "TEST" button for a minimum of 4 seconds.  
The remote controller will enter the FIELD SET MODE.
- ③ Select the MODE No. "00" with the "MODE" button.
- ④ Use the "GROUP" button to select the group No. for each group.  
(Group numbers increase in the order of 1-00, 1-01, ... 1-15, 2-00, ... 8-15.)
- ⑤ Press "SET" to set the selected group No.
- ⑥ Press "TEST" to return to the NORMAL MODE.

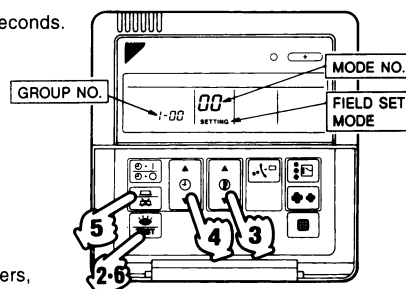

- NOTES)
- For simplified remote controller, see the installation table.
  - For setting group No. of HRV and wiring adaptor for other air conditioners, etc., refer to the instruction manual attached.

**NOTICE** Enter the group No. and installation place of the indoor unit into the attached installation table. Be sure to keep the installation table with the operation manual for maintenance.

## 7 CONFIRMING OPERATION

Before starting test operation, supply power to the indoor units, outdoor units, and unified ON/OFF controller and press the ON/OFF BUTTON.

If the operation lamp flashes, it indicates a malfunction in the indoor unit of the applicable group.

If the display of "HOST\_A" flashes, it indicates a malfunction in the optional controllers for centralized control. Check for such malfunctions.

- NOTES**
- For test operation of indoor and outdoor units, refer to the installation manual attached with the outdoor unit.
  - After turning the power supply ON, if the unit does not accept operation for two minutes or more with the display of "HOST\_A" flashing, check the following points.
    - Check that setting of the connector for setting master controller is correct.
    - Check that the group No. for centralized control has been set.

1P162827