

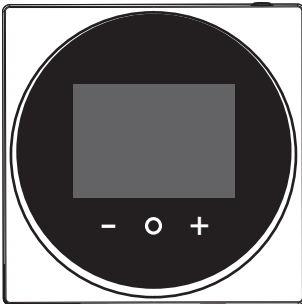

Installer and user reference guide

Wired remote controller



BRC1H519W
BRC1H519K
BRC1H519S

Installer and user reference guide
Wired remote controller

English

Table of contents

1	General safety precautions	3	12	Starting up the system	12
1.1	For the user	3	12.1	Master and slave controller	12
1.2	For the installer	3	12.2	To designate a controller as slave	12
2	About this document	4	13	Operation	13
For the user			13.1	Buttons	13
3	Buttons	4	13.2	Screen	13
4	Home screens	4	13.3	Status indicator	13
5	Status icons	5	13.4	Information	14
6	Operation	5	13.4.1	Information screen	14
6.1	Operation mode	5	13.4.2	Information menu	14
6.1.1	About the operation modes	6	14	Configuration	14
6.1.2	To set the operation mode	7	14.1	Installer menu	14
6.2	Setpoint	7	14.1.1	About the installer menu	14
6.2.1	About the setpoint	7	14.1.2	Screen settings	15
6.2.2	To set the setpoint	7	14.1.3	Status indicator settings	15
6.3	Date and time	7	14.1.4	Field settings	15
6.3.1	About date and time	7	14.1.5	Miscellaneous settings	20
6.3.2	To set date and time	7	14.2	Remote controller software update	27
6.4	Airflow	7	14.2.1	To update the software with Updater	27
6.4.1	Airflow direction	7	15	About the app	28
6.4.2	Fan speed	8	15.1	Operation and configuration overview	28
6.5	Ventilation	8	15.2	Pairing	28
6.5.1	Ventilation mode	8	15.2.1	About pairing	28
6.5.2	Ventilation rate	9	15.2.2	To pair the app with a controller	28
6.6	Advanced operation	9	15.3	Installer mode	28
6.6.1	To make a Bluetooth connection	9	15.3.1	About installer mode	28
7	Maintenance and service	9	15.3.2	To activate Installer mode	28
7.1	Overview: Maintenance and service	9	15.3.3	To deactivate Installer mode	28
8	Troubleshooting	9	15.3.4	To make Installer mode settings	28
8.1	Overview: Troubleshooting	9	15.4	Demo mode	28
8.2	Refrigerant leak detection	9	15.4.1	About demo mode	28
8.2.1	To stop the leak detection alarm	10	15.4.2	To launch demo mode	29
8.2.1	To stop the leak detection alarm	10	15.4.3	To exit demo mode	29
For the installer			15.5	Functions	29
9	About the box	10	15.5.1	Overview: Functions	29
9.1	To unpack the controller	10	15.5.2	Remote controller firmware update	29
10	Preparation	10	15.5.3	Notifications	30
10.1	Wiring requirements	10	15.5.4	Master/slave status	30
10.1.1	To prepare the wiring for installation	10	15.5.5	Screen	30
11	Installation	10	15.5.6	Status indicator	30
11.1	Overview: Installation	10	15.5.7	Date and time	30
11.2	Mounting the controller	10	15.5.8	About	30
11.2.1	About mounting the controller	10	15.5.9	Remove bonding information	30
11.2.2	To mount the controller	11	15.5.10	Presence detection	30
11.3	Connecting the electrical wiring	11	15.5.11	OFF timer	30
11.3.1	Precautions when connecting the electrical wiring	11	15.5.12	Energy consumption	31
11.3.2	To connect the electrical wiring	11	15.5.13	Power consumption limit	31
11.4	Closing the controller	11	15.5.14	Setpoint auto reset	31
11.4.1	Precautions when closing the controller	11	15.5.15	Schedule	31
11.4.2	To close the controller	12	15.5.16	Holiday	31
11.5	Opening the controller	12	15.5.17	Setpoint mode	31
11.5.1	Precautions when opening the controller	12	15.5.18	Setback	31
11.5.2	To open the controller	12	15.5.19	Individual airflow direction	32
			15.5.20	Setpoint range	32
			15.5.21	Cooling/Heating masterhood	32
			15.5.22	Airflow direction range	32
			15.5.23	Draught prevention	33
			15.5.24	Quick start	33
			15.5.25	External input interlock	33
			15.5.26	Defrost operation	33
			15.5.27	Function lock	33
			15.5.28	Quiet mode	34
			15.5.29	Errors and warnings	34
			15.5.30	Unit number	34
			15.5.31	Filter auto clean	34
			15.5.32	Filter notifications	34
			15.5.33	AirNet address	34

15.5.34	Group address	34
15.5.35	Field settings	34
15.5.36	Duty rotation	35
15.5.37	Test operation	36
15.5.38	Unit status	36
15.5.39	Operating hours	36
15.5.40	Contact information	36
16	Maintenance	36
16.1	Maintenance safety precautions	36
16.2	About maintenance	37
16.3	To remove a warning screen	37
16.4	To clean the controller	37
17	Troubleshooting	37
17.1	Error codes of the indoor unit	37
18	Technical data	38
18.1	Connection diagram	38
18.1.1	Typical layout	38
18.1.2	Typical layout for group control	38
18.1.3	Controller + DIII central control equipment	39







1 General safety precautions

Please read these general safety precautions carefully before installing air conditioning equipment, and be sure to install the equipment correctly.



Failure to follow these instructions properly may result in property damage or personal injury, which may be serious depending on the circumstances.

Meaning of warnings and symbols

These safety messages are used to attract your attention. The meaning of each safety message is described below:

	WARNING Indicates a situation that could result in death or serious injury.
	CAUTION Indicates a situation that could result in minor or moderate injury.
	DANGER Indicates a situation that results in death or serious injury.
	DANGER: RISK OF EXPLOSION Indicates a situation that could result in explosion.
	INFORMATION Indicates useful tips or additional information.
	NOTICE Indicates a situation that could result in equipment or property damage.

1.1 For the user

	INFORMATION Also see the operation manual delivered with the outdoor and indoor unit.
	WARNING Do NOT play with the unit or its remote controller. Accidental operation by a child may result in impairment of bodily functions and harm health.

 **WARNING**

To prevent electric shocks or fire:

- Do NOT operate the controller with wet hands.
- Do NOT disassemble the controller and touch interior parts. Contact your dealer.
- Do NOT modify or repair the controller. Contact your dealer.
- Do NOT relocate or reinstall the controller by yourself. Contact your dealer.

 **WARNING**

Do NOT use flammable materials (e.g. hairspray or insecticide) near the controller.

 **NOTICE**

To clean the controller, do NOT use organic solvents, such as paint thinner. **Possible consequence:** damage, electric shock, or fire.

1.2 For the installer

The precautions described in this document cover very important topics, follow them carefully.

 **INFORMATION**

This controller is an option and cannot be used standalone. Also see the installation and operation manual of the indoor and outdoor units.

 **NOTICE**

Improper installation or attachment of equipment or accessories could result in electric shock, short-circuit, leaks, fire or other damage to the equipment. Only use accessories, optional equipment and spare parts made or approved by Daikin.

 **WARNING**

All field wiring and components MUST be installed by a licensed electrician and MUST comply with the applicable legislation.

 **NOTICE**

The remote controller MUST be mounted indoors.

 **NOTICE**

When the controller is used as room thermostat, select an installation location where the average temperature in the room can be detected.

Do NOT install the controller in the following places:

- In places that are exposed to direct sunlight.
- In places that are near a heat source.
- In places that are affected by outside air or air draught due to e.g. door opening/closing.
- In places where the display can easily get dirty.
- In places where there is NO easy access to the controls.
- In places with temperatures $<-10^{\circ}\text{C}$ and $>50^{\circ}\text{C}$.
- In places where the relative humidity is $>95\%$.
- In places where there is machinery that emits electromagnetic waves. Electromagnetic waves may disturb the control system, and cause malfunction of the equipment.
- In places where it may be exposed to water, or in generally moist areas.

2 About this document

If you are NOT sure how to install or operate the unit, contact your dealer.

After finishing installation:

- Conduct a trial operation to check for faults.
- Explain the user how to operate the controller.
- Ask the user to store the manual for future reference.



INFORMATION

Consult your dealer regarding the relocation and reinstallation of the controller.

2 About this document

Target audience

Authorised installers + end users

Documentation set

This document is part of a documentation set. The complete set consists of:

- **Installation and operation manual:**
 - Installation instructions
 - Basic operation instructions
 - Format: Paper (in the box of the controller)
- **Installer and user reference guide:**
 - Extended installation and operation information
 - Format: Digital files on <http://www.daikineurope.com/support-and-manuals/product-information/>

Madoka Assistant in-app documentation:

- The controller only allows for basic settings and operation. Advanced settings and operation are performed via the Madoka Assistant app. For more information, see the app and its in-app documentation.
- Format: App available from Google Play and the Apple Store

Declaration of conformity:

- Hereby, Daikin Europe N.V. declares that the radio equipment type BRC1H is in compliance with the Directive 2014/53/EU. The original declaration of conformity is available from the BRC1H product page <http://www.daikin.eu/BRC1H>.
- Format: Digital file from the product page

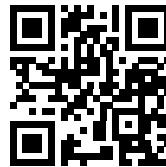

Latest revisions of the supplied documentation may be available on the regional Daikin website or via your dealer.

The original documentation is written in English. All other languages are translations.

Technical engineering data

- A **subset** of the latest technical data is available on the regional Daikin website (publicly accessible).
- The **full set** of latest technical data is available on the Daikin extranet (authentication required).

For the user

3 Buttons

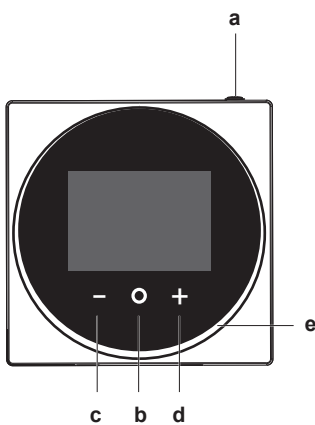

- a ON/OFF
 - When OFF, press to turn ON the system. As a result, the status indicator (e) will turn ON too.
 - When ON, press to turn OFF the system. As a result, the status indicator (e) will turn OFF too.
- b ENTER/ACTIVATE /SET
 - From the home screen, enter the main menu.
 - From the main menu, enter one of the submenus.
 - From their respective submenu, activate an operation/ventilation mode.
 - In one of the submenus, confirm a setting.
- c CYCLE/ADJUST
 - Cycle left.
 - Adjust a setting (default: decrease).
- d CYCLE/ADJUST
 - Cycle right.
 - Adjust a setting (default: increase).



INFORMATION

The behaviour of the status indicator is according to field settings. For more information, see "14.1.3 Status indicator settings" on page 15.

4 Home screens

Depending on installer configuration, the controller either has a standard or a detailed home screen. In most cases, the standard home screen gives you only the active operation mode, messages (if any), and the setpoint temperature (in case of Cooling, Heating, or Auto operation mode). The detailed home screen gives you all kinds of information through status icons.

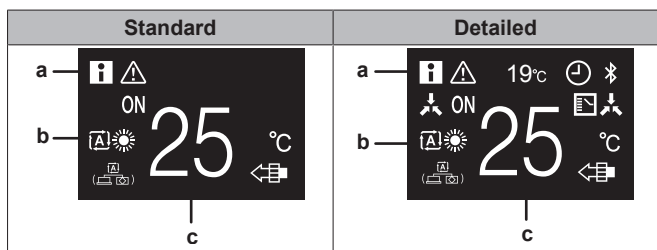























- a Messages
- b Active operation mode
- c Setpoint temperature

INFORMATION

The controller is equipped with a power saving function that causes the screen to go blank after a period of inactivity. To make the screen light up again, press one of the buttons.

5 Status icons





Icon	Description
	System operation ON. Indicates that the system is in operation.
	System operation OFF. Indicates that the system is NOT in operation.
	Bluetooth. ¹ Indicates that the controller is communicating with a mobile device, for use with the Madoka Assistant app.
	Lock. Indicates that a function or operation mode is locked and therefore cannot be used or selected.
	Centralised control. Indicates that the system is controlled by central control equipment (optional accessory) and that control of the system by the controller is limited.
	Changeover under centralised control. Indicates that the cooling/heating changeover is under centralised control by another indoor unit, or by an optional cool/ heat selector that is connected to the outdoor unit.
	Defrost/Hot start. Indicates that the defrost/hot start mode is active.
	Schedule/Timer. Indicates that the system operates according to a schedule, or that the OFF timer is enabled.
	Time not set. Indicates that controller's time is not set.
	Self-cleaning filter operation. Indicates that self-cleaning filter operation is active.
	Quick Start. Indicates that Quick Start mode is active (Sky Air only).
	Test operation. Indicates that Test Operation mode is active (Sky Air only).
	Inspection. Indicates that the indoor or outdoor unit is being inspected.
	Periodic inspection. Indicates that the indoor or outdoor unit is being inspected.
	Backup. Indicates that in the system an indoor unit is set as backup indoor unit.
	Individual airflow direction. Indicates that the individual airflow direction setting is enabled.
	Information. Indicates that the system has a message to convey. To see the message, go to the information screen.

Icon	Description
	Warning. Indicates that an error occurred, or that an indoor unit component needs to be maintained.
	Power consumption limit. Indicates that the system's power consumption is being limited, and that it is running with restricted capacity.
	End of power consumption limit. Indicates that the system's power consumption is no longer being limited, and that it is no longer running with restricted capacity.
	Rotation. Indicates that Rotation mode is active.
	Setback. Indicates that the indoor unit is operating under setback conditions.
	Ventilation. Indicates that a heat reclaim ventilation unit is connected.

INFORMATION

- For information on the operation mode and ventilation mode icons, see "6.1 Operation mode" on page 5 and "6.5.1 Ventilation mode" on page 8 respectively.
- Most icons are related to things set in the Madoka Assistant app. For more information, see the app.

6 Operation

From the home screen, press  to enter the main menu. Use  and  to cycle through the menus. Press  again to enter one of the menus.

INFORMATION

- Depending on the type of indoor unit you are operating, more or less menus may be available.
- In the main menu, the icon for each menu reflects the current active setting or mode. When operating the controller, the menu you navigate through can look different from that represented in this manual.
- The controller only allows for basic operation of the system. For advanced operation (setback, schedule timer, ...), see the Madoka Assistant app.

INFORMATION

It is possible that menus are locked. When this is the case, they appear crossed-out in the menu, and get accompanied by a lock icon. The locking of functions happens through the Madoka Assistant app. For more information, see the Madoka Assistant app and "15.5.27 Function lock" on page 33.

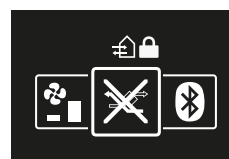









6.1 Operation mode

The indoor unit can operate in various operation modes.

⁽¹⁾ The Bluetooth® word mark and logos are registered trademarks owned by the Bluetooth SIG, Inc. and use of such marks by Daikin Europe N.V. is under license. Other trademarks and trade names are those of their respective owners.

6 Operation

Icon	Operation mode
	Cooling. In this mode, cooling will be activated as required by the setpoint, or by Setback operation..
	Heating. In this mode, heating will be activated as required by the setpoint, or by Setback operation.
	Fan Only. In this mode, air circulates without heating or cooling.
	Dry. In this mode, the air humidity will be lowered with a minimal temperature decrease. The temperature and fan speed are controlled automatically and cannot be controlled by the controller. Dry operation will not function if the room temperature is too low.
	Ventilation. In this mode, the space gets ventilated, but not cooled or heated.
	Air Clean. In this mode, the optional air cleaning unit operates.
	Ventilation + Air Clean. Combination of ventilation and air clean operation.
	Auto. In Auto mode, the indoor unit automatically switches between heating and cooling mode, as required by the setpoint.
	



INFORMATION

Depending on the indoor unit, more or less operation modes are available.

6.1.1 About the operation modes



INFORMATION

If the indoor unit is a cooling-only model, it can only be set to run in Cooling, Fan only, or Dry operation mode.



INFORMATION

When operation modes are not available in the operation mode menu, it is additionally possible that they are locked. The locking of operation modes occurs through the Madoka Assistant app. For more information, see the Madoka Assistant app and "[15.5.27 Function lock](#)" on [page 33](#).



INFORMATION

If the operation mode changeover of an indoor unit is under centralised control ('changeover under centralised control' status icon blinking in the home screen), then it is NOT possible to change the operation mode of that indoor unit. For more information, see "[Cooling/Heating masterhood](#)" on [page 26](#).

Cooling

If the outdoor air temperature is high, it can take some time until the indoor room temperature reaches the setpoint temperature.

When the indoor room temperature is low, and the indoor unit is set to run in Cooling operation mode, the indoor unit can enter Defrost operation mode first (i.e. Heating operation), this to prevent a decrease of the system's cooling capacity due to frost on the heat exchanger. For more information, see "[Heating](#)" on [page 6](#).



The indoor unit can run in Cooling operation mode because it is operating under Setback conditions. For more information, see "[15.5.18 Setback](#)" on [page 31](#).

Heating

When running in Heating operation mode, the system requires a longer time to reach the setpoint temperature than when running in Cooling operation mode. To make up for this, it is recommended to let the system start operation in advance by making use of the timer function.

The indoor unit can run in Heating operation mode because it is operating under Setback conditions. For more information, see "[15.5.18 Setback](#)" on [page 31](#).

To prevent cold drafts and a reduction of the system's heating capacity, the system can run in the following special heating operation modes:

Operation	Description
Defrost	To prevent the loss of heating capacity due to frost accumulation in the outdoor unit, the system will automatically switch to defrost operation. During defrost operation, the indoor unit fan will stop operation, and the following icon will appear on the home screen:  The system will resume normal operation after approximately 6 to 8 minutes.
Hot start (VRV only)	During hot start, the indoor unit fan will stop operation, and the following icon will appear on the home screen: 



INFORMATION

When the system is stopped while the indoor unit is running in Heating operation mode, the fan will continue to operate for approximately 1 minute, this to get out any heat remaining in the indoor unit.



INFORMATION

- The lower the outdoor air temperature, the lower the heating capacity. If the system's heating capacity is insufficient, it is recommended to include another heating appliance into the setup (if you use a combustion appliance, ventilate the room regularly. Also, do not use the heating appliance in places where it is exposed to the airflow of the indoor unit).
- The indoor unit is of the hot air circulation type. As a result, after operation start, it takes the indoor unit some time to warm up the room.
- The indoor unit fan will automatically operate until the indoor temperature of the system rises to a certain level.
- When hot air stays under the ceiling and your feet feel cold, it is recommended to include a circulator into the setup.

Dry



NOTICE

To prevent water leakage or system failure, do NOT turn off the system immediately after indoor unit operation. Before turning off the system, wait until the drain pump finishes discharging any water remaining in the indoor unit (approximately 1 minute).



INFORMATION

To ensure a smooth start, do not turn off the system while it is operating.

6.1.2 To set the operation mode

- 1 Navigate to the operation mode menu.



- 2 Use **-** and **+** to select an operation mode.

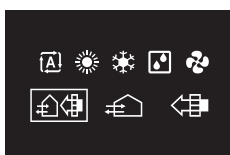

- 3 Press **OK** to activate.

Result: The indoor unit changes its operation mode and the controller returns to the home screen.

6.2 Setpoint

The setpoint is the target temperature for the Cooling, Heating, and Auto operation modes.

6.2.1 About the setpoint

The setpoint that is displayed on the home screen depends on ON/OFF status, and on whether Setback is enabled:

When ...	then ...
... the system is turned ON	... the home screen displays the regular temperature setpoint.
... the system is turned OFF, and Setback is disabled	... the home screen displays the regular temperature setpoint.
... the system is turned OFF, and Setback is enabled	... the home screen displays the Setback temperature setpoint.

For information about Setback, see "[15.5.18 Setback](#)" on page 31.

6.2.2 To set the setpoint

Prerequisite: The active operation mode is either 'Cooling', 'Heating', or 'Auto'.

- 1 In the home screen, use **-** and **+** to adjust the setpoint.



Result: The indoor unit changes its temperature setpoint.

6.3 Date and time

Set the date and time for the indoor units connected to the controller.

6.3.1 About date and time

Depending on daylight saving time settings, the date and time menu has the following daylight saving time indicators:

	Summer time
	Winter time

For more information, see "[Indoor unit field settings](#)" on page 18 (remote controller settings) and "[15.5.7 Date and time](#)" on page 30 (app settings).

6.3.2 To set date and time

- 1 Navigate to the date and time menu.

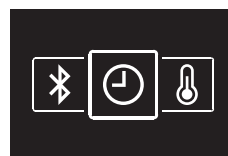

- 2 Press **+** to activate

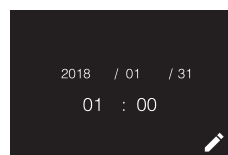

Result: The fields become editable.

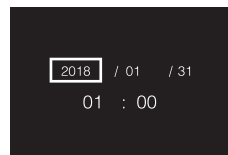

- 3 Set the date and time. Set with **-** and **+**. Confirm with **OK**. Cycle through the menu until all fields are set correctly.

Result: You set the date and the time.



INFORMATION

Confirming the value in a field will automatically bring you to the next field. To finish making settings and leave the menu, navigate to and confirm the value in the last field.

6.4 Airflow

6.4.1 Airflow direction



The airflow direction is the direction in which the indoor unit blows its air.

About airflow direction

The following airflow directions can be set:

Direction	Screen
Fixed position. The indoor unit blows air in 1 of 5 fixed positions.	

6 Operation

Direction	Screen
Swing. The indoor unit alternates between the 5 positions.	
Auto. The indoor unit adjusts its airflow direction according to movement sensed by a movement sensor.	

INFORMATION

- Depending on the type of indoor unit, and/or on system layout and organisation, Auto airflow direction may not be available.
- For some types of indoor unit, you cannot set the airflow direction.

Automatic airflow control

In the following operating conditions, the airflow direction of the indoor units is controlled automatically:

- When the room temperature is higher than the controller's setpoint for Heating operation (including Auto operation).
- When the indoor units run in Heating operation mode, and the Defrost function is active.
- When the indoor units run in Continuous operation, and the airflow direction is Horizontal.

To set the airflow direction

- Navigate to the airflow direction menu.



- Use  and  to adjust the airflow direction.



- Press  to confirm.

Result: The indoor unit changes its airflow direction and the controller returns to the home screen.



6.4.2 Fan speed

The fan speed is the strength of the airflow coming out of the indoor unit.

About fan speed

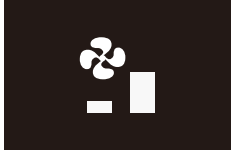
Depending on the indoor unit, you can choose between either:

Fan speed	Screen
2 fan speeds	

Fan speed	Screen
3 fan speeds	
5 fan speeds	

Some indoor units additionally support Automatic fan speed. In this case, the indoor unit adjusts its fan speed automatically, according to the setpoint and indoor temperature.

Fan speed	Screen
Automatic	



INFORMATION

- For mechanical protection purposes, it is possible that the indoor unit switches itself to 'Automatic fan speed' mode.
- If the fan stops operating, this does not necessarily mean system failure. The fan can stop operating at all times.
- It may take some time before changes made to fan speed settings are actually carried out.

To set the fan speed

- Navigate to the fan speed menu.



- Use  and  to adjust the fan speed.



- Press  to confirm.

Result: The indoor unit changes its fan speed and the controller returns to the home screen.

6.5 Ventilation

INFORMATION

Ventilation settings can ONLY be made for heat reclaim ventilation units.

6.5.1 Ventilation mode

The heat reclaim ventilation unit can operate in various operation modes.

Icon	Ventilation mode
	Energy Reclaim Ventilation. The outdoor air is supplied to the room after passing through a heat exchanger.
	Bypass. The outdoor air is supplied to the room without passing through a heat exchanger.
	Auto. To ventilate the room in the most efficient way, the heat reclaim ventilation unit automatically switches between "Bypass" and "Energy Reclaim Ventilation" mode (based on internal calculations).

i **INFORMATION**
Depending on the heat reclaim ventilation unit, more or less ventilation modes are available.

i **INFORMATION**
Ventilation mode changes are possible regardless of Cooling/Heating masterhood. For more information, see "[Cooling/Heating masterhood](#)" on page 26.

! **NOTICE**
Before starting up the system, the unit **MUST** be energised for at least 6 hours to avoid compressor breakdown during startup.

i **INFORMATION**
To ensure a smooth start, do not turn off the system while it is operating.

To set the ventilation mode

- 1 Navigate to the ventilation mode menu.



- 2 Use **-** and **+** to select a ventilation mode.



- 3 Press **OK** to activate.

Result: The heat reclaim ventilation unit changes its operation mode and the controller returns to the home screen.

6.5.2 Ventilation rate

The ventilation rate is the fan speed during ventilation operation.

To set the ventilation rate

- 1 Navigate to the ventilation rate menu.



- 2 Use **-** and **+** to adjust the ventilation rate.



- 3 Press **OK** to confirm.

Result: The heat reclaim ventilation unit changes its ventilation rate and the controller returns to the home screen.

6.6 Advanced operation

The controller only allows for basic operation. For advanced operation, use the Madoka Assistant app.

6.6.1 To make a Bluetooth connection

Prerequisite: You have a mobile device on which the Madoka Assistant app is installed and running.

Prerequisite: Your mobile device supports Bluetooth version 4.2.

- 1 Open the Madoka Assistant app and follow the instructions from there.

7 Maintenance and service

7.1 Overview: Maintenance and service

When the system needs to be maintained or serviced, consult your dealer.

When the following indoor unit components are due for maintenance, you will be confronted by a maintenance screen as soon as you try to enter the main menu:

Maintenance screens		
Clean filter	Replace filter	Empty dust collector

8 Troubleshooting

8.1 Overview: Troubleshooting

When the system is in error and the controller presents you with an error screen as soon as you try to enter the main menu, consult your dealer.

Error screen (example)

8.2 Refrigerant leak detection

When the system detects a refrigerant leak, an alarm goes off. Stop the alarm and consult your dealer.

9 About the box

8.2.1 To stop the leak detection alarm

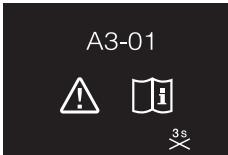

- 1 Press **+** for 3 seconds to stop the alarm.

Result: The alarm stops.

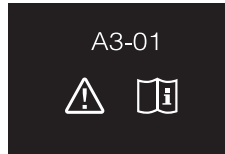

- 2 Consult your dealer.

For the installer

9 About the box

9.1 To unpack the controller

- 1 Open the box.
- 2 Separate the accessories.

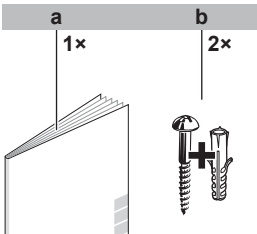

- a Installation and operation manual
b Wood screws + wall plugs (Ø4.0x30)

10 Preparation

10.1 Wiring requirements

All wiring must comply with the following requirements:

Wire specification	Value
Type	Sheathed vinyl cord or cable (2 wires)
Section	0.75~1.25 mm ²
Maximum length	500 m

10.1.1 To prepare the wiring for installation

- 1 Peel the sheath of the part of the cable that needs to pass through the inside of the rear casing (L), according to the figure and the table.
- 2 Keep a 10 mm distance between the length of the 2 wires.

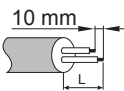

Wiring outlet	L
Top	±150 mm
Left	±120 mm
Bottom	±100 mm
Rear	No requirements

11 Installation

11.1 Overview: Installation

The installation of the controller typically consists of the following stages:

- 1 Determining how you want to route the electrical wiring, and nipping away a piece of the rear casing accordingly.
- 2 Mounting the rear casing to the wall.
- 3 Connecting the electrical wiring.
- 4 Closing the controller.

11.2 Mounting the controller

11.2.1 About mounting the controller

Before you can mount the controller, you have to determine the wiring routing, and accordingly, remove a piece of the controller's rear casing.

The wiring can be routed from the top, the rear, the left, or the bottom. Remove a piece of the rear casing according to the illustration:

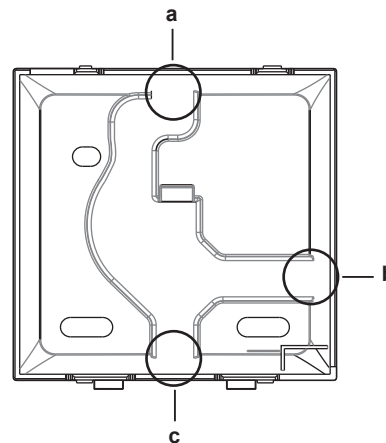

- a Wiring from the top
b Wiring from the left
c Wiring from the bottom

In case you are routing the wiring from the rear, you don't have to remove anything.



INFORMATION

When routing the wiring from the top or from the rear, insert the wiring through the knockout hole before mounting the rear casing to the wall.

11.2.2 To mount the controller

- 1 Take the screws and plugs from the accessory bag.
- 2 Mount the rear casing to a flat surface.

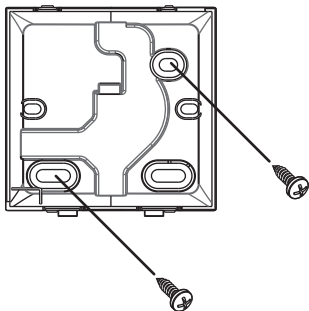

NOTICE

Be careful not to distort the rear casing by overtightening the mounting screws.

11.3 Connecting the electrical wiring

11.3.1 Precautions when connecting the electrical wiring



INFORMATION

Also read the precautions and requirements in the following chapters:

- General safety precautions
- Preparation



WARNING

All field wiring and components **MUST** be installed by a licensed electrician and **MUST** comply with the applicable legislation.



CAUTION

When connecting the controller to the indoor unit, make sure the indoor unit switchbox and transmission wiring are not connected.



NOTICE

The wiring for connection is **NOT** included.



NOTICE

When wiring, run the wiring away from the power supply wiring in order to avoid receiving electric noise (external noise).



INFORMATION

P1 and P2 have no polarity.

11.3.2 To connect the electrical wiring

Connect controller terminals P1/P2 to indoor unit terminals P1/P2.

From the top

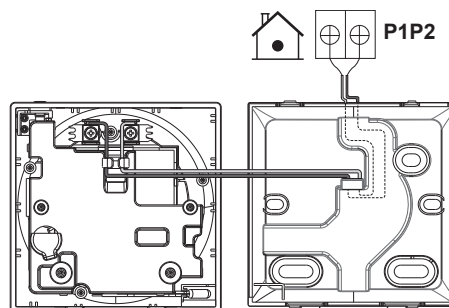

From the rear

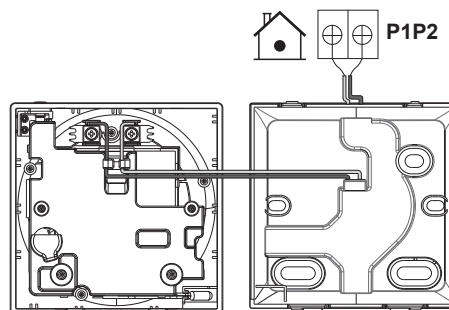

From the left

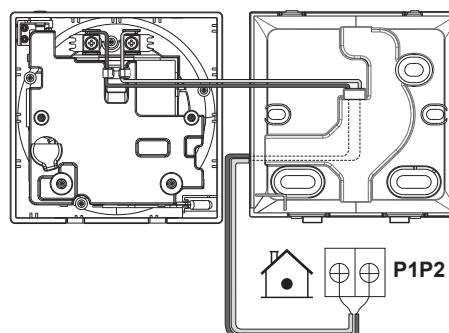

From the bottom

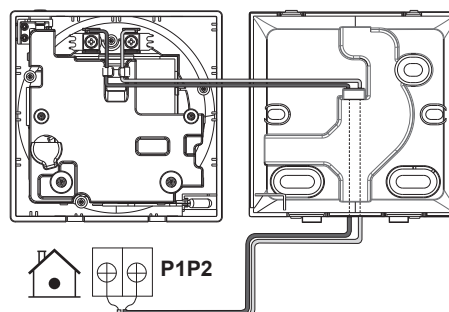

11.4 Closing the controller

11.4.1 Precautions when closing the controller



CAUTION

Never touch the internal parts of the controller.



CAUTION

When closing the controller, be careful not to pinch the wiring.

12 Starting up the system

NOTICE

To prevent damage, make sure the front of the controller is clicked into the rear casing securely.

11.4.2 To close the controller

- 1 Click the front of the controller into the rear casing.

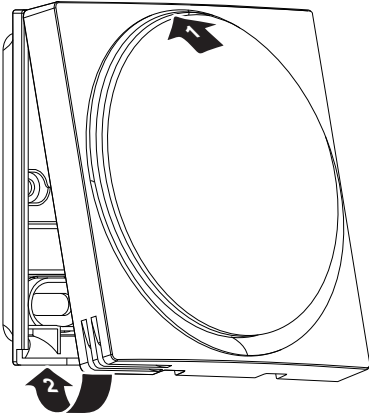

- 2 When the installation site is dust-free, peel off the protective seal.

11.5 Opening the controller

11.5.1 Precautions when opening the controller

NOTICE

The controller PCB is mounted into the front casing. When opening the controller, be careful not to damage the PCB.

NOTICE

When the front and rear casing are separated, make sure the PCB does not come into contact with dust or moisture.

11.5.2 To open the controller

- 1 Insert a flat-head screwdriver into one of the bottom closing mechanisms and slowly twist it.

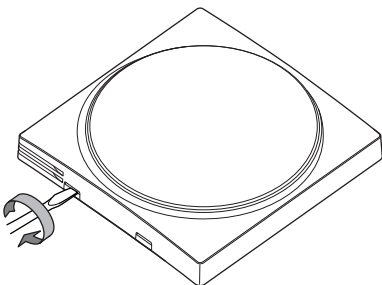

12 Starting up the system

CAUTION

Before starting up the system, make sure:

- The indoor and outdoor unit wiring is completed.
- The switch box covers of the indoor and outdoor units are closed.

The controller gets its power from the indoor unit. It will start up as soon as it is connected. For the controller to be operable, therefore make sure the indoor unit is powered on.

Once the controller is powered, it will automatically start up. If it is the first and only controller that is connected to the indoor unit, it will automatically get designated as master controller. For a second controller to get designated as slave controller, manual action is required. For instructions, see "12.2 To designate a controller as slave" on page 12.

12.1 Master and slave controller

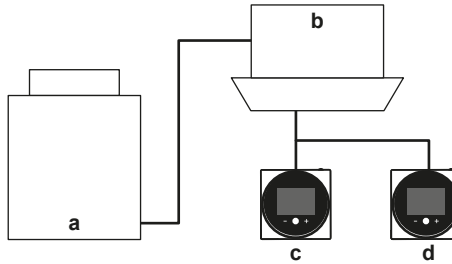

- a Outdoor unit
- b Indoor unit
- c Master remote controller
- d Slave remote controller

On the information screen, master/slave status is indicated by the following icons:

Icon	Description
	Master
	Slave

For more information, see "13.4.1 Information screen" on page 14.

INFORMATION

It is only possible to use a master and a slave controller of the same type.

INFORMATION

In case digital input adapter BRP7A5* is part of the system, it is not possible to connect and designate a second controller. Connecting a second controller when the system already contains the adapter, will cause the adapter to go in error.

INFORMATION

If a slave controller does not display the home screen 2 minutes after its designation, turn off the power and check the wiring.

INFORMATION

After re-designating a controller, the system requires a power reset.

INFORMATION

Slave controllers do not support all functions. If you cannot find a function on a slave controller, check for it on the master controller.

12.2 To designate a controller as slave

Prerequisite: A master controller is already connected to the indoor unit.

- 1 Connect a second controller.

Result: It will start up automatically.

- 2 Wait for a U5 or U8 error to appear on the screen.



- 3 When the U5 or U8 error appears, press  and keep it pressed until "2" appears on the screen.



Result: The controller is now designated as slave.







INFORMATION

If the slave controller does not display the home screen two minutes after its designation, turn off the power and check the wiring.

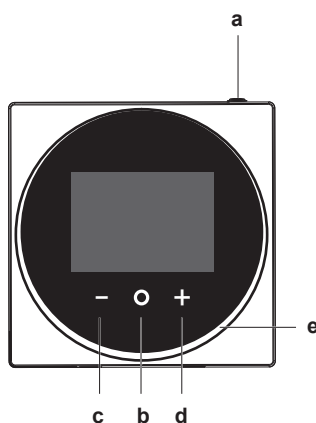
13 Operation

13.1 Buttons



- a  ON/OFF
- When OFF, press to turn ON the system. As a result, the status indicator (e) will turn ON too.
 - When ON, press to turn OFF the system. As a result, the status indicator (e) will turn OFF too.
- b  ENTER/ACTIVATE /SET
- From the home screen, enter the main menu.
 - From the main menu, enter one of the submenus.
 - From their respective submenu, activate an operation/ventilation mode.
 - In one of the submenus, confirm a setting.
- c  CYCLE/ADJUST
- Cycle left.
 - Adjust a setting (default: decrease).
- d  CYCLE/ADJUST
- Cycle right.
 - Adjust a setting (default: increase).



INFORMATION

The behaviour of the status indicator is according to field settings. For more information, see ["14.1.3 Status indicator settings" on page 15](#).

13.2 Screen

Home screen

Depending on installer configuration, the controller either has a standard or a detailed home screen. In most cases, the standard home screen gives you only the active operation mode, messages (if any), and the setpoint temperature (in case of Cooling, Heating, or Auto operation mode). The detailed home screen gives you all kinds of information through status icons.

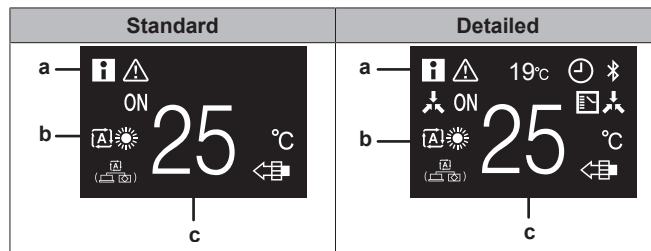

- a Messages
b Active operation mode
c Setpoint temperature

Home screen mode is set with remote controller field setting R1-7 (Home screen). For more information, see ["Remote controller field settings" on page 19](#).

Backlight

The screen backlight has the following states:

State	Description
ON	For the controller to be operable, the screen backlight needs to be ON (otherwise the controller does not detect any button presses). To turn ON the backlight, press  shortly. For instructions on how to set screen brightness and contrast when the backlight is ON, see "14.1.2 Screen settings" on page 15 .
OFF	After a period of operation inactivity, the backlight will either turn OFF, or go into a faint ON state, depending on operation conditions: <ul style="list-style-type: none"> Operation OFF: backlight OFF, Operation ON: backlight ON faintly. Backlight state changeover after inactivity is set with remote controller field setting R1-8 (No-operation timer). Backlight faintness is set with remote controller field setting R1-10 (Backlight faintness). For more information, see "Remote controller field settings" on page 19 .
ON faintly	

13.3 Status indicator

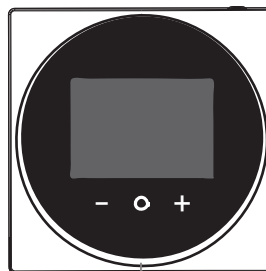

- a Status indicator



For instructions on how to make status indicator settings, see ["14.1.3 Status indicator settings" on page 15](#).

14 Configuration

13.4 Information

13.4.1 Information screen

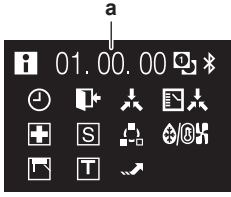
The information screen collects the following information:

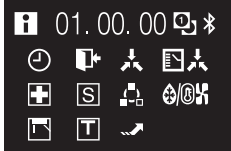
Information	Description
Software version	<p>The information screen will always contain the latest software version.</p>  <p>a Software version</p>
Status icons	<p>Depending on operation status, the information screen can contain various status icons. For the meaning of those icons, see "5 Status icons" on page 5.</p> <p>When the information screen has information to convey,  is displayed in the top left corner of the home screen.</p> 

INFORMATION

The presence of icons on the information screen depends on operation status. The controller may display more or less icons than are indicated here.

To enter the information screen

Prerequisite: The controller displays the home screen.

- 1 Press  and keep it pressed until the information screen appears.

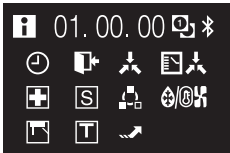

INFORMATION

The presence of icons on the information screen depends on operation status. The controller may display more or less icons than are indicated here.

13.4.2 Information menu











You can consult additional information in the information menu, which is part of the installer menu. For instructions on how to enter the information menu, see ["14.1 Installer menu" on page 14](#) and ["Information" on page 27](#).

14 Configuration

14.1 Installer menu

14.1.1 About the installer menu

In the installer menu you can make the following settings:

Category	Icon	Settings
Screen settings		Brightness
		Contrast
Status indicator settings		Intensity
Field settings		Indoor unit field settings
		Remote controller field settings
Miscellaneous settings		Group address and AirNet address
		External input interlock
		Force fan ON
		Switch Cooling/Heating master
		Information

To enter the installer menu

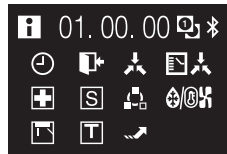

Prerequisite: The controller displays the home screen.

- 1 Press  and keep it pressed until the information screen appears:



INFORMATION

The presence of icons on the information screen depends on operation status. The controller may display more or less icons than are indicated here.

- 2 From the information screen, press  and  simultaneously and keep them pressed until you enter the installer menu:

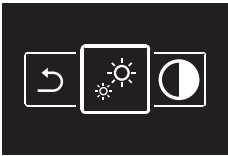

Result: You are now in the installer menu.

14.1.2 Screen settings

To set screen brightness

Prerequisite: You are in the installer menu.

- 1 Navigate to the screen brightness menu.

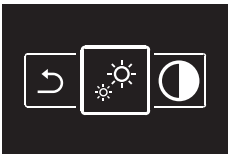

- 2 Use **-** and **+** to adjust screen brightness.



- 3 Press **OK** to confirm.

Result: The screen adjusts its brightness and the controller returns to the installer menu.

To set screen contrast

Prerequisite: You are in the installer menu.

- 1 Navigate to the screen contrast menu.

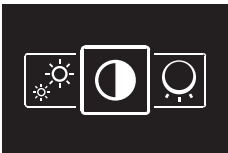

- 2 Use **-** and **+** to adjust screen contrast.

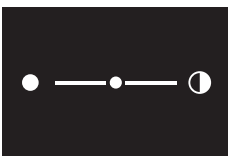

- 3 Press **OK** to confirm.

Result: The screen adjusts its contrast and the controller returns to the installer menu.

14.1.3 Status indicator settings

About status indicator settings

In the installer menu, you can set status indicator intensity and behaviour.

Intensity

For instructions on how to set status indicator intensity, see ["To set status indicator intensity" on page 15](#).

Behaviour

Status indicator behaviour is changed through remote controller field settings. For instructions on how to make field settings, see ["14.1.4 Field settings" on page 15](#). For an overview of remote controller field settings, see ["Remote controller field settings" on page 19](#).

To set status indicator intensity

Prerequisite: You are in the installer menu.

- 1 Navigate to the status indicator intensity menu.

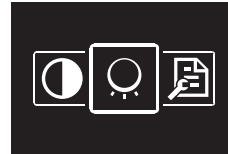

- 2 Use **-** and **+** to adjust status indicator intensity.

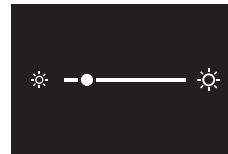

- 3 Press **OK** to confirm.

Result: The status indicator adjusts its intensity and the controller returns to the installer menu.

14.1.4 Field settings

About field settings

The controller allows for making field settings related to the indoor unit, and to the controller itself.

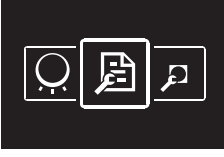
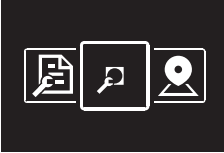
Screen	Field settings
	Indoor unit
	Remote controller

In both case, the setting procedure is the same. For instructions, see ["Setting procedure" on page 15](#).





Setting procedure

Field settings are composed of the following components:

- 1 Modes ("Mode"),
- 2 Units ("Unit"),
- 3 Settings ("SW"), and
- 4 Values for those settings.

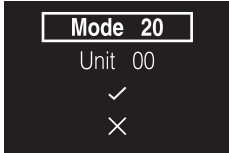
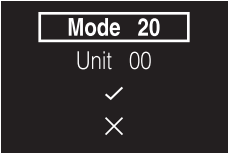
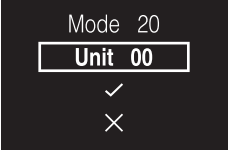

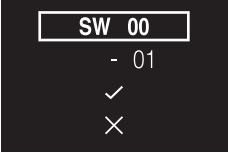
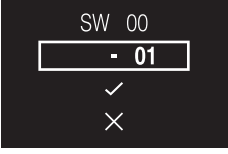
The field settings menus have two levels. You set modes and units in the first level, and settings and values in the second.

14 Configuration

Level	Description
<p>First level</p> 	<p>Mode (Mode)</p>  <p>A mode is a group of settable parameters.</p> <p>In the field settings tables, find available mode numbers in the "Mode" column. Mode numbers that apply to individual indoor units are between brackets in the "Mode" column.</p> <hr/> <p>Unit (Unit) (indoor unit field settings only)</p>  <p>A unit is an individual unit to which a setting might apply.</p> <p>When making field settings for individual units, this is the place where you define the number of the unit to which the setting applies.</p> <p>When making field settings for grouped units, you do NOT set the unit number. The settings will then apply to all indoor units that are part of that group.</p>
<p>Second level</p> 	<p>Setting (SW)</p>  <p>A setting is a settable parameter. These are the settings you are making.</p> <p>In the field settings tables, find the available setting numbers in the "SW" column.</p> <hr/> <p>Value</p>  <p>A value is one of a fixed set of values that you can choose for a setting.</p> <p>When the value field contains a "-", there are no values available for the selected setting:</p>  <p>When making group settings, you can ONLY set a value for a setting if the value field contains a "*" (if the value field does NOT contain a "*", you cannot apply the selected setting to the group):</p>  <p>In the field settings tables, find the available values for each setting in the "Value" column.</p>

Navigation

To navigate through the field settings menus, use , , and .

1 Use  and  to move the highlighter.

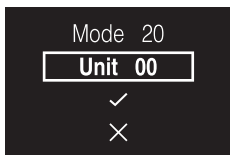

- 2 Press to select a field setting component.

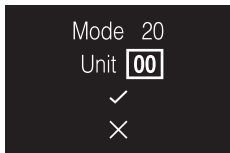

- 3 Use and to change the value of that field setting component.
- 4 Press to confirm that value.
- 5 In the first level, select to move to the second level.

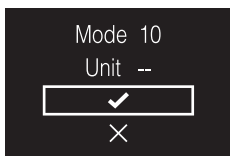

- 6 In the second level, navigate and select in the same way as you did in the first level.
- 7 Select to confirm and activate made settings.

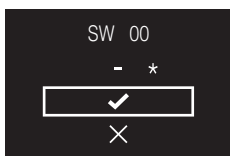

- 8 At all times, select to go back a level.

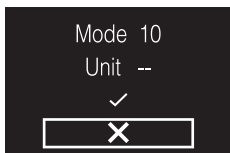

14 Configuration

Indoor unit field settings

The setting procedure is different depending on whether you want to make settings for individual units, or for grouped units.

Individual indoor units

- Define a mode by setting a Mode number (number between brackets)
- Define the unit to which the setting will apply by setting a Unit number
- Define the setting by setting a SW number

- Define a value for that setting

Grouped indoor units

- Define a mode by setting a Mode number (number NOT between brackets)
- Do NOT set a Unit number (setting applies to all the units in the group)
- Define the setting by setting a SW number
- Define a value for that setting

Mode	SW	Setting (SW) description	—						
			01	02	03	04			
10 (20)	00	Filter contamination timer: set the timer for the appearance of the "Time to clean filter" screen.	Ultra long life filter	Light	±10000 hrs.	Heavy	±5000 hrs	—	—
			Long life filter		±2500 hrs		±1250 hrs		
			Standard filter		±200 hrs		±100 hrs		
	01	Long life filter: if applicable, set which type of long life filter is used.	Long life filter	Ultra long life filter	—	—			
02	Controller thermostat sensor: set how the controller thermostat sensor is used.	Used in combination with indoor unit thermistor	Not used	Used exclusively	—				
03	Disable filter sign: set whether or not the filter sign can be displayed.	Display	Do not display	—	—				
11 (21)	00	Simultaneous operation: set the simultaneous indoor unit operation mode (Sky Air)	Pair	Twin	Triple	Double twin			
12 (22)	01	External On/OFF input: set the operation of voltage free contacts T1/T2 (indoor unit contacts)	Forced OFF	On/OFF operation	Emergency	Forced OFF (multi-tenant)			
	02	Thermostat differential: if the system contains a remote sensor, set the increase/decrease increments.	1°C	0.5°C	—	—			
13 (23)	00	High air outlet velocity: set in case of high-ceiling applications.	h≤2.7 m	2.7 m<h≤3 m	3 m<h≤3.5 m	—			
	01	Airflow direction: set in case an indoor unit is equipped with an option kit that blocks the airflow.	4-way flow	3-way flow	2-way flow	—			
	03	Airflow function: set whether the indoor unit is equipped with a decoration panel at its air outlet.	Equipped	Not equipped	—	—			
	04	Airflow direction range	Upper	Normal	Lower	—			
	06	External static pressure: set the external static pressure (according to the resistance of the connected ducts). FHYK: follow the high-ceiling setting.	Normal	High static pressure	Low static pressure	—			
15 (25)	03	Humidification drain pump: set whether the system is equipped with a humidification drain pump.	Equipped	Not equipped	—	—			
1c	01	Thermostat sensor: set which thermostat sensor you want to use.	Indoor unit thermistor	Controller thermistor	—	—			
1c	12	Window contact B1 (external input)	Do not use	Use	—	—			
1c	13	Key card contact B2 (external input)	Do not use	Use	—	—			
1e	02	Setback function: set Setback operation.	No Setback	Heating only	Cooling only	Heating and Cooling			
1e	07	Rotation overlap time. Set the Rotation overlap time.	30 minutes	15 minutes	10 minutes	5 minutes			
1B	08	Daylight saving time. Set how the system controls daylight saving time.	Disable	Automatic changeover	Manual changeover	Centralised control			



INFORMATION

- The connection of optional accessories to the indoor unit might cause changes to some field settings. For more information, see the installation manual of the optional accessory.
- For details about the specific field settings of each type of indoor unit, see the installation manual of the indoor units.
- Field settings that are not available for a connected indoor unit are not displayed.
- Field setting default values are different depending on the indoor unit model. For more information, see the service manual of the indoor units.

Remote controller field settings

Mode	SW	SW description	Value	Default value
R1	3	Controller thermistor adjustment (Cooling)	0: -3.0°C, 1: -2.5°C, 2: -2.0°C, 3: -1.5°C, 4: -1.0°C, 5: -0.5°C, 6: ±0°C, 7: +0.5°C, 8: +1.0°C, 9: +1.5°C, 10: +2.0°C, 11: +2.5°C, 12: +3.0°C	6
	4	Controller thermistor adjustment (Heating)	0: -3.0°C, 1: -2.5°C, 2: -2.0°C, 3: -1.5°C, 4: -1.0°C, 5: -0.5°C, 6: ±0°C, 7: +0.5°C, 8: +1.0°C, 9: +1.5°C, 10: +2.0°C, 11: +2.5°C, 12: +3.0°C	6
	5	Controller thermistor adjustment (Auto)	0: -3.0°C, 1: -2.5°C, 2: -2.0°C, 3: -1.5°C, 4: -1.0°C, 5: -0.5°C, 6: ±0°C, 7: +0.5°C, 8: +1.0°C, 9: +1.5°C, 10: +2.0°C, 11: +2.5°C, 12: +3.0°C	6
	6	Controller thermistor adjustment (Fan only)	0: -3.0°C, 1: -2.5°C, 2: -2.0°C, 3: -1.5°C, 4: -1.0°C, 5: -0.5°C, 6: ±0°C, 7: +0.5°C, 8: +1.0°C, 9: +1.5°C, 10: +2.0°C, 11: +2.5°C, 12: +3.0°C	6
	7	Home screen	0: Detailed 1: Standard	1
	8	Backlight no-operation timer	0: 5 seconds 1: 10 seconds 2: 20 seconds	0
	9	Status indicator faintness	0: 0% (OFF), 1: 1%, 2: 2%, 3: 3%, 4: 5%, 5: 7%, 6: 9%, 7: 11%, 8: 13%, 9: 15%, 10: 17%, 11: 20%	9
	10	Backlight faintness	0: 0% (OFF), 1: 1%, 2: 2%, 3: 3%, 4: 4%, 5: 5%,	5
	11	Status indicator mode	0: Normal 1: Hotel setting 1 2: Hotel setting 2	2
	13	Bluetooth Low Energy advertising	0: Always advertising 1: Enable manually	0
R2	1	Touch button indicator (on screen)	0: None 1: Small 2: Medium 3: Large	1

Status indicator mode (R1-11)

Remote controller field setting R1-11 allows for the status indicator to be set to a mode suitable for use in hotels. According to the value that is set for this setting, the status indicator has the following behaviour:

Operation state	Status indicator behaviour		
	0 (Normal)	1 (Hotel setting 1)	2 (Hotel setting 2)
Operation ON	ON	ON	ON (when the backlight goes into faint state, the status indicator turns OFF)
Operation OFF	OFF	OFF	OFF

14 Configuration

Operation state	Status indicator behaviour		
	0 (Normal)	1 (Hotel setting 1)	2 (Hotel setting 2)
Error	Blinking	(no change)	(no change)
Warning	ON	ON	ON (when the backlight goes into faint state, the status indicator turns OFF)
Setting of status indicator intensity	ON	ON	ON
Pairing with indoor unit	Blinking	Blinking	Blinking

14.1.5 Miscellaneous settings



Group address and Airnet address (DIII)

Group address

To control the system with central control equipment, you need to set addresses for:

- Groups ("Group"), and/or
- Units ("Group(Unit)").

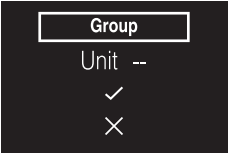
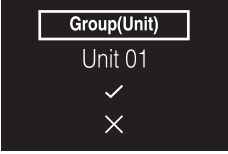
The Group address and Airnet address menu has two levels. You define groups and/or units in the first level, and set or release addresses for those groups and/or units in the second.

Address	Description
First level	Group (Group)  <p>A group is a group of indoor units. When setting addresses for groups, you do NOT have to define a unit number.</p>
	Unit (Group(Unit))  <p>A unit is an individual indoor unit. Define the indoor unit for which you want to set an address.</p> 

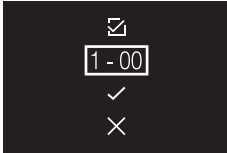
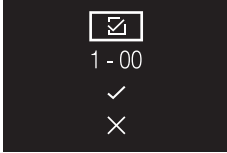
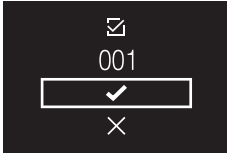
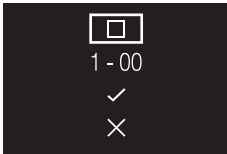
Address	Description
Second level	<p>Define an address for the indoor unit.</p>  <p>To SET an address, make sure <input checked="" type="checkbox"/> is selected.</p>  <p>Apply settings.</p>  <p>To RELEASE an address that was previously set, change <input checked="" type="checkbox"/> to <input type="checkbox"/> and then apply settings.</p> 

AirNet address





To connect the system to the AirNet monitoring and diagnostics system, you need to set AirNet addresses for:

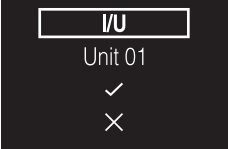

- Indoor units ("I/U")

- Outdoor units ("O/U")

The Group address and AirNet address menu has two levels. You define groups and/or units in the first level, and set and release an address for those groups and/or units in the second.

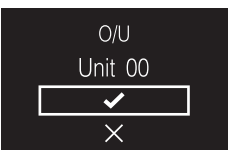
14 Configuration

Address	Description
First level	<p>Indoor unit (I/U)</p>  <p>Unit 01 ✓ ✗</p> <p>Define the indoor unit for which you want to set an AirNet address.</p>  <p>Unit 01 ✓ ✗</p> <p>Proceed to the next level.</p>  <p>Unit 01 ✓ ✗</p>
	<p>Outdoor unit (O/U)</p>  <p>Unit 00 ✓ ✗</p> <p>Define the outdoor unit for which you want to set an AirNet address.</p>  <p>Unit 00 ✓ ✗</p> <p>Proceed to the next level.</p>  <p>Unit 00 ✓ ✗</p>

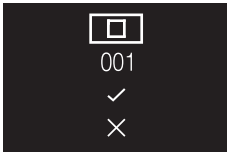
Address	Description
Second level	<p>Define an address for the indoor/outdoor unit.</p>  <p>To SET an address, make sure <input checked="" type="checkbox"/> is selected.</p>  <p>Apply settings.</p>  <p>To RELEASE an address that was previously set, change <input checked="" type="checkbox"/> to <input type="checkbox"/> and then apply settings.</p> 

External input interlock

About external input interlock

External input interlock allows for the integration of external contacts in the system's control logic. By adding a key card contact and/or a window contact to the control setup, it is possible to have the system respond to the insertion/removal of a key card in/from a card reader, and/or the opening/closing of windows.



INFORMATION

To use this function, it is required that digital input adapter BRP7A5* is part of the system.

- Make sure that the digital input adapter and its optional contacts (window contact B1 and key card contact B2) are correctly installed. Confirm that the voltage free contact of the digital input adapter is in the correct position. For instructions on how to install the digital input adapter, see the installation manual of the digital input adapter.
- When the digital input adapter does not function properly, external input interlock is not available in the menu.
- When the digital input adapter is part of the system, the system does not allow for the connection of a slave controller.
- When the digital input adapter is part of the system, it is not possible to use the Schedule function.
- When the digital input adapter is part of the system, as well as a centralised controller, the external input interlock function is controlled by the centralised controller, and not by the adapter.

To make external input interlock settings

Prerequisite: You are in the installer menu.

- Navigate to the external input interlock menu.

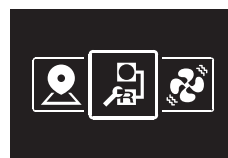

- Use **-** and **+** to navigate through the menu.
- Press **OK** to select a parameter.
- With a parameter selected, use **-** and **+** to change that parameter's value.
- With a parameter selected, press **OK** to confirm the value for that parameter.
- When you are done making settings, confirm all settings by selecting and pressing **OK**.

Result: The system will restart and implement any changes made.





INFORMATION

For an overview of settable parameters and what they mean, see ["External input interlock settings overview" on page 24](#).

14 Configuration

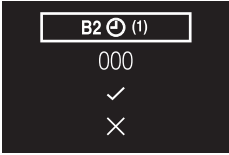
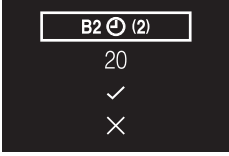
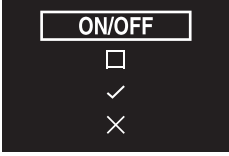
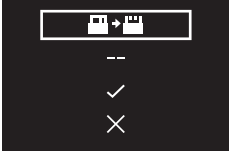
External input interlock settings overview

Parameter	Description	Possible values	Default value
B2 Delay Timer 	Timer that starts as soon as the key card is removed. The unit continues normal operation until the timer expires.	0-10 minutes	"1 min"
B2 Reset Timer 	Timer that starts as soon as the Delay Timer expires. When this timer expires, the previous state (i.e. regular setpoint) changes to the "Default Reset Setting" state.	0-20 hours	"20 hours"
Reset ON/OFF 	"Default Reset Setting" on/off state	"ON", "OFF", "--"	"OFF"
Reset Mode 	"Default Reset Setting" operation mode	Auto, Cooling, Heating, Fan only, --	"--"
Reset Cool SP 	"Default Reset Setting" cooling setpoint	See indoor unit's setpoint range and setpoint range limitation, "--"	"22°C"
Reset Heat SP 	"Default Reset Setting" heating setpoint	See indoor unit's setpoint range and setpoint range limitation, "--"	"22°C"



INFORMATION

When the value for a parameter is "- -", this means that when the timer expires, nothing changes for that parameter and the current active value is kept.

Window contact logic

Window contact B1	Key card contact B2	Time	Action
Contact closed (window closed)	Contact closed (key card IN)	—	<ul style="list-style-type: none"> Normal indoor unit operation. The unit returns to the previous state before opening the contact.
Contact open (window open)	Contact closed (key card IN)	—	Unit operation is forced off: <ul style="list-style-type: none"> No delay and reset timer functionality. No Setback functionality. Not possible to turn on/off the unit with the controller's ON/OFF button.

Key card contact logic

Window contact B1	Key card contact B2	Time	Action
Contact closed (window closed)	Contact closed (key card IN)	<ul style="list-style-type: none"> — Delay timer < Time < Reset timer Time > Reset timer 	<ul style="list-style-type: none"> The unit operates normally. If the reset timer has not expired, the unit returns to the previous state before opening the contact. If the reset timer has expired, the unit returns to the "Default Reset Setting" (see "External input interlock settings overview" on page 24).
Contact closed (window closed)	Contact open (key card OUT)	Time < Delay timer	Normal indoor unit operation.
Contact closed (window closed)	Contact open (key card OUT)	Time > Delay timer	Unit operation is forced off: <ul style="list-style-type: none"> Depending on whether the Setback function is enabled, Setback will work or not. Not possible to turn on/off the unit with the controller's ON/OFF button. After the delay timer has expired, the reset timer will start counting.



INFORMATION

- The "previous state" can be the on/off state, operation mode, cooling setpoint, and heating setpoint.
- When using the contacts, the fan speed as well as the Setback cooling and heating setpoints can be changed at any time, without losing changes.
- The fan speed is stored independently for the two main operation modes (Heating and Cooling). Separate fan speed settings are saved for Heating operation mode on the one hand, and Cooling, Dry and Fan only operation mode on the other hand.
- When closing the contact, changes made while the key card contact is open and the delay timer has not expired (normal operation) will not be saved.

Combination of window contact and key card contact logic

- The window contact has priority over the delay timer and the Setback functionality of the key card contact: When the window contact is opened while the key card contact is open, the delay timer will immediately expire if it is still running, and Setback will not work anymore. The reset timer will immediately start counting or will not reset when it was already running.
- The reset timer functionality of the key card contact has priority over the window contact when returning to the previous state: When the key card contact is opened while the window contact is open, the delay timer will start running. When the delay timer expires the reset timer will start running. When the reset timer expires, the previous state is updated to the **"Default Reset Setting"** state.

Example 1

- You remove the key card.

Result: The indoor unit continues operating normally until the delay timer expires.

- You open the window before the delay timer expires.

Result: The indoor unit stops immediately. It is not possible to turn the unit on or off, the Setback functionality does not work, the delay timer stops counting, and the reset timer starts counting.

- You insert the key card again.

Result: An update of the previous state occurs. The unit is forced off and the Setback functionality is still disabled (see ["Window contact logic"](#) on page 24).

IF the reset timer HAS NOT expired before inserting the key card, the previous state is the same as the original state because there was only a change to the original state.

IF the reset timer HAS expired before inserting the key card, the previous state is the **"Default Reset Setting"** state.

- You close the window.

Result: The unit reverts to the previous state. The previous state depends on the expiration of the reset timer.

Example 2

- You open the window.

Result: The unit stops immediately. It is not possible to turn the unit on or off with the ON/OFF button, the Setback functionality does not work, and the delay timer does not start counting.

- You remove the key card.

Result: The delay timer starts counting.

- You close the window again.

Result: There is no change in state. It is as if you never opened the window (Setback will work if enabled).

IF the delay timer HAS expired before closing the window, the reset timer will have started counting. Closing the window has no influence on the reset timer.

IF the delay timer HAS NOT expired before closing the window, it will expire immediately and the reset timer will start counting. When the reset timer expires, the previous state is updated to the "Default Reset Setting" state.

- You insert the key card again.

Result:

IF the reset timer HAS NOT expired before inserting the key card, the unit returns to the state before the window was opened (last "on" state);

IF the reset timer HAS expired before inserting the key card, the unit goes to the "Default Reset Setting" state.

14 Configuration

Force fan ON

About Force fan ON

Force fan ON allows you to force fan operation of individual indoor units. In this way, you can check which indoor unit number was assigned to which indoor unit.

To force fan operation

Prerequisite: You are in the installer menu.

- 1 Navigate to the Force Fan ON menu.



- 2 Select an indoor unit number.



- 3 Select and press to force fan operation.

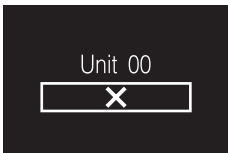

Result: The fan of the indoor unit that corresponds to the selected indoor unit number starts operating.

Cooling/Heating masterhood

About Cooling/Heating masterhood

A

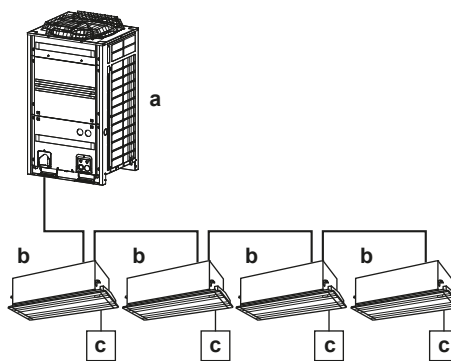

B

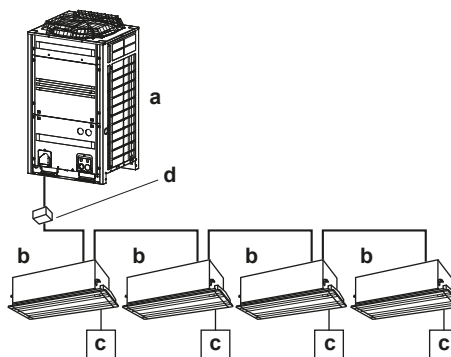

- A Heat pump system
- B Heat recovery system
- a Outdoor unit
- b Indoor unit
- c Remote controller
- d BS unit

When multiple indoor units are connected to an outdoor unit, one of these units (or a group of indoor units, in case of group control) needs to be set as Cooling/Heating master. The other units/groups then become Cooling/Heating slaves, and are restricted in their operation by the master (e.g. one outdoor unit does not allow for one indoor unit to run in Cooling operation while another runs in Heating operation).

When an indoor unit or group of indoor units is set as Cooling/Heating master, the other indoor units automatically become its slaves. For instructions, see ["To set Cooling/Heating masterhood" on page 27](#).

Status icon

Cooling/Heating masterhood corresponds to the following status icon:



The behaviour of this status icon is according to the following table:

If a controller displays ...	Then ...
... NO status icon	... The indoor unit connected to that controller is Cooling/Heating master.
... a CONSTANT status icon	... The indoor unit connected to that controller is slave to a Cooling/Heating master.
... BLINKING status icon	... NO indoor unit is assigned as Cooling/Heating master yet.

Operation mode

The operation mode behaviour of the indoor units is according to the following table:

If the master ...	Then the slaves ...
... is set to "Heating", "Dry", or "Auto" operation mode	... start running in the same operation mode as the master. No other modes are then available for them.
... is set to "Cooling" operation mode	... then the slaves cannot run in "Heating" operation mode, but can still run in "Cooling", "Fan only" and "Dry" operation mode.
... is set to "Fan only" mode	... can ONLY run in "Fan only" mode.

Once an indoor unit is set as master, it can be released from masterhood. For instructions, see ["To release Cooling/Heating masterhood" on page 27](#). To turn a slave unit/group into the master, first release the currently active master from its masterhood.



INFORMATION

Ventilation mode changes are possible regardless of Cooling/Heating masterhood.

To set Cooling/Heating masterhood

Prerequisite: No indoor unit is yet set as Cooling/Heating master ("changeover under centralised control" icon blinking on all controllers).

Prerequisite: You are operating the controller of the indoor unit that you want to set as Cooling/Heating master.

- 1 Navigate to the operation mode menu.



- 2 Set the operation mode to either Cooling or Heating.

Result: The indoor unit is now Cooling/Heating master ("changeover under centralised control" icon not on controller).

Result: All slave controllers display the "changeover under centralised control" icon.

To release Cooling/Heating masterhood

Prerequisite: You are in the installer menu.

Prerequisite: You are operating the controller of the indoor unit that you want to release from its masterhood.

- 1 Navigate to the Cooling/Heating masterhood menu.

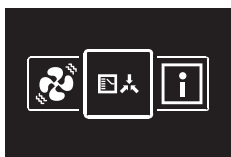

- 2 Press **+** to release the indoor unit from its masterhood.

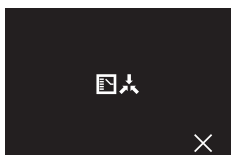

Result: The indoor unit is released from its masterhood.

Result: The controllers of all indoor units display a blinking "changeover under centralised control" icon.

Information

About the information menu

In the information menu, you can see the following information:

Information	Description
SW1	Controller software ID
Ver	Controller software version
	Time
SW2	UE878 software ID
---:---:---:---	UE878 MAC address

To see information

Prerequisite: You are in the installer menu.

- 1 Navigate to the information menu.



- 2 Read out information.

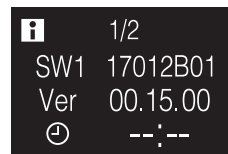

- 3 Press **+** to go to the second page.

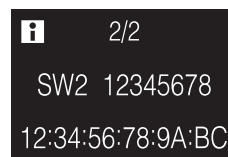

14.2 Remote controller software update

14.2.1 To update the software with Updater

Prerequisite: PC with Updater (contact your dealer for the correct version of the software)

Prerequisite: PC USB cable EKPCAB4 or higher (includes a USB cable and additional connection cables)

- 1 Make sure that the indoor unit is powered OFF.
- 2 Connect the controller to the PC.

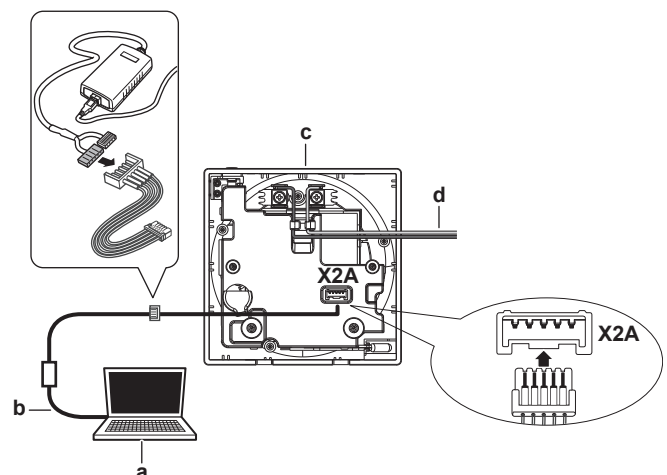

15 About the app

- a PC with Updater
- b USB cable
- c Controller PCB
- d To indoor unit

- 3 Power ON the indoor unit.
- 4 Open Updater.
- 5 In Updater, go to "Update procedure".
- 6 Type in the model name of the controller.
- 7 Select the desired update procedure.
- 8 Follow the on-screen instructions.

15 About the app

The Madoka Assistant app is a companion to the BRC1H remote controller. Where the controller only allows for basic operation and configuration, the app offers advanced operation and configuration functionality.

15.1 Operation and configuration overview

The app continually searches for BRC1H controllers to connect with. All controllers that are in range of your mobile device are listed in the home menu.

To operate and/or configure the system, tap the tile of the controller that is connected to the indoor units that you want to control.

15.2 Pairing

15.2.1 About pairing

Before you can actually connect with a controller, you have to make sure that the app and the controller are paired. Pair the app with all the controllers that you want to connect with.

15.2.2 To pair the app with a controller

Prerequisite: You are close to the controller.

- 1 In the app, tap the controller that you want to pair with.
Result: The operating system of your mobile device sends out a pairing request.
Result: The controller displays the following screen:

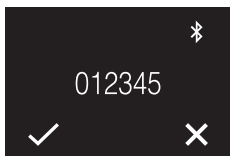

- 2 In the app, accept the pairing request.
- 3 On the controller, accept the pairing request by pressing

Result: The app is paired with the controller.

INFORMATION

Once paired with the app, the controllers will remain bonded. It is not required to repeat this procedure each time you want to use the app, unless you delete the bonds.

15.3 Installer mode

15.3.1 About installer mode

In installer mode you have access to settings that are not available for regular end users.

15.3.2 To activate Installer mode

Prerequisite: You are not in installer mode.

- 1 Go to the main menu.
- 2 Tap "About".
- 3 Tap "Application version" five times.

Result: You are in the installer mode menu.

Result: Installer mode is automatically activated.



INFORMATION

- To continue using the app in installer mode, tap the return button.
- The duration of installer mode depends on installer mode settings. For more information, see "[15.3.4 To make Installer mode settings](#)" on page 28.
- There is a visual indication that installer mode is active, which can be disabled. For more information, see "[15.3.4 To make Installer mode settings](#)" on page 28.

15.3.3 To deactivate Installer mode

Prerequisite: You are in installer mode.

- 1 Go to the main menu.
- 2 Tap "Installer mode enabled".
Result: You are in the installer mode menu.
Result: Installer mode is automatically activated.
- 3 Deactivate installer mode by tapping the slider.

Result: Installer mode is deactivated.

15.3.4 To make Installer mode settings

- 1 Enable installer mode.
Result: You are in the installer mode menu.
- 2 Make installer mode settings.

Installer mode settings	Description
Installer mode activation	Enable or disable installer mode.
Installer mode duration timer	Set the duration of installer mode. <ul style="list-style-type: none">▪ 30 minutes: installer mode active for 30 minutes. After 30 minutes, installer mode will automatically deactivate. (default)▪ Indefinitely: installer mode active until the next manual deactivation.
Installer mode indicator	Set whether installer mode activation is indicated by the installer mode indicator.



INFORMATION

Mind that installer mode is automatically enabled as soon as you enter the installer mode menu.

15.4 Demo mode

15.4.1 About demo mode

To try out the app's operation and configuration functions in a safe environment, it is possible to launch a demo version of the app.

15.4.2 To launch demo mode

Prerequisite: You are not in demo mode.

- 1 Go to the main menu.
- 2 Tap "Demo mode".

Result: You are in demo mode.

15.4.3 To exit demo mode

Prerequisite: You are in demo mode.

- 1 Go to the main menu.
- 2 Tap "Exit demo mode".

Result: You exited demo mode.

15.5 Functions

15.5.1 Overview: Functions

Category	Control
Operation	Turn ON/OFF unit operation
	Read out temperature sensor information
	Change the operation mode
	Change the setpoint
	Change the fan speed
	Change the ventilation mode
	Change the ventilation rate
	Change the airflow direction
Configuration and advanced operation	See notifications
	Make controller and indoor unit settings:
	General
	▪ Remote controller firmware update
	▪ Notifications
	Remote controller settings
	▪ Master/slave status
	▪ Screen
	▪ Status indicator
	▪ Date and time
	▪ About
	▪ Remove bonding information
	Energy saving
	▪ Presence detection
	▪ OFF timer
	▪ Energy consumption
	▪ Power consumption limit ^(a)
▪ Setpoint auto reset	
>> to be continued	

Category	Control
<< continuation	
Configuration and advanced operation	Scheduling
	▪ Schedule
	▪ Holiday
	Configuration and operation
	▪ Setpoint mode
	▪ Setback
	▪ Individual airflow direction
	▪ Setpoint range
	▪ Cooling/Heating masterhood
	▪ Airflow direction range
	▪ Draught prevention
	▪ Quick start
	▪ Defrost operation ^(a)
	▪ Function lock
	▪ Quiet mode
	▪ External input interlock ^(a)
	Maintenance
▪ Errors and warnings ^(a)	
▪ Unit number	
▪ Filter auto clean	
▪ Filter notifications	
▪ AirNet address ^(a)	
▪ Group address ^(a)	
▪ Field settings ^(a)	
▪ Duty rotation ^(a)	
▪ Test operation ^(a)	
▪ Unit status	
▪ Operating hours ^(a)	
▪ Contact information	

(a) This function is only available when the app is in installer mode. For more information, see ["15.3 Installer mode" on page 28](#).

15.5.2 Remote controller firmware update

Update remote controller firmware. It is required to keep remote controller firmware up to date. When new firmware is available for a controller, the app will send out a notification in the operation screen of that controller.

To update remote controller firmware

Prerequisite: You are in the operation screen of one of the controllers, and the app notified you that new firmware for that controller is available.

Prerequisite: You are close to the controller.

- 1 Tap the settings icon.

Result: You are in the Unit settings menu.

- 2 At the very top, tap "Firmware update available".

Result: You are in the "Firmware update" menu.

- 3 Tap "Update firmware".

Result: The latest firmware is downloaded to the controller.

Result: During the download, the controller displays the following screen.

15 About the app

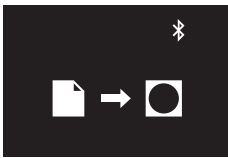

Result: After the download, the controller restarts to implement changes.

15.5.3 Notifications

Get an overview of active system notifications. These can be:

- Errors
- Warnings
- System information

15.5.4 Master/slave status

Find out if the controller you are operating is a master or a slave controller. It is not possible to make changes to master/slave status from the app. For instructions on how to change a controller's master/slave status, see ["12 Starting up the system" on page 12](#).

15.5.5 Screen

Make remote controller screen settings:

Setting	Description
Home screen mode	Switch between "Standard" or "Detailed" home screen mode. In "Detailed" mode, the remote controller gives extensive system operation through status icons, as compared to "Standard" mode.
Brightness	Set screen brightness.
Contrast	Set screen contrast.

INFORMATION

When making remote controller screen settings from the app, it is possible that the remote controller does not implement changes immediately. To make the controller implement changes: on the controller, navigate to the installer menu, and then back to the home screen. For instructions on how to enter the installer menu, see ["To enter the installer menu" on page 14](#).

15.5.6 Status indicator

Make remote controller status indicator settings:

Settings	Description
Mode	Check the active status indicator mode. It is not possible to set the status indicator mode from the app; this happens through remote controller field setting R1-11. For more information, see "Remote controller field settings" on page 19 .
Intensity	Set status indicator intensity.

15.5.7 Date and time

Set the remote controller date and time. In the date and time menu you send date and time information to the remote controller from the app. You can choose to either send the date and time information of your mobile device ("Synchronise"), or to manually create and send date and time information.

INFORMATION

If the controller is disconnected from the power for more than 48 hours, the date and the time need to be set again.

INFORMATION

The clock will maintain accuracy to within 30 seconds/month.

15.5.8 About

Read out the current remote controller and remote controller Bluetooth module software version.

15.5.9 Remove bonding information

Make the controller forget all previously bonded mobile devices.

15.5.10 Presence detection

Set a timer for the system to adjust the temperature setpoint or to turn off automatically, based on (the lack of) presence detected by a motion sensor.

Action	Description
Auto OFF	Set an OFF timer that starts running as soon as the motion sensor detects the room is unoccupied.
Setpoint adjustment	Set setpoint adjustment increments and intervals for both heating and cooling operation. When the motion sensor detects the room is unoccupied, the system will raise (cooling operation) or lower (heating operation) the setpoint, until the set limit is reached.

INFORMATION

To use this function, it is required that the indoor units are equipped with a motion sensor (optional accessory).

INFORMATION

This function cannot be used when the indoor units are controlled by a centralised controller.

INFORMATION

This function is not supported when the system contains Sky Air RR or RQ outdoor units.

INFORMATION

This function cannot be used when the indoor units are in group control.

INFORMATION

For systems in which the indoor units run in simultaneous operation, this function is controlled by the motion sensor mounted in the master indoor unit.

15.5.11 OFF timer

Set a timer for the system to turn OFF automatically. The timer can be enabled or disabled. When the timer is enabled, it starts running each time the system gets turned ON.

The timer has a range of 30~180 minutes, and can be set in increments of 10 minutes.

15.5.12 Energy consumption

See and compare energy consumption data.

i **INFORMATION**
The availability of this function depends on the type of indoor unit.

i **INFORMATION**
This function cannot be used when the indoor units are in group control.

i **INFORMATION**
This function is not supported when the system contains Sky Air RR or RQ outdoor units.

i **INFORMATION**
The displayed energy consumption can be different from the actual energy consumption. The displayed data is not the result of a kWh measurement, but the result of a calculation based on measured operation data. Some of that operation data are absolute values, but some are interpolations, including room for interpolation tolerance.

15.5.13 Power consumption limit

Set a timespan in which the system limits its peak power consumption. When enabled, this function makes the outdoor unit operate with limited energy consumption (70% or 40% of usual consumption) in the set timespan.

i **INFORMATION**
The availability of this function depends on the type of outdoor unit.

15.5.14 Setpoint auto reset

Set a timer for the system to automatically adjust the temperature to a set temperature value. The timer can be enabled or disabled for Heating and Cooling operation separately. When a timer is enabled, it starts running each time the system gets turned ON. When the timer runs out, the temperature setpoint will always change to the set value, also if the temperature setpoint has been changed in the meanwhile.

The timer has a range of 30~120 minutes, and can be set in increments of 30 minutes.

i **INFORMATION**
This function cannot be used when the indoor units are controlled by a centralised controller.

15.5.15 Schedule

Organise system actions into schedules. The schedule function allows you to set up to 5 timed actions for each day of the week. It is possible to create up to 3 different schedules, though only 1 schedule can be active at the same time.

The action logic is as follows:

- 1 Set a timespan for the action.
- 2 Choose to turn system operation ON or OFF, and set the conditions.

IF Operation	THEN
ON	Set action-specific temperature setpoints for Cooling and/or Heating operation, or choose to maintain the current setpoints.

IF Operation	THEN
OFF	Choose to enable or disable Setback operation for Cooling and/or Heating operation. If enabled, set action-specific Setback setpoints, or choose to maintain the current setpoints. For more information, see " 15.5.18 Setback " on page 31.

i **INFORMATION**
This function cannot be used when the indoor units are controlled by a centralised controller.

i **INFORMATION**
This function cannot be used when digital input adapter BRP7A5* is part of the system.

15.5.16 Holiday

Select days of the week for which the schedule does not apply. On the selected days, any actions set with the schedule function do not get executed. The holiday function can be enabled or disabled. When enabled, it applies to any schedule that is set to be active.

i **INFORMATION**
For more information, see "[15.5.15 Schedule](#)" on page 31.

15.5.17 Setpoint mode

Set whether the controller runs in "Indoor unit" or "Remote controller" setpoint mode.

Setpoint mode	Description
Indoor unit	The system uses indoor unit setpoint logic.
Remote controller	The setpoint logic is the same for Cooling and Heating operation.

i **INFORMATION**

- In "Remote controller" setpoint mode, there is one shared setpoint for Cooling and Heating operation mode. Changing the setpoint for Cooling operation automatically changes the setpoint for Heating operation.
- When the indoor units are under control of a centralised controller, only "Indoor unit" setpoint mode is possible.



15.5.18 Setback

Enable Setback temperature control. Setback is a function that keeps the room temperature in a specific range when the system is turned off (by the user, the schedule function, or the OFF timer). To achieve this, the system temporarily runs in Heating or Cooling operation mode, according to the setback setpoint and recovery differential.

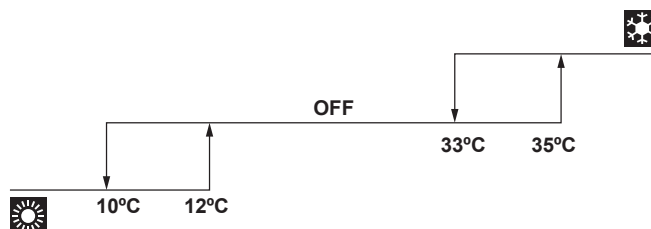
Example:



15 About the app

Settings		Result
Heating operation 	Setback setpoint	10°C
	Recovery differential	+2°C
Cooling operation 	Setback setpoint	35°C
	Recovery differential	-2°C

If the room temperature drops below 10°C, the system automatically starts heating operation. If after 30 minutes the temperature rises above 12°C, the system stops heating operation, and turns off again. When the room temperature drops below 10°C again, the process gets repeated.

If the room temperature rises above 35°C, the system automatically starts cooling operation. If after 30 minutes the temperature drops below 33°C, the system stops cooling operation, and turns off again. When the room temperature rises above 35°C again, the process gets repeated.

INFORMATION

- Setback is by default enabled.
- Setback turns on the system for at least 30 minutes, unless the setback setpoint is changed, or the system is turned on with the ON/OFF button.
- When Setback is active, you cannot make changes to fan speed settings.
- When Setback activates while the system is set to Auto operation mode, the system will switch to Cooling or Heating operation mode, depending on which is required. The Setback setpoint displayed on the operation screen is then according to the operation mode.

INFORMATION

This function cannot be used when the indoor units are controlled by a centralised controller.

INFORMATION

The default setpoint range limits for Setback operation are [33°C-37°C] for Cooling operation, and [10°C-15°C] for Heating operation. It is not possible to change these limits.

15.5.19 Individual airflow direction

Set the airflow direction of each individual indoor unit air outlet. The maximum number of indoor units for which you can make these settings depends on the type of system:

System	Maximum number of indoor units
Sky Air	4
VRV	16

Of cassette-type indoor units, it is possible to identify the individual air outlets by way of the following indicators:

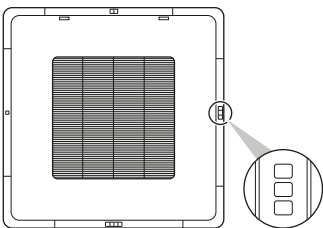

INFORMATION

The availability of this function depends on the type of indoor unit.

15.5.20 Setpoint range

Set a limitation to the temperature setpoint range of both Cooling and Heating operation.

INFORMATION

This function cannot be used when the indoor units are controlled by a centralised controller.

INFORMATION

The default setpoint range limits for both Heating and Cooling operation is [16°C-32°C], regardless of whether or not Setpoint range is enabled. It is not possible to exceed these limits.

15.5.21 Cooling/Heating masterhood

Set an indoor unit (or group of indoor units) as Cooling/Heating master. When multiple indoor units are connected to an outdoor unit, one of these units (or a group of indoor units, in case of group control) needs to be set as Cooling/Heating master. The other units/groups then become Cooling/Heating slaves, and are restricted in their operation by the master (e.g. one outdoor unit does not allow for one indoor unit to run in Cooling operation while another runs in Heating operation).



When an indoor unit or group of indoor units is set as Cooling/Heating master, the other units/groups automatically become its slaves. To turn a slave unit into the master, first connect the app to the controller controlling the currently active master and release it from its masterhood, then set the (slave) unit as master.

15.5.22 Airflow direction range

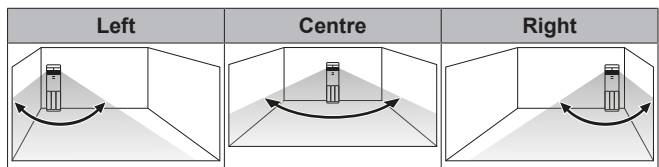
Set the indoor unit airflow direction range according to the installation location. This function is available for floorstanding indoor units only. The maximum number of indoor units for which you can make these settings is 16.



The ranges correspond with the following airflow swing patterns:

Left	Centre	Right
Left swing	Wide swing	Right swing
		

INFORMATION

The availability of this function depends on the type of indoor unit.

INFORMATION

For systems in which the indoor units run in simultaneous operation, it is possible to set the airflow direction range of individual indoor units by connecting the controller to each indoor unit separately.

15.5.23 Draught prevention

Prevent people from getting affected by indoor unit airflow, based on (the lack of) presence detected by a motion sensor.

INFORMATION

To use this function, it is required that the indoor units are equipped with a motion sensor (optional accessory).

INFORMATION

This function is not supported when the system contains Sky Air RR or RQ outdoor units.

15.5.24 Quick start

Activate Quick start to quickly bring the room to a comfortable temperature.

When Quick start is active, the outdoor unit operates with increased capacity. Indoor unit fan speed gets controlled automatically, making manual fan speed changes impossible.

After activation, Quick start is active up to 30 minutes. After 30 minutes, Quick start automatically deactivates, and the system resumes normal operation. Additionally, Quick start will deactivate from the moment you change the operation mode manually.

Quick start can ONLY be activated when the system is running in Cooling, Heating, or Auto operation mode.

INFORMATION

This function is only available for Sky Air indoor units.

INFORMATION

This function is not supported when the system contains Sky Air RR or RQ outdoor units.

15.5.25 External input interlock

External input interlock allows for the integration of external contacts in the system's control logic. By adding a key card contact and/or a window contact to the control setup, it is possible to have the system respond to the insertion/removal of a key card in/from a card reader, and/or the opening/closing of windows.

For more information, see ["About external input interlock" on page 23](#).

INFORMATION

To use this function, it is required that digital input adapter BRP7A5* is part of the system.

- Make sure that the digital input adapter and its optional contacts (window contact B1 and key card contact B2) are correctly installed. Confirm that the voltage free contact of the digital input adapter is in the correct position. For instructions on how to install the digital input adapter, see the installation manual of the digital input adapter.
- When the digital input adapter does not function properly, external input interlock is not available in the menu.
- When the digital input adapter is part of the system, the system does not allow for the connection of a slave controller.
- When the digital input adapter is part of the system, it is not possible to use the Schedule function.
- When the digital input adapter is part of the system, as well as a centralised controller, the external input interlock function is controlled by the centralised controller, and not by the adapter.

15.5.26 Defrost operation

Make the system run in defrost operation mode, this to prevent the loss of heating capacity due to frost accumulation in the outdoor unit.

INFORMATION

The system will return to normal operation after approximately 6 to 8 minutes.

15.5.27 Function lock

Make functions and operation modes unavailable by locking them. It is possible to lock the following functions and operation modes:

Remote controller	▪ Menu button 
Functions	<ul style="list-style-type: none"> ▪ Operation ON/OFF ▪ Setpoint changes ▪ Fan speed control ▪ Operation mode control ▪ Airflow direction control ▪ Ventilation rate control ▪ Ventilation mode control ▪ Setpoint range ▪ Setback ▪ Presence sensor – Setpoint adjustment ▪ Presence sensor – Auto OFF ▪ Schedule ▪ Filter auto clean ▪ Date and time ▪ Quiet mode ▪ Draught prevention
Operation modes	<ul style="list-style-type: none"> ▪ Automatic ▪ Cooling ▪ Heating ▪ Fan ▪ Dry ▪ Ventilation



INFORMATION

- When you lock an operation mode that is active at the moment of locking, that mode will still be active upon saving settings and leaving the menu. Only when you change the operation mode, that mode will not be available anymore.
- When you lock ALL operation modes, it will not be possible to switch to an operation mode other than the one that is active at the moment of locking.

Remote controller

Locking functions and operation modes from the app results in changes on the remote controller.

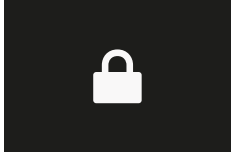
15 About the app

Operation	Remote controller
Home screen	<p>When you lock functions/buttons that are operated from the controller home screen, the controller will display a lock screen when you try to use these functions/buttons.</p> 
Main menu	<p>When you lock functions that are main menu items on the controller, these functions get crossed out in the main menu, and accompanied by a lock icon.</p>  <p>When locking operation modes, the controller simply omits them from the operation mode menu.</p>

15.5.28 Quiet mode

Set a timespan in which the outdoor unit operates more quietly.



INFORMATION

The availability of this function depends on the type of outdoor unit.

15.5.29 Errors and warnings

Consult the error history, and temporarily enable/disable the pushing of error and/or warning notifications.

The pushing of error and warning notifications is by default enabled. Disable "Display errors" and "Display warnings" to prevent the system from pushing error and warning notifications for 48 hours. After 48 hours, "Display errors" and "Display warnings" become automatically enabled again.

15.5.30 Unit number

Change the unit number of the indoor unit(s). To configure individual indoor units, these units require a unit number. The unit number of an indoor unit is its ranking in the list. To give a unit a new unit number, change its ranking by either moving it to an empty slot, or switching it with another indoor unit. If you need help identifying physical indoor units, tap an indoor unit's fan icon to make that indoor unit's fan operate.

15.5.31 Filter auto clean



INFORMATION

To use this function, it is required that the indoor units are equipped with a self-cleaning decoration panel (optional accessory).

Enable automatic indoor unit filter cleaning operation and set a timespan for it.

Reset dustbox maintenance timer

When it is time to empty the self-cleaning decoration panel's dustbox, the app displays a notification in the operation screen. Empty the dustbox and reset the notification.

15.5.32 Filter notifications

Reset notification

The app displays a filter notification in the operation screen when it is time to perform one of the following filter-related maintenance activities:

- Replace the filter of the indoor unit.
- Clean the filter of the indoor unit.
- Clean the element of the indoor unit.

Perform the required maintenance, then reset the notification.



INFORMATION

For more information on indoor unit maintenance, see the operation manual of the indoor unit.

Reset notification timer



INFORMATION

To use this function, it is required that you use the app in installer mode. For instructions on how to activate installer mode, see ["15.3 Installer mode" on page 28](#).

Filter maintenance due time is controlled by timers. The app sends out a maintenance notification each time a timer expires. It is possible to reset these timers.

15.5.33 AirNet address

Assign AirNet addresses to the indoor and outdoor units, this to connect the system to the AirNet monitoring and diagnostics system. First select a unit by way of its unit number, then assign it an AirNet address.

15.5.34 Group address

Assign addresses to the indoor units, this to control the system with central control equipment. You can assign an address to the group of indoor units connected to the controller, and to indoor units individually.

15.5.35 Field settings

Make indoor unit and remote controller field settings. For an overview of possible field settings, see ["Indoor unit field settings" on page 18](#) and ["Remote controller field settings" on page 19](#).

Setting procedure

Field settings are composed of the following components:

- Modes
- Units
- Settings
- Values

The field settings procedure differs depending on whether you are making settings for individual indoor units or for groups of indoor units, or for the remote controller.

Field settings type	Procedure
Individual indoor units	<ul style="list-style-type: none"> Set the field setting type to "Indoor unit". Define a mode. In the field settings table, find this number between brackets in the Mode column. Define the unit to which the setting will apply by setting a unit number. Define the setting by tapping the right tile in the app. In the field settings table, find settings in the SW column. Define a value for that setting.
Groups of indoor units	<ul style="list-style-type: none"> Set the field setting type to "Indoor unit". Define a mode. In the field settings table, find this number NOT between brackets in the Mode column. Do NOT set a unit number (the settings will apply to all units in the group). Define the setting by tapping the right tile in the app. In the field settings table, find settings in the SW column. Define a value for that setting.
Remote controller	<ul style="list-style-type: none"> Set the field setting type to "Remote controller". Define a mode. Define the setting by tapping the right tile in the app. In the field settings table, find settings in the SW column. Define a value for that setting.

Default values

Field setting default values are different depending on the indoor unit model. For more information, see the service manual of the indoor units. For the following field settings, the default values are the same for all indoor unit models:

Field setting	Default value
Thermostat sensor	02
Setback	04
Window contact B1	02
Key card contact B2	02
Airflow direction range	02
Remote controller thermostat sensor	02
Rotation overlap time	03

INFORMATION

- The connection of optional accessories to the indoor unit might cause changes to some field settings. For more information, see the installation manual of the optional accessory.
- For details about the specific field settings of each type of indoor unit, see the installation manual of the indoor units.
- Outdoor unit field settings can only be configured via the outdoor unit PCB. For more information, see the installation manual of the outdoor unit.
- Field settings that are not available for a connected indoor unit are not displayed.

15.5.36 Duty rotation

Activate Duty rotation to let the indoor units operate alternately (one indoor unit alternately inactive), this to increase system lifespan and reliability.

Duty rotation is designed for units operating in critical applications (e.g. in server rooms that require lots of cooling). In these cases, the system is equipped with an extra backup unit. Activating Duty rotation then allows for:

- Rotation:** because the system is equipped with more units than are required to provide the heating/cooling load, one of the units can remain inactive during normal operation. After a set time (i.e. "Rotation cycle time"), the inactive unit will start operation, and a previously active unit will become inactive (i.e. duty rotation). Because the units only operate alternately, the lifespan of the system increases.
- Backup:** having a backup unit allows for system redundancy. If an active unit goes into error, "Duty rotation" makes sure an inactive one takes over.

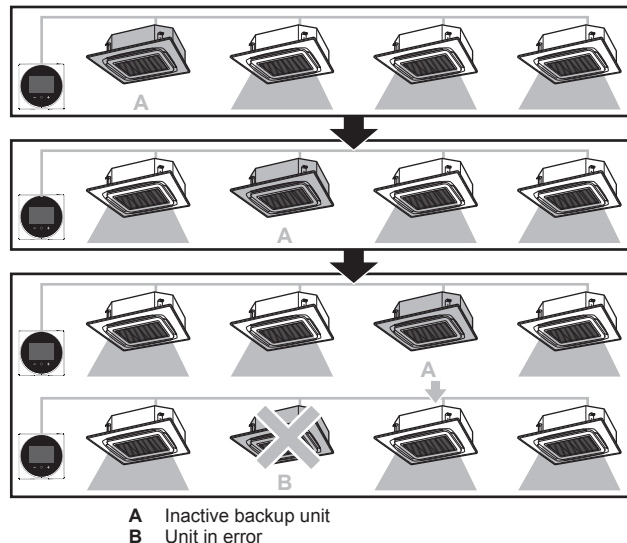

INFORMATION

This function can only be used when the indoor units are in group control.

INFORMATION

- To let the backup unit reach its cooling/heating capacity, an overlap period is included in which all indoor units are active. For more information, see ["Indoor unit field settings" on page 18](#) (cfr. field setting 1E-7).
- The rotation order depends on the set unit number. For instructions on how to change the indoor units' unit number, see ["15.5.30 Unit number" on page 34](#).

16 Maintenance

15.5.37 Test operation

Perform an indoor unit test operation. During the test run, the indoor units cycle through various operation modes and functions to check if they are ready for operation.

When

Only activate the test operation after the following is completed:

- Installation of refrigerant piping;
- Installation of drain piping;
- Connection of electrical wiring.

Typical workflow

Performing a test operation typically consists of the following stages:

- 1 Activating the test operation (Madoka Assistant app),
- 2 Testing the indoor unit functions according to the instructions set out in ["To perform a test operation" on page 36](#),
- 3 Deactivating the test operation (Madoka Assistant app),
- 4 Checking the error history for possible errors.
- 5 If applicable, fixing the causes of those errors.
- 6 Repeating the procedure if required.



INFORMATION

This function is only available for Sky Air indoor units.



INFORMATION

Also see the installation manual of the indoor unit and outdoor unit.

Precautions when performing a test operation



CAUTION

Before starting up the system, make sure:

- The indoor and outdoor unit wiring is completed.
- The switch box covers of the indoor and outdoor units are closed.



NOTICE

Be sure to turn on the power 6 hours before operation in order to have power running to the crankcase heater and to protect the compressor.



INFORMATION

After the installation of the refrigerant piping, drain piping, and electrical wiring, make sure to clean the inside of the indoor unit, as well as the decoration panel.

To perform a test operation

- 1 Confirm that the indoor unit gas and liquid stop valves are open.



INFORMATION

It is possible that the pressure inside the refrigerant circuit does not rise, despite the opened stop valve. This can be due to the expansion valve (or the like) blocking the refrigerant, and does not obstruct the test run.

- 2 Open the Madoka Assistant app.
- 3 Navigate to the operation screen of the controller that is connected to the indoor unit(s) on which you want to perform a test run.
- 4 In the operation screen, set the operation mode to Cooling.
- 5 Go to the "Unit settings" menu (upper right corner of the operation screen).

Result: You are in the "Unit settings" menu.

- 6 In the "Maintenance field", tap "Test operation".

Result: You are in the "Test operation" menu.

- 7 Tap "Start test operation".

Result: The indoor unit(s) enter test operation mode, during which normal operation is not possible.

- 8 Return to the operation screen.
- 9 Tap "Vertical airflow direction".
- 10 Tap "Fixed".
- 11 Cycle through the five fixed airflow directions, and confirm if the indoor unit flaps behave correspondingly.
- 12 Return to the "Test operation" menu.
- 13 Tap "Stop test operation".

Result: The indoor units leave test operation mode. Normal operation is possible again.

- 14 Go to ["6 Operation" on page 5](#) and confirm if the indoor unit(s) behave according to the information set out there.
- 15 Check the error history. If required, solve the cause of the errors and perform the test operation again.



INFORMATION

The test operation finishes after 30 minutes.

15.5.38 Unit status

With "Unit status", you can:

- **Read-only:** see information provided by various sensors that are present in the system. First select a unit by way of its unit number.
- **Information retrieval:** enter a code to make the system retrieve specific information about an indoor or outdoor unit component. First select a unit by way of its unit number, then enter the code to start the information retrieval.



INFORMATION

The **information retrieval** function is only present in the menu when you use the app in installer mode. For instructions on how to activate installer mode, see ["15.3 Installer mode" on page 28](#).

15.5.39 Operating hours

Monitor indoor and outdoor unit operating hours.

15.5.40 Contact information

Enter the phone number of the system's service contact.

16 Maintenance

16.1 Maintenance safety precautions



WARNING

Before carrying out any maintenance or repair activities, stop system operation with the controller, and turn off the power supply circuit breaker. **Possible consequence:** electric shock or injury.



NOTICE

To clean the controller, do NOT use organic solvents, such as paint thinner. **Possible consequence:** damage, electric shock, or fire.

**WARNING**

Do not wash the remote controller. **Possible consequence:** electric leakage, electric shock, or fire.



**INFORMATION**

When the dirt on the surface cannot be removed easily while cleaning the controller, soak the cloth in neutral detergent diluted with water, squeeze the cloth tightly, and clean the surface. Afterwards, wipe dry with a dry cloth.

16.2 About maintenance

When the indoor unit needs to be maintained, the controller will display  on the home screen, and confront you with a warning screen as soon as you try to enter the main menu. Perform the required maintenance, and then remove the warning screen.

The following warning screens are related to indoor unit maintenance:

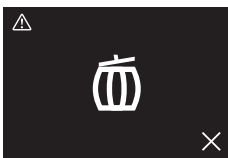
Time to clean filter 	Time to replace filter 
Time to empty dust collector 	—

16.3 To remove a warning screen

Prerequisite: The controller displays the home screen, and  is visible, indicating error or maintenance.

- 1 Press  to enter the main menu.

Result: Since  is visible, you are confronted with a warning screen, e.g.

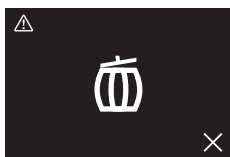

- 2 Solve the cause of the warning screen.
- 3 Press  to remove the warning screen.

Result: The controller returns to the home screen. If the cause of the warning was properly solved,  has disappeared.

16.4 To clean the controller

- 1 Wipe the screen and other surface parts of the controller with a dry cloth.

17 Troubleshooting

17.1 Error codes of the indoor unit

When the indoor unit is in error, the controller will display  on the home screen, and confront you with an error screen as soon as you try to enter the main menu:

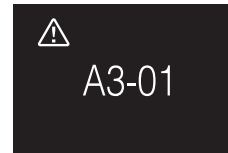

Solve the cause of the error, and press  to remove the error screen. For an overview of indoor unit error codes and what they mean, see the documentation of the indoor units.

18 Technical data

A **subset** of the latest technical data is available on the regional Daikin website (publicly accessible). The **full set** of latest technical data is available on the Daikin Business Portal (authentication required).

18.1 Connection diagram

18.1.1 Typical layout

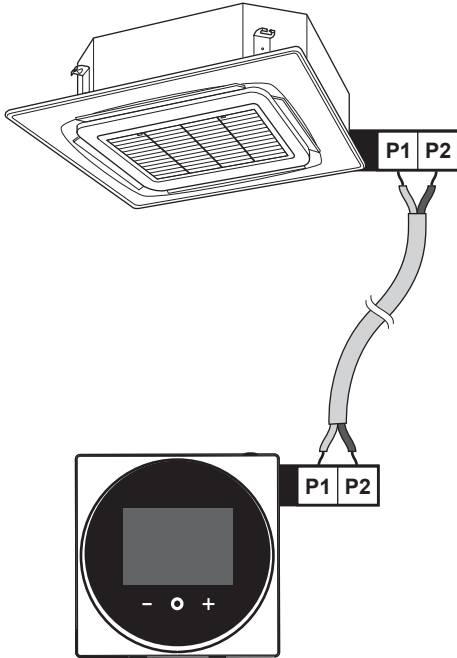

18.1.2 Typical layout for group control

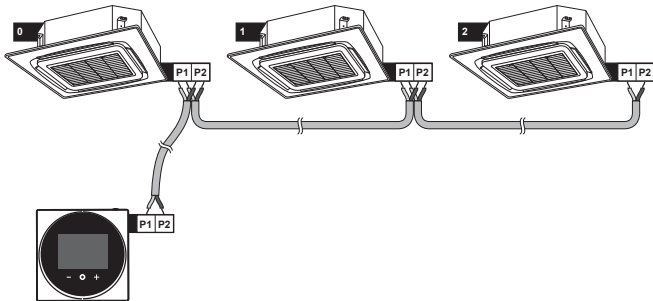

Group control: master and slave controller

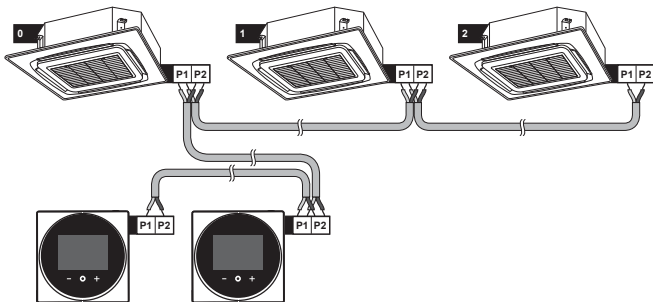

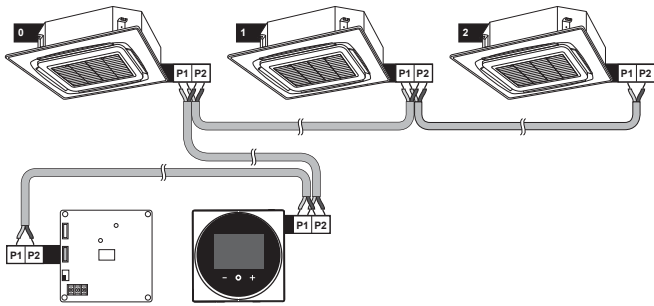
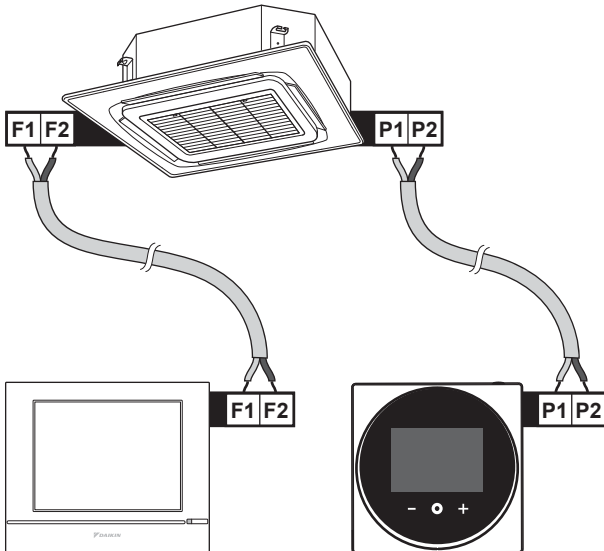
Group control: controller + digital inputs adapter BRP7A5**18.1.3 Controller + DIII central control equipment**



UA. TR. 028



I005 18

Numéro d'agrément: MR 15844 ANRT 2018
Date d'agrément: 16/02/2018

Maximum Voltage: DC 17.6 V
Power Consumption: Max 1.94 VA

OMAN - TRA
TRA-TA-R/5107/18
D100428

TRC/LPD/2018/60

Copyright 2018 Daikin

DAIKIN EUROPE N.V.

Zandvoordestraat 300, B-8400 Oostende, Belgium

4P513689-1C 2018.12