Wireless Remote Controller Kit

MODELS:

BRC7C512W
BRC7C513W

Thank you for purchasing this Daikin air conditioner. Carefully read this operation manual before using the air conditioner. It will tell you how to use the unit properly and help you if any trouble occurs. After reading the manual, file it away for future reference.

Vielen Dank für den Kauf einer Klimaanlage von Daikin. Lesen Sie dieses Betriebshandbuch vor Inbetriebnahme der Klimaanlage sorgfältig durch. Sie erfahren hier, wie die Einheit korrekt genutzt wird, und es ist Ihnen bei Störungen behilflich. Wenn Sie das Handbuch durchgelesen haben, bewahren Sie es gut auf, damit Sie auch später noch nachschlagen können.

Nous vous remercions pour votre acquisition de ce système de climatisation Daikin. Lisez attentivement ce manuel avant d'utiliser le climatiseur. Il vous expliquera comment vous servir correctement de l'appareil et vous guidera en cas de problème. Lorsque vous aurez lu le manuel, rangez-le afin de pouvoir vous y référer ultérieurement.

PRIOR TO USE

This operation manual is exclusively for instructions on how to use the wireless remote controller. Read also the operation manual attached to the indoor unit for safe usage of the system and maintenance.

VOR DER INBETRIEBNAHME

Diese Betriebsanleitung enthält ausschließlich Anweisungen über den Gebrauch der drahtlosen Fernbedienung. Über die sichere Anwendung und Wartung des Systems, lesen Sie auch die dem Innenaggregat beiliegende Bedienungsanleitung.

AVANT LA MISE EN SERVICE

Ce mode d'emploi ne concerne que les instructions d'utilisation de la télécommande sans câble. Lire également le mode d'emploi joint à l'unité intérieure pour une utilisation et un entretien du système en toute sécurité.

ENGLISH 5

DEUTSCH 18

FRANÇAIS 31

1

1-1

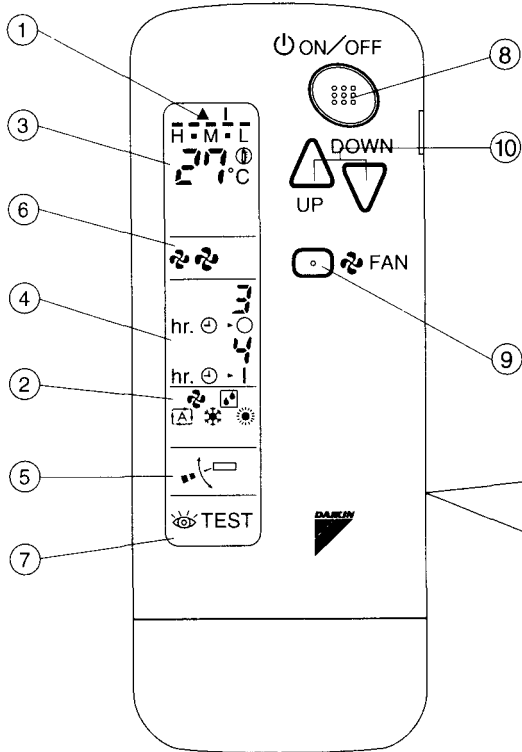

1-2

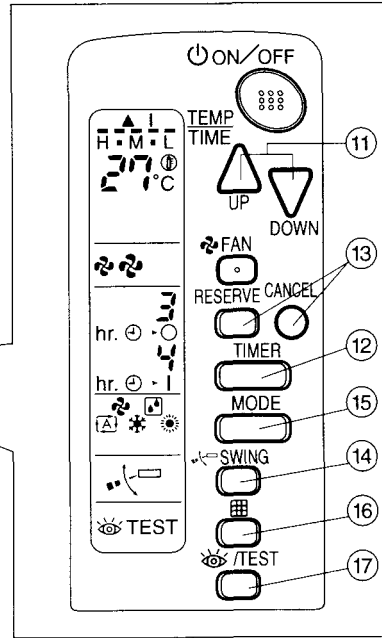

1-3

COOL/HEAT CHANGEOVER REMOTE CONTROL SWITCH

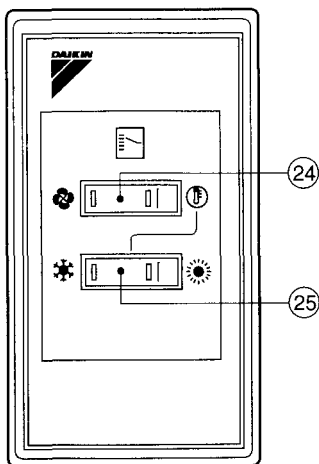

2

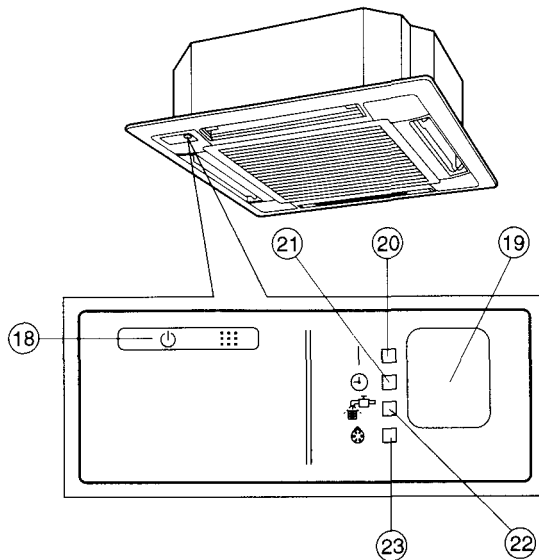

CONTENTS

PRIOR TO USE	1
SAFETY CONSIDERATIONS	6
NAMES AND FUNCTIONS OF THE OPERATING SECTION	8
HANDLING FOR WIRELESS REMOTE CONTROLLER	9
OPERATION PROCEDURE	10
NOT MALFUNCTION OF THE AIR CONDITIONER	15
HOW TO DIAGNOSE TROUBLE SPOTS	15
Fig. 1, 2	4
Fig. 3, 4	44
Fig. 5, 6, 7, 8, 9	45
Fig. 10	46

SAFETY CONSIDERATIONS

Read the following cautions carefully and use your equipment properly.

There are three kinds of safety cautions and tips listed here as follows:

- ⚠ WARNING** : Improper handling can lead to such serious consequences as death or severe injury.
- ⚠ CAUTION** : Improper handling can lead to injury or damage. It could also have serious consequences under certain conditions.
- NOTE** : These instructions will ensure proper use of the equipment.

Be sure to follow these important safety cautions.

Keep these warning sheets handy so that you can refer to them if needed.

Also, if this equipment is transferred to a new user, make sure to hand over this user's manual to the new user.

⚠ WARNING

- **Do not expose yourself directly to the cool air currents too long nor allow the air in the room to become too cold.**

Doing so may make you feel sick or damage your health.

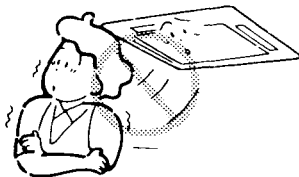

- **If you detect any abnormality (such as the smell of fire), turn off the power and contact your dealer for instructions.**

If you keep using the air conditioner under these conditions, it will eventually break down, and could cause electric shocks or catch fire.

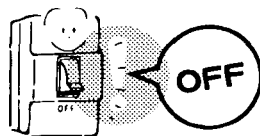

- **Ask your dealer to install your equipment.**

Improper installation could cause water leakage, electric shocks or fire.

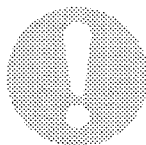

- **Ask your dealer to perform servicing or repairs whenever necessary.**

Improper servicing or repairs could cause water leakage, electric shocks or fire.

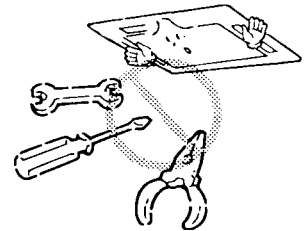

- **Do not stick your fingers or any other objects into the air inlet, air outlet or air direction vanes during operation.**

The high-speed fan is dangerous and could cause injury.

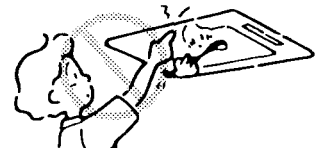

- **Ask your dealer to remove and reinstall your equipment whenever necessary.**

Improper installation could cause water leakage, electric shocks or fire.

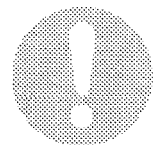

⚠ CAUTION

- **Do not use the air conditioner for purposes other than air conditioning.**

Do not use the air conditioner for special purposes such as preserving or protecting food, animals, plants, precision machinery or works of art, since the quality of such items could be adversely affected.

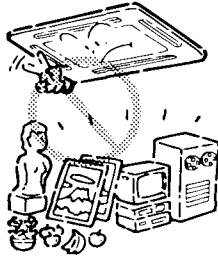

- **When using the air conditioner with other heating equipment, ventilate the room from time to time.**

Inadequate ventilation could cause an oxygen shortage.

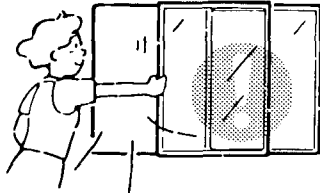

- **Do not expose your pets or plants to the air current.**

They may be adversely affected.

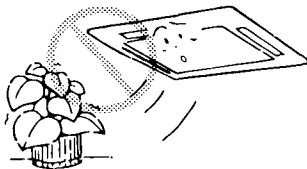

- **Do not operate the air conditioner with wet hands.**

Otherwise, you could receive an electric shock.



- **Do not place any burning appliance in the air current from the air conditioner, since such appliance may suffer incomplete combustion.**

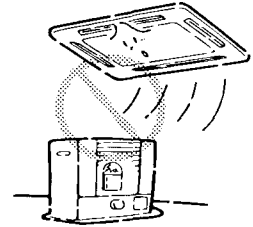

- **Never place nor use any inflammable sprays near the air conditioner, since such sprays could cause a fire.**

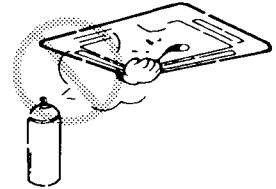

NAMES AND FUNCTIONS OF THE OPERATING SECTION (Fig. 1, 2)

①	DISPLAY “▲” (SIGNAL TRANSMISSION) This lights up when a signal is being transmitted.	⑭	AIR FLOW DIRECTION ADJUST BUTTON Refer to page 11.
②	DISPLAY “❄️” “🔥” “A” “🌞” “🌙” (OPERATION MODE) This display shows the current OPERATION MODE. For straight cooling type, “A” (Auto) and “🌙” (Heating) are not installed.	⑮	OPERATION MODE SELECTOR BUTTON Press this button to select OPERATION MODE.
③	DISPLAY “27.5°C” (SET TEMPERATURE) This display shows the set temperature.	⑯	FILTER SIGN RESET BUTTON Refer to the section of MAINTENANCE in the operation manual attached to the indoor unit.
④	DISPLAY “3 hr 4” (PROGRAMMED TIME) This display shows PROGRAMMED TIME of the system start or stop.	⑰	INSPECTION/TEST OPERATION BUTTON This button is used only by qualified service persons for maintenance purposes.
⑤	DISPLAY “🌬️” (AIR FLOW FLAP) Refer to page 12.	⑱	EMERGENCY OPERATION SWITCH This switch is readily used if the remote controller does not work.
⑥	DISPLAY “❄️” “🌬️” (FAN SPEED) The display shows the set fan speed.	⑲	RECEIVER This receives the signals from the remote controller.
⑦	DISPLAY “🔍 TEST” (INSPECTION/TEST OPERATION) When the INSPECTION/TEST OPERATION BUTTON is pressed, the display shows the system mode is in.	⑳	OPERATING INDICATOR LAMP (Red) This lamp stays lit while the air conditioner runs. It flashes when the unit is in trouble.
⑧	ON/OFF BUTTON Press the button and the system will start. Press the button again and the system will stop.	㉑	TIMER INDICATOR LAMP (Green) This lamp stays lit while the timer is set.
⑨	FAN SPEED CONTROL BUTTON Press this button to select the fan speed, HIGH or LOW, of your choice.	㉒	AIR FILTER CLEANING TIME INDICATOR LAMP (Red) Lights up when it is time to clean the air filter.
⑩	TEMPERATURE SETTING BUTTON Use this button for SETTING TEMPERATURE (Operates with the front cover of the remote controller closed.)	㉓	DEFROST LAMP (Orange) Lights up when the defrosting operation has started.
⑪	PROGRAMMING TIMER BUTTON Use this button for programming “START and/or STOP” time. (Operates with the front cover of the remote controller opened.)	㉔	FAN/AIR CONDITIONING SELECTOR SWITCH Set the switch to “❄️” (FAN) for FAN and “🌬️” (A/C) for HEAT or COOL.
⑫	TIMER MODE START/STOP BUTTON Refer to page 12.	㉕	COOL/HEAT CHANGEOVER SWITCH Set the switch to “🌙” (COOL) for COOL and “🌞” (HEAT) for HEAT.
⑬	TIMER RESERVE/CANCEL BUTTON Refer to page 13.	(NOTES) <ul style="list-style-type: none"> For the sake of explanation, all indications are shown on the display in Figure 1 contrary to actual running situations. Fig. 1-2 shows the remote controller with the front cover opened. Fig. 1-3 shows this remote controller can be used in conjunction with the one provided with the VRV system. If the air filter cleaning time indicator lamp lights up, clean the air filter as explained in the operation manual provided with the indoor unit. After cleaning and reinstalling the air filter, press the filter sign reset button on the remote controller. The air filter cleaning time indicator lamp on the receiver will go out. 	

HANDLING FOR WIRELESS REMOTE CONTROLLER

Precautions in handling remote controller

Direct the transmitting part of the remote controller to the receiving part of the air conditioner.

If something blocks the transmitting and receiving path of the indoor unit and the remote controller as curtains, it will not operate.

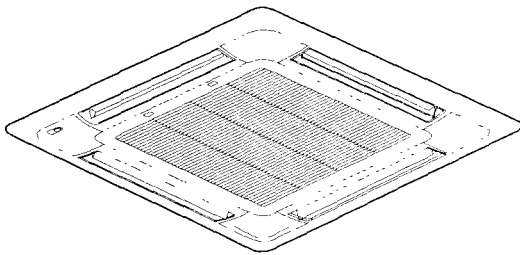

2 short beeps from the receiver indicates that the transmission is properly done.

Transmitting distance is approximately 7 m.

Do not drop or get it wet.
It may be damaged.

Never press the button of the remote controller with a hard, pointed object.

The remote controller may be damaged.

Installation site

- It is possible that signals will not be received in rooms that have electronic fluorescent lighting. Please consult with the salesman before buying new fluorescent lights.
- If the remote controller operated some other electrical apparatus, move that machine away or consult your dealer.

Placing the remote controller in the remote controller holder

Install the remote controller holder to a wall or a pillar with the attached screw. (Make sure it transmits)

Placing the remote controller

Slide from above

Removing the remote controller

Pull it upward

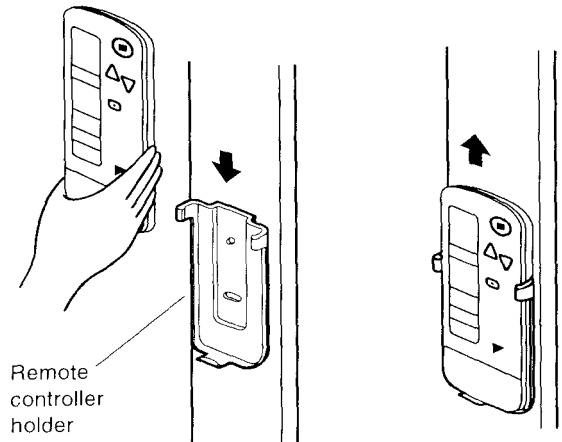

How to put the dry batteries

- ① Remove the back cover of the remote controller to the direction pointed by the arrow mark.
- ② Put the batteries
Use two LR03<IEC> dry cell batteries. Put dry batteries correctly to fit their (+) and (-).
- ③ Close the cover

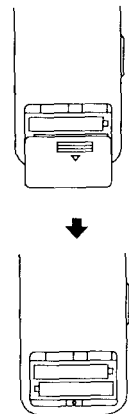

When to change batteries

Under normal use, batteries last about a year. However, change them whenever the indoor unit doesn't respond or responds slowly to commands, or if the display becomes dark.

CAUTIONS

- Replace all batteries at the same time, do not use new and old batteries intermixed.
- In case the remote controller is not used for a long time take out all batteries in order to prevent liquid leak of the battery.



OPERATION PROCEDURE

- Operating procedure varies with heat pump type and straight cooling type. Contact your Daikin dealer to confirm your system types.
- To protect the unit, turn on the main power switch 6 hours before operation.
- If the main power supply is turned off during operation, operation will restart automatically after the power turns back on again.

COOLING, HEATING AND FAN OPERATION (Fig. 3, 4)

■ **FOR SYSTEMS WITHOUT COOL/HEAT CHANGEOVER REMOTE CONTROL SWITCH (Fig. 3)**

1 Press **OPERATION MODE SELECTOR** button several times and select the **OPERATION MODE** of your choice as follows.



COOLING OPERATION "  "
 HEATING OPERATION "  "
 FAN OPERATION "  "

2 Press **ON/OFF** button

OPERATION lamp lights up and the system starts OPERATION.

■ **FOR SYSTEMS WITH COOL/HEAT CHANGEOVER REMOTE CONTROL SWITCH (Fig. 4)**

1 Select **OPERATION MODE** with the **COOL/HEAT CHANGEOVER REMOTE CONTROL SWITCH** as follows.

COOLING OPERATION.....Refer to fig. 4-1
 ( , )

HEATING OPERATION.....Refer to fig. 4-2

( , )

FAN OPERATION.....Refer to fig. 4-3 ()

2 Press **ON/OFF** button

OPERATION lamp lights up and the system starts OPERATION.

Adjustment

For programming TEMPERATURE and FAN SPEED and AIR FLOW DIRECTION, follow the procedure shown below.

3 Press **TEMPERATURE SETTING** button and program the setting temperature.



Each time this button is pressed, setting temperature rises 1°C.



Each time this button is pressed, setting temperature lowers 1°C.

Note:

- The setting is impossible for fan operation.

4 Press **FAN SPEED CONTROL** button.

High or Low fan speed can be selected.

5 Press **AIR FLOW DIRECTION** button

Refer to "ADJUSTING THE AIR FLOW DIRECTION" (p. 12) for details.

STOPPING THE SYSTEM

6 Press **ON/OFF** button once again.

OPERATION lamp goes off, and the system stops OPERATION.

Note:

- Do not turn OFF power immediately after the unit stops. Then, wait no less than 5 minutes. Water is leaking or there is something else wrong with the unit.

EXPLANATION OF HEATING OPERATION

DEFROST OPERATION

- As the frost on the coil of an outdoor unit increase, heating effect decreases and the system goes into DEFROST OPERATION.
- The fan operation stops and the DEFROST lamp of the indoor unit goes on.
After 6 to 8 minutes (maximum 10 minutes) of DEFROST OPERATION, the system returns to HEATING OPERATION.

Heating capacity & Outdoor air temperature

- Heating capacity drops as outdoor air temperature lowers. If feeling cold, use another heater at the same time as this air conditioner.
- Hot air is circulated to warm the room. It will take some time from when the air conditioner is first started until the entire room becomes warm. The internal fan automatically turns at low speed until the air conditioner reaches a certain temperature on the inside. In this situation, all you can do is wait.
- If hot air accumulates on the ceiling and feet are left feeling cold, it is recommended to use a circulator. For details, contact the place of purchase.

PROGRAM DRY OPERATION (Fig. 5, 6)

- The function of this program is to decrease the humidity in your room with the minimum temperature decrease.
- Micro computer automatically determines TEMPERATURE and FAN SPEED.
- This system does not go into operation if the room temperature is below 16°C.

■ FOR SYSTEMS WITHOUT COOL/HEAT CHANGEOVER REMOTE CONTROL SWITCH (Fig. 5)

- 1 Press OPERATION MODE SELECTOR button several times and select “” (PROGRAM DRY OPERATION)

- 2 Press ON/OFF button

OPERATION lamp lights up and system starts OPERATION.

Adjustment

- 3 Press AIR FLOW DIRECTION ADJUST button.

Refer to “ADJUSTING THE AIR FLOW DIRECTION” (p. 12) for details.

STOPPING THE SYSTEM

- 4 Press ON/OFF button again.

OPERATION lamp goes off and the system stops OPERATION.

■ FOR SYSTEMS WITH COOL/HEAT CHANGEOVER REMOTE CONTROL SWITCH (Fig. 6)

- 1 Select COOLING OPERATION MODE with the COOL/HEAT CHANGEOVER REMOTE CONTROL SWITCH.

- 2 Press OPERATION MODE SELECTOR button several times and select PROGRAM DRY “”.

- 3 Press ON/OFF button.

OPERATION lamp lights up and the system starts.

- 4 Press AIR FLOW DIRECTION ADJUST button.

Refer to “ADJUSTING THE AIR FLOW DIRECTION” (p. 12) for details.

STOPPING THE SYSTEM

5 Press ON/OFF button once again.

OPERATION lamp goes off, and the system stops OPERATION.

Note:

- Do not turn OFF power immediately after the unit stops. Then, wait no less than 5 minutes. Water is leaking or there is something else wrong with the unit.

ADJUSTING THE AIR FLOW DIRECTION (Fig. 7)

Press the AIR FLOW DIRECTION ADJUST button to adjust the air flow angle.

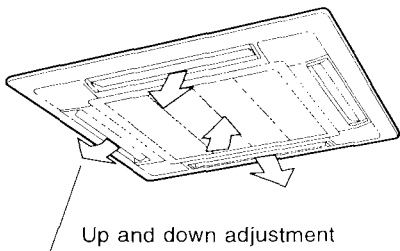

- The movable limit of the blade is changeable. Contact your Daikin dealer for details.

1 Press the AIR FLOW DIRECTION ADJUST button to select the air direction as shown below.

" " DISPLAY appears and the air flow direction continuously varies. (Automatic swing setting)



Press AIR FLOW DIRECTION ADJUST button to select the air direction of your choice.

" " DISPLAY vanishes and the desired air flow direction is fixed. (Fixed air flow setting)

MOVEMENT OF THE AIR FLOW FLAP

For the following conditions, micro computer controls the air flow direction so it may be different from the display.

Operation mode	Cooling	Heating
Operation conditions	<ul style="list-style-type: none"> • When room temperature is lower than the set temperature 	<ul style="list-style-type: none"> • When room temperature is higher than the set temperature • At defrost operation
	<ul style="list-style-type: none"> • When operating continuously at horizontal air flow direction 	

Operation mode includes automatic operation.

PROGRAM TIMER OPERATION (Fig. 8)

- The timer is operated in the following two ways. Programming the stop time (\oplus \circ). . . . The system stops operating after the set time has elapsed. Programming the start time (\oplus $|$). . . . The system starts operating after the set time has elapsed.
- The timer can be programmed a maximum of 72 hours.
- The start and the stop time can be simultaneously programmed.

1 Press the TIMER MODE START/STOP button several times and select the mode on the display.

The display flashes.

For setting the timer stop (\oplus \circ)

For setting the timer start (\oplus $|$)

2 Press the PROGRAMMING TIMER button and set the time for stopping or starting the system.



When this button is pressed, the time advances by 1 hour.



When this button is pressed, the time goes backward by 1 hour.

3 Press RESERVE button.

The timer setting procedure ends.

The display changes from flashing light to a constant light.

NOTE

- When setting the timer Off and On at the same time, repeat the above procedure from 1 to 3 once again.

For example.

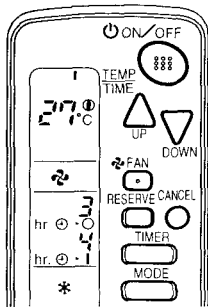

When the timer is programmed to stop the system after 3 hours and start the system after 4 hours, the system will stop after 3 hours and then 1 hour later the system will start.

- After the timer is programmed, the display shows the remaining time.
- Press the TIMER OFF button to cancel programming. The display vanishes. (4)

HOW TO SET MASTER REMOTE CONTROLLER (For VRV series)

- When the system is installed as shown below, it is necessary to designate the master remote controller.

■ For Heat pump system

When one outdoor unit is connected with several indoor units.

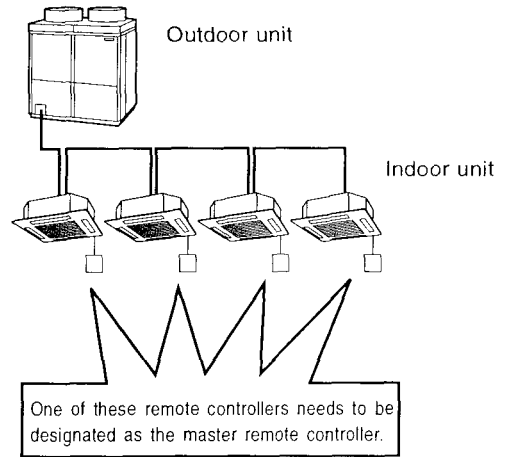

- Only the master remote controller can select HEATING, COOLING OPERATION.
- When the indoor unit with master remote controller is set to "COOL", you can switch over operation mode between "FAN", "DRY" and "COOL".
- When the indoor unit with master remote controller is set to "HEAT", you can switch over operation mode between "FAN" and "HEAT".
- When the indoor unit with master remote controller is set to "FAN", you cannot switch operation mode.
- When attempting settings than that consented above, a "peep" is emitted as a warning.
- If you can set the indoor unit to AUTOMATIC, a "peep" will be emitted as a warning.

How to designate the master remote controller

1 Continuously press the **OPERATION MODE SELECTOR button for 4 seconds.**

The displays showing “” of all slave indoor unit connected to the same outdoor unit flash.

2 Press the **OPERATION MODE SELECTOR button to the indoor unit that you wish to designate as the master remote controller. Then designation is completed. This indoor unit is designated as the master remote controller and the display showing “” vanishes.**

- To change settings, repeat steps **1** and **2**.

EMERGENCY OPERATION (Fig. 10)

When the remote controller does not work due to dead batteries or it is missing, use this switch which is located beside the discharge grille on the main unit. When the remote controller does not work, but the battery low indicator on it is not lit, contact your dealer.

START

1 Press the **EMERGENCY OPERATION switch.**

The machine runs in the previous mode.
The system operates with the previously set air flow direction.

STOP

2 Press the **EMERGENCY OPERATION switch again.**

PRECAUTIONS FOR GROUP CONTROL SYSTEM OR TWO REMOTE CONTROLLER CONTROL SYSTEM

This system provides two other control systems beside individual control (one remote controller controls one indoor unit) system. Confirm the following if your unit is of the following control system type.

■ **Group control system**

One remote controller controls up to 16 indoor units.
All indoor units are equally set.

■ **Two remote controller control system**

Two remote controllers control one indoor unit. (In case of group control system, one group of indoor units)
The unit follows individual operation.

NOTE:

- Cannot have two remote controller control system with only wireless remote controllers. (It will be a two remote controller control system having one wired and one wireless remote controllers.)
- Under two remote controller control system, wireless remote controller cannot control timer operation.
- Only the operating indicator lamp out of 3 other lamps on the indoor unit display functions.

NOTE:

Contact your Daikin dealer in case of changing the combination or setting of group control and two remote controller control systems.

NOT MALFUNCTION OF THE AIR CONDITIONER

The following symptoms do not indicate air conditioner malfunction

I. THE SYSTEM DOES NOT OPERATE

- The system does not restart immediately after the ON/OFF button is pressed.

If the OPERATION lamp lights, the system is in normal condition. It does not restart immediately because a safety device operates to prevent overload of the system. After 3 minutes, the system will turn on again automatically.

- The system does not restart immediately when TEMPERATURE SETTING button is returned to the former position after pushing the button.

It does not restart immediately because a safety device operates to prevent overload of the system. After 3 minutes, the system will turn on again automatically.

- If the reception beep is rapidly repeated 3 times (It sounds only twice when operating normally.)

Control is set to the optional controller for centralized control.

- If the defrost lamp on the indoor unit's display is lit when heating is started.

This indication is to warn against cold air being blown from the unit. There is nothing wrong with the equipment.

HOW TO DIAGNOSE TROUBLE SPOTS (Fig. 9)

I. EMERGENCY STOP

When the air conditioner stops in emergency, the run lamp on the indoor unit starts blinking. Take the following steps yourself to read the malfunction code that appears on the display. Contact your dealer with this code. It will help pinpoint the cause of the trouble, speeding up the repair.

- 1 Press the INSPECTION/TEST button to select the inspection mode "□".

"□" appears on display and blinks. "UNIT" lights up.

- 2 Press PROGRAMMING TIMER BUTTON and change the unit number.

Press to change the unit number until the indoor unit beeps and perform the following operation according to the number of beeps.

Number of beeps

3 short beeps Perform all steps from 3 to 6.

1 short beep Perform 3 and 6 steps

1 long beep Normal state

- 3 Press OPERATION MODE SELECTOR BUTTON

"□" on the left-hand of the malfunction code blinks.

- 4 Press PROGRAMMING TIMER BUTTON and change the malfunction code.

Press until the indoor unit beeps twice.

5 Press OPERATION MODE SELECTOR BUTTON

"1" on the right-hand of the malfunction code blinks.

6 Press PROGRAMMING TIMER BUTTON and change the malfunction code.

Press until the indoor unit makes a long beep.
The malfunction code is fixed when the indoor unit makes a long beep.

7 Reset of the display

Press OPERATION MODE SELECTOR BUTTON to get the display back to the normal state.

II. IN CASE BESIDES EMERGENCY STOP

1. The unit does not operate at all.

- Check if the receiver is exposed of sunlight or strong light. Keep receiver away from light.
- Check if there are batteries in the remote controller. Place the batteries.
- Check if the indoor unit number and wireless remote controller number are equal.

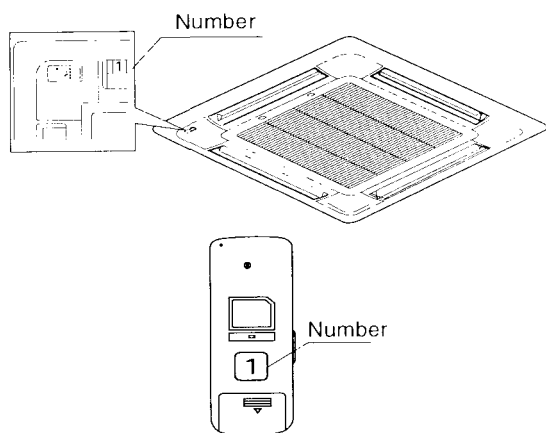

Operate the indoor unit with the remote controller of the same number.

Signal transmitted from a remote controller of a different number cannot be accepted. (If the number is not mentioned, it is considered as "1")

2. The system operates but it does not sufficiently cool or heat.

- If the set temperature is not proper.
- If the FAN SPEED is set to LOW SPEED.
- If the air flow angle is not proper.

Contact the place of purchase in the following case.

WARNING

- When you detect a burning odor, shut OFF power immediately and contact the place of purchase. Using the equipment in anything but proper working condition can result in equipment damage, electric shock and/or fire.

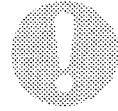

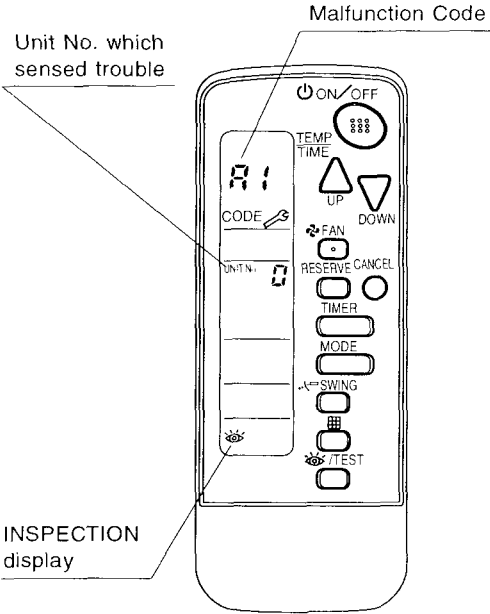
Trouble	Remedial action
<p>The RUN lamp of the indoor unit is flashing and the unit does not work at all.</p> <p>Unit No. which sensed trouble</p> <p>Malfunction Code</p>  <p>INSPECTION display</p>	<p>Check the malfunction code (A1 ~ UF) on the remote control and contact the place of purchase. (See page 15.)</p>

3

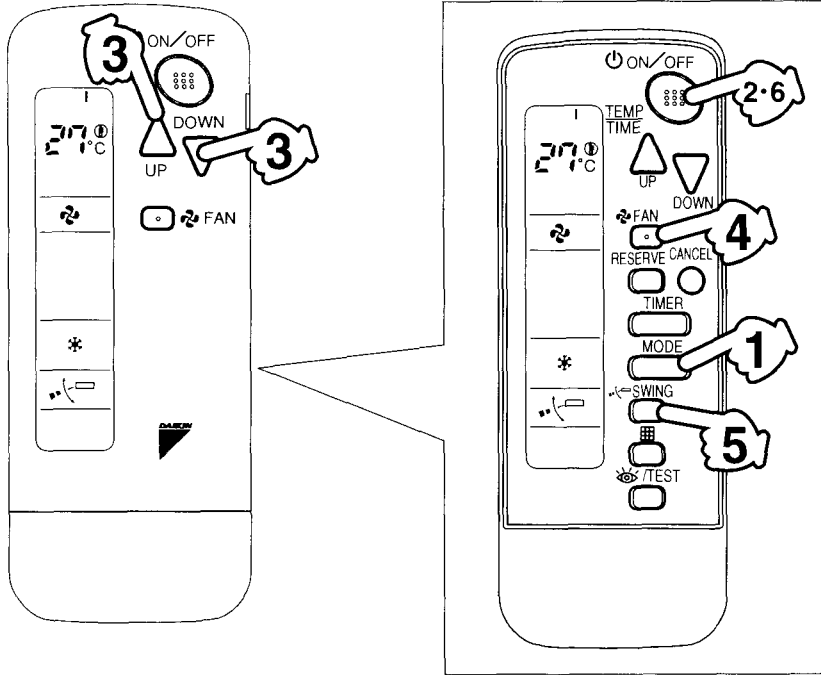

4

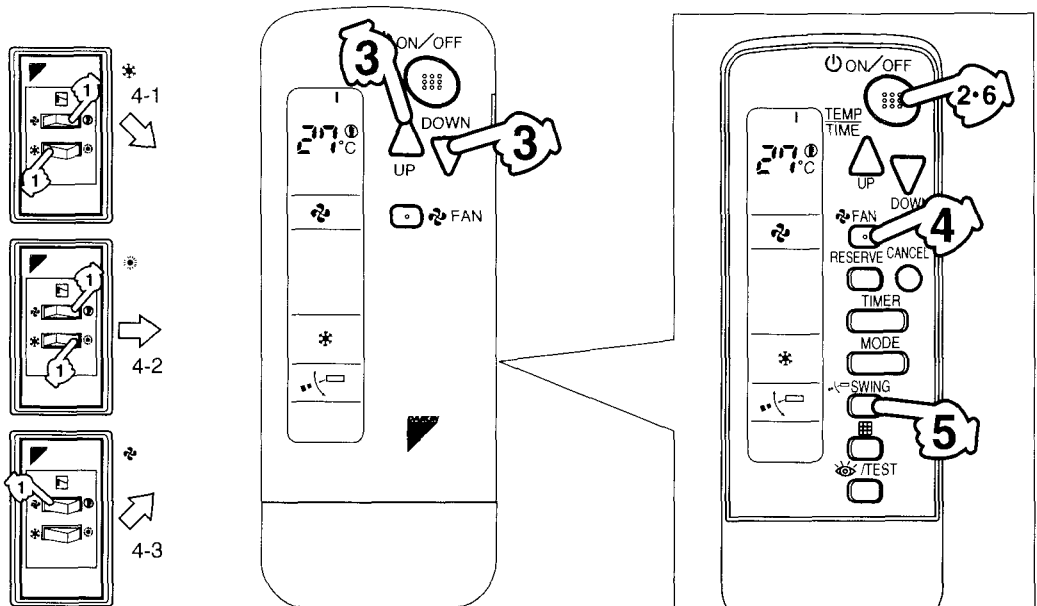

5

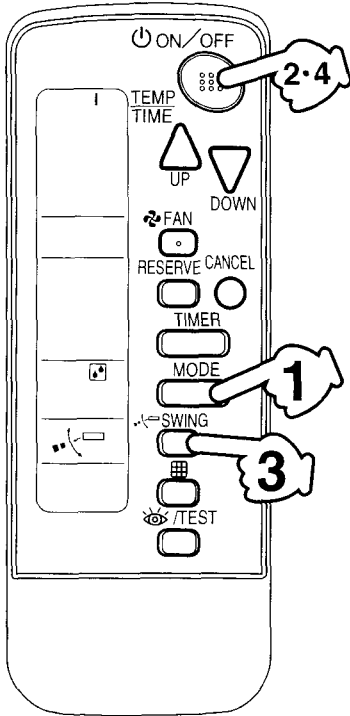

6

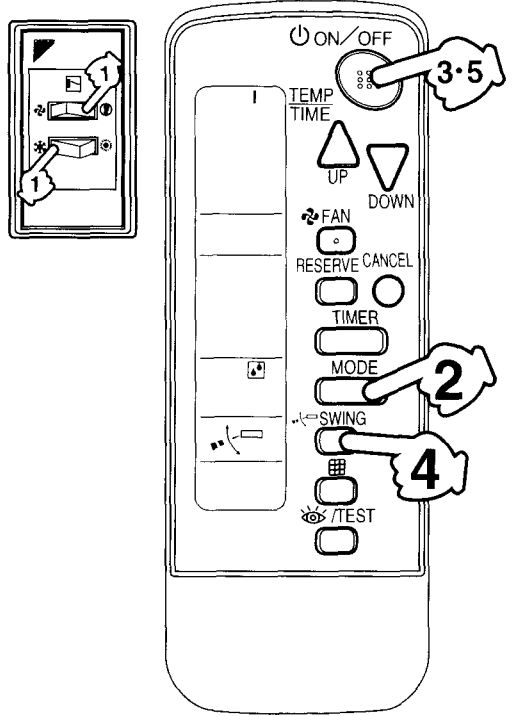

7

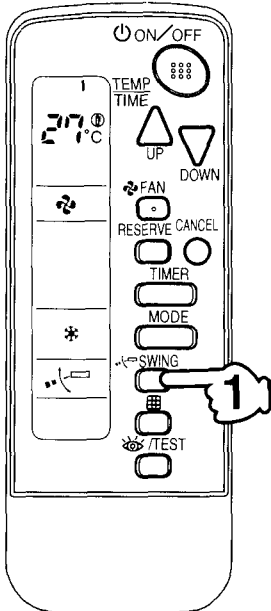

8

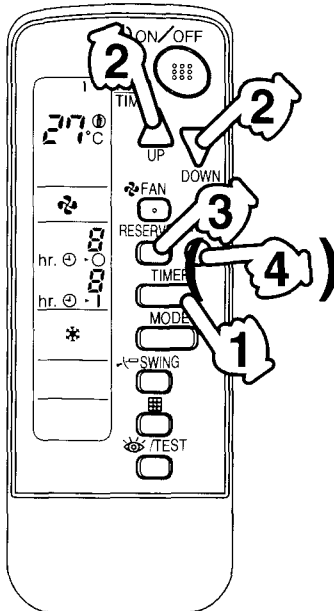

9

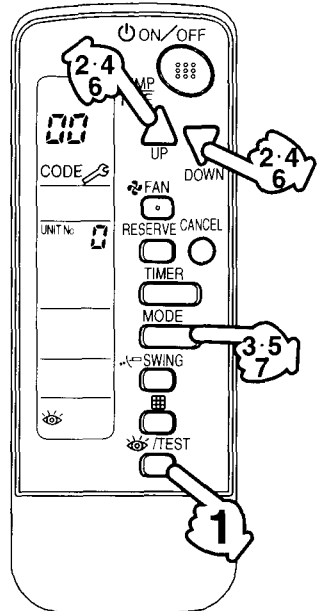

10

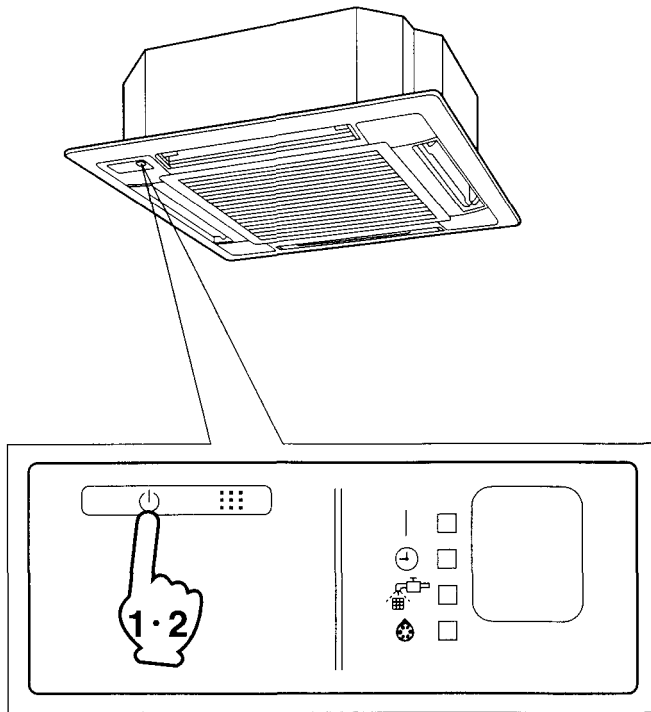

DAIKIN INDUSTRIES, LTD.

Head office:

Umeda Center Bldg., 4-12, Nakazaki-Nishi 2 chome,
Kita-ku, Osaka, 530-8323 Japan

Tokyo office:

Shinjuku Sumitomo Bldg., 6-1 Nishi-Shinjuku
2-chome, Shinjuku-ku, Tokyo, 163-0290 Japan

DAIKIN EUROPE NV

Zandvoordestraat 300, B-8400 Oostende, Belgium