

---

## Wireless Remote Controller Kit

---

### MODELS

**BRC7C528W**

**BRC7C529W**

---

**READ THESE INSTRUCTIONS CAREFULLY BEFORE INSTALLATION.  
KEEP THIS MANUAL IN A HANDY PLACE FOR FUTURE REFERENCE.**

**LESEN SIE DIESE ANWEISUNGEN VOR DER INSTALLATION SORGFÄLTIG  
DURCH.  
BEWAHREN SIE DIESE ANLEITUNG FÜR SPÄTERE BEZUGNAHME  
GRIFFBEREIT AUF.**

**LIRE SOIGNEUSEMENT CES INSTRUCTIONS AVANT L'INSTALLATION.  
CONSERVER CE MANUEL A PORTEE DE MAIN POUR REFERENCE  
ULTERIEURE.**

**LEA CUIDADOSAMENTE ESTAS INSTRUCCIONES ANTES DE INSTALAR.  
GUARDE ESTE MANUAL EN UN LUGAR A MANO PARA LEER EN CASO DE  
TENER ALGUNA DUDA.**

**PRIMA DI PROCEDERE ALL'INSTALLAZIONE, LEGGERE ATTENTAMENTE  
QUESTE ISTRUZIONI.  
CONSERVARE QUESTO MANUALE A PORTATA DI MANO PER FUTURE  
CONSULTAZIONI.**

**ΔΙΑΒΑΣΤΕ ΑΥΤΕΣ ΤΙΣ ΟΔΗΓΙΕΣ ΠΡΟΣΕΚΤΙΚΑ ΠΡΙΝ ΑΠΟ ΤΗΝ ΕΓΚΑΤΑΣΤΑΣΗ  
ΕΧΕΤΕ ΑΥΤΟ ΤΟ ΕΓΧΕΙΡΙΔΙΟ ΕΥΚΑΙΡΟ ΓΙΑ ΝΑ ΤΟ ΣΥΜΒΟΥΛΕΥΕΣΤΕ ΣΤΟ  
ΜΕΛΛΟΝ.**

**LEES DEZE INSTRUCTIES ZORGVULDIG VOOR INSTALLATIE.  
BEWAAR DEZE HANDLEIDING WAAR U HEM KAN TERUGVINDEN VOOR  
LATERE NASLAG.**

**LEIA COM ATENÇÃO ESTAS INSTRUÇÕES ANTES DE REALIZAR A  
INSTALAÇÃO.  
MANTENHA ESTE MANUAL AO SEU ALCANCE PARA FUTURAS CONSULTAS.**

**LÆS DISSE INSTRUKTIONER OMHYGGELIGT FØR INSTALLATION.  
OPBEVAR DENNE MANUAL PÅ ET TILGÆNGELIGT STED FOR FREMTIDIGE  
REFERENCER.**

**يرجى قراءة هذا الكتيب بانتباه قبل التركيب.  
احتفظ بهذا الكتيب في متناول اليد للاطلاع عليه في المستقبل.**

在安裝之前，請認真閱讀本安裝手冊。  
妥善將本手冊保管於易取之處，以備今後參照。

---

<b>CONTENTS</b>	<b>En.</b>
SAFETY CONSIDERATIONS .....	1
BEFORE INSTALLATION .....	1
REMOTE CONTROLLER INSTALLATION .....	2
RECEIVER INSTALLATION .....	2
FIELD SETTING .....	5
TEST OPERATION .....	6

<b>INHALTSVERZEICHNIS</b>	<b>Ge.</b>
SICHERHEITSHINWEISE .....	7
VOR DER INSTALLATION .....	7
INSTALLATION DER FERNBEDIENUNG .....	8
INSTALLATION DES EMPFÄNGERS .....	8
ORTS-EINSTELLUNG .....	11
TESTBETRIEB .....	12

<b>TABLE DES MATIERES</b>	<b>Fr.</b>
CONSIDERATIONS DE SECURITE .....	13
AVANT L'INSTALLATION .....	13
INSTALLATION DE LA TELECOMMANDE .....	14
INSTALLATION DU RECEPTEUR .....	14
REGLAGE LOCAUX .....	17
ESSAI DE FONCTIONNEMENT .....	18

<b>INDICE</b>	<b>Sp.</b>
CUIDADOS PARA SU SEGURIDAD .....	19
ANTES DE INSTALAR .....	19
INSTALACION DEL CONTROL REMOTO .....	20
INSTALACION DEL RECEPTOR .....	20
AJUSTE LOCAL .....	23
FUNCIONAMIENTO DE PRUEBA .....	24

<b>INDICE</b>	<b>It.</b>
CONSIDERAZIONI PER LA SICUREZZA .....	25
PRIMA DELL'INSTALLAZIONE .....	25
INSTALLAZIONE DEL TELECOMANDO .....	26
INSTALLAZIONE DEL RICEVITORE .....	26
IMPOSTAZIONE SEL SISTEMA IN BASE AL POSTO DI INSTALLAZIONE .....	29
FUNCIONAMENTO DI PROVA .....	30

<b>ΠΕΡΙΕΧΟΜΕΝΑ</b>	<b>Gr.</b>
ΠΡΟΤΑΣΕΙΣ ΑΣΦΑΛΕΙΑΣ .....	31
ΠΡΙΝ ΑΠΟ ΤΗΝ ΕΓΚΑΤΑΣΤΑΣΗ .....	31
ΕΓΚΑΤΑΣΤΑΣΗ ΤΗΛΕΧΕΙΡΙΣΤΗΡΙΟΥ .....	32
ΕΓΚΑΤΑΣΤΑΣΗ ΤΟΥ ΔΕΚΤΗ .....	32
ΡΥΘΜΙΣΗ ΣΤΗ ΘΕΣΗ ΕΓΚΑΤΑΣΤΑΣΗΣ .....	35
ΔΟΚΙΜΑΣΤΙΚΗ ΛΕΙΤΟΥΡΓΙΑ .....	36

<b>INHOUD</b>	<b>Ne.</b>
VEILIGHEIDSOVERWEGINGEN .....	37
VOOR INSTALLATIE .....	37
INSTALLATIE VAN DE AFSTANDBEDIENING .....	38
INSTALLATIE VAN DE ONTVANGER .....	38
HET VELD INSTELLEN .....	41
WERKINGSTEST .....	42

<b>ÍNDICE</b>	<b>Po.</b>
CONSIDERAÇÕES SOBRE SEGURANÇA .....	43
ANTES DA INSTALAÇÃO .....	43
INSTALAÇÃO DO CONTROLE REMOTO .....	44
INSTALAÇÃO DO RECEPTOR .....	44
AJUSTE DE CAMPO .....	47
FUNCIONAMENTO DE TESTE .....	48

<b>INDHOLD</b>	<b>Da.</b>
SIKKERHEDSREGLER .....	49
INDEN INSTALLATION .....	49
KLARGØRING AF DEN TRÅDLØSE FJERNBETJENING .....	50
KLARGØRING AF MODTAGER .....	50
INDSTILLING AF FUNKTIONEN FIELD .....	53
AFPRØVNING .....	54

<b>المحتويات</b>	<b>Ar.</b>
اعتبارات الامان .....	55
قبل التركيب .....	55
تركيب جهاز التحكم عن بعد .....	56
تركيب جهاز الاستقبال .....	56
الضبط فى موقع التركيب .....	59
التشغيل التجريبي .....	60

<b>目錄</b>	<b>Ch.</b>
安全注意事項 .....	61
安裝之前 .....	61
遙控器的安 .....	62
接收器的安裝 .....	62
現場設定 .....	65
試運轉 .....	66

# SAFETY CONSIDERATIONS

Please read this "SAFETY CONSIDERATIONS" carefully before installing air conditioning equipment and be sure to install it correctly. After completing the installation, make sure at start up operation that the unit operates properly. Please instruct the customer how to operate the unit and keep maintenance.

Meaning of caution symbols

**⚠ CAUTION**..... If the caution is not observed, it may cause injury or damage to equipment.

**NOTE** ..... These instructions will ensure proper use of the equipment.

## ⚠ CAUTION









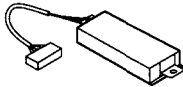
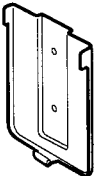

- Refer also to the installation manual attached to the indoor unit.
- Confirm that following conditions are satisfied prior to installation.
  - \* Ensure that nothing interrupts the operation of the wireless remote controller. (Ensure that there is neither a source of light nor fluorescent lamp near the receiver. Also, ensure that the receiver is not exposed of direct sun light.)
  - \* Ensure that the operaiton display lamp and other indicators are easy to see.

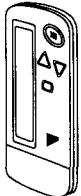
# BEFORE INSTALLATION

- Install the wireless remote controller in the indoor unit before hanging the unit from the ceiling.
- When using the wireless remote controller, the air intake grille must be attached in a specific direction. Check which way the grille will open before selecting a location for the indoor unit.

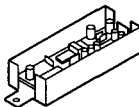
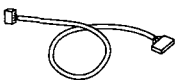
## ACCESSORIES

Check if the following accessories are included with your unit.

Name	Shape	Quantity	Name	Shape	Quantity	Name	Shape	Quantity
Receiver		1 set	Remote controller holder		1 pc.	Drycell battery LR03 (AM4)		2 pcs.
Wireless remote controller		1 pc.				Screw for installing remote control holder		2 pcs.
			Faceplate for receiver		1 pc.	Tapping screw		4 pcs.
Transmitter board		1 pc.	Relay harness		1 pc.	Cable clamp		2 pcs.
			Unit No. label		1 pc.	Operation manual		1 pc.

## NOTE TO THE INSTALLER

Be sure to instruct the customer how to properly operate the system showing him/her the attached operation manual.

# REMOTE CONTROLLER INSTALLATION

## < Installing wireless remote controller >

- Do not throw the remote controller or impose large shocks. Also, do not store where it may be exposed to moisture or direct sunlight.
- When operating, point the transmitting part of the remote controller in the direction of the receiver.
- The direct transmitting distance of the remote controller is approximately 7 meters.
- The signal cannot be transmitted if something such as curtains blocks the receiver and the remote controller.

### • Installing to a wall or a pillar

Slide the remote controller into the remote controller holder from the top.

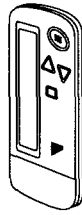

Fix the remote controller holder with the screws.

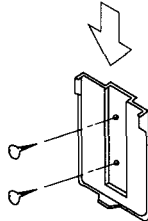

### • How to insert the batteries

① Open the back cover of the remote controller by sliding it in the direction of the arrow.

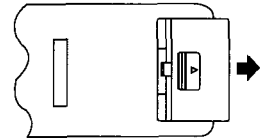

② Insert the attached dry cell batteries. Properly insert, set the batteries by matching the (+) and (-) polarity marks as indicated. Then close the cover as before.

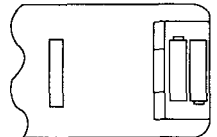

# RECEIVER INSTALLATION

## (1) Attaching the receiver faceplate

- Remove the installation drawing from the indoor unit. The drawing is glued down and can be peeled off.
- Attach the included receiver faceplate so that it fits the receiver frame.

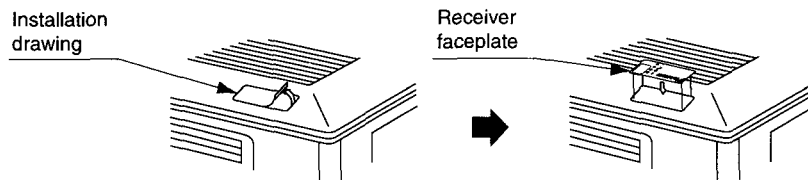

## (2) Determination of address and MAIN/SUB remote controller.

If setting multiple wireless remote controllers to operate in one room, perform address setting for the receiver and the wireless remote controller.  
If setting multiple wired remote controllers in one room, change the MAIN/SUB switch of the receiver.

## SETTING PROCEDURE

### ① Setting the receiver

Through the small opening on the back of the receiver, set the wireless address switch (SS2) on the printed circuit board according to the table below.

Unit No.	No. 1	No. 2	No. 3
Wireless address switch (SS2)	1 2 3	1 2 3	1 2 3



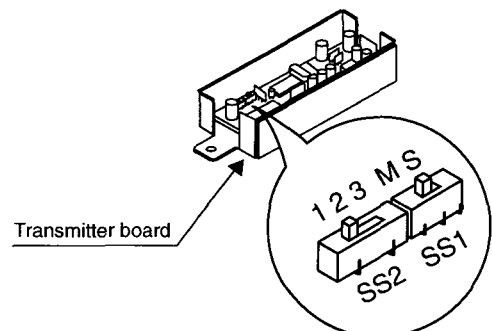

When using both a wired and a wireless remote controller for 1 indoor unit, the wired controller should be set to MAIN. Therefore, set the MAIN/SUB switch (SS1) of the receiver to SUB.

	MAIN	SUB
MAIN/SUB switch (SS1)	S M	S M

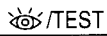

② **Setting the address of wireless remote controller (It is factory set to "1")**

〈 Setting from the remote controller 〉

- ① Hold down the  button and the  button for at least 4 seconds to get the Field Set mode. (Indicated in the display area in the figure at right).
- ② Press the  button and select a multiple setting (A/b). Each time the button is pressed the display switches between "A" and "b".
- ③ Press the " " button and " " button to set the address.

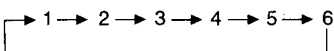

Address can be set from 1 to 6, but set it to 1 ~ 3 and to same address as the receiver. (The receiver does not work with address 4 ~ 6.)

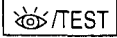
- ④ Press the  button to enter the setting.
- ⑤ Hold down the  button for at least 1 second to quit the Field Set mode and return to the normal display.

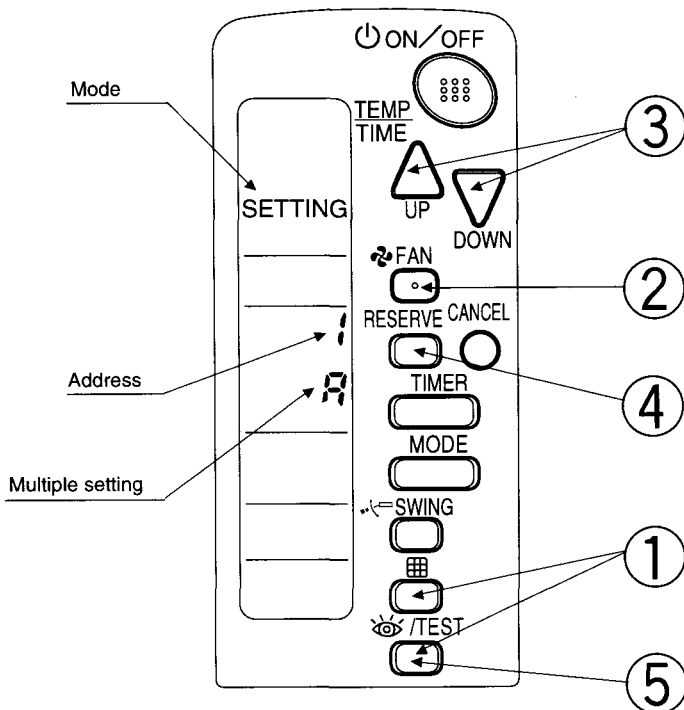

〈 **Multiple settings A/b** 〉

When the indoor unit is being operating by outside control (central remote controller, etc.), it sometimes does not respond to ON/OFF and temperature setting commands from this remote controller. Check what setting the customer wants and make the multiple setting as shown below.

Remote controller		Indoor unit	
Multiple setting	Remote controller display	To control other air conditions and units	For other than on left
A: Standard	All items displayed.	Commands other than ON/OFF and temperature setting accepted. (1 LONG BEEP or 3 SHORT BEEPS emitted)	
b: Multi System	Operations remain displayed shortly after execution.	All commands accepted (2 SHORT BEEPS)	

- ③ Stick the Unit No. label to the indoor unit and the back of the wireless remote controller.

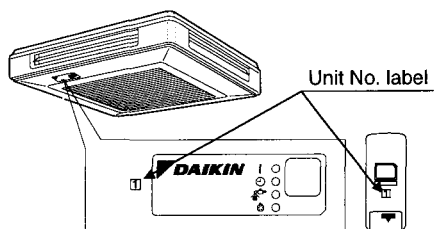

**PRECAUTIONS**

Set the Unit No. of the receiver and the wireless remote controller to be equal. If the settings differs, the signal from the remote controller cannot be transmitted.

### (3) PC BOARD INSTALLATION

- Detach the air intake grille and switch box lid (screws x 2) as explained in the installation instructions of the indoor unit.

- Install the transmitter board and receiver in the locations indicated at right.

**Note:** When using the wireless remote controller, the indoor unit must be opened/closed in the direction shown at right.

- ① Connect the relay harness from the receiver to connector X1A on the transmitter board and the relay harness included in this kit to connector X2A on the transmitter board. After making the connections, attach the cover as before.
- ② Install the transmitter board in the indoor unit. (Screws x 2)
- ③ Install the receiver in the indoor unit. (Screws x 2)  
When doing so, feed the swing motor lead, limit switch lead and relay harness under the receiver.
- ④ Bundle the two harnesses together with the included cable clamps in the two locations shown at right.
- ⑤ Connect the relay harness from the transmitter board to connector X24A on the PC board in the switch box.
- ⑥ Attach the lid to the indoor unit's switch box.

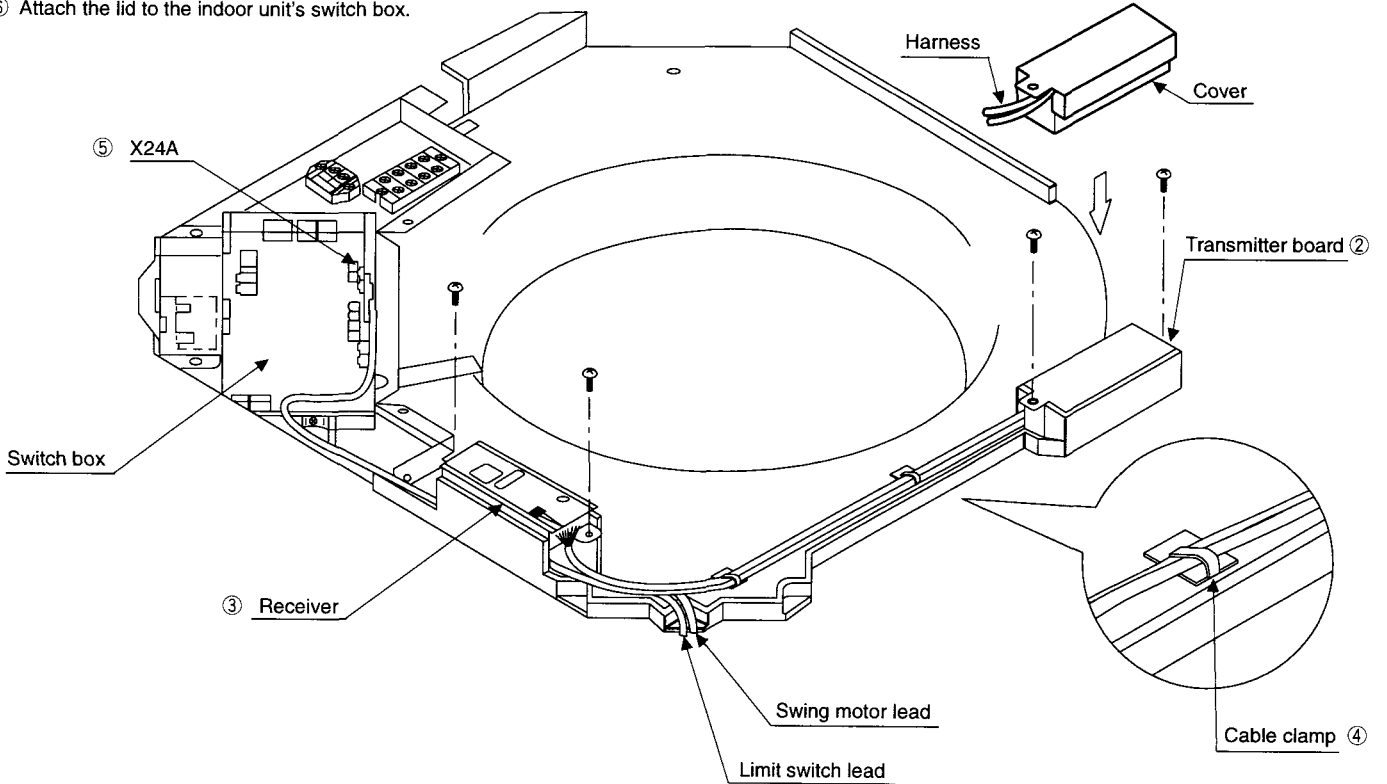
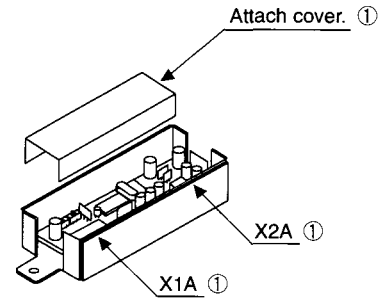
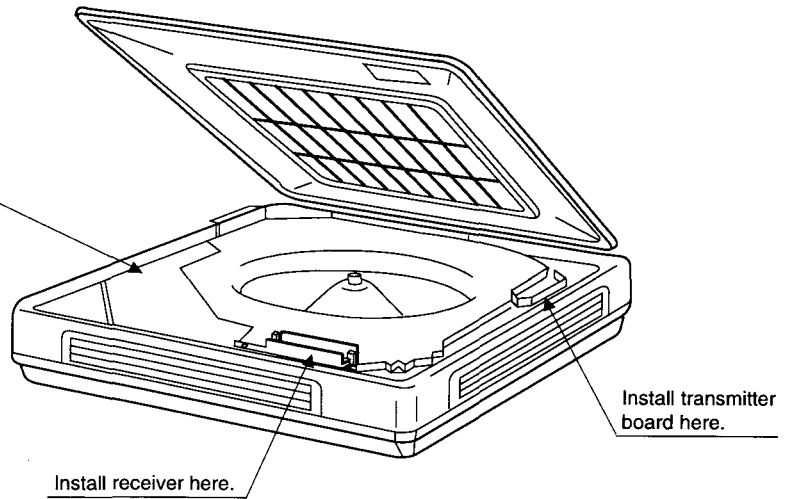

#### (4) ATTACHING THE AIR INTAKE GRILLE

- Attach the air intake grille as explained in the installation instructions of the indoor unit. When doing so, make sure the receiver faceplate on the air intake grille lines up with the receiver on the indoor unit.

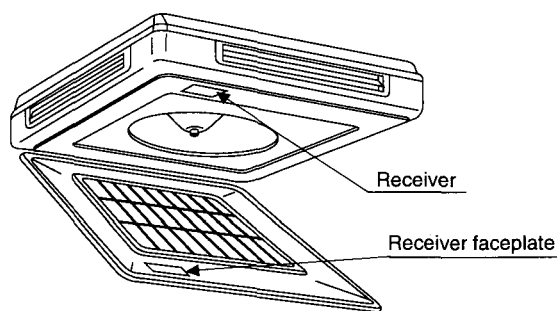

## FIELD SETTING

If optional accessories are mounted on the indoor unit, the indoor unit setting may have to be changed. Refer to the instruction manual (optional hand book) for each optional accessory.

### Procedure

- ① When in the normal mode, press the button for a minimum of four seconds, and the FIELD SET MODE is entered.
- ② Select the desired MODE NO. with the button.
- ③ Push the "UP" button and select the FIRST CODE NO.
- ④ Push the "DOWN" button and select the SECOND CODE NO.
- ⑤ Push the button and the present settings are SET.
- ⑥ Push the button to return to the NORMAL MODE.

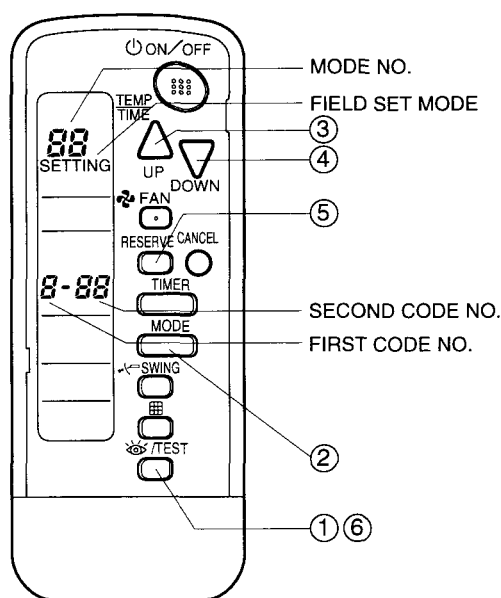

(Example) If the time to clean air filter is set to "Filter Contamination-Heavy", set Mode No. to "10", FIRST CODE NO. to "0", and SECOND CODE NO. to "02".

MODE NO.	FIRST CODE NO.	DESCRIPTION OF SETTING	SECOND CODE NO. NOTE)				
			01	02	03		
10	0	Filter Contamination-Heavy/Light (Setting for spacing time of display time to clean air filter) (Setting for when filter contamination is heavy, and spacing time of display time to clean air filter is to be halved)	Light	Approx. 2,500 hrs.	Heavy	Approx. 1,250 hrs.	—
	3	Spacing time of display time to clean air filter count (Setting for when the filter sign is not to be displayed)	Display		Do not display		—
11 (Split system)	0	Setting the number of connected simultaneous operation system indoor units.	Pair	Twin	Triple		—
12 (VRV system)	1	ON/OFF input from outside (Set to enable starting/stopping from remote.)	Forced OFF input	ON/OFF	—		—
	2	Thermostat differential changeover (Set when using remote controller thermostat sensor.)	1°C	0.5°C	—		—
13	0	High ceiling setting (Setting for when installed in a ceiling higher than 2.7 m)	Normal	High Ceiling 1	High Ceiling 2		—
	1	Selection of Air Flow Direction (Setting for when a blocking pad kit has been installed)	F	T	W		—

Do not use any settings not listed in the table.

For group control with a wireless remote controller, initial settings for all the indoor units of the group are equal. (For group control, refer to the installation manual attached to the indoor unit for group control.)

# TEST OPERATION

- Perform test operation according to the instructions in the installation manual attached to the indoor unit.
- After refrigerant piping, drain piping, and electric wiring, operate according to the table to protect the unit.

## < PRECAUTIONS >

1. Refer to malfunction diagnosis label attached to the unit if it does not operate.
2. Refer to the installation manual attached to the outdoor unit for individual operation system types.

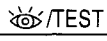
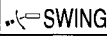
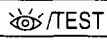
Order	Operation
(1)	Open gas side stop valve.
(2)	Open liquid side stop valve.
(3)	Electrify crank case heater for 6 hours. (Not necessary for cooling type units)
(4)	Set to cooling with the remote controller and push <b>ON/OFF</b> button to start operation.
(5)	Push  button twice and operate in TEST OPERATION mode for 3 minutes.
(6)	Push  button and confirm its operation.
(7)	Push  button and operate normally.
(8)	Confirm its function according to the operation manual.



