Wireless Remote Controller Kit

Model No.

BRC7C54W

BRC7C59W

BRC7C510W

BRC7C511W

BRC7CA510W

BRC7CA511W

READ THESE INSTRUCTIONS CAREFULLY BEFORE INSTALLATION.
KEEP THIS MANUAL IN A HANDY PLACE FOR FUTURE REFERENCE.

LESEN SIE DIESE ANWEISUNGEN VOR DER INSTALLATION SORGFÄLTIG DURCH.
BEWAHREN SIE DIESE ANLEITUNG FÜR SPÄTERE BEZUGNAHME GRIFFBEREIT
AUF.

LIRE SOIGNEUSEMENT CES INSTRUCTIONS AVANT L'INSTALLATION.
CONSERVER CE MANUEL A PORTEE DE MAIN POUR REFERENCE
ULTERIEURE.

LEES DEZE INSTRUCTIES ZORGVULDIG VOOR INSTALLATIE.
BEWAAR DEZE HANDLEIDING WAAR U HEM KAN TERUGVINDEN VOOR LATERE
NASLAG.

PRIMA DI PROCEDERE ALL'INSTALLAZIONE, LEGGERE ATTENTAMENTE QUESTE
ISTRUZIONI.
CONSERVARE QUESTO MANUALE A PORTATA DI MANO PER FUTURE
CONSULTAZIONI.

ΔΙΑΒΑΣΤΕ ΑΥΤΕΣ ΤΙΣ ΟΔΗΓΙΕΣ ΠΡΟΣΕΚΤΙΚΑ ΠΡΙΝ ΑΠΟ ΤΗΝ ΕΓΚΑΤΑΣΤΑΣΗ.
ΦΥΛΑΞΤΕ ΑΥΤΟ ΤΟ ΕΓΧΕΙΡΙΔΙΟ ΕΥΚΑΙΡΟ ΓΙΑ ΝΑ ΤΟ ΣΥΜΒΟΥΛΕΥΕΣΤΕ ΣΤΟ ΜΕΛΛΟΝ.

LEA CUIDADOSAMENTE ESTAS INSTRUCCIONES ANTES DE INSTALAR.
GUARDE ESTE MANUAL EN UN LUGAR A MANO PARA LEER EN CASO DE TENER
ALGUNA DUDA.

LEIA COM ATENÇÃO ESTAS INSTRUÇÕES ANTES DE REALIZAR A INSTALAÇÃO.
MANTENHA ESTE MANUAL AO SEU ALCANCE PARA FUTURAS CONSULTAS.

CONTENTS	En.
SAFETY CONSIDERATIONS	2
BEFORE INSTALLATION	2
REMOTE CONTROLLER INSTALLATION	3
RECEIVER INSTALLATION	3
FIELD SETTING	5
TEST OPERATION	6

INHALTSVERZEICHNIS	Ge.
SICHERHEITSHINWEISE	7
VOR DER INSTALLATION	7
INSTALLATION DER FERNBEDIENUNG	8
INSTALLATION DES EMPFÄNGERS	8
ORTS-EINSTELLUNG	10
TESTBETRIEB	11

TABLE DES MATIERES	Fr.
CONSIDERATIONS DE SECURITE	12
AVANT L'INSTALLATION	12
INSTALLATION DE LA TELECOMMANDE	13
INSTALLATION DU RECEPTEUR	13
REGLAGE LOCAUX	15
ESSAI DE FONCTIONNEMENT	16

INHOUD	Ne.
VEILIGHEIDSOVERWEGINGEN	17
VOOR INSTALLATIE	17
INSTALLATIE VAN DE AFSTANDSBEDIENING	18
INSTALLATIE VAN DE ONTVANGER	18
HET VELD INSTELLEN	20
WERKINGSTEST	21

INDICE	It.
CONSIDERAZIONI PER LA SICUREZZA	22
PRIMA DELL'INSTALLAZIONE	22
INSTALLAZIONE DEL TELECOMANDO	23
INSTALLAZIONE DEL RICEVITORE	23
IMPOSTAZIONE DEL SISTEMA IN BASE AL POSTO DI INSTALLAZIONE	25
FUNZIONAMENTO DI PROVA	26

ΠΕΡΙΕΧΟΜΕΝΑ	Gr.
ΠΡΟΤΑΣΕΙΣ ΑΣΦΑΛΕΙΑΣ	27
ΠΡΙΝ ΑΠΟ ΤΗΝ ΕΓΚΑΤΑΣΤΑΣΗ	27
ΕΓΚΑΤΑΣΤΑΣΗ ΤΗΛΕΧΕΙΡΙΣΤΗΡΙΟΥ	28
ΕΓΚΑΤΑΣΤΑΣΗ ΤΟΥ ΔΕΚΤΗ	28
ΡΥΘΜΙΣΗ ΣΤΗ ΘΕΣΗ ΕΓΚΑΤΑΣΤΑΣΗΣ	30
ΔΟΚΙΜΑΣΤΙΚΗ ΛΕΙΤΟΥΡΓΙΑ	31

INDICE	Sp.
CUIDADOS PARA SU SEGURIDAD	32
ANTES DE INSTALAR	32
INSTALACION DEL CONTROL REMOTO	33
INSTALACION DEL RECEPTOR	33
AJUSTE LOCAL	35
FUNCIONAMIENTO DE PRUEBA	36

ÍNDICE	Po.
CONSIDERAÇÕES SOBRE SEGURANÇA	37
ANTES DA INSTALAÇÃO	37
INSTALAÇÃO DO CONTROLADOR REMOTO	38
INSTALAÇÃO DO RECEPTOR	38
AJUSTAMENTO DO CAMPO	40
FUNIONAMENTO DE TESTE	41

SAFETY CONSIDERATIONS

Please read this "SAFETY CONSIDERATIONS" carefully before installing air conditioning equipment and be sure to install it correctly. After completing the installation, make sure at start up operation that the unit operates properly. Please instruct the customer how to operate the unit and keep maintenance.

Meaning of caution symbols

- ⚠ CAUTION** If the caution is not observed, it may cause injury or damage to equipment.
- NOTE** These instructions will ensure proper use of the equipment.





⚠ CAUTION

- Refer also to the installation manual attached to the indoor unit.
 - Confirm that following conditions are satisfied prior to installation.
 - * Ensure that nothing interrupts the operation of the wireless remote controller. (Ensure that there is neither a source of light nor fluorescent lamp near the receiver. Also, ensure that the receiver is not exposed of direct sun light.)
 - * Ensure that the operation display lamp and other indicators are easy to see.
-

BEFORE INSTALLATION

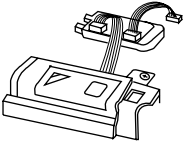
ACCESSORIES

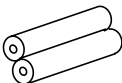
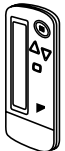
Check if the following accessories are included with your unit.

Name	Shape	Quantity	Name	Shape	Quantity	Name	Shape	Quantity
Wireless display cover		1 set	Remote controller holder		1 pc.	Screw for installing remote controller holder		2 pcs.
			Dry cell battery LR03 (AM4)		2 pcs.			
Wireless remote controller		1 pc.	Unit No. label		1 pc.	Operation manual		1 pc.

NOTE TO THE INSTALLER

Be sure to instruct the customer how to properly operate the system showing him/her the attached operation manual.

REMOTE CONTROLLER INSTALLATION

< Installing wireless remote controller >

- Do not throw the remote controller or impose large shocks. Also, do not store where it may be exposed to moisture or direct sunlight.
- When operating, point the transmitting part of the remote controller in the direction of the receiver.
- The direct transmitting distance of the remote controller is approximately 12 meters.
- The signal cannot be transmitted if something such as curtains blocks the receiver and the remote controller.

• Installing to a wall or a pillar

Slide the remote controller into the remote controller holder from the top.

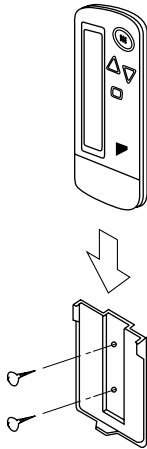

Fix the remote controller holder with the screws.

• How to insert the batteries

① Open the back cover of the remote controller by sliding it in the direction of the arrow.

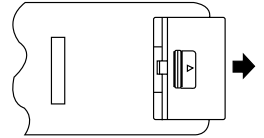

② Insert the attached dry cell batteries. Properly insert, set the batteries by matching the (+) and (-) polarity marks as indicated. Then close the cover as before.

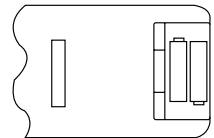

RECEIVER INSTALLATION

(1) Preparations before installation

Install this kit after electric wiring the indoor unit.

- ① Do not attach back in position the right side panel and the control display cover, both of which have been removed for electric wiring. Remove the left side panel too.
- ② Draw out the air filter, and remove the front grille as shown at below.

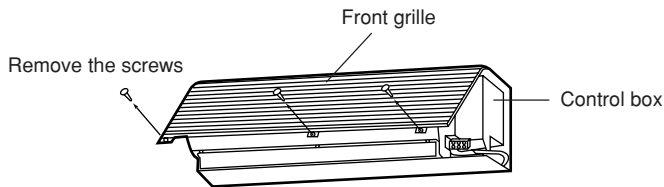

(2) Determination of address and MAIN/SUB remote controller.

If setting multiple wireless remote controllers to operate in one room, perform address setting for the receiver and the wireless remote controller. If setting multiple wired remote controllers in one room, change the MAIN/SUB switch of the receiver.

SETTING PROCEDURE

① Setting the receiver

Referring to the table below, set the wireless address switch (SS2) on the transmission PC board that is connected with the wireless display cover.

Unit No.	No. 1	No. 2	No. 3
Wireless address switch (SS2)			



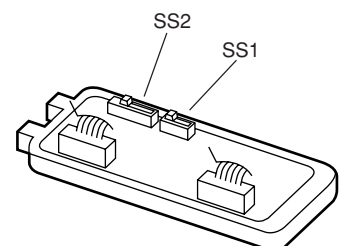

When using both a wired and a wireless remote controller for 1 indoor unit, the wired controller should be set to MAIN. Therefore, set the MAIN/SUB switch (SS1) of the receiver to SUB.



	MAIN	SUB
MAIN/SUB switch (SS1)		

② **Setting the address of wireless remote controller (It is factory set to "1")**

〈 Setting from the remote controller 〉

- ① Hold down the  button and the  button for at least 4 seconds to get the Field Set mode. (Indicated in the display area in the figure at right).
- ② Press the  button and select a multiple setting (A/b). Each time the button is pressed the display switches between "A" and "b".
- ③ Press the "  " button and "  " button to set the address.

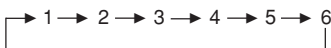

Address can be set from 1 to 6, but set it to 1 ~ 3 and to same address as the receiver. (The receiver does not work with address 4 ~ 6.)

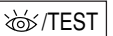
- ④ Press the  button to enter the setting.
- ⑤ Hold down the  button for at least 1 second to quit the Field Set mode and return to the normal display.

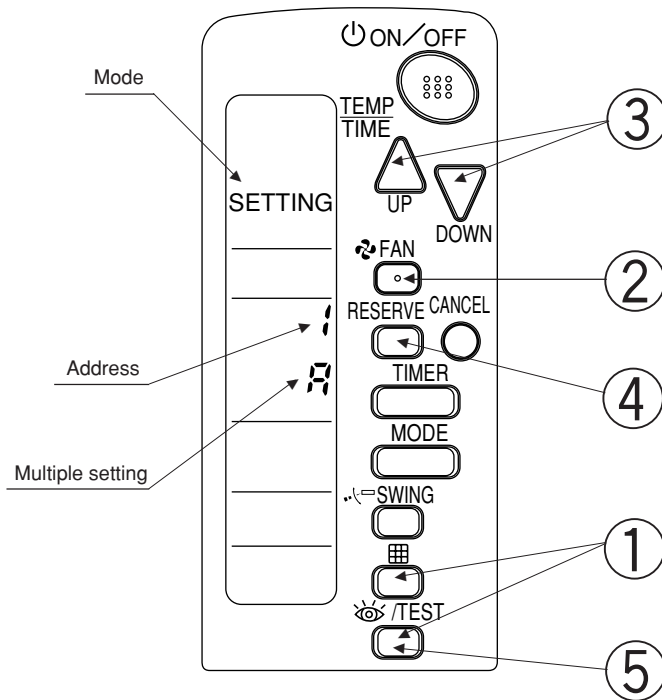

〈 **Multiple settings A/b** 〉

When the indoor unit is being operating by outside control (central remote controller, etc.), it sometimes does not respond to ON/OFF and temperature setting commands from this remote controller. Check what setting the customer wants and make the multiple setting as shown below.

Remote controller		Indoor unit	
Multiple setting	Remote controller display	To control other air conditions and units	For other than on left
A: Standard	All items displayed.	Commands other than ON/OFF and temperature setting accepted. (1 LONG BEEP or 3 SHORT BEEPS emitted)	
b: Multi System	Operations remain displayed shortly after execution.	All commands accepted (2 SHORT BEEPS)	

- ③ Stick the Unit No. labels next to the Model No. label at the bottom of the indoor unit as well as on the back of the wireless remote controller.

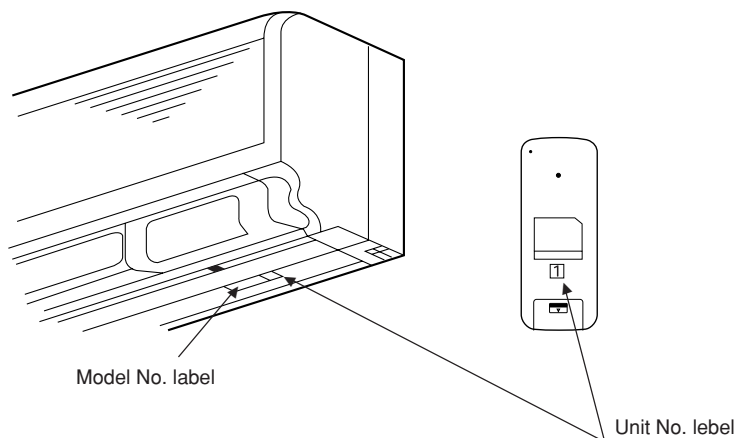

PRECAUTIONS

Set the Unit No. of the receiver and the wireless remote controller to be equal. If the settings differs, the signal from the remote controller cannot be transmitted.

(3) Setting up the wireless display cover and the transmission PC board

- ① To attach the wireless display cover as shown at right, take the reverse steps or detaching the display cover.
 - (A) Insert the cover with the arrow facing toward the right hand of the air outlet.
 - (B) Fix the cover to the control box with the screws.

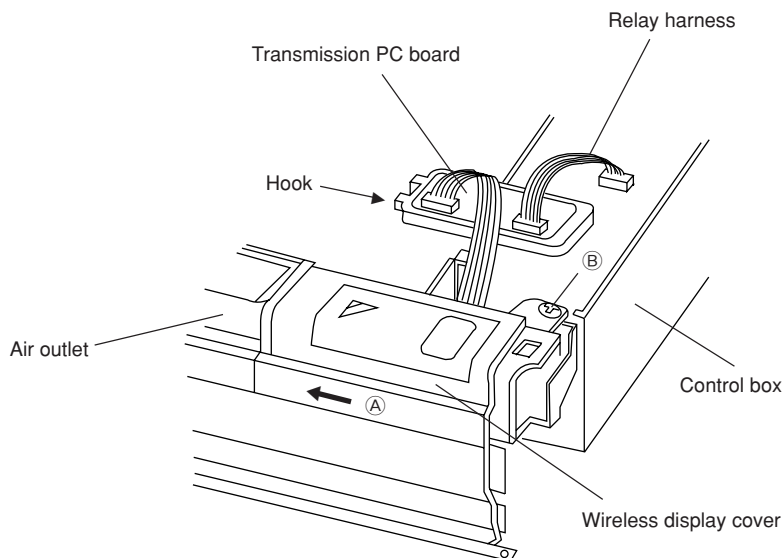

- ② To attach the transmission PC board, take the following steps.

First connect the relay harness of the transmission PC board to the connector (C) on the PC board of the unit.

Then put the transmission PC board, with its hooks upward, on the facing face of the PC board on the unit.

Make sure that the PC board comes on the center of the 3 catches (in the arrow (D)).

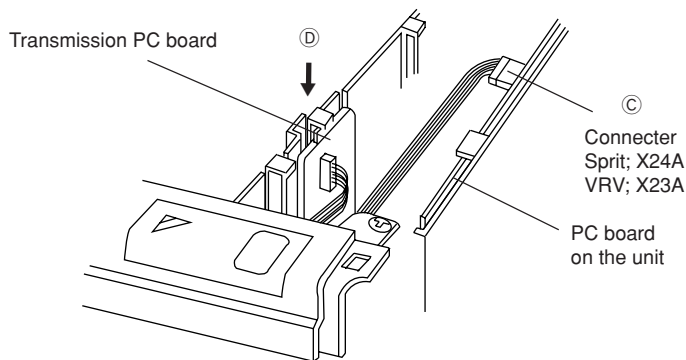





- ③ Place the front grille first and then the right and left side panels into position.
- ④ Finally attach the air filter in place.

FIELD SETTING

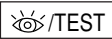
(If optional accessories are mounted on the indoor unit, the indoor unit setting may have to be changed. Refer to the instruction manual (optional hand book) for each optional accessory.)

Procedure

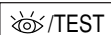
- ① When in the normal mode, press the  button for a minimum of four seconds, and the FIELD SET MODE is entered.
- ② Select the desired MODE NO. with the  button.
- ③ Push the “” button and select the FIRST CODE NO.
- ④ Push the “” button and select the SECOND CODE NO.
- ⑤ Push the  button and the present settings are SET.
- ⑥ Push the  button to return to the NORMAL MODE.

(Example) If the time to clean air filter is set to “Filter Contamination-Heavy”, set Mode No. to “10”, FIRST CODE NO. to “0”, and SECOND CODE NO. to “02”.

MODE NO.	FIRST CODE NO.	DESCRIPTION OF SETTING	SECOND CODE NO.		NOTES) 1.		
			01	02	03		
10	0	Filter Contamination-Heavy/Light (Setting for spacing time of display time to clean air filter) (Setting for when filter contamination is heavy, and spacing time of display time to clean air filter is to be halved)	Light	Approx. 200 hrs.	Heavy	Approx. 100 hrs.	—
	3	Spacing time of display time to clean air filter count (Setting for when the filter sign is not to be displayed)	Display		Do not display		—
11 (Sprit system)	0	Setting the number of connected simultaneous operation system indoor units.	Pair	Twin	Triple		
12 (VRV system)	1	ON/OFF input from outside (Set to enable starting/stopping from remote)	Forced OFF input	ON/OFF		—	
	2	Thermostat differential changeover (Set when using remote controller thermostat sensor.)	1°C	0.5°C		—	
13	0	Air flowrate increase mode (to be set upon user's request)	Standard	A little increase		Increase	

- NOTES) 1. The SECOND CODE NO. is factory set to "01".
 2. Do not use any settings not listed in the table.
 3. For group control with a wireless remote controller, initial settings for all the indoor units of the group are equal. (For group control, refer to the installation manual attached to the indoor unit group control.)

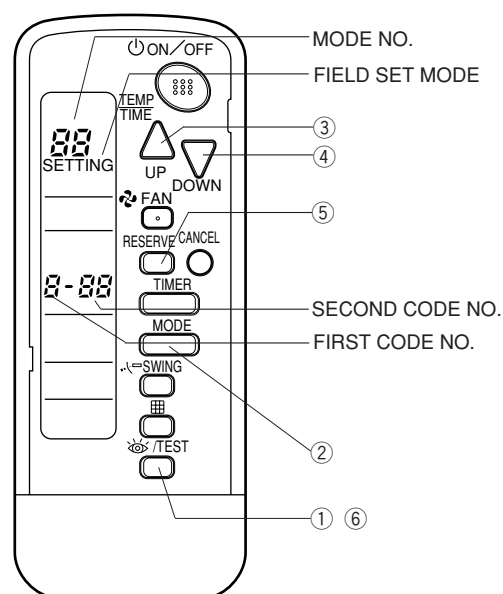

TEST OPERATION

- Perform test operation according to the instructions in the installation manual attached to the indoor unit.
- After refrigerant piping, drain piping, and electric wiring, operate according to the table to protect the unit.

< PRECAUTIONS >

1. Refer to malfunction diagnosis label attached to the unit if it does not operate.
2. Refer to the installation manual attached to the outdoor unit for individual operation system types.

Order	Operation
(1)	Open gas side stop valve.
(2)	Open liquid side stop valve.
(3)	Electrify crank case heater for 6 hours. (Not necessary for cooling type units)
(4)	Set to cooling with the remote controller and push ON/OFF button to start operation.
(5)	Push TEST button twice and operate in TEST OPERATION mode for 3 minutes.
(6)	Push SWING button and confirm its operation.
(7)	Push TEST button and operate normally.
(8)	Confirm its function according to the operation manual.

