Wireless Remote Controller Kit

MODELS

BRC7C512W **BRC7CA512W**
BRC7C513W **BRC7CA513W**

English

Deutsch

Français

READ THESE INSTRUCTIONS CAREFULLY BEFORE INSTALLATION.
KEEP THIS MANUAL IN A HANDY PLACE FOR FUTURE REFERENCE.

LESEN SIE DIESE ANWEISUNGEN VOR DER INSTALLATION SORGFÄLTIG DURCH.
BEWAHREN SIE DIESE ANLEITUNG FÜR SPÄTERE BEZUGNAHME GRIFFBEREIT AUF.

LIRE SOIGNEUSEMENT CES INSTRUCTIONS AVANT L'INSTALLATION.
CONSERVER CE MANUEL A PORTEE DE MAIN POUR REFERENCE ULTERIEURE.



CONTENTS

1. SAFETY CONSIDERATIONS	1
2. BEFORE INSTALLATION	2
3. REMOTE CONTROLLER INSTALLATION	2
4. RECEIVER INSTALLATION	3
5. FIELD SETTING.....	6
6. TEST OPERATION	7

1. SAFETY CONSIDERATIONS

Please read this "SAFETY CONSIDERATIONS" carefully before installing air conditioning equipment and be sure to install it correctly. After completing the installation, make sure at start up operation that the unit operates properly. Please instruct the customer how to operate the unit and keep maintenance.

Meaning of caution symbols

 **CAUTION** If the caution is not observed, it may cause injury or damage to equipment.

NOTE  These instructions will ensure proper use of the equipment.

CAUTION



- Refer also to the installation manual attached to the indoor unit and the installation manual attached to the decoration panel.
- Confirm that following conditions are satisfied prior to installation.
 - Ensure that nothing interrupts the operation of the wireless remote controller. (Ensure that there is neither a source of light nor fluorescent lamp near the receiver. Also, ensure that the receiver is not exposed of direct sun light.)
 - Ensure that the operation display lamp and other indicators are easy to see.
- The installation position of this kit is 1 position of the decoration panel. Therefore, confirm that its position is set so that the signal from the wireless remote controller can be easily transmitted and its display can be easily seen.
- If both this kit and fresh air intake kit are installed, only one duct chamber shall be used. Refer to the installation manual of the fresh air intake kit (optional hand book).

2. BEFORE INSTALLATION

2-1 ACCESSORIES

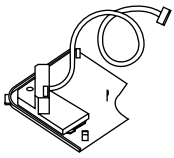
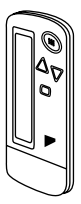
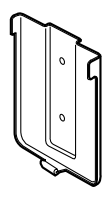
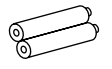
Check if the following accessories are included with your unit.

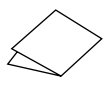
Name	Receiver	Wireless remote controller	Remote controller holder	Dry cell battery LR03 (AM4)	Unit No. label									
Quantity	1 set.	1 pc.	1 pc.	2 pcs.	1 pc.									
Shape					<table border="1" data-bbox="1332 425 1444 504"> <tr><td>1</td><td>2</td><td>3</td></tr> <tr><td>1</td><td>2</td><td>3</td></tr> <tr><td>1</td><td>2</td><td>3</td></tr> </table>	1	2	3	1	2	3	1	2	3
1	2	3												
1	2	3												
1	2	3												

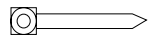
Name	Screw for installing remote control holder	Operation manual	Sealing pad	Binding band
Quantity	2 pcs.	1 pc.	1 pc.	1 pc.
Shape			 20 × 35	

2-2 NOTE TO THE INSTALLER

- Be sure to instruct the customer how to properly operate the system showing him/her the attached operation manual.

3. REMOTE CONTROLLER INSTALLATION

⟨Installing wireless remote controller⟩

- Do not throw the remote controller or impose large shocks. Also, do not store where it may be exposed to moisture or direct sunlight.
- When operating, point the transmitting part of the remote controller in the direction of the receiver.
- The direct transmitting distance of the remote controller is approximately 7 meters.
- The signal cannot be transmitted if something such as curtains blocks the receiver and the remote controller.

- Installing to a wall or a pillar

Slide the remote controller into the remote controller holder from the top.

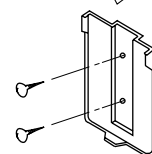
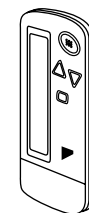

Fix the remote controller holder with the screws.

- How to insert the batteries

1. Open the back cover of the remote controller by sliding it in the direction of the arrow.

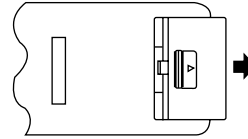

2. Insert the attached dry cell batteries. Properly insert, set the batteries by matching the (+) and (-) polarity marks as indicated. Then close the cover as before.

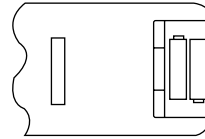

4. RECEIVER INSTALLATION

(1) Preparations before installation.

Install this kit after installing the decoration panel.

1. Remove the suction grille and the air filter according to the instructions in the installation manual attached to the decoration panel.
2. Remove the control box lid according to the instructions in the installation manual attached to the indoor unit.

(2) Determination of address and MAIN/SUB remote controller.

If setting multiple wireless remote controllers to operate in one room, perform address setting for the receiver and the wireless remote controller.

If setting multiple wired remote controllers in one room, change the MAIN/SUB switch of the receiver.

SETTING PROCEDURE

1. Setting the receiver

Through the small opening on the back of the receiver, set the wireless address switch (SS2) on the printed circuit board according to the table below.

Unit No.	No. 1	No. 2	No. 3
Wireless address switch (SS2)			

When using both a wired and a wireless remote controller for 1 indoor unit, the wired controller should be set to MAIN. Therefore, set the MAIN/SUB switch (SS1) of the receiver to SUB.

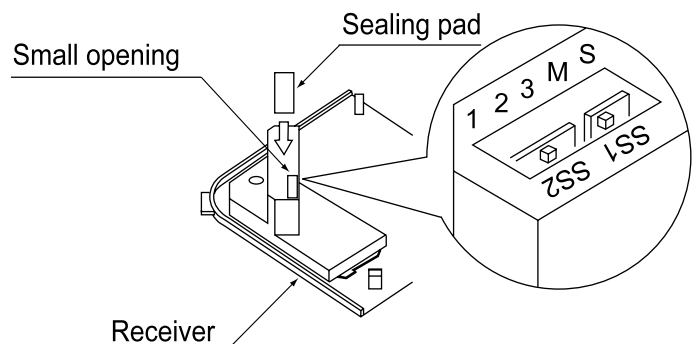

	MAIN	SUB
MAIN/SUB switch (SS1)		



After completing setting, seal off the opening of the address switch and the MAIN/SUB switch with the attached sealing pad.



2. Setting the address of wireless remote controller (It is factory set to “1”)

〈Setting from the remote controller〉

1. Hold down the  button and the  button for at least 4 seconds to get the Field Set mode.



(Indicated in the display area in the figure at right.)

2. Press the  button and select a multiple setting (A/b). Each time the button is pressed the display switches between “A” and “b”.

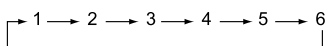
3. Press the “” button and “” button to set the address.



Address can be set from 1 to 6, but set it to 1 ~ 3 and to same address as the receiver. (The receiver does not work with address 4 ~ 6.)

4. Press the  button to enter the setting.
5. Hold down the  button for at least 1 second to quit the Field Set mode and return to the normal display.

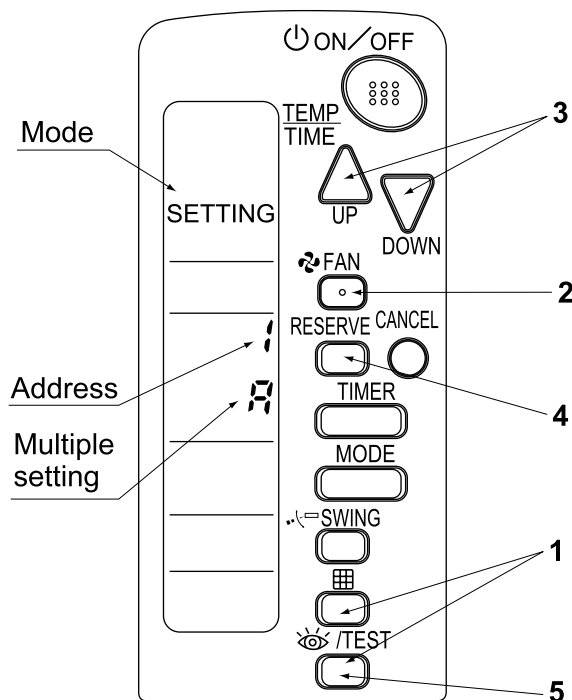

Multiple settings A/b

When the indoor unit is being operating by outside control (central remote controller, etc.), it sometimes does not respond to ON/OFF and temperature setting commands from this remote controller. Check what setting the customer wants and make the multiple setting as shown below.

Remote controller		Indoor unit	
Multiple setting	Remote controller display	To control other air conditions and units	For other than on left
A: Standard	All items displayed.	Commands other than ON/OFF and temperature setting accepted. (1 LONG BEEP or 3 SHORT BEEPS emitted)	
b: Multi System	Operations remain displayed shortly after execution.	All commands accepted (2 SHORT BEEPS)	

- Stick the Unit No. label on the air outlet of the decoration panel and the back of the wireless remote controller.

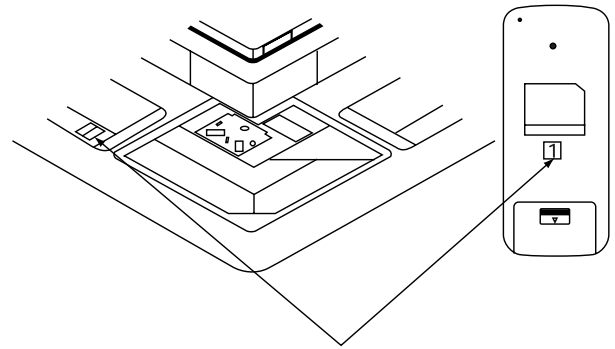

Unit No. label

[PRECAUTIONS]

Set the Unit No. of the receiver and the wireless remote controller to be equal. If the settings differs, the signal from the remote controller cannot be transmitted.

(3) Receiver installation.

- Detach the swing motor and the diagonally opposite decorative corner panel. This corner panel piece is not needed hereafter. (For instructions on attaching/ detaching decorative panels, see the installation instructions provided with the original panel.)

The receiver cannot be installed anywhere but in this corner.



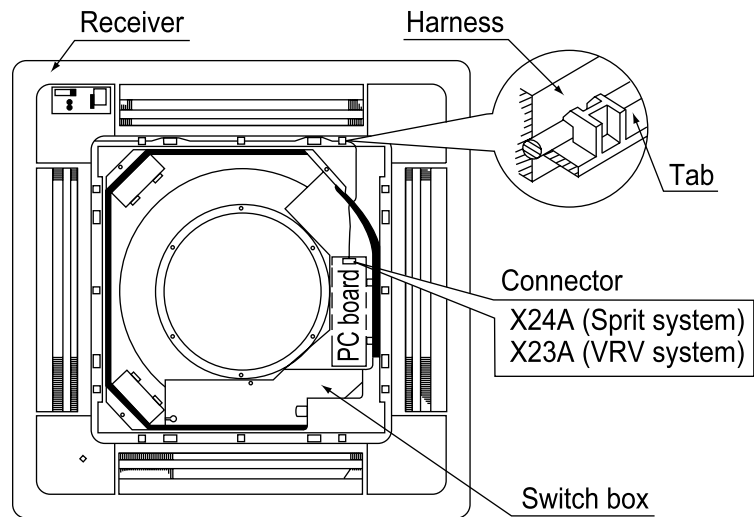
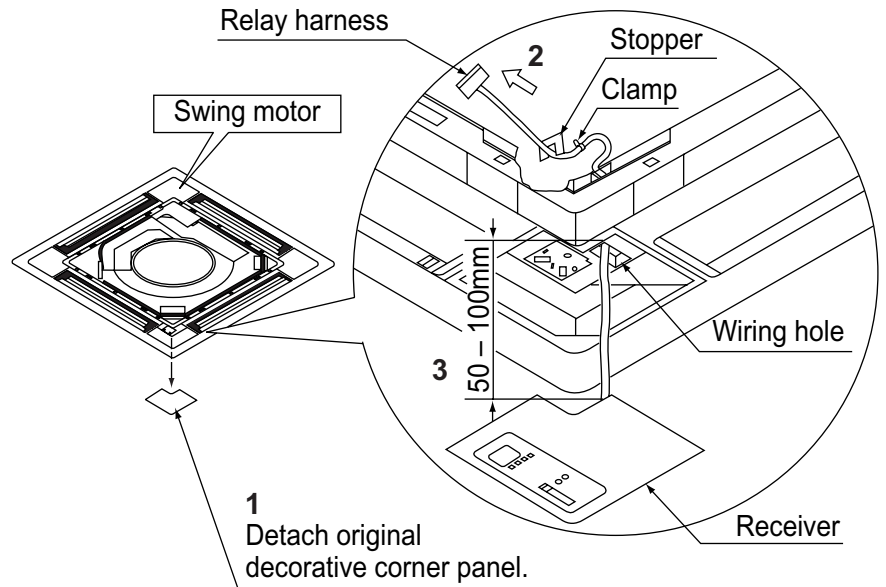

- Pull the relay harness from the receiver up to where the clamp meets the stopper, as shown at right.
- Install the receiver where the decorative corner panel before. Proceed in the oppsite order in which you removed the corner panel.
- Fit the relay harness under the tab on the decorative panel and connect it to connector (refer to the right figure) on the indoor unit PC board. Bundle the remaining harness with the included tie band so that it does not droop or get pinched in the suction grille.
- Attach the lid to the indoor unit's switch box and the suction grille to the decorative panel.

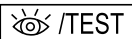

5. FIELD SETTING

(If optional accessories are mounted on the indoor unit, the indoor unit setting may have to be changed. Refer to the instruction manual (optional hand book) for each optional accessory.)

Procedure

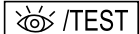
1. When in the normal mode, press the  button for a minimum of four seconds, and the FIELD SET MODE is entered.
2. Select the desired MODE NO. with the  button.
3. Push the “” button and select the FIRST CODE NO.
4. Push the “” button and select the SECOND CODE NO.
5. Push the  button and the present settings are SET.
6. Push the  button to return to the NORMAL MODE.

(Example)

If the time to clean air filter is set to “Filter Contamination-Heavy”, set Mode No. to “10”, FIRST CODE NO. to “0”, and SECOND CODE NO. to “02”.

MODE NO.	FIRST CODE NO.	DESCRIPTION OF SETTING	SECOND CODE NO. NOTE)				
			01	02	03		
10	0	Filter Contamination-Heavy/Light (Setting for spacing time of display time to clean air filter) (Setting for when filter contamination is heavy, and spacing time of display time to clean air filter is to be halved)	Light	Approx. 2,500 hrs.	Heavy	Approx. 1,250 hrs.	—
	3	Spacing time of display time to clean air filter count (Setting for when the filter sign is not to be displayed)	Display		Do not display		—
11 (Split system)	0	Setting the number of connected simultaneous operation system indoor units.	Pair	Twin		Triple	
12 (VRV system)	1	ON/OFF input from outside (Set to enable starting/stopping from remote.)	Forced OFF input	ON/OFF			—
	2	Thermostat differential changeover (Set when using remote controller thermostat sensor.)	1°C	0.5°C			—
13	0	High ceiling setting (Setting for when installed in a ceiling higher than 2.7 m)	Normal	High Ceiling 1		High Ceiling 2	
	1	Selection of Air Flow Direction (Setting for when a blocking pad kit has been installed)	F	T			W
	4	Air Flow Direction Range Setting	Upper	Normal		Lower	

NOTE) The SECOND CODE NO. is factory set to "01". However, for the following cases it is set to "02".

- Remote controller thermostat sensor (Spirit System only)
- Air Flow Direction Range Setting

Do not use any settings not listed in the table.

For group control with a wireless remote controller, initial settings for all the indoor units of the group are equal. (For group control, refer to the installation manual attached to the indoor unit for group control.)

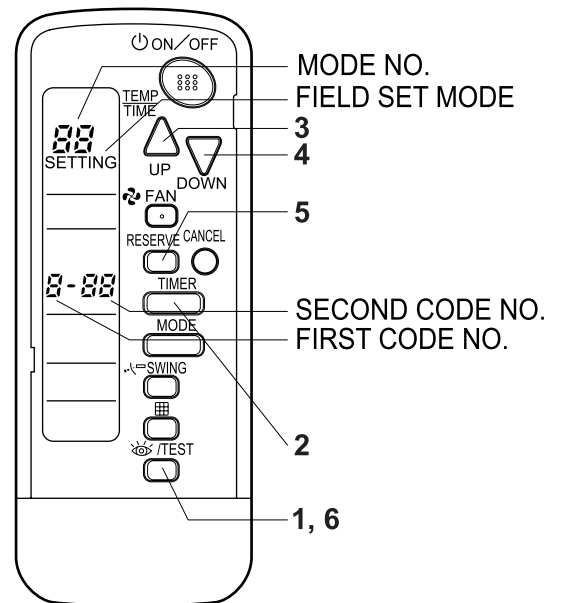

6. TEST OPERATION

- Perform test operation according to the instructions in the installation manual attached to the indoor unit.
- After refrigerant piping, drain piping, and electric wiring, operate according to the table to protect the unit.

[PRECAUTIONS]

1. Refer to malfunction diagnosis label attached to the unit if it does not operate.
2. Refer to the installation manual attached to the outdoor unit for individual operation system types.

Order	Operation
(1)	Open gas side stop valve.
(2)	Open liquid side stop valve.
(3)	Electrify crank case heater for 6 hours. (Not necessary for cooling type units)
(4)	Set to cooling with the remote controller and push ON/OFF button to start operation.
(5)	Push TEST button twice and operate in TEST OPERATION mode for 3 minutes.
(6)	Push SWING button and confirm its operation.
(7)	Push TEST button and operate normally.
(8)	Confirm its function according to the operation manual.

