

DAIKIN



INSTALLATION MANUAL

Wireless remote controller kit

BRC7E530W8
BRC7E531W8

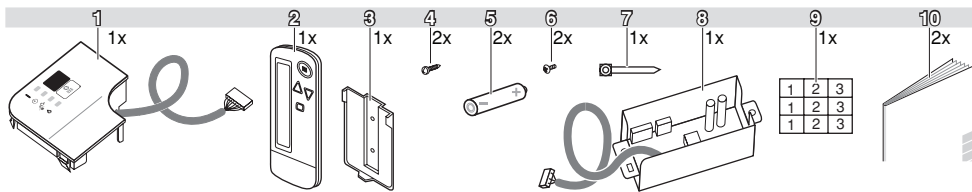

1

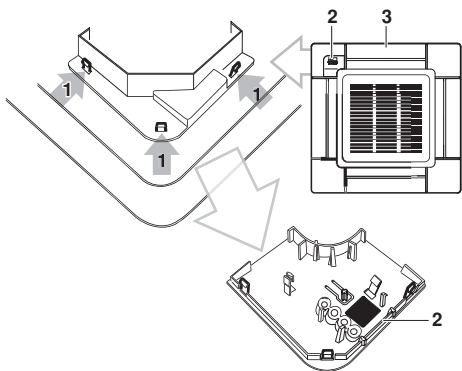

2

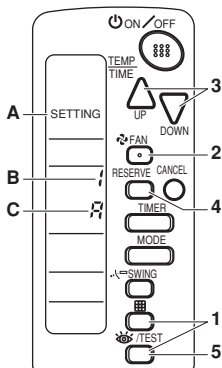

3

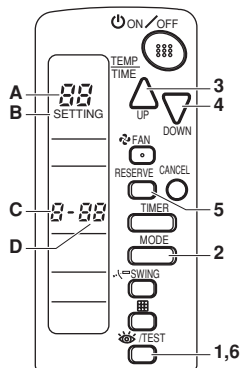

4

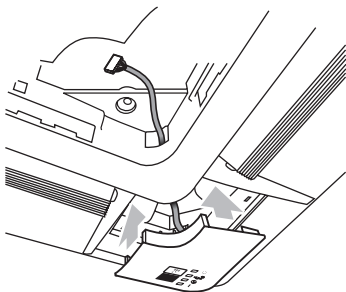

5

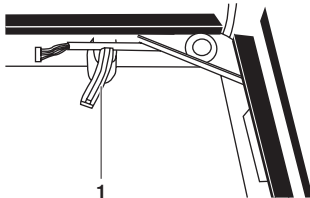

6

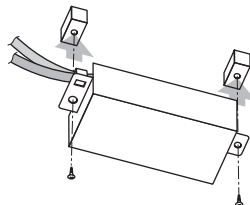

7

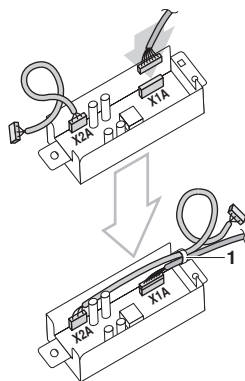

8

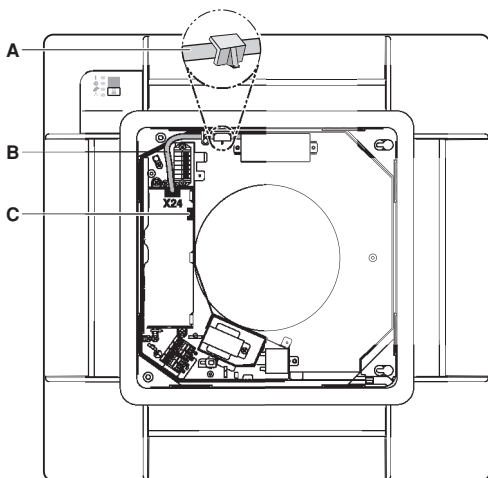

9

CONTENTS

	Page
Safety considerations	1
Before installation	1
Accessories	1
Note to the installer	1
Remote controller installation	2
Installing wireless remote controller	2
Receiver installation	2
Preparations before installation	2
Determination of address and MAIN/SUB remote controller	2
Setting procedure	2
Receiver installation	3
Field setting	4
Test operation	5



READ THIS MANUAL ATTENTIVELY BEFORE STARTING UP THE UNIT. DO NOT THROW IT AWAY. KEEP IT IN YOUR FILES FOR FUTURE REFERENCE.

IMPROPER INSTALLATION OR ATTACHMENT OF EQUIPMENT OR ACCESSORIES COULD RESULT IN ELECTRIC SHOCK, SHORT-CIRCUIT, LEAKS, FIRE OR OTHER DAMAGE TO THE EQUIPMENT. BE SURE ONLY TO USE ACCESSORIES MADE BY DAIKIN WHICH ARE SPECIFICALLY DESIGNED FOR USE WITH THE EQUIPMENT AND HAVE THEM INSTALLED BY A PROFESSIONAL.

IF UNSURE OF INSTALLATION PROCEDURES OR USE, ALWAYS CONTACT YOUR DAIKIN DEALER FOR ADVICE AND INFORMATION.

SAFETY CONSIDERATIONS

Please read this "Safety considerations" carefully before installing air conditioning equipment and be sure to install it correctly. After completing the installation, make sure at start up operation that the unit operates properly. Please instruct the customer how to operate the unit and keep maintenance.

Please instruct the customer how to operate the unit and keep maintenance.

Meaning of caution symbols



If the caution is not observed, it may cause injury or damage to equipment.

NOTE



These instructions will ensure proper use of the equipment.



- Refer also to the installation manual attached to the indoor unit and the installation manual attached to the decoration panel.
- Confirm that following conditions are satisfied prior to installation.
 - Ensure that nothing interrupts the operation of the wireless remote controller. (Ensure that there is neither a source of light nor fluorescent lamp near the receiver. Also, ensure that the receiver is not exposed of direct sunlight.)
 - Ensure that the operation display lamp and other indicators are easy to see.
- The installation position of this kit is 1 position of the decoration panel. Therefore, confirm that its position is set so that the single form the wireless remote controller can be easily transmitted and its display can be easily seen.

BEFORE INSTALLATION

Accessories

See [figure 1](#). Check if the following accessories are included with your unit.

- | | |
|---|---|
| 1 Receiver | 5 Alkaline battery of type AAA.LR03 |
| 2 Wireless remote controller | 6 Tapping screw for transmitter board |
| 3 Remote controller holder | 7 Clamp |
| 4 Screw for installing remote controller holder | 8 Transmitter board |
| | 9 Unit No. label |
| | 10 Installation manual Operation manual |

Note to the installer

Be sure to instruct the customer how to properly operate the system showing him/her the attached operation manual.

REMOTE CONTROLLER INSTALLATION

Installing wireless remote controller

- Do not throw the remote controller or impose large shocks. Also, do not store where it may be exposed to moisture or direct sunlight.
- When operating, point the transmitting part of the remote controller in the direction of the receiver.
- The direct transmitting distance of the remote controller is approximately 7 meters.
- The signal cannot be transmitted if something such as curtains blocks the receiver and the remote controller.

Installing to a wall or a pillar

- 1 Fix the remote controller holder with the screws.
- 2 Slide the remote controller into the remote controller holder from the top.

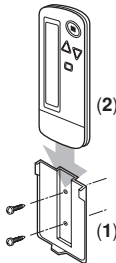

How to insert the batteries

- 1 Open the back cover of the remote controller by sliding it in the direction of the arrow.
- 2 Insert the attached dry cell batteries. Properly insert, set the batteries by matching the (+) and (-) polarity marks as indicated. Then close the cover as before.

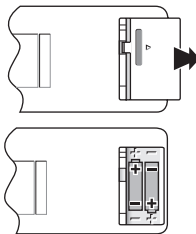

RECEIVER INSTALLATION

Preparations before installation

(See figure 2)

- 1 Detach the brand name plate part of the of the decoration corner panel piece, before attaching the decoration panel . This part is not needed hereafter.
- 2 Next, remove the suction grille and the air filter according to the instructions in the installation manual attached to the decoration panel.
- 3 Remove the control box lid according to the instructions in the installation manual attached to the indoor unit. (Be sure to turn off power, before removing the control box lid.)
 - 1 Push three hooks to detach them from the holes of the rear side.
 - 2 Brand name plate part
 - 3 Decoration panel

Determination of address and MAIN/SUB remote controller

- If setting multiple wireless remote controllers to operate in one room, perform address setting for the receiver and the wireless remote controller.
- If setting multiple wired remote controllers in one room, change the MAIN/SUB switch of the receiver.

Setting procedure

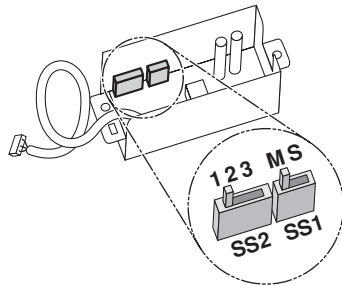

Setting the receiver

Set the wireless address switch (SS2) on the transmitter board according to the table below.

	Unit No.		
	1	2	3
Wireless address switch (SS2)	 1 2 3	 1 2 3	 1 2 3

When using both a wired and a wireless remote controller for 1 indoor unit, the wired controller should be set to MAIN. Therefore, set the MAIN/SUB switch (SS1) of the transmitter board to SUB.

	MAIN	SUB
MAIN/SUB switch (SS1)	 S M	 S M

(See figure 3)

- A Mode
- B Address (is factory set to "f")
- C Multiple setting

Setting from the remote controller

- Hold down the button and the /TEST button for at least 4 seconds to get the Field Set mode. (Indicated in the display area in the figure.)
- Press the FAN button and select a multiple setting (R/b). Each time the button is pressed the display switches between "R" and "b".
- Press the button and button to set the address.

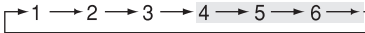

Address can be set from 1 to 6, but set it to 1~3 and to same address as the receiver. (The receiver does not work with address 4~6.)

- Press the RESERVE button to enter the setting.
- Hold down the /TEST button for at least 1 second to quit the Field Set mode and return to normal display.

Multiple setting R/b

When the indoor unit is being operated by outside control (central remote controller, etc.), it sometimes does not respond to ON/OFF and temperature setting commands from this remote controller. Check what setting the customer wants and make the multiple setting as shown below.

Remote controller		Movement when the operation is controlled by the other air conditioners and equipment
Multiple setting	Remote controller display	
R: Standard	All items displayed.	When operation changeover, temperature setting or the like is carried out from the remote controller, the indoor unit rejects the instruction. (Signal receiving sound "peeh" or "pick-pick-pick") As a result, a discrepancy between the operation state of the indoor unit and the indication of the remote controller display occurs.
b: Multi System	Operations remain displayed shortly after execution.	Since the indication of the remote controller is turned off, no discrepancy such as mentioned above occurs.

Stick the unit number label on the air outlet of the decoration panel and on the back of the wireless remote controller.

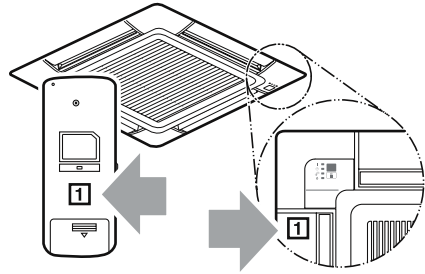

NOTE Set the Unit No. of the receiver and the wireless remote controller to be equal. If the settings differ, the signal from the remote controller cannot be transmitted.

Receiver installation

- Refer to [figure 5](#). Pass the harness from the receiver through the wiring hole of the decoration panel. Then, attach the receiver to the decoration panel.
- Refer to [figure 6](#). Hook the harness from the receiver of the decoration panel. Be sure to push the harness to the groove.

1 Panel temporary suspension

- Attach the decoration panel to the indoor unit. (Refer to the installation manual attached to the decoration panel.)
- Refer to [figure 8](#). Connect the harness from the receiver to the connector X1A on the transmitter board.

After connecting, use the clamp to fix the two harnesses to the transmitter board box.

1 Clamp

- Refer to [figure 7](#). Use two tapping screws to attach the transmitter board to the indoor unit, as shown in the figure.

6 Refer to figure 9. Connect the harness from the transmitter board to the connector X24 on the indoor unit PC board.

- A Be sure to pass only the harness connecting to the indoor unit PC board under the tab.
- B Be sure to wire the harness as shown to avoid the harness to be caught by the control box and the control box lid.
- C Position of the connector in the case of the VRV system.

(See figure 4)

- A MODE NO.
- B FIELD SET MODE
- C FIRST CODE NO.
- D SECOND CODE NO.

Procedure

- 1 When in normal mode, press the /TEST button for a minimum of four seconds, and the FIELD SET MODE is entered.
- 2 Select the desired MODE NO. with the MODE button.
- 3 Push the button and select the FIRST CODE NO.
- 4 Push the button and select the SECOND CODE NO.
- 5 Push the RESERVE button and the present settings are SET.
- 6 Push the /TEST button to return to the NORMAL MODE.

FIELD SETTING

If optional accessories are mounted on the indoor unit, the indoor unit setting may have to be changed. Refer to the instruction manual (optional hand book) for each optional accessory.

Example

If the time to clean air filter is set to "Filter Contamination-Heavy", set MODE NO. to "10", FIRST CODE NO. to "0", and SECOND CODE NO. to "02".

MODE NO.	FIRST CODE NO.	Description of setting	SECOND CODE NO. ¹					
			01		02		03	
10	0	Filter Contamination-Heavy/Light (Setting for spacing time of display time to clean air filter) (Setting for when filter contamination is heavy, and spacing time of display time to clean air filter is to be halved)	Long-life type	Light	±2500 hours	Heavy	±1250 hours	—
	3	Spacing time of display time to clean air filter count (Setting for when the filter sign is not to be displayed)		Display		Do not display		—
12 (VRV system)	1	ON/OFF input from outside (Set to enable starting/stopping from remote.)		Forced OFF input		ON/OFF		—
	2	Thermostat differential changeover (Set when using remote controller thermostat sensor.)		1°C		0.5°C		—
13	1	Selection of Air Flow Direction (Setting for when a sealing member of air discharge outlet kit has been installed)		F		T		W
	4	Air Flow Direction Range Setting		Upper		Normal		Lower

1 **NOTE**The SECOND CODE NO. is factory set to "0". However, for the following cases it is set to "02".

- Air Flow Direction Range Setting

Do not use any settings not listed in the table.
For group control with a wireless remote controller, initial settings for all the indoor units of the group are equal. (For group control, refer to the installation manual attached to the indoor unit for group control.)



4PW23710-1 A 000000F

Copyright © Daikin

DAIKIN EUROPE N.V.

Zandvoordestraat 300, B-8400 Oostende, Belgium

4PW23710-1A