

2.2 BRC7E61W / BRC7E65 (For FXF)

2.2.1 Operation

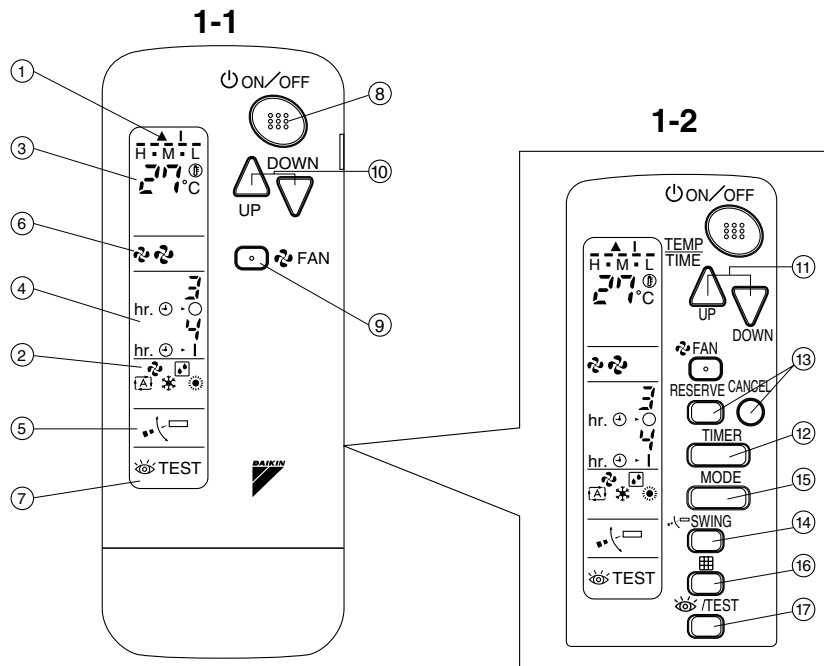

1

COOL/HEAT CHANGEOVER REMOTE CONTROL SWITCH

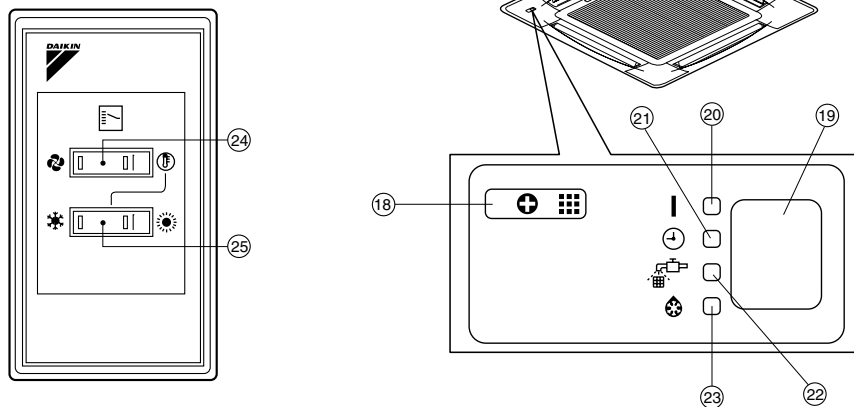

1-3

2

3PA63363-24W-0

1. SAFETY CONSIDERATIONS

Read the following cautions carefully and use your equipment properly.

There are three kinds of safety cautions and tips listed here as follows:

⚠ WARNING Improper handling can lead to such serious consequences as death or severe injury.

⚠ CAUTION Improper handling can lead to injury or damage. It could also have serious consequences under certain conditions.

NOTE  These instructions will ensure proper use of the equipment.

Be sure to follow these important safety cautions. **Keep these warning sheets handy so that you can refer to them if needed.**

Also, if this equipment is transferred to a new user, make sure to hand over this user's manual to the new user.

⚠ WARNING

Do not expose yourself directly to the cool air currents too long nor allow the air in the room to become too cold.

Doing so may make you feel sick or damage your health.

If you detect any abnormality (such as the smell of fire), turn off the power and contact your dealer for instructions.

If you keep using the air conditioner under these conditions, it will eventually break down, and could cause electric shocks or catch fire.

Ask your dealer to install your equipment. Improper installation could cause water leakage, electric shocks or fire.

Ask your dealer to perform servicing or repairs whenever necessary.

Improper servicing or repairs could cause water leakage, electric shocks or fire.

Do not stick your fingers or any other objects into the air inlet, air outlet or air direction vanes during operation.

The high-speed fan is dangerous and could cause injury.

Ask your dealer to remove and reinstall your equipment whenever necessary. Improper installation could cause water leakage, electric shocks or fire.

⚠ CAUTION

Do not use the air conditioner for purposes other than air conditioning.

Do not use the air conditioner for special purposes such as preserving or protecting food, animals, plants, precision machinery or works of art, since the quality of such items could be adversely affected.

When using the air conditioner with other heating equipment, ventilate the room from time to time.

Inadequate ventilation could cause an oxygen shortage.

Do not expose your pets or plants to the air current.

They may be adversely affected.

Do not operate the air conditioner with a wet hand.

Otherwise, you could receive an electric shock.















Do not place any burning appliance in the air current from the air conditioner, since such appliance may suffer incomplete combustion.

Never place nor use any inflammable sprays near the air conditioner, since such sprays could cause a fire.

2

2.2 BRCTE61W / BRCTE65





2. NAMES AND FUNCTIONS OF THE OPERATING SECTION (Fig. 1, 2)

1	DISPLAY “▲” (SIGNAL TRANSMISSION)
	This lights up when a signal is being transmitted.
2	DISPLAY “” “” “” “” “” (OPERATION MODE)
	This display shows the current OPERATION MODE. For cooling only type, “  ” (Auto) and “  ” (Heating) are not installed.
3	DISPLAY “” (SET TEMPERATURE)
	This display shows the set temperature.
4	DISPLAY “ hr.  hr.” (PROGRAMMED TIME)
	This display shows PROGRAMMED TIME of the system start or stop.
5	DISPLAY “” (AIR FLOW FLAP)
	Refer to Note 1.
6	DISPLAY “” “” (FAN SPEED)
	The display shows the set fan speed.
7	DISPLAY “ TEST” (INSPECTION/ TEST OPERATION)
	When the INSPECTION/TEST OPERATION BUTTON is pressed, the display shows the system mode is in.

8	ON/OFF BUTTON
	Press the button and the system will start. Press the button again and the system will stop.
9	FAN SPEED CONTROL BUTTON
	Press this button to select the fan speed, HIGH or LOW, of your choice.
10	TEMPERATURE SETTING BUTTON
	Use this button for SETTING TEMPERATURE (Operates with the front cover of the remote controller closed.)
11	PROGRAMMING TIMER BUTTON
	Use this button for programming “START and/or STOP” time. (Operates with the front cover of the remote controller opened.)
12	TIMER MODE START/STOP BUTTON
	Refer to Note 1.
13	TIMER RESERVE/CANCEL BUTTON
	Refer to Note 2.
14	AIR FLOW DIRECTION ADJUST BUTTON
	Refer to Note 1.
15	OPERATION MODE SELECTOR BUTTON
	Press this button to select OPERATION MODE.
16	FILTER SIGN RESET BUTTON
	Refer to the section of MAINTENANCE in the operation manual attached to the indoor unit.
17	INSPECTION/TEST OPERATION BUTTON
	This button is used only by qualified service persons for maintenance purposes.
18	EMERGENCY OPERATION SWITCH
	This switch is readily used if the remote controller does not work.
19	RECEIVER
	This receives the signals from the remote controller.

3PA63363-24W-2

Note 1 : page 35, Note 2 : page 36

20	OPERATING INDICATOR LAMP (Red) This lamp stays lit while the air conditioner runs. It flashes when the unit is in trouble.
21	TIMER INDICATOR LAMP (Green) This lamp stays lit while the timer is set.
22	AIR FILTER CLEANING TIME INDICATOR LAMP (Red) Lights up when it is time to clean the air filter.
23	DEFROST LAMP (Orange) Lights up when the defrosting operation has started. (For cooling only type this lamp does not turn on.)
24	FAN/AIR CONDITIONING SELECTOR SWITCH Set the switch to “  ” (FAN) for FAN and “  ” (A/C) for HEAT or COOL.
25	COOL/HEAT CHANGEOVER SWITCH Set the switch to “  ” (COOL) for COOL and “  ” (HEAT) for HEAT.
NOTES 	
<ul style="list-style-type: none"> For the sake of explanation, all indications are shown on the display in Figure 1 contrary to actual running situations. Fig. 1-2 shows the remote controller with the front cover opened. Fig. 1-3 shows this remote controller can be used in conjunction with the one provided with the VRV system. If the air filter cleaning time indicator lamp lights up, clean the air filter as explained in the operation manual provided with the indoor unit. After cleaning and reinstalling the air filter, press the filter sign reset button on the remote controller. The air filter cleaning time indicator lamp on the receiver will go out. The Defrost Lamp will flash when the power is turned on. This is not a malfunction. 	

3. HANDLING FOR WIRELESS REMOTE CONTROLLER

Precautions in handling remote controller

Direct the transmitting part of the remote controller to the receiving part of the air conditioner.

If something blocks the transmitting and receiving path of the indoor unit and the remote controller as curtains, it will not operate.

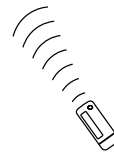
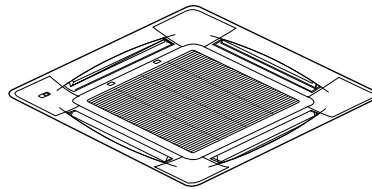

2 short beeps from the receiver indicates that the transmission is properly done.

Transmitting distance is approximately 7 m.

Do not drop or get it wet.

It may be damaged.

Never press the button of the remote controller with a hard, pointed object.

The remote controller may be damaged.

Installation site

- It is possible that signals will not be received in rooms that have electronic fluorescent lighting. Please consult with the salesman before buying new fluorescent lights.
- If the remote controller operated some other electrical apparatus, move that machine away or consult your dealer.

Placing the remote controller in the remote controller holder

Install the remote controller holder to a wall or a pillar with the attached screw. (Make sure it transmits)

Placing the remote controller

Slide from above

Removing the remote controller

Pull it upward

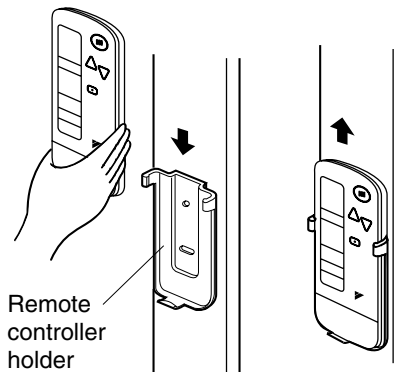

How to put the dry batteries

- (1) Remove the back cover of the remote controller to the direction pointed by the arrow mark.
- (2) Put the batteries
Use two LR03<IEC> dry cell batteries. Put dry batteries correctly to fit their (+) and (-).
- (3) Close the cover

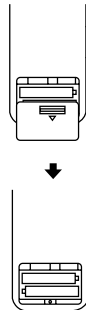

— When to change batteries —

Under normal use, batteries last about a year. However, change them whenever the indoor unit doesn't respond or responds slowly to commands, or if the display becomes dark.

[CAUTIONS]

- Replace all batteries at the same time, do not use new and old batteries intermixed.

- In case the remote controller is not used for a long time take out all batteries in order to prevent liquid leak of the battery.

IN THE CASE OF CENTRALIZED CONTROL SYSTEM

If the indoor unit is under centralized control, it is necessary to switch the remote controller's setting. In this case, contact your DAIKIN dealer.

4. OPERATION RANGE

Split System

If the temperature or the humidity is beyond the following conditions, safety devices may work and the air conditioner may not operate, or sometimes, water may drop from the indoor unit.

COOLING [°C]

OUTDOOR UNIT	INDOOR		OUTDOOR TEMPERATURE
	TEMPERATURE	HUMIDITY	
RZP71 DV1/VAL RZP100 DV1/VAL	D B	21 to 35	D B -5 to 50
RZP125 DV1/TAL RZP140 DTAL	W B	14 to 25	

HEATING [°C]

OUTDOOR UNIT	INDOOR TEMPERATURE	OUTDOOR TEMPERATURE
RZP71 DV1/VAL RZP100 DV1/VAL	D B 15 to 27	D B -14 to 21
RZP125 DV1/TAL RZP140 DTAL		W B -15 to 15.5

DB: Dry bulb temperature
WB: Wet bulb temperature

3PA63363-24W-4

The setting temperature range of the remote controller is 16°C to 32°C.

VRV System

See the operation manual provided with the air conditioner.

5. OPERATION PROCEDURE

Refer to figure 1 (Note 1)

- Operating procedure varies with heat pump type and cooling only type. Contact your Daikin dealer to confirm your system type.
- To protect the unit, turn on the main power switch 6 hours before operation.
- If the main power supply is turned off during operation, operation will restart automatically after the power turns back on again.

COOLING, HEATING, AUTOMATIC, FAN, AND PROGRAM DRY OPERATION

Operate in the following order.

- AUTOMATIC OPERATION can be selected only by Heat pump split system or Heat recovery VRV system.
- For cooling only type, "COOLING", and "FAN" and "DRY" operation are able to select.

<<FOR SYSTEMS WITHOUT COOL/HEAT CHANGE OVER REMOTE CONTROL SWITCH>>

Refer to figure 1-1, 2 (Note 2)



Press OPERATION MODE SELECTOR button several times and select the OPERATION MODE of your choice as follows.

- COOLING OPERATION " ❄️ "
- HEATING OPERATION " ☀️ "

- AUTOMATIC OPERATION " 🔄 "

• In this operation mode, COOL/HEAT changeover is automatically conducted.

- FAN OPERATION..... " 🌀 "

- DRY OPERATION " 🏠 "

- The function of this program is to decrease the humidity in your room with the minimum temperature decrease.
- Micro computer automatically determines TEMPERATURE and FAN SPEED.
- This system does not go into operation if the room temperature is below 16°C.



Press ON/OFF button OPERATION lamp lights up or goes off and the system starts or stops OPERATION.

NOTE

- Do not turn OFF power immediately after the unit stops. Then, wait no less than 5 minutes. Water is leaking or there is something else wrong with the unit.

<<FOR SYSTEMS WITH COOL/HEAT CHANGE OVER REMOTE CONTROL SWITCH>>

Refer to figure 1-1,3 (Note 3)



(1) Select OPERATION MODE with the COOL/HEAT CHANGE OVER REMOTE CONTROL SWITCH as follows.

- COOLING OPERATION " ❄️ "





- HEATING OPERATION " ☀️ "



Note 1 : page 28, Note 2 : page 28, Note 3 : page 28

3PA63363-24W-5

- FAN OPERATION “  ”
- DRY OPERATION “  ”

- See “FOR SYSTEM WITHOUT COOL/HEAT CHANGEOVER REMOTE CONTROL SWITCH” for details on dry operation.

(2) Press OPERATION MODE SELECTOR button several times and select “  ”
(This operation is only available during dry operation.)



Press ON/OFF button

OPERATION lamp lights up or goes off and the system starts or stops OPERATION.

NOTE 

- Do not turn OFF power immediately after the unit stops. Then, wait no less than 5 minutes.
Water is leaking or there is something else wrong with the unit.

[EXPLANATION OF HEATING OPERATION]

DEFROST OPERATION

- As the frost on the coil of an outdoor unit increase, heating effect decreases and the system goes into DEFROST OPERATION.
- The fan operation stops and the DEFROST lamp of the indoor unit goes on. After 6 to 8 minutes (maximum 10 minutes) of DEFROST OPERATION, the system returns to HEATING OPERATION.

Heating capacity & Outdoor air temperature

- Heating capacity drops as outdoor air temperature lowers. If feeling cold, use another heater at the same time as this air conditioner.



- Hot air is circulated to warm the room. It will take some time from when the air conditioner is first started until the entire room becomes warm. The internal fan automatically turns at low speed until the air conditioner reaches a certain temperature on the inside. In this situation, all you can do is wait.
- If hot air accumulates on the ceiling and feet are left feeling cold, it is recommended to use a circulator. For details, contact the place of purchase.

ADJUSTMENT



For programming TEMPERATURE, FAN SPEED and AIR FLOW DIRECTION, follow the procedure shown below.

TEMPERATURE SETTING

Press TEMPERATURE SETTING button and program the setting temperature.

-  Each time this button is pressed, setting temperature rises 1°C.
-  Each time this button is pressed, setting temperature lowers 1°C.

In case of automatic operation

-  Each time this button is pressed, setting temperature shifts to “H” side.
-  Each time this button is pressed, setting temperature shifts to “L” side.

[°C]

	H	▪	M	▪	L
Setting temperature	25	23	22	21	19

- The setting is impossible for fan operation.

NOTE 

- The setting temperature range of the remote controller is 16°C to 32°C.

3PA63363-24W-6



FAN SPEED CONTROL

Press FAN SPEED CONTROL button. High or Low fan speed can be selected. The microchip may sometimes control the fan speed in order to protect the unit.

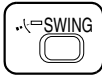

AIR FLOW DIRECTION ADJUST

UP AND DOWN DIRECTION

- The movable limit of the flap is changeable. Contact your Daikin dealer for details.

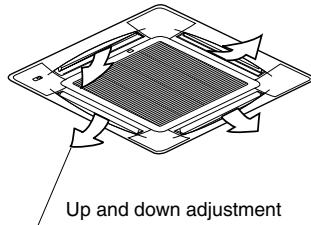

Press the AIR FLOW DIRECTION ADJUST button to select the air direction as shown below.

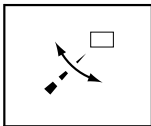

DISPLAY appears and the air flow direction continuously varies. (Automatic swing setting)



Press AIR FLOW DIRECTION ADJUST button to select the air direction of your choice.



DISPLAY vanishes the air flow direction is fixed (Fixed air flow direction setting).

MOVEMENT OF THE AIR FLOW FLAP

For the following conditions, micro computer controls the air flow direction so it may be different from the display.

Operation mode	Cooling	Heating
Operation conditions	<ul style="list-style-type: none"> When operating continuously at horizontal air flow direction 	<ul style="list-style-type: none"> When room temperature is higher than the set temperature At defrost operation (The flaps blow horizontally to avoid blowing cold air directly on the occupants of the room.)

NOTE

- If you try cooling or programmed drying, while the flaps are facing downward, air flow direction may change unexpectedly. There is nothing wrong with the equipment. This serves to prevent dew formed on parts in the air discharge outlet from dripping.
- Operation mode includes automatic operation.

PROGRAM TIMER OPERATION

Operate in the following order.

- The timer is operated in the following two ways.
 - Programming the stop time (⊕ · ○)
 - The system stops operating after the set time has elapsed.
 - Programming the start time (⊕ · |)
 - The system starts operating after the set time has elapsed.
- The timer can be programmed a maximum of 72 hours.
- The start and the stop time can be simultaneously programmed.



TIMER MODE START/STOP

Press the TIMER MODE START/STOP button several times and select the mode on the display.

The display flashes.



For setting the timer stop “⊕ · ○”

For setting the timer start “⊕ · |”

3PA63363-24W-7

2  **PROGRAMMING TIME**

Press the **PROGRAMMING TIME** button and set the time for stopping or starting the system.

-  When this button is pressed, the time advances by 1 hour.
-  When this button is pressed, the time goes backward by 1 hour.

3  **TIMER RESERVE**

Press the **TIMER RESERVE** button. The timer setting procedure ends. The display or changes from flashing light to a constant light.

4  **TIMER CANCEL**

Press the **TIMER OFF** button to cancel programming. The display vanishes.

For example.

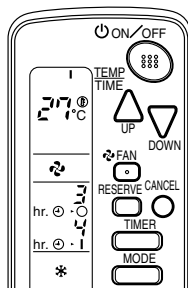

When the timer is programmed to stop the system after 3 hours and start the system after 4 hours, the system will stop after 3 hours and then 1 hour later the system will start.

NOTE

- When the timer is programmed to stop the system after 3 hours and start the system after 4 hours, the system will stop after 3 hours and then 1 hour later the system will start.
- After the timer is programmed, the display shows the remaining time.

HOW TO SET MASTER REMOTE CONTROLLER (For VRV system)

- When the system is installed as shown below, it is necessary to designate the master remote controller.

■ **For Heat pump system**

When one outdoor unit is connected with several indoor units.

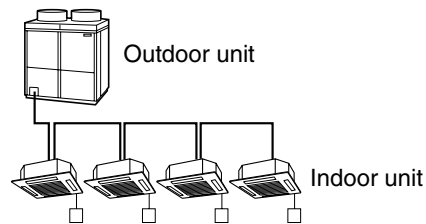

One of these remote controllers needs to be designated as the master remote controller.

■ **For Heat recovery system**

When one BS unit is connected with several indoor units.

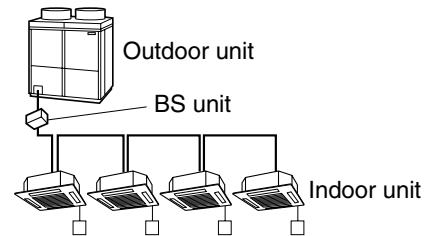

One of these remote controllers needs to be designated as the master remote controller.

- Only the master remote controller can select HEATING, COOLING or AUTOMATIC (only Heat recovery system) OPERATION.

3PA63363-24W-8

When the indoor unit with master remote controller is set to "COOL", you can switch over operation mode between "FAN", "DRY" and "COOL".

When the indoor unit with master remote controller is set to "HEAT", you can switch over operation mode between "FAN" and "HEAT".

When the indoor unit with master remote controller is set to "FAN", you cannot switch operation mode.

When attempting settings than that consented above, a "peep" is emitted as a warning.

Only with Heat recovery system, you can set the indoor unit to AUTOMATIC. Attempting to do so, a "peep" will be emitted as a warning.

How to designate the master remote controller

Operate in the following order.



1 Continuously press the OPERATION MODE SELECTOR button for 4 seconds.

The displays showing "⊕" of all slave indoor unit connected to the same outdoor unit or BS unit flash.



2 Press the OPERATION MODE SELECTOR button to the indoor unit that you wish to designate as the master remote controller. Then designation is completed. This indoor unit is designated as the master remote controller and the display showing "⊕" vanishes.

- To change settings, repeat steps ① and ②.

EMERGENCY OPERATION

When the remote controller does not work due to battery failure or the absence thereof, use this switch which is located beside the

discharge grille on the main unit. When the remote controller does not work, but the battery low indicator on it is not lit, contact your dealer.

[START]

1 To press the emergency operation switch.

The machine runs in the previous mode. The system operates with the previously set air flow direction.

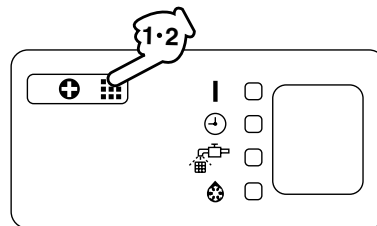

[STOP]

2 Press the EMERGENCY OPERATION switch again.

PRECAUTIONS FOR GROUP CONTROL SYSTEM OR TWO REMOTE CONTROLLER CONTROL SYSTEM

This system provides two other control systems beside individual control (one remote controller controls one indoor unit) system. Confirm the following if your unit is of the following control system type.

■ Group control system

One remote controller controls up to 16 indoor units.
All indoor units are equally set.

■ Two remote controller control system

Two remote controllers control one indoor unit. (In case of group control system, one group of indoor units)
The unit follows individual operation.

3PA63363-24W-9

NOTES 

- Cannot have two remote controller control system with only wireless remote controllers. (It will be a two remote controller control system having one wired and one wireless remote controllers.)
- Under two remote controller control system, wireless remote controller cannot control timer operation.
- Only the operating indicator lamp out of 3 other lamps on the indoor unit display functions.

NOTE 

- Contact your Daikin dealer in case of changing the combination or setting of group control and two remote controller control systems.

6. NOT MALFUNCTION OF THE AIR CONDITIONER

The following symptoms do not indicate air conditioner malfunction

I. THE SYSTEM DOES NOT OPERATE

- **The system does not restart immediately after the ON/OFF button is pressed.**
If the OPERATION lamp lights, the system is in normal condition. It does not restart immediately because a safety device operates to prevent overload of the system. After 3 minutes, the system will turn on again automatically.
- **The system does not restart immediately when TEMPERATURE SETTING button is returned to the former position after pushing the button.**
It does not restart immediately because a safety device operates to prevent overload of the system. After 3 minutes, the system will turn on again automatically.
- **If the reception beep is rapidly repeated 3 times (It sounds only twice when operating normally.)**

Control is set to the optional controller for centralized control.

- **If the defrost lamp on the indoor unit's display is lit when heating is started.**
This indication is to warn against cold air being blown from the unit. There is nothing wrong with the equipment.

7. HOW TO DIAGNOSE TROUBLE SPOTS

I. EMERGENCY STOP

When the air conditioner stops in emergency, the run lamp on the indoor unit starts blinking. Take the following steps yourself to read the malfunction code that appears on the display. Contact your dealer with this code. It will help pinpoint the cause of the trouble, speeding up the repair.



Press the **INSPECTION/TEST** button to select the inspection mode “”.

“” appears on display and blinks. “UNIT” lights up.



Press **PROGRAMMING TIMER BUTTON** and change the unit number.

Press to change the unit number until the indoor unit beeps and perform the following operation according to the number of beeps.

Number of beeps

3 short beeps Perform all steps from **3** to **6**.

1 short beep Perform **3** and **6** steps
1 long beep..... Normal state

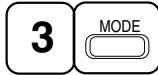

Press OPERATION MODE SELECTOR BUTTON

“” on the left-hand of the malfunction code blinks.



Press PROGRAMMING TIMER BUTTON and change the malfunction code.

Press until the indoor unit beeps twice.



Press OPERATION MODE SELECTOR BUTTON

“” on the right-hand of the malfunction code blinks.



Press PROGRAMMING TIMER BUTTON and change the malfunction code.

Press until the indoor unit makes a long beep.
The malfunction code is fixed when the indoor unit makes a long beep.



Reset of the display

Press OPERATION MODE SELECTOR BUTTON to get the display back to the normal state.

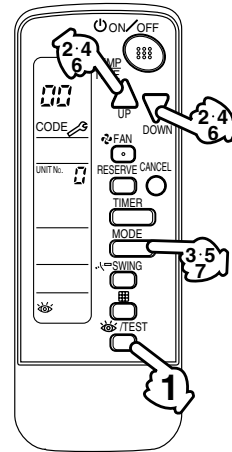

II. IN CASE BESIDES EMERGENCY STOP

1. The unit does not operate at all.

- Check if the receiver is exposed of sunlight or strong light. Keep receiver away from light.
- Check if there are batteries in the remote controller. Place the batteries.
- Check if the indoor unit number and wireless remote controller number are equal.

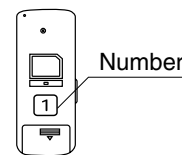
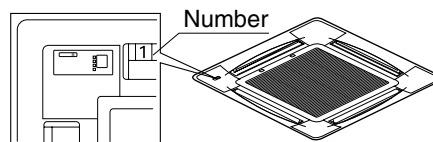

Operate the indoor unit with the remote controller of the same number.
Signal transmitted from a remote controller of a different number cannot be accepted. (If the number is not mentioned, it is considered as “1”)

3PA63363-24W-11

2. The system operates but it does not sufficiently cool or heat.

- If the set temperature is not proper.
- If the FAN SPEED is set to LOW SPEED.
- If the air flow angle is not proper.

Contact the place of purchase in the following case.

⚠ WARNING

When you detect a burning odor, shut OFF power immediately and contact the place of purchase. Using the equipment in anything but proper working condition can result in equipment damage, electric shock and/or fire.

[Trouble]

The RUN lamp of the indoor unit is flashing and the unit does not work at all.

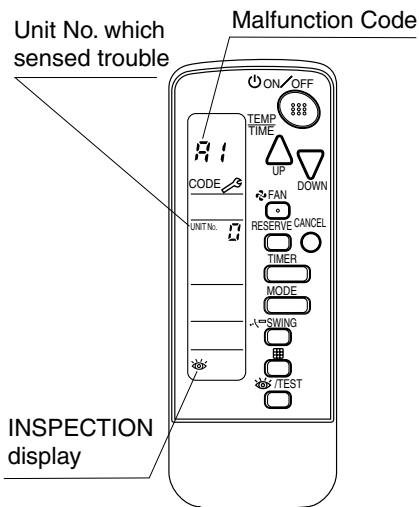

[Remedial action]





Check the malfunction code (A1 - UF) on the remote control and contact the place of purchase.



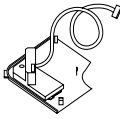

2.2.2 Installation

1. BEFORE INSTALLATION

1-1 ACCESSORIES

Check if the following accessories are included with your unit.

Name	Receiver	Wireless remote controller	Remote controller holder	Dry cell battery LR03 (AM4)	Unit No. label
Quantity	1 set.	1 pc.	1 pc.	2 pcs.	1 pc.
Shape					

Name	Screw for installing remote controller holder	Operation manual	Sealing pad	Binding band
Quantity	2 pcs.	1 pc.	1 pc.	2 pc.
Shape			 20 x 35	

1-2 NOTE TO THE INSTALLER

- Be sure to instruct the customer how to properly operate the system showing him/her the attached operation manual.

2. REMOTE CONTROLLER INSTALLATION

(Installing wireless remote controller)

- Do not throw the remote controller or impose large shocks. Also, do not store where it may be exposed to moisture or direct sunlight.
- When operating, point the transmitting part of the remote controller in the direction of the receiver.
- The direct transmitting distance of the remote controller is approximately 7 meters.
- The signal cannot be transmitted if something such as curtains blocks the receiver and the remote controller.

• Installing to a wall or a pillar

Slide the remote controller into the remote controller holder from the top.

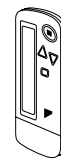

Fix the remote controller holder with the screws.

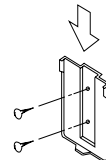

C: 3PA59585-23Y-2

• **How to insert the batteries**

1. Open the back cover of the remote controller by sliding it in the direction of the arrow.

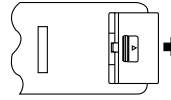

2. Insert the attached dry cell batteries. Properly insert, set the batteries by matching the (+) and (-) polarity marks as indicated. Then close the cover as before.

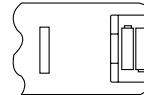

3. RECEIVER INSTALLATION

(1) Preparations before installation

Install this kit after installing the decoration panel.

1. Remove the suction grille and the air filter according to the instructions in the installation manual attached to the decoration panel.
2. Remove the control box lid according to the instructions in the installation manual attached to the indoor unit.

(2) Determination of address and MAIN/SUB remote controller.

If setting multiple wireless remote controllers to operate in one room, perform address setting for the receiver and the wireless remote controller.

If setting multiple wired remote controllers in one room, change the MAIN/SUB switch of the receiver.

SETTING PROCEDURE

1. Setting the receiver

Through the small opening on the back of the receiver, set the wireless address switch (SS2) on the printed circuit board according to the table below.

Unit No.	No. 1	No. 2	No. 3
Wireless address switch (SS2)			

When using both a wired and a wireless remote controller for 1 indoor unit, the wired controller should be set to MAIN. Therefore, set the MAIN/SUB switch (SS1) of the receiver to SUB.

	MAIN	SUB
MAIN/SUB switch (SS1)		

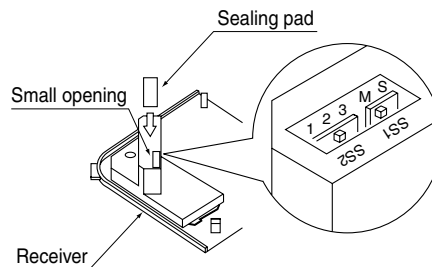

After completing setting, seal off the opening of the address switch and the MAIN/SUB switch with the attached sealing pad.

C: 3PA59585-23Y-3

2. Setting the address of wireless remote controller (It is factory set to “1”)

(Setting from the remote controller)

1. Hold down the button and the button for at least 4 seconds to get the Field Set mode. (Indicated in the display area in the figure at right.)
2. Press the button and select a multiple setting (A/b). Each time the button is pressed the display switches between “A” and “b”.
3. Press the “” button and “” button to set the address.

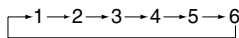

Address can be set from 1 to 6, but set it to 1 ~ 3 and to same address as the receiver. (The receiver does not work with address 4 ~ 6.)

4. Press the button to enter the setting.
5. Hold down the button for at least 1 second to quit the Field Set mode and return to the normal display.

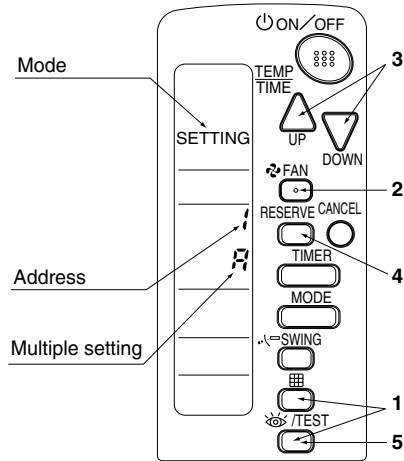

Multiple settings A/b

When the indoor unit is being operating by outside control (central remote controller, etc.), it sometimes does not respond to ON/OFF and temperature setting commands from this remote controller. Check what setting the customer wants and make the multiple setting as shown below.

Remote controller		Movement when the operation is controlled by the other air conditioners and equipment
Multiple setting	Remote controller display	
A: Standard	All items displayed.	When operation changeover, temperature setting or the like is carried out from the remote controller, the indoor unit rejects the instruction. (Signal receiving sound “peeh” or “pick-pick-pick”) As a result, a discrepancy between the operation state of the indoor unit and the indication of the remote controller display occurs.
b: Multi System	Operations remain displayed shortly after execution.	Since the indication of the remote controller is turned off, no discrepancy such as mentioned above occurs.

3. Stick the Unit No. label on the air outlet of the decoration panel and the back of the wireless remote controller.

[PRECAUTIONS]

Set the Unit No. of the receiver and the wireless remote controller to be equal. If the settings differs, the signal from the remote controller cannot be transmitted.

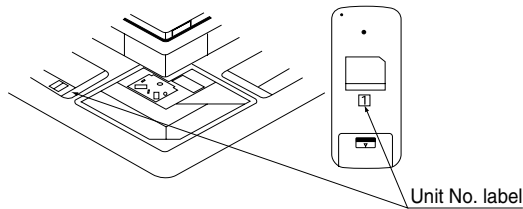

C: 3PA59585-23Y-4

(3) Receiver installation

1. Detach the decorative corner panel diagonally opposite to swing motor. This corner panel piece is not needed hereafter. (For instructions on attaching/ detaching decorative panels, see the installation manual provided with the original panel.)

The receiver cannot be installed anywhere but in this corner.

2. Pull the relay harness from the receiver up to where the clamp meets the stopper, as shown at right.
3. Install the receiver where the decorative corner panel before. Proceed in the oppsite order in which you removed the corner panel.
4. Fit the relay harness under the tab as shown at right and connect it to connector X24A on the indoor unit PC board. Bundle the remaining harness with the included binding band so that it does not droop or get pinched in the suction grille. **Use the included binding band to prevent the relay harness from sagging down and getting caught in the suction grill.**
5. Attach the lid to the indoor unit's switch box and the suction grille to the decorative panel.

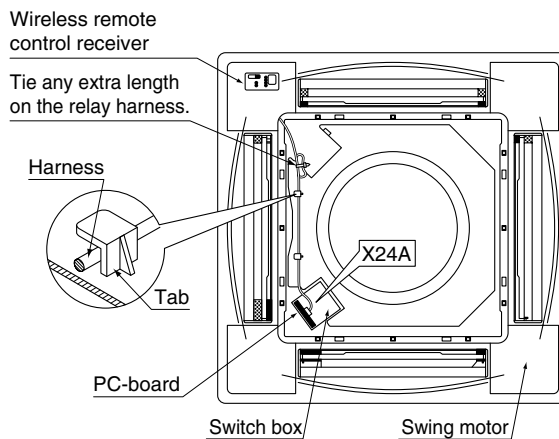
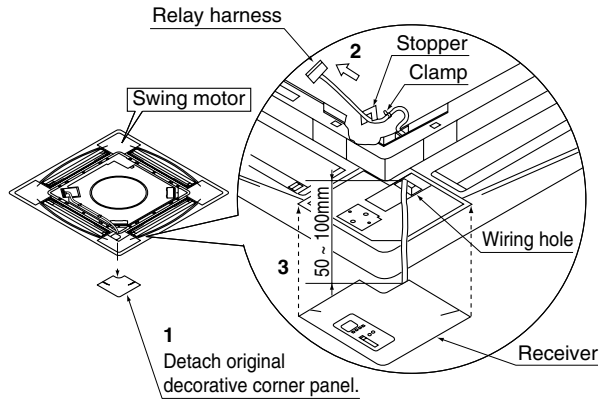

4. FIELD SETTING

If optional accessories are mounted on the indoor unit, the indoor unit setting may have to be changed. Refer to the instruction manual (optional hand book) for each optional accessory.

Procedure

1. When in the normal mode, press the button for a minimum of four seconds, and the FIELD SET MODE is entered.
2. Select the desired MODE NO. with the button.
3. Push the “” button and select the FIRST CODE NO.
4. Push the “” button and select the SECOND CODE NO.
5. Push the button and the present settings are SET.
6. Push the button to return to the NORMAL MODE.

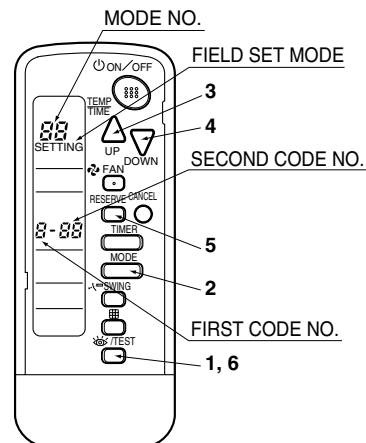

C: 3PA59585-23Y-5

(Example)

If the time to clean air filter is set to "Filter Contamination-Heavy", set Mode No. to "10", FIRST CODE NO. to "0", and SECOND CODE NO. to "02".

MODE NO.	FIRST CODE NO.	DESCRIPTION OF SETTING	SECOND CODE NO. NOTE)				
			01	02	03		
10	0	Filter Contamination-Heavy/Light (Setting for spacing time of display time to clean air filter) (Setting for when filter contamination is heavy, and spacing time of display time to clean air filter is to be halved)	Ultra-long-life type	approx. 10,000 hours	approx. 5,000 hours	-	
		Long-life type	light	approx. 2,500 hours	heavy		approx. 1,250 hours
		Standard type		approx. 200 hours			approx. 100 hours
	1	Long-life filter type (Setting of filter sign indication time) (Change setting when Ultra-long-life filter is installed)		Long-life filter	Ultra-long-life filter (1)	-	
	3	Spacing time of display time to clean air filter count (Setting for when the filter sign is not to be displayed)		Display	Do not display	-	
11 (Split system)	0	Setting the number of connected simultaneous operation system indoor units.		Pair	Twin	Triple	
12 (VRV system)	1	ON/OFF input from outside (Set to enable starting/stopping from remote.)		Forced OFF input	ON/OFF	-	
	2	Thermostat differential changeover (Set when using remote controller thermostat sensor.)		1°C	0.5°C	-	
13	0	High ceiling setting (Setting for when installed in a ceiling higher than 2.7 m)		Normal	High Ceiling 1	High Ceiling 2	
	1	Selection of Air Flow Direction (Setting for when a blocking pad kit has been installed)		F	T	W	
	4	Air Flow Direction Range Setting		Upper	Normal	-	

NOTE 

The SECOND CODE NO. is factory set to "01". However, for the following cases it is set to "02".

Air Flow Direction Range Setting

Do not use any settings not listed in the table.

For group control with a wireless remote controller, initial settings for all the indoor units of the group are equal.

(For group control, refer to the installation manual attached to the indoor unit for group control.)





C: 3PA59585-23Y-6

5. TEST OPERATION

Perform test operation according to the instructions in the installation manual attached to the indoor unit.
After refrigerant piping, drain piping, and electric wiring, operate according to the table to protect the unit.

[PRECAUTIONS]

1. Refer to malfunction diagnosis label attached to the unit if it does not operate.
2. Refer to the installation manual attached to the outdoor unit for individual operation system types.

Order	Operation
(1)	Open gas side stop valve.
(2)	Open liquid side stop valve.
(3)	Electrify crank case heater for 6 hours. (Not necessary for cooling type units)
(4)	Set to cooling with the remote controller and push  button to start operation.
(5)	Push  button twice and operate in TEST OPERATION mode for 3 minutes.
(6)	Push  button and confirm its operation.
(7)	Push  button and operate normally.
(8)	Confirm its function according to the operation manual.

C: 3PA59585-23Y-7