

## 2.3 BRC7F634F / BRC7F635F (For FXFQ-P)

### 2.3.1 Features

BRC7F634F (for Heat Pump)  
BRC7F635F (for Cooling Only)

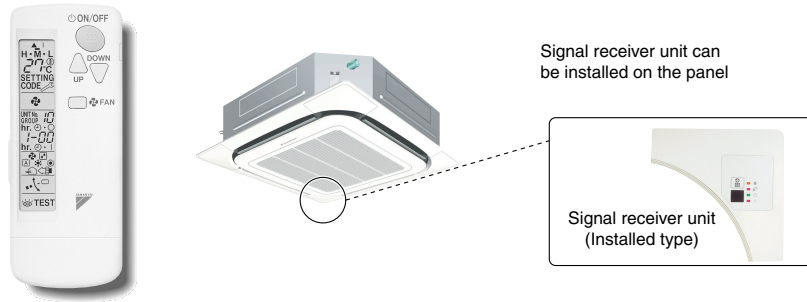

- The same operation modes and settings as with wired remote controllers are possible.
- A light receiver unit for a Ceiling Mounted Cassette (Round Flow) type is mounted into the indoor unit.
- This unit supports the three-speed airflow rate control (HH / H / L).

### 2.3.2 Function

Model	BRC7F634F/635F
ON/OFF	Possible
Temp. setting	Possible
Air flow rate setting	Possible
Air flow direction setting	Possible
Timer setting	Possible
Mode setting	Possible
Filter sign reset	Possible
Inspection/Test operation	Possible

2.3.3 Dimensions

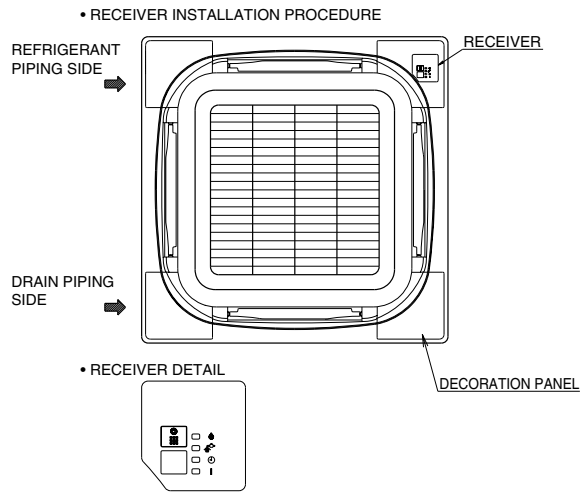
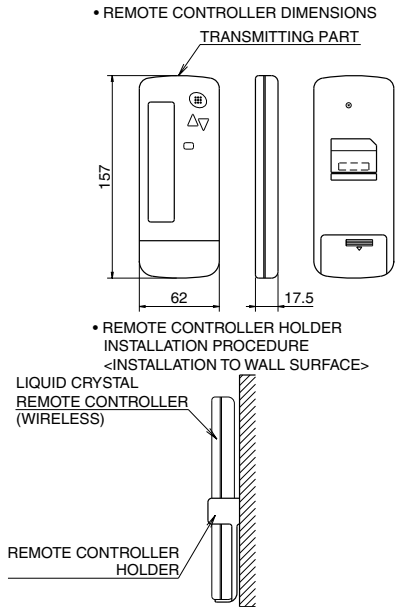

• WIRELESS REMOTE CONTROLLER KIT FOR EACH DECORATION PANEL

WIRELESS REMOTE CONTROLLER KIT		DECORATION PANEL
BRC7F632F	BRC7F634F BRC7F635F	BYCP125K-W1

3D052918B

2.3.4 Operation Manual

■ Names and Functions of the Operating Section

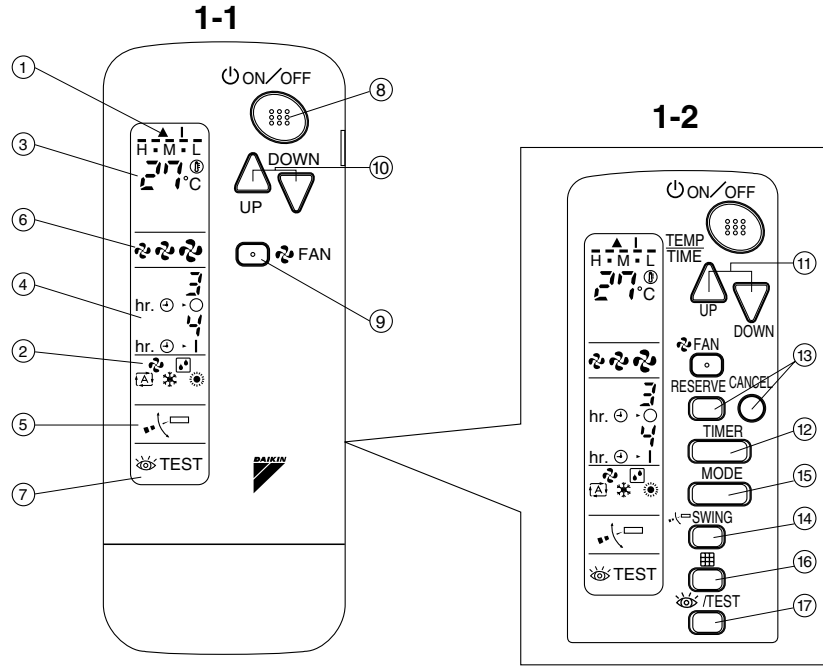

1



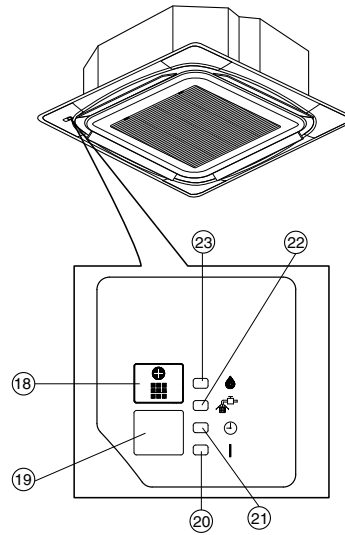
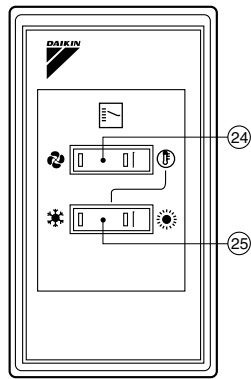











COOL/HEAT CHANGEOVER  
REMOTE CONTROL SWITCH







1-3

2

See Fig. 1, 2

1	<b>DISPLAY “▲” (SIGNAL TRANSMISSION)</b> This lights up when a signal is being transmitted.
2	<b>DISPLAY “ “ “ “ “” (OPERATION MODE)</b> This display shows the current OPERATION MODE. For cooling only type, “  ” (Auto) and “  ” (Heating) are not installed.
3	<b>DISPLAY “” (SET TEMPERATURE)</b> This display shows the set temperature.
4	<b>DISPLAY “ hr.  hr.” (PROGRAMMED TIME)</b> This display shows PROGRAMMED TIME of the system start or stop.
5	<b>DISPLAY “” (AIR FLOW FLAP)</b> Refer to page 56.
6	<b>DISPLAY “ “ “” (FAN SPEED)</b> The display shows the set fan speed.
7	<b>DISPLAY “ TEST” (INSPECTION/ TEST OPERATION)</b> When the INSPECTION/TEST OPERATION BUTTON is pressed, the display shows the system mode is in.
8	<b>ON/OFF BUTTON</b> Press the button and the system will start. Press the button again and the system will stop.
9	<b>FAN SPEED CONTROL BUTTON</b> Press this button to select the fan speed, HH, H, L of your choice.
10	<b>TEMPERATURE SETTING BUTTON</b> Use this button for SETTING TEMPERATURE (Operates with the front cover of the remote controller closed.)
11	<b>PROGRAMMING TIMER BUTTON</b> Use this button for programming “START and/or STOP” time. (Operates with the front cover of the remote controller opened.)
12	<b>TIMER MODE START/STOP BUTTON</b> Refer to page 57.
13	<b>TIMER RESERVE/CANCEL BUTTON</b> Refer to page 57.
14	<b>AIR FLOW DIRECTION ADJUST BUTTON</b> Refer to page 56.
15	<b>OPERATION MODE SELECTOR BUTTON</b> Press this button to select OPERATION MODE.
16	<b>FILTER SIGN RESET BUTTON</b> Refer to the section of MAINTENANCE in the operation manual attached to the indoor unit.
17	<b>INSPECTION/TEST OPERATION BUTTON</b> This button is used only by qualified service persons for maintenance purposes.
18	<b>EMERGENCY OPERATION SWITCH</b> This switch is readily used if the remote controller does not work.
19	<b>RECEIVER</b> This receives the signals from the remote controller.
20	<b>OPERATING INDICATOR LAMP (Red)</b> This lamp stays lit while the air conditioner runs. It flashes when the unit is in trouble.
21	<b>TIMER INDICATOR LAMP (Green)</b> This lamp stays lit while the timer is set.
22	<b>AIR FILTER CLEANING TIME INDICATOR LAMP (Red)</b> Lights up when it is time to clean the air filter.
23	<b>DEFROST LAMP (Orange)</b> Lights up when the defrosting operation has started. (For cooling only type this lamp does not turn on.)

24	<b>FAN/AIR CONDITIONING SELECTOR SWITCH</b>
	Set the switch to “  ” (FAN) for FAN and “  ” (A/C) for HEAT or COOL.
25	<b>COOL/HEAT CHANGEOVER SWITCH</b>
	Set the switch to “  ” (COOL) for COOL and “  ” (HEAT) for HEAT.

**NOTES**

- For the sake of explanation, all indications are shown on the display in Figure 1 contrary to actual running situations.
- Fig. 1-2 shows the remote controller with the front cover opened.
- Fig. 1-3 shows this remote controller can be used in conjunction with the one provided with the VRV system.
- If the air filter cleaning time indicator lamp lights up, clean the air filter as explained in the operation manual provided with the indoor unit.  
After cleaning and reinstalling the air filter, press the filter sign reset button on the remote controller. The air filter cleaning time indicator lamp on the receiver will go out.
- The Defrost Lamp will flash when the power is turned on. This is not a malfunction.

### ■ Handling for Wireless Remote Controller

#### Precautions in handling remote controller

**Direct the transmitting part of the remote controller to the receiving part of the air conditioner.**

If something blocks the transmitting and receiving path of the indoor unit and the remote controller as curtains, it will not operate.

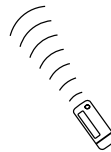
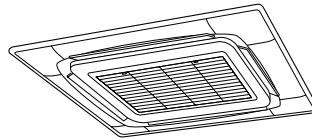

2 short beeps from the receiver indicates that the transmission is properly done.

**Transmitting distance is approximately 7 m.**

**Do not drop or get it wet.**

It may be damaged.

**Never press the button of the remote controller with a hard, pointed object.**

The remote controller may be damaged.

#### Installation site

- It is possible that signals will not be received in rooms that have electronic fluorescent lighting. Please consult with the salesman before buying new fluorescent lights.
- If the remote controller operated some other electrical apparatus, move that machine away or consult your dealer.

**Placing the remote controller in the remote controller holder**

Install the remote controller holder to a wall or a pillar with the attached screw. (Make sure it transmits)

**Placing the remote controller**

Slide from above

**Removing the remote controller**

Pull it upward

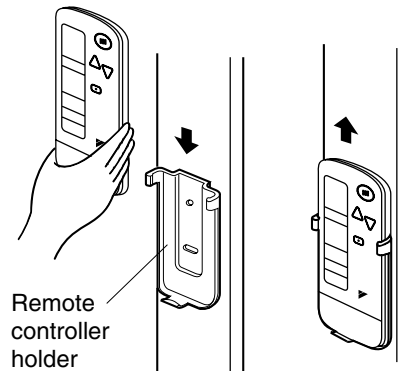
**How to put the dry batteries**

- (1) Remove the back cover of the remote controller to the direction pointed by the arrow mark.
- (2) Put the batteries  
Use two LR03<IEC> dry cell batteries.  
Put dry batteries correctly to fit their (+) and (-).
- (3) Close the cover

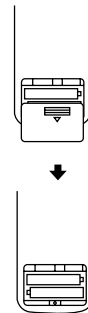
**When to change batteries**

Under normal use, batteries last about a year. However, change them whenever the indoor unit doesn't respond or responds slowly to commands, or if the display becomes dark.

**[CAUTIONS]**

- Replace all batteries at the same time, do not use new and old batteries intermixed.
- In case the remote controller is not used for a long time take out all batteries in order to prevent liquid leak of the battery.

**IN THE CASE OF CENTRALIZED CONTROL SYSTEM**

If the indoor unit is under centralized control, it is necessary to switch the remote controller's setting. In this case, contact your DAIKIN dealer.

## ■ Operation Range

### Split System

If the temperature or the humidity is beyond the following conditions, safety devices may work and the air conditioner may not operate, or sometimes, water may drop from the indoor unit.

#### COOLING [°C]

INDOOR		HUMIDITY	OUTDOOR TEMPERATURE	
TEMPERATURE			DB	
DB	21 to 35	80% or below	DB	- 5 to 50
WB	14 to 25			

#### HEATING [°C]

INDOOR TEMPERATURE		OUTDOOR TEMPERATURE	
DB	15 to 27	DB	- 14 to 21
		WB	- 15 to 15.5

DB : Dry bulb temperature

WB: Wet bulb temperature

The setting temperature range of the remote controller is 16°C to 32°C.

### VRV System

See the operation manual provided with the air conditioner.

## ■ Operation Procedure

### Refer to figure 1 on page 49

- Operating procedure varies with heat pump type and cooling only type. Contact your Daikin dealer to confirm your system type.
- To protect the unit, turn on the main power switch 6 hours before operation.
- If the main power supply is turned off during operation, operation will restart automatically after the power turns back on again.

### COOLING, HEATING, AUTOMATIC, FAN, AND PROGRAM DRY OPERATION

Operate in the following order.

- AUTOMATIC OPERATION can be selected only by Heat pump split system or Heat recovery VRV system.
- For cooling only type, "COOLING", and "FAN" and "DRY" operation are able to select.

#### (1) For Systems Without Cool / Heat Changeover Remote Control Switch

Refer to figure 1-1, 2 on page 49



### OPERATION MODE SELECTOR

Press OPERATION MODE SELECTOR button several times and select the OPERATION MODE of your choice as follows.

- COOLING OPERATION..... "❄"
  - The function of this program is to decrease the humidity in your room with the minimum temperature decrease.
- HEATING OPERATION..... "☀"
  - The set point is the air temperature when starting operation by dry operation.
  - Micro computer automatically determines TEMPERATURE and FAN SPEED.
  - This system does not go into operation if the room temperature is below 16°C.
- AUTOMATIC OPERATION ..... "🔄"
  - In this operation mode, COOL/HEAT changeover is automatically conducted.
- FAN OPERATION ..... "🌀"
  - The function of this program is to decrease the humidity in your room with the minimum temperature decrease.
- DRY OPERATION..... "🏠"
  - The function of this program is to decrease the humidity in your room with the minimum temperature decrease.
  - The set point is the air temperature when starting operation by dry operation.
  - Micro computer automatically determines TEMPERATURE and FAN SPEED.
  - This system does not go into operation if the room temperature is below 16°C.



**ON/OFF**

**Press ON/OFF button.**

OPERATION lamp lights up or goes off and the system starts or stops OPERATION.

**NOTE**





- Do not turn OFF power immediately after the unit stops. Then, wait no less than 5 minutes. Water is leaking or there is something else wrong with the unit.

**(2) For Systems with Cool/Heat Changeover Remote Control Switch**  
Refer to figure 1-1,3 on page 49



**OPERATION MODE SELECTOR**

**(1) Select OPERATION MODE with the COOL/HEAT CHANGEOVER REMOTE CONTROL SWITCH as follows.**

- COOLING OPERATION..... “  ”
- HEATING OPERATION..... “  ”
- FAN OPERATION..... “  ”
- DRY OPERATION..... “  ”

- See “FOR SYSTEM WITHOUT COOL/HEAT CHANGEOVER REMOTE CONTROL SWITCH” for details on dry operation.

**(2) Press OPERATION MODE SELECTOR button several times and select “  ”.**  
(This operation is only available during dry operation.)



**ON/OFF**

**Press ON/OFF button.**

OPERATION lamp lights up or goes off and the system starts or stops OPERATION.

- The fan may keep on running for about 1 minute after the heating operation stops for removing the heat in the indoor unit.
- The air flow rate may be adjusted automatically depending on the room temperature or the fan may stop immediately. This is not a malfunction.

**NOTE**

- Do not turn OFF power immediately after the unit stops. Then, wait no less than 5 minutes. Water is leaking or there is something else wrong with the unit.

**[EXPLANATION OF HEATING OPERATION]**

- For general heating operation, it may take longer to reach the set temperature than in cooling operation. We recommend starting the operation which was used before using timer operation.

**DEFROST OPERATION**

- As the frost on the coil of an outdoor unit increase, heating effect decreases and the system goes into DEFROST OPERATION.
- The fan operation stops and the DEFROST lamp of the indoor unit goes on. After 6 to 8 minutes (maximum 10 minutes) of DEFROST OPERATION, the system returns to HEATING OPERATION.



**Heating capacity & Outdoor air temperature**

- Heating capacity drops as outdoor air temperature lowers. If feeling cold, use another heater at the same time as this air conditioner.
- Hot air is circulated to warm the room. It will take some time from when the air conditioner is first started until the entire room becomes warm. The internal fan automatically turns at low speed until the air conditioner reaches a certain temperature on the inside. In this situation, all you can do is wait.
- If hot air accumulates on the ceiling and feet are left feeling cold, it is recommended to use a circulator. For details, contact the place of purchase.

**(3) Adjustment**

For programming TEMPERATURE, FAN SPEED and AIR FLOW DIRECTION, follow the procedure shown below.

**TEMPERATURE SETTING**

Press **TEMPERATURE SETTING** button and program the setting temperature.

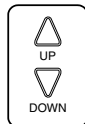

Each time this button is pressed, setting temperature rises 1°C.

Each time this button is pressed, setting temperature lowers 1°C.

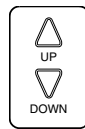
**In case of automatic operation**

Each time this button is pressed, setting temperature shifts to "H" side.

Each time this button is pressed, setting temperature shifts to "L" side.

[°C]

	H	•	M	•	L
Setting temperature	25	23	22	21	19

- The setting is impossible for fan operation.

**NOTE** 

- The setting temperature range of the remote controller is 16°C to 32°C.

**FAN SPEED CONTROL**

Press **FAN SPEED CONTROL** button.

Fan speed (HH, H, L) can be selected.

The microchip may sometimes control the fan speed in order to protect the unit.



**AIR FLOW DIRECTION ADJUST**

**UP AND DOWN DIRECTION**

- The movable limit of the flap is changeable. Contact your Daikin dealer for details.

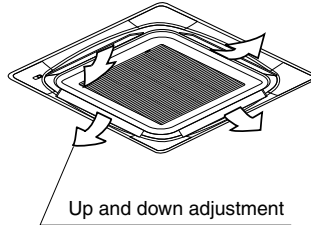

Press the AIR FLOW DIRECTION ADJUST button to select the air direction as shown below.

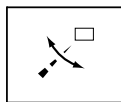

DISPLAY appears and the air flow direction continuously varies. (Automatic swing setting)



Press AIR FLOW DIRECTION ADJUST button to select the air direction of your choice.



DISPLAY vanishes the air flow direction is fixed (Fixed air flow direction setting).

**MOVEMENT OF THE AIR FLOW FLAP**

For the following conditions, micro computer controls the air flow direction so it may be different from the display.

Operation mode	Cooling	Heating
Operation conditions	<ul style="list-style-type: none"> <li>● When operating continuously at horizontal air flow direction</li> </ul>	<ul style="list-style-type: none"> <li>● When room temperature is higher than the set temperature</li> <li>● At defrost operation (The flaps blow horizontally to avoid blowing cold air directly on the occupants of the room.)</li> </ul>

**NOTES**

- If you try cooling or programmed drying, while the flaps are facing downward, air flow direction may change unexpectedly. There is nothing wrong with the equipment. This serves to prevent dew formed on parts in the air discharge outlet from dripping.
- Operation mode includes automatic operation.

**(4) Program Timer Operation**

Operate in the following order.

- The timer is operated in the following two ways.
  - Programming the stop time ( ⊕ - ○ )
    - .... The system stops operating after the set time has elapsed.
  - Programming the start time ( ⊕ - | )
    - .... The system starts operating after the set time has elapsed.
- The timer can be programmed a maximum of 72 hours.
- The start and the stop time can be simultaneously programmed.



### 1 TIMER MODE START/STOP

Press the **TIMER MODE START/STOP** button several times and select the mode on the display.

The display flashes.

For setting the timer stop .... “ ⊕ > ○ ”

For setting the timer start .... “ ⊕ > | ”



### 2 PROGRAMMING TIME

Press the **PROGRAMMING TIME** button and set the time for stopping or starting the system.

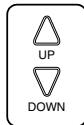

When this button is pressed, the time advances by 1 hour.

When this button is pressed, the time goes backward by 1 hour.



### 3 TIMER RESERVE

Press the **TIMER RESERVE** button.

The timer setting procedure ends.

The display or changes from flashing light to a constant light.



### 4 TIMER CANCEL

Press the **TIMER OFF** button to cancel programming. The display vanishes.

**For example.**

When the timer is programmed to stop the system after 3 hours and start the system after 4 hours, the system will stop after 3 hours and then 1 hour later the system will start.

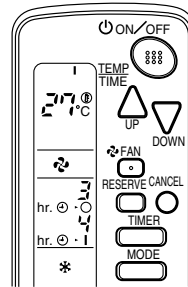

#### NOTES

- When the timer is programmed to stop the system after 3 hours and start the system after 4 hours, the system will stop after 3 hours and then 1 hour later the system will start.
- After the timer is programmed, the display shows the remaining time.

**(5) How to Set Master Remote Controller (For VRV System)**

- When the system is installed as shown below, it is necessary to designate the master remote controller.

**■ For Heat pump system**

When one outdoor unit is connected with several indoor units.

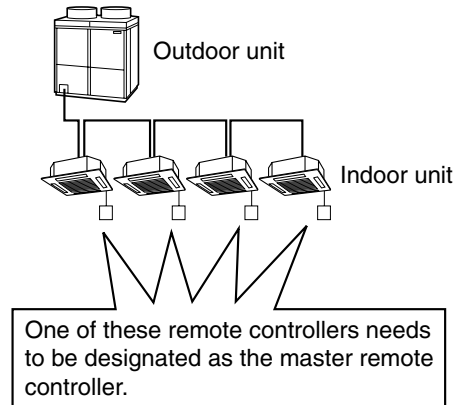
**■ For Heat recovery system**

When one BS unit is connected with several indoor units.

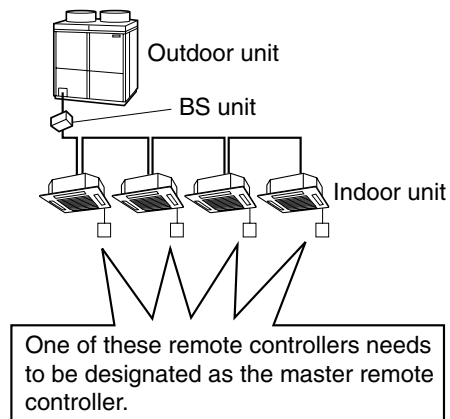

- Only the master remote controller can select HEATING, COOLING or AUTOMATIC (only Heat recovery system) OPERATION.

When the indoor unit with master remote controller is set to "COOL", you can switch over operation mode between "FAN", "DRY" and "COOL".

When the indoor unit with master remote controller is set to "HEAT", you can switch over operation mode between "FAN" and "HEAT".

When the indoor unit with master remote controller is set to "FAN", you cannot switch operation mode.

When attempting settings than that consented above, a "peep" is emitted as a warning.

Only with Heat recovery system, you can set the indoor unit to AUTOMATIC. Attempting to do so, a "peep" will be emitted as a warning.

**How to designate the master remote controller**

Operate in the following order.



Continuously press the OPERATION MODE SELECTOR button for 4 seconds.

The displays showing “⊕” of all slave indoor unit connected to the same outdoor unit or BS unit flash.



Press the OPERATION MODE SELECTOR button to the indoor unit that you wish to designate as the master remote controller. Then designation is completed. This indoor unit is designated as the master remote controller and the display showing “⊕” vanishes.

- To change settings, repeat steps ① and ②.

#### (6) Emergency Operation

When the remote controller does not work due to battery failure or the absence thereof, use this switch which is located beside the discharge grille on the main unit. When the remote controller does not work, but the battery low indicator on it is not lit, contact your dealer.

#### [START]



To press the emergency operation switch.

The machine runs in the previous mode.  
The system operates with the previously set air flow direction.

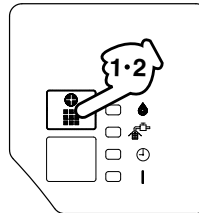

#### [STOP]



Press the EMERGENCY OPERATION switch again.

#### (7) Precautions for Group Control System or Two Remote Controller Control System

This system provides two other control systems beside individual control (one remote controller controls one indoor unit) system. Confirm the following if your unit is of the following control system type.

##### ■ Group control system

One remote controller controls up to 16 indoor units.  
All indoor units are equally set.

##### ■ Two remote controller control system

Two remote controllers control one indoor unit. (In case of group control system, one group of indoor units)  
The unit follows individual operation.

#### NOTES

- Cannot have two remote controller control system with only wireless remote controllers. (It will be a two remote controller control system having one wired and one wireless remote controllers.)
- Under two remote controller control system, wireless remote controller cannot control timer operation.
- Only the operating indicator lamp out of 3 other lamps on the indoor unit display functions.

**NOTE** 

- Contact your Daikin dealer in case of changing the combination or setting of group control and two remote controller control systems.

## ■ Not Malfunction of the Air Conditioner

The following symptoms do not indicate air conditioner malfunction

### I. THE SYSTEM DOES NOT OPERATE

- **The system does not restart immediately after the ON/OFF button is pressed.**  
If the OPERATION lamp lights, the system is in normal condition. It does not restart immediately because a safety device operates to prevent overload of the system. After 3 minutes, the system will turn on again automatically.
- **The system does not restart immediately when TEMPERATURE SETTING button is returned to the former position after pushing the button.**  
It does not restart immediately because a safety device operates to prevent overload of the system. After 3 minutes, the system will turn on again automatically.
- **If the reception beep is rapidly repeated 3 times (It sounds only twice when operating normally.)**  
Control is set to the optional controller for centralized control.
- **If the defrost lamp on the indoor unit's display is lit when heating is started.**  
This indication is to warn against cold air being blown from the unit. There is nothing wrong with the equipment.

### II. THE UNIT STOPS ONCE IN A WHILE

- **The remote controller indicates "U4" and "U5", the unit stops. Within several minutes the unit restarts.**  
Due to electrical noise other than that from the air conditioner, the communication between the units is cut off and the unit stops.  
When the noise is gone, the unit automatically restarts.

### III. NO CHANGE OVER IS AVAILABLE BETWEEN HEATING AND COOLING MODES

- **The indoor unit makes a "PEEE" receiving sound.**  
When operation changeover is under control, the control is set to the mode that cannot be carried out.

### IV. AIR FLOW RATE CANNOT BE OBTAINED AS SET

- **Even if the air flow rate adjusting button is pressed, the air flow rate does not change.**  
When the room temperature reaches the indoor unit set temperature, the outdoor unit stops and the air flow rate of indoor unit drops to the minimum.  
This is to avoid the cold air from getting in contact with the people in the room.

### V. AIR DISCHARGE DIRECTION IS NOT AS SET

- **The remote controller indication and the air discharge direction is not the same.**  
**Air discharge direction swing is impossible.**  
Because it is controlled by microcomputer. Refer to "AIR FLOW DIRECTION ADJUST" on page 56.

### VI. ONLY A PART OF INDICATION SHOWS

- **Even if the unit is operated, only the operation indication shows, or even if the indication shows, soon after, the indication other than that for operation disappears.**  
The corresponding indoor unit is that for multi-system and the remote controller is set to the multi-system.

### VII. NO INDICATION SHOWS OR ALL INDICATION SHOW

- **When the remote controller button is pressed.**  
The battery is dead.

### VIII. INSUFFICIENT COOLING

- **It is in program dry operation.**  
The program dry operation is an operation mode trying to keep the room temperature constant as much as possible. Refer to "Cooling, Heating, Automatic, Fan and Program dry operation" on page 53.

## ■ How to Diagnose Trouble Spots

### I. EMERGENCY STOP

When the air conditioner stops in emergency, the run lamp on the indoor unit starts blinking. Take the following steps yourself to read the malfunction code that appears on the display. Contact your dealer with this code. It will help pinpoint the cause of the trouble, speeding up the repair.



**Press the INSPECTION/TEST button to select the inspection mode "G".**  
"G" appears on display and blinks. "UNIT" lights up.



**Press PROGRAMMING TIMER BUTTON and change the unit number.**

Press to change the unit number until the indoor unit beeps and perform the following operation according to the number of beeps.

**Number of beeps**

3 short beeps ..... Perform all steps from (3) to (6) .

1 short beep ..... Perform (3) and (6) steps

1 long beep ..... Normal state



**Press OPERATION MODE SELECTOR BUTTON.**

"G" on the left-hand of the malfunction code blinks.



**Press PROGRAMMING TIMER BUTTON and change the malfunction code.**

Press until the indoor unit beeps twice.



**Press OPERATION MODE SELECTOR BUTTON.**

"G" on the right-hand of the malfunction code blinks.



**Press PROGRAMMING TIMER BUTTON and change the malfunction code.**

Press until the indoor unit makes a long beep.

The malfunction code is fixed when the indoor unit makes a long beep.



### Reset of the display

Press OPERATION MODE SELECTOR BUTTON to get the display back to the normal state.

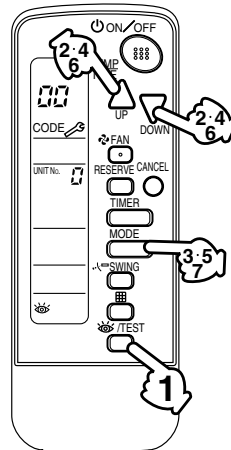

## II. IN CASE BESIDES EMERGENCY STOP

### 1. The unit does not operate at all.

- Check if the receiver is exposed of sunlight or strong light. Keep receiver away from light.
- Check if there are batteries in the remote controller. Place the batteries.
- Check if the indoor unit number and wireless remote controller number are equal.

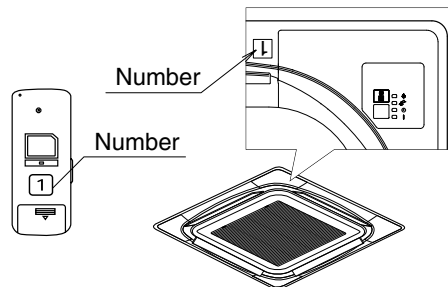

Operate the indoor unit with the remote controller of the same number.

Signal transmitted from a remote controller of a different number cannot be accepted. (If the number is not mentioned, it is considered as "1")

### 2. The system operates but it does not sufficiently cool or heat.

- If the set temperature is not proper.
- If the FAN SPEED is set to LOW SPEED.
- If the air flow angle is not proper.

Contact the place of purchase in the following case.



### WARNING

When you detect a burning odor, shut OFF power immediately and contact the place of purchase. Using the equipment in anything but proper working condition can result in equipment damage, electric shock and/or fire.



**[Trouble]**

The RUN lamp of the indoor unit is flashing and the unit does not work at all.

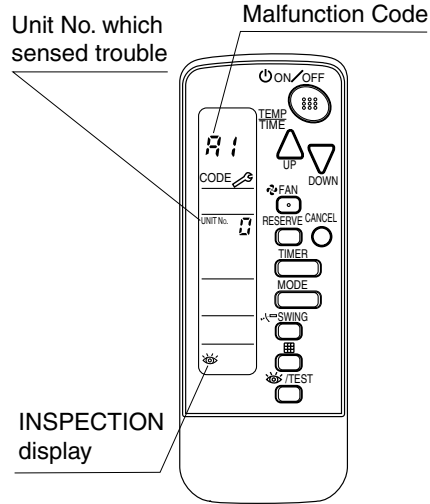

**[Remedial action]**

Check the malfunction code (A1 - UF) on the remote control and contact the place of purchase. (See page 60.)

**2.3.5 Installation**

**■ Safety Precautions**

Please read these "SAFETY PRECAUTIONS" carefully before installing air conditioning unit and be sure to install it correctly.

After completing installation, conduct a trial operation to check for faults and explain to the customer how to operate the air conditioner and take care of it with the aid of the operation manual. Ask the customer to store the installation manual along with the operation manual for future reference.

Meaning of CAUTION notices



**CAUTION**

Failure to observe these instructions properly may result in property damage or personal injury, which may be serious depending on the circumstances.



**CAUTION**

- Refer also to the installation manual attached to the indoor unit and the installation manual attached to the decoration panel.
- Confirm that following conditions are satisfied prior to installation.
  - Ensure that nothing interrupts the operation of the wireless remote controller. (Ensure that there is neither a source of light nor fluorescent lamp near the receiver. Also, ensure that the receiver is not exposed of direct sun light.)
  - Ensure that the operation display lamp and other indicators are easy to see.
- The installation position of this kit is 1 position of the decoration panel. Therefore, confirm that its position is set so that the signal from the wireless remote controller can be easily transmitted and its display can be easily seen.
- If both this kit and fresh air intake kit are installed, only one duct chamber shall be used. Refer to the installation manual of the fresh air intake kit (optional hand book).

**■ Before Installation**

**(1) Accessories**

Check if the following accessories are included with your unit.

Name	Receiver	Wireless remote controller	Transmission	Remote controller holder	Screw for installing transmission	Screw for installing remote controller holder
Quantity	1 set	1 pc.	1 set	1 pc.	2 pcs.	2 pcs.
Shape						

Name	Clamp	Dry cell battery LR03 (AM4)	Unit No. label	Field setting label	Operation manual	Installation manual
Quantity	1 pc.	2 pcs.	1 pc.	1 pc.	1 pc.	1 pc.
Shape						

**(2) Note to the Installer**

- Be sure to instruct the customer how to properly operate the system showing him/her the attached operation manual.

■ Remote Controller Installation

NOTES

- Do not throw the remote controller or impose large shocks. Also, do not store where it may be exposed to moisture or direct sunlight.
- When operating, point the transmitting part of the remote controller in the direction of the receiver.
- The direct transmitting distance of the remote controller is approximately 7 meters.
- The signal cannot be transmitted if something such as curtains blocks the receiver and the remote controller.

● When attaching in a wall or a pillar

1. Fix the remote controller holder with the screws.

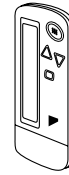

2. Slide the remote controller into the remote controller holder from the top.

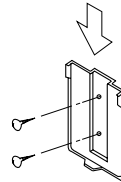

● How to insert the batteries

1. Open the back cover of the remote controller by sliding it in the direction of the arrow.

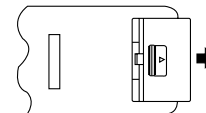

2. Insert the attached dry cell batteries. Properly insert, set the batteries by matching the (+) and (-) polarity marks as indicated. Then close the cover as before.

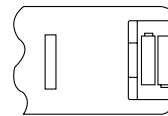

■ Address Set Up

Determination of address and MAIN/SUB remote controller.

If setting multiple wireless remote controllers to operate in one room, perform address setting for the receiver and the wireless remote controller.

If setting multiple wired remote controllers in one room, change the MAIN/SUB switch of the receiver.

SETTING PROCEDURE

(1) Setting the receiver

Set the wireless address switch (SS2) on the printed circuit board according to the table below.





Unit No.	No. 1	No. 2	No. 3
Wireless address switch (SS2)			

When using both a wired and a wireless remote controller for 1 indoor unit, the wired controller should be set to MAIN. Therefore, set the MAIN/SUB switch (SS1) of the receiver to SUB.

	MAIN	SUB
MAIN/SUB switch (SS1)		



**(2) Setting the address of wireless remote controller (It is factory set to "1")**

(Setting from the remote controller)

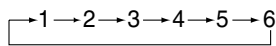
1. Hold down the  button and the  button for at least 4 seconds to get the Field Set mode.  
(Indicated in the display area in the figure at right.)
2. Press the  button and select a multiple setting (A/b). Each time the button is pressed the display switches between "A" and "b".
3. Press the " UP" button or " DOWN" button to set the address.



Address can be set from 1 to 6, but set it to 1 ~ 3 and to same address as the receiver. (The receiver does not work with address 4 ~ 6.)

4. Press the  button to enter the setting.
5. Hold down the  button for at least 1 second to quit the Field Set mode and return to the normal display.

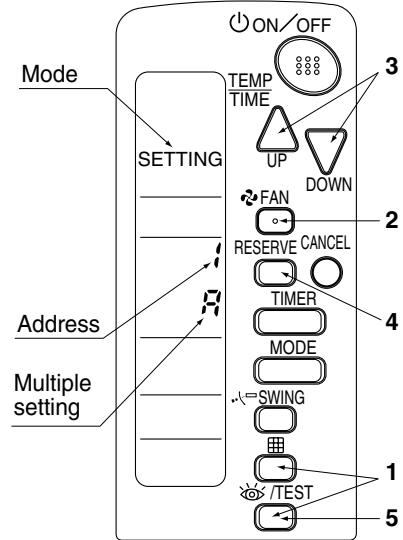

**Multiple settings A/b**

When the indoor unit is being operating by outside control (central remote controller, etc.), it sometimes does not respond to ON/OFF and temperature setting commands from this remote controller. Check what setting the customer wants and make the multiple setting as shown below.

Remote controller		Movement when the operation is controlled by the other air conditioners and equipment
Multiple setting	Remote controller display	
A: Standard	All items displayed.	When operation changeover, temperature setting or the like is carried out from the remote controller, the indoor unit rejects the instruction. (Signal receiving sound "peeh" or "pick-pick-pick") As a result, a discrepancy between the operation state of the indoor unit and the indication of the remote controller display occurs.
b: Multi System	Operations remain displayed shortly after execution.	Since the indication of the remote controller is turned off, no discrepancy such as mentioned above occurs.

**(3) Stick the Unit No. label on the air outlet of the decoration panel and the back of the wireless remote controller.**

**[PRECAUTIONS]**  
Set the Unit No. of the receiver and the wireless remote controller to be equal. If the settings differ, the signal from the remote controller cannot be transmitted.

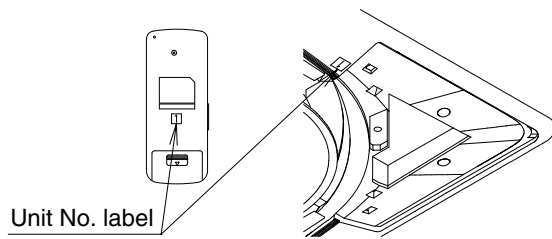

<Attachment of Unit No. label>

### ■ Installation of the Transmission

1. Remove the lid of the terminal box as described in the Installation Manual supplied with the indoor unit.
2. Fix the transmission at the bottom of the bell mouths on the indoor unit body using provided transmission fixing screws as shown below.
3. Connect the wire harness (shorter one) from the transmission to X24A connector on the printed circuit board in the indoor unit. Bring out the wire harness (longer one) from the transmission to outside of the unit through the field wiring pathway (low voltage side) of the indoor unit.
4. Fix two wire harnesses from the transmission using provided clamps.

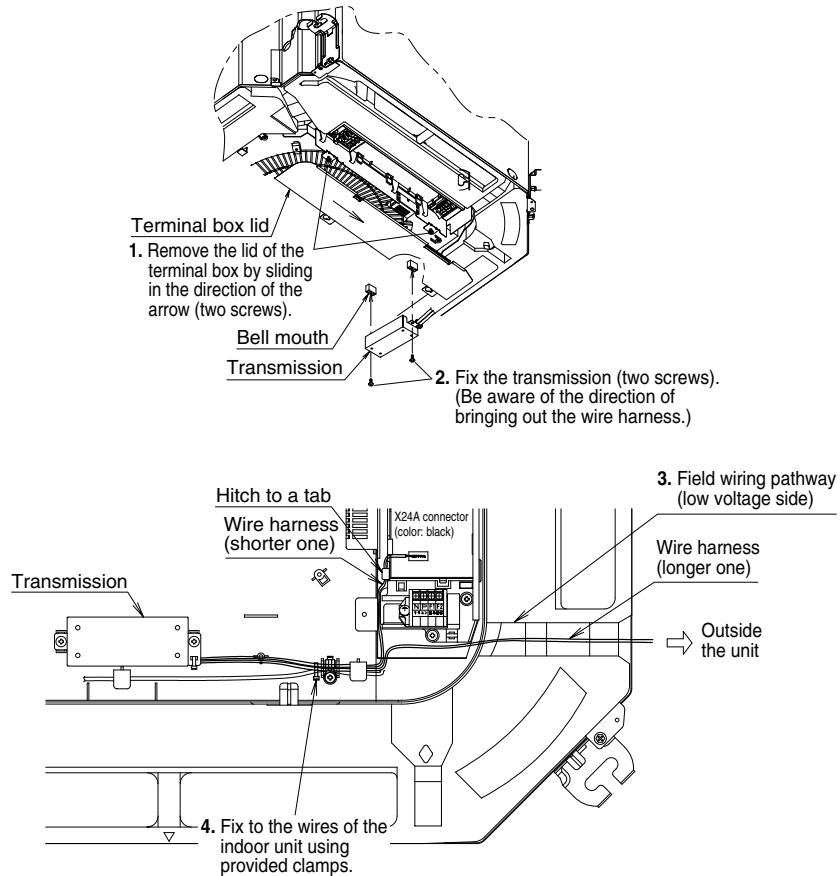

### ■ Installation of the Decoration Panel

Install the decoration panel as described in the Installation Manual supplied with the decoration panel.

#### NOTE

- Watch that the wire harness (longer one) from the transmission is not caught between the indoor unit and the decoration panel, and ceiling and the decoration panel.

■ Installation of the Receiver

1. Remove the corner decoration lid of the decoration panel, locating at the opposing corner of the drain piping section. The lid will be no longer in use.

**Be sure to install the receiver to this corner.**

2. Remove a backside cover of the receiver.
3. Connect the wire harness (longer one) from the transmission to the connector of the printed circuit board of the receiver.
4. Attach the backside cover of the receiver in reverse procedure to 2.
5. Install the receiver to the decoration panel.

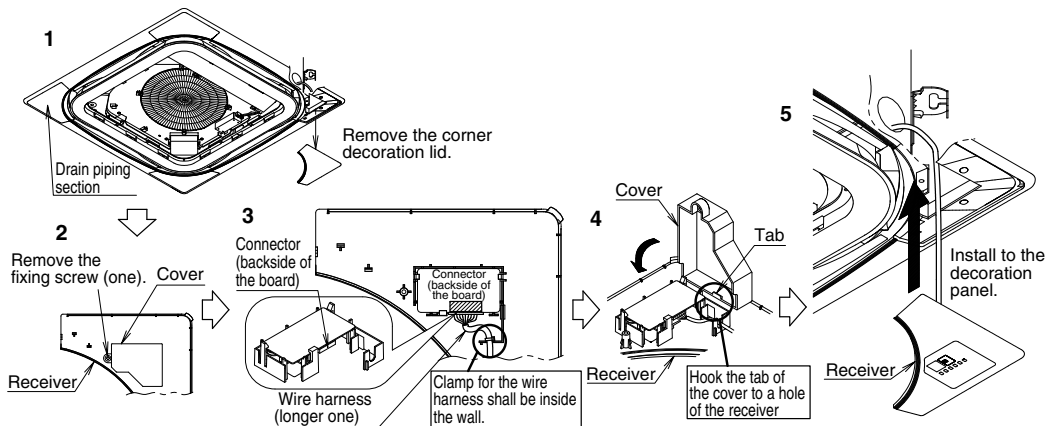

■ Field Setting

If optional accessories are mounted on the indoor unit, the indoor unit setting may have to be changed. Refer to the instruction manual (optional hand book) for each optional accessory.

**Procedure**

1. When in the normal mode, press the **TEST** button for a minimum of four seconds, and the FIELD SET MODE is entered.
2. Select the desired MODE NO. with the **MODE** button.
3. Push the “**UP**” button and select the FIRST CODE NO.
4. Push the “**DOWN**” button and select the SECOND CODE NO.
5. Push the **RESERVE** button and the present settings are SET.
6. Push the **TEST** button to return to the NORMAL MODE.

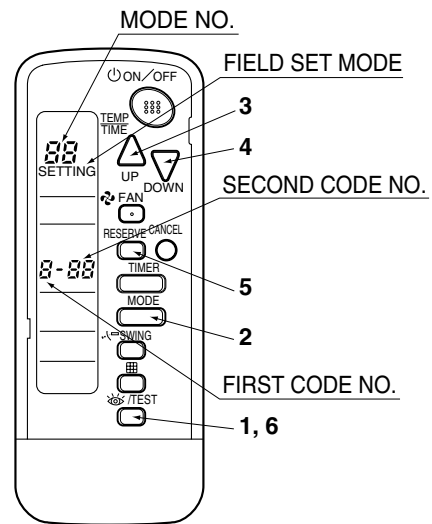

(Example)

If the time to clean air filter is set to "Filter Contamination-Heavy", set Mode No. to "10", FIRST CODE NO. to "0", and SECOND CODE NO. to "02".

MODE NO.	FIRST CODE NO.	DESCRIPTION OF SETTING	SECOND CODE NO. NOTE)			
			01	02	03	
10	0	Filter Contamination-Heavy/Light (Setting for spacing time of display time to clean air filter) (Setting for when filter contamination is heavy, and spacing time of display time to clean air filter is to be halved)	Ultra-long-life type	approx. 10,000 hours	approx. 5,000 hours	-
			Long-life type	approx. 2,500 hours	approx. 1,250 hours	
			Standard type	approx. 200 hours	approx. 100 hours	
	1	Long-life filter type (Setting of filter sign indication time) (Change setting when Ultra-long-life filter is installed)	Long-life filter	Ultra-long-life filter	-	
3	Spacing time of display time to clean air filter count (Setting for when the filter sign is not to be displayed)	Display	Do not display	-		
13	0	High ceiling setting (Setting for when installed in a ceiling higher than 2.7 m)	Normal	High Ceiling 1	High Ceiling 2	
	1	Selection of Air Flow Direction (Setting for when a blocking pad kit has been installed)	F	T	W	
	4	Air Flow Direction Range Setting	Upper	Normal	-	

**NOTE**

- The SECOND CODE NO. is factory set to "01". However, for the following cases it is set to "02".
  - Air Flow Direction Range Setting

Do not use any settings not listed in the table.





For group control with a wireless remote controller, initial settings for all the indoor units of the group are equal. (For group control, refer to the installation manual attached to the indoor unit for group control.)

**■ Test Operation**

- Perform test operation according to the instructions in the installation manual attached to the indoor unit.
- After refrigerant piping, drain piping, and electric wiring, operate according to the table to protect the unit.

**[PRECAUTIONS]**

- Refer to malfunction diagnosis in the installation manual attached to the indoor unit for split types.
- Refer to malfunction diagnosis in the installation manual attached to the outdoor unit for VRV system types.

Order	Operation
(1)	Open gas side stop valve.
(2)	Open liquid side stop valve.
(3)	Electrify crank case heater for 6 hours. (Not necessary for cooling type units)
(4)	Set to cooling with the remote controller and push  button to start operation.
(5)	Push  button twice and operate in TEST OPERATION.
(6)	Push  button and confirm its operation.
(7)	Push  button and operate normally.
(8)	Confirm its function according to the operation manual.