

DAIKIN

INSTALLATION MANUAL

R32 Split Series

INVERTER

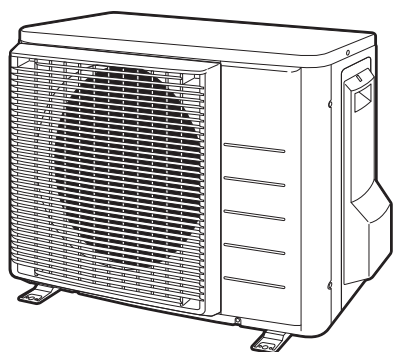

Models

RXJ20M2V1B

RXJ25M2V1B

RXJ35M2V1B

RXM20M2V1B

RXM25M2V1B

RXM35M2V1B

ARXM25M2V1B

ARXM35M2V1B

Safety Precautions



	Read the precautions in this manual carefully before operating the unit.		This appliance is filled with R32.
---	--	---	------------------------------------

- The precautions described herein are classified as WARNING and CAUTION. They both contain important information regarding safety. Be sure to observe all precautions without fail.
- Meaning of WARNING and CAUTION notices





 **WARNING.....Failure to follow these instructions properly may result in personal injury or loss of life.**

 **CAUTION.....Failure to observe these instructions properly may result in property damage or personal injury, which may be serious depending on the circumstances.**

- The safety marks shown in this manual have the following meanings:

 Be sure to follow the instructions.	 Be sure to establish an earth connection.	 Never attempt.
---	---	--

- After completing installation, conduct a trial operation to check for faults and explain to the customer how to operate the air conditioner and take care of it with the aid of the operation manual.
- The English text is the original instruction. Other languages are translations of the original instructions.

 WARNING	
<ul style="list-style-type: none"> • Ask your dealer or qualified personnel to carry out installation work. Do not attempt to install the air conditioner yourself. Improper installation may result in water leakage, electric shocks or fire. 	
<ul style="list-style-type: none"> • Install the air conditioner in accordance with the instructions in this installation manual. Improper installation may result in water leakage, electric shocks or fire. 	
<ul style="list-style-type: none"> • Be sure to use only the specified accessories and parts for installation work. Failure to use the specified parts may result in the unit falling, water leakage, electric shocks or fire. 	
<ul style="list-style-type: none"> • Install the air conditioner on a foundation strong enough to withstand the weight of the unit. A foundation of insufficient strength may result in the equipment falling and causing injury. 	
<ul style="list-style-type: none"> • Electrical work must be performed in accordance with relevant local and national regulations and with instructions in this installation manual. Be sure to use a dedicated power supply circuit only. Insufficiency of power circuit capacity and improper workmanship may result in electric shocks or fire. 	
<ul style="list-style-type: none"> • Use a cable of suitable length. Do not use tapped wires or an extension lead, as this may cause overheating, electric shocks or fire. 	
<ul style="list-style-type: none"> • Make sure that all wiring is secured, the specified wires are used, and that there is no strain on the terminal connections or wires. Improper connections or securing of wires may result in abnormal heat build-up or fire. 	
<ul style="list-style-type: none"> • When wiring the power supply and connecting the wiring between the indoor and outdoor units, position the wires so that the control box lid can be securely fastened. Improper positioning of the control box lid may result in electric shocks, fire or over heating terminals. 	
<ul style="list-style-type: none"> • If refrigerant gas leaks during installation, ventilate the area immediately. Toxic gas may be produced if the refrigerant comes into contact with fire. 	
<ul style="list-style-type: none"> • After completing installation, check for refrigerant gas leakage. Toxic gas may be produced if the refrigerant gas leaks into the room and comes into contact with a source of fire, such as a fan heater, stove or cooker. 	
<ul style="list-style-type: none"> • When installing or relocating the air conditioner, be sure to bleed the refrigerant circuit to ensure it is free of air, and use only the specified refrigerant (R32). The presence of air or other foreign matter in the refrigerant circuit causes abnormal pressure rise, which may result in equipment damage and even injury. 	
<ul style="list-style-type: none"> • During installation, attach the refrigerant piping securely before running the compressor. If the refrigerant pipes are not attached and the stop valve is open when the compressor is run, air will be sucked in, causing abnormal pressure in the refrigeration cycle, which may result in equipment damage and even injury. 	
<ul style="list-style-type: none"> • During pump-down, stop the compressor before removing the refrigerant piping. If the compressor is still running and the stop valve is open during pump-down, air will be sucked in when the refrigerant piping is removed, causing abnormal pressure in the refrigeration cycle, which may result in equipment damage and even injury. 	
<ul style="list-style-type: none"> • Be sure to earth the air conditioner. Do not earth the unit to a utility pipe, lightning conductor or telephone earth lead. Imperfect earthing may result in electric shocks. 	
<ul style="list-style-type: none"> • Be sure to install an earth leakage breaker. Failure to install an earth leakage breaker may result in electric shocks or fire. 	



Safety Precautions

⚠ CAUTION

<ul style="list-style-type: none"> Do not install the air conditioner at any place where there is a danger of flammable gas leakage. In the event of a gas leakage, build-up of gas near the air conditioner may cause a fire to break out. 	⊘
<ul style="list-style-type: none"> While following the instructions in this installation manual, install drain piping to ensure proper drainage and insulate piping to prevent condensation. Improper drain piping may result in indoor water leakage and property damage. 	
<ul style="list-style-type: none"> Tighten the flare nut according to the specified method such as with a torque wrench. If the flare nut is too tight, it may crack after prolonged use, causing refrigerant leakage. 	
<ul style="list-style-type: none"> Make sure to provide for adequate measures in order to prevent that the outdoor unit be used as a shelter by small animals. Small animals making contact with electrical parts can cause malfunctions, smoke or fire. Please instruct the customer to keep the area around the unit clean. 	
<ul style="list-style-type: none"> The temperature of refrigerant circuit will be high, please keep the inter-unit wire away from copper pipes that are not thermally insulated. 	
<ul style="list-style-type: none"> This appliance is intended to be used by expert or trained users in shops, in light industry and on farms, or for commercial and household use by lay persons. 	
<ul style="list-style-type: none"> Sound pressure level is less than 70 dB(A). 	

Accessories

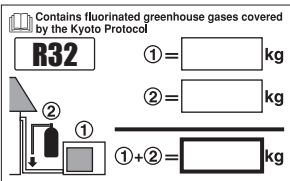
Accessories supplied with the outdoor unit:

(A) Installation manual	1	(B) Drain plug (heat pump models)  It is on the bottom of the packing case.	1
(C) Refrigerant charge label 	1		
(D) Multilingual fluorinated greenhouse gases label 	1		

Precautions for Selecting the Location

- Choose a place solid enough to bear the weight and vibration of the unit, where the operation noise will not be amplified.
- Choose a location where the hot air discharged from the unit or the operation noise will not cause a nuisance to the neighbours of the user.
- Avoid places near a bedroom and the like, so that the operation noise will cause no trouble.
- There must be sufficient spaces for carrying the unit into and out of the site.
- There must be sufficient space for air passage and no obstructions around the air inlet and the air outlet.
- The site must be free from the possibility of flammable gas leakage in a nearby place.
- Install units, power cords and inter-unit wire at least 3m away from television and radio sets. This is to prevent interference to images and sounds. (Noises may be heard even if they are more than 3m away depending on radio wave conditions.)
- In coastal areas or other places with salty atmosphere of sulfate gas, corrosion may shorten the life of the air conditioner.
- Since drain flows out of the outdoor unit, do not place under the unit anything which must be kept away from moisture.

NOTE

Cannot be installed hanging from ceiling or stacked.

Precautions for Selecting the Location

CAUTION

When operating the air conditioner in a low outdoor ambient temperature, be sure to follow the instructions described below.

- To prevent exposure to wind, install the outdoor unit with its suction side facing the wall.
- Never install the outdoor unit at a site where the suction side may be exposed directly to wind.
- To prevent exposure to wind, it is recommended to install a baffle plate on the air discharge side of the outdoor unit.
- In heavy snowfall areas, select an installation site where the snow will not affect the unit.

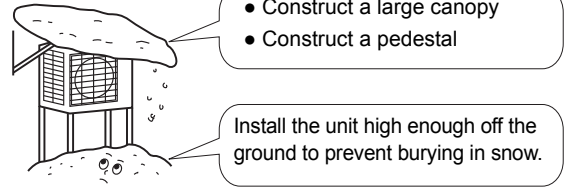

Outdoor Unit Installation Drawings

Max. allowable piping length	20m
** Min. allowable piping length	1.5m
Max. allowable piping height	15m
* Additional refrigerant required for refrigerant pipe exceeding 10m in length.	20g/m
Gas pipe	O.D. 9.5mm
Liquid pipe	O.D. 6.4mm

- * Be sure to add the proper amount of additional refrigerant. Failure to do so may result in reduced performance.
- ** The suggested shortest pipe length is 1.5m, in order to avoid noise from the outdoor unit and vibration. (Mechanical noise and vibration may occur depending on how the unit is installed and the environment in which it is used.)

Wrap the insulation pipe with the finishing tape from bottom to top.

CAUTION
**Set the piping length from 1.5m to 20m.

Allow 300mm of work space below the ceiling surface

Allow space for piping and electrical servicing.

In sites with poor drainage, use block bases for outdoor unit. Adjust foot height until the unit is leveled. Otherwise, water leakage or pooling of water may occur.

250mm from wall

Stop valve cover

■ **How to remove the stop valve cover**

- Remove the screw on the stop valve cover.
- Slide the cover downward to remove it.

■ **How to attach the stop valve cover**

- Insert the upper part of the stop valve cover into the outdoor unit.
- Tighten the screws.

Where there is a danger of the unit falling, use foot bolts, or wires.

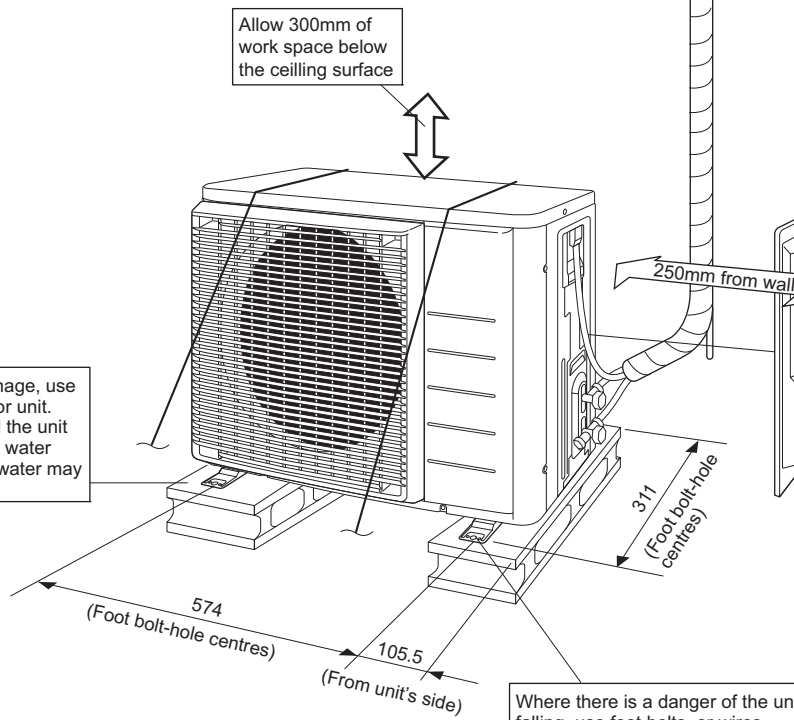

unit: mm

Installation Guidelines

- Where a wall or other obstacle is in the path of outdoor unit's inlet or outlet airflow, follow the installation guidelines below.
- For any of the following installation patterns, the wall height on the outlet side should be 1200mm or less.

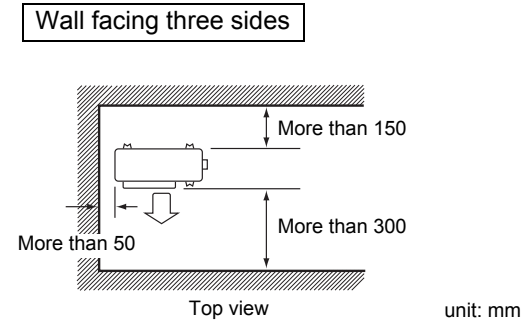
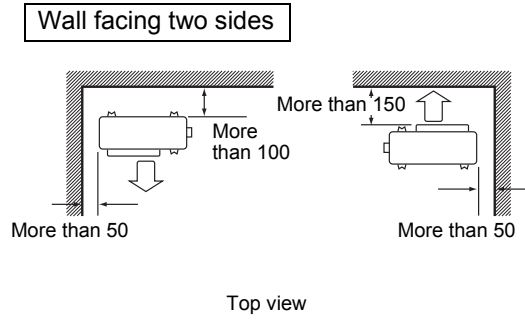
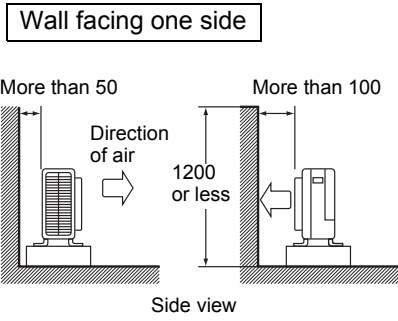

Precautions on Installation

- Check the strength and level of the installation ground so that the unit will not cause any operating vibration or noise after installed.
- In accordance with the foundation drawing, fix the unit securely by means of the foundation bolts. (Prepare 4 sets of M8 or M10 foundation bolts, nuts and washers each which are available on the market.)
- It is best to screw in the foundation bolts until their ends are 20mm from the foundation surface.

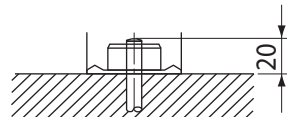

Outdoor Unit Installation

1. Installing outdoor unit

- 1) When installing the outdoor unit, refer to "Precautions for Selecting the Location" and the "Outdoor Unit Installation Drawings."
- 2) If drain work is necessary, follow the procedures below.

2. Drain work

- 1) Use drain plug for drainage.
- 2) If the drain port is covered by a mounting base or floor surface, place additional foot bases of at least 30mm in height under the outdoor unit's feet.
- 3) In cold areas, do not use a drain hose with the outdoor unit. (Otherwise, drain water may freeze, impairing heating performance.)

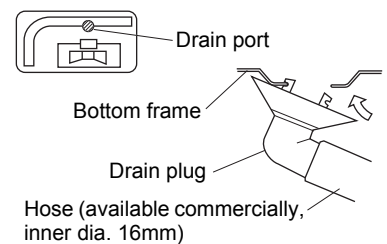

Outdoor Unit Installation

3. Flaring the pipe end

- 1) Cut the pipe end with a pipe cutter.
- 2) Remove burrs with the cut surface facing downward so that the chips do not enter the pipe.
- 3) Put the flare nut on the pipe.
- 4) Flare the pipe.
- 5) Check that the flaring is properly made.

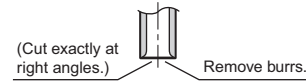

Flaring

Set exactly at the position shown below.

Flare tool for R410A/R32	Conventional flare tool	
	Clutch-type	Wing-nut type (Imperial-type)
A	0-0.5mm	1.5-2.0mm

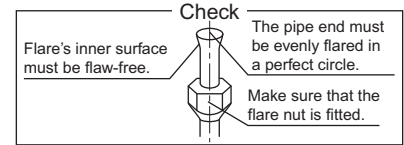

⚠ WARNING

- Do not use mineral oil on flared part.
- Prevent mineral oil from getting into the system as this would reduce the lifetime of the units.
- Never use piping which has been used for previous installations. Only use parts which are delivered with the unit.
- Never install a dryer to this R32 unit in order to guarantee its lifetime.
- The drying material may dissolve and damage the system.
- Incomplete flaring may cause refrigerant gas leakage.

4. Refrigerant piping work

⚠ CAUTION

- Use the flare nut fixed to the main unit. (To prevent cracking of the flare nut by aged deterioration.)
 - To prevent gas leakage, apply refrigeration oil only to the inner surface of the flare. (Use refrigeration oil for R410A or R32.)
 - Use torque wrenches when tightening the flare nuts to prevent damage to the flare nuts and gas leakage.
 - After the piping work is finished (after checking for gas leaks), open the stop valves or the compressor might break down.
- Align the centres of both flares and tighten the flare nuts 3 or 4 turns by hand. Then tighten them fully with the torque wrenches.

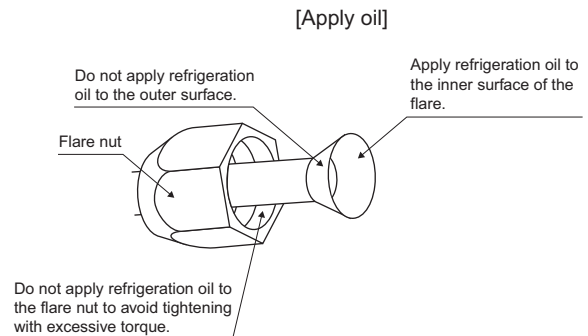
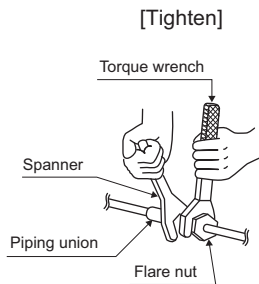

Flare nut tightening torque	
Gas side	Liquid side
3/8 inch	1/4 inch
32.7-39.9N • m (333-407kgf • cm)	14.2-17.2N • m (144-175kgf • cm)

Valve cap tightening torque	
Gas side	Liquid side
3/8 inch	1/4 inch
21.6-27.4N • m (220-280kgf • cm)	21.6-27.4N • m (220-280kgf • cm)

Service port cap tightening torque
10.8-14.7N • m (110-150kgf • cm)

Outdoor Unit Installation

4-1 Cautions on pipe handling

- 1) Protect the open end of the pipe against dust and moisture.
- 2) All pipe bends should be as gentle as possible. Use a pipe bender for bending.

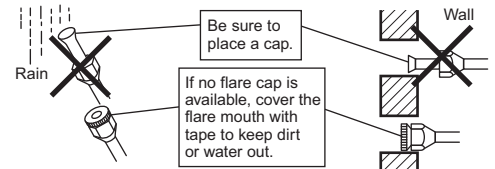

4-2 Selection of copper and heat insulation materials

When using commercial copper pipes and fittings, observe the following:

- 1) Insulation material: Polyethylene foam
Heat transfer rate: 0.041 to 0.052W/mK (0.035 to 0.045kcal/mh°C)
Refrigerant gas pipe's surface temperature reaches 110°C max.
Choose heat insulation materials that will withstand this temperature.
- 2) Be sure to insulate both the gas and liquid piping and to provide insulation dimensions as below.

Gas side	Liquid side	Gas pipe thermal insulation	Liquid pipe thermal insulation
O.D. 9.5mm	O.D. 6.4mm	I.D. 12-15mm	I.D. 8-10mm
Minimum bend radius		Thickness 10mm Min.	
30mm or more			
Thickness 0.8mm (C1220T-O)			

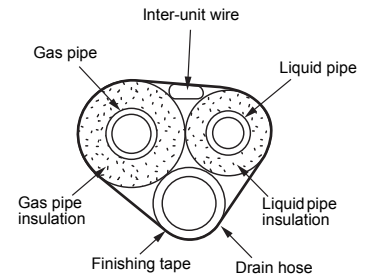

- 3) Use separate thermal insulation for gas and liquid refrigerant pipes.

5. Evacuating the air with a vacuum pump and checking gas leakage

⚠ WARNING

- Do not mix any substance other than the specified refrigerant (R32) into the refrigeration cycle.
- When refrigerant gas leaks occur, ventilate the room as soon and as much as possible.
- R32, as well as other refrigerants, should always be recovered and never be released directly into the environment.
- Use a vacuum pump for R32 or R410A exclusively. Using the same vacuum pump for different refrigerants may damage the vacuum pump or the unit.
- Use tools for R32 or R410A (such as the gauge manifold, charging hose, or vacuum pump adapter).

- When piping work is completed, it is necessary to evacuate the air and check for gas leakage.
- If using additional refrigerant, perform air evacuating from the refrigerant pipes and indoor unit using a vacuum pump, then charge additional refrigerant.
- Use a hexagonal wrench (4mm) to operate the stop valve rod.
- All refrigerant pipe joints should be tightened with a torque wrench at the specified tightening torque.

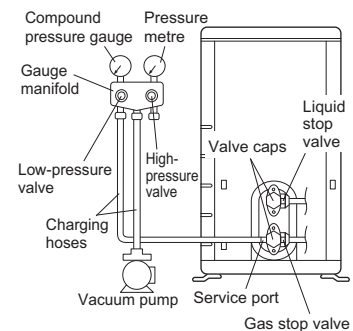

- 1) Connect projection side of charging hose (which comes from gauge manifold) to gas stop valve's service port.
- 2) Fully open gauge manifold's low-pressure valve (Lo) and completely close its high-pressure valve (Hi). (High-pressure valve subsequently requires no operation.)
- 3) Do vacuum pumping and make sure that the compound pressure gauge reads -0.1MPa (-76cmHg).*1
- 4) Close gauge manifold's low-pressure valve (Lo) and stop vacuum pump. (Keep this state for a few minutes to make sure that the compound pressure gauge pointer does not swing back.)*2
- 5) Remove caps from liquid stop valve and gas stop valve.

Outdoor Unit Installation

- 6) Turn the liquid stop valve's rod 90 degrees counterclockwise with a hexagonal wrench to open valve. Close it after 5 seconds, and check for gas leakage. Using soapy water, check for gas leakage from indoor unit's flare and outdoor unit's flare and valve rods. After the check is complete, wipe all soapy water off.
- 7) Disconnect charging hose from gas stop valve's service port, then fully open liquid and gas stop valves. (Do not attempt to turn valve rod beyond its stop.)
- 8) Tighten valve caps and service port caps for the liquid and gas stop valves with a torque wrench at the specified torques.

*1. Pipe length vs. vacuum pump run time.

Pipe length	Up to 15m	More than 15m
Run time	Not less than 10 min.	Not less than 15 min.

*2. If the compound pressure gauge pointer swings back, refrigerant may have water content or a loose pipe joint may exist. Check all pipe joints and retighten nuts as needed, then repeat steps 2) through 4).

6. Refilling the refrigerant

Check the type of refrigerant to be used on the machine nameplate.
Fill from the gas pipe in liquid form.

Important information regarding the refrigerant used

This product contains fluorinated greenhouse gases covered by the Kyoto Protocol. Do not vent gases into the atmosphere.

Refrigerant type: **R32**

GWP⁽¹⁾ value: **675** ⁽¹⁾GWP = global warming potential

Please fill in with indelible ink,

- ① the factory refrigerant charge of the product,
 - ② the additional refrigerant amount charged in the field and
 - ①+② the total refrigerant charge
- on the refrigerant charge label supplied with the product.

The filled out label must be adhered in the proximity of the product charging port (e.g. onto the inside of the stop valve cover).

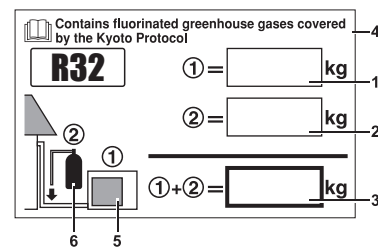

- 1 factory refrigerant charge of the product: see unit name plate
- 2 additional refrigerant amount charged in the field
- 3 total refrigerant charge
- 4 Contains fluorinated greenhouse gases covered by the Kyoto Protocol
- 5 outdoor unit
- 6 refrigerant cylinder and manifold for charging

NOTE

National implementation of EU regulation on certain fluorinated greenhouse gases may require to provide the appropriate official national language on the unit. Therefore an additional multilingual fluorinated greenhouse gases label is supplied with the unit. Sticking instructions are illustrated on the backside of that label.

Pump Down Operation

In order to protect the environment, be sure to pump down when relocating or disposing of the unit.

- 1) Remove the valve cap from liquid stop valve and gas stop valve.
- 2) Carry out forced cooling operation.
- 3) After 5 to 10 minutes, close the liquid stop valve with a hexagonal wrench.
- 4) After 2 to 3 minutes, close the gas stop valve and stop forced cooling operation.

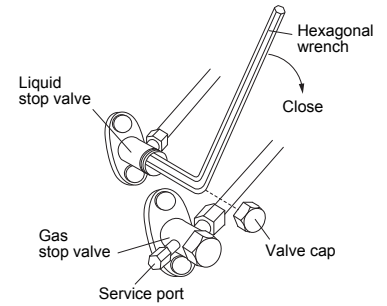

Forced cooling operation

■ Using the indoor unit ON/OFF switch

Press the indoor unit ON/OFF switch for at least 5 seconds. (The operation will start.)

- Forced cooling operation will stop automatically after around 15 minutes.
To stop the operation, press the indoor unit ON/OFF switch.

■ Using the indoor unit's remote controller

- Please read about the procedure in "Trial operation from remote controller" in the installation manual attached to the indoor unit. Please set the operation mode to "cooling".

⚠ CAUTION

- When pressing the switch, do not touch the terminal block. It has a high voltage, so doing so may cause electric shock.
- After closing the liquid stop valve, close the gas stop valve within 3 minutes, then stop the forced cooling operation.

Facility Setting (cooling at low outdoor temperature)

This function is designed for facilities such as equipment or computer rooms. It is never to be used in a residence or office where people occupy the space.

- 1) Cutting jumper 6 (J6) on the circuit board will expand the operation range down to -15°C . However it will stop if the outdoor temperature drops below -20°C and start back up once the temperature rises again.

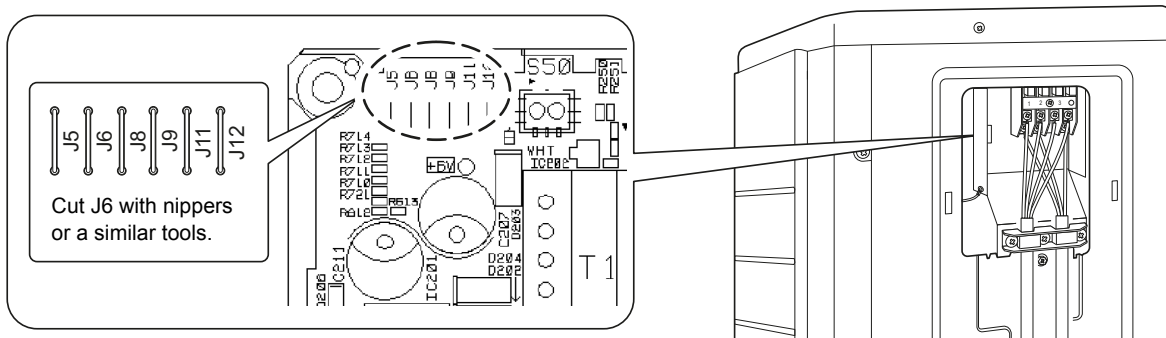

⚠ CAUTION

- If the outdoor unit is installed where the heat exchanger of the unit is exposed to direct wind, provide a windbreak wall.
- Intermittent noises may be produced by the indoor unit due to the outdoor fan turning on and off when using facility settings.
- Do not place humidifiers or other items which might raise the humidity in rooms where facility settings are being used.
A humidifier might cause dew condensation from the indoor unit outlet vent.
- Cutting jumper 6 (J6) sets the indoor fan tap to the highest position. Notify the user about this.

Wiring

⚠ WARNING

- Do not use tapped wires, stranded wires, extension cords, or starburst connections, as they may cause overheating, electrical shock, or fire.
- Do not use locally purchased electrical parts inside the product. (Do not branch the power for the drain pump, etc., from the terminal block.) Doing so may cause electric shock or fire.
- Be sure to install an earth leak detector. (One that can handle higher harmonics.)
(This unit uses an inverter, which means that an earth leak detector capable of handling higher harmonics must be used, in order to prevent malfunctioning of the earth leak detector itself.)
- Use an all-pole disconnection type breaker with at least 3mm between the contact point gaps.
- Do not connect the power wire to the indoor unit. Doing so may cause electric shock or fire.

- Do not turn ON the safety breaker until all work is completed.

- 1) Strip the insulation from the wire (20mm).
- 2) Connect the connection wires between the indoor and outdoor units so that the terminal numbers match. Tighten the terminal screws securely. We recommend a flathead screwdriver be used to tighten the screws. The screws are packed with the terminal block.

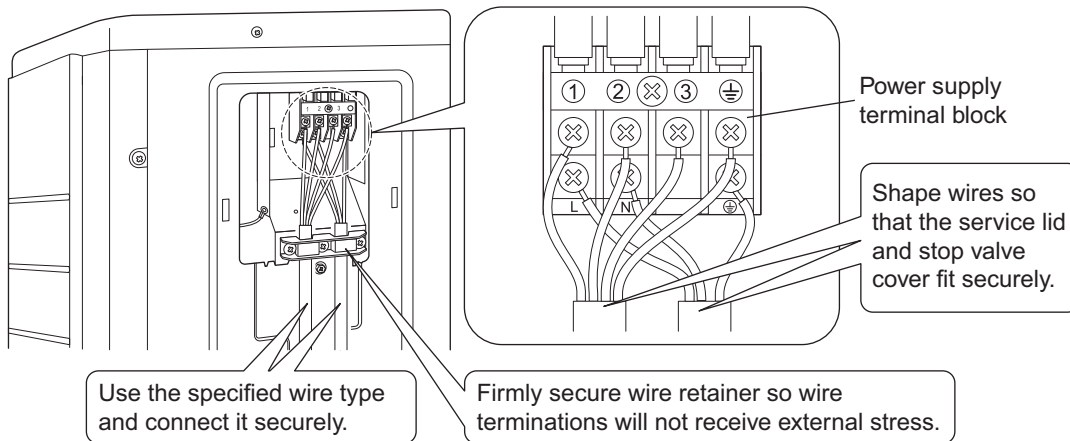
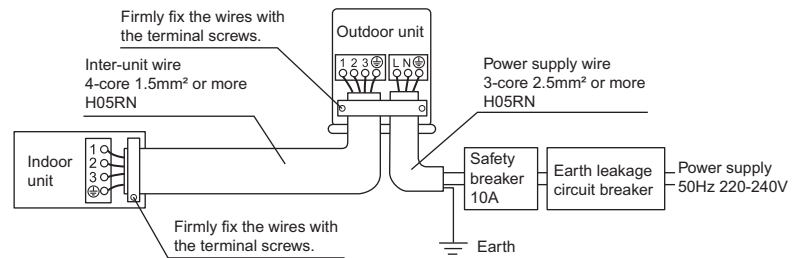

Observe the notes mentioned below when wiring to the power supply terminal block.
Precautions to be taken for power supply wiring.

⚠ CAUTION

- When connecting the connection wires to the terminal block using a single core wire, be sure to perform curling. Problems with the work may cause heat and fires.

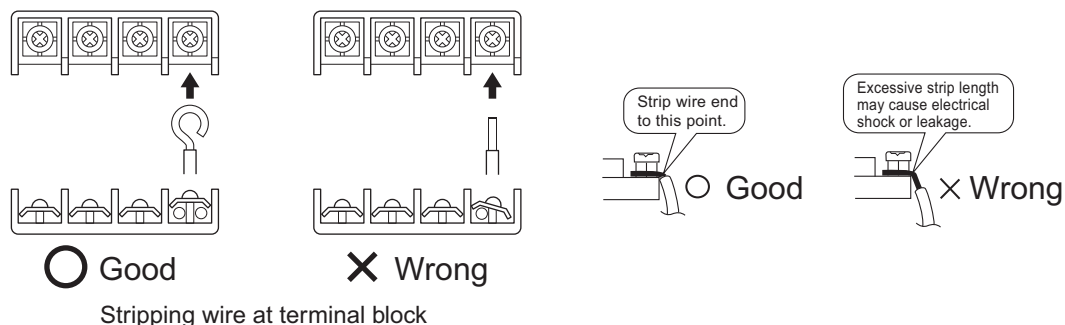

- If the stranded wires must be used, make sure to use the round crimp-style terminal for connection to the power supply terminal block. Place the round crimp-style terminals on the wires up to the covered part and secure in place.

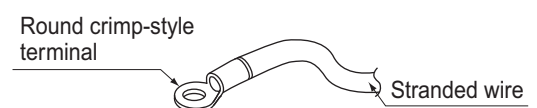

- 3) Pull the wire and make sure that it does not disconnect. Then fix the wire in place with a wire stop.

Wiring

Wiring diagram

For applied parts and numbering refer to the wiring diagram sticker supplied on the unit. Part numbering is realized by Arabic numbers in ascending order for each part and is represented in the overview below by symbol ^(*) in the part code.

	:	CONNECTION		:	PROTECTIVE EARTH (SCREW)
	:	CONNECTOR		:	RECTIFIER
	:	EARTH		:	RELAY CONNECTOR
	:	FIELD WIRING		:	SHORT CIRCUIT CONNECTOR
	:	INDOOR UNIT		:	TERMINAL
	:	OUTDOOR UNIT		:	TERMINAL STRIP
	:	PROTECTIVE EARTH		:	WIRE CLAMP
BLK	:	BLACK	GRN	:	GREEN
BLU	:	BLUE	GRY	:	GREY
BRN	:	BROWN	ORG	:	ORANGE
PNK	:	PINK	RED	:	RED
WHT	:	WHITE	PRP, PPL	:	PURPLE
			YLW	:	YELLOW
A*P	:	PRINTED CIRCUIT BOARD	PTC*	:	THERMISTOR PTC
BS*	:	PUSH BUTTON ON / OFF, OPERATION SWITCH	Q*	:	INSULATED GATE BIPOLAR TRANSISTOR (IGBT)
BZ, H*O	:	BUZZER	Q*DI	:	EARTH LEAK CIRCUIT BREAKER
C*	:	CAPACITOR	Q*L	:	OVERLOAD PROTECTOR
CN*, E*AC*, HA*, HE, HL*, HN*, HR*, MR*_A, MR*_B, S*, X*A	:	CONNECTION, CONNECTOR	Q*M	:	THERMO SWITCH
D*, V*D	:	DIODE	R*	:	RESISTOR
DB*	:	DIODE BRIDGE	R*T	:	THERMISTOR
DS*	:	DIP SWITCH	RC	:	RECEIVER
E*H	:	HEATER	S*C	:	LIMIT SWITCH
F*U, FU* (FOR CHARACTERISTICS REFER TO PCB INSIDE YOUR UNIT)	:	FUSE	S*L	:	FLOAT SWITCH
FG*	:	CONNECTOR (FRAME GROUND)	S*NPH	:	PRESSURE SENSOR (HIGH)
H*	:	HARNESS	S*NPL	:	PRESSURE SENSOR (LOW)
H*P, LED*, V*L	:	PILOT LAMP, LIGHT EMITTING DIODE	S*PH, HPS*	:	PRESSURE SWITCH (HIGH)
HAP	:	LIGHT EMITTING DIODE (SERVICE MONITOR GREEN)	S*PL	:	PRESSURE SWITCH (LOW)
IES	:	INTELLIGENT EYE SENSOR	S*T	:	THERMOSTAT
IPM*	:	INTELLIGENT POWER MODULE	S*W, SW*	:	OPERATION SWITCH
K*R, KCR, KFR, KHuR	:	MAGNETIC RELAY	SA*	:	SURGE ARRESTOR
L	:	LIVE	SR*, WLU	:	SIGNAL RECEIVER
L*	:	COIL	SS*	:	SELECTOR SWITCH
L*R	:	REACTOR	SHEET METAL	:	TERMINAL STRIP FIXED PLATE
M*	:	STEPPER MOTOR	T*R	:	TRANSFORMER
M*C	:	COMPRESSOR MOTOR	TC, TRC	:	TRANSMITTER
M*F	:	FAN MOTOR	V*, R*V	:	VARISTOR
M*P	:	DRAIN PUMP MOTOR	V*R	:	DIODE BRIDGE
M*S	:	SWING MOTOR	WRC	:	WIRELESS REMOTE CONTROLLER
MR*, MRCW*, MRM*, MRN*	:	MAGNETIC RELAY	X*	:	TERMINAL
N	:	NEUTRAL	X*M	:	TERMINAL STRIP (BLOCK)
PAM	:	PULSE-AMPLITUDE MODULATION	Y*E	:	ELECTRONIC EXPANSION VALVE COIL
PCB*	:	PRINTED CIRCUIT BOARD	Y*R, Y*S	:	REVERSING SOLENOID VALVE COIL
PM*	:	POWER MODULE	Z*C	:	FERRITE CORE
PS	:	SWITCHING POWER SUPPLY	ZF, Z*F	:	NOISE FILTER

Trial Operation and Testing

1. Trial operation and testing

1-1 Measure the supply voltage and make sure that it falls in the specified range.

1-2 Trial operation should be carried out in either cooling or heating mode.

- In cooling mode, select the lowest programmable temperature; in heating mode, select the highest programmable temperature.
 - 1) Trial operation may be disabled in either mode depending on the room temperature.
 - 2) After trial operation is complete, set the temperature to a normal level (26°C to 28°C in cooling mode, 20°C to 24°C in heating mode).
 - 3) For protection, the system disables restart operation for 3 minutes after it is turned off.

1-3 Carry out the test operation in accordance with the operation manual to ensure that all functions and parts, such as louver movement, are working properly.

- The air conditioner requires a small amount of power in its standby mode. If the system is not to be used for some time after installation, shut off the circuit breaker to eliminate unnecessary power consumption.
- If the circuit breaker trips to shut off the power to the air conditioner, the system will restore the original operation mode when the circuit breaker is opened again.

2. Test items

Test items	Symptom	Check
Indoor and outdoor units are installed properly on solid bases.	Fall, vibration, noise	
No refrigerant gas leaks.	Incomplete cooling/heating function	
Refrigerant gas and liquid pipes and indoor drain hose extension are thermally insulated.	Water leakage	
Draining line is properly installed.	Water leakage	
System is properly earthed.	Electrical leakage	
The specified wires are used for inter-unit wiring.	Inoperative or burn damage	
Indoor or outdoor unit's air inlet or air outlet has clear path of air.	Incomplete cooling/heating function	
Stop valves are opened.	Incomplete cooling/heating function	
Indoor unit properly receives remote control commands.	Inoperative	

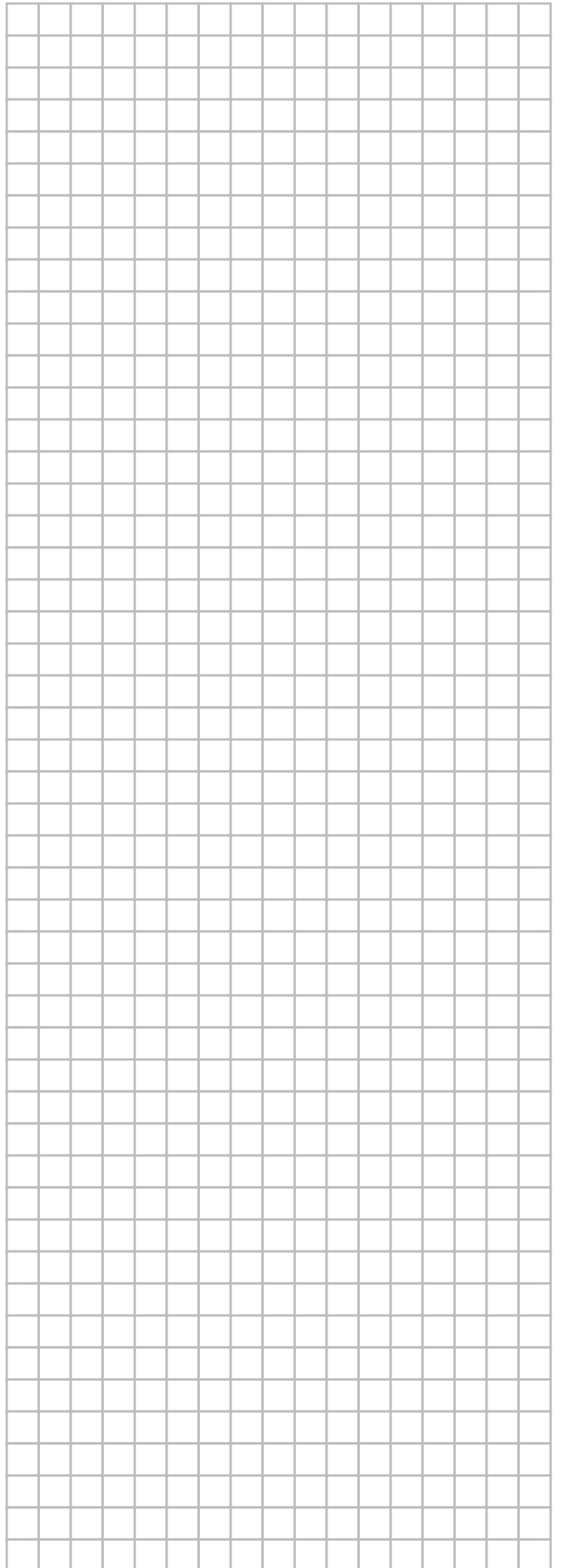
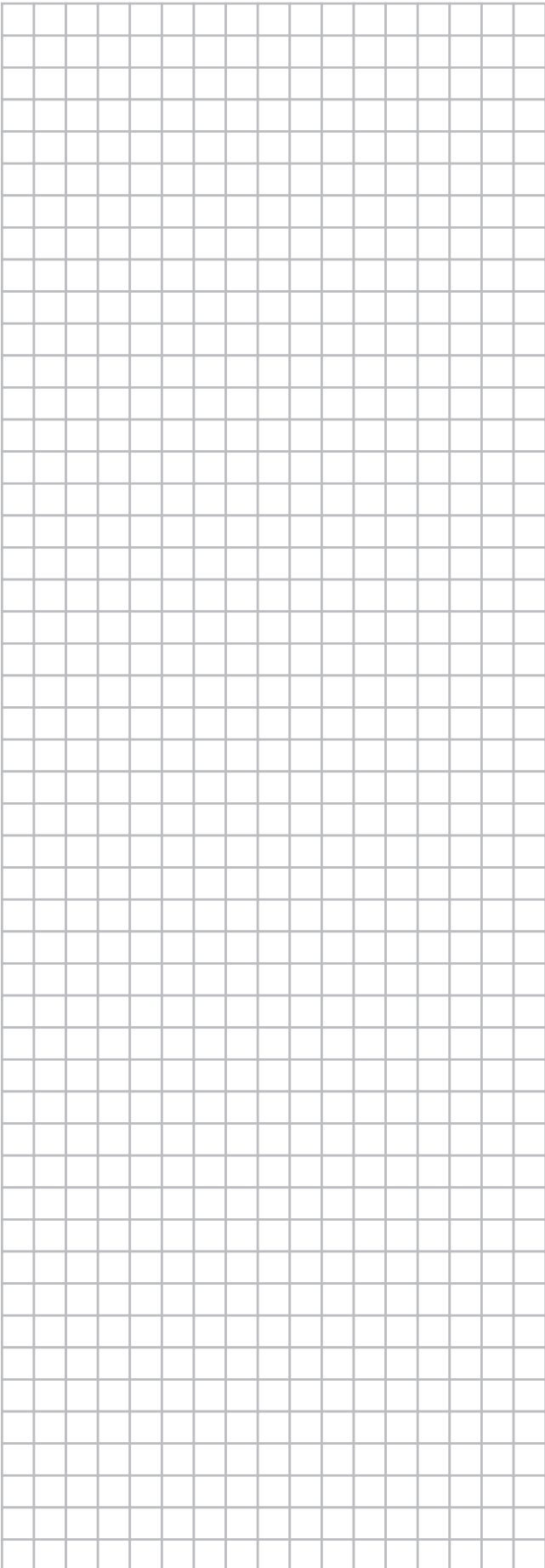

DAIKIN INDUSTRIES CZECH REPUBLIC s.r.o.

U Nové Hospody 1/1155, 301 00 Plzeň Skvrňany, Czech Republic

DAIKIN EUROPE N.V.

Zandvoordestraat 300, B-8400 Oostende, Belgium

Copyright 2015 Daikin

ERC

3P386697-2C 2015.10