

Ventilation
Technical Data

VAM-FC

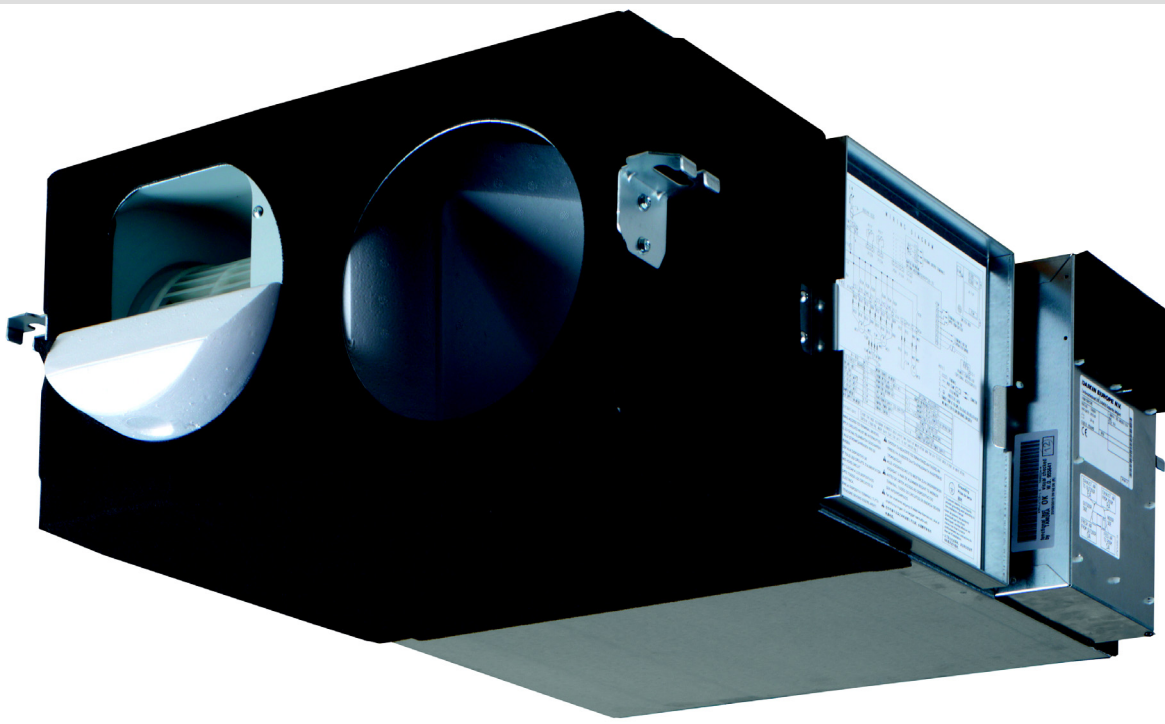

- > VAM150FCVE
- > VAM250FCVE
- > VAM350FCVE
- > VAM500FCVE
- > VAM650FCVE
- > VAM800FCVE

- > VAM1000FCVE
- > VAM1500FCVE
- > VAM2000FCVE

TABLE OF CONTENTS

VAM-FC

1	Features	2
2	Specifications	3
	Technical Specifications	3
	Electrical Specifications	4
3	Options	6
4	Exchange efficiency	7
5	Dimensional drawings	8
6	Centre of gravity	13
7	Wiring diagrams	17
	Wiring Diagrams - Single Phase	17
8	Sound data	21
	Sound Power Spectrum	21
	Sound Pressure Spectrum	25
9	Fan characteristics	28
10	Air filter characteristics	33
11	Installation	38
	Installation Method	38

1 Features

Ventilation with heat recovery as standard

- Energy saving ventilation using indoor heating, cooling and moisture recovery
- Ideal solution for shops, restaurants or offices requiring maximum floor space for furniture, decorations and fittings
- Free cooling possible when outdoor temperature is below indoor temperature (eg. during nighttime)
- Reduced energy consumption thanks to specially developed DC fan motor
- Prevent energy losses from over-ventilation while improving indoor air quality with optional CO2 sensor
- Can be used as stand alone or integrated in the Sky Air or VRV system
- Wide range of units: air flow rate from 150 up to 2,000 m³/h
- Optional medium and fine dust filters M6, F7, F8 to meet customer request or legislation
- Shorter installation time thanks to easy adjustment of nominal air flow rate, so less need for dampers compared with traditional installation.
- Specially developed heat exchange element with High Efficiency Paper (HEP)
- No drain piping needed
- Can operate in over- and under pressure
- Total solution for fresh air with Daikin supply of both VAM / VKM and electrical heaters

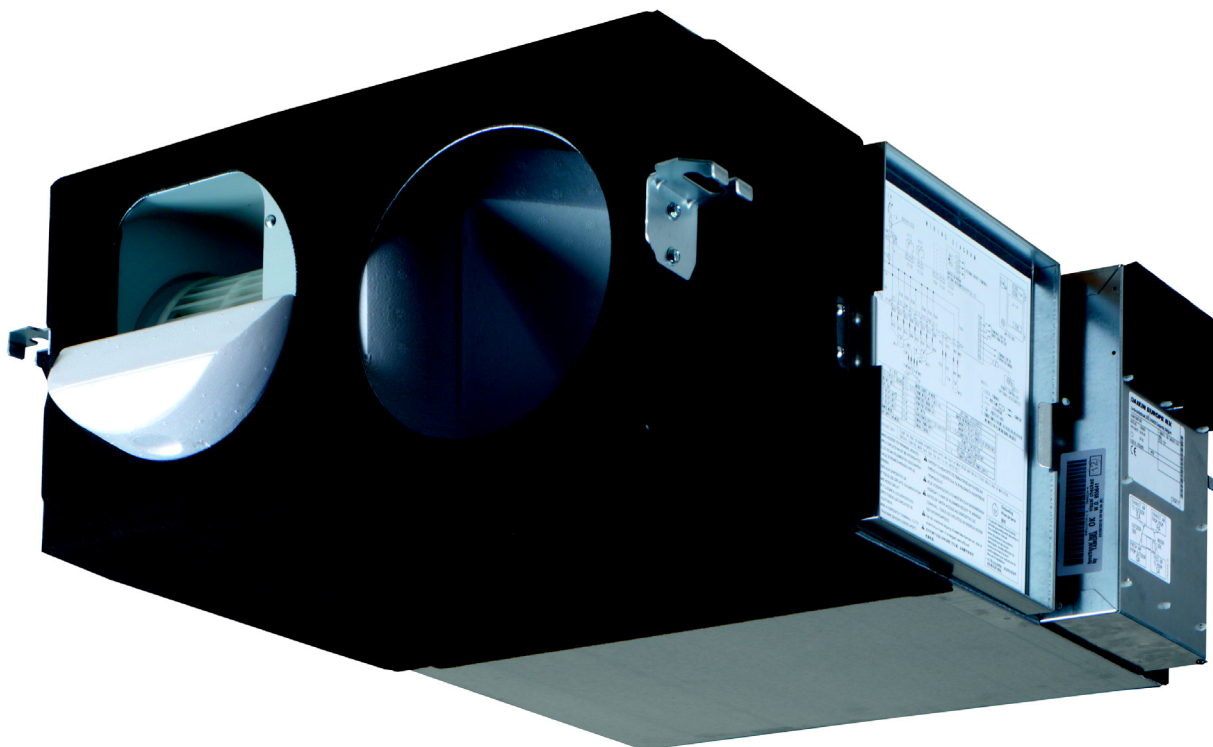

2 Specifications

2-1 Technical Specifications				VAM150F C	VAM250F C	VAM350F C	VAM500F C	VAM650F C	VAM800F C	VAM1000 FC	VAM1500 FC	VAM2000 FC	
Power input - 50Hz	Heat exchange mode	Nom.	Ultra high	kW	0.132	0.161	0.071 (1)	0.147 (1)	0.188 (1)	0.320 (1)	0.360 (1)	0.617 (1)	0.685 (1)
			High	kW	0.111	0.079	0.057 (1)	0.101 (1)	0.114 (1)	0.241 (1)	0.309 (1)	0.463 (1)	0.575 (1)
			Low	kW	0.058	0.064	0.020 (1)	0.049 (1)	0.063 (1)	0.185 (1)	0.198 (1)	0.353 (1)	0.295 (1)
	Bypass mode	Nom.	Ultra high	kW	0.132	0.161	0.071 (1)	0.147 (1)	0.188 (1)	0.320 (1)	0.360 (1)	0.617 (1)	0.685 (1)
			High	kW	0.111	0.079	0.057 (1)	0.101 (1)	0.114 (1)	0.241 (1)	0.309 (1)	0.463 (1)	0.575 (1)
			Low	kW	0.058	0.064	0.020 (1)	0.049 (1)	0.063 (1)	0.185 (1)	0.198 (1)	0.353 (1)	0.295 (1)
Temperature exchange efficiency - 50Hz	Ultra high		%	77.0 (2) / 72.0 (3)	74.9 (2) / 69.5 (3)	78.0 (2) / 71.6 (4)	77.0 (2) / 70.2 (4)	77.0 (2) / 69.8 (4)	77.0 (2) / 67.8 (4)	78.0 (2) / 70.2 (4)	78.0 (2) / 69.5 (4)	78.0 (2) / 70.2 (4)	
	High		%	78.3 (2) / 72.3 (3)	76.0 (2) / 70.0 (3)	79.3 (2) / 71.9 (4)	78.8 (2) / 70.7 (4)	79.1 (2) / 71.2 (4)	78.2 (2) / 68.8 (4)	78.6 (2) / 71.1 (4)	79.6 (2) / 70.3 (4)	79.6 (2) / 71.3 (4)	
	Low		%	82.8 (2) / 73.2 (3)	80.1 (2) / 72.0 (3)	84.1 (2) / 73.0 (4)	80.9 (2) / 71.3 (4)	81.1 (2) / 72.9 (4)	79.1 (2) / 69.6 (4)	80.2 (2) / 73.4 (4)	80.8 (2) / 71.0 (4)	80.6 (2) / 74.6 (4)	
Enthalpy exchange efficiency - 50Hz	Cooling	Ultra high	%	60.3 (2)		63.4 (2)	60.3 (2)		62.4 (2)		63.4 (2)		
		High	%	61.9 (2)	61.2 (2)	65.0 (2)	63.4 (2)	64.0 (2)	63.6 (2)	64.2 (2)	65.0 (2)	64.5 (2)	
		Low	%	67.3 (2)	64.5 (2)	70.7 (2)	66.9 (2)	67.3 (2)	64.6 (2)	66.3 (2)	66.2 (2)	67.8 (2)	
	Heating	Ultra high	%	66.6 (2)		67.6 (2)	64.5 (2)		65.5 (2)		67.6 (2)		
		High	%	67.9 (2)	67.4 (2)	68.9 (2)	67.6 (2)	67.7 (2)	68.8 (2)	69.4 (2)	69.7 (2)	69.5 (2)	
		Low	%	72.4 (2)	70.7 (2)	73.7 (2)	71.1 (2)	69.7 (2)	69.8 (2)	71.5 (2)	70.5 (2)	72.1 (2)	
Operation mode				Heat exchange mode, bypass mode, fresh-up mode									
Heat exchange system				Air to air cross flow total heat (sensible + latent heat) exchange									
Heat exchange element				Specially processed non-flammable paper									
Dimensions	Unit	Height	mm	285		301		364			726		
		Width	mm	776		828		1,000			1,510		
		Depth	mm	525		816		868		1,160	868	1,160	
Weight	Unit	kg	24.0		33.0		51.0	54.0	63.0	128	145		
Casing	Material			Galvanised steel plate									
Fan	Type			Sirocco fan									
	Air flow rate - 50Hz	Heat exchange mode	Ultra high	m³/h	150 (5)	250 (5)	350 (1)	500 (1)	650 (1)	800 (1)	1,000 (1)	1,500 (1)	2,000 (1)
			High	m³/h	140 (5)	230 (5)	320 (1)	410 (1)	545 (1)	725 (1)	950 (1)	1,350 (1)	1,880 (1)
			Low	m³/h	105 (5)	155 (5)	210 (1)	310 (1)	450 (1)	665 (1)	820 (1)	1,230 (1)	1,500 (1)
		Bypass mode	Ultra high	m³/h	150 (5)	250 (5)	350 (1)	500 (1)	650 (1)	800 (1)	1,000 (1)	1,500 (1)	2,000 (1)
			High	m³/h	140 (5)	230 (5)	320 (1)	410 (1)	545 (1)	725 (1)	950 (1)	1,350 (1)	1,880 (1)
			Low	m³/h	105 (5)	155 (5)	210 (1)	310 (1)	450 (1)	665 (1)	820 (1)	1,230 (1)	1,500 (1)
	External static pressure - 50Hz	Ultra high		Pa	90 (5)	70 (5)	103 (1)	83 (1)	100 (1)	109 (1)	147 (1)	116 (1)	132 (1)
		High		Pa	87 (5)	63 (5)	93 (1)	57 (1)	73 (1)	94 (1)	135 (1)	97 (1)	118 (1)
Low		Pa	40 (5)	25 (5)	51 (1)	35 (1)	49 (1)	78 (1)	100 (1)	80 (1)	77 (1)		
Fan motor	Quantity			2						4			
	Output	50 Hz	W	30		80		106	210				
Air filter	Type			Multidirectional fibrous fleeces									
Sound pressure level - 50Hz	Heat exchange mode	Ultra high	dBA	27.0	28.0	32.0	33.0	34.5	36.0		39.5	40.0	
		High	dBA	26.0		31.5		33.0	34.5	35.0	38.0		
		Low	dBA	20.5	21.0	23.5	24.5	27.0	31.0		34.0	35.0	
	Bypass mode	Ultra high	dBA	27.0	28.0	32.0	33.5	34.5	36.0		40.5	40.0	
		High	dBA	26.5	27.0	31.0	32.5	34.0	34.5	35.5	38.0		
		Low	dBA	20.5	21.0	24.5	25.5	27.0	31.0		33.5	35.0	
Operation range	Min.		°CDB	-15									
	Max.		°CDB	50									
	Relative humidity			%	80% or less								
	On coil temperature	Cooling	Max.	°CDB	-								
Heating		Min.	°CDB	-									
Connection duct diameter			mm	100	150	200		250		350			
Insulation material				Self-extinguishable urethane foam									

2 Specifications

2

2-1 Technical Specifications			VAM150F C	VAM250F C	VAM350F C	VAM500F C	VAM650F C	VAM800F C	VAM1000 FC	VAM1500 FC	VAM2000 FC
General	Supplier/ Manufacturer details	Name or trademark	Daikin Europe N.V.								
	Product description	Model identifier	VAM150 FCVE	VAM250 FCVE	VAM350 FCVE	VAM500 FCVE	VAM650 FCVE	VAM800 FCVE	VAM1000 FCVE	VAM1500 FCVE	VAM2000 FCVE
Specific energy consumption (SEC)	Cold climate	kWh/(m ² .a)	-56.0 (6)	-60.5 (6)	-						
	Average climate	kWh/(m ² .a)	-22.1 (6)	-27.0 (6)	-						
	Warm climate	kWh/(m ² .a)	-0.100 (6)	-5.30 (6)	-						
SEC class			D / (6)	B / (6)	-						
Type of product			Bidirectional RVU / (7)		Bidirectional NRVU / (7)						
Type of drive			Multi-speed drive								
Heat recovery system			recuperative								
Thermal efficiency		%	73.6 (3)	72.2 (3)	71.6 (4)	70.2 (4)	69.8 (4)	69.0 (4)	70.2 (4)	69.5 (4)	70.2 (4)
Maximum flow rate at 100 Pa ESP	Flow rate	m ³ /h	130 (5)	207 (5)	-						
	Electric power input	W	129	160	-						
Sound power level (Lwa)		dB	40	43	48	50	51	53		55	57
Nominal flow rate		m ³ /s	-		0.097	0.139	0.181	0.222	0.278	0.417	0.556
Reference flow rate		m ³ /s	0.025	0.040	-						
Reference pressure difference		Pa	50.0		-						
Effective electric power input		kW	-		0.055	0.121	0.140	0.241	0.279	0.465	0.532
Specific power input		W/(m ³ /h)	0.626 (8)	0.445 (8)	-						
Internal specific fan power		W/(m ³ /s)	-		350	644	594	845	818	852	811
Ventilation control	Type	Clock control		-							
	Factor	0.950 (6)		-							
Maximum external leakage		%	7.42	4.66	4.13	2.89	3.81	3.09	6.59	3.09	6.59
Maximum internal leakage		%	4.50		8.10	8.20	7.70		6.50	7.70	6.50
Filter energy performance		kWh	-		279 (7)						
Filter service warning			Displayed on controller / (5)								
Instructions for pre-/disassembly			www.daikineurope.com/energylabel								
Annual electricity consumption		kWh/a	18.9 (6)	13.6 (6)	-						
Annual heating saved	Cold climate	kWh/a	41.0 (6)	40.6 (6)	-						
	Average climate	kWh/a	80.2 (6)	79.4 (6)	-						
	Warm climate	kWh/a	18.5 (6)	18.4 (6)	-						
Face velocity		m/s	-		0.648	0.926	1.20	1.48	1.38	1.39	1.38
External pressure		Pa	-		59.7	56.4	52.6	56.8	84.8	60.0	67.7
Internal pressure drop		Pa	-		94.9	143	151	210	249	189	160
Fan efficiency		%	-		32.9		47.2		37.1		

2-2 Electrical Specifications			VAM150F C	VAM250F C	VAM350F C	VAM500F C	VAM650F C	VAM800F C	VAM1000 FC	VAM1500 FC	VAM2000 FC		
Power supply	Name		VE										
	Phase		1~										
	Frequency	Hz	50/60										
	Voltage		220-240/220										
Voltage range	Min.	%	-10										
	Max.	%	10										
Current	Minimum circuit amps (MCA)		0.900			1.30	1.60	2.50	3.00	5.00			
	Maximum fuse amps (MFA)		15.0			16.0							
	Fan motor rated output		0.03x2		0.08x2		0.106x2		0.210x2		0.210x4		
	Full load amps (FLA)	Fan motor	A	0.400			0.600	0.700	1.10	1.30	2.20		
		Fan motor 2	A	0.400			0.600	0.700	1.10	1.30	2.20		
Fan motor 3		A	-										
Fan motor 4		A	-										

4

2 Specifications

Notes

- (1) Measured on fan curve 15. Refer to fan curves.
- (2) Measured according to JIS B 8628
- (3) Measured at reference flow rate according to EN13141-7
- (4) Measured according to EN308 : 1997
- (5) Clean the filter when the filter icon appears on the controller screen. Regular filter cleaning is important for delivered air quality and for the unit's energy efficiency.
- (6) In accordance with commission regulation (EU) No 1254/2014
- (7) In accordance with commission regulation (EU) No 1253/2014
- (8) At reference flow rate in accordance with commission regulation (EU) No 1254/2014

3 Options

3 - 1 Options

3

VAM150-250FC

Type Ceiling-mounted Installation with duct

Item		Model		
		VAM150FCVE	VAM250FCVE	
Control systems	Remote control	BRC301B61		
	Remote control Wired type	BRC1D52		
		BRC1E52A / BRC1E52B *		
		DCS302C51		
	Centralised control systems	Unified ON/OFF controller	DCS301B61 (for General) DCS301B51 (for EU market)	
		Schedule timer	DST301B51	
		iTouch Manager	DCM601A51	
		iTouch Controller	DCS601C51	
		iTab Controller	DCC601A51	
		Modbus -DIII- adaptor	EKMBDXA7V1	
		Adaptor PCB	** Wiring adaptor for electrical appendices	KRP2A61 (for general) KRP2A51 (for EU market)
	** For humidifiers		KRP50-2	
	*** Installation box for adaptor PCB		KRP50-2A90	
	For heater control kit		BRP4A50	
Miscellaneous	Replacement air filter	YAFF323F15	YAFF323F25	
	High-efficiency filter	YAFM323F15	YAFM323F25	

Notes

- * BRC1E52A Included languages are: English, German, French, Dutch, Spanish, Italian, Greek, Portuguese, Russian, Turkish, and Polish.
- * BRC1E52B Included languages are: English, German, Albanian, Bulgarian, Croatian, Czech, Hungarian, Romanian, Serbian, Slovak, and Slovenian.
- ** To install adaptor PCBs -KRP2A61, KRP2A51, KRP50-2-, installation box -KRP50-2A90- is required.
- *** Up to 2- adaptor PCBs can be fixed per installation.
- Only one installation box can be installed per indoor unit.

3D099234B

VAM350-2000FC

Type Ceiling-mounted Installation with duct

Item		Model							
		VAM350FCVE	VAM500FCVE	VAM650FCVE	VAM800FCVE	VAM1000FCVE	VAM1500FCVE	VAM2000FCVE	
Control systems	Remote control	BRC301B61							
	Remote control Wired type	BRC1D52							
		BRC1E52A / BRC1E52B *							
		DCS302C51							
	Centralised control systems	Unified ON/OFF controller	DCS301B51						
		Schedule timer	DTS301B51						
		iTouch Manager	DCM601A51						
		iTouch Controller	DCS601C51						
		iTab Controller	DCC601A51						
		Modbus -DIII- adaptor	EKMBDXA7V1						
		Adaptor PCB	Wiring adaptor for electrical appendices	KRP2A51 + Installation box -KRP1BA101-					
	For heaters or humidifiers		BRP4A50A						
	Mounting plate		----					EKMPVAM **	
	Miscellaneous	Silencer	Model	---	KDDM24850	KDDM248100	KDDM248100	KDDM248100	KDDM248100 x 2
Outside diameter (mm)			---	Ø200	Ø200	Ø250	Ø250	Ø250	
High-efficiency filter		EN779 M6	EKAFV50F6		EKAFV80F6		EKAFV100F6		
		EN779 F7	EKAFV50F7		EKAFV80F7		EKAFV100F7		
	EN779 F8	EKAFV50F8		EKAFV80F8		EKAFV100F8			
CO2 Sensor		BRYMA65	BRYMA65	BRYMA65	BRYMA100	BRYMA100	BRYMA200	BRYMA200	

Notes

- * BRC1E52A Included languages are: English, German, French, Dutch, Spanish, Italian, Greek, Portuguese, Russian, Turkish, and Polish.
- * BRC1E52B Included languages are: English, German, Albanian, Bulgarian, Croatian, Czech, Hungarian, Romanian, Serbian, Slovak, and Slovenian.
- ** To install an adaptor PCB on -VAM1500FC/VAM2000FC- units, mounting plate -EKMPVAM- is required.
- Humidifiers and heaters cannot be combined.
- If you order 1 filter set, you can use it for either supply side or exhaust side. To provide both sides with filters, 2 filter sets are required.

3D099233B

6

4 Exchange efficiency

4 - 1 Exchange efficiency

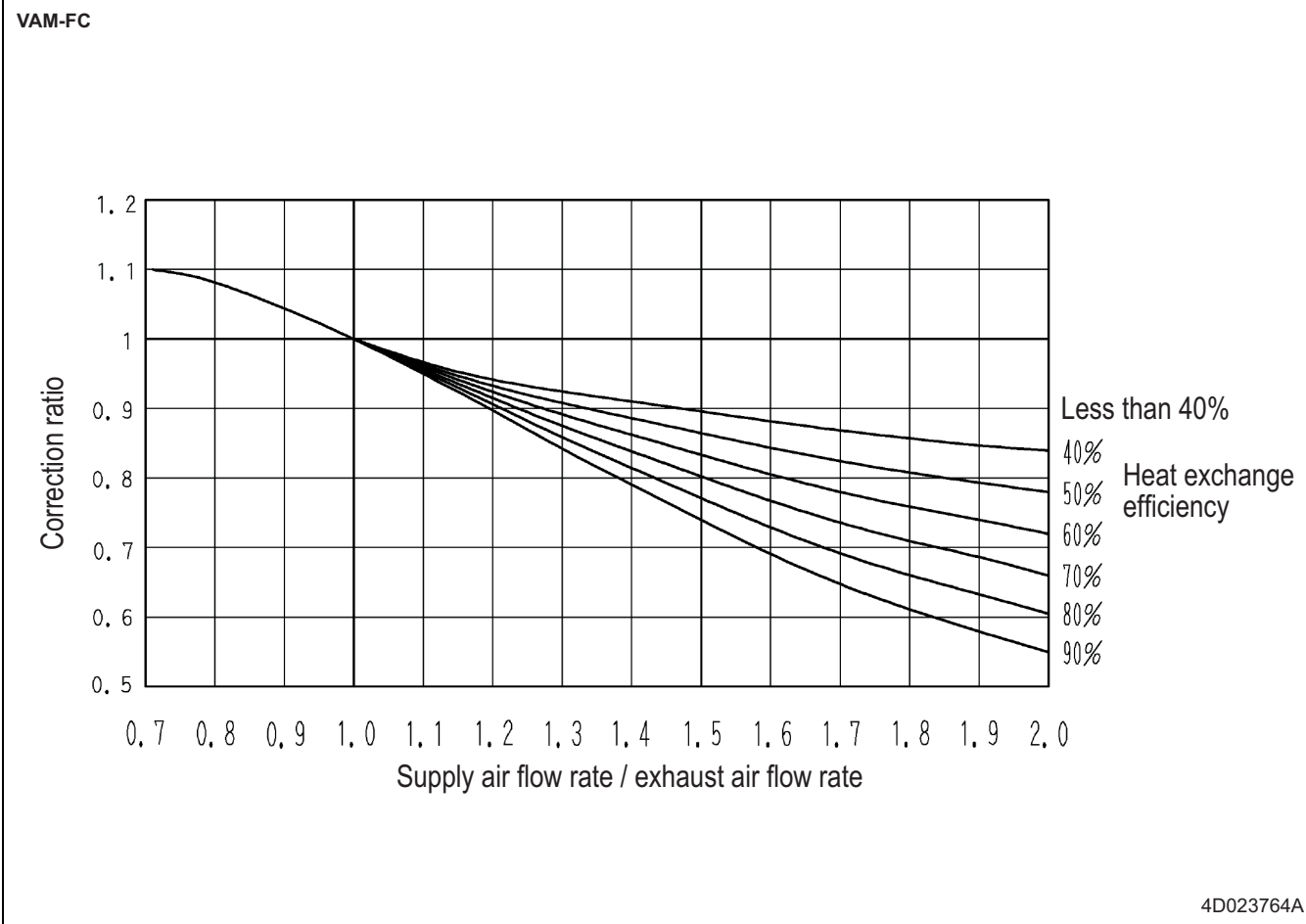
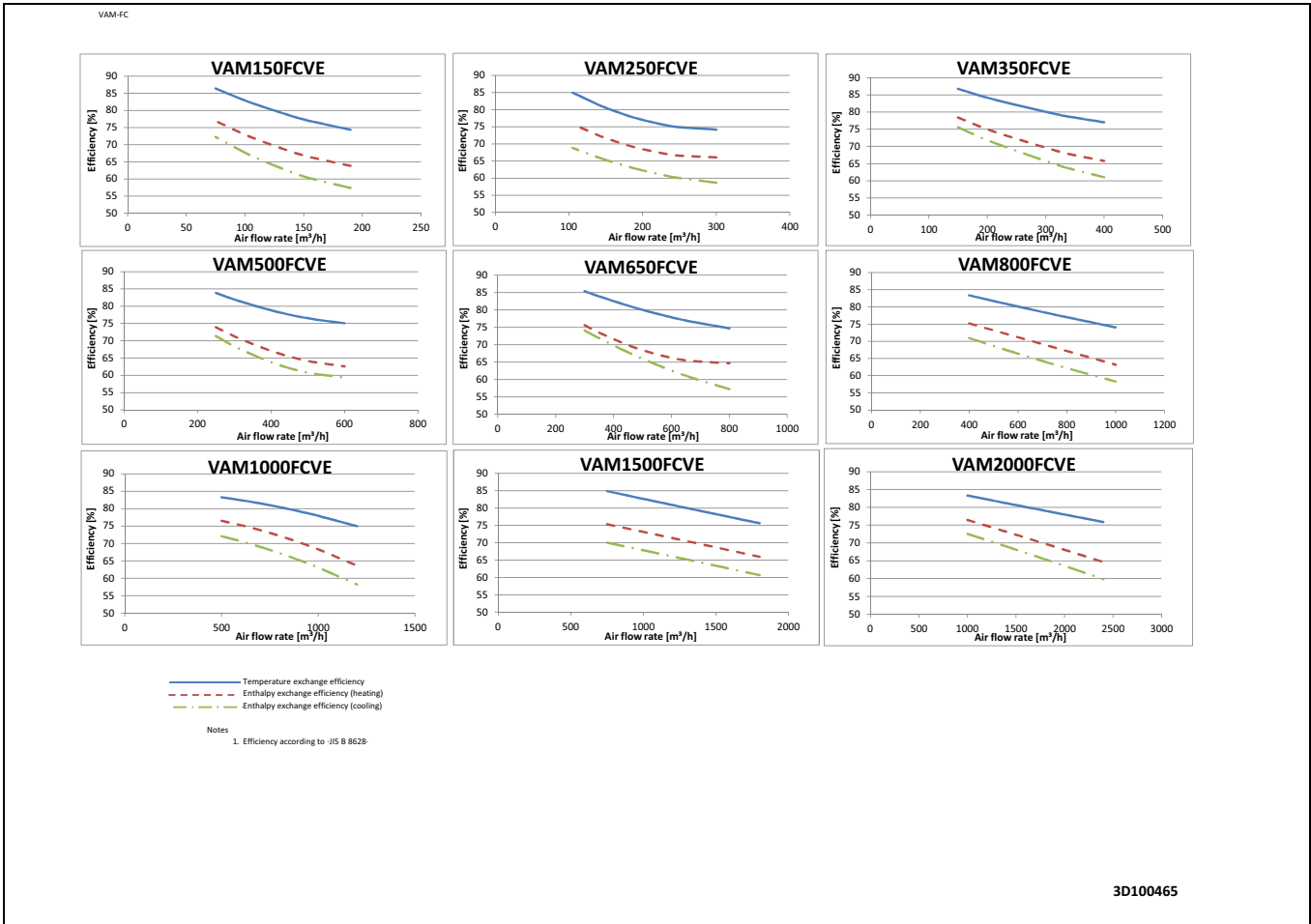

5 Dimensional drawings

5 - 1 Dimensional Drawings

5

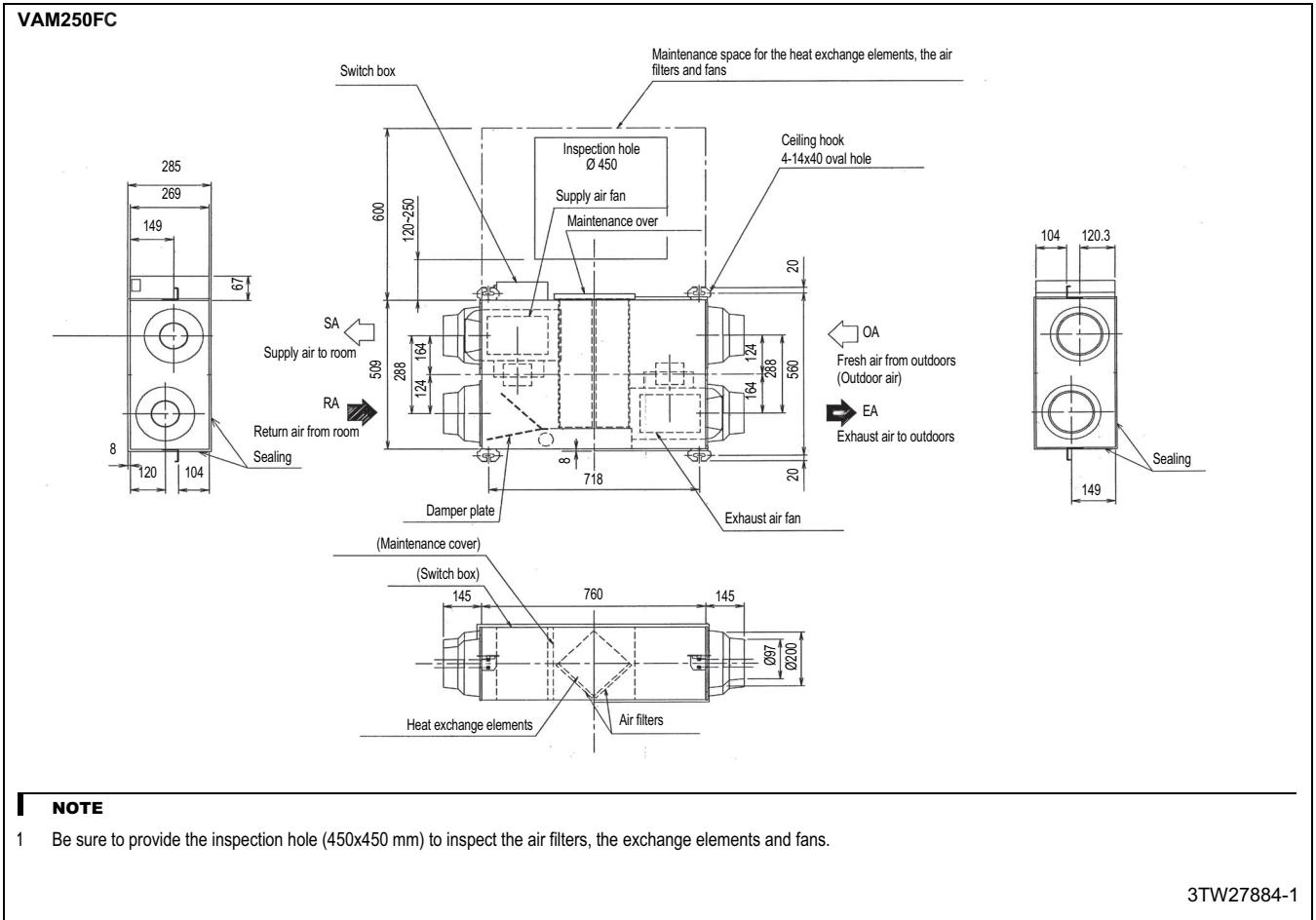
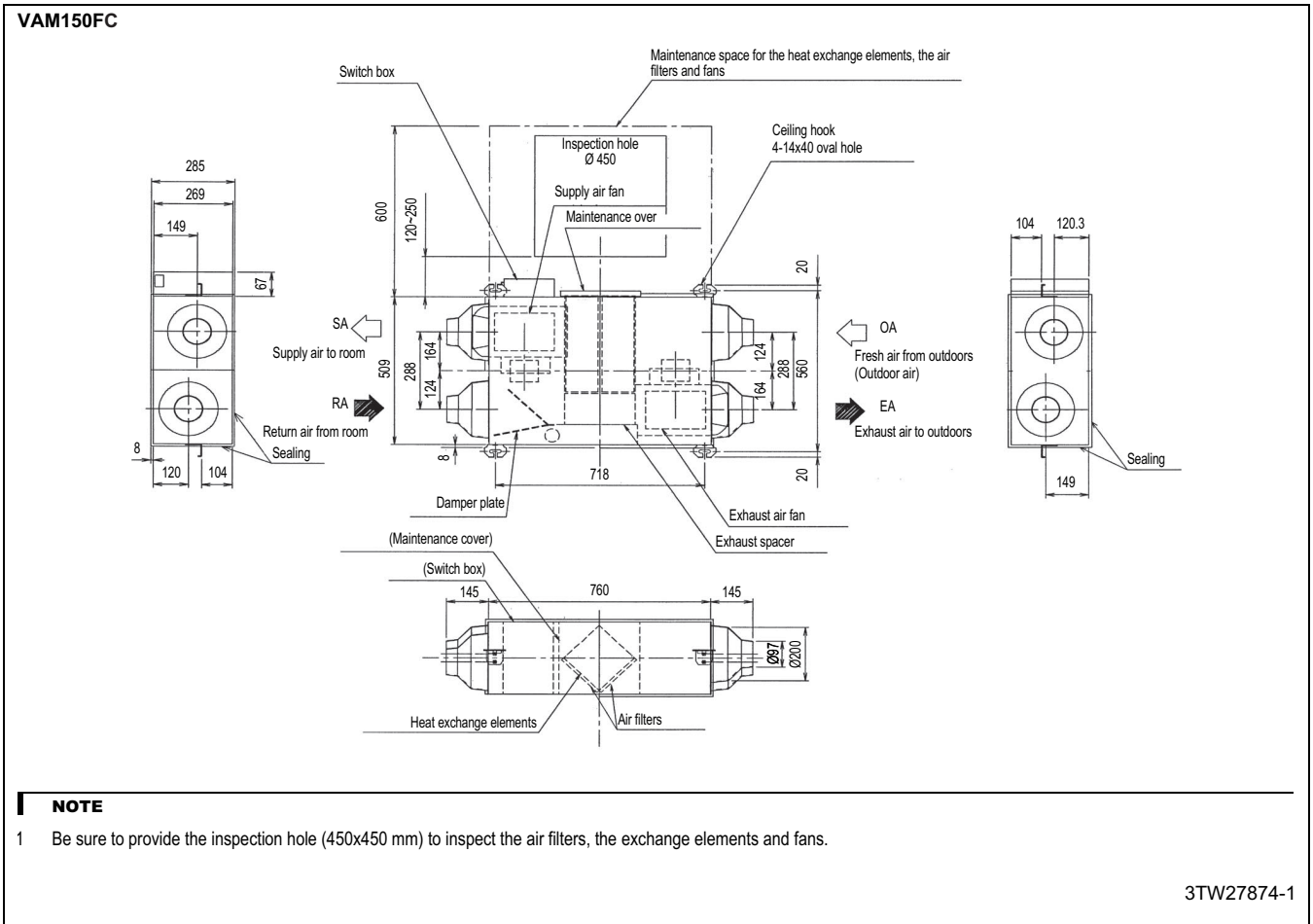

5 Dimensional drawings

5 - 1 Dimensional Drawings

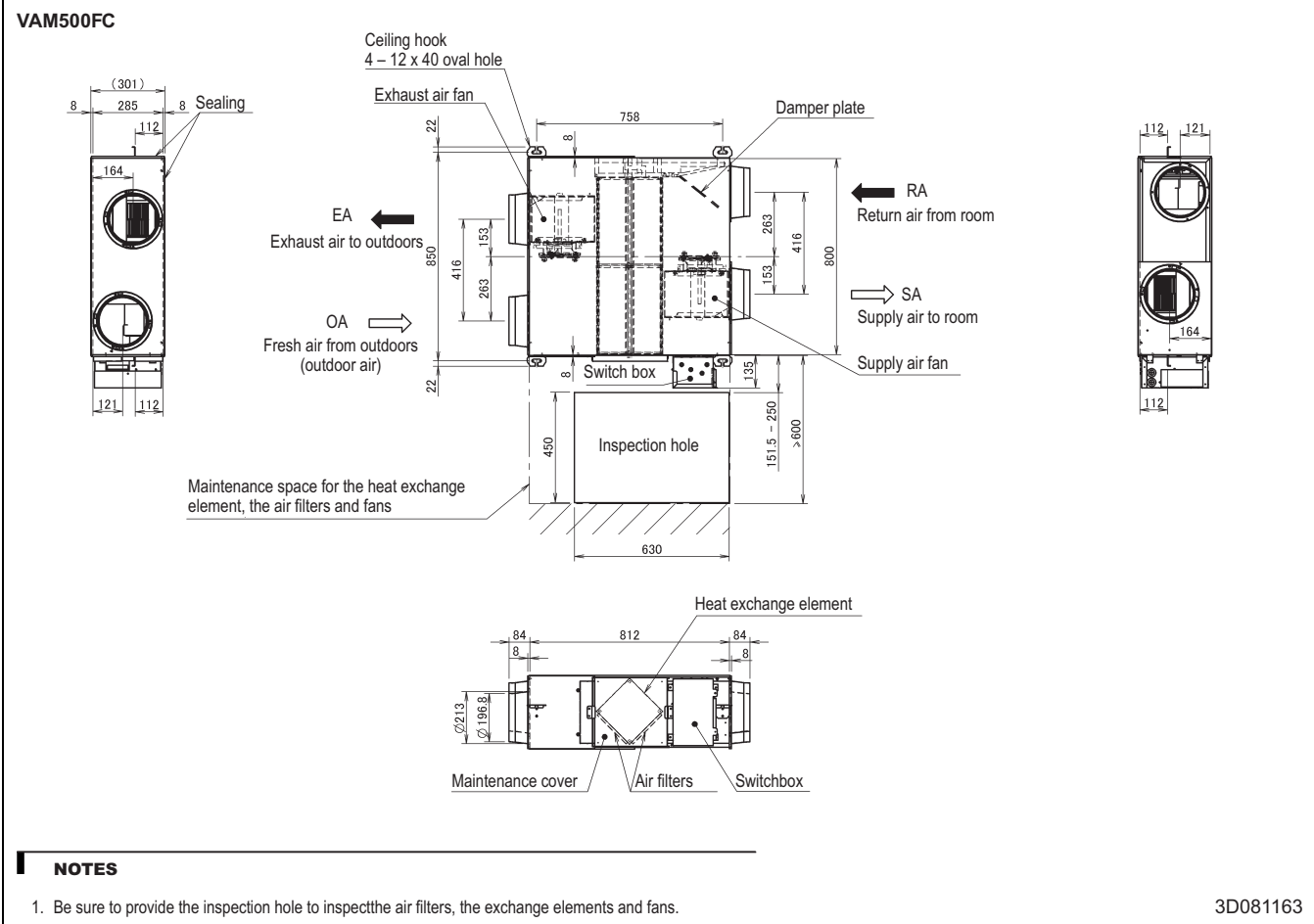
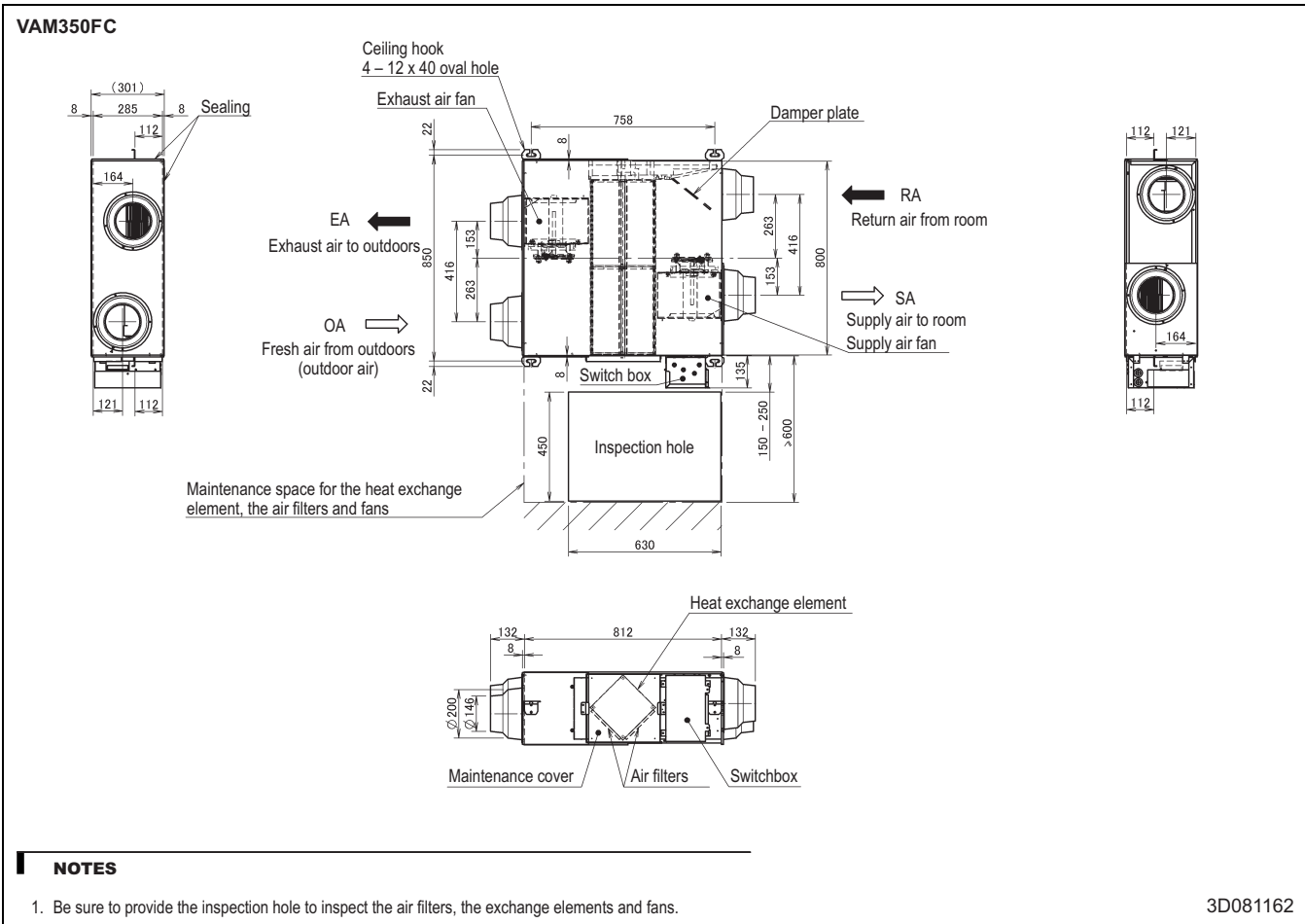

5 Dimensional drawings

5 - 1 Dimensional Drawings

5

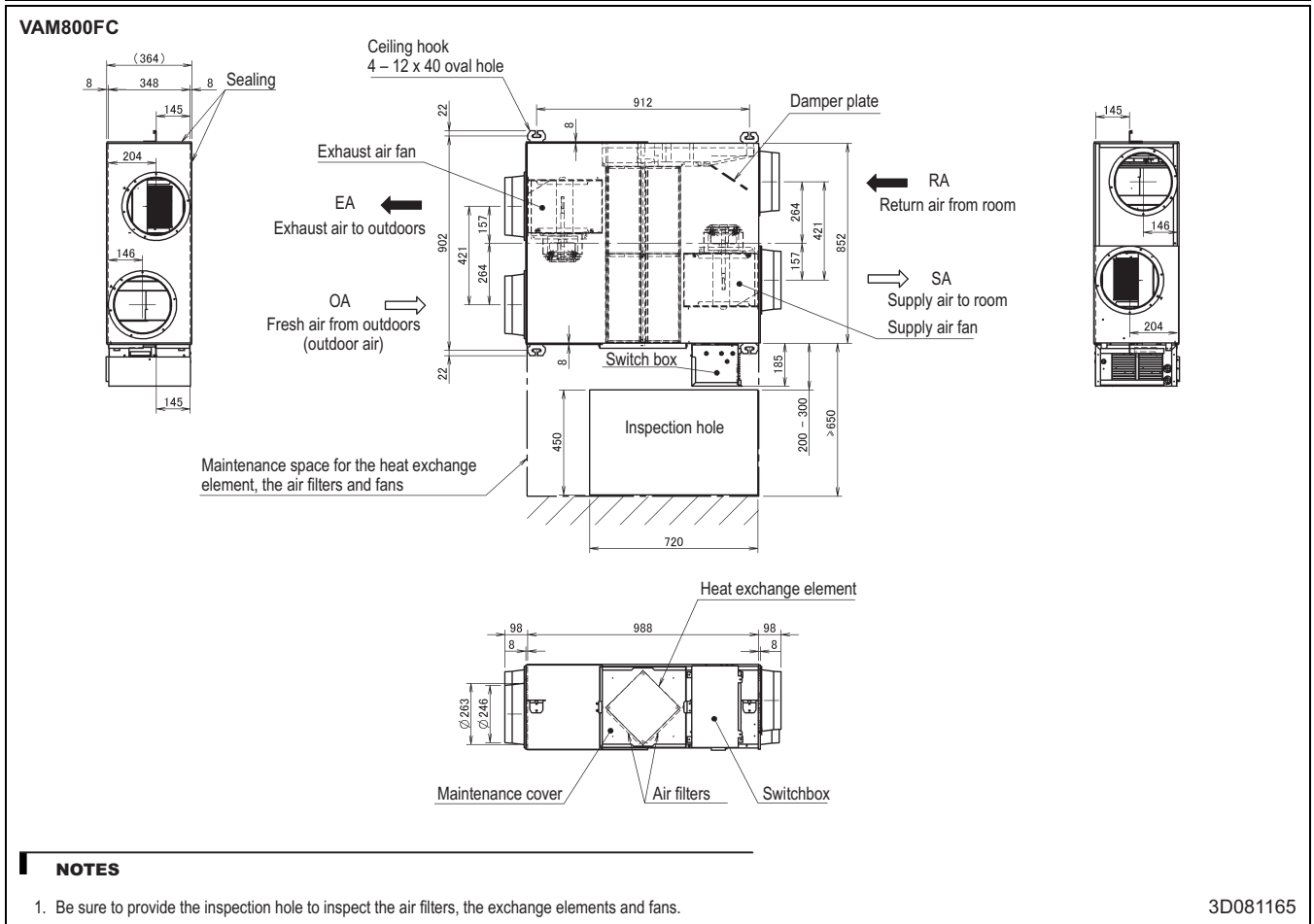
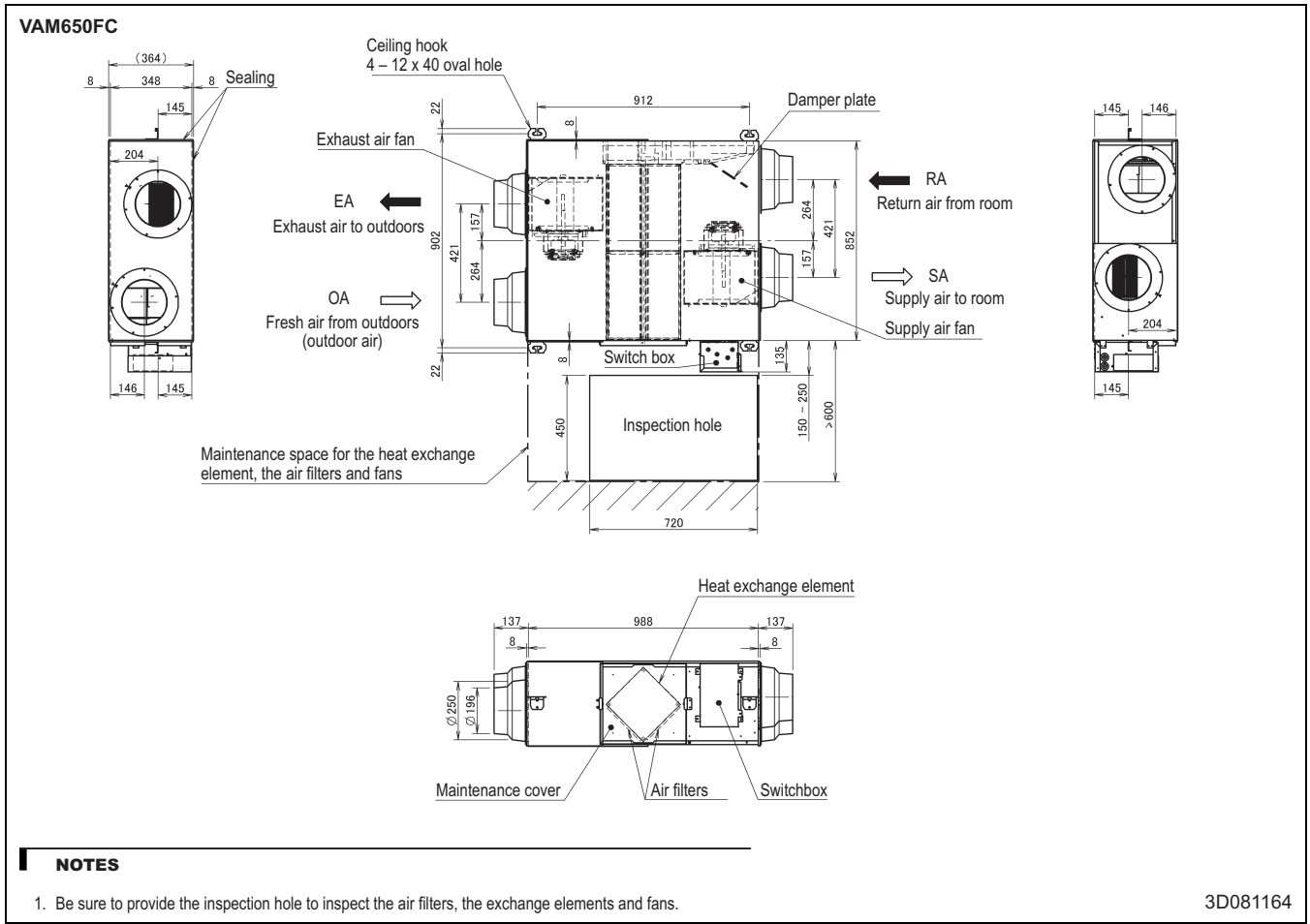

5 Dimensional drawings

5 - 1 Dimensional Drawings

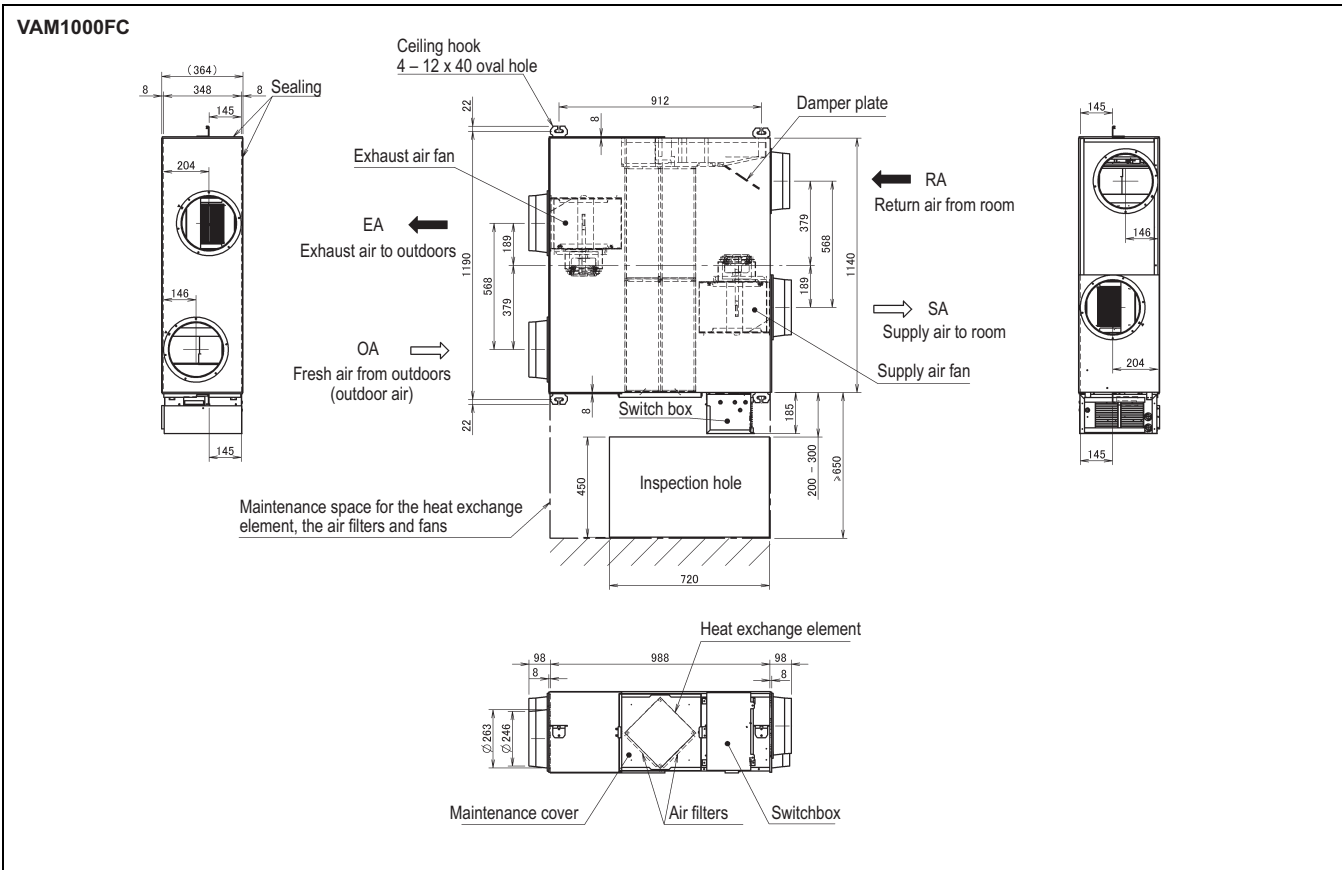

NOTES

1. Be sure to provide the inspection hole to inspect the air filters, the exchange elements and fans. 3D081166

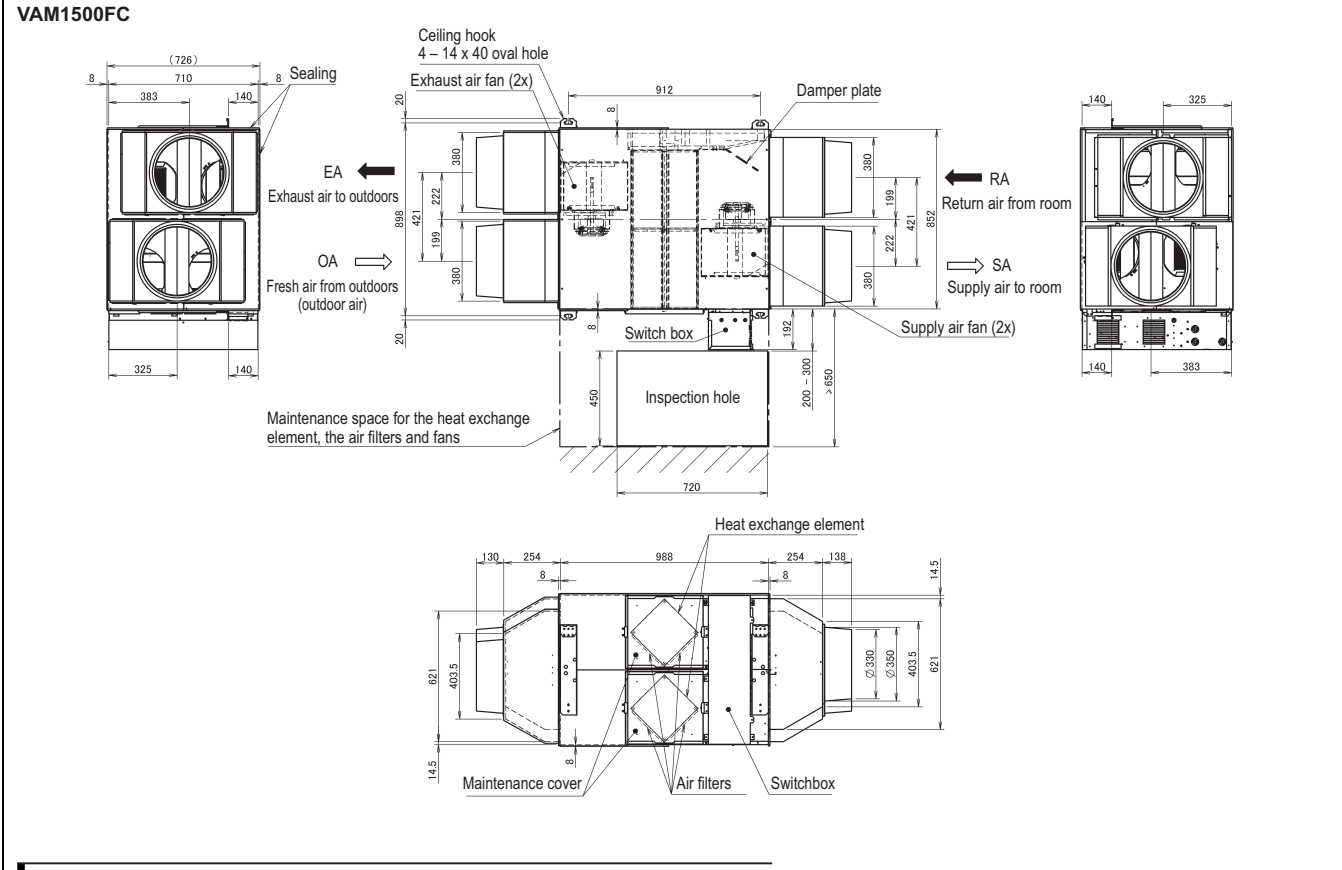

NOTES

1. Be sure to provide the inspection hole to inspect the air filters, the exchange elements and fans. 3D081167

5 Dimensional drawings

5 - 1 Dimensional Drawings

5

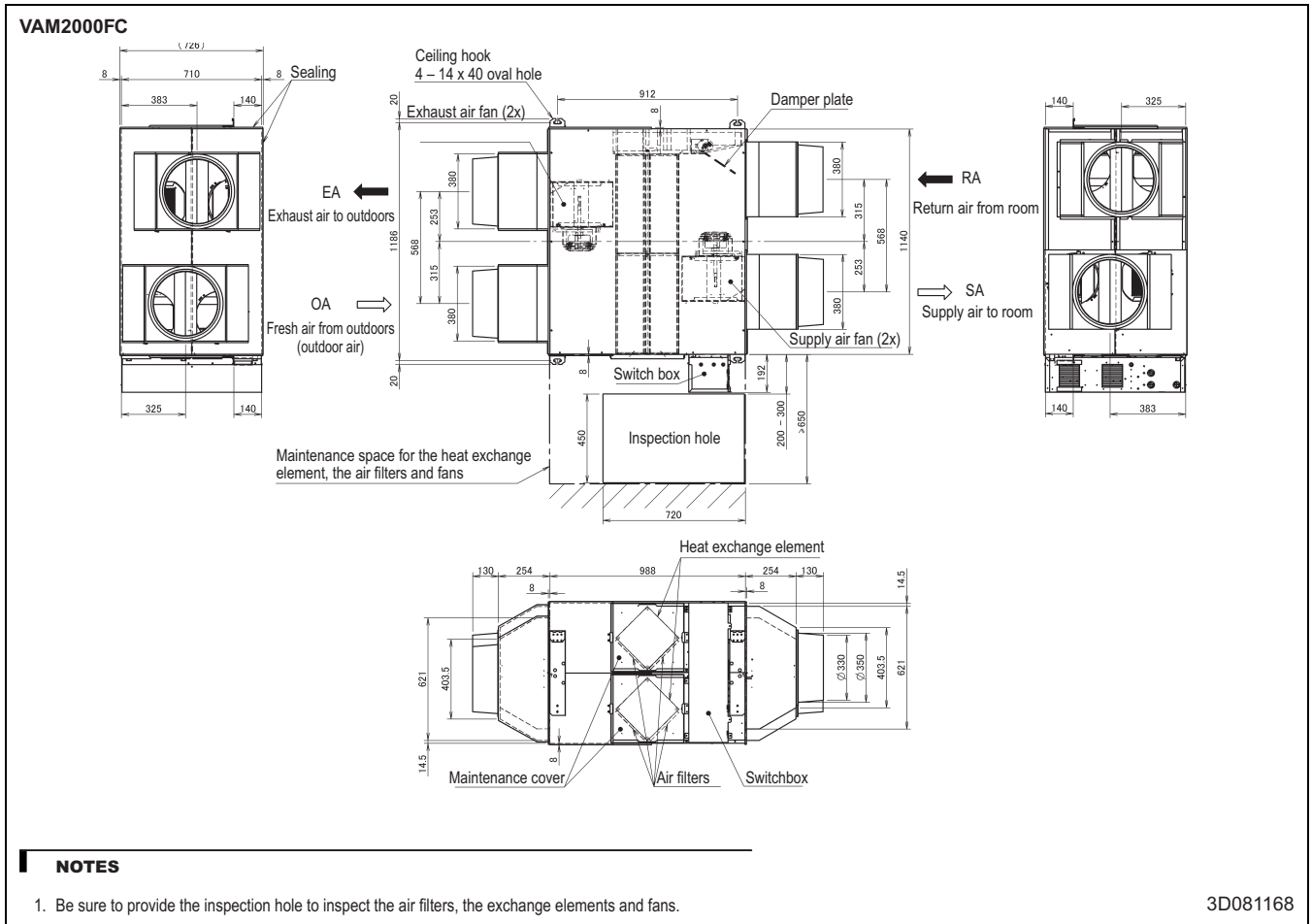

6 Centre of gravity

6 - 1 Centre of Gravity

VAM350-500FC

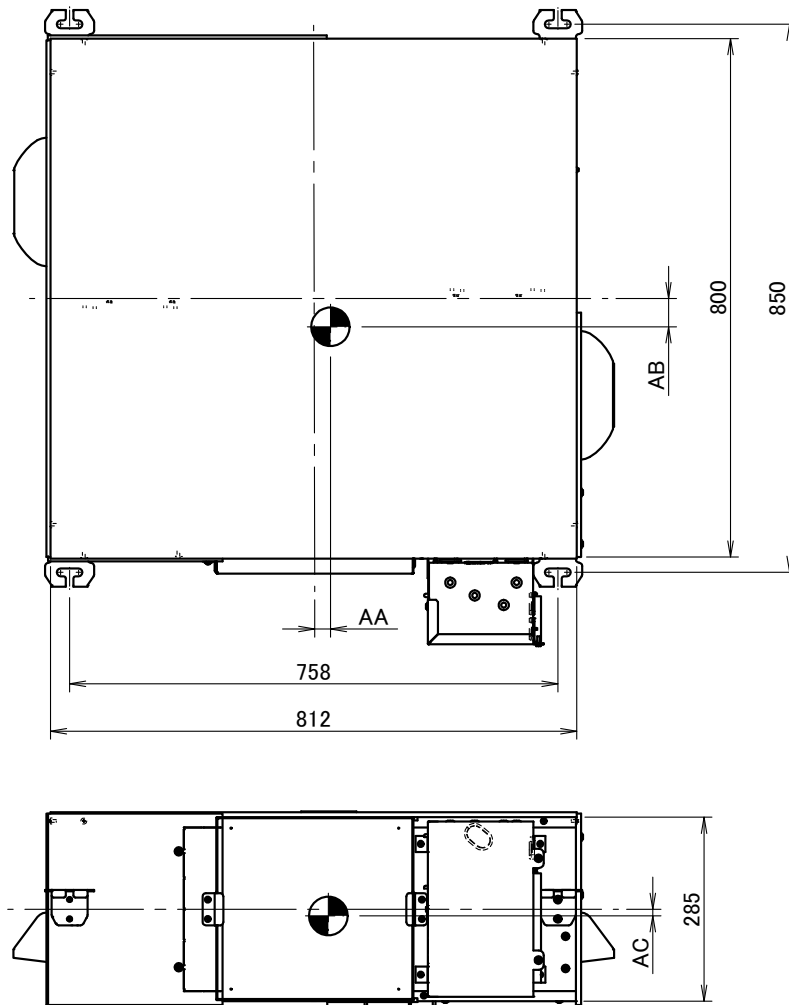

Unit	AA	AB	AC
VAM350*	24	51	10
VAM500*	23	36	9

4D081262A

6 Centre of gravity

6 - 1 Centre of Gravity

VAM650-800FC

6

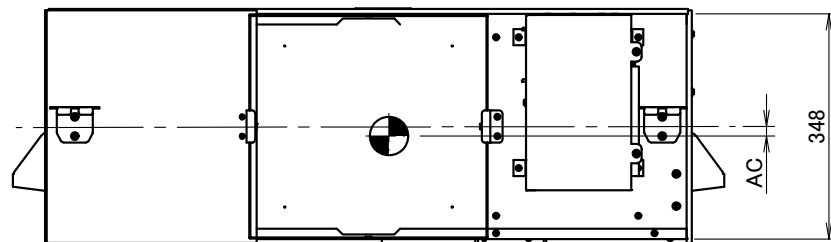
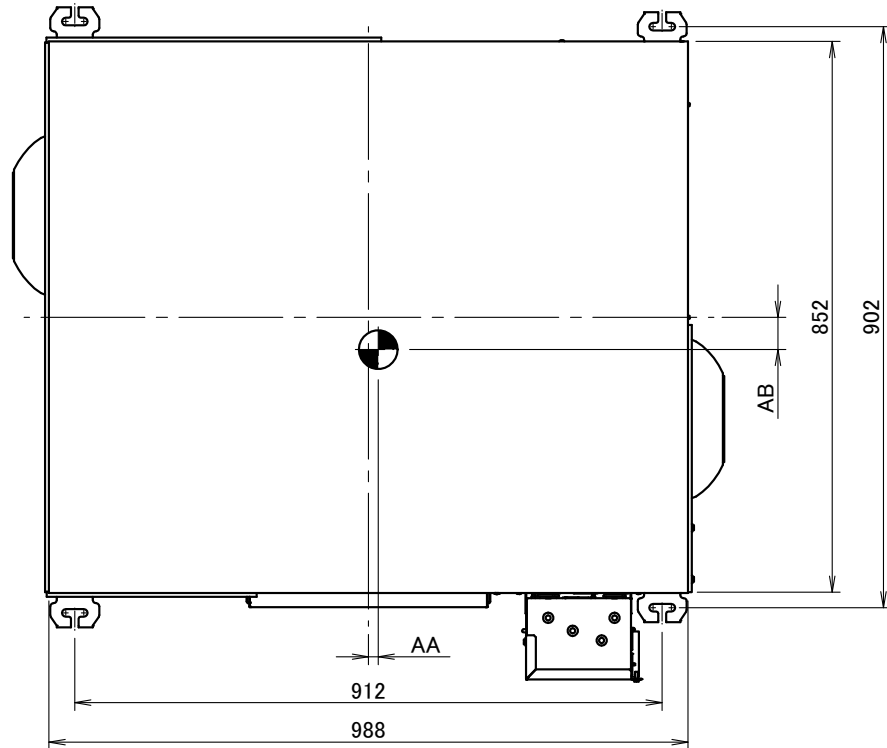

Unit	AA	AB	AC
VAM650*	20	42	6
VAM800*	32	58	5

4D081263A

6 Centre of gravity

6 - 1 Centre of Gravity

VAM1000FC

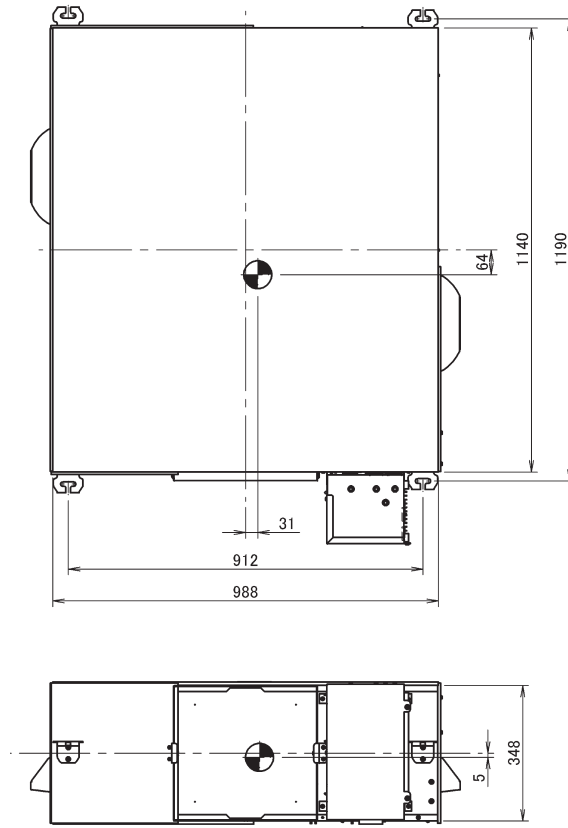

4D081264

VAM1500FC

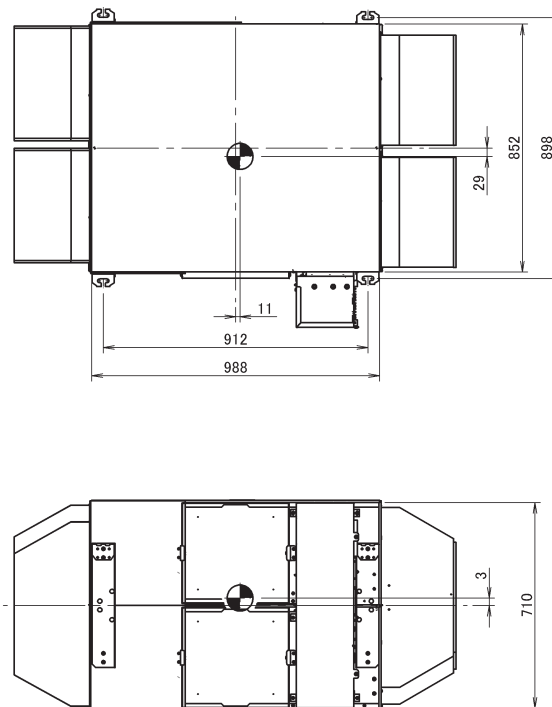

4D081265

6 Centre of gravity

6 - 1 Centre of Gravity

6

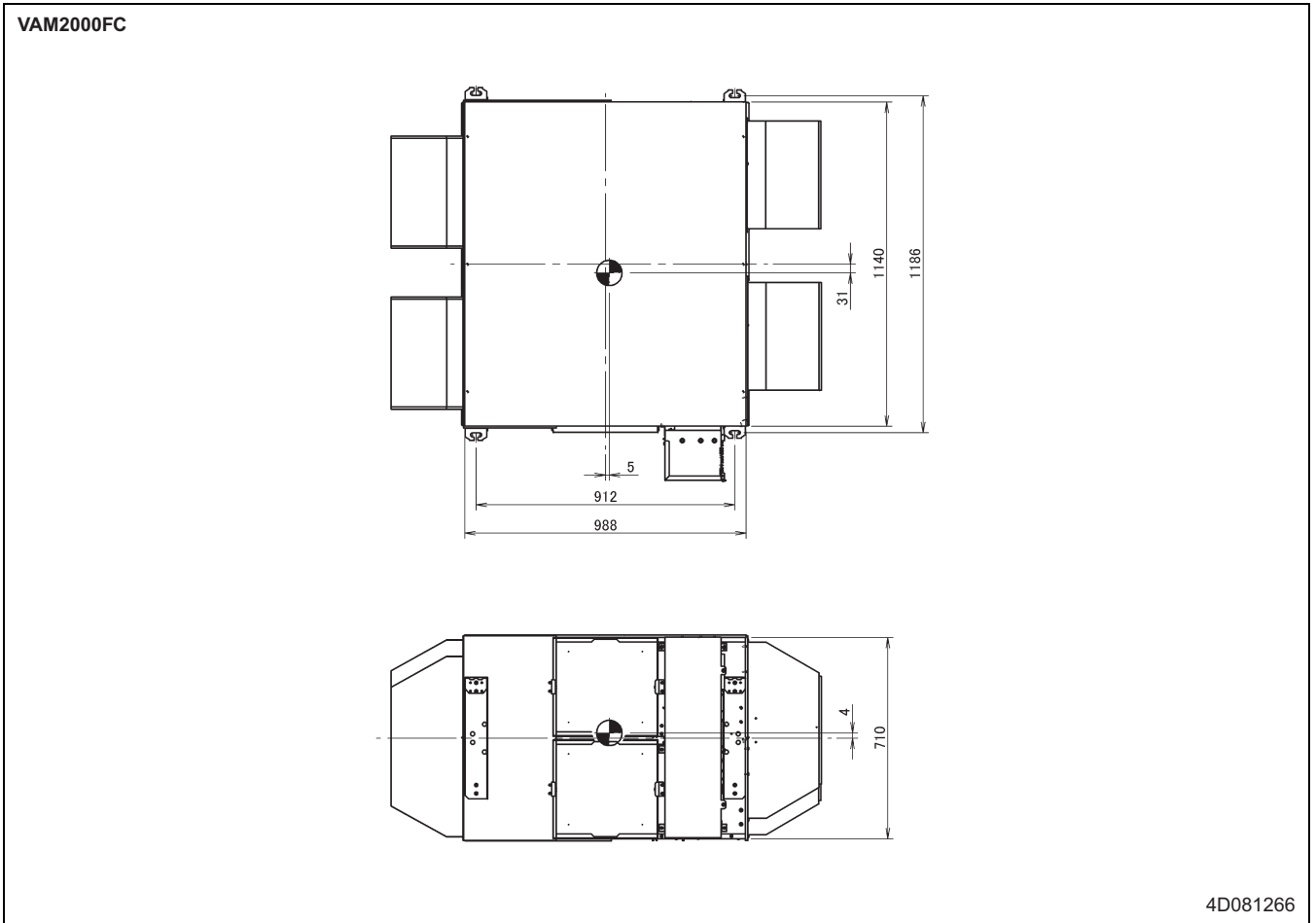

7 Wiring diagrams

7 - 1 Wiring Diagrams - Single Phase

VAM150-250FC

Power supply
Single phase
220-240V/220V
50/60Hz

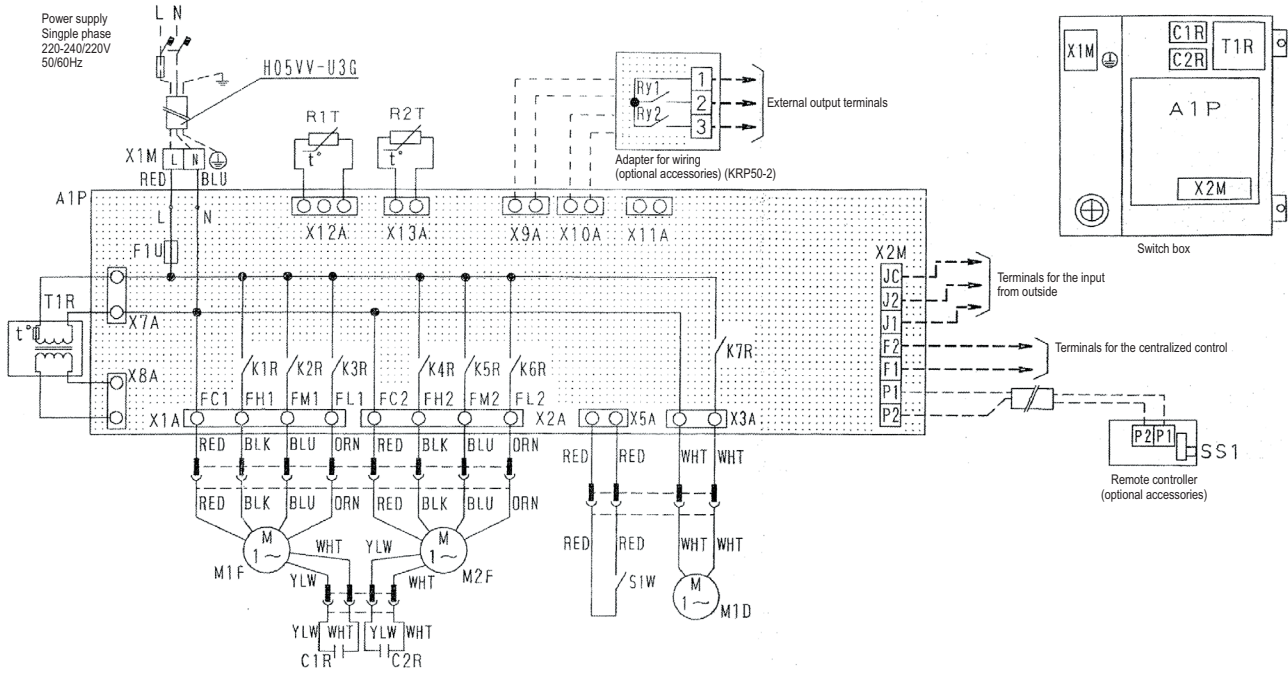

L-RED	N-BLU	M2F	Motor (exhaust fan motor)	Optional Accessories
A1P	Printed circuit board	Q1L-Q2L	Thermo switch (MF1-2 built-in)	Adapter for wiring (KRP50-2)
C1R-C2R	Capacitor (M1F · M2F)	R1T	Thermistor (indoor air)	Ry1 Magnetic relay (ON/OFF)
F1U	Fuse (250V, 10A)	R2T	Thermistor (outdoor air)	Ry2 Magnetic relay (humidifier operation)
K1R-K3R	Magnetic relay (M1F)	S1W	Limit switch	X9A-10A Connector (KRP50-2)
K4R-K6R	Magnetic relay (M2F)	T1R	Transformer (supply 220-240V/22V)	Remote Controller
K7R	Magnetic relay (M1D)	X1M	Terminal (power supply)	SS1 Selector switch (main/sub)
M1D	Motor (damper motor)	X2M	Terminal (control)	Optional connector
M1F	Motor (air supply fan motor)			X11A Connector (adapter power supply)

NOTES

- : terminals
- : wire clamp, □ : connector
- : field wiring
- ⊕ : protective earth
- Symbols show as follows: BLK: Black, RED: Red, BLU: Blue, WHT: White, YLW: Yellow, ORN: Orange, GRN: Green

⚠ CLEANING PRECAUTIONS:
Clean the heat exchange elements once every two years or more often and the air filter once a year or more often. (Before cleaning, make sure that the unit is not operating).

⚠
Before obtaining access to terminal devices, all power supply circuits must be interrupted.

⊕ Grounding
To prevent electric shock hazards, provide grounding work according to the installation manual.

7 Wiring diagrams

7 - 1 Wiring Diagrams - Single Phase

7

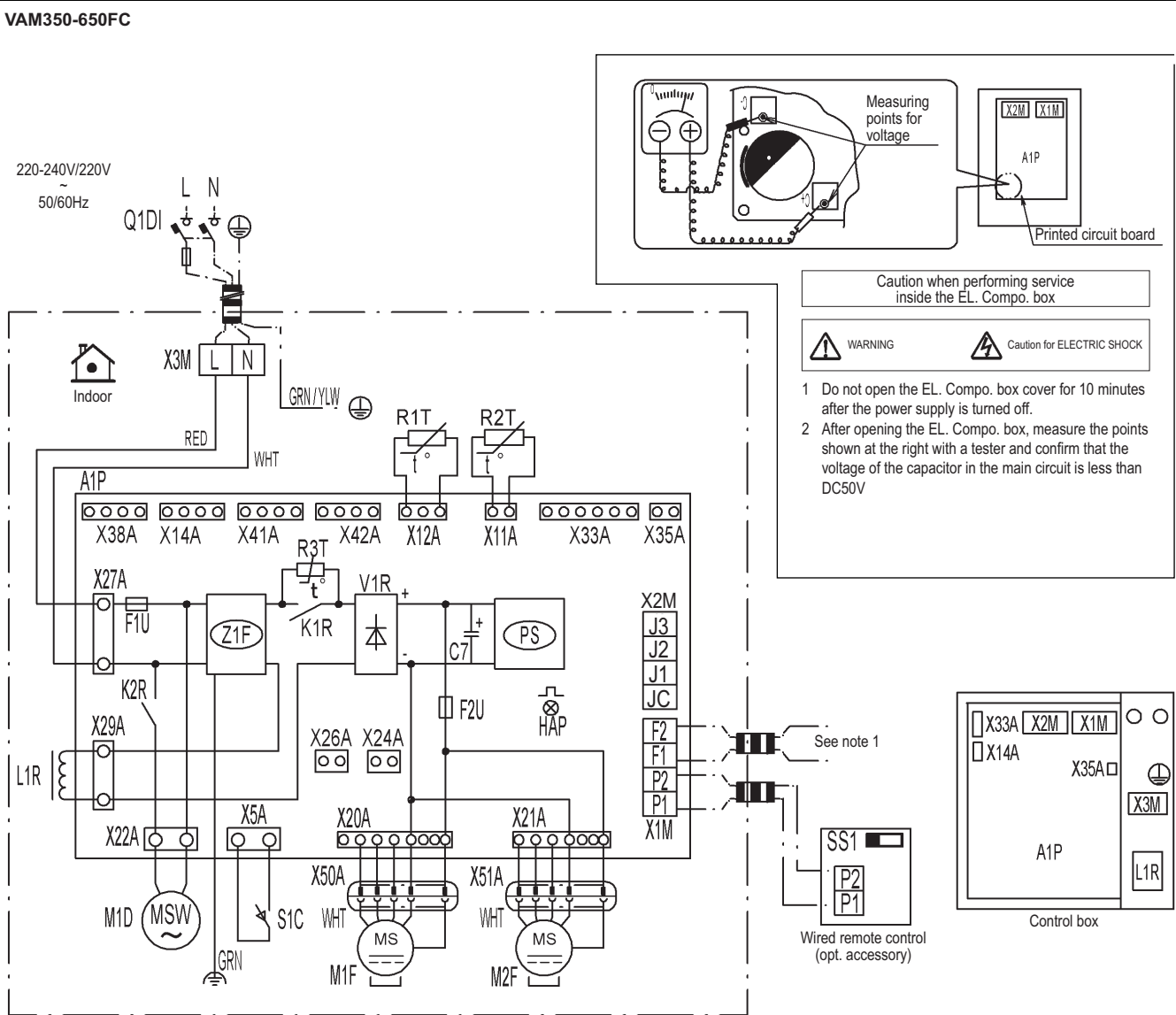

A1P	Printed circuit board	Q1DI	Field earth leak detector (Max. 300 mA)	REMOTE CONTROL	
C1	Capacitor (M1F)	R1T	Thermistor (Indoor air)	SS1	Selector switch
F1U	Fuse T, 6.3A, 250V (A1P)	R2T	Thermistor (Outdoor air)	CONNECTOR FOR OPTION (See note 3)	
F1U	Fuse T, 5A, 250V (A1P)	R3T	Thermistor (PTC)	X14A	Connector (CO ₂ sensor)
HAP	Pilot lamp (Service monitor - green)	S1C	Limit switch damper motor	X24A	Connector (Outside damper)
K1R	Magnetic relay	X1M	Terminal (A1P)	X28A	Connector (Filter sign)
K2R	Magnetic relay	X2M	Terminal (Outside input) (A1P)	X33A	Connector (Contact PCB)
L1R	Reactor	X3M	Terminal (Power supply)	X35A	Connector (Appendices PCB)
M1F	Motor (Supply air fan)	X41A	Connector (Humidity sensor 1)	X42A	Connector (Humidity sensor 2)
M2F	Motor (Exhaust air fan)	V1R	Diode bridge		
M1D	Motor (Damper)	Z1F	Noise filter		
PS	Switching power supply (A1P)				

- L : Live
- N : Neutral
- Field wiring
- Terminal strip
- Connector
- Connection
- Relay connector
- Protective earth (screw)
- Noiseless earth
- Colors: BLK: Black
- BLU: Blue
- ORG: Orange
- RED: Red
- WHT: White
- YLW: Yellow
- GRN: Green

3D080682C

- NOTES**
- In case you use the central remote control, connect it to the unit in accordance with the attached manual.
 - When connecting the input wires from outside, fresh-up or on/off control operation can be selected. (Contact with a minimum applicable load of 12V DC, 1mA)
 - For details of connection see the attached manual of the option kit.
 - SS1 (A1P) has already been set to "nor." at factory set. The unit will not run if the setting is changed.

7 Wiring diagrams

7 - 1 Wiring Diagrams - Single Phase

VAM800-1000FC

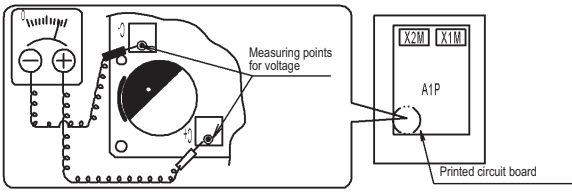

Caution when performing service inside the EL. Compo. box



WARNING



Caution for ELECTRIC SHOCK

- 1 Do not open the EL. Compo. box cover for 10 minutes after the power supply is turned off.
- 2 After opening the EL. Compo. box, measure the points shown at the right with a tester and confirm that the voltage of the capacitor in the main circuit is less than DC50V

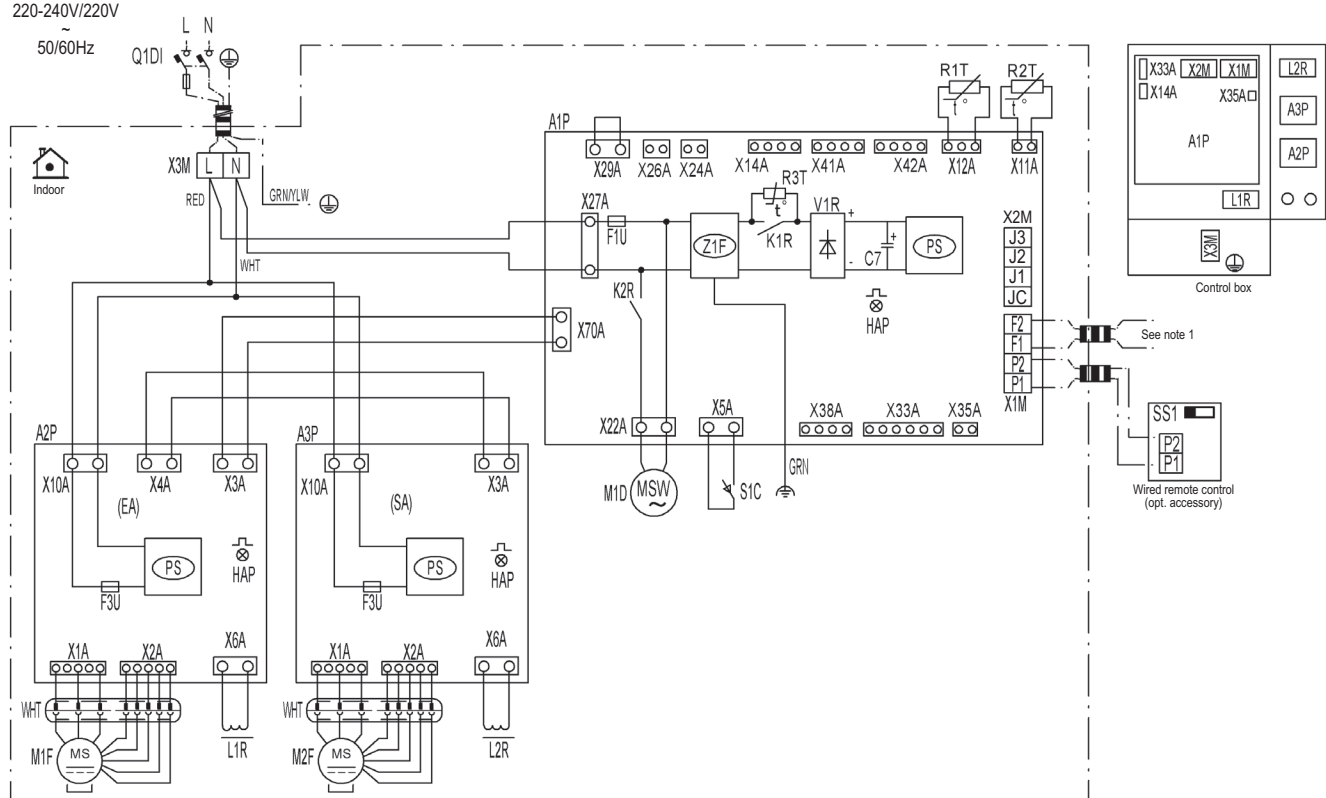

A1P	Printed circuit board	M1D	Motor (Damper)	REMOTE CONTROL	
A2P	Printed circuit board assy (Fan)	PS	Switching power supply (A1P)	SS1	Selector switch
A3P	Printed circuit board assy (Fan)	Q1DI	Field earth leak detector (Max. 300 mA)	CONNECTOR FOR OPTION (See note 3)	
C1	Capacitor (M1F)	R1T	Thermistor (Indoor air)	X14A	Connector (CO ₂ sensor)
F1U	Fuse T, 6.3A 250V (A1P)	R2T	Thermistor (Outdoor air)	X24A	Connector (Outside damper)
F3U	Fuse T, 6.3A, 250V (A2P,A3P)	R3T	Thermistor (PTC)	X26A	Connector (Filter sign)
HAP	Pilot lamp (Service monitor - green)	S1C	Limit switch damper motor	X33A	Connector (Contact PCB)
K1R	Magnetic relay	X1M	Terminal (A1P)	X35A	Connector (Appendices PCB)
K2R	Magnetic relay	X2M	Terminal (Outside input) (A1P)	X41A	Connector (Humidity sensor 1)
L1R	Reactor	X3M	Terminal (Power supply)	X42A	Connector (Humidity sensor 2)
L2R	Reactor	V1R	Diode bridge		
M1F	Motor (Supply air fan)	Z1F	Noise filter		
M2F	Motor (Exhaust air fan)				

- | | | | |
|--------------------|------------------------------|--------------------|-------------|
| L : Live | ⬮ : Connection | Colors: BLK: Black | WHT: White |
| N : Neutral | ⬮ : Relay connector | BLU: Blue | YLW: Yellow |
| ⬮ : Field wiring | ⊕ : Protective earth (screw) | ORG: Orange | GRN: Green |
| □ : Terminal strip | ⚡ : Noiseless earth | RED: Red | |
| ⊞ : Connector | | | |

2D080683B

NOTES

- 1 In case you use the central remote control, connect it to the unit in accordance with the attached manual.
- 2 When connecting the input wires from outside, fresh-up or on/off control operation can be selected. (Contact with a minimum applicable load of 12V DC, 1mA)
- 3 For details of connection see the attached manual of the option kit.
- 4 SS1 (A1P) has already been set to "nor." at factory set. The unit will not run if the setting is changed.

7 Wiring diagrams

7 - 1 Wiring Diagrams - Single Phase

7

VAM1500-2000FC

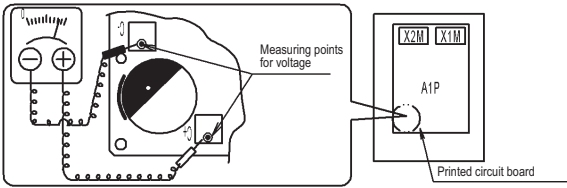

Caution when performing service inside the EL. Compo. box



- 1 Do not open the EL. Compo. box cover for 10 minutes after the power supply is turned off.
- 2 After opening the EL. Compo. box, measure the points shown at the right with a tester and confirm that the voltage of the capacitor in the main circuit is less than DC50V

220-240V/220V

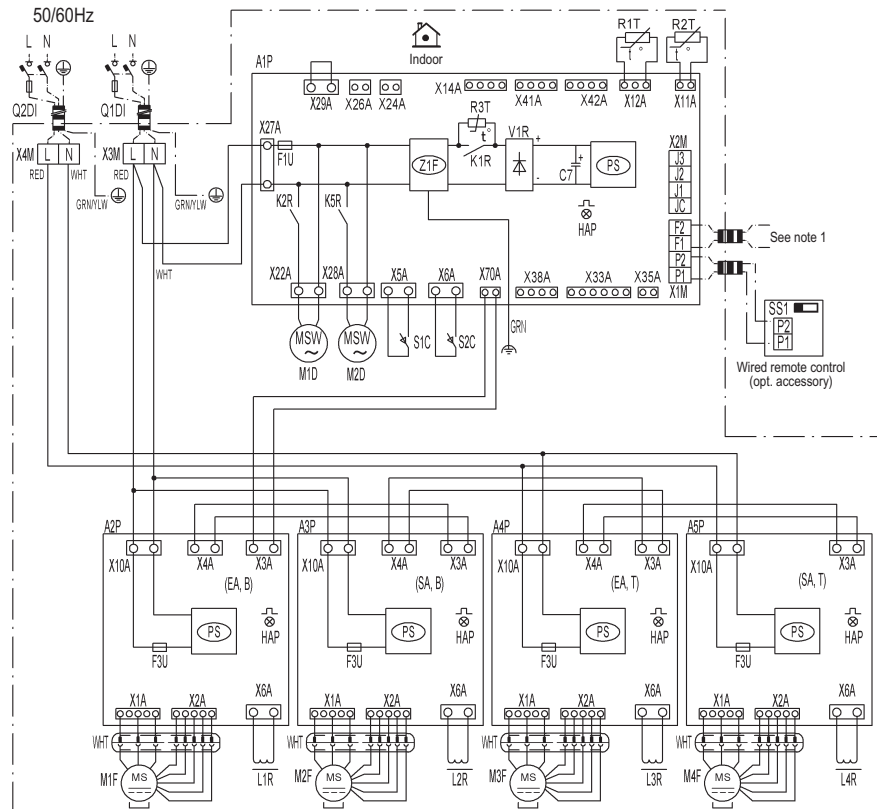

A1P	Printed circuit board	M4F	Motor (Supply air fan) (Top)	V1R	Diode bridge
A2P-A4P	Printed circuit board Assy (Fan)	M1D,M2D	Motor (Damper)	Z1F	Noise filter
A5P	Printed circuit board Assy (Fan)	PS	Switching power supply (A1P)	REMOTE CONTROL	
C1	Capacitor (M1F)	Q1DI, Q2DI	Field earth leak detector (Max. 300 mA)	SS1	Selector switch
F1U	Fuse T, 6.3A, 250V (A1P)	R1T, R2T	Thermistor (Indoor air)	CONNECTOR FOR OPTION (See note 3)	
F3U	Fuse T, 6.3A, 250V (A2P, A3P, A4P, A5P)	R3T	Thermistor (PTC)	X14A	Connector (CO ₂ sensor)
HAP	Pilot lamp (Service monitor - green)	S1C, S2C	Limit switch damper motor	X24A	Connector (Outside damper)
K1R, K5R	Magnetic relay	X1M	Terminal (A1P)	X26A	Connector (Filter sign)
L1R-L4R	Reactor	X2M	Terminal (Outside input) (A1P)	X33A	Connector (Contact PCB)
M1F	Motor (Exhaust air fan) (Bottom)	X3M	Terminal (Power supply)	X35A	Connector (Appendices PCB)
M2F	Motor (Supply air fan) (Bottom)	X41A		X41A	Connector (Humidity sensor 1)
M3F	Motor (Exhaust air fan) (Top)	X42A		X42A	Connector (Humidity sensor 2)

- L : Live
- N : Neutral
- Field wiring
- Terminal strip
- Connector
- Connection
- Relay connector
- Protective earth (screw)
- Noiseless earth

- Colors: BLK: Black
- BLU: Blue
- ORG: Orange
- RED: Red
- WHT: White
- YLW: Yellow
- GRN: Green

2D080684B

NOTES

- 1 In case you use the central remote control, connect it to the unit in accordance with the attached manual.
- 2 When connecting the input wires from outside, fresh-up or on/off control operation can be selected. (Contact with a minimum applicable load of 12V DC, 1mA)
- 3 For details of connection see the attached manual of the option kit.
- 4 SS1 (A1P) has already been set to "nor." at factory set. The unit will not run if the setting is changed.

8 Sound data

8 - 1 Sound Power Spectrum

VAM150FC

Sound power

Model	Fan speed	Hz								Total
		63	125	250	500	1000	2000	4000	8000 [dB]	
VAM150FCVE	U-H	57	55	48	44	41	33	27	22	46
	H	56	54	47	43	40	32	26	22	45
	L	55	49	43	37	33	25	22	23	40

Notes

1. dBA = A-weighted sound power level (A scale according to IEC).
2. Reference acoustic intensity 0dB = $10E-6\mu W/m^2$
3. Measured according to ISO 3744
4. Depending on the operating conditions, reflected sound, and peripheral noise, the operating sound may become higher than this value.

4D099265A

8 Sound data

8 - 1 Sound Power Spectrum

8

VAM250FC

Sound power

Model	Fan speed	Hz								
		63	125	250	500	1000	2000	4000	8000 [dB]	Total [dBA]
VAM250FCVE	U-H	61	59	52	47	44	37	31	26	50
	H	60	58	51	46	43	36	29	26	49
	L	57	51	45	40	35	27	25	26	42

Notes

1. dBA = A-weighted sound power level (A scale according to IEC).
2. Reference acoustic intensity 0dB = 10E-6μW/m²
3. Measured according to ISO 3744
4. Depending on the operating conditions, reflected sound, and peripheral noise, the operating sound may become higher than this value.

4D099266A

8 Sound data

8 - 1 Sound Power Spectrum

VAM350FC

Power level data (in case of Total Heat Exchange mode)

(dB) (dBA)

Unit model name	Fan speed	Hz								
		63	125	250	500	1000	2000	4000	8000	Total
VAM350FB	U-H	57.5	53.0	49.5	45.0	42.5	39.5	31.5	25.5	48
	H	58.5	51.0	46.5	43.5	40.5	35.0	26.0	26.5	46
	L	58.5	45.5	41.5	38.0	33.5	24.0	25.0	27.0	41

NOTES

1. dBA = A-weighted sound power level (A-scale according to IEC).
2. Reference acoustic intensity $0dB = 10E-6\mu W/m^2$
3. Measured according to ISO 3744.
4. The operating sound level may become higher than this value depending on the operating conditions, reflected sound and peripheral noise.
5. The power levels have been calculated in the assumption that the measuring point is immediately under the source of operating sound.

4D082464

VAM500FC

Power level data (in case of Total Heat Exchange mode)

(dB) (dBA)

Unit model name	Fan speed	Hz								
		63	125	250	500	1000	2000	4000	8000	Total
VAM500FB	U-H	57.0	54.0	51.0	48.0	45.0	37.5	27.5	25.5	50
	H	54.0	51.5	49.0	46.0	42.5	36.0	26.5	26.0	48
	L	50.5	47.5	44.0	39.0	33.5	25.0	23.0	24.5	41

NOTES

1. dBA = A-weighted sound power level (A-scale according to IEC).
2. Reference acoustic intensity $0dB = 10E-6\mu W/m^2$
3. Measured according to ISO 3744.
4. The operating sound level may become higher than this value depending on the operating conditions, reflected sound and peripheral noise.
5. The power levels have been calculated in the assumption that the measuring point is immediately under the source of operating sound.

4D082465

VAM650FC

Power level data (in case of Total Heat Exchange mode)

(dB) (dBA)

Unit model name	Fan speed	Hz								
		63	125	250	500	1000	2000	4000	8000	Total
VAM650FB	U-H	62.0	58.0	52.5	48.5	45.5	41.5	34.0	26.0	51
	H	61.0	56.5	51.0	47.0	44.5	39.0	30.0	26.0	50
	L	53.5	50.5	46.0	42.0	37.5	32.0	24.0	25.5	44

NOTES

1. dBA = A-weighted sound power level (A-scale according to IEC).
2. Reference acoustic intensity $0dB = 10E-6\mu W/m^2$
3. Measured according to ISO 3744.
4. The operating sound level may become higher than this value depending on the operating conditions, reflected sound and peripheral noise.
5. The power levels have been calculated in the assumption that the measuring point is immediately under the source of operating sound.

4D082466

8 Sound data

8 - 1 Sound Power Spectrum

8

VAM800FC

Power level data (in case of Total Heat Exchange mode)

(dB) (dBA)

Unit model name	Fan speed	Hz								
		63	125	250	500	1000	2000	4000	8000	Total
VAM800FB	U-H	58.0	58.0	52.5	49.5	48.5	41.5	33.5	26.0	53
	H	58.5	57.0	51.5	49.5	47.0	40.5	31.0	27.5	52
	L	54.5	54.5	47.5	44.5	43.0	35.5	24.5	23.5	47

NOTES

1. dBA = A-weighted sound power level (A-scale according to IEC).
2. Reference acoustic intensity $0dB = 10E-6\mu W/m^2$
3. Measured according to ISO 3744.
4. The operating sound level may become higher than this value depending on the operating conditions, reflected sound and peripheral noise.
5. The power levels have been calculated in the assumption that the measuring point is immediately under the source of operating sound.

4D082467

VAM1000FC

Power level data (in case of Total Heat Exchange mode)

(dB) (dBA)

Unit model name	Fan speed	Hz								
		63	125	250	500	1000	2000	4000	8000	Total
VAM1000FB	U-H	62.0	58.5	54.0	50.5	49.0	42.0	36.5	28.0	53
	H	61.0	57.0	52.0	50.0	48.0	38.5	31.0	25.5	52
	L	58.0	55.0	49.0	45.5	43.5	36.5	27.5	24.0	48

NOTES

1. dBA = A-weighted sound power level (A-scale according to IEC).
2. Reference acoustic intensity $0dB = 10E-6\mu W/m^2$
3. Measured according to ISO 3744.
4. The operating sound level may become higher than this value depending on the operating conditions, reflected sound and peripheral noise.
5. The power levels have been calculated in the assumption that the measuring point is immediately under the source of operating sound.

4D082468

VAM1500FC

Power level data (in case of Total Heat Exchange mode)

(dB) (dBA)

Unit model name	Fan speed	Hz								
		63	125	250	500	1000	2000	4000	8000	Total
VAM1500FB	U-H	60.5	61.0	55.5	52.5	50.5	46.0	39.5	29.5	55
	H	60.5	60.0	53.5	51.5	49.5	44.5	37.0	31.0	54
	L	58.5	58.0	51.0	49.0	47.0	39.5	30.5	31.0	51

NOTES

1. dBA = A-weighted sound power level (A-scale according to IEC).
2. Reference acoustic intensity $0dB = 10E-6\mu W/m^2$
3. Measured according to ISO 3744.
4. The operating sound level may become higher than this value depending on the operating conditions, reflected sound and peripheral noise.
5. The power levels have been calculated in the assumption that the measuring point is immediately under the source of operating sound.

4D082469

VAM2000FC

Power level data (in case of Total Heat Exchange mode)

(dB) (dBA)

Unit model name	Fan speed	Hz								
		63	125	250	500	1000	2000	4000	8000	Total
VAM2000FB	U-H	65.0	61.5	57.0	54.0	53.0	45.0	39.5	32.5	57
	H	64.0	60.0	55.0	53.0	51.0	41.5	34.5	30.5	55
	L	62.0	58.0	51.5	50.0	48.5	40.5	32.5	30.5	53

NOTES

1. dBA = A-weighted sound power level (A-scale according to IEC).
2. Reference acoustic intensity $0dB = 10E-6\mu W/m^2$
3. Measured according to ISO 3744.
4. The operating sound level may become higher than this value depending on the operating conditions, reflected sound and peripheral noise.
5. The power levels have been calculated in the assumption that the measuring point is immediately under the source of operating sound.

4D082470

8 Sound data

8 - 2 Sound Pressure Spectrum

VAM150FC

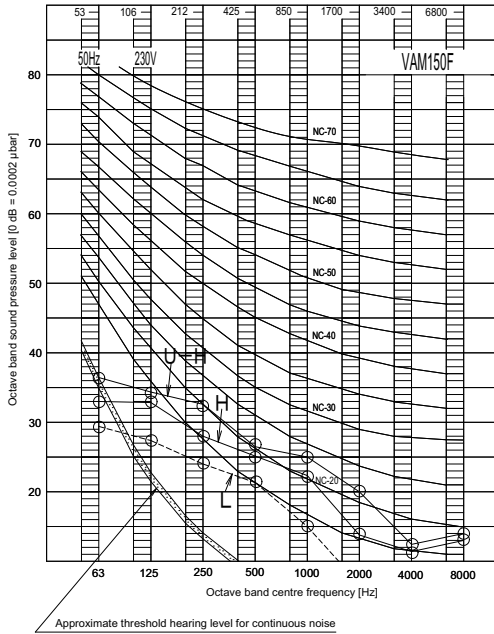

Notes

- Data is valid at nominal operation condition.
- dBA = A-weighted sound pressure level (A scale according to IEC).
- Operating noise varies depending on operation, installation, and ambient conditions.
- Measuring location: anechoic chamber

Scale	Total dB		
	Air flow rate		
A	28	27	21

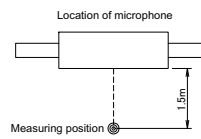

3D099269

VAM250FC

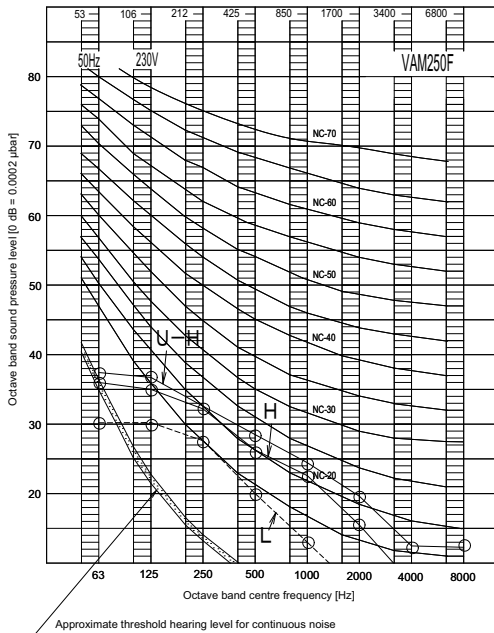

Notes

- Data is valid at nominal operation condition.
- dBA = A-weighted sound pressure level (A scale according to IEC).
- Operating noise varies depending on operation, installation, and ambient conditions.
- Measuring location: anechoic chamber

Scale	Total dB		
	Air flow rate		
A	28.5	26.5	21.5

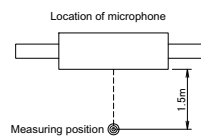

3D099270

8 Sound data

8 - 2 Sound Pressure Spectrum

8

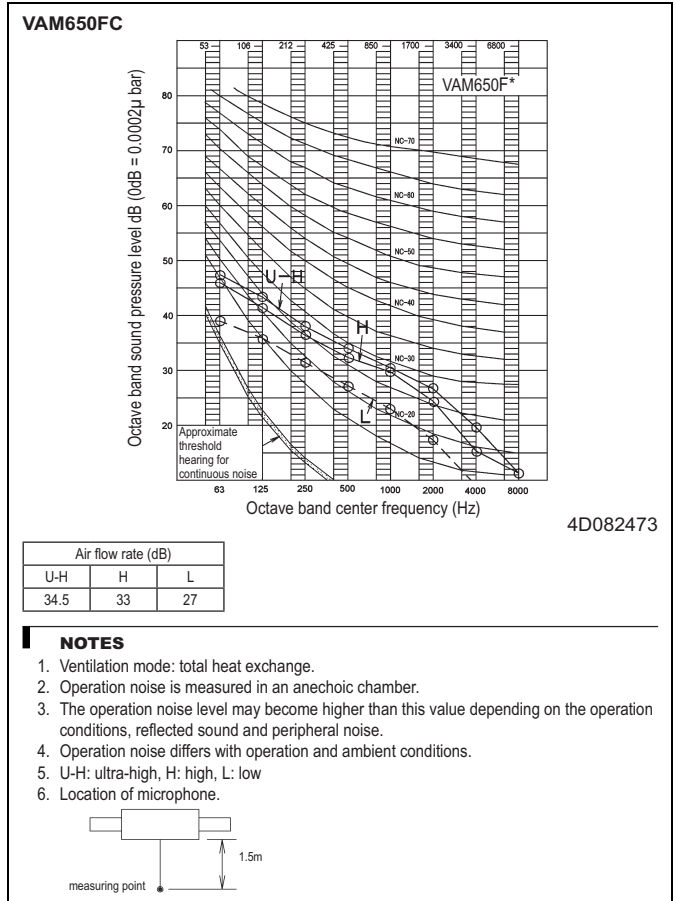
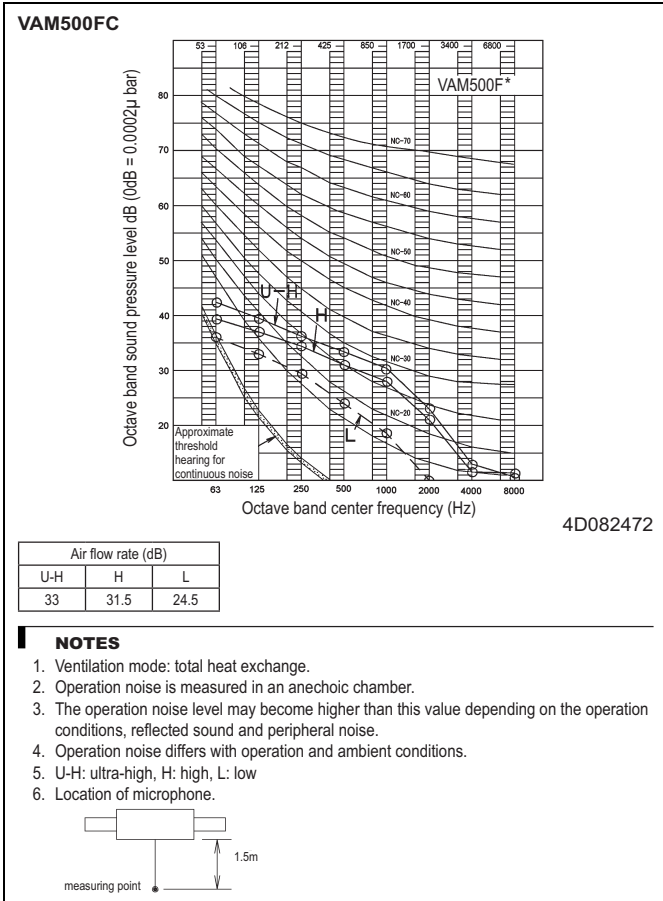
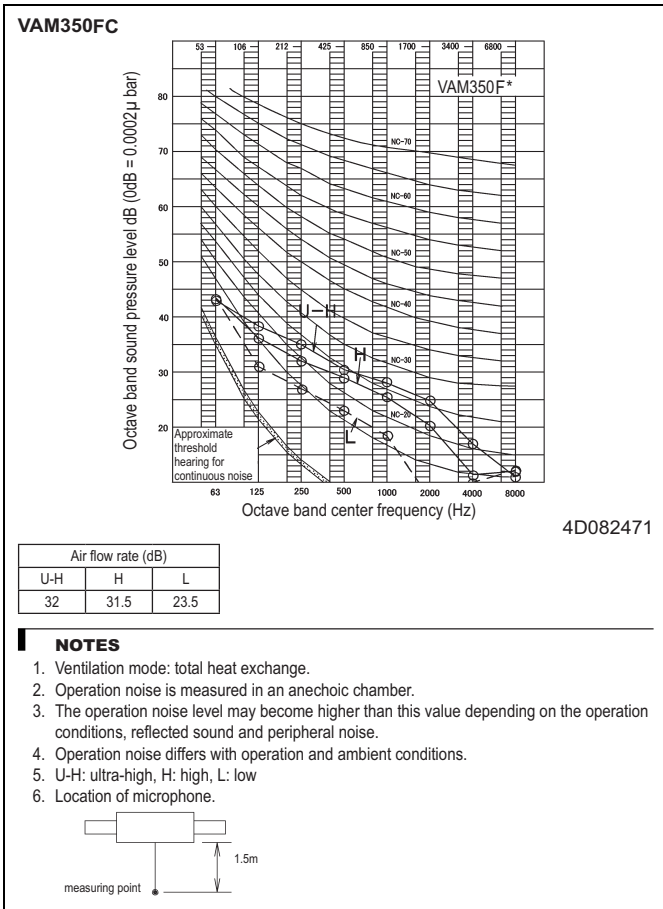

8 Sound data

8 - 2 Sound Pressure Spectrum

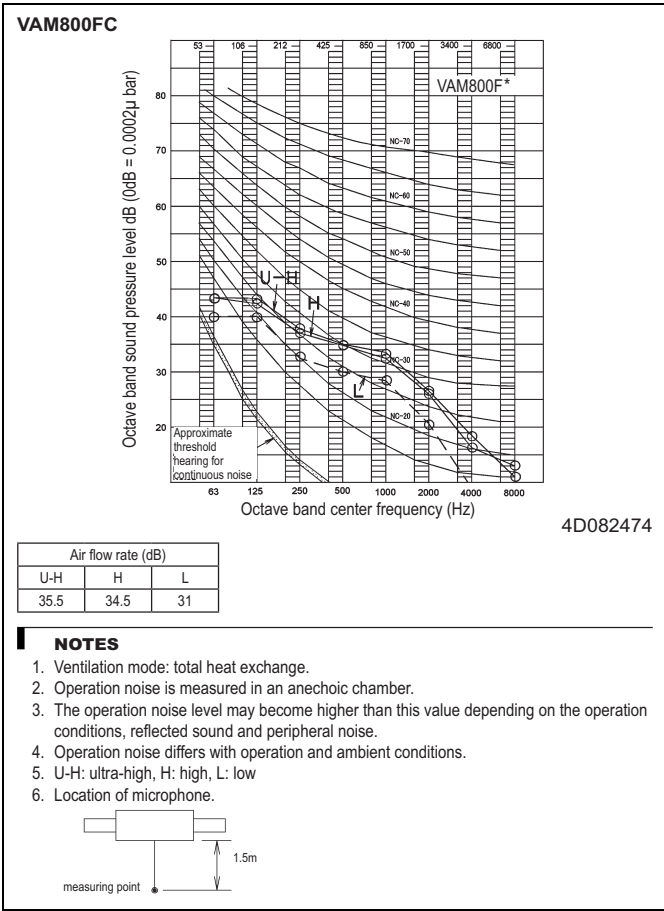

4D082474

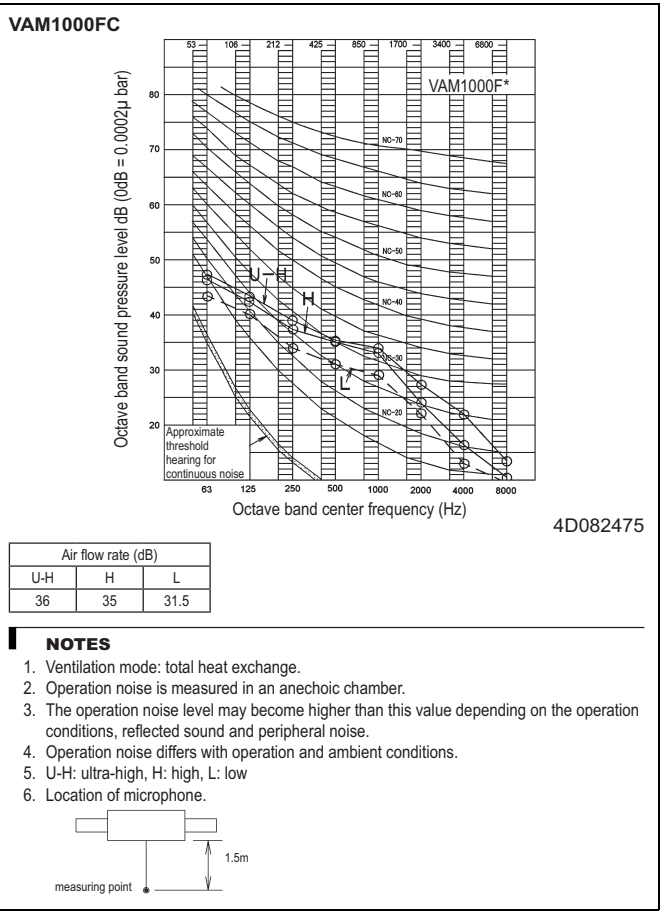

4D082475

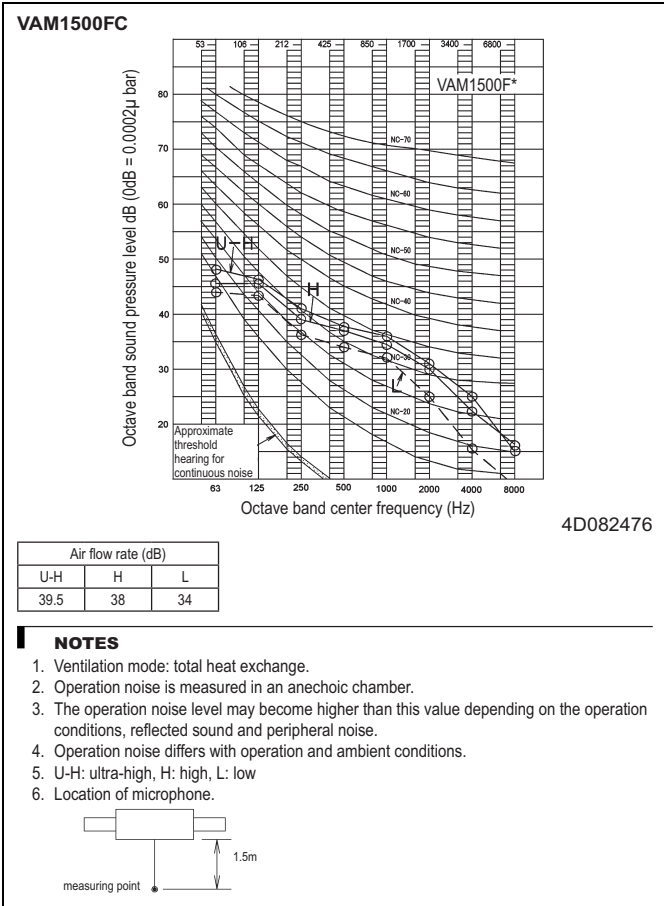

4D082476

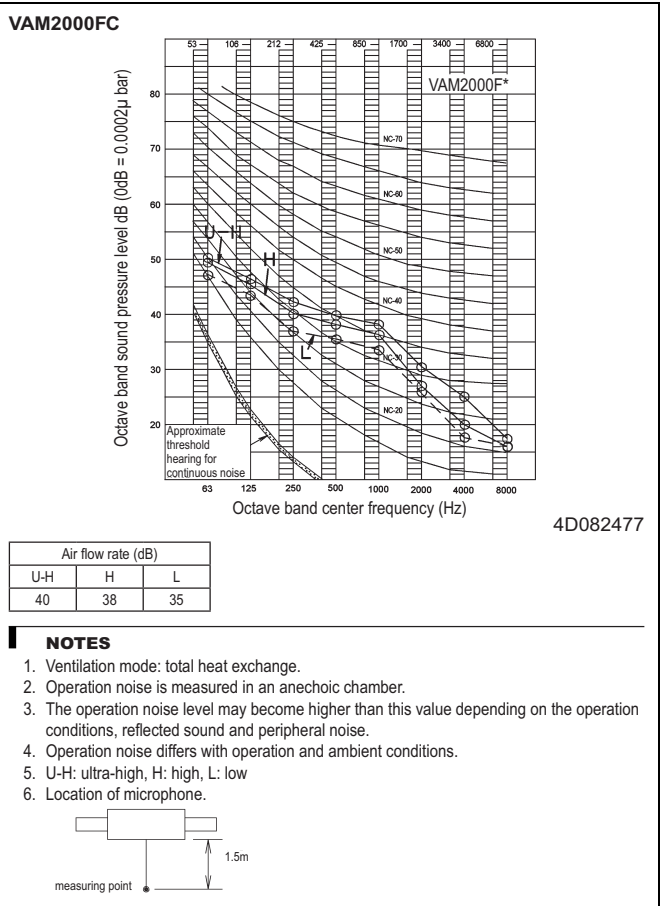

4D082477

9 Fan characteristics

9 - 1 Fan Characteristics

VAM150FC

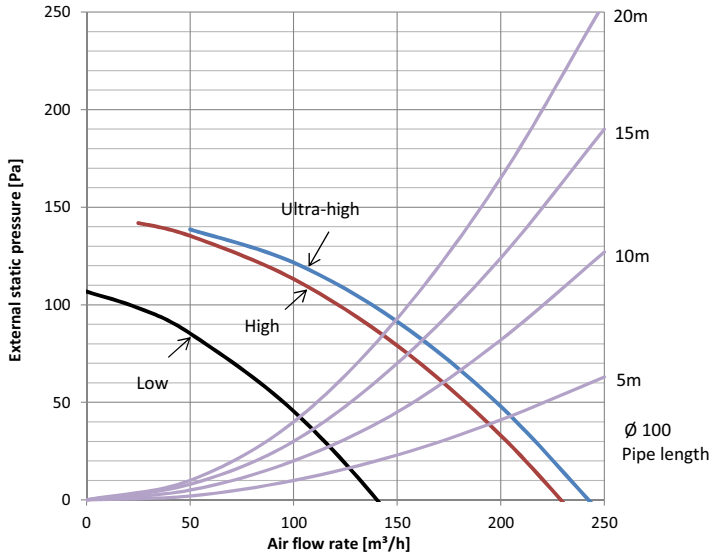

Notes

1. The fan speeds are valid for ~230-V, ~50-Hz power supply.

4D100379

VAM250FC

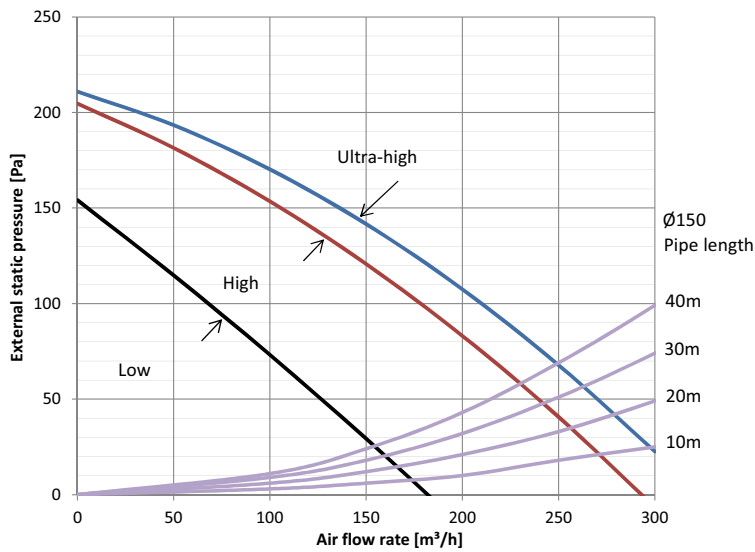

Notes

1. The fan speeds are valid for ~230-V, ~50-Hz power supply.

4D100380

9 Fan characteristics

9 - 1 Fan Characteristics

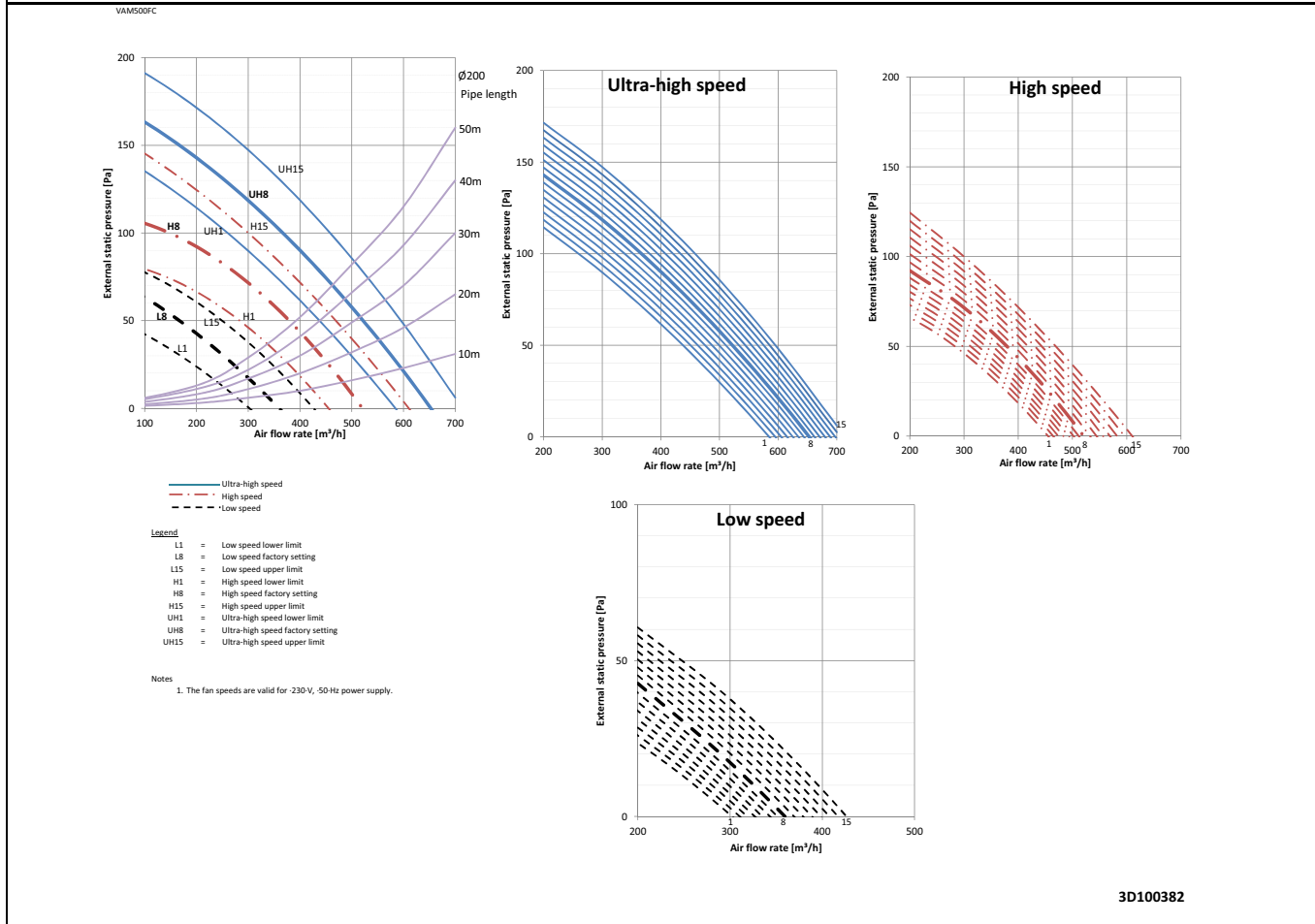
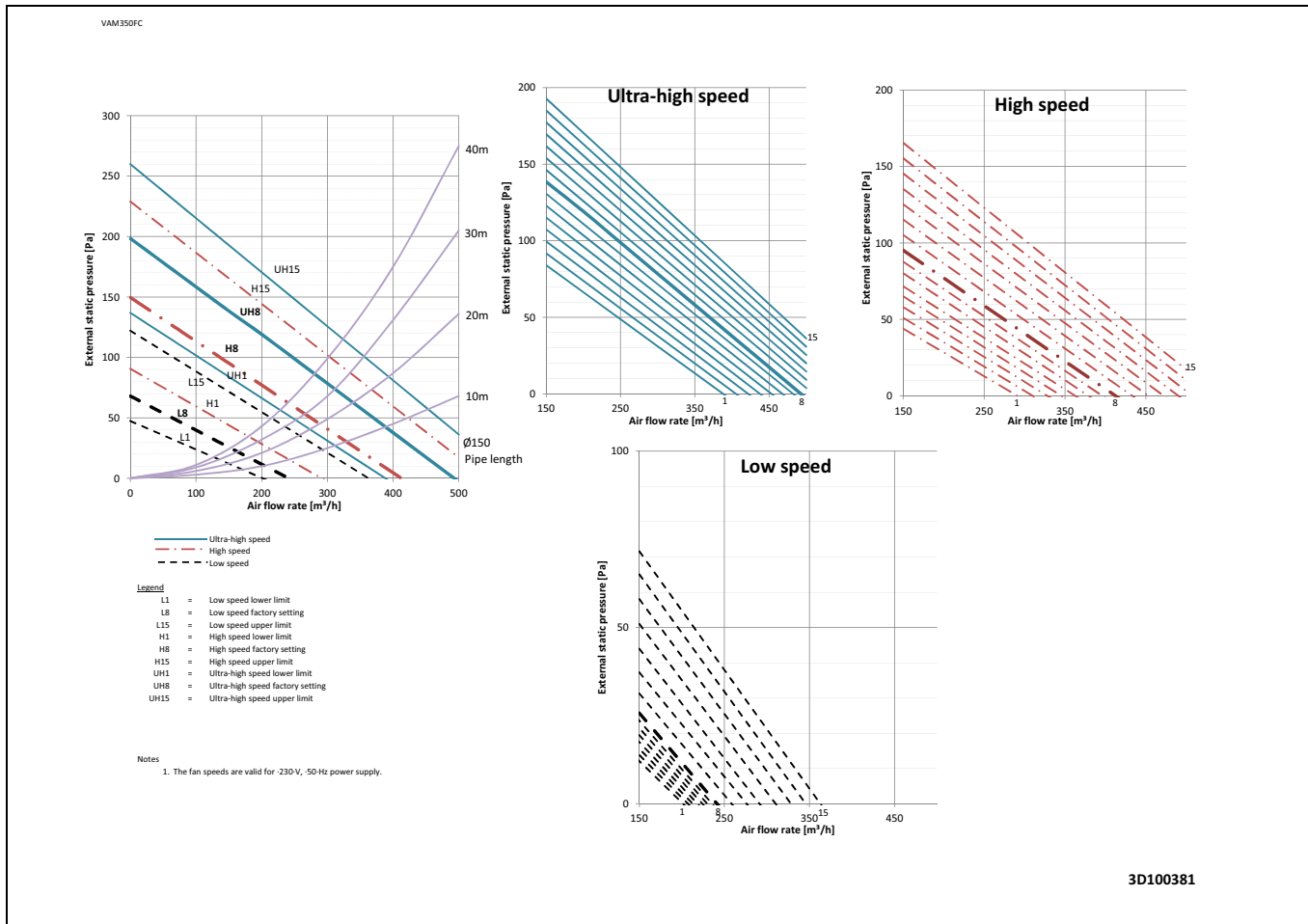

9 Fan characteristics

9 - 1 Fan Characteristics

9

VAM650FC

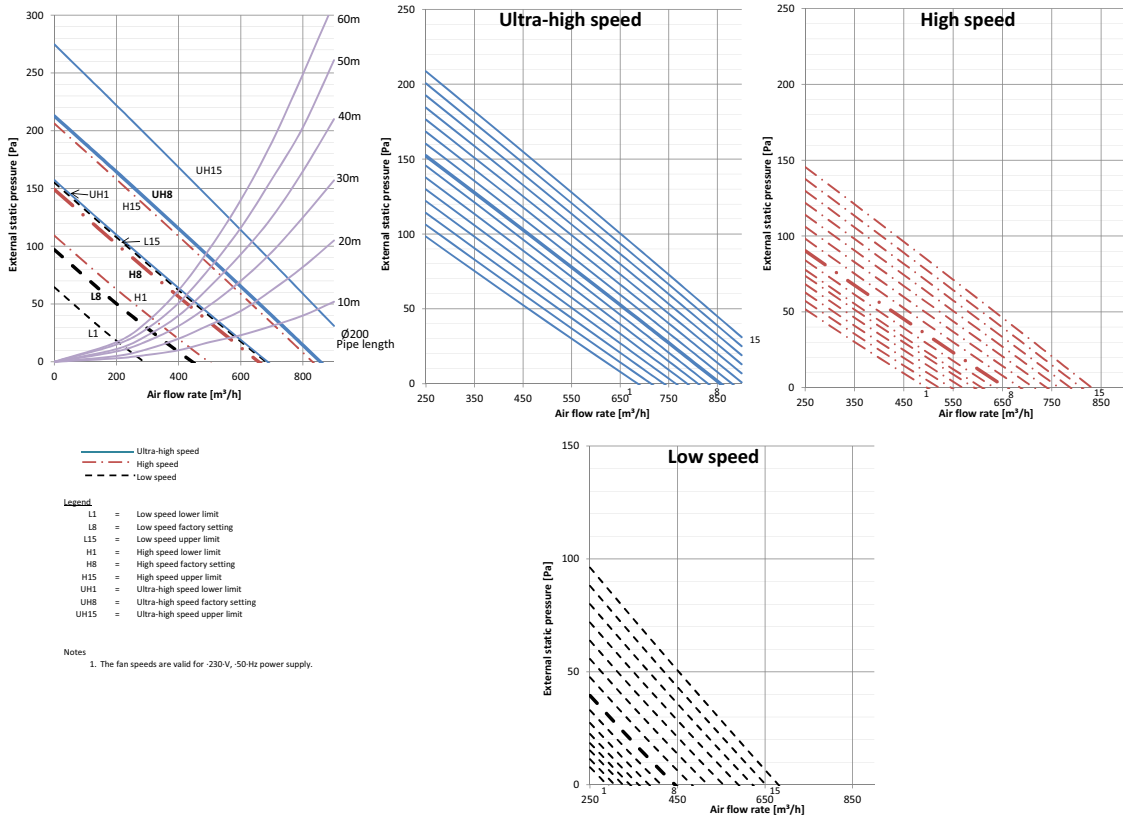

3D100383

VAM800FC

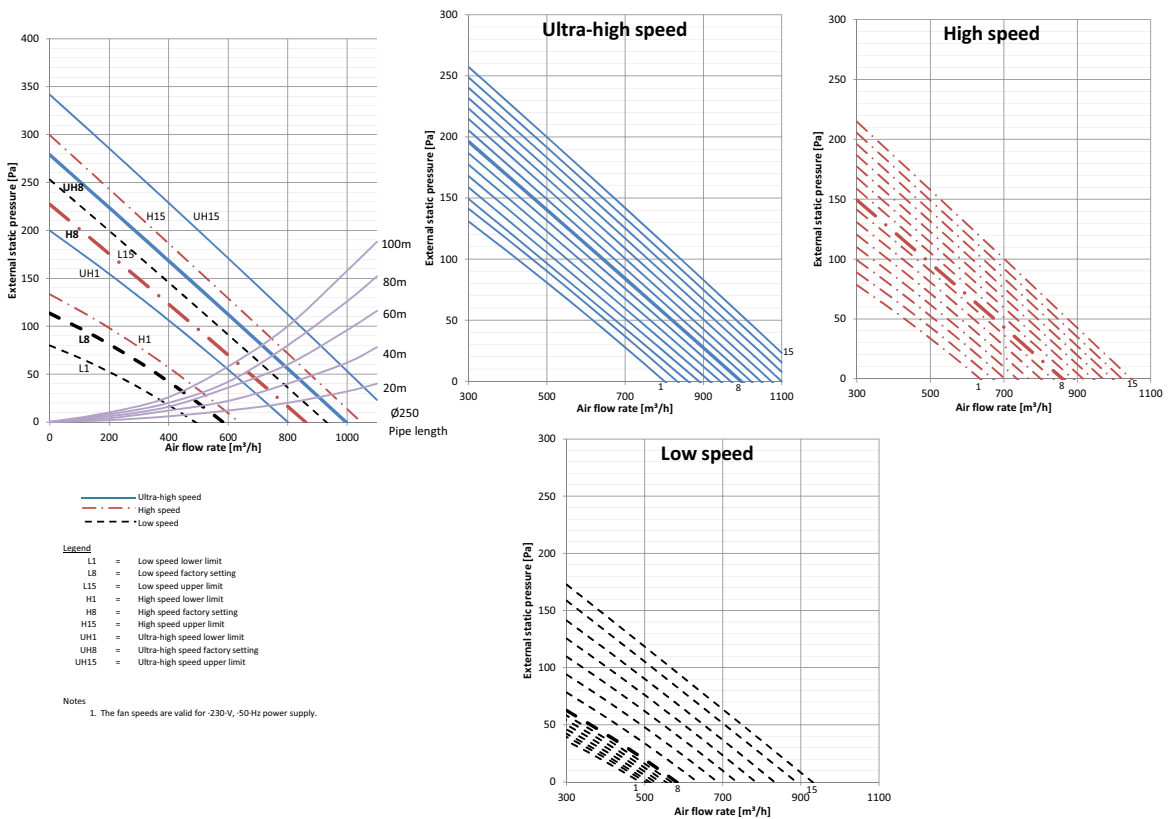

3D100384

9 Fan characteristics

9 - 1 Fan Characteristics

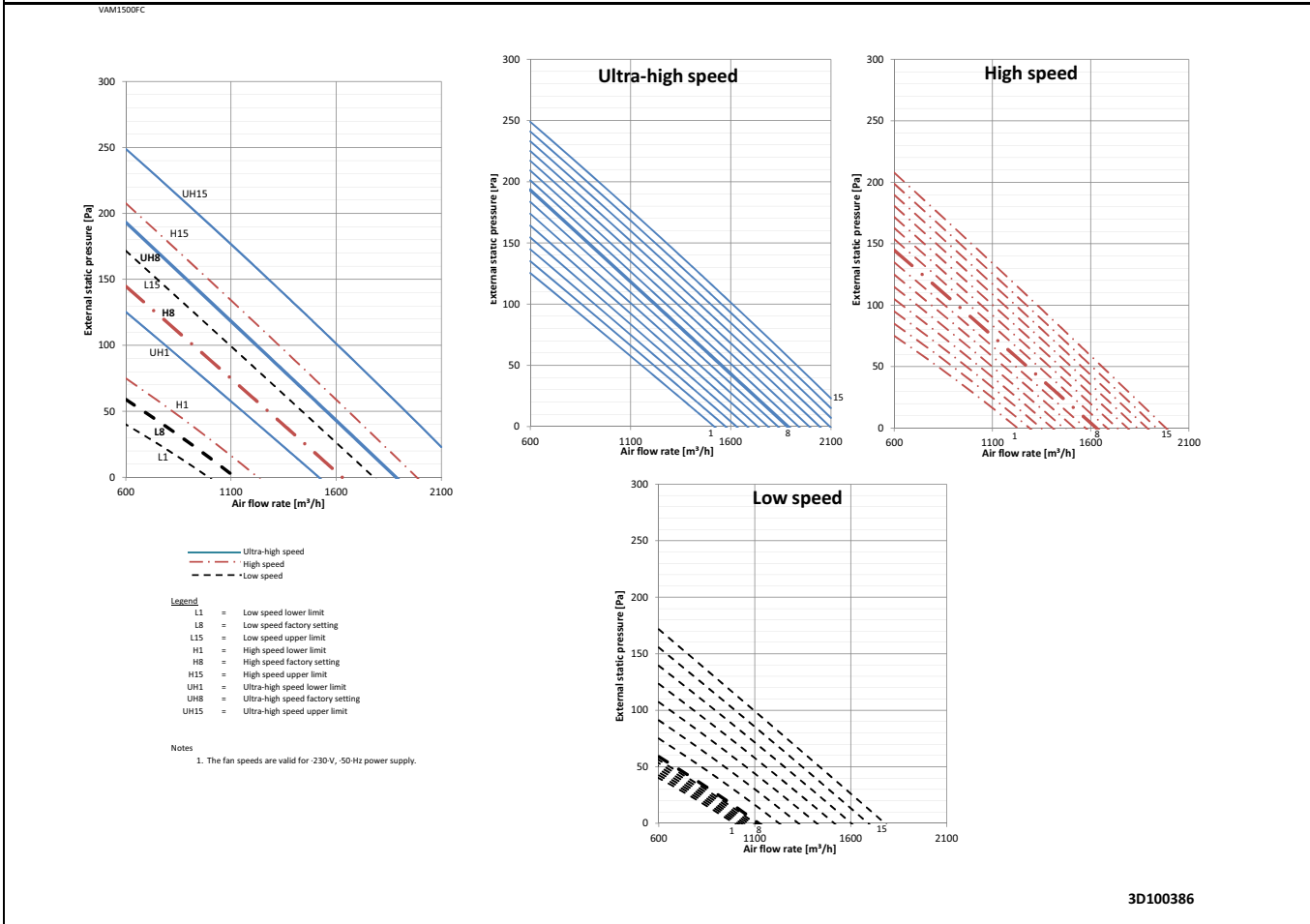
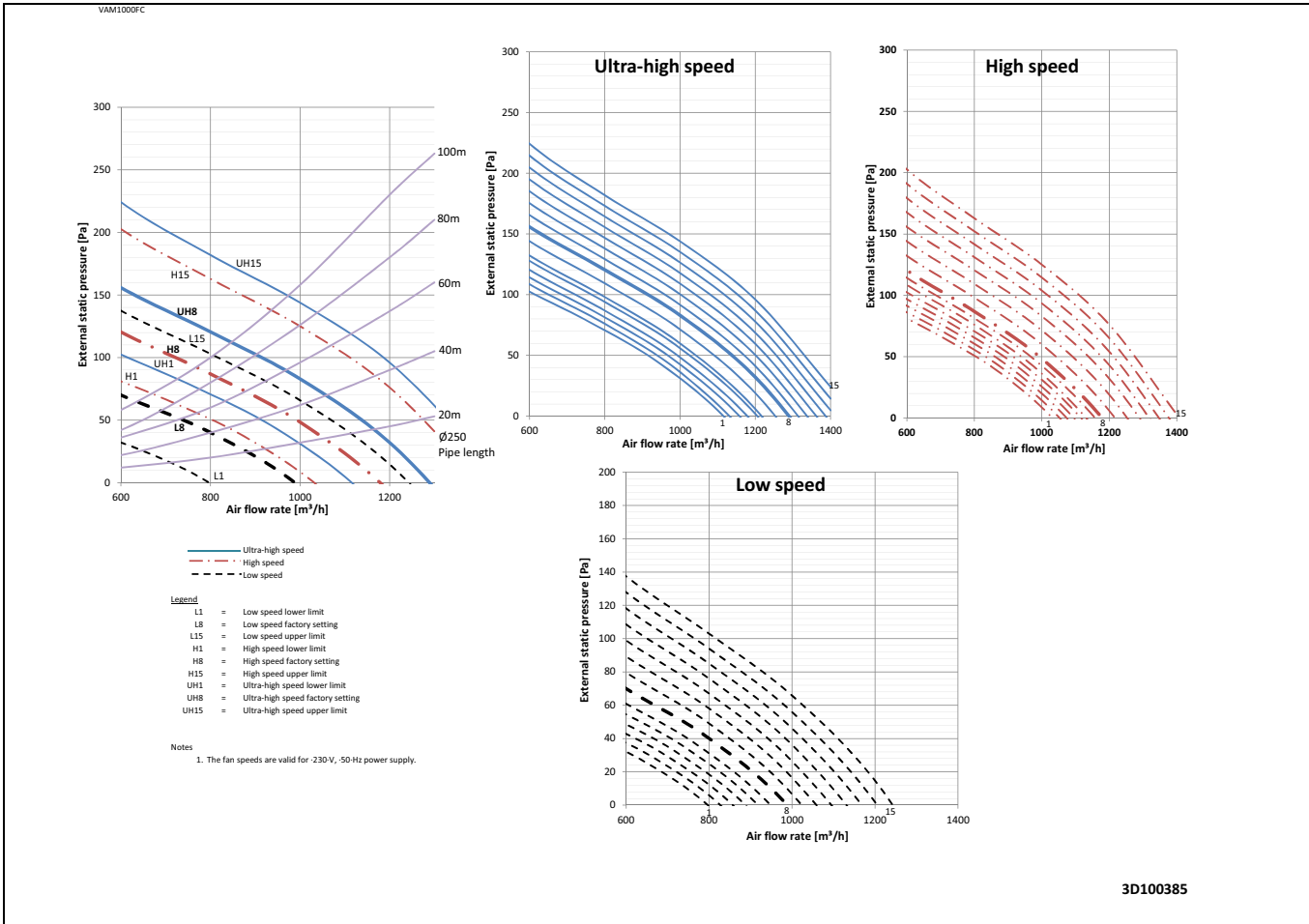

9 Fan characteristics

9 - 1 Fan Characteristics

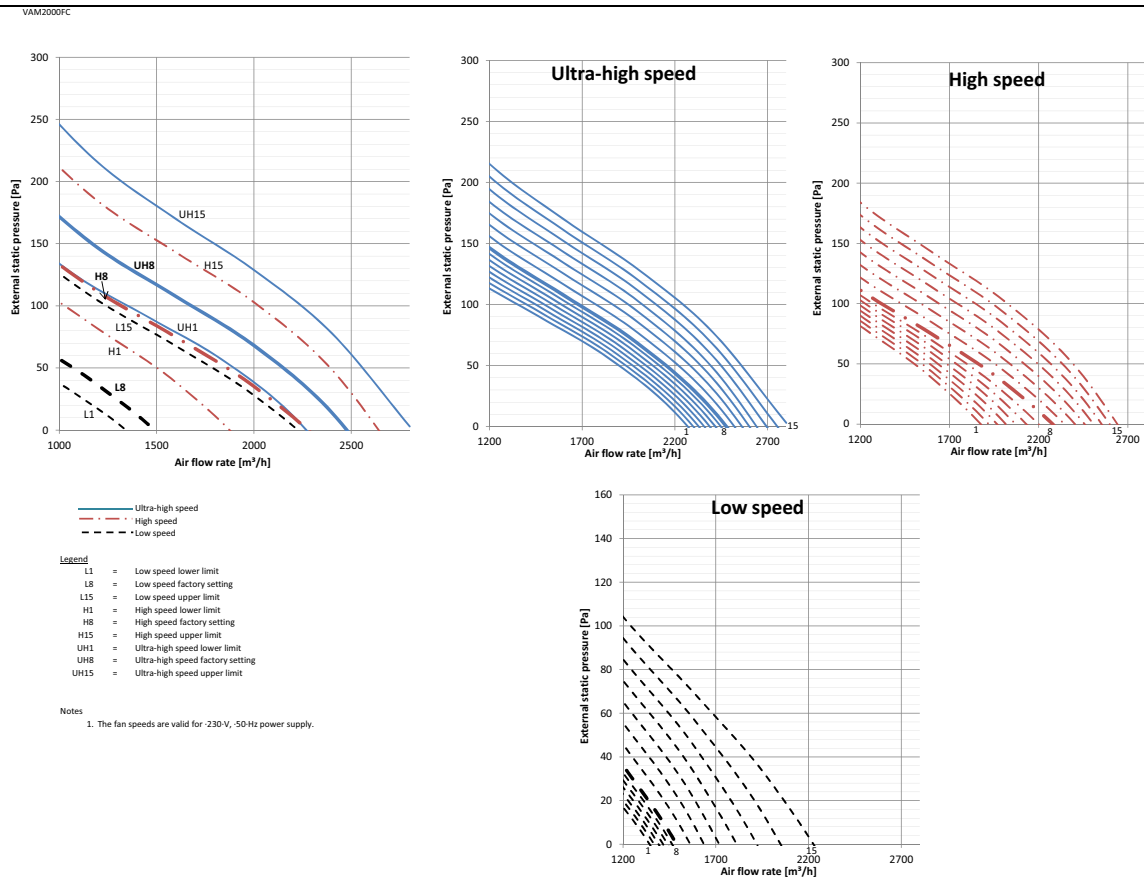

3D100387

10 Air filter characteristics

10 - 1 Air filter characteristics

VAM350-2000FC

High efficiency filter / dust filter for VAM350-2000FC

1 Information for filter selection

- 1 Choose required airflow
- 2 Choose the filters
- 3 Add up all the pressure drops of the duct system on the installation site and the filters [For filter characteristics, refer to D-drawings]
- 4 Compare this with the unit performance characteristics to see resulting airflow & ESP

Download the VAM selection software on the Daikin extranet for easy selection

1 - 1 Choose required airflow

Choose the required airflow based upon the application/information

1 - 2 Choose the filters

Depending on the application prefilters and/or dust filters will be needed.

Filter requirements according to EN779: 2012

Table: Recommended dust filter classes per filter section (definition of filter classes according to EN 779)

Outdoor Air Quality	Indoor Air Quality			
	IDA 1 (High)	IDA 2 (Medium)	IDA 3 (Moderate)	IDA 4 (Low)
ODA 1 (pure air)	N/A	F8	F7	F5
ODA 2 (dust)	N/A	F6+F8	F5+F7	F5+F6
ODA 3 (very high concentrations of dust of gases)	N/A	N/A	F5+F7	F5+F6

*) GF = Gas filter (carbon filter) and/or chemical filter

Outdoor air Quality:

- ODA 1 - Pure air
- ODA 2 - High concentration particles air
- ODA 3 - High concentration gas pollution
- ODA 4 - High concentration gas pollution and particles
- ODA 5 - Very high concentration gas pollution and particles

Indoor air Quality:

- IDA 1 - Optimum quality air (hospitals, laboratories, nursery)
- IDA 2 - Good quality air (offices, residences, museum,...)
- IDA 3 - Medium quality air (commercial buildings, cinema, theatre, room hotels, restaurants, bars, gym, computer room)

On the image below it is indicated where the standard prefilters and optional dust filters are installed. If 2 optional dust filters are used, the second one replaces the standard filter.

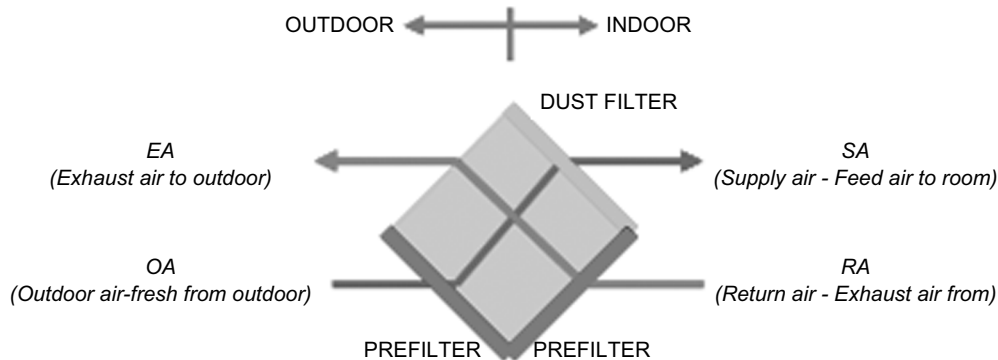
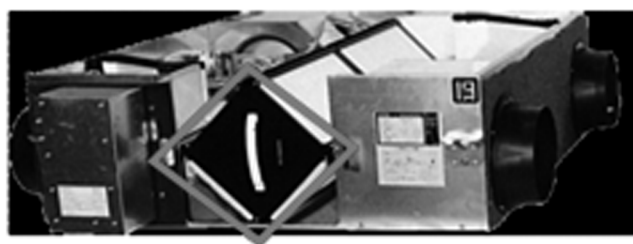

NOTE

- 1 Prefilters are factory mounted, M6, F7 and F8 dust filters are options

10 Air filter characteristics

10 - 1 Air filter characteristics

10

VAM350-2000FC

1-3 Add up all the pressure drops of the duct system on the installation site and the filters

[For filter characteristics, refer to D-drawings]

unit	airflow (m ³ /h)	filter pressure drop		
		M6	F7	F8
VAM350F	350	39	52	88
VAM500F	500	65	87	148
VAM650F	650	61	83	140
VAM800F	800	89	121	206
VAM1000F	1000	80	109	185
VAM1500F	1500	79	106	181
VAM2000F	2000	80	109	185

NOTES

- 1 Table shows values at nominal level, refer to drawings for detailed information
- 2 Filters according to EN779:2012
- 3 For more information refer to VAM installation, operation manual or filter manual

To adjust static pressure after filter placement:

Setting mode	Setting switch No.	Description of setting
19 (29)	2	SA fan speed setting
	3	EA fan speed setting

10 Air filter characteristics

10 - 1 Air filter characteristics

VAM350-500FC

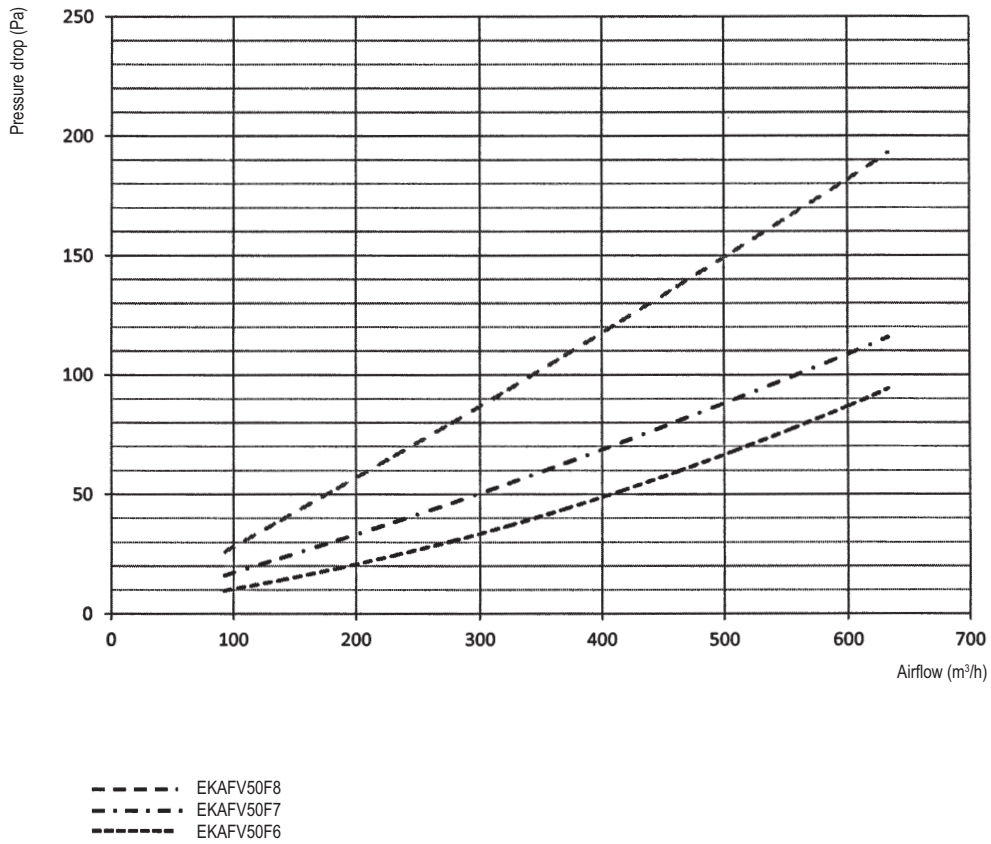

4D082449

VAM650-800FC

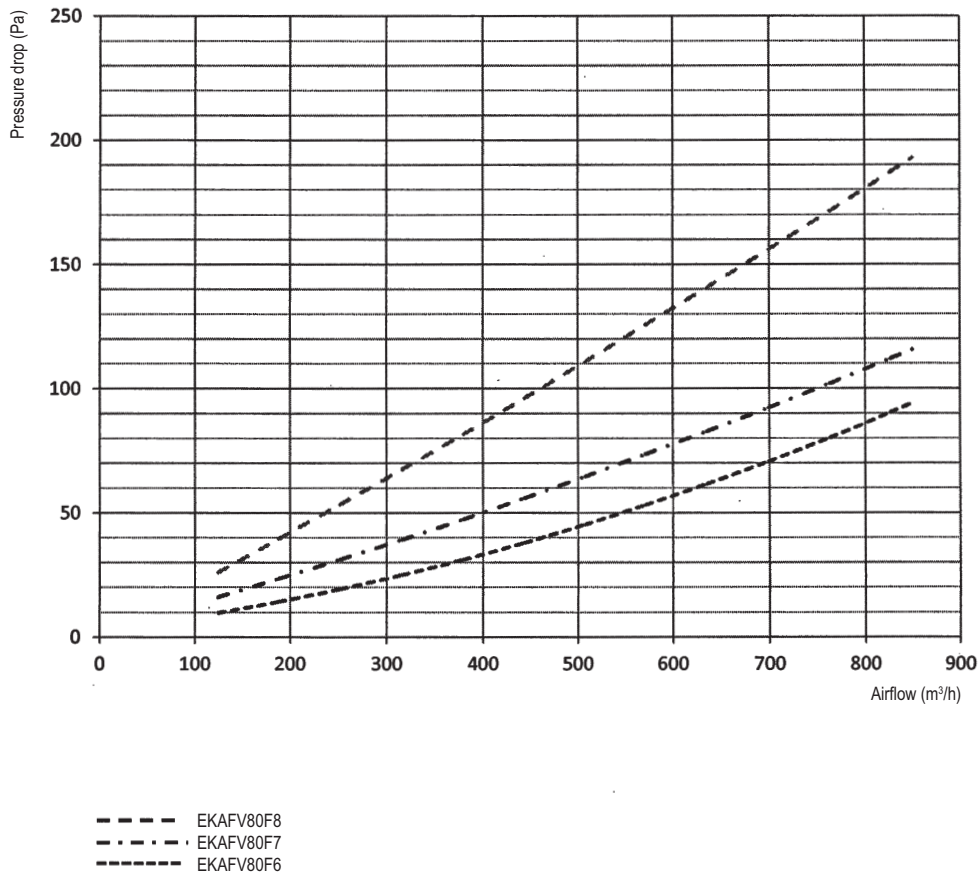

4D082450

10 Air filter characteristics

10 - 1 Air filter characteristics

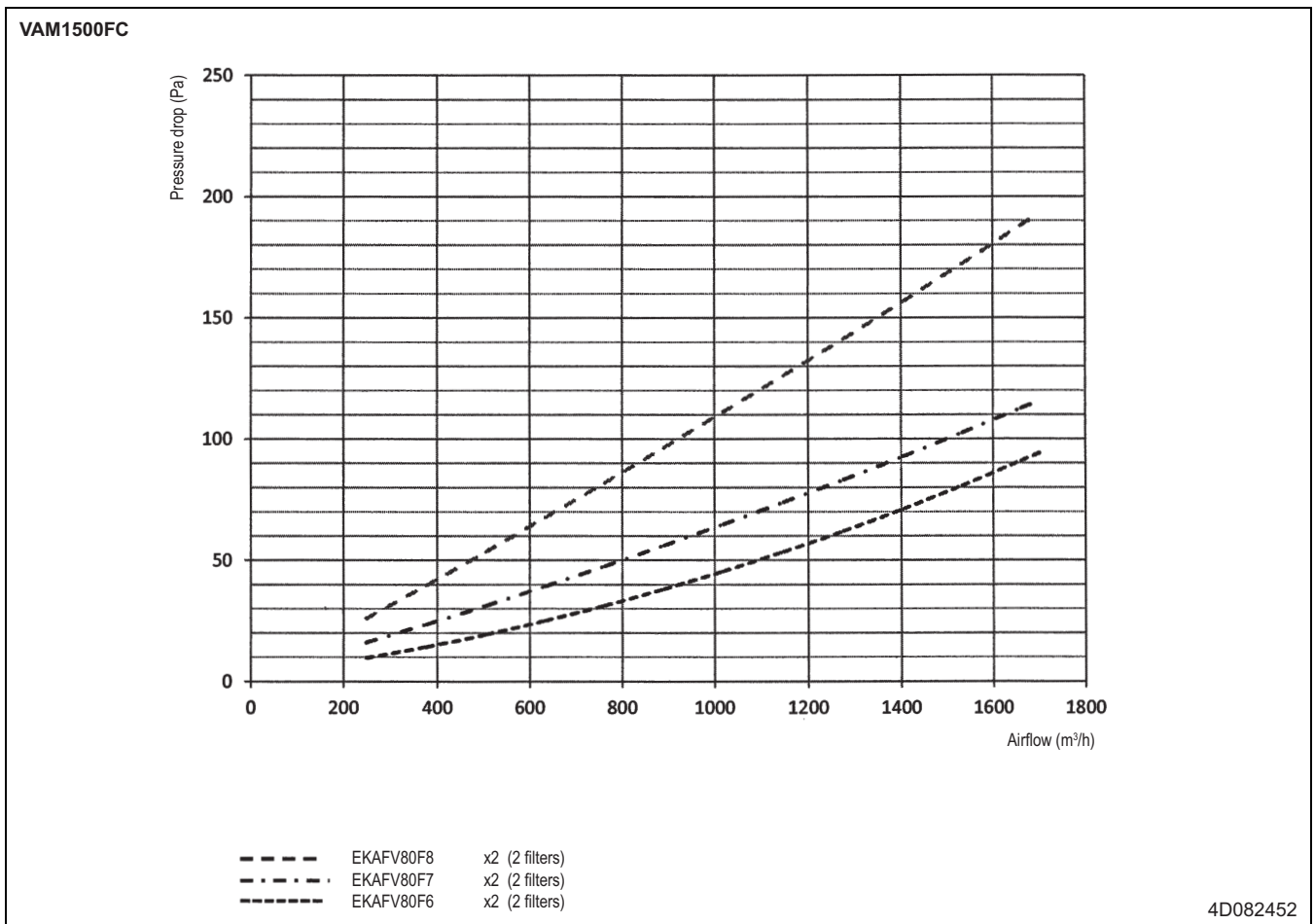
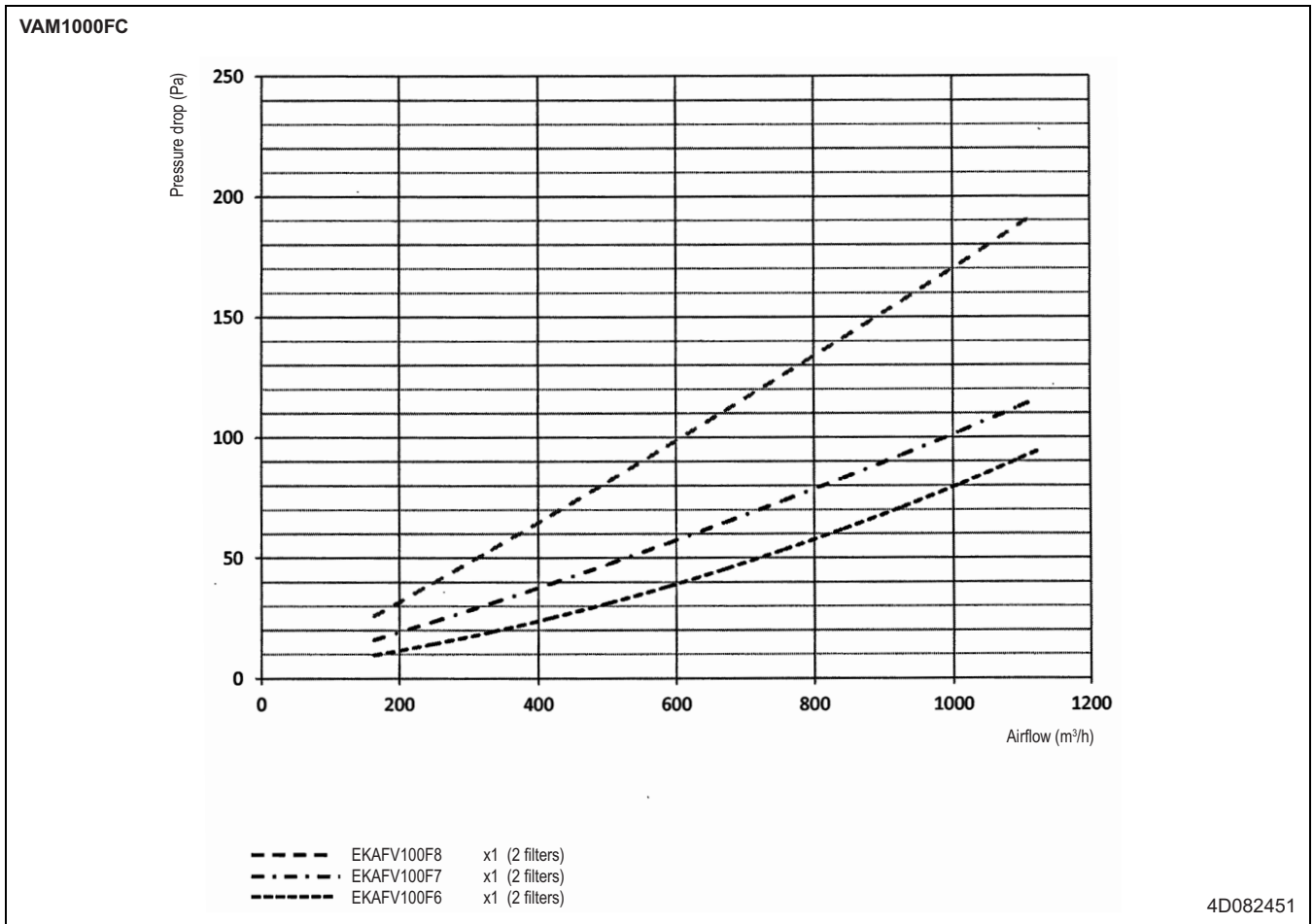

10 Air filter characteristics

10 - 1 Air filter characteristics

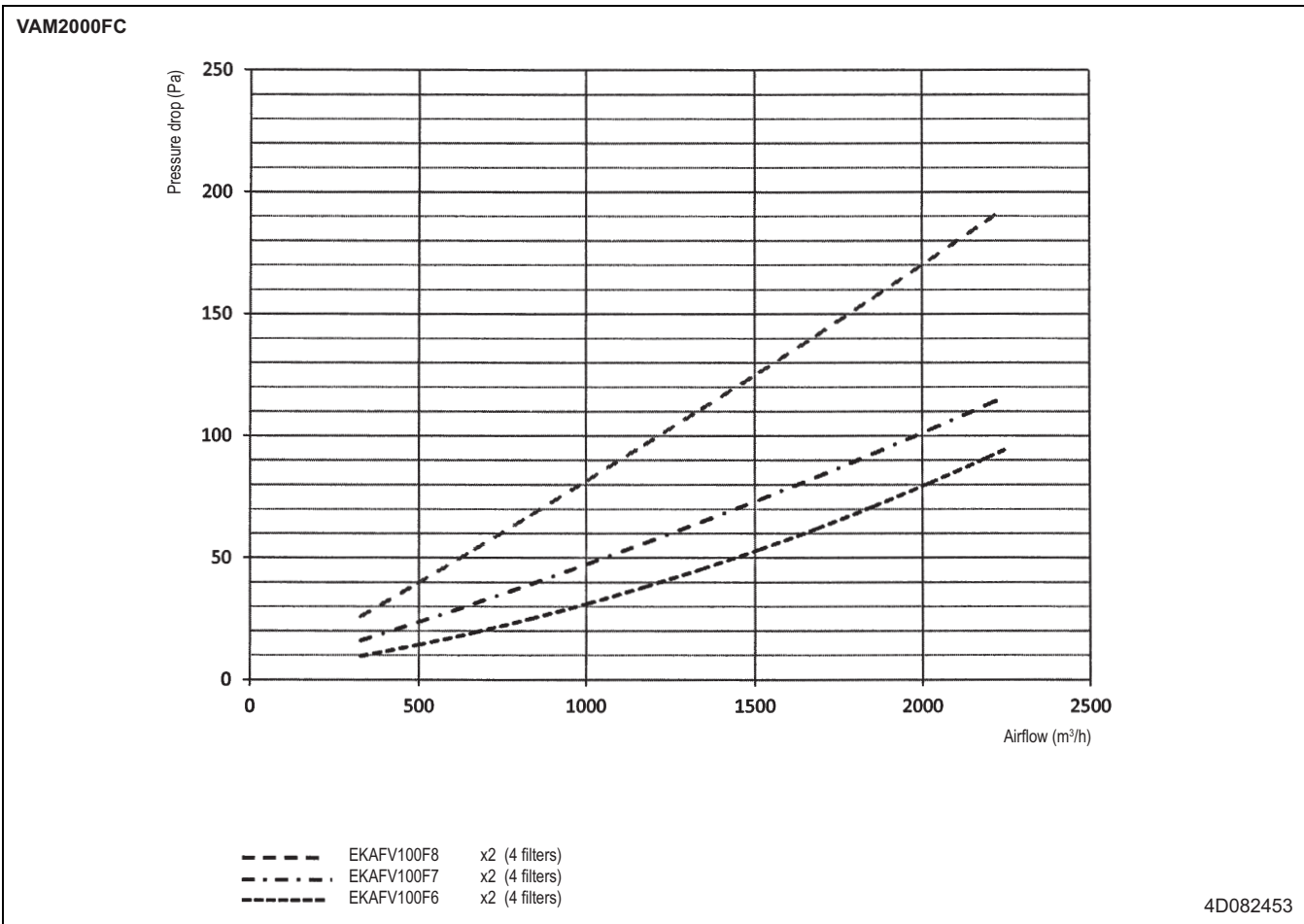

11 Installation

11 - 1 Installation Method

VAM150FC

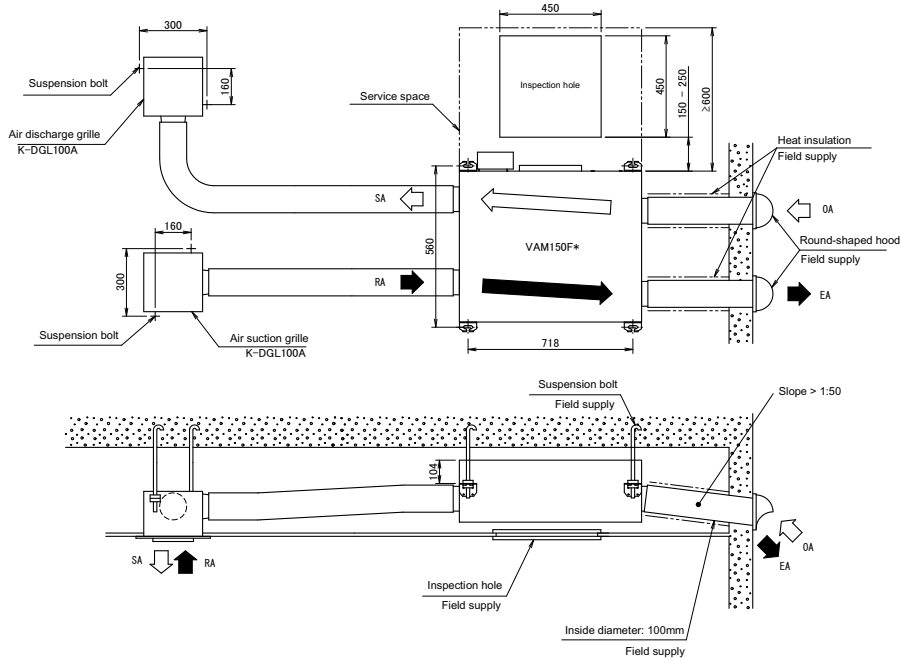

- Symbols
 OA = Fresh outdoor air
 EA = Exhaust air
 SA = Supply air to room
 RA = Return air from room

3D099263

VAM250FC

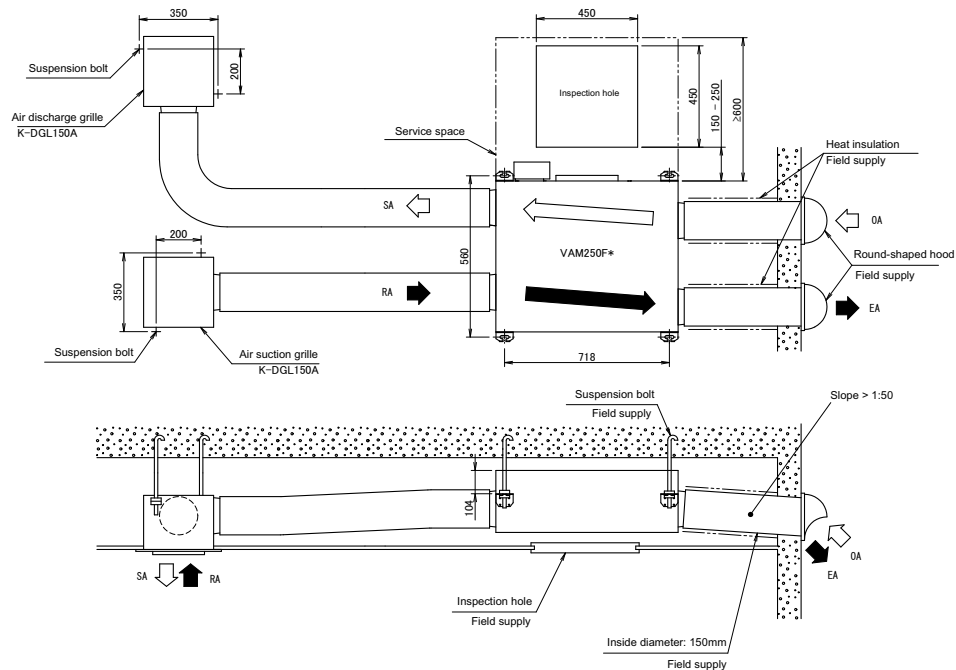

- Symbols
 OA = Fresh outdoor air
 EA = Exhaust air
 SA = Supply air to room
 RA = Return air from room

3D099264

11 Installation

11 - 1 Installation Method

VAM350FC

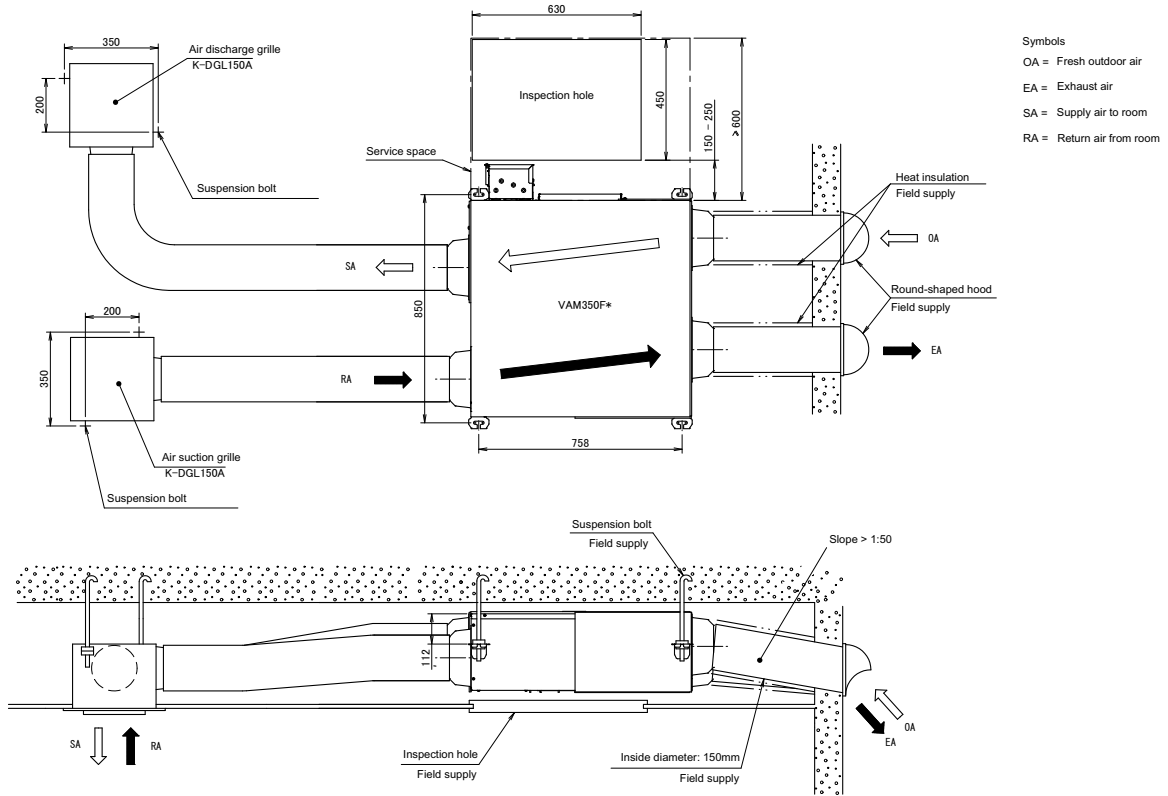

3D081267A

VAM500FC

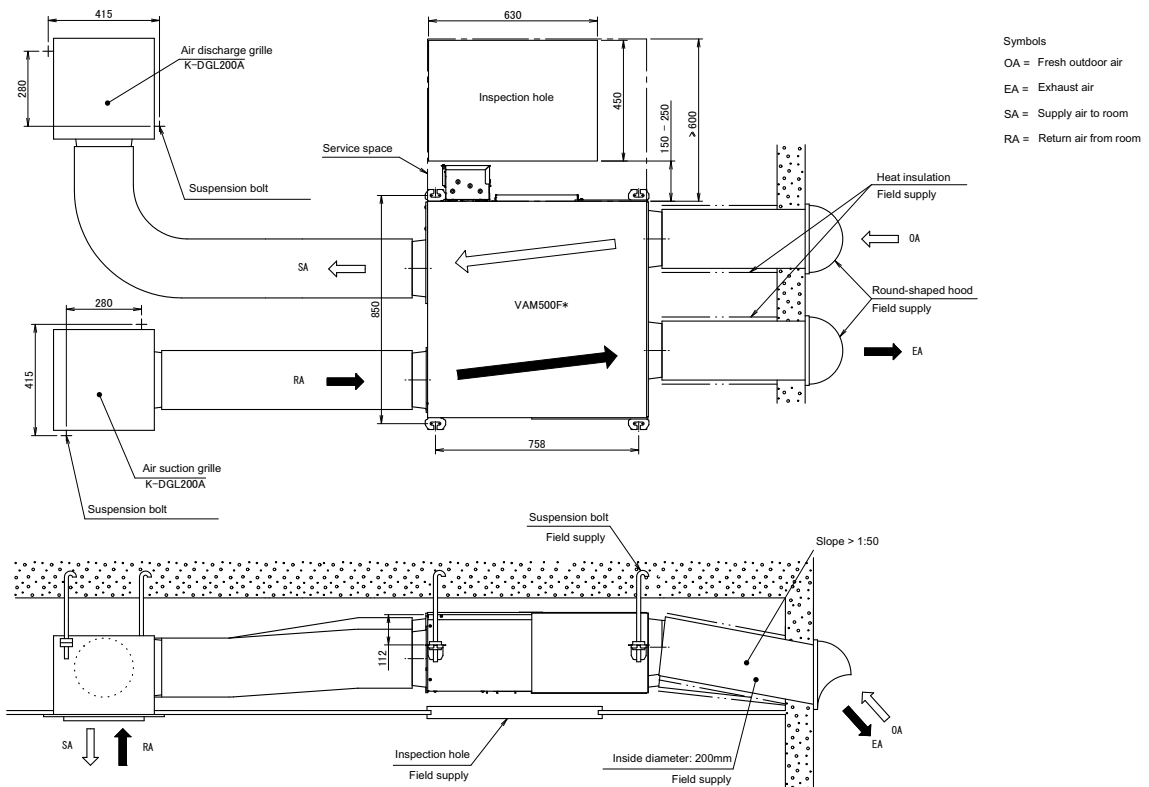

3D081268A

11 Installation

11 - 1 Installation Method

VAM650FC

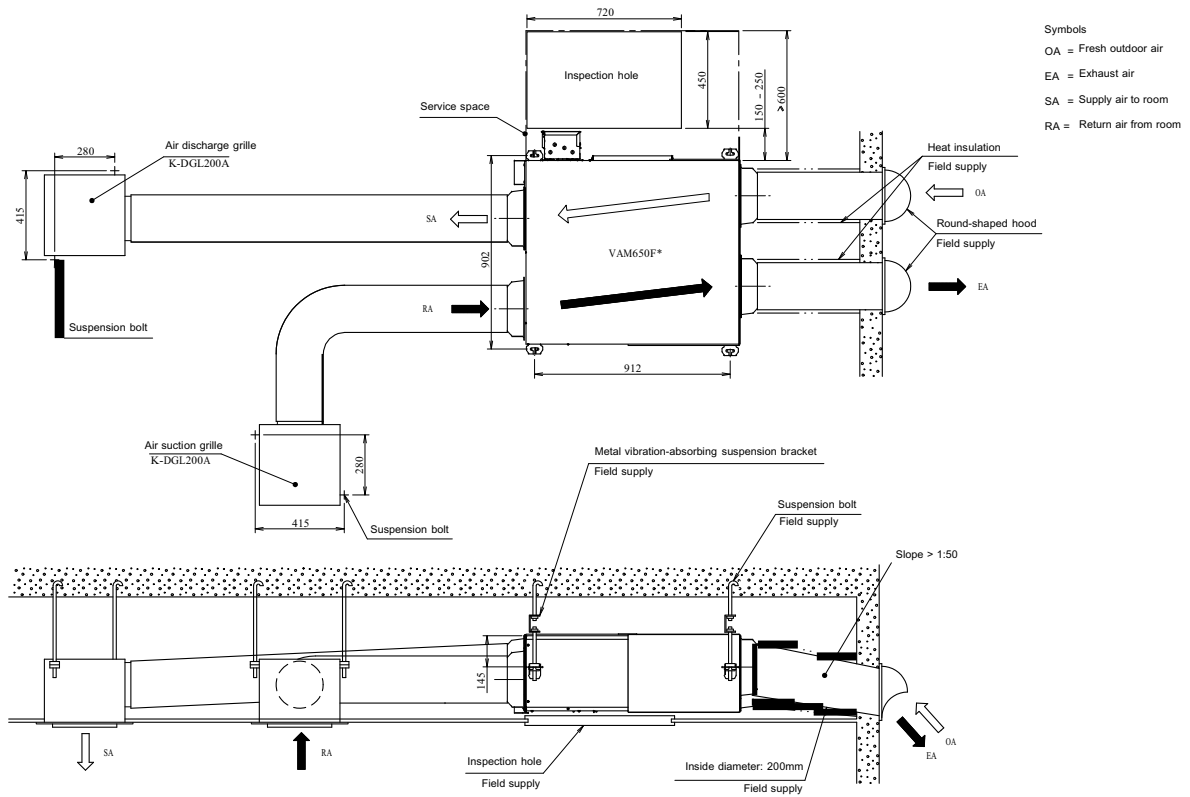

3D081269A

VAM800FC

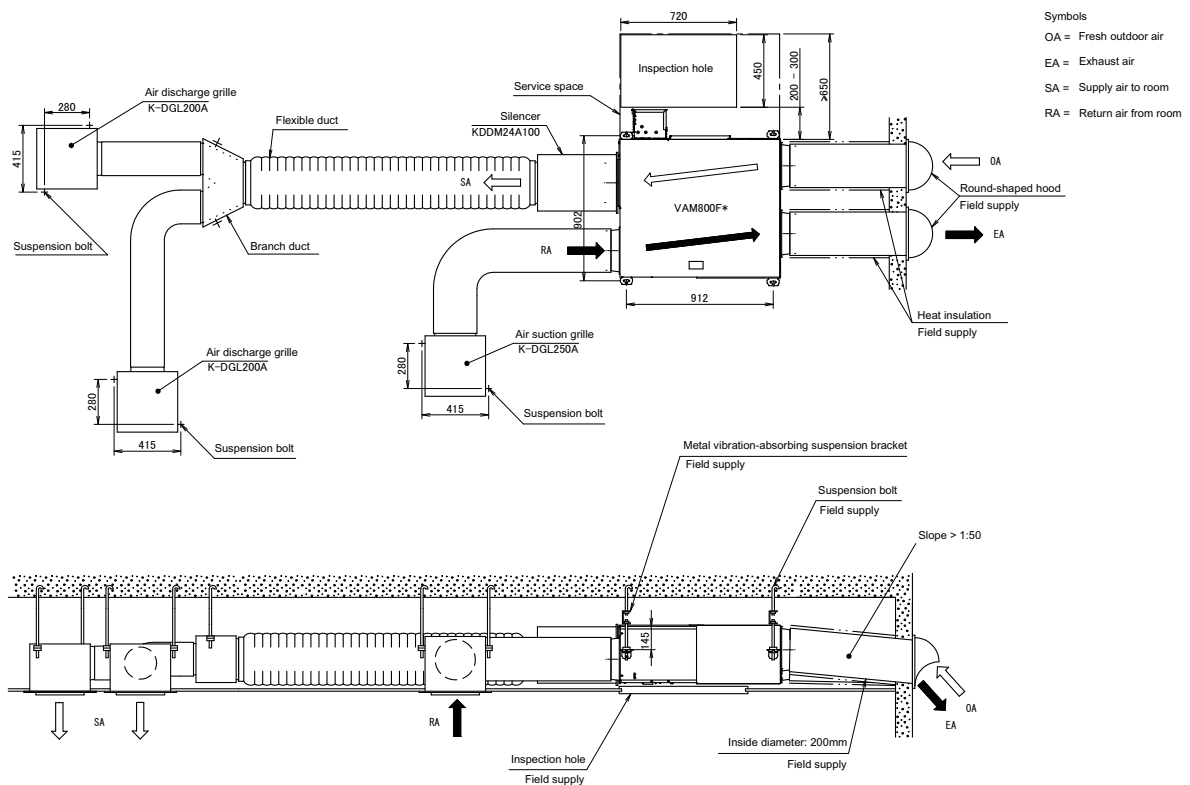

3D081270A

11 Installation

11 - 1 Installation Method

VAM1000FC

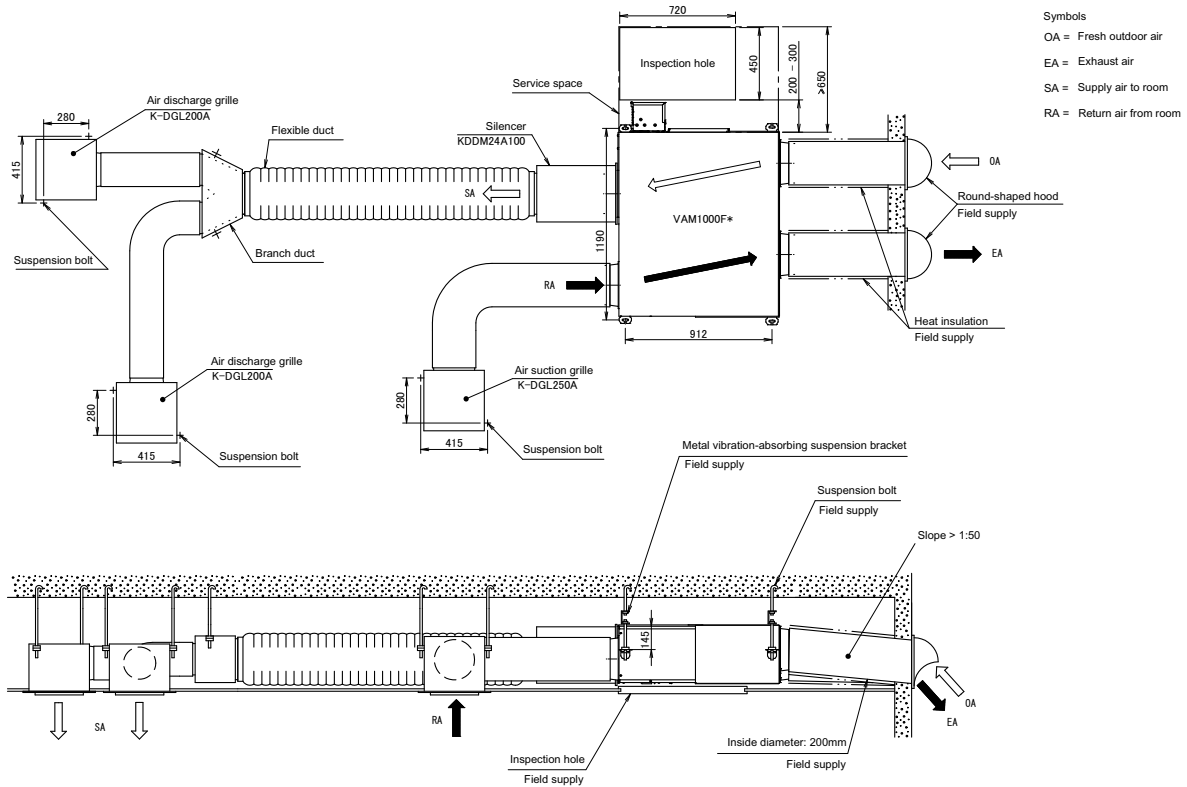

- Symbols**
 OA = Fresh outdoor air
 EA = Exhaust air
 SA = Supply air to room
 RA = Return air from room

3D091271A

VAM1500FC

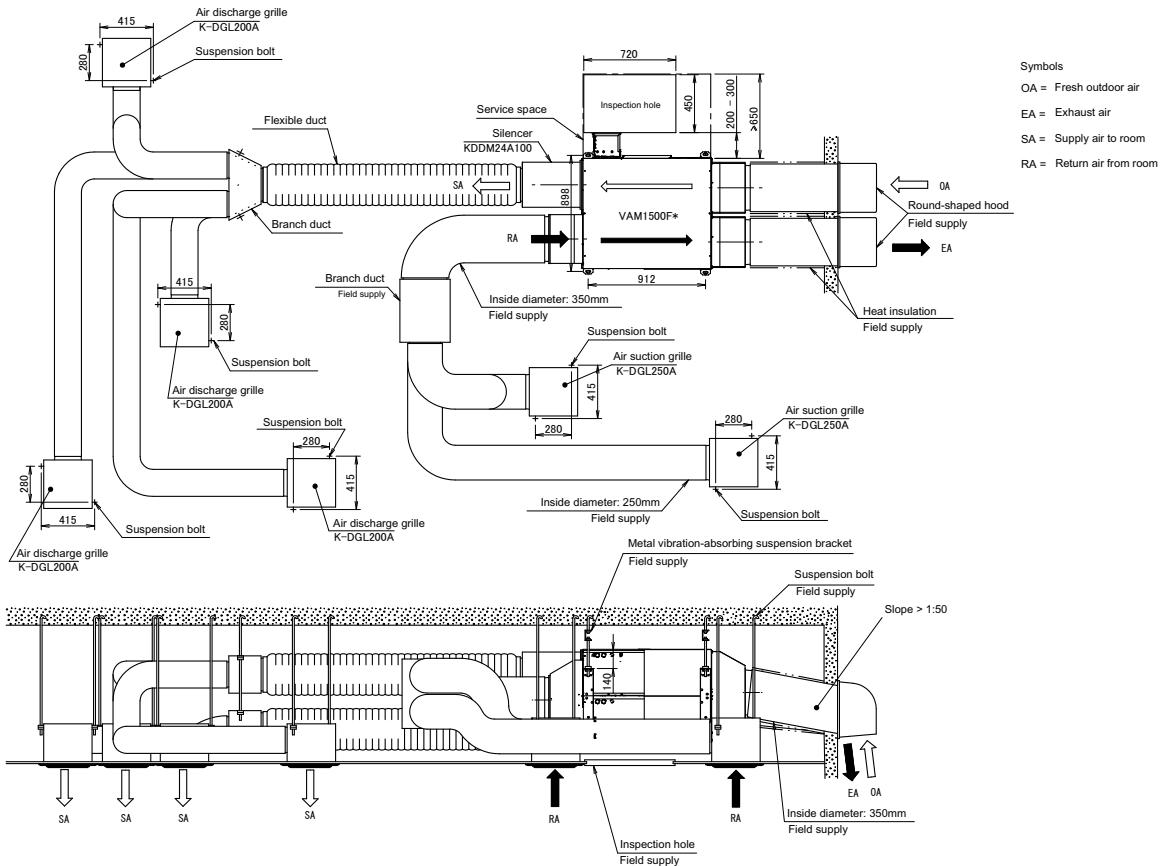

- Symbols**
 OA = Fresh outdoor air
 EA = Exhaust air
 SA = Supply air to room
 RA = Return air from room

3D081272A

11 Installation

11 - 1 Installation Method

11

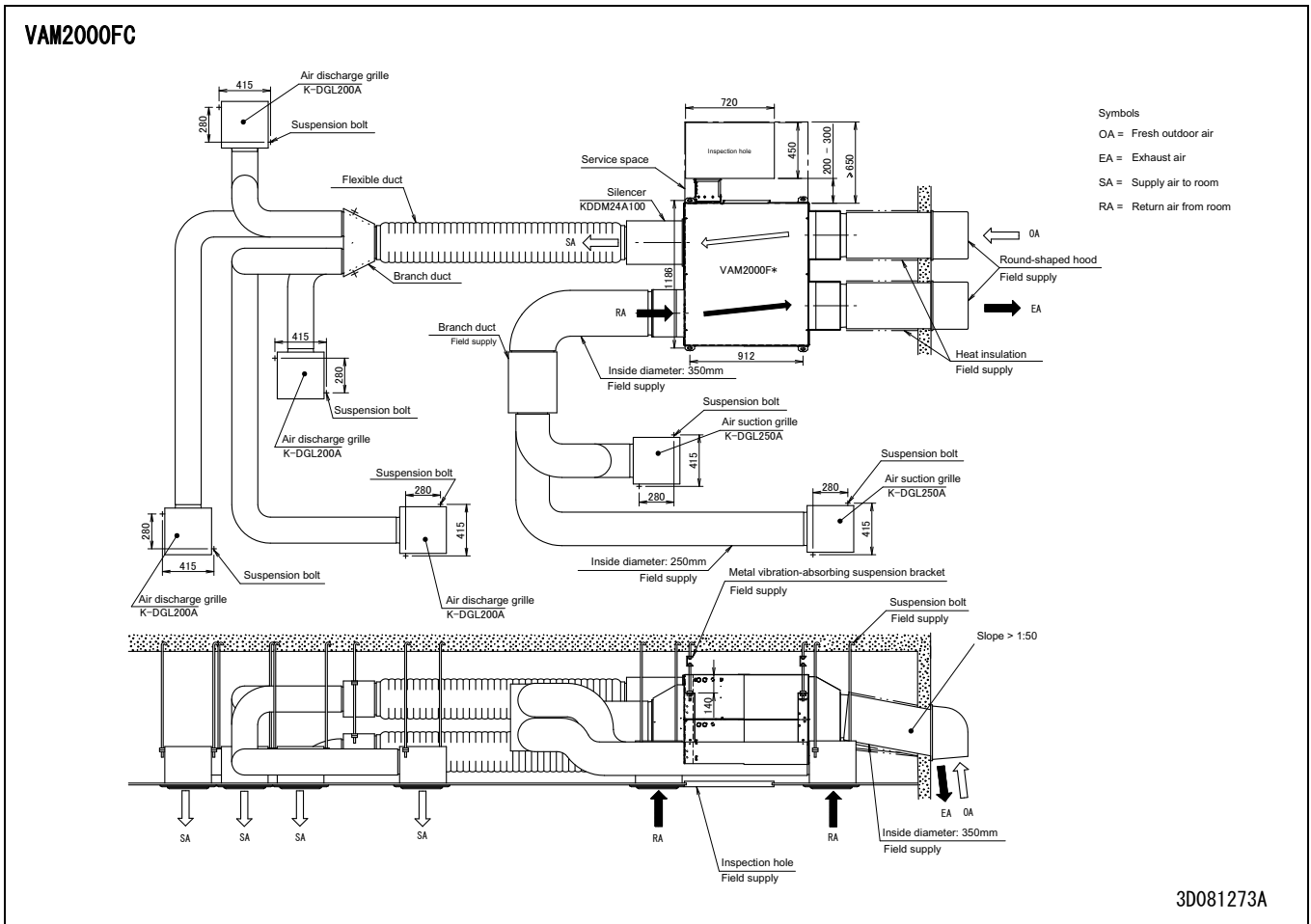



Daikin Europe N.V. Naamloze Vennootschap - Zandvoordestraat 300, B-8400 Oostende - Belgium - www.daikin.eu - BE 0412 120 336 - RPR Oostende

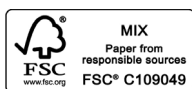
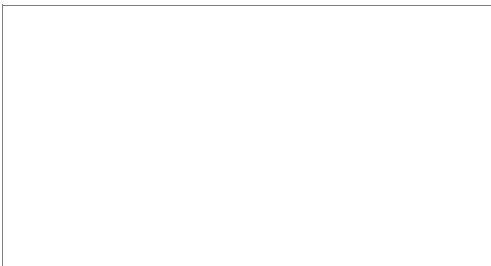

EEDEN XXX-04/16



The present leaflet is drawn up by way of information only and does not constitute an offer binding upon Daikin Europe N.V.. Daikin Europe N.V. has compiled the content of this leaflet to the best of its knowledge. No express or implied warranty is given for the completeness, accuracy, reliability or fitness for particular purpose of its content and the products and services presented therein. Specifications are subject to change without prior notice. Daikin Europe N.V. explicitly rejects any liability for any direct or indirect damage, in the broadest sense, arising from or related to the use and/or interpretation of this leaflet. All content is copyrighted by Daikin Europe N.V.