

# Total Heat Exchanger HRV (Heat Reclaim Ventilation) -with DX Coil-

English

Deutsch

Français

Español

Italiano

Ελληνικά

Nederlands

Portugues

Русский

## MODELS

(Ceiling mounted duct type)

### With DX coil & Humidifier



VKM50GMV1  
VKM80GMV1  
VKM100GMV1

### With DX coil

VKM50GV1  
VKM80GV1  
VKM100GV1

## HRV

### HRV;Heat Reclaim Ventilation

Please read this installation manual carefully and install the unit properly to keep it at full capacity for a long time.  
Please provide some necessary parts, for example round hoods, air suction/discharge grilles etc., before the installation of the unit.

### HRV;Wärmerückgewinnungslüftung

Lesen Sie dieses Installationshandbuch bitte sorgfältig durch, und installieren Sie die Einheit korrekt, so daß sie ihre Leistungsfähigkeit noch lange Zeit behält.

Einige erforderliche Teile wie z. B. Rundkappen, Luftansaug-/Lufausblasgitter müssen bereits vor der Installation der Einheit vorhanden sein.

### HRV;Ventilation avec récupération de chaleur

Veillez lire attentivement ce Manuel d'installation et installer correctement l'appareil de manière à ce qu'il puisse être utilisé pendant une longue période de temps sans aucun dérangement.

Veillez vous procurer certains éléments nécessaires, tels que des capuchons de formes arrondies, des grilles d'aspiration/évacuation d'air., avant l'installation de cette unité.

### HRV;Ventilación con recuperación de calor

Por favor lea cuidadosamente el manual de instalacion e instale correctamente la unided para que pueda conservar su plena capacidad durante un largo periodo.

Por favor, antes de proceder a la instalacion de la unidad, proporcione las piezas necesarias, por ejemplo tapas redondas, rejillas de aspiracion y de impulsión de aire, etc.

### HRV;Ventilazione per recupero del calore

Leggere attentamente questo mauale ed installare correttamente l'unit in modo da farla funzionare a lungo al massimo delle sue capacita.

Prima dell'installazione, è opportuno disporuno delle partinec-essarie, come ganci arrotondati, griglie di aspirazione/di mandata, ecc.

### HRV;Αερισμός με ανάκτηση θερμότητας

Διαβάστε προσεκτικά το παρόν εγχειρίδιο εγκατάστασης και εγκαταστήστε σωστά τη μονάδα για να διατηρήσετε την πλήρη απόδοσή της για πολύ καιρό.

Προμηθευτείτε μερικά απαραίτητα εξαρτήματα π.χ. κυκλικά καλύμματα, εσχάρες αναρρόφησης/κατάθλιψης κ.τ.λ. πριν εγκαταστήσετε τη μονάδα.

### HRV;Hergebruik van warmte

Lees eerst zorgvuldig deze installatiehandleiding en installeer de unit op de juiste manier, zodat deze gedurende lange tijd zijn volledige vermogen kan leveren.

Zorg dat alle componenten aanwezig zijn, zoals ronde kappen, luchtaan- en afvoerroosters etc. voordat u de unit gaat installeren.

### HRV;Ventilação de Recuperação Térmica

Leia atentamente este manual e instale correctamente esta unidade para que esta funcione inteiramente durante um longo período de tempo.

Adquira algumas peças necessárias, por exemplo, tampas redondas, grelhas de aspiração/exaustão, etc., antes da instalação da unidade.

### HRV;Вентиляция с регенерацией тепла

Внимательно ознакомьтесь с данным руководством и установите блок надлежащим образом, чтобы он работал на полную мощность в течение долгого времени.

Перед установкой блока подготовьте необходимые детали, например колпак округлой формы, решетки всасывания/выпуска воздуха и т.п.





With DX coil & Humidifier	VKM50GMV1	With DX coil	VKM50GV1
	VKM80GMV1		VKM80GV1
	VKM100GMV1		VKM100GV1

# CONTENTS

1 SAFETY CONSIDERATIONS .....	1
2 BEFORE INSTALLATION .....	2
3 SELECTING INSTALLATION SITE .....	3
4 PREPARATIONS BEFORE INSTALLATION.....	4
5 THE METHOD OF INSTALLATION.....	4
6 DRAIN PIPING AND WATER SUPPLY WORK .....	5
7 REFRIGERANT PIPING WORK .....	6
8 DUCT CONNECTION .....	7
9 ELECTRIC WIRING WORK.....	8
10 WIRING EXAMPLE AND HOW TO SET THE REMOTE CONTROLLER .....	9
11 FIELD SETTING AND TEST RUN .....	13
12 WIRING DIAGRAM .....	16

## 1 SAFETY CONSIDERATIONS

Please read these "SAFETY CONSIDERATIONS" carefully before installing HRV and be sure to install it correctly.

The safety precautions listed here are divided into two categories.

In either case, important safety information is listed which must be read carefully.

**⚠ WARNING** ..... Failure to observe a warning may result in death or serious injury.

**⚠ CAUTION** ..... Failure to observe a caution may result in injury or damage to the equipment. These too might lead to serious injury depending on the circumstances.

After completing the installation, make sure that the unit operates properly during the start-up operation. Please instruct the customer on how to operate the unit and keep it maintained. Also, inform customers that they should store this installation manual along with the operation manual for future reference.

### ⚠ WARNING

- Ask your dealer or qualified personnel to carry out installation work. Do not try to install the machine yourself. Improper installation may result in water leakage, electric shocks or fire.
- Installation should be done following the installation manual and no changes should be made to the unit. Incorrect installation may cause leaking, electric shocks, or fire. Injuries may result if the HRV falls.
- Install the unit on a foundation strong enough to withstand the weight of the unit. A foundation of insufficient strength may result in the equipment falling and causing injuries.
- Do not allow exhaust air to enter the outside air intake vent. This may cause the air of the room to become contaminated, harming the health.
- Locate the outside air intake vent so that it does not take in exhaust air which contains combustion air, etc. Incorrect installation may cause a loss of oxygen in the room, leading to serious accidents.
- Make sure that a separate power supply circuit is provided for this unit and that all electrical work is carried out by qualified personnel according to local laws and regulations and this installation manual. An insufficient power supply capacity or improper electrical construction may lead to electric shocks or fire. Insufficient power supply capacity or incorrect wiring may cause electrical shocks or fire.

- Use only accessories and manufacturer-specified parts when installing. The use of parts other than specified may cause drop of the unit, water leakage, electric shock, fire or other accidents.
- Be sure to ground. Do not connect the ground wire to gas or water pipes, lightning rod or a telephone ground wire. Incomplete grounding may result in electric shocks.
- Make sure that all wiring is secured, the specified wires are used, and no external forces act on the terminal connections or wires. Improper connections or installation may result in overheating or fire.
- When wiring the power supply and connecting the remote controller wiring and transmission wiring, position the wires so that the electric parts box lid can be securely fastened. Improper positioning of the electric parts box lid may result in electric shocks, fire or the terminals overheating.
- When installing the unit in a small room, take measures against to keep refrigerant concentration from exceeding allowable safety limits in the event of refrigerant leakage. Contact the place of purchase for more information. Excessive refrigerant in a closed ambient can lead to oxygen deficiency.
- If the refrigerant gas leaks during installation, ventilate the area immediately. Toxic gas may be produced if the refrigerant gas comes into contact with fire.
- After completing the installation work, check that the refrigerant gas does not leak. Toxic gas may be produced if the refrigerant gas leaks into the room and comes into contact with a source of fire, such as a fan heater, stove or cooker.
- Do not directly touch any refrigerant which has leaked out of refrigerant piping connections, etc. This may cause frostbite.

### ⚠ CAUTION

- Be sure to install an earth leakage breaker. Failure to install an earth leakage breaker may result in electric shocks or fire.
- Install the indoor and outdoor units, power supply wiring and connecting wires at least 1 meter away from televisions or radios in order to prevent image interference or noise. (Depending on the radio waves, a distance of 1 meter may not be sufficient enough to eliminate the noise.)
- While following the instructions in this installation manual, install drain piping in order to ensure proper drainage and insulate piping in order to prevent condensation. Improper drain piping may result in water leakage and property damage.
- Install the two outdoor ducts with down slope to prevent rain-water from entering the unit. If this is not done completely, water may enter the building, may damage furniture, and cause electric shocks and fire.
- Insulate the two outdoor ducts and the supply air duct to prevent condensation. If this is not done completely, water may enter the building, may damage furniture, etc.
- Insulate the duct and the wall electrically when a metal duct is to be penetrated through the metal lattice and wire lattice or metal lining of a wooden structure wall. Improper duct work may cause electric shocks or fire.
- Do not install the unit in the following locations:
  - a. Place subjected to high temperature or direct flame. May result in fire or overheating.
  - b. Where a mineral oil mist or an oil spray or vapor is produced, for example in a kitchen. This may cause fire.

- c. Place such as machinery plant and chemical plant where gas, which contains noxious gas or corrosive components of materials such as acid, alkali organic solvent and paint, is generated. Place where combustible gas leakage is likely. Copper piping and brazed joints may corrode, causing refrigerant to leak or poisoning and fire due to leaked gas.
  - d. Place such as bathroom subjected to moisture. Electric leak or electric shocks and other failure can be caused.
  - e. Locations below freezing point. Using the unit at temperatures below 0°C may cause the drain pan the supply and discharge piping, the humidifying element, the solenoid valves, and other parts to freeze, which can cause accidents.
  - f. Near machinery emitting electromagnetic waves. Electromagnetic waves may disturb the operation of the control system and result in a malfunction of the equipment.
- Make sure the temperature and humidity near the unit and the air suction/discharge air grille is within limit dictated by the usage conditions. Do not install in refrigerated truck or other locations with low temperatures or near heated pools. This may cause fires or short circuits.
  - Make sure that a snow protection measure is taken. If no protection snow may enter through the outdoor ducts, and cause damaging furniture and electric shock and fire.

## 2 BEFORE INSTALLATION

The accessories needed for installation must be retained in your custody until the installation work is completed. Do not discard them!

After carrying in the unit, protect it with packing materials to prevent it from scratching until installation work is done.

[1] Decide upon a line of transport.

[2] Leave the unit inside its packaging while moving, until reaching the installation site. Where unpacking is unavoidable, use a sling of soft material or protective plates together with a rope when lifting, to avoid damage or scratches to the unit.

Hold the unit by the hanger brackets (4) when opening the crate and moving it, and do not lift it holding on to any other part (especially the refrigerant piping, the drain piping, the water supply piping, and the duct connecting flange).



- Be sure to check the type of R410A refrigerant to be used before installing the unit. (Using an incorrect refrigerant will prevent normal operation of the unit.)
- For the installation of an outdoor unit, refer to the installation manual attached to the outdoor unit.



### 2.1 PRECAUTIONS

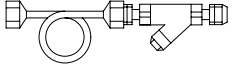

- Be sure to instruct customers how to properly operate the unit (especially maintenance of air filter, and operation procedure) by having them carry out operations themselves while looking at the manual.
- Where the air contains high levels of salt such as that near the ocean and where voltage fluctuates greatly such as that in factories. Also in vehicles or vessels.

## 2.2 ACCESSORIES

Check the following accessories are included with your unit.

Name	Duct connecting flange	M4 tapping screw (For connecting duct)	Water supply piping with strainer
Quantity	4 pcs.	24 pcs.	VKM-GMV1: 1 pc. VKM-GV1: 0 pc.
Shape			

Name	Half-union joint (Copper piping joint)	Flare nut (Copper piping joint)	Refrigerant piping insulation cover
Quantity	VKM-GMV1: 1 pc. VKM-GV1: 0 pc.	VKM-GMV1: 1 pc. VKM-GV1: 0 pc.	1 set
Shape			 I.D.: φ35 I.D.: φ26

Name	Water supply piping insulation cover	Sealing material	Clamp	(Other) • Installation manual • Operation manual
Quantity	VKM-GMV1: 1 pc. VKM-GV1: 0 pc.	1 pc.	VKM-GMV1: 8 pcs. VKM-GV1: 6 pcs.	
Shape	 I.D.: φ15			

### 2.3 OPTIONAL ACCESSORIES

- This unit can be made a part of two different systems: as part of the combined operation system used together with VRVII SYSTEM Air Conditioners, and as the independent system using only the HRV. An operating remote controller is required for this unit when using the unit as an independent system. Select a suitable remote controller from below table according to customer request and technical materials.

Table

Remote controller type	BRC1A62, BRC1D527
------------------------	-------------------

NOTE) 1

If you use the remote controller which is not listed in above table, please consult your dealer.

NOTE) 2

We recommend the remote controller "BRC1D527" especially when the unit is used as independent system. Because it displays the ventilation mode and can be selected ventilation fan mode with the button.

- When installing the unit, have ready the round shape hood, the air discharge grille and the air suction grille, and other parts needed for the installation. Consult your Daikin dealer when selecting optional accessories.

**FOR THE FOLLOWING ITEMS, TAKE SPECIAL CARE DURING CONSTRUCTION AND CHECK AFTER INSTALLATION IS FINISHED.**

**a. Items to be checked after completion of work**

Items to be checked	If not properly done, what is likely to occur	Check
Are the indoor and outdoor unit fixed firmly?	The units may drop, vibrate or make noise.	
Is the outdoor duct installed to outside with down slope? (Refer to page 8 Fig. 16)	Condensate water may drip.	
Is the gas leak test finished?	It may result in insufficient cooling.	
Is the unit fully insulated?	Condensate water may drip.	
Does drainage flow smoothly?	Condensate water may drip.	
Does the power supply voltage correspond to that shown on the name plate?	The unit may malfunction or the components burn out.	
Are wiring and piping correct?	The unit may malfunction or the components burn out.	
Is the unit safely grounded?	Dangerous at electric leakage.	
Is wiring size according to specifications?	The unit may malfunction or the components burn out.	
Is something blocking the air outlet or inlet of either the indoor or outdoor units?	It may result in insufficient cooling.	
Are refrigerant piping length and additional refrigerant charge noted down?	The refrigerant charge in the system is not clear.	
Is water supplied with the water supply piping connected?	Not humidified.	

Please check all items listed in the "SAFETY CONSIDERATIONS" above once again.

**b. Items to be checked at time of delivery**

Items to be checked	Check
Did you explain about operations while showing the operation manual to your customer?	
Did you hand the operation manual and warranty over to your customer?	

**c. Points for explanation about operations**

The items with **⚠** WARNING and **⚠** CAUTION marks in the operation manual are the items pertaining to possibilities for bodily injury and material damage in addition to the general usage of the product. Accordingly, it is necessary that you make a full explanation about the described contents and also ask your customers to read the operation manual.

**3 SELECTING INSTALLATION SITE**

**⚠ CAUTION**

- When moving the unit during or after unpacking, make sure to lift it by holding its hanger brackets. Do not exert any pressure on other parts, especially the refrigerant piping, drain piping, water supply piping and duct connecting flange.
- If you think the humidity inside the ceiling might exceed 30°C and RH80%, reinforce the insulation on the inter-unit piping. Use glass wool or polyethylene foam as insulation so that it is no thicker than 10mm and fits inside the ceiling opening.
- Use glass wool or polyethylene form of 10mm or more thick which fit into ceiling opening as insulation material.

**(1) Select an installation site where the following conditions are fulfilled and that meets with your customer's approval.**

- Install in a place which has sufficient strength and stability. (Beams, ceiling, and other locations capable of fully supporting the weight of the unit.) Insufficient strength is dangerous. It may also cause vibration and unusual operating noise.
- Where piping between indoor and outdoor units is possible within the allowable limit. (Refer to the installation manual for the outdoor unit.)
- Where nothing blocks air passage.
- Where condensate can be properly drained.
- Install in a location where the air around the unit or taken into the humidifier will not drop below 0°C.
- Do not install the unit directly against a ceiling or wall. (If the unit is in contact with the ceiling or wall, it can cause vibration.)
- Where sufficient clearance for maintenance and service can be ensured. (Refer to Fig. 1)

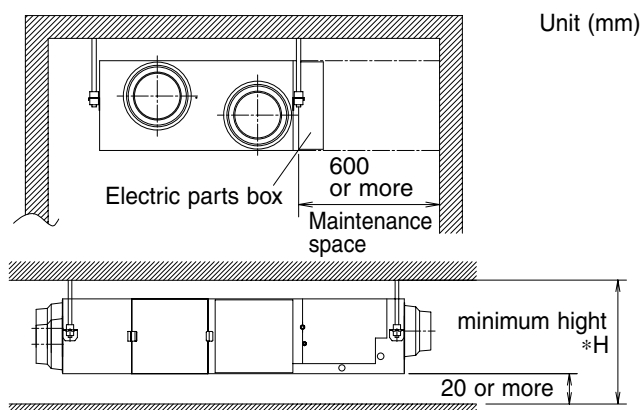

**Fig. 1** Select the \*H dimension such that a downward slope of at least 1/100 is ensured as indicated in "6 DRAIN PIPING AND WATER SUPPLY WORK".

**[PRECAUTION]**

- Install the indoor and outdoor units, power supply wiring and connecting wires at least 1 meter away from televisions or radios in order to prevent image interference or noise. Depending on the radio waves, a distance of 1 meter may not be sufficient enough to eliminate the electric noise.
- The bellows may not be able to be used in some districts, so exercise caution. (Contact your local government office or fire department for details.)
- When discharging exhaust air to a common duct, the Building Standard Law requires the use of fire-proof materials, so attach a 2m copper plate standing duct.

**(2) Use suspension bolts for installation. Check whether the ceiling is strong enough to support the weight of the unit or not. If there is a risk, reinforce the ceiling before installing the unit.**

(Installation pitch is mentioned as follow. Refer to it to check for points requiring reinforcing.)

## 4 PREPARATIONS BEFORE INSTALLATION

### (1) Confirm the positional relationship between the unit and suspension bolts. (Refer to Fig. 2)

Leave space for servicing the unit and include inspection hatches. (Always open a hole on the side of the electric parts box so that the air filters, heat exchange elements, fans, and humidifier elements can easily be inspected and serviced.)

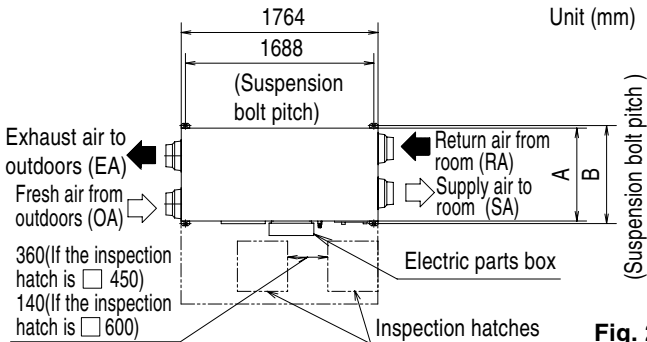

Fig. 2

(mm)

Model	A	B
VKM50GMV1, VKM50GV1	832	878
VKM80GMV1, VKM80GV1 VKM100GMV1, VKM100GV1	1214	1262

### (2) Make sure the range of the unit's external static pressure is not exceeded.

(See the fan-strength and static performance characteristic drawings as well as the general catalog for the range of the external static pressure setting.)

### (3) Open the installation hole. (Pre-set ceilings)

- Once the installation hole is opened in the ceiling where the unit is to be installed, pass refrigerant, drain piping, transmission wiring, and remote controller wiring to the unit's piping and wiring holes.

See "6 DRAIN PIPING AND SUPPLY WATER WORK", "7 REFRIGERANT PIPING WORK", and "10 WIRING EXAMPLE AND HOW TO SET THE REMOTE CONTROLLER".

- After opening the ceiling hole, make sure ceiling is level if needed. It might be necessary to reinforce the ceiling frame to prevent shaking. Consult an architect or carpenter for details.

### (4) Install the suspension bolts.

(Use M10 to M12 suspension bolts.)

Use a hole-in-anchor, sunken insert, sunken anchor for existing ceilings, or other part to be procured in the field to reinforce the ceiling to bearing the weight of the unit.

(Refer to Fig. 3)

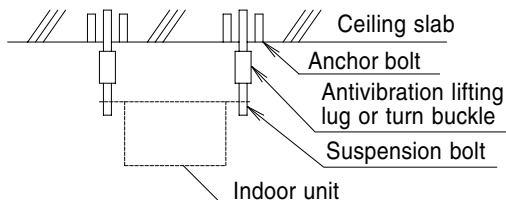

Note: All the above parts are locally procured.

Fig. 3

## 5 THE METHOD OF INSTALLATION

### ⚠ CAUTION

«Hold underside of the unit or hanger bracket without putting force on other parts when unpacking or moving the unit.»

«As for the parts to be used for installation work, be sure to use the provided accessories and specified parts designated by our company.»

### (1) Install the unit temporarily.

- Attach the hanger bracket to the suspension bolt. Be sure to fix it securely by using nuts and washers (locally procured) from the upper and lower sides of the hanger bracket. (Refer to Fig. 4)

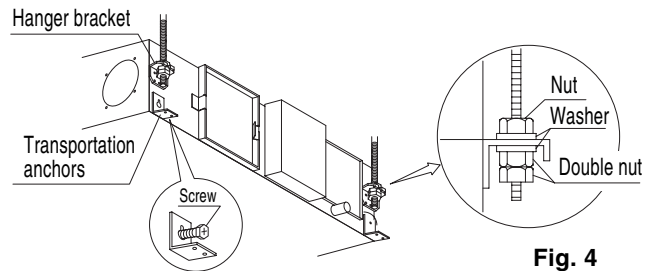

Fig. 4

### (2) If unnecessary, remove the four transportation anchors.

- Loosen the screws.
- Slide upward and remove the transportation anchors.
- Securely tighten the screws as before.

### ⚠ CAUTION

- The screws shouldn't be removed from the unit and should be tightened in order to prevent air from escaping.
- Check that foreign objects such as plastic or paper are not contained in the unit when installing.

- Install the unit after checking the indoor (SA/RA) and outdoor (EA/OA) in accordance with the figure duct layout precaution label.
- Do not turn the unit upside down.

### (3) Adjust the height of the unit.

(Tighten the double nuts securely.)

**(4) Check the unit is horizontally level.**

**CAUTION**

Use a level to make sure that the unit is level and that the tilt (downward slope) to the drain piping connection is within 1°. (Refer to Fig. 5)

(One thing to watch out for in particular is if it is installed so that the slope is not in the direction of the drain piping, as this might cause leaking.)

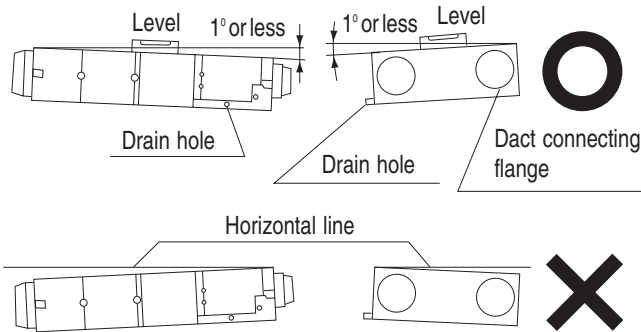

Fig. 5

**(5) Tighten the upper nut.**

**(6) Attach the accessory duct connecting flanges using the included screws to the outlet and intake holes (a total of four).**

When attaching, make sure the alignment markings on the unit match up with the triangle on the each duct connecting flange. (Refer to Fig. 6)

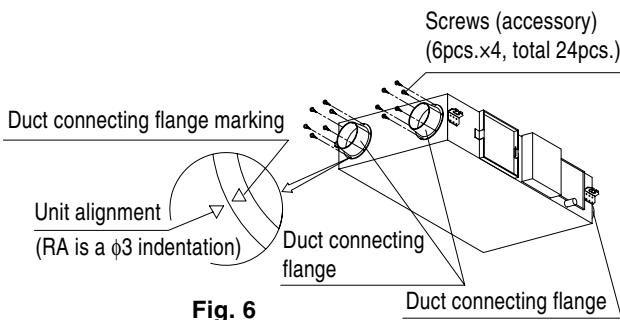

Fig. 6

**6 DRAIN PIPING AND WATER SUPPLY WORK**

**(1) Install the drain piping.**

- Make sure the drain works properly.
- In case of the direct duct connection system, there is negative pressure inside the unit relative to atmospheric pressure when the unit is running, so be sure to provide drain trap on the drain outlet. (See Fig. 7-1)

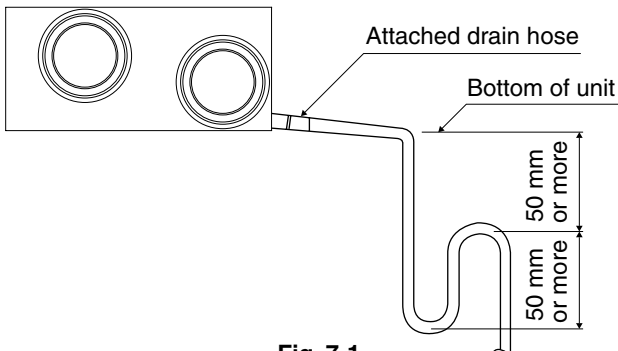

Fig. 7-1

**CAUTION**

Do not connect the drain piping directly to sewage pipes that smell of ammonia. The ammonia in the sewage might enter the indoor unit through the drain pipes and corrode the heat exchanger (Direct expansion coil).

- Keep the drain pipe short and sloping downwards at a gradient of at least 1/100 to prevent air pockets from forming. (Refer to Fig. 7-2)
- If converging multiple drain pipes, install according to the procedure shown below. (Install a drain trap for each indoor unit.)

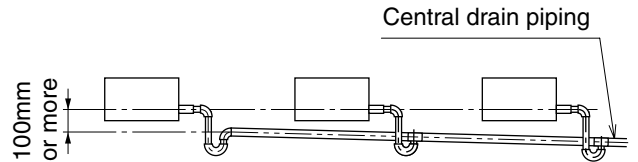

Fig. 7-2 (Install with a downward slope of at least 1/100)

**CAUTION**

Water accumulating in the drain piping can cause the drain to clog.

- The diameter of the drain pipe should be greater than or equal to the diameter of the connecting pipe. (pipe size: PT3/4B)
- When piping passes indoors, always insulate it all the way to the base of the drain socket.
- In areas where freezing may occur, always take steps to prevent the pipes from freezing.
- Make sure water doesn't leak from the drain pipes.
- Avoid bends and curves in the pipes to prevent them getting clogged.
- If you are using central drain piping, follow the procedure outlined in the figure 7-2.
- Select central drain pipes of proper size according to the capacity of the connected unit.
- Make sure the tip of the drain pipes opens out into a location where the drainage can be safely processed.

**(2) After piping work is finished, check drainage flows smoothly.**

- Test the drainage by pouring around 1000cc of water into the drain pan through the inspection hole by removing the maintenance cover (10 screws) or through the outlet duct joint of supply air to room (SA). (Refer to Fig. 8)

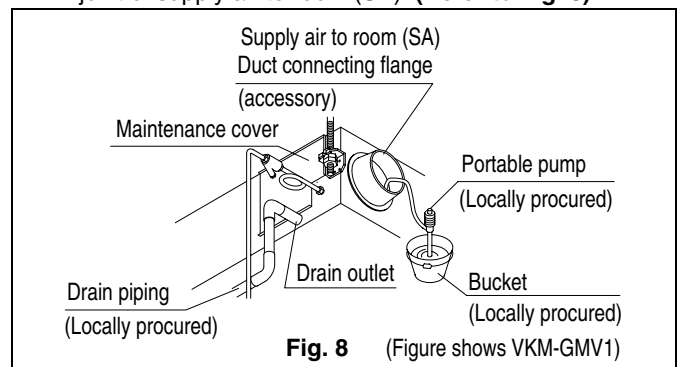

Fig. 8 (Figure shows VKM-GMV1)

**(3) Make sure that heat insulation work is executed on the following 2 spots to prevent any possibility water leakage due to dew condensation.**

- Indoor drain piping
- Drain outlet

#### (4) Install the water supply piping. (VKM-GMV1 series only)

##### CAUTION

When installing the water supply piping, wash the pipes with tap water so that all dirt is removed from them or install a drain valve somewhere along the piping and drain the pipes thoroughly until the water flowing through them is clear. Make sure no cutting oils or detergents get into the pipes.

- Connect the water supply piping with strainer (accessory), other pipings and valves (locally procured) to the indoor unit as shown in the figure at below.

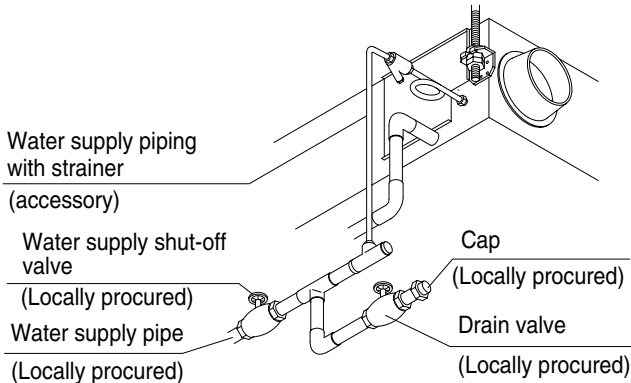

##### [PRECAUTION]

- When installing the water supply piping, do not pass piping in front of the maintenance cover, as this will make it impossible to remove the humidifier element.
- Include the water supply piping with strainer (included), a water supply shut-off valve, and a drain valve (both locally procured) somewhere along the water supply piping that can be reached from the inspection hole.
- It is impossible to connect the water supply piping directly to public piping. Use a cistern tank (of the approved type) if you need to get your water supply from public piping.
- When using copper piping for the water supply connections, replace the included half-union joints. (Refer to Fig. 9)

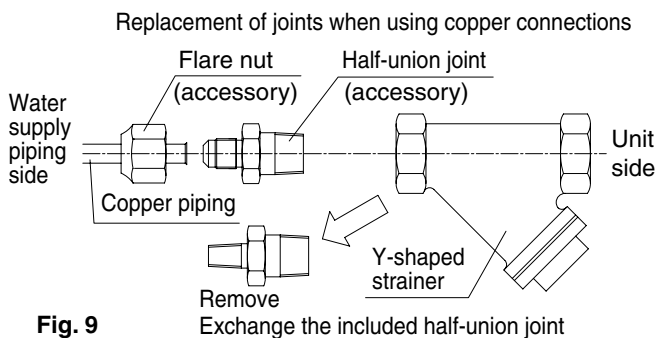

Fig. 9 Exchange the included half-union joint

- Use two spanners when attaching or removing pipes to the half-union joints.
- Secure the water supply piping without applying pressure

##### [PRECAUTIONS]

- Use pure water (city water, tap water or equivalent) that satisfies the standard regulated by the law of each country for water supply to the humidifier when performing anti-sweat work.
- Dirty water may cause valves to clog, dirt to accumulate in water tanks, and resulting in poor humidifier performance. (Never use water from a cooling tower or warm water for heating.)
- Make sure the supply water is between 5°C and 40°C in temperature and 0.02MPa to 0.49MPa (0.2kg/cm<sup>2</sup> to 5kg/cm<sup>2</sup>) in pressure. Include a pressure release valve between the humidifier and the strainer if the water pressure will be higher than this range.
- Use city water or clean water and take steps to prevent condensation from forming.

- Also, if the supply water is hard water, use a water softener because of short life.
  - \* Life of humidifying element is about 3 years (4,000 hours), under the supply water conditions of hardness: 150mg/l. (Life of humidifying element is about 1 year (1,500 hours), under the supply water conditions of hardness: 400mg/l.)
  - Annual operating hours: 10 hours / day × 26 days / month × 5 month = 1,300 hours

#### (5) Insulate all piping that passes indoors.

After checking that the water supply piping connections do no leak, insulate them using the included insulation as shown in Fig. 10. (Tighten both edges with clamping material.) (Refer to Fig. 10)

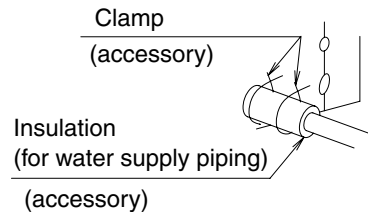

Fig. 10

- Wrap the water supply piping with insulation to prevent condensation from forming.
- In areas where freezing may occur, always take steps to prevent the pipes from freezing.

## 7 REFRIGERANT PIPING WORK

(For refrigerant piping of outdoor units, see the installation manual attached to the outdoor unit.)

(Execute heat insulation work completely on both sides of the gas piping and the liquid piping. Otherwise, a water leakage can result sometimes.)

Use insulation that can withstand temperatures of at least 120°C. Improve insulation of refrigerant piping according to the installation environment. Condensation may form on the surface of the insulation.)

(Before refrigerant piping work, check the type of R410A refrigerant is used. (Proper operation is not possible if the types of refrigerant are not the same.))

##### CAUTION

This product must use a new refrigerant (R410A). Obey the following items.

- Use a pipe cutter and flare suitable for the type of refrigerant (R410A).
- Apply ester oil or ether oil around the flare portions before connectioning.
- Only use the flare nuts included with the unit. Using different flare nuts may cause the refrigerant to leak.
- To prevent dust, moisture or other foreign matter from infiltrating the tube, either pinch the end or cover it with tape.
- Do not allow anything other than the designated refrigerant to get mixed into the refrigerant circuit, such as air, etc. If any refrigerant gas leaks while working on the unit, ventilate the room thoroughly right away.

- The outdoor unit is charged with refrigerant.
- Be sure to use both a spanner and torque wrench together, as shown in the drawing, when connecting or disconnecting pipes to the unit. (Refer to Fig. 11)
- Refer to the "Table 1" for the dimensions of flare nut spaces.



Table 1

Pipe gauge	Tightening torque	Flare dimension A (mm)	Flare shape
φ 6.4	14.2–17.2 N·m	8.7 – 9.1	
φ12.7	49.5–60.3 N·m	16.2 – 16.6	

- When connecting the flare nut, coat the flare section (both inside and outside) with ester oil or ether oil, rotate three or four times first, then screw in. **(Refer to Fig. 12)**

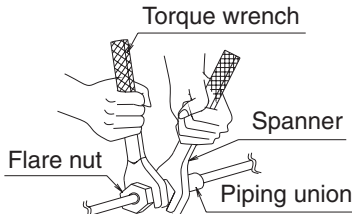

Fig. 11

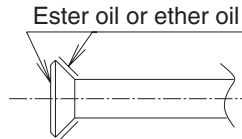

Fig. 12

- Refer to the “Table 1” for tightening torque.

**CAUTION**

**Over-tightening may damage the flare and cause a refrigerant leakage.**

- If a torque wrench is not available, tighten the nut in the following manner. Once work is complete, make sure there is no gas leaking. As the flare nut is tightened with the wrench, the torque will suddenly increase. From that position, tighten the nut to the angle shown on “Table 2”.

Table 2

Pipe size	Further tightening angle	Recommended arm length of tool
φ 6.4 (1/4")	60 to 90 degrees	Approx. 150mm
φ 12.7 (1/2")	30 to 60 degrees	Approx. 250mm

- After the work is finished, make sure to check that there is no gas leak.
- After checking the pipe-connection for gas leakage, be sure to insulate the liquid and gas piping. **(Refer to Fig. 13)**

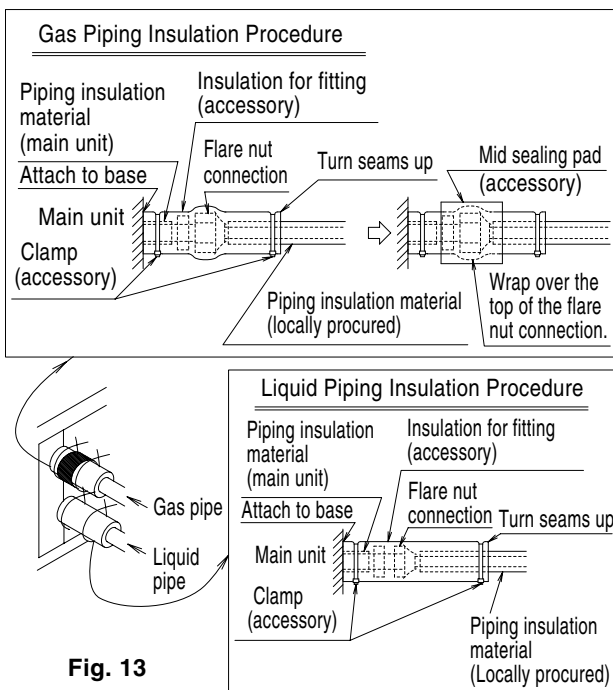

Fig. 13

**CAUTION**

Be sure to insulate any field piping all the way to the piping connection inside the unit. Any exposed piping may cause condensation or burns if touched.

- Connect refrigerant piping and branching according to the attached installation manuals that come with the outdoor unit.

Model	Gas piping diameter	Liquid piping diameter
VKM50GMV1, VKM50GV1 VKM80GMV1, VKM80GV1 VKM100GMV1, VKM100GV1	φ 12.7	φ 6.4

- When brazing the refrigerant piping, perform nitrogen replacement first, or perform the brazing (note 2) while feeding nitrogen into the refrigerant piping (note 1), and finally connect the indoor unit using the flare connections. **(Refer to Fig. 14)**

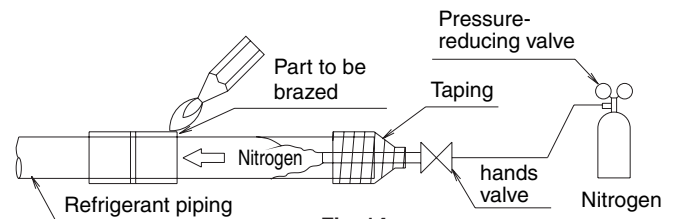

Fig. 14

**CAUTION**

- When brazing a pipe while feeding nitrogen inside the pipe, make sure to set the nitrogen pressure to 0.02 MPa (0.2 kg/cm<sup>2</sup>) or less using the pressure reducing valve. (This pressure is such that breeze is blown to your cheek.)
- Do not use a flux when brazing the refrigerant pipe joints. Use phosphor copper brazer (BCuP-2: JIS Z 3264/B-Cu93P-710/795: ISO 3677) which does not require flux. (Using a flux containing chlorine may cause the piping to corrode. Using a welding flux containing fluorine may cause the refrigerant lubricant to deteriorate, and affect adversely the refrigerant piping system.)
- Do not use anti-oxidants or other similar agent when brazing the pipe joints. Residue can clog the pipes and may cause breakdown of parts.

**8 DUCT CONNECTION**

**(Perform duct work keeping the following things in mind)**

- Do not connect the ducts as shown in Fig. 15.
  - (a) Extreme bend (Do not bend the duct over 90°)
  - (b) Multi bend
  - (c) Reduce the diameter of the duct to be connected.
  - (d) a bend right next to the outlet

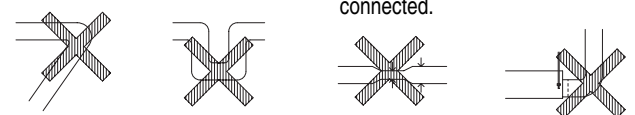

Fig. 15

- The minimal radius of bends for flexible ducts are as follows.
  - 200-mm duct : 300 mm diameter
  - 250-mm duct : 375 mm diameter
- To prevent air leakage, wind aluminum tape round the section after the duct connecting flange and the duct are connected. **(Refer to Fig. 16)**
- To prevent short circuit, install the opening of the indoor air intake as far as from the opening of the exhaust suction.

- Use the duct applicable to the model of unit used (Refer to the installation drawing.)
- Install the two outdoor ducts with down slope (slope of 1/30 or more) to prevent entry of rain water. Also, provide insulation for three ducts (Outdoor ducts and Indoor supply air duct) to prevent dew condensation. (Material : Glass wool of 25 mm thick) (Refer to Fig. 16)
- If the level of temperature and humidity inside the ceiling is always high, install a ventilation equipment inside the ceiling.
- Insulate the duct and the wall electrically when a metal duct is to be penetrated through the metal lattice and wire lattice or metal lining of a wooden structure wall.
- Using flexible or silent ducts can be effective in reducing the air discharge sound of the supply air to room (SA). Select materials keeping in mind the fan strength and operating sound of the unit. Consult your Daikin dealer for selection.
- Set the pitch between the exhaust air outlet (EA) and the outside air intake (OA) to 3 times the duct diameter.
- Do not use a bent cap or a round hood as the outdoor hood if they might get rained on directly. (We recommend using a deep hood (optional accessory).)
- When using a deep hood, make sure the duct from the deep hood (outer wall) to the unit is at least 1m long.

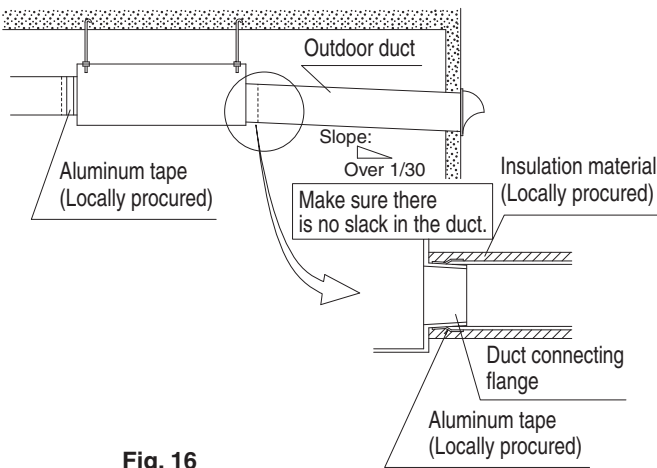

Fig. 16

- The change of air discharge grill's location should be examined when the cold draft from air discharge grill is feared. The fan is driving while defrost operation, and the cold air is often blowing.
- When connecting the indoor unit directly to the duct, always use the same system on the indoor unit as with the outdoor unit, perform group-linked operation, and make the direct duct connection settings from the remote controller (Mode No. "17 (27)" – FIRST CODE NO. "5" – SECOND CODE NO. "06") Also, do not connect to the outlet side of the indoor unit. Depending on the fan strength and static pressure, the unit might back up.

## 9 ELECTRIC WIRING WORK

- Shut off the power before doing any work.
- All field supplied parts and materials, electric works must conform to local codes.
- Use copper wire only.
- All wiring must be performed by an authorized electrician.
- See also the "Electrical Wiring Diagram label" attached to the electric parts box lid when laying electrical wiring.
- Wire the outdoor unit and remote controller as shown in the electric wiring diagram label. See the "Remote Controller Installation Manual" for details on how to install and lay the wiring for the remote controller.
- This system consists of multiple indoor units. Mark each indoor unit as unit A, unit B..., and be sure the terminal board wiring to the outdoor unit and BS unit are properly matched. If wiring and piping between the outdoor unit and an indoor unit are mismatched, the system may cause a malfunction.
- Install a wiring interrupter or ground-fault circuit interrupter for the power wiring.

- Make sure the ground resistance is no greater than 100Ω . This value can be as high as 500Ω when using a ground fault circuit interrupter since the protective ground resistance can be applied.
- Do not let the ground wire should come in contact with gas pipes, water pipes, lighting rods, or telephone ground wires.
  - Gas pipes: gas leaks can cause explosions and fire.
  - Water pipes: cannot be grounded if hard vinyl pipes are used.
  - Telephone ground and lightning rods: the ground potential when struck by lightning gets extremely high.
- Do not turn on the power supply (switch, wiring interrupter or ground fault circuit interrupter) until all other works are done.

## SPECIFICATIONS FOR FIELD SUPPLIED FUSES AND WIRE

Model	Power supply wiring			Remote controller wiring Transmission wiring	
	Field fuses 	Wire	Size	Wire	Size
VKM50GMV1, VKM50GV1	15A	H05VV-U3G	Follow local standards	Sheathed wire (2 wire)	0.75-1.25 mm <sup>2</sup>
VKM80GMV1, VKM80GV1					
VKM100GMV1, VKM100GV1					

### NOTE

- If the wiring is in a place where people it can be easily touched by people, install a leak interrupter to prevent electric shock.
- When using a ground-fault circuit interrupter, make sure to select one useful also to protection against overcurrent and short-circuit. If you use a leak interrupter which is designed for protecting against ground faults, be sure to combine it with a wiring interrupter or an load switch that has a fuse.
- The length of the transmission wiring and remote controller wiring are as follows.

Length of outdoor-indoor transmission wiring ... max 1000m (total wiring length 2000m)

Length of remote controller wiring between indoor unit and remote controller ... max 500m

## ELECTRICAL CHARACTERISTICS

Model	Units			Power supply		Fan motor	
	Hz	Volts	Voltage range	MCA	MFA	kW	FLA
VKM50GMV1, VKM50GV1	50	220-240V	Max. 264V Min. 198V	4.3	15	0.28x2	1.9x2
VKM80GMV1, VKM80GV1				4.3	15	0.28x2	1.9x2
VKM50GMV1, VKM50GV1				4.3	15	0.28x2	1.9x2

MCA: Min. Circuit Amps (A); MFA: Max. Fuse Amps (A)  
kW: Fan Motor Rated Output (kW); FLA: Full Load Amps (A)

# 10 WIRING EXAMPLE AND HOW TO SET THE REMOTE CONTROLLER

## 10.1 OPENING AND SHUTTING THE ELECTRIC PARTS BOX AND CONNECTING THE WIRING

**CAUTION**  
Be sure to power off before opening the electric parts box.

- Remove the electric parts box lid and wire as shown in the figure below.

SS1 is the switch for setting the remote controller. The unit will not run if the settings are changed.

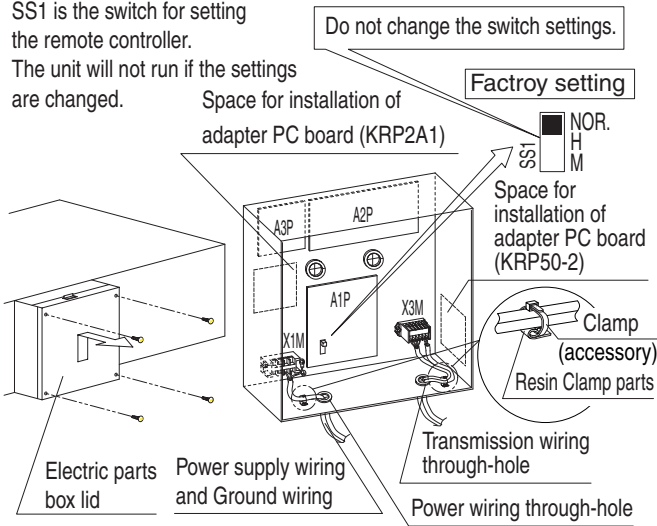

NOTE) A3P: VKM-GMV1 series only

**CAUTION**

- See "Electrical Wiring Diagram label" on the backside of the lid of the electric parts box for electric wiring work.
- Be sure to attach the sealing material or putty (locally procured) to hole of wiring to prevent the infiltration of water as well as any insects and other small creatures from outside. Otherwise a short-circuit may occur inside the electric parts box.
- When clamping the wires, be sure no pressure is applied to the wire connections by using the included clamping material to make appropriate clamps. Also, when wiring, make sure the lid on the electric parts box fits snugly by arranging the wires neatly and attaching the electric parts box lid firmly. When attaching the electric parts box lid, make sure no wires get caught in the edges. Pass wiring through the wiring through holes to prevent damage to them.
- Make sure the remote controller wiring, the wiring between the units, and other electrical wiring do not pass through the same locations outside of the unit, separating them by at least 50mm, otherwise electrical noise (external static) could cause mistaken operation or breakage.

## 10.2 Connecting power supply wiring and ground wiring

- Pass the power supply wiring and the ground wiring through the wiring through-hole into the electrical parts box and secure with the included clamping material after connecting the wires to terminal blocks. (Refer to Fig. 17-1, 17-2)

(VKM-GMV1 series)

Terminal block (X1M) details

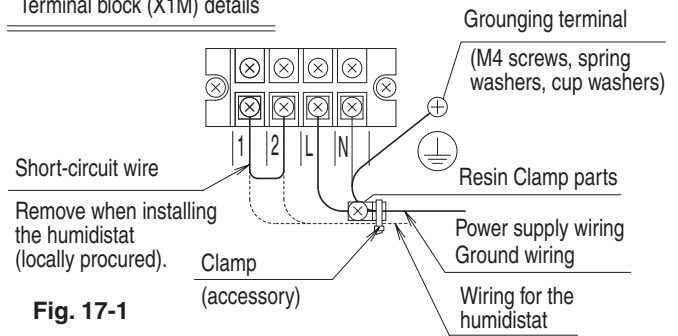

Fig. 17-1

(VKM-GV1 series)

Terminal block (X1M) details

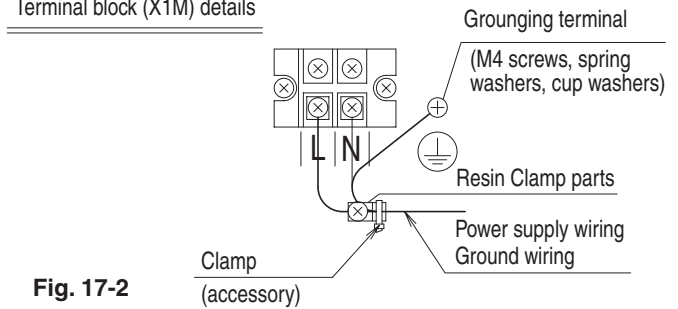

Fig. 17-2

### (Precautions when laying power supply wiring)

#### [PRECAUTIONS]

- A circuit breaker capable of shutting down power supply to the entire system must be installed.
- A single switch can be used to supply power to units on the same system. However branch switches, branch overload circuit interrupter must be selected carefully.
- Fit the power supply wiring of each unit with a switch and fuse as shown in the drawing.

#### COMPLETE SYSTEM EXAMPLE

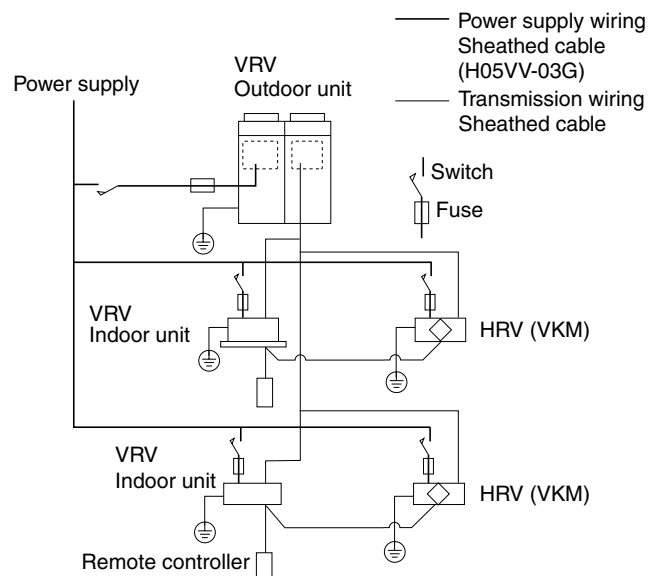

- [4] Use round crimp-style terminals for connecting wires to the power supply terminal block. If unavailable, observe the following points when wiring.
- Do not connect wires of different gauge to the same power supply terminal. (Looseness in the connection may cause overheating.)
  - Use the specified electric wire. Connect the wire securely to the terminal. Lock the wire down without applying excessive force to the terminal. (Tightening torque: 131N·cm ±10 %)

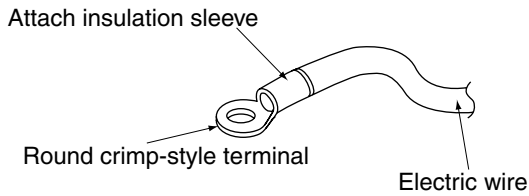

- [5] Tightening torque for the terminal screws.
- Use the correct screwdriver for tightening the terminal screws. If the blade of screwdriver is too small, the head of the screw might be damaged, and the screw will not be properly tightened.
  - If the terminal screws are tightened too hard, screws might be damaged.
  - Refer to the table below for the tightening torque of the terminal screws.

	Tightening torque (N·m)
Terminal block for remote controller/ Transmission wiring (X3M)	0.79 – 0.97
Power supply terminal block (X1M)	1.18 – 1.44
Ground terminal (M4)	1.44 – 1.94

#### <Precautions when connecting the ground>

When pulling the ground wire out, wire it so that it comes through the cut out section of the cup washer. (An improper ground connection may prevent a good ground from being achieved.)

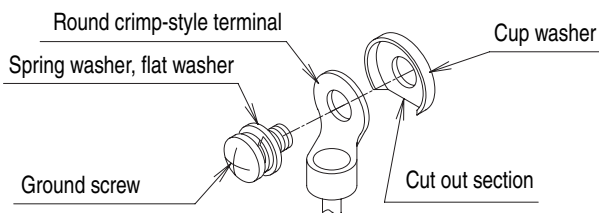

### 10. 3 Remote power supply wiring, transmission wiring, computerised control wire

- Pass the remote control wiring, the transmission wiring, and the computerised control wire into the electric parts box through the through-hole and connect to the terminals on the X3M terminal block. After connection, secure with the included cramping material. (Refer to Fig. 18)

Detail of terminal block (X3M)

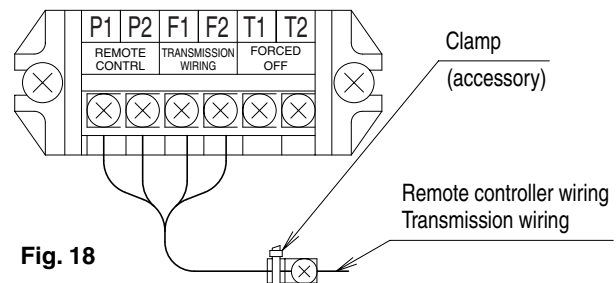

#### [PRECAUTIONS]

- Refer to the “Remote Controller Installation Manual” on how to install and lay the wiring for the remote controller.
- Do not, under any circumstances, connect the power wiring to the remote controller or transmission wiring terminal block. Doing so can destroy the entire system.
- Connect the remote controller and transmission wiring their respective terminal blocks.

### 10. 4 Wiring for the humidity regulator (locally procured) (VKM-GMV1 series only)

- Pass into the electric parts box together with the power wire through the power wiring through-hole.
- Remove the short-circuit wires (1 and 2) on the X1M terminal block and connect the wiring for the humidity regulator.
- Secure with cramping material together with the power wire. (Refer to Fig. 17-1)

Wiring specifications	Sheathed wire (2 wire)
Size	0.75 - 1.25mm <sup>2</sup>
Length	MAX. 100m
External contact specifications	Normally closed contact (Current tolerance 10mA – 0.5A)

#### ⚠ CAUTION

#### <VKM-GMV1 series only>

- If using humidistat, install one per HRV unit. Controlling more than one HRV unit with a single humidity controller may prevent normal humidity operation and cause water leakage, etc.

### 10. 5 WIRING EXAMPLE

- This unit can be used as part of the combined operation system used together with indoor units (VRVII system air conditioners), or as a independent system for processing outside air.
- When connecting with a cooling free building multi type and bringing the RA (exhaust gas intake) of this unit directly in from the ceiling, connect to a BS unit identical to the building multi indoor unit (master unit), and use group-linked operation. (See the Engineering Data for details.)

**<Combined operation system with VRV system (connected with HRV units and standard indoor units in a single refrigerant circuit)>**

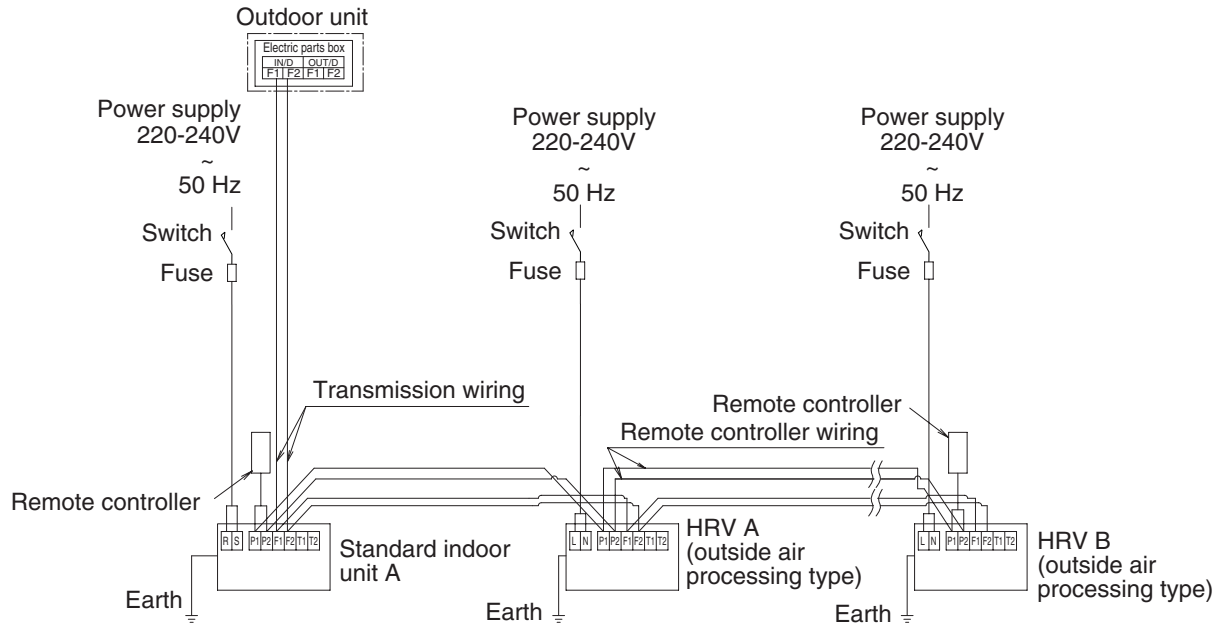

**<Independent system (connected only with a HRV unit in a single refrigerant circuit)>**

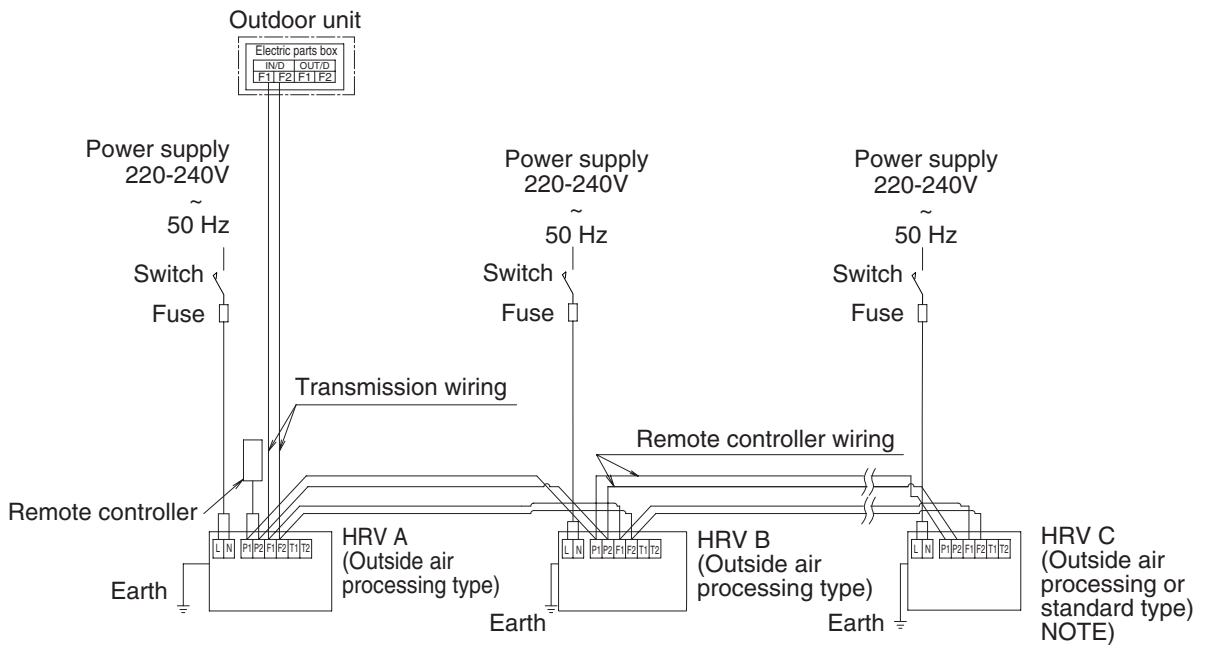

NOTE) Standard type ..... VAM series

**<When including a BS unit>**

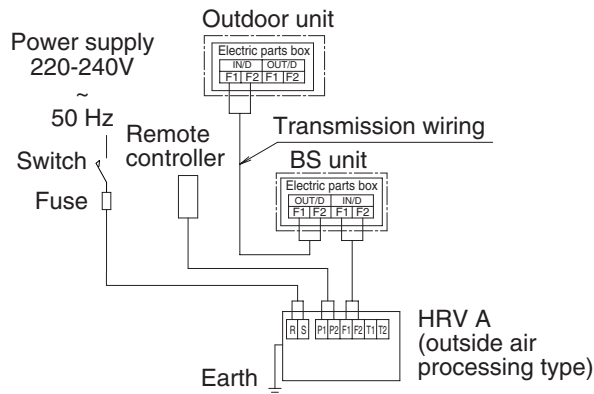

**[PRECAUTIONS]**

There is not need to set the indoor unit address when using group control. (It is automatically set when the power is turned on.) However, since the HRV (outside air processing type) uses two remote control addresses per unit, the number of units which can be group controlled is as follows.

No. of indoor air conditioner units	0	1	2	3	4	5	6	7	8	9	10	11	12	13	14
No. of HRV units	8	7	7	6	6	5	5	4	4	3	3	2	2	1	1

**10. 6 CONTROL BY 2 REMOTE CONTROLLERS  
(Controlling 1 indoor unit by 2 remote controllers)**

- When using 2 remote controllers, one must be set to "MAIN" and the other to "SUB".

**MAIN / SUB CHANGEOVER**

- Insert a screw driver into the recess between the upper and lower part of remote controller and, working from the 2 positions, pry off the upper part. (The remote controller PC board is attached to the upper part of remote controller.)

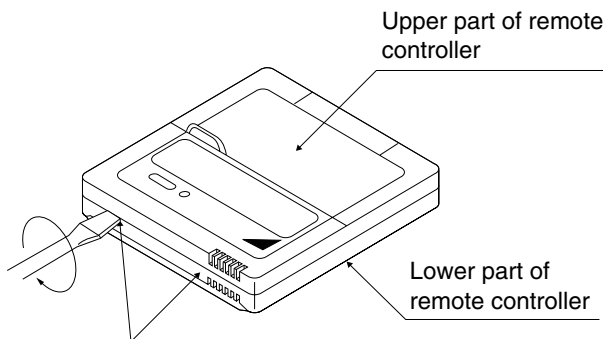

Insert the screwdriver here and gently work off the upper part of remote controller.

- Turn the MAIN/SUB changeover switch on one of the two remote controller PC boards to "S". (Leave the switch of the other remote controller set to "M".)

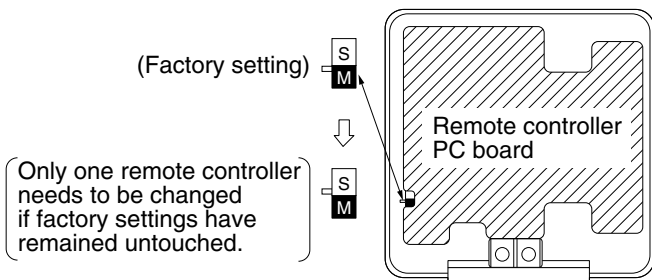

**<Wiring Method> (See "ELECTRIC WIRING WORK")**

- Remove the electric parts box lid.
- Add remote controller 2 (slave) to the terminal block for remote controller (P<sub>1</sub>, P<sub>2</sub>) in the electric parts box. (There is no polarity.)

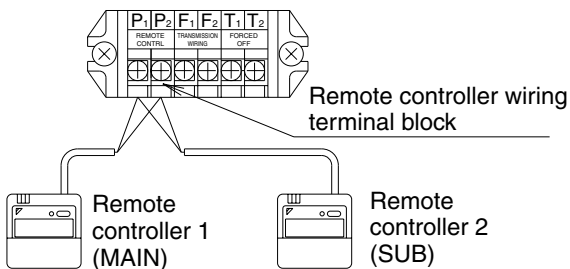

**[PRECAUTIONS]**

- Crossover wiring is needed when using group control and 2 remote controllers at the same time.
- Connect the indoor unit at the end of the crossover wire (P<sub>1</sub>, P<sub>2</sub>) to remote controller 2 (slave).

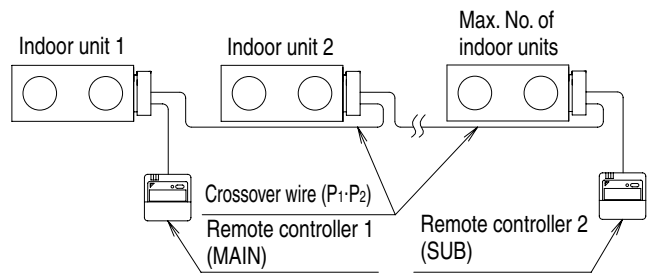

**10. 7 COMPUTERISED CONTROL  
(FORCED OFF AND ON/OFF OPERATION)**

- Wire specifications and how to perform wiring  
Connect the input from outside to terminals T1 and T2 of the terminal block for remote controller.

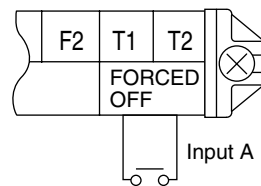

Wire specification	Sheathed wire (2 wire)
Gauge	0.75 - 1.25 mm <sup>2</sup>
Length	Max. 100 m
External terminal	Contact that can ensure the minimum applicable load of 15 V DC, 1 mA.

- Actuation  
The following table explains FORCED OFF and ON/OFF OPERATIONS in response to Input A.

FORCED OFF	ON/OFF OPERATION
Input "ON" stops operation (impossible by remote controllers.)	Input OFF → ON turns ON unit.
Input OFF enables control by remote controller.	Input ON → OFF turns OFF unit.

- How to select FORCED OFF and ON/OFF OPERATION  
Enter the FORCED OFF and ON/OFF OPERATION selection using the local "external start/stop input" settings based on "11 FIELD SETTING AND TEST RUN"

**10. 8 Central control**

If control is performed with a central device (central management controller, etc.), group number needs to be set with the remote controller. See the manual of each central device for detail.

**10. 9 FRESH-UP OPERATION BY EXTERNAL INPUT (HRV UNIT)**

**PURPOSES AND FUNCTIONS**

When the operation is interlocked with the local ventilating fan (such as the one for toilet or kitchen), the HRV unit performs the over-supply operation to prevent inflow of the odor from outside.

The flow rate of supply air becomes higher than that of exhaust air.

Both the excessive supply mode (Supply Fresh-up) and the excessive exhaust mode (Exhaust Fresh-up) are selectable. In details, contact your dealer.

## EXAMPLE OF CONTROL WIRING

Connecting line can be extended up to 50m maximum.

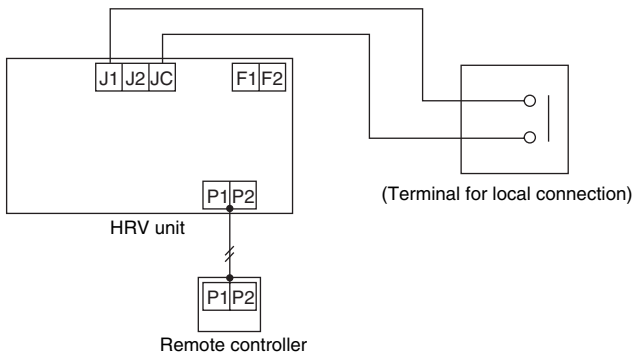

### Local wiring

Operation of HRV unit	Terminal for local connection	Capacity of connecting terminal
Fresh-up	Short-circuit	No-voltage normally open contact for micro-current
Normal	Open circuit	12V, 1mA

### Note:

The connecting wiring between HRV unit and the terminal for local connection can be extended up to 50m maximum.

## 11 FIELD SETTING AND TEST RUN

### 11.1 Perform field settings with the remote controller.

- (1) Make sure the electric parts box lids are closed on the indoor and outdoor units.
- (2) Depending on the type of installation, make the field settings from the remote controller after the power is turned on, following the "Field Settings" manual which came with the remote controller.

Lastly, make sure the customer keeps the "Field Settings" manual, along with the operating manual, in a safe place.

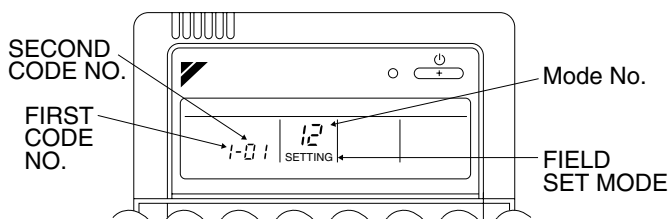

#### 11.1.1 Field setting

Using the remote controller of the VRV-system air conditioner to make HRV unit settings

##### <Initial setting>

- "Mode No." 17, 18 and 19: Group control of HRV units.
- "Mode No." 27, 28 and 29: individual control

##### <Operating procedure>

The following describes the operating procedure and settings.

- (1) Press the INSPECTION/TRIAL button for more than four seconds with the unit in the normal mode to enter the local setting mode.
- (2) Use the TEMPERATURE ADJUSTMENT button to select the desired "Mode No." (The code display will blink.)

- (3) To make settings for individual units under group control (when mode No. 27, 28 or 29 is selected), press the TIMER SETTING ON/OFF button to select the "unit No." for which the settings are to be made. (This process is not necessary when settings are made for the entire group.)
- (4) Press the top section of the TIMER button to select the "FIRST CODE NO."
- (5) Press the lower section of the TIMER button to select "SECOND CODE NO."
- (6) Press the PROGRAM/CANCEL button once to enter the settings. (The code display will stop blinking and light up.)
- (7) Press the INSPECTION/TRIAL button to return to normal mode.

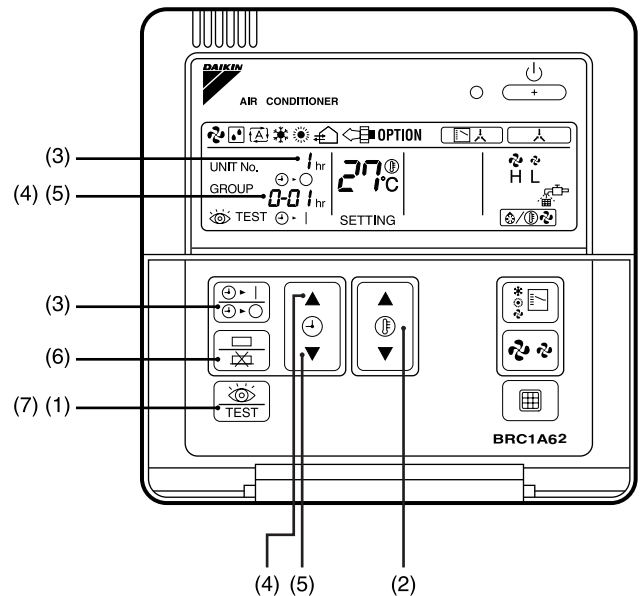
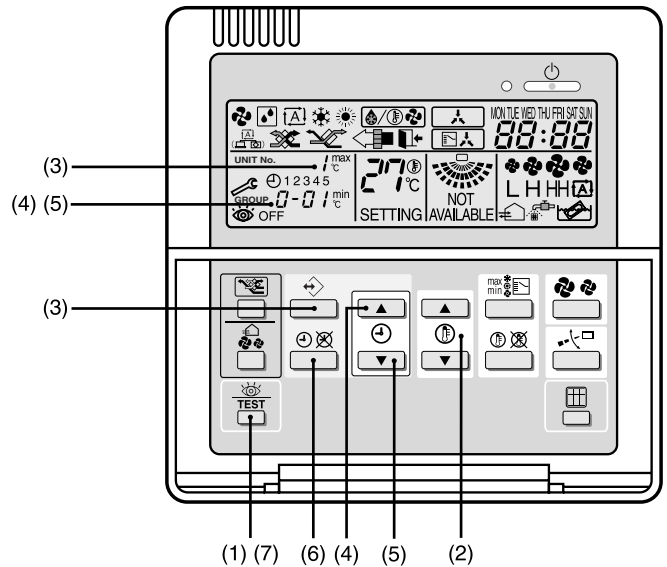

### <Example>

When adjusting the ventilation air flow to low setting in the group setting mode, enter the Mode No., "19" FIRST CODE NO., "0" and SECOND CODE NO., "01".

## ■Settings and setting numbers

Description of setting	Mode No. *1	FIRST CORD NO.	SECOND CORD NO.						
			01	02	03	04	05	06	07
Filter cleaning time setting (NOTE) 5	17 (27)	0	App- rox. 2500 hours	App- rox. 1250 hours	No coun- ting	—	—	—	—
Nighttime free cooling operation setting (Time after air conditioning is stopped.) (NOTE) 5		1	OFF	2 hours later	4 hours later	6 hours later	8 hours later	—	—
Fan speed initial setting		4	Normal	Ultra high	—	—	—	—	—
Direct duct connection with VRV setting		5	Not direct duct (Air flow set- ting)	With direct duct (fan off)	—	Not direct duct (Air flow set- ting)	—	With direct duct (fan off)	—
Setting for cold areas (Fan operation selection for heater thermo OFF) (NOTE) 6		5	Air flow set- ting	Air flow set- ting	—	Fan L	—	Fan L	—
Ventilation air flow setting when Nighttime free cooling setting	17 (27)	6	High	Ult- ra- High	—	—	—	—	
ON/OFF input from Outside (Set when ON/OFF is to be controlled from outside)	12 (22)	1	For- ced off	ON/ OFF con- trol	—	—	—	—	
Power failure automatic reset (Auto Restart)	12 (22)	5	No equ- ipp- ed	Equ- ipp- ed	—	—	—	—	
Humidification on/off when heating thermo is off	15 (25)	1	No	Yes	—	—	—	—	
Indication of ventilation mode/Not indication	18 (28)	4	Indi- cat- ion	No Indi- cat- ion	—	—	—	—	
Fresh up air supply/exhaust setting		7	No Indication	Indication		—	—	—	
			Supply	Exhaust	Supply	Exhaust	—	—	
External input terminal function selection (between J1 and JC) (NOTE) 7		8	Fresh- up	Overall alarm	—	—	—	Air flow incre- ase	
KRP50-2 output switching selection (between 1 and 3)		9	Fan on/off	Abnor- mal	—	—	—	—	
Ventilation air flow setting	19 (29)	0	Low	Low	Low	Low	High	High	
Ventilation mode setting		2	Auto- matic	Ex- change	By- pass	—	—	—	—
Fresh-up operation	1A		Off	On	—	—	—	—	
Forced fan on	43								
Unit no. allocation	45								

NOTE)

- The  inside the frame indicates the second code no. set when shipped from factory.
- The settings are applied to the entire group, but if the mode no. inside the parentheses is selected, the settings can be applied to individual indoor units.  
However, it is only possible to check any changes made to the settings inside the parentheses in individual mode. (For group batch operation, the changes are made but the display remains as it was when shipped from the factory.)
- Do not set anything not shown above. If the applicable functions are not available, they will not be displayed.
- When returning to normal mode, the remote controller is initialized, so the display might show "88."
- When "Filter cleaning time setting" or "Nighttime free cooling operation setting" is changed, explain set contents to the customer.
- See below for details on the settings for cold areas.  
— : operate at the set fan strength

	Air conditioner fan	01	02	04	06
Heating thermo off	Operation	—	—	L	L
Defrost	Stop	—	Stop	Stop	Stop
Oil return	Stop	—	Stop	Stop	Stop

In case of Independent operation

	Air conditioner fan	01	02	04	06
Heating thermo off	Operation	—	—	L	L
Defrost	Stop	—	—	Stop	Stop
Oil return	Stop	—	—	Stop	Stop

- : operate at the set fan strength  
L : operate at the weak fan strength  
S : Stop

Defrost operation

- In heating operation, freezing of the outdoor unit's coil increases.  
Heating capability decreases and the system goes into defrost operation.
- The remote controller will read "🌬️❄️" until the hot air starts blowing.
- It returns to the heating operation again after 6 to 8 minutes (10 at the longest).
- During defrost operation, the fans of the unit continues driving (factory setting).  
The purpose of this is to maintain the amount of ventilation and humidifying.
- The change of air discharge grill's location should be examined when the cold draft from air discharge grill is feared.
- Though the fan can be stopped by the setting of remote controller.  
Do not stop the fan in the place where no ventilation by stopping the fan may cause the influence of diffusion of air which it is dirty and moisture into another room, or the inflow from outside the room.  
(outflow such as viruses from the sickroom, or smell leakage from the rest room, etc.)

7. See below for details on the external input terminal function.

SECOND CODE NO.	Input contact	Fan operation	Operation lamp	
01	a	Operation	On	Fresh-up operation
02	a	Operation	On	Malfunction code "60" is displayed
06	a	Operation	On	Fan strength up (Low to High, High to Ultra-High)

\*SECOND CODE NO. "04" does not function when in air conditioner linked mode.



## 11. 2 Perform a test run according to the outdoor unit's installation manual.

- (1) Make sure the electric parts box of the unit is closed before turning on power.
- (2) Make a test run following the operation manual of the outdoor unit.
  - The operation lamp of the remote controller will flash when an malfunction occurs. Check the malfunction code on the liquid crystal display to identify the point of trouble. An explanation of malfunction codes and the corresponding trouble is provided in "CAUTION FOR SERVICING" of the outdoor unit.

If the display shows any of the following, there is a possibility that the wiring was done incorrectly or that the power is not on, so check again.

Remote controller display	Content
"E3" is display	<ul style="list-style-type: none"> <li>• There is a short circuit at the FORCED OFF terminals (T1, T2)</li> </ul>
"E4" is display	<ul style="list-style-type: none"> <li>• The test-run has not be performed.</li> </ul>
"E4" is display "E5" is display	<ul style="list-style-type: none"> <li>• The power on the outdoor unit is off.</li> <li>• The outdoor unit has not been wired for power supply.</li> <li>• Incorrect wiring for the transmission wiring and the wiring (the remote controller wiring or FORCED OFF wiring.)</li> <li>• The transmission wiring is cut.</li> </ul>
"E6" is display	<ul style="list-style-type: none"> <li>• "MAIN/SUB" setting of the remote controller is wrong.</li> </ul>
No display	<ul style="list-style-type: none"> <li>• The power on the indoor unit and HRV is off.</li> <li>• The indoor unit and HRV has not been wired for power supply.</li> <li>• Incorrect wiring for the remote controller wiring and the wiring (the transmission wiring or the FORCED OFF wiring.)</li> <li>• The remote controller wiring is cut.</li> </ul>

## 11. 3 Next, run the humidifier.

### <VKM-GMV1 series only>

- (1) Check that the water supply piping is connected securely.
- (2) Open the water supply shut-off valve. (No water will be supplied at this time.)
- (3) Run the HRV unit in heating mode.  
(See the operating manual included with the indoor unit for details on how to run the unit in heating mode.)  
The water supply will start and the humidifier will begin operation.
- (4) After starting heating (humidifying), the sound of the water supply solenoid valve will be heard every 3 or 4 minutes (a clicking sound), so listening for that clicking sound let the unit run for 30 minutes to make sure that humidifying operation is normal.



### CAUTION

- If carpentry work is not completed when a test run is finished, tell the customer not to run the humidifier for the protection of indoor unit and HRV until it is completed.
- If the humidifier is run, paint, particles generated from adhesive and other materials used for carpentry work may cause HRV to get dirty, causing splash or leakage of water.

**WIRING DIAGRAM**

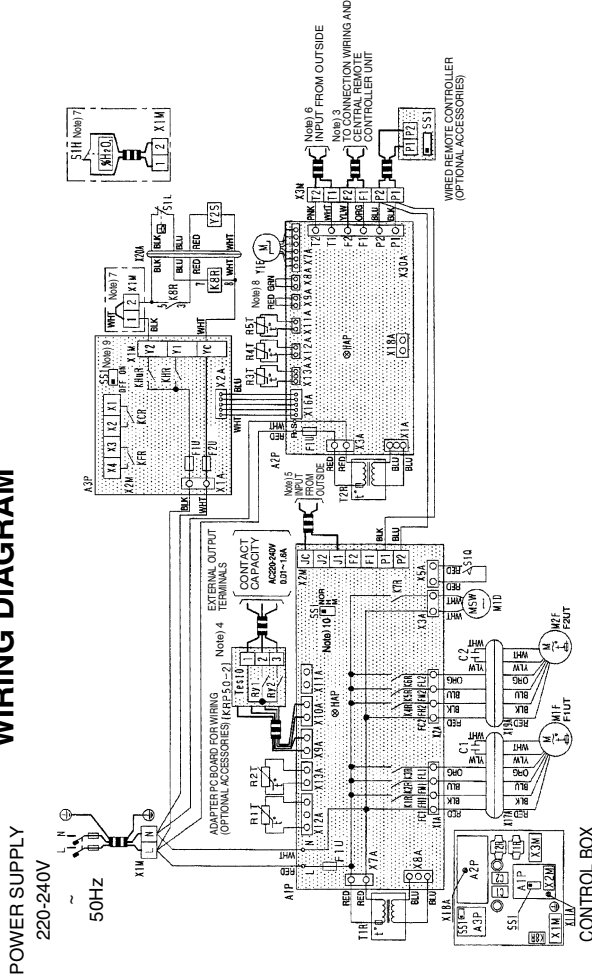

Notes

1. □ : TERMINAL BLOCK, ○ : TERMINAL, □, D : CONNECTOR, □ : SHORT CIRCUIT CONNECTOR
2. ■ : FIELD WIRING
3. IN CASE USING CENTRAL REMOTE CONTROLLER, CONNECT IT TO THE UNIT IN ACCORDANCE WITH THE ATTACHED INSTRUCTION MANUAL.
4. IN CASE USING WIRING ADAPTER, CONNECT IT TO THE UNIT IN ACCORDANCE WITH THE ATTACHED INSTALLATION MANUAL.
5. WHEN CONNECTING THE INPUT WIRES FROM OUTSIDE, FRESH UP CONTROL OPERATION CAN BE SELECTED BY REMOTE CONTROLLER, IN DETAILS, REFER TO THE INSTALLATION MANUAL ATTACHED THE UNIT.
6. WHEN CONNECTING THE INPUT WIRES FROM OUTSIDE, FORCED OFF OR ON/OFF CONTROL OPERATION CAN BE SELECTED BY REMOTE CONTROLLER, IN DETAILS, REFER TO THE INSTALLATION MANUAL ATTACHED THE UNIT.
7. IN CASE INSTALLING A HUMIDISTAT S1H (LOCALLY PROCURED), REMOVE THE SHORT CIRCUIT WIRING BETWEEN (1) AND (2) AS SHOWN IN THE FIGURE RIGHT.
8. DO NOT REMOVE THE SHORT CIRCUIT CONNECTORS OF X8A AND X9A, THE UNIT WILL NOT RUN IF THEY ARE REMOVED.
9. SS1 (A3P) HAS ALREADY BEEN SET TO OFF AT FACTORY SET. HUMIDIFYING BECOMES IMPOSSIBLE, IF THE SETTING ARE CHANGED.
10. SS1(A1P) HAS ALREADY BEEN SET TO "NOR." AT FACTORY SET. THE UNIT WILL NOT RUN IF THE SETTING ARE CHANGED.
11. SYMBOLS SHOW AS FOLLOWS. (PNK: PINK WHT: WHITE YLW: YELLOW ORG: ORANGE BLU: BLUE BLK: BLACK RED: RED GRN: GREEN)
12. USE COPPER CONDUCTORS ONLY.

A1P	PRINTED CIRCUIT BOARD	X1M	TERMINAL BLOCK (POWER SUPPLY)
A2P	PRINTED CIRCUIT BOARD	X1M/X2M	TERMINAL BLOCK (CONTROL)(A3P)
A3P	PRINTED CIRCUIT BOARD (ADAPTOR FOR WIRING)	X2M	TERMINAL BLOCK (CONTROL)(A1P)
C1-C2	CAPACITOR (M1F, M2F)	X3M	TERMINAL BLOCK (CONTROL)
F1U	FUSE (⊙, 10A, 250V)(A1P)	X17A/X18A	CONNECTOR (RELAYING WIRE)
F1U	FUSE (⊙, 5A, 250V)(A2P)	X20A	CONNECTOR (RELAYING WIRE)
F1U/F2U	FUSE (⊙, 5A, 250V)(A3P)	Y1E	ELECTRONIC EXPANSION VALVE
F1UT.	THERMO SWITCH (152°C)(M1F, M2F BUILT-IN)	Y2S	FEED WATER SOLENOID VALVE
F2UT	LIGHT EMITTING DIODE (SERVICE MONITOR-GREEN)(A1P)		OPTIONAL ACCESSORIES
HAP	LIGHT EMITTING DIODE (SERVICE MONITOR-GREEN)(A2P)	K7R	MAGNETIC RELAY (M1D)(A1P)
HAP	LIGHT EMITTING DIODE (SERVICE MONITOR-GREEN)(A3P)	K8R	MAGNETIC RELAY (S1L)
K7R-K8R	MAGNETIC RELAY (M1F)(A1P)	K8R, K8R	MAGNETIC RELAY (A3P)
K7R-K8R	MAGNETIC RELAY (M2F)(A1P)	R4R, K4R	MAGNETIC RELAY (A3P)
K7R	MAGNETIC RELAY (M1D)(A1P)	M1D	MOTOR (DAMPEN MOTOR)
K8R	MAGNETIC RELAY (S1L)	M1F	MOTOR (SUPPLY AIR FAN)
K8R, K8R	MAGNETIC RELAY (A3P)	M2F	MOTOR (EXHAUST AIR FAN)
R4R, K4R	MAGNETIC RELAY (A3P)	R1T	THERMISTOR (INDOOR AIR)
M1D	MOTOR (DAMPEN MOTOR)	R2T	THERMISTOR (OUTDOOR AIR)
M1F	MOTOR (SUPPLY AIR FAN)	R3T	THERMISTOR (INLET AIR INTO COIL)
M2F	MOTOR (EXHAUST AIR FAN)	R4T, R5T	THERMISTOR (LIQUID/GAS PIPE OF COIL)
R1T	THERMISTOR (INDOOR AIR)	S1L	FLOAT SWITCH (HUMIDIFIER)
R2T	THERMISTOR (OUTDOOR AIR)	S1Q	FLOAT SWITCH (HUMIDIFIER)
R3T	THERMISTOR (INLET AIR INTO COIL)	SS1	SELECTOR SWITCH (DAMPEN MOTOR)
R4T, R5T	THERMISTOR (LIQUID/GAS PIPE OF COIL)	SS1	SELECTOR SWITCH (FOR ESPECIALLY USE )(A1P)
S1L	FLOAT SWITCH (HUMIDIFIER)	SS1	SELECTOR SWITCH (HUMIDISTAT INPUT )(A3P)
S1Q	FLOAT SWITCH (HUMIDIFIER)	T1R	TRANSFORMER (220-240V/22V)
SS1	SELECTOR SWITCH (DAMPEN MOTOR)	T2R	TRANSFORMER (220-240V/22V)
SS1	SELECTOR SWITCH (FOR ESPECIALLY USE )(A1P)		
SS1	SELECTOR SWITCH (HUMIDISTAT INPUT )(A3P)		
T1R	TRANSFORMER (220-240V/22V)		
T2R	TRANSFORMER (220-240V/22V)		

3D047684-1 VKM50-80-100GMV1

# WIRING DIAGRAM

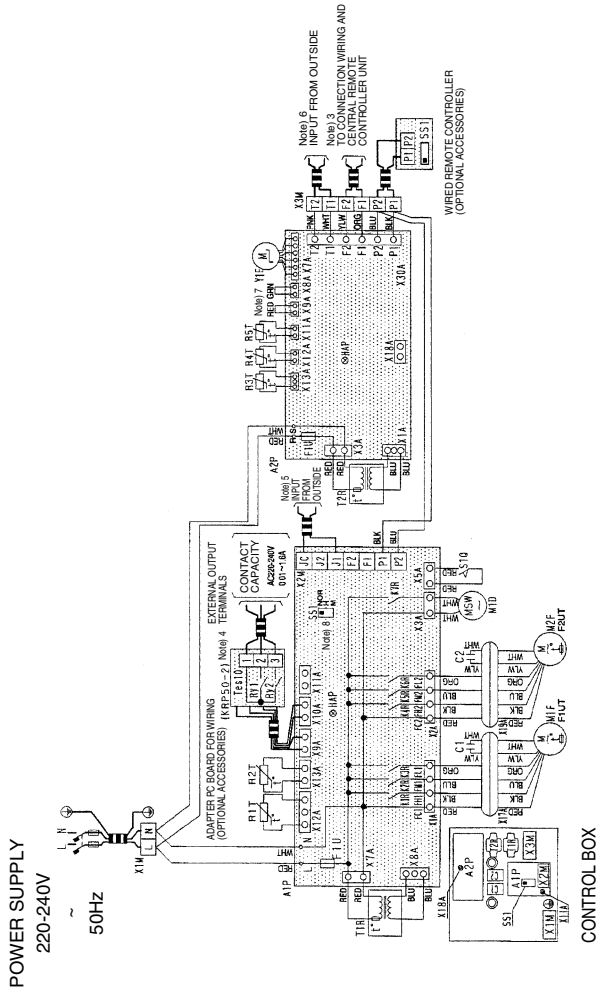

Notes)

1. [Symbol] : TERMINAL BLOCK, [Symbol] : TERMINAL, [Symbol] : CONNECTOR, [Symbol] : SHORT CIRCUIT CONNECTOR
2. [Symbol] : FIELD WIRING
3. IN CASE USING CENTRAL REMOTE CONTROLLER, CONNECT IT TO THE UNIT IN ACCORDANCE WITH THE ATTACHED INSTRUCTION MANUAL.
4. IN CASE USING WIRING ADAPTER, CONNECT IT TO THE UNIT IN ACCORDANCE WITH THE ATTACHED INSTALLATION MANUAL.
5. WHEN CONNECTING THE INPUT WIRES FROM OUTSIDE, FRESH UP CONTROL OPERATION CAN BE SELECTED BY REMOTE CONTROLLER, IN DETAILS, REFER TO THE INSTALLATION MANUAL ATTACHED THE UNIT.
6. WHEN CONNECTING THE INPUT WIRES FROM OUTSIDE, FORCED OFF OR ON/OFF CONTROL OPERATION CAN BE SELECTED BY REMOTE CONTROLLER, IN DETAILS, REFER TO THE INSTALLATION MANUAL ATTACHED THE UNIT.
7. DO NOT REMOVE THE SHORT CIRCUIT CONNECTORS OF X8A AND X9A, THE UNIT WILL NOT RUN IF THEY ARE REMOVED.
8. SS1(A1P) HAS ALREADY BEEN SET TO "NOR." AT FACTORY SET. THE UNIT WILL NOT RUN IF THE SETTING ARE CHANGED.
9. SYMBOLS SHOW AS FOLLOWS. (PNK: PINK WHT: WHITE YLW: YELLOW ORG: ORANGE BLU: BLUE BLK: BLACK RED: RED GRN: GREEN)
10. USE COPPER CONDUCTORS ONLY.

A1P	PRINTED CIRCUIT BOARD	X1M	TERMINAL BLOCK (POWER SUPPLY)
A2P	PRINTED CIRCUIT BOARD	X2M	TERMINAL BLOCK (CONTROL)(A1P)
C1-C2	CAPACITOR (M1F, M2F)	X3M	TERMINAL BLOCK (CONTROL)
F1U	FUSE ( Ⓟ , 10A, 250V)(A1P)	X17A, X18A	CONNECTOR (RELAYING WIRE)
F1U	FUSE ( Ⓟ , 5A, 250V)(A2P)	X20A	CONNECTOR (RELAYING WIRE)
F1UT	THERMO SWITCH	Y1E	ELECTRONIC EXPANSION VALVE
F2UT	(152°C)(M1F, M2F BUILT-IN)		
HAP	LIGHT EMITTING DIODE (SERVICE MONITOR-GREEN)(A1P)		
HAP	LIGHT EMITTING DIODE (SERVICE MONITOR-GREEN)(A2P)		
K1F-K3R	MAGNETIC RELAY (M1F)(A1P)		
K4F-K6R	MAGNETIC RELAY (M2F)(A1P)		
K7R	MAGNETIC RELAY (M1D)(A1P)		
M1D	MOTOR (DAMPER MOTOR)	SS1	SELECTOR SWITCH (MAIN/SUB)
M1F	MOTOR (SUPPLY AIR FAN)		
M2F	MOTOR (EXHAUST AIR FAN)		
R1T	THERMISTOR (INDOOR AIR)		
R2T	THERMISTOR (OUTDOOR AIR)		
R3T	THERMISTOR (INLET AIR INTO COIL)	Ry1	MAGNETIC RELAY (OPERATION/STOP)
R4T, R5T	THERMISTOR (LIQUID/GAS PIPE OF COIL)	Ry2	MAGNETIC RELAY (FOR HUMIDIFIER OPERATION)
S1Q	LIMIT SWITCH (DAMPER MOTOR)	Test10	TERMINAL BLOCK (FOR EXTERNAL OUTPUT)
SS1	SELECTOR SWITCH (FOR ESPECIALLY USE)(A1P)		
T1R	TRANSFORMER (220-240V/22V)	X11A	CONNECTOR (ADAPTER POWER SUPPLY)(A1P)
T2R	TRANSFORMER (220-240V/22V)	X18A	CONNECTOR (WIRING ADAPTER FOR ELECTRICAL APPENDICES)(A2P)

3D048372-1

VKM50-80-100GV1

