

Total Heat Exchanger Heat Reclaim Ventilator -with DX Coil-

MODELS
(Ceiling mounted duct type)

With DX coil & Humidifier With DX coil

VKM50GBMV1	VKM50GBV1
VKM80GBMV1	VKM80GBV1
VKM100GBMV1	VKM100GBV1

Heat Reclaim Ventilator

Heat Reclaim Ventilator

Please read this installation manual carefully and install the unit properly to keep it at full capacity for a long time.
Please provide some necessary parts, for example round hoods, air suction/discharge grilles etc., before the installation of the unit.

Wärmerückgewinnungslüftung

Lesen Sie dieses Installationshandbuch bitte sorgfältig durch, und installieren Sie die Einheit korrekt, so daß sie ihre Leistungsfähigkeit noch lange Zeit behält.
Einige erforderliche Teile wie z. B. Rundkappen, Luftansaug-/Lufausblasgitter müssen bereits vor der Installation der Einheit vorhanden sein.

Ventilateur Récupérateur de Chaleur

Veillez lire attentivement ce Manuel d'installation et installer correctement l'appareil de manière à ce qu'il puisse être utilisé pendant une longue période de temps sans aucun dérangement.
Veillez vous procurer certains éléments nécessaires, tels que des capuchons de formes arrondies, des grilles d'aspiration/évacuation d'air., avant l'installation de cette unité.

Ventilación con recuperación de calor

Por favor lea cuidadosamente el manual de instalacion e instale correctamente la unided para que pueda conservar su plena capacidad durante un largo periodo.
Por favor, antes de proceder a la instalacion de la unidad, proporcione las piezas necesarias, por ejemplo tapas redondas, rejillas de aspiracion y de impulsión de aire, etc.

Ventilatore a recupero di calore

Leggere attentamente questo mauale ed installare corretttamente l'unit in modo da farla funzionare a lungo al massimo delle sue capacita.
Prima dell'installazione, è opportuno disporuno delle partinec-essarie, come ganci arrotondati, griglie di aspirazione/di mandata, ecc.

Εξαιριστήρας με Ανάκτηση Θερμότητας

Διαβάστε προσεκτικά το παρόν εγχειρίδιο εγκατάστασης και εγκαταστήστε σωστά τη μονάδα για να διατηρήσετε την πλήρη απόδοσή της για πολύ καιρό.
Προμηθευτείτε μερικά απαραίτητα εξαρτήματα π.χ. κυκλικά καλύμματα, εσχάρες αναρρόφησης/κατάθλιψης κ.τ.λ. πριν εγκαταστήσετε τη μονάδα.

Hergebruik van Warmte

Lees eerst zorgvuldig deze installatiehandleiding en installeer de unit op de juiste manier, zodat deze gedurende lange tijd zijn volledige vermogen kan leveren.
Zorg dat alle componenten aanwezig zijn, zoals ronde kappen, luchtaan-en afvoerroosters etc. voordat u de unit gaat installeren.

Ventilação de Recuperação Térmica

Leia atentamente este manual e instale correctamente esta unidade para que esta funcione inteiramente durante um longo período de tempo.
Adquira algumas peças necessárias, por exemplo, tampas redondas, grelhas de aspiração/exaustão, etc., antes da instalação da unidade.

Вентилятор с рекуперацией тепла

Внимательно ознакомьтесь с данным руководством и установите блок надлежащим образом, чтобы он работал на полную мощность в течение долгого времени.
Перед установкой блока подготовьте необходимые детали, например колпак округлой формы, решетки всасывания/выпуска воздуха и т.п.

English

Deutsch

Français

Español

Italiano

Ελληνικά

Nederlands

Portugues

Русский

CONTENTS

1 SAFETY PRECAUTIONS	1
2 BEFORE INSTALLATION	2
3 SELECTING INSTALLATION SITE	3
4 PREPARATIONS BEFORE INSTALLATION	4
5 THE METHOD OF INSTALLATION	4
6 DRAIN PIPING AND WATER SUPPLY WORK.....	5
7 REFRIGERANT PIPING WORK.....	6
8 DUCT CONNECTION.....	8
9 ELECTRIC WIRING WORK.....	8
10 WIRING EXAMPLE AND HOW TO SET THE REMOTE CONTROLLER	9
11 FIELD SETTING AND TEST RUN.....	13

The original instructions are written in English. All other languages are translations of the original instructions.

1 SAFETY PRECAUTIONS

Be sure to follow this "SAFETY PRECAUTIONS". This product comes under the term "appliances not accessible to the general public". This manual classifies the precautions into WARNINGS and CAUTIONS. Be sure to follow all the precautions below: They are all important for ensuring safety.

WARNING.....Indicates a potentially hazardous situation which, if not avoided, could result in death or serious injury.

CAUTION.....Indicates a potentially hazardous situation which, if not avoided, may result in minor or moderate injury. It may also be used to alert against unsafe practices.

- After the installation is completed, test the Heat Reclaim Ventilator unit and check if the Heat Reclaim Ventilator unit operates properly. Give the user adequate instructions concerning the use and cleaning of the Heat Reclaim Ventilator unit according to the Operation Manual. Ask the user to keep this manual and the Operation Manual together in a handy place for future reference.

WARNING

- Ask your local dealer or qualified personnel to carry out installation work. Improper installation may result in water leakage, electric shocks or a fire.
- Installation should be done following the installation manual and no changes should be made to the unit.
Improper installation may result in water leakage, electric shocks or a fire. Injuries may result if the Heat Reclaim Ventilator unit falls.
- Install the Heat Reclaim Ventilator unit on a foundation that can withstand its mass.
Insufficient strength may result in the Heat Reclaim Ventilator unit falling down and causing injury. In addition, it may lead to vibration of indoor units and cause unpleasant chattering noise.
- Do not allow exhaust air to enter the outside air intake vent. This may cause the air of the room to become contaminated, harming the health.
- Locate the outside air intake vent so that it does not take in exhaust air which contains combustion air, etc.
Incorrect installation may cause a loss of oxygen in the room, leading to serious accidents.
- Make certain that all electrical work is carried out by qualified personnel according to the applicable legislation (note 1) and this installation manual, using a separate circuit.
In addition, even if the wiring is short, make sure to use a wiring that has sufficient length and never connect additional wiring to make the length sufficient. Insufficient capacity of

the power supply circuit or improper electrical construction may lead to electric shocks or a fire.

(note 1) applicable legislation means "All international, national and local directives, laws, regulations and/or codes which are relevant and applicable for a certain product or domain".

- Be sure to use only the specified parts and accessories for installation work. Failure to use the specified parts may result in the Heat Reclaim Ventilator unit falling down, water leakage, electric shocks, a fire, etc.
- Carry out the specified installation work in consideration of strong winds, typhoons, or earthquakes. Improper installation may result in an accident such as Heat Reclaim Ventilator unit falling.
- Make sure that all wiring is secure, using the specified wiring and ensuring that external forces do not act on the terminal connections or wiring. Incomplete connection or fixing may cause an overheat or a fire.
- When wiring remote controller wiring and transmission wiring, and wiring the power supply, form the wiring orderly so that the control box lid can be securely fastened. If the control box lid is not in place, overheat of the terminals, electric shocks or a fire may be caused.
- Consult your local dealer regarding what to do in case of refrigerant leakage.

When the Heat Reclaim Ventilator unit is installed in a small room, it is necessary to take proper measures so that the amount of any leaked refrigerant does not exceed the concentration limit in the event of a leakage. Otherwise, this may lead to an accident due to oxygen deficiency.

- If refrigerant gas leaks during installation work, ventilate the area immediately. Toxic gas may be produced if refrigerant gas comes into contact with a fire.
- After completing the installation work, check to make sure that there is no leakage of refrigerant gas. Toxic gas may be produced if refrigerant gas leaks into the room and comes into contact with a source of a fire, such as a fan heater, stove or cooker.
- Disconnect the power supply before touching the electric components. If you touch the live part, you may get an electric shocks.
- Never directly touch any accidental leaking refrigerant. This could result in severe wounds caused by frostbite.
- Earth the Heat Reclaim Ventilator unit.
Do not connect the earth wiring to gas or water piping, lightning conductor or telephone earth wiring. Incomplete earthing may cause electric shocks or a fire. A high surge current from lightning or other sources may cause damage to the air conditioner.
- Be sure to install an earth leakage circuit breaker.
Failure to do so may cause electric shocks and a fire.

CAUTION

- Install drain piping according to this installation manual to ensure good drainage, and insulate the piping to prevent condensation. Improper drain piping may cause water leakage, make the furniture get wet.
- Install the Heat Reclaim Ventilator unit, power supply wiring, remote controller wiring and transmission wiring at least 1 meter away from televisions or radios to prevent image interference or noise. (Depending on the radio waves, a distance of 1 meter may not be sufficient to eliminate the noise.)
- Install the two outdoor ducts with down slope to prevent rainwater from entering the unit. If this is not done completely, water may enter the building, may damage furniture, and cause electric shocks and fire.
- Insulate the two outdoor ducts and the supply air duct to prevent condensation. If this is not done completely, water may enter the building, may damage furniture, etc.
- Insulate the duct and the wall electrically when a metal duct is to be penetrated through the metal lattice and wire lattice or metal lining of a wooden structure wall. Improper duct work may cause electric shocks or fire.

- Do not install the Heat Reclaim Ventilator unit in places such as the following:
 - Place subjected to high temperature or direct flame. May result in a fire or overheating.
 - Where corrosive gas, such as sulfurous acid gas, is produced. This may cause a fire.
 - Place such as machinery plant and chemical plant where gas, which contains noxious gas or corrosive components of materials such as acid, alkali organic solvent and paint, is generated. Place where combustible gas leakage is likely. Copper piping and brazed joints may corrode, causing refrigerant to leak or poisoning and a fire due to leaked gas.
 - Locations below freezing point. Using the unit at temperatures below 0°C may cause the drain pan the supply and discharge piping, the humidifying element, the solenoid valves, and other parts to freeze, which can cause accidents.
 - Where there is machinery which emits electromagnetic waves. Electromagnetic waves may disturb the control system, and cause malfunction of the equipment.
 - Where flammable gases may leak, where carbon fibre or ignitable dust is suspended in the air or where volatile flammables, such as thinner or gasoline, are handled. If the gas should leak and remained around the Heat Reclaim Ventilator unit, it may cause ignition.
- Make sure the temperature and humidity near the unit and the air suction/discharge air grille is within limit dictated by the usage conditions.
 - Refrigerated truck or other locations with low temperatures.
 - Place such as bathroom or heated pools subjected to moisture. This may cause fires or electric leak or electric shocks.
- Make sure that a snow protection measure is taken. If no protection snow may enter through the outdoor ducts, and cause damaging furniture and electric shock and a fire.
- In areas where insects are easily attracted to a light, such as where there is a window or light near a ventilation opening, extremely small insects can sometimes infiltrate the room by passing through the ventilation opening. Since totally preventing against infiltration by extremely small insects is difficult, it is important to consider a serious solution like a filter box (field supply) during the design process to protect against insect infiltration.
- The Heat Reclaim Ventilator unit is not intended for use in a potentially explosive atmosphere.

2 BEFORE INSTALLATION

The accessories needed for installation must be retained in your custody until the installation work is completed. Do not discard them!

After carrying in the unit, protect it with packing materials to prevent it from scratching until installation work is done.

- Decide upon a line of transport.
- Leave the unit inside its packaging while moving, until reaching the installation site. Where unpacking is unavoidable, use a sling of soft material or protective plates together with a rope when lifting, to avoid damage or scratches to the unit.

Hold the unit by the hanger brackets (4) when opening the crate and moving it, and do not lift it holding on to any other part (especially the refrigerant piping, the drain piping, the water supply piping, and the duct connecting flange).

- Be sure to check the type of R410A refrigerant to be used before installing the unit. (Using an incorrect refrigerant will prevent normal operation of the unit.)
- For the installation of an outdoor unit, refer to the installation manual attached to the outdoor unit.



2.1 PRECAUTIONS



- Be sure to instruct customers how to properly operate the unit (especially maintenance of air filter, and operation procedure) by having them carry out operations themselves while looking at the manual.

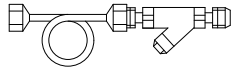

- Where the air contains high levels of salt such as that near the ocean and where voltage fluctuates greatly such as that in factories. Also in vehicles or vessels.

2.2 ACCESSORIES

Check the following accessories are included with your unit.

Name	Duct connecting flange	M4 tapping screw (For connecting duct)	Water supply piping with strainer
Quantity	4 pcs.	24 pcs.	VKM-GBMV1: 1 pc. VKM-GBV1: 0 pc.
Shape		 50 type M4x12 80, 100 type M4x16	

Name	Half-union joint (Copper piping joint)	Flare nut (Copper piping joint)	Refrigerant piping insulation cover
Quantity	VKM-GBMV1: 1 pc. VKM-GBV1: 0 pc.	VKM-GBMV1: 1 pc. VKM-GBV1: 0 pc.	1 set
Shape			 I.D.: φ35 I.D.: φ26

Name	Water supply piping insulation cover	Sealing material	Clamp	(Other)
Quantity	VKM-GBMV1: 1 pc. VKM-GBV1: 0 pc.	1 pc.	VKM-GBMV1: 10 pcs. VKM-GBV1: 8 pcs.	• Installation manual • Operation manual
Shape	 I.D.: φ15			

2.3 OPTIONAL ACCESSORIES

- This unit can be made a part of two different systems: as part of the combined operation system used together with VRV SYSTEM Air Conditioners, and as the independent system using only the Heat Reclaim Ventilator. An operating remote controller is required for this unit when using the unit as an independent system.

Table

Remote controller type	BRC1D527
------------------------	----------

NOTE) 1

If you use the remote controller except the above, please consult your local dealer.

NOTE) 2

We recommend the remote controller "BRC1D527" especially when the unit is used as independent system. Because it displays the ventilation mode and can be selected ventilation fan mode with the button.

- When installing the unit, have ready the round shape hood, the air discharge grille and the air suction grille, and other parts needed for the installation. Consult your local dealer when selecting optional accessories.

FOR THE FOLLOWING ITEMS, TAKE SPECIAL CARE DURING CONSTRUCTION AND CHECK AFTER INSTALLATION IS FINISHED.

a. Items to be checked after completion of work

Items to be checked	If not properly done, what is likely to occur	Check
Are the indoor and outdoor units fixed firmly?	The units may drop, vibrate or make noise.	
Is the outdoor duct installed to outside with down slope? (Refer to page 8 Fig. 16)	Condensate water may drip.	
Is the gas leak test finished?	It may result in insufficient cooling.	
Is the unit fully insulated?	Condensate water may drip.	
Does drainage flow smoothly?	Condensate water may drip.	
Does the power supply voltage correspond to that shown on the name plate?	The unit may malfunction or the components may burn out.	
Are wiring and piping correct?	The unit may malfunction or the components may burn out.	
Is the unit safely grounded?	Dangerous at electric leakage.	
Is wiring size according to specifications?	The unit may malfunction or the components may burn out.	
Is something blocking the air outlet or inlet of either the indoor or outdoor units?	It may result in insufficient cooling.	
Are refrigerant piping length and additional refrigerant charge noted down?	The refrigerant charge in the system is not clear.	
Is water supplied with the water supply piping connected?	Not humidified.	

Please check all items listed in the "SAFETY PRECAUTIONS" above once again.

b. Items to be checked at time of delivery

Items to be checked	Check
Did you explain about operations while showing the operation manual to your customer?	
Did you hand the operation manual and warranty over to your customer?	

c. Points for explanation about operations

The items with \triangle WARNING or \triangle CAUTION mark in the operation manual are the items pertaining to possibilities for bodily injury and material damage in addition to the general usage of the product. Accordingly, it is necessary that you make a full explanation about the described contents and also ask your customers to read the operation manual.

3 SELECTING INSTALLATION SITE

CAUTION

- When moving the unit during or after unpacking, make sure to lift it by holding its hanger brackets. Do not exert any pressure on other parts, especially the refrigerant piping, drain piping, water supply piping and duct connecting flange.
- If you think the humidity inside the ceiling might exceed 30°C and RH80%, reinforce the insulation on the inter-unit piping. Use glass wool or polyethylene foam as insulation so that it is no thicker than 10 mm and fits inside the ceiling opening.
- Use glass wool or polyethylene form of 10 mm or more thick which fit into ceiling opening as insulation material.

(1) Select an installation site where the following conditions are fulfilled and that meets with your customer's approval.

- Install in a place which has sufficient strength and stability. (Beams, ceiling, and other locations capable of fully supporting the weight of the unit.) Insufficient strength is dangerous. It may also cause vibration and unusual operating noise.
- Where piping between indoor and outdoor units is possible within the allowable limit. (Refer to the installation manual for the outdoor unit.)
- Where nothing blocks air passage.
- Where condensate can be properly drained.
- Install in a location where the air around the unit or taken into the humidifier will not drop below 0°C.
- Do not install the unit directly against a ceiling or wall. (If the unit is in contact with the ceiling or wall, it can cause vibration.)
- Where sufficient clearance for maintenance and service can be ensured. (Refer to Fig. 1)

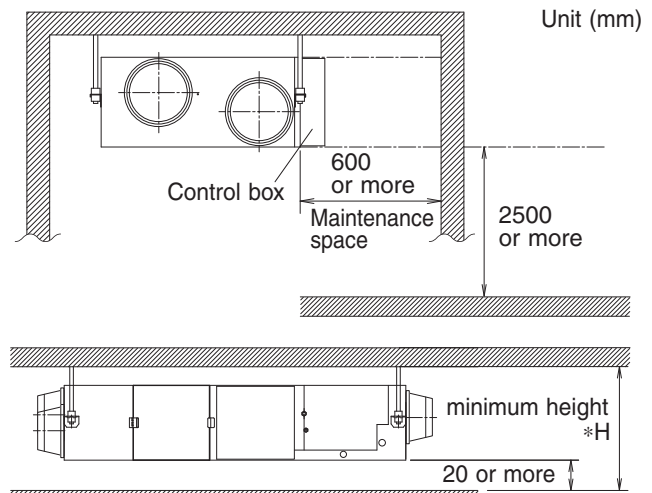

Fig. 1 Select the *H dimension such that a downward slope of at least 1/100 is ensured as indicated in "6 DRAIN PIPING AND WATER SUPPLY WORK".

[PRECAUTION]

- Install the indoor and outdoor units, power supply wiring and connecting wires at least 1 meter away from televisions or radios in order to prevent image interference or noise. Depending on the radio waves, a distance of 1 meter may not be sufficient enough to eliminate the electric noise.
- The bellows may not be able to be used in some districts, so exercise caution. (Contact your local government office or fire department for details.)
- When discharging exhaust air to a common duct, the Building Standard Law requires the use of fire-proof materials, so attach a 2 m copper plate standing duct or smoke back flow prevention damper.

- (2) Use suspension bolts for installation. Check whether the ceiling is strong enough to support the weight of the unit or not. If there is a risk, reinforce the ceiling before installing the unit.

(Installation pitch is mentioned as follow. Refer to it to check for points requiring reinforcing.)

4 PREPARATIONS BEFORE INSTALLATION

- (1) Confirm the positional relationship between the unit and suspension bolts. (Refer to Fig. 2)

Leave space for servicing the unit and include inspection hatches. (Always open a hole on the side of the control box so that the air filters, heat exchange elements, fans, and humidifier elements can easily be inspected and serviced.)

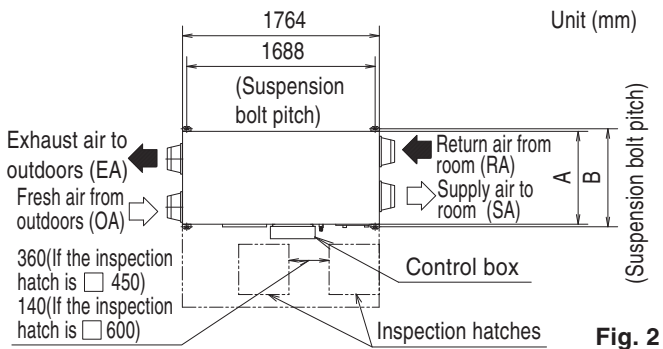

Fig. 2

(mm)

Model	A	B
VKM50GBMV1, VKM50GBV1	832	878
VKM80GBMV1, VKM80GBV1 VKM100GBMV1, VKM100GBV1	1214	1262

- (2) Make sure the range of the unit's external static pressure is not exceeded.

(See the fan-strength and static performance characteristic drawings as well as the general catalog for the range of the external static pressure setting.)

- (3) Open the installation hole. (Pre-set ceilings)

- Once the installation hole is opened in the ceiling where the unit is to be installed, pass refrigerant, drain piping, transmission wiring, and remote controller wiring to the unit's piping and wiring holes.

See "6 DRAIN PIPING AND SUPPLY WATER WORK", "7 REFRIGERANT PIPING WORK", and "10 WIRING EXAMPLE AND HOW TO SET THE REMOTE CONTROLLER".

- After opening the ceiling hole, make sure ceiling is level if needed. It might be necessary to reinforce the ceiling frame to prevent shaking.

Consult an architect or carpenter for details.

- (4) Install the suspension bolts.

(Use M10 to M12 suspension bolts.)

Use a hole-in-anchor, sunken insert, sunken anchor for existing ceilings, or other part to be procured in the field to reinforce the ceiling to bearing the weight of the unit.

(Refer to Fig. 3)

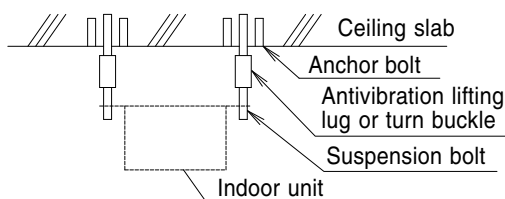

Note: All the above parts are locally procured.

Fig. 3

5 THE METHOD OF INSTALLATION

CAUTION

<<Hold underside of the unit or hanger bracket without putting force on other parts when unpacking or moving the unit.>>

<<As for the parts to be used for installation work, be sure to use the provided accessories and specified parts designated by our company.>>

- (1) Install the unit temporarily.

- Attach the hanger bracket to the suspension bolt. Be sure to fix it securely by using nuts (M10, M12) and washers (M10 with external dia. 30 to 34 mm, M12 with external dia. 36 to 38 mm) (locally procured) from the upper and lower sides of the hanger bracket. (Refer to Fig. 4)

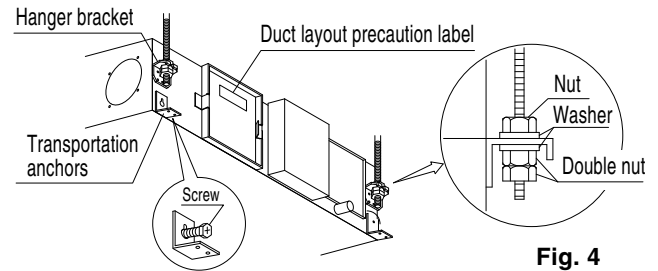

Fig. 4

- (2) If unnecessary, remove the four transportation anchors.

- Loosen the screws.
- Slide upward and remove the transportation anchors.
- Securely tighten the screws as before.

CAUTION

- The screws shouldn't be removed from the unit and should be tightened in order to prevent air from escaping.
- Check that foreign objects such as plastic or paper are not contained in the unit when installing.

- Install the unit after checking the indoor (SA/RA) and outdoor (EA/OA) in accordance with the figure duct layout precaution label.
- Do not turn the unit upside down.

- (3) Adjust the height of the unit. (Tighten the double nuts securely.)

(4) Check the unit is horizontally level.

CAUTION

Use a level to make sure that the unit is level and that the tilt (downward slope) to the drain piping connection is within 1°. (Refer to Fig. 5)

(One thing to watch out for in particular is if it is installed so that the slope is not in the direction of the drain piping, as this might cause leaking.)

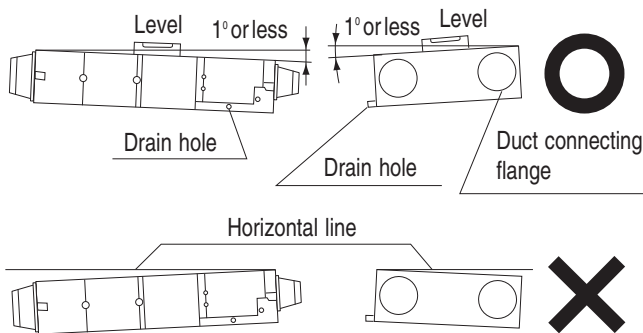

Fig. 5

(5) Tighten the upper nut.

(6) Attach the accessory duct connecting flanges using the included screws to the outlet and intake holes (a total of four).

When attaching, make sure the alignment markings on the unit match up with the triangle on the each duct connecting flange. (Refer to Fig. 6)

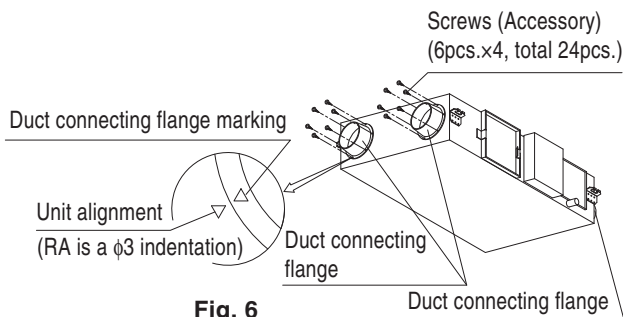

Fig. 6

6 DRAIN PIPING AND WATER SUPPLY WORK

(1) Install the drain piping.

- Make sure the drain works properly.
- In case of the direct duct connection system, there is negative pressure inside the unit relative to atmospheric pressure when the unit is running, so be sure to provide drain trap on the drain outlet. (Refer to Fig. 7-1)

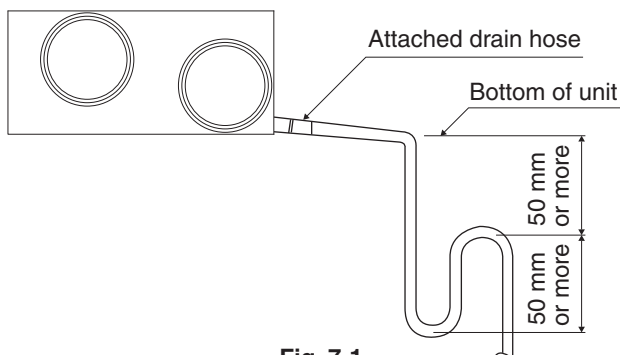

Fig. 7-1

CAUTION

Do not connect the drain piping directly to sewage pipes that smell of ammonia. The ammonia in the sewage might enter the indoor unit through the drain pipes and corrode the heat exchanger (Direct expansion coil).

- Keep the drain pipe short and sloping downwards at a gradient of at least 1/100 to prevent air pockets from forming. (Refer to Fig. 7-2)
- If converging multiple drain pipes, install according to the procedure shown below. (Install a drain trap for each indoor unit.)

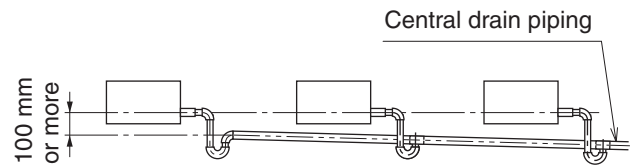

Fig. 7-2 (Install with a downward slope of at least 1/100)

CAUTION

Water accumulating in the drain piping can cause the drain to clog.

- The diameter of the drain pipe should be greater than or equal to the diameter of the connecting pipe. (pipe size: PT3/4B)
- When piping passes indoors, always insulate it all the way to the base of the drain socket.
- In areas where freezing may occur, always take steps to prevent the pipes from freezing.
- Make sure water doesn't leak from the drain pipes.
- Avoid bends and curves in the pipes to prevent them getting clogged.
- If you are using central drain piping, follow the procedure outlined in the figure 7-2.
- Select central drain pipes of proper size according to the capacity of the connected unit.
- Make sure the tip of the drain pipes opens out into a location where the drainage can be safely processed.

(2) After piping work is finished, check drainage flows smoothly.

- Test the drainage by pouring around 1000cc of water into the drain pan through the inspection hole by removing the maintenance cover (10 screws) or through the outlet duct joint of supply air to room (SA). (Refer to Fig. 8)

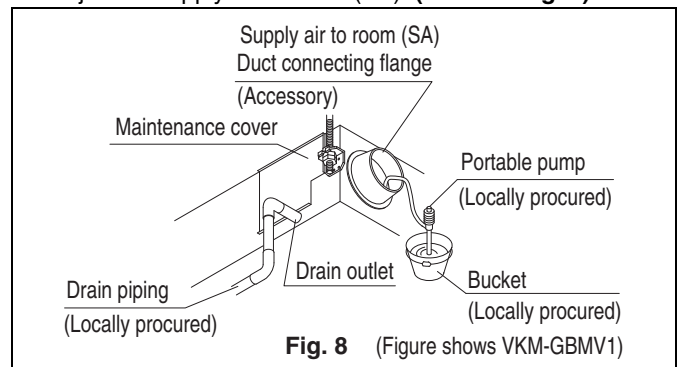

Fig. 8 (Figure shows VKM-GBMV1)

(3) Make sure that heat insulation work is executed on the following 2 spots to prevent any possibility water leakage due to dew condensation.

- Indoor drain piping
- Drain outlet

(4) Install the water supply piping. <VKM-GBMV1 series only>

⚠ CAUTION

When installing the water supply piping, wash the pipes with tap water so that all dirt is removed from them or install a drain valve somewhere along the piping and drain the pipes thoroughly until the water flowing through them is clear. Make sure no cutting oils or detergents get into the pipes.

- Connect the water supply piping with strainer (accessory), other pipings and valves (locally procured) to the indoor unit as shown in the figure at below.

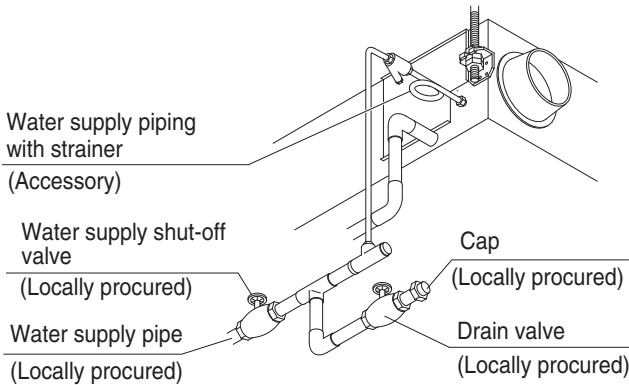

[PRECAUTION]

- When installing the water supply piping, do not pass piping in front of the maintenance cover, as this will make it impossible to remove the humidifier element.
- Include the water supply piping with strainer (included), a water supply shut-off valve, and a drain valve (both locally procured) somewhere along the water supply piping that can be reached from the inspection hole.
- It is impossible to connect the water supply piping directly to public piping. Use a cistern tank (of the approved type) if you need to get your water supply from public piping.
- When using copper piping for the water supply connections, replace the included half-union joints. (Refer to Fig. 9)

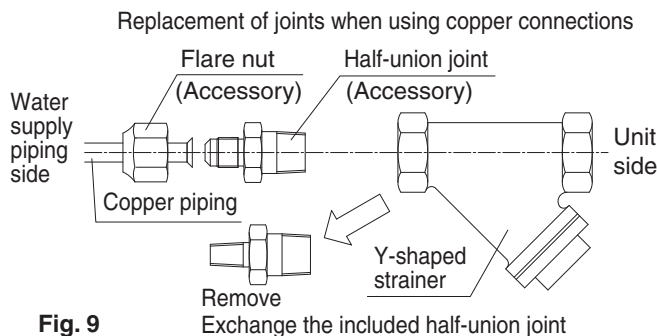

Fig. 9

- Use two spanners when attaching or removing pipes to the half-union joints.
- Secure the water supply piping without applying pressure.

[PRECAUTIONS]

- Use pure water (city water, tap water or equivalent) that satisfies the standard regulated by the law of each country for water supply to the humidifier when performing anti-sweat work.
- Dirty water may cause valves to clog, dirt to accumulate in water tanks, and resulting in poor humidifier performance. (Never use water from a cooling tower or warm water for heating.)
- Make sure the supply water is between 5°C and 40°C in temperature and 0.02 MPa to 0.49 MPa (0.2 kg/cm² to 5 kg/cm²) in pressure. Include a pressure release valve between the humidifier and the strainer if the water pressure will be higher than this range.
- Use city water or clean water and take steps to prevent condensation from forming.

- Also, if the supply water is hard water, use a water softener because of short life.
 - * Life of humidifying element is about 3 years (4,000 hours), under the supply water conditions of hardness: 150 mg/l. (Life of humidifying element is about 1 year (1,500 hours), under the supply water conditions of hardness: 400 mg/l.)
- Annual operating hours: 10 hours / day × 26 days / month × 5 month = 1,300 hours

(5) Insulate all piping that passes indoors.

After checking that the water supply piping connections do not leak, insulate them using the included insulation as shown in Fig. 10. (Tighten both edges with clamping material.) (Refer to Fig. 10)

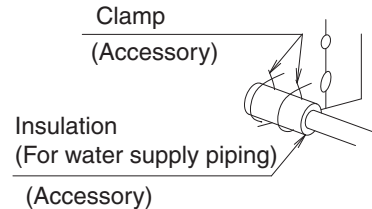

Fig. 10

- Wrap the water supply piping with insulation to prevent condensation from forming.
- In areas where freezing may occur, always take steps to prevent the pipes from freezing.

7 REFRIGERANT PIPING WORK

<For refrigerant piping of outdoor units, see the installation manual attached to the outdoor unit.>

<Execute heat insulation work completely on both sides of the gas piping and the liquid piping. Otherwise, a water leakage can result sometimes.>

Use insulation that can withstand temperatures of at least 120°C. Improve insulation of refrigerant piping according to the installation environment.

Refer to the following information as a guide.

- The ambient temperature is 30°C and humidity is 75% to 80%: 15 mm min. in thickness.
- The ambient temperature exceeds 30°C and the humidity exceeds 80%: 20 mm min. in thickness.

Without reinforcement, condensation may form on the surface of the insulation.>

<Before refrigerant piping work, check the type of R410A refrigerant is used. (Proper operation is not possible if the types of refrigerant are not the same.)>

⚠ CAUTION

This product must use a refrigerant (R410A). Obey the following items.

- Use a pipe cutter and flare suitable for the type of refrigerant (R410A).
 - Apply ester oil or ether oil around the flare portions before connecting.
 - Only use the flare nuts included with the unit. Using different flare nuts may cause the refrigerant to leak.
 - To prevent dust, moisture or other foreign matter from infiltrating the tube, either pinch the end or cover it with tape.
 - Do not allow anything other than the designated refrigerant to get mixed into the refrigerant circuit, such as air, etc. If any refrigerant gas leaks while working on the unit, ventilate the room thoroughly right away.
- The outdoor unit is charged with refrigerant.
 - Be sure to use both a spanner and torque wrench together, as shown in the drawing, when connecting or disconnecting pipes to the unit. (Refer to Fig. 11)
 - Refer to the "Table 1" for the dimensions of flare nut spaces.

Table 1

Pipe gauge	Tightening torque	Flare dimension A (mm)	Flare shape
φ 6.4	14.2–17.2 N·m	8.7 – 9.1	
φ12.7	49.5–60.3 N·m	16.2 – 16.6	

- When connecting the flare nut, coat the flare section (both inside and outside) with ester oil or ether oil, rotate three or four times first, then screw in. (Refer to Fig. 12)

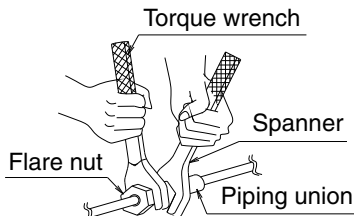

Fig. 11

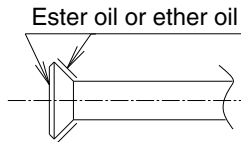

Fig. 12

- Refer to the “Table 1” for tightening torque.

CAUTION

Over-tightening may damage the flare and cause a refrigerant leakage.

- If a torque wrench is not available, tighten the nut in the following manner. Once work is complete, make sure there is no gas leaking. As the flare nut is tightened with the wrench, the torque will suddenly increase. From that position, tighten the nut to the angle shown on “Table 2”.

Table 2

Pipe size	Further tightening angle	Recommended arm length of tool
φ 6.4 (1/4")	60 to 90 degrees	Approx. 150 mm
φ 12.7 (1/2")	30 to 60 degrees	Approx. 250 mm

- After the work is finished, make sure to check that there is no gas leak.
- After checking the pipe-connection for gas leakage, be sure to insulate the liquid and gas piping. (Refer to Fig. 13)

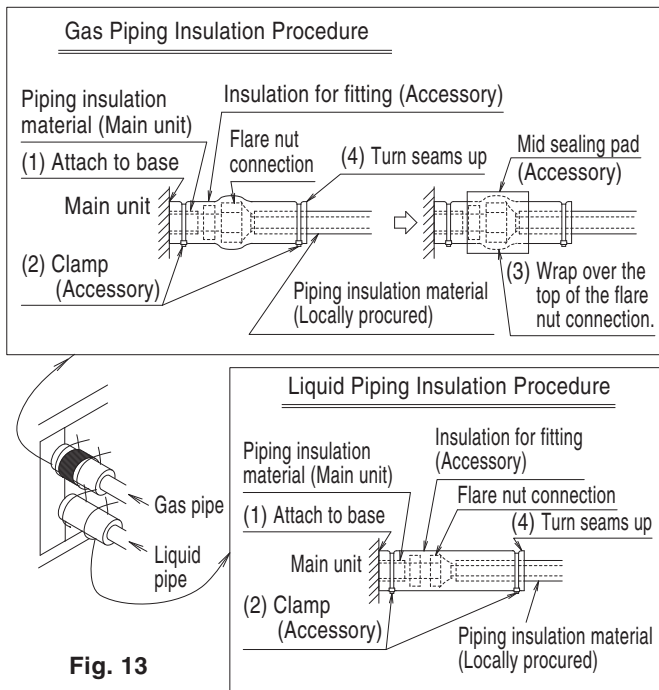
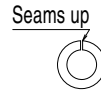

Fig. 13

Precautions for insulation material installation on flare nut connection

- Make sure that the piping insulation material comes in close contact with the base so that there will be no air passage at the edges of the piping insulation material.
- Do not tighten the clamp excessively so as to maintain the appropriate thickness of the insulator.
 - Wrap the sealing material around the upper part of the flare nut connection.
 - Turn the seams up (see the figure on the right-hand side).



CAUTION

Be sure to insulate any field piping all the way to the piping connection inside the unit. Any exposed piping may cause condensation or burns if touched.

- Connect refrigerant piping and branching according to the attached installation manuals that come with the outdoor unit.

Model	Gas piping diameter	Liquid piping diameter
VKM50GBMV1, VKM50GBV1 VKM80GBMV1, VKM80GBV1 VKM100GBMV1, VKM100GBV1	φ 12.7	φ 6.4

- When brazing the refrigerant piping, perform nitrogen replacement first, or perform the brazing (note 2) while feeding nitrogen into the refrigerant piping (note 1), and finally connect the indoor unit using the flare connections. (Refer to Fig. 14)

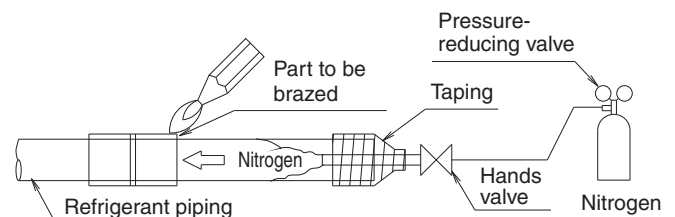

Fig. 14

CAUTION

- When brazing a pipe while feeding nitrogen inside the pipe, make sure to set the nitrogen pressure to 0.02 MPa (0.2 kg/cm²) or less using the pressure reducing valve. (This pressure is such that breeze is blown to your cheek.)
- Do not use a flux when brazing the refrigerant pipe joints. Use phosphor copper brazer (BCuP-2: JIS Z 3264/B-Cu93P-710/795: ISO 3677) which does not require flux. (Using a flux containing chlorine may cause the piping to corrode. Using a welding flux containing fluorine may cause the refrigerant lubricant to deteriorate, and affect adversely the refrigerant piping system.)
- Do not use anti-oxidants or other similar agent when brazing the pipe joints. Residue can clog the pipes and may cause breakdown of parts.

8 DUCT CONNECTION

<Perform duct work keeping the following things in mind.>

- Do not connect the ducts as shown in Fig. 15.

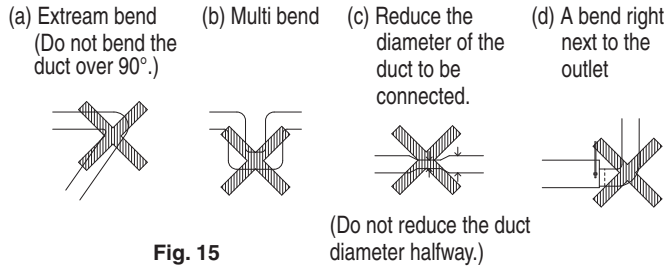

Fig. 15

- The minimal radius of bends for flexible ducts are as follows.
200-mm duct : 300 mm diameter
250-mm duct : 375 mm diameter
- To prevent air leakage, wind aluminum tape round the section after the duct connecting flange and the duct are connected. (Refer to Fig. 16)
- To prevent short circuit, install the opening of the indoor air intake as far as from the opening of the exhaust suction.
- Use the duct applicable to the model of unit used (Refer to the installation drawing.)
- Install the two outdoor ducts with down slope (slope of 1/30 or more) to prevent entry of rain water. Also, provide insulation for three ducts (Outdoor ducts and Indoor supply air duct) to prevent dew condensation. (Material : Glass wool of 25 mm thick) (Refer to Fig. 16)
- If the level of temperature and humidity inside the ceiling is always high, install a ventilation equipment inside the ceiling.
- Insulate the duct and the wall electrically when a metal duct is to be penetrated through the metal lattice and wire lattice or metal lining of a wooden structure wall.
- Using flexible or silent ducts can be effective in reducing the air discharge sound of the supply air to room (SA). Select materials keeping in mind the fan strength and operating sound of the unit. Consult your local dealer for selection.
- Set the pitch between the exhaust air outlet (EA) and the outside air intake (OA) to 3 times the duct diameter.
- Do not use a bent cap or a round hood as the outdoor hood if they might get rained on directly. (We recommend using a deep hood (optional accessory).)
- When using a deep hood, make sure the duct from the deep hood (outer wall) to the unit is at least 1 m long.

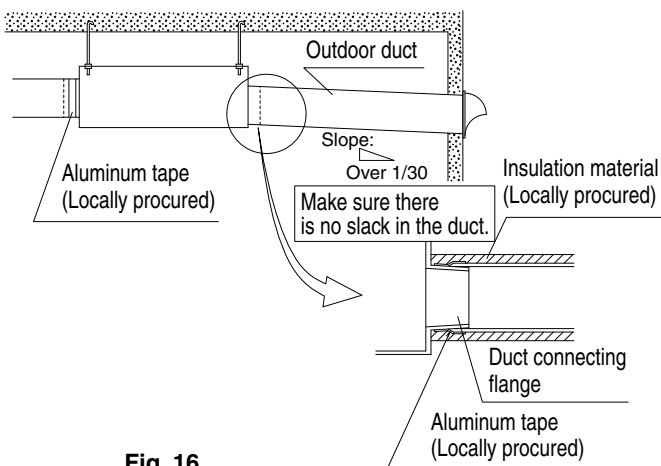

Fig. 16

- The change of air discharge grill's location should be examined when the cold draft from air discharge grill is feared. The fan is driving while defrost operation, and the cold air is often blowing.

- When connecting the indoor unit directly to the duct, always use the same system on the indoor unit as with the outdoor unit, perform group-linked operation, and make the direct duct connection settings from the remote controller (Mode No. "17 (27)" – FIRST CODE NO. "5" – SECOND CODE NO. "06") Also, do not connect to the outlet side of the indoor unit. Depending on the fan strength and static pressure, the unit might back up.
- In the case of suburban buildings where windows and road lighting equipment are close to the air supply opening and insects tends to swarm around the light, minute insects may intrude indoors through the air supply opening and air filter. In such cases, the use of a high-performance filter (sold separately) is recommended. However, it may be still difficult to prevent the intrusion of very minute insects. In that case, consider ultimate countermeasures, such as a filter box (arranged on site).

9 ELECTRIC WIRING WORK

- Shut off the power before doing any work.
- All field supplied parts and materials, electric works must conform to local codes.
- Use copper wire only.
- All wiring must be performed by an authorized electrician.
- See also the "Electrical Wiring Diagram label" attached to the control box lid when laying electrical wiring.
- Wire the outdoor unit and remote controller as shown in the electric wiring diagram label. See the "Remote Controller Installation Manual" for details on how to install and lay the wiring for the remote controller.
- This system consists of multiple indoor units. Mark each indoor unit as unit A, unit B..., and be sure the terminal board wiring to the outdoor unit and BS unit are properly matched. If wiring and piping between the outdoor unit and an indoor unit are mismatched, the system may cause a malfunction.
- Install a wiring interrupter or ground-fault circuit interrupter for the power wiring.
- Make sure the ground resistance is no greater than 100Ω . This value can be as high as 500Ω when using a ground fault circuit interrupter since the protective ground resistance can be applied.
- Do not let the ground wire should come in contact with gas pipes, water pipes, lighting rods, or telephone ground wires.
 - Gas pipes: gas leaks can cause explosions and fire.
 - Water pipes: cannot be grounded if hard vinyl pipes are used.
 - Telephone ground and lightning rods: the ground potential when struck by lightning gets extremely high.
- Do not turn on the power supply (switch, wiring interrupter or ground fault circuit interrupter) until all other works are done.

SPECIFICATIONS FOR FIELD SUPPLIED FUSES AND WIRE

Model	Power supply wiring and ground wiring			Remote controller wiring Transmission wiring	
	Field fuses 	Wire	Size	Wire	Size
VKM50GBMV1, VKM50GBV1	15 A	H05VV-U3G	Follow local standards	Sheathed wire (2 wire)	0.75-1.25 mm ²
VKM80GBMV1, VKM80GBV1					
VKM100GBMV1, VKM100GBV1					

NOTE

- If the wiring is in a place where people it can be easily touched by people, install a leak interrupter to prevent electric shock.
- When using a ground-fault circuit interrupter, make sure to select one useful also to protection against overcurrent and short-circuit.

If you use a leak interrupter which is designed for protecting again ground faults, be sure to combine it with a wiring interrupter or an load switch that has a fuse.

- The length of the transmission wiring and remote controller wiring are as follows.

Length of outdoor-indoor transmission wiring ... max 1000 m (total wiring length 2000 m)
Length of remote controller wiring between indoor unit and remote controller ... max 500 m

ELECTRICAL CHARACTERISTICS

Units				Power supply		Fan motor	
Model	Hz	Volts	Voltage range	MCA	MFA	kW	FLA
VKM50GBMV1, VKM50GBV1	50	220-240 V	Max. 264 V Min. 198 V	3.25	15	0.21x2	1.3x2
VKM80GBMV1, VKM80GBV1				3.25	15	0.21x2	1.3x2
VKM100GBMV1, VKM100GBV1				3.25	15	0.21x2	1.3x2

MCA: Min. Circuit Amps (A) MFA: Max. Fuse Amps (A)
 kW: Fan Motor Rated Output (kW) FLA: Full Load Amps (A)

10 WIRING EXAMPLE AND HOW TO SET THE REMOTE CONTROLLER

10.1 OPENING AND SHUTTING THE CONTROL BOX AND CONNECTING THE WIRING

CAUTION

Be sure to power off before opening the control box.

- Remove the control box lid and wire as shown in the figure below (Refer to Fig 17 and 18 for details).

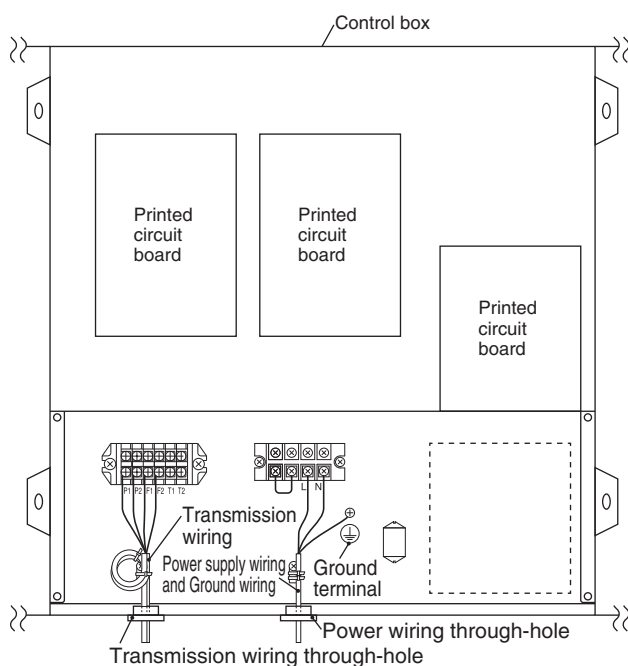

CAUTION

- See "Electrical Wiring Diagram label" on the backside of the lid of the control box for electric wiring work.
- Be sure to attach the sealing material or putty (locally procured) to hole of wiring to prevent the infiltration of water as well as any insects and other small creatures from outside. Otherwise a short-circuit may occur inside the control box.
- When clamping the wires, be sure no pressure is applied to the wire connections by using the included clamping material to make appropriate clamps. Also, when wiring, make sure the lid on the control box fits snugly by arranging the wires neatly and attaching the control box lid firmly. When attaching the control box lid, make sure no wires get caught in the edges. Pass wiring through the wiring through holes to prevent damage to them.
- Make sure the remote controller wiring, the wiring between the units, and other electrical wiring do not pass through the same locations outside of the unit, separating them by at least 50 mm, otherwise electrical noise (external static) could cause mistaken operation or breakage.

10.2 CONNECTING POWER SUPPLY WIRING AND GROUND WIRING

- Pass the power supply wiring and the ground wiring through the wiring through-hole into the control box and secure with the included clamping material after connecting the wires to terminal blocks. (Refer to Fig. 17)

Terminal block (X1M) details

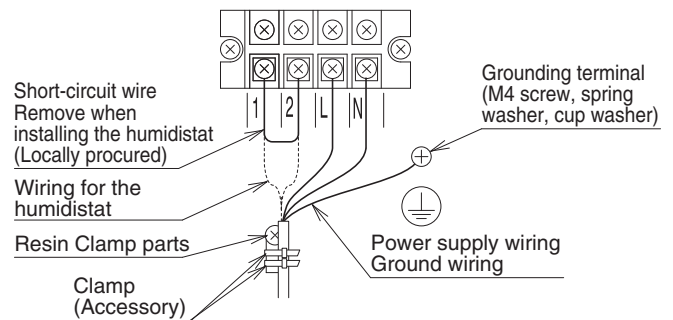

Fig. 17

<Precautions when laying power supply wiring>

[PRECAUTIONS]

- [1] A circuit breaker capable of shutting down power supply to the entire system must be installed.
- [2] A single switch can be used to supply power to units on the same system. However branch switches, branch overload circuit interrupter must be selected carefully.
- [3] Fit the power supply wiring of each unit with a switch and fuse as shown in the drawing.

COMPLETE SYSTEM EXAMPLE

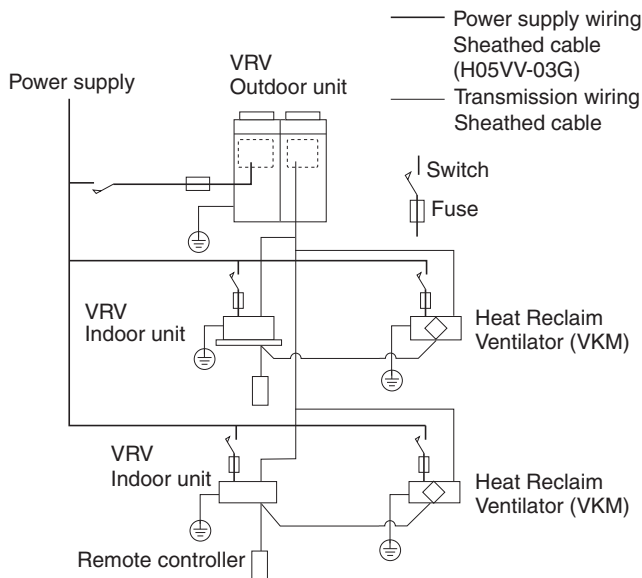

[4] Use round crimp-style terminals for connecting wires to the power supply terminal block.

If unavailable, observe the following points when wiring.

- Do not connect wires of different gauge to the same power supply terminal. (Looseness in the connection may cause overheating.)
- Use the specified electric wire. Connect the wire securely to the terminal. Lock the wire down without applying excessive force to the terminal. (Tightening torque: 131N·cm ±10%)

Attach insulation sleeve

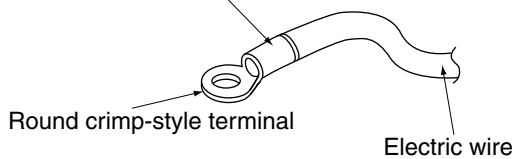

[5] Tightening torque for the terminal screws.

- Use the correct screwdriver for tightening the terminal screws. If the blade of screwdriver is too small, the head of the screw might be damaged, and the screw will not be properly tightened.
- If the terminal screws are tightened too hard, screws might be damaged.
- Refer to the table below for the tightening torque of the terminal screws.

	Tightening torque (N·m)
Terminal block for remote controller/ Transmission wiring (X3M)	0.88 ± 0.09
Power supply terminal block (X1M)	1.31 ± 0.13
Ground terminal	1.69 ± 0.25

<Precautions when connecting the ground>

When pulling the ground wire out, wire it so that it comes through the cut out section of the cup washer. (An improper ground connection may prevent a good ground from being achieved.)

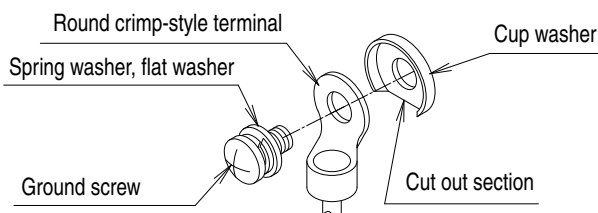

10. 3 REMOTE POWER SUPPLY WIRING, TRANSMISSION WIRING, COMPUTERISED CONTROL WIRE

- Pass the remote control wiring, the transmission wiring, and the computerised control wire into the control box through the through-hole and connect to the terminals on the X3M terminal block. After connection, secure with the included clamping material.

(Refer to Fig. 18)

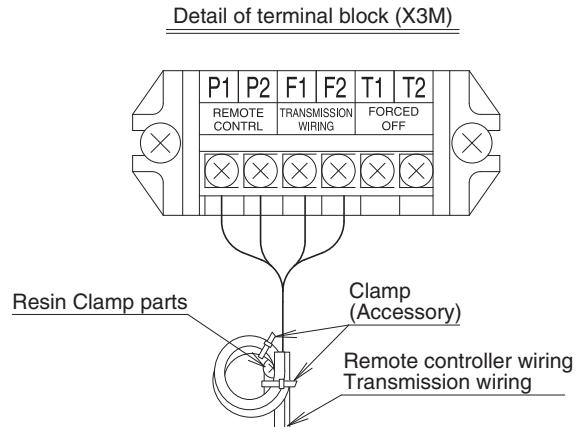

Fig. 18

[PRECAUTIONS]

- Refer to the “Remote Controller Installation Manual” on how to install and lay the wiring for the remote controller.
- Do not, under any circumstances, connect the power wiring to the remote controller or transmission wiring terminal block. Doing so can destroy the entire system.
- Connect the remote controller and transmission wiring their respective terminal blocks.

10. 4 WIRING FOR THE HUMIDITY REGULATOR (LOCALLY PROCURED)

<VKM-GBMV1 SERIES ONLY>

- Pass into the control box together with the power wire through the power wiring through-hole.
- Remove the short-circuit wires (1 and 2) on the X1M terminal block and connect the wiring for the humidity regulator.
- Secure with clamping material together with the power wire. (Refer to Fig. 17)

Wiring specifications	Sheathed wire (2 wire)
Size	0.75 - 1.25 mm ²
Length	MAX. 100 m
External contact specifications	Normally closed contact (Current tolerance 10 mA – 0.5 A)

<VKM-GBMV1 series only>

- If using humidistat, install one per Heat Reclaim Ventilator unit. Controlling more than one Heat Reclaim Ventilator unit with a single humidity controller may prevent normal humidity operation and cause water leakage, etc.

10. 5 WIRING EXAMPLE

- This unit can be used as part of the combined operation system used together with indoor units (VRV system air conditioners), or as a independent system for processing outside air.
- When connecting with a cooling free building multi type and bringing the RA of this unit directly in from the ceiling, connect to a BS unit identical to the building multi indoor unit (master unit), and use group-linked operation. (See the Engineering Data for details.)

<Combined operation system with VRV system (connected with Heat Reclaim Ventilator units and standard indoor units in a single refrigerant circuit)>

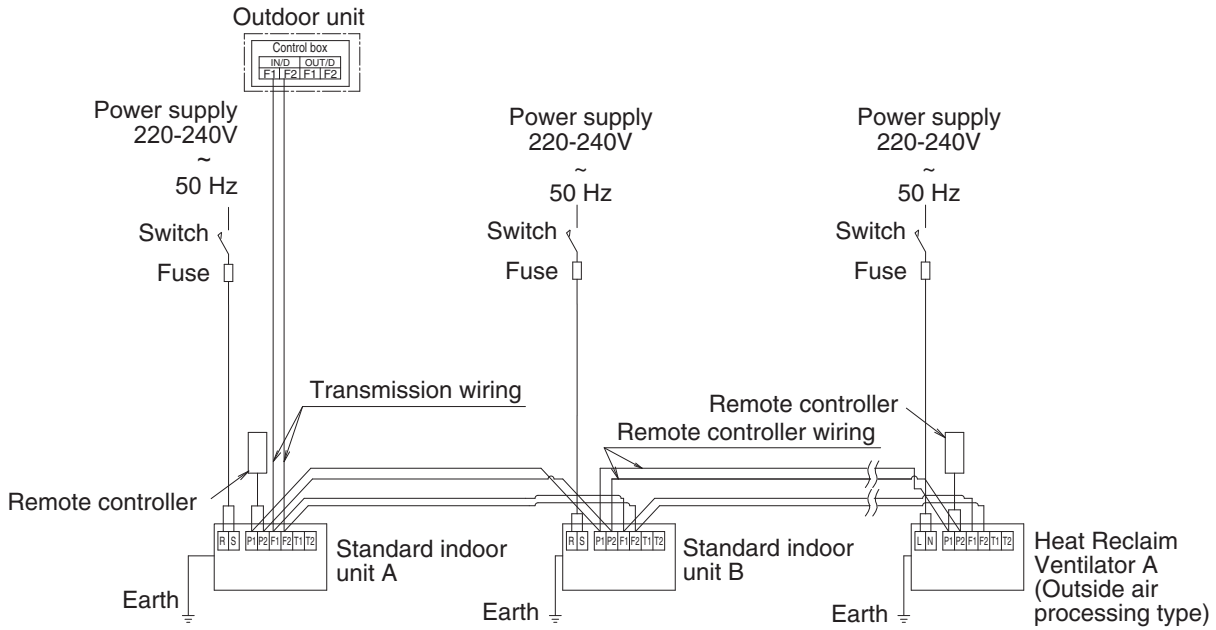

<Independent system (connected only with a Heat Reclaim Ventilator unit in a single refrigerant circuit)>

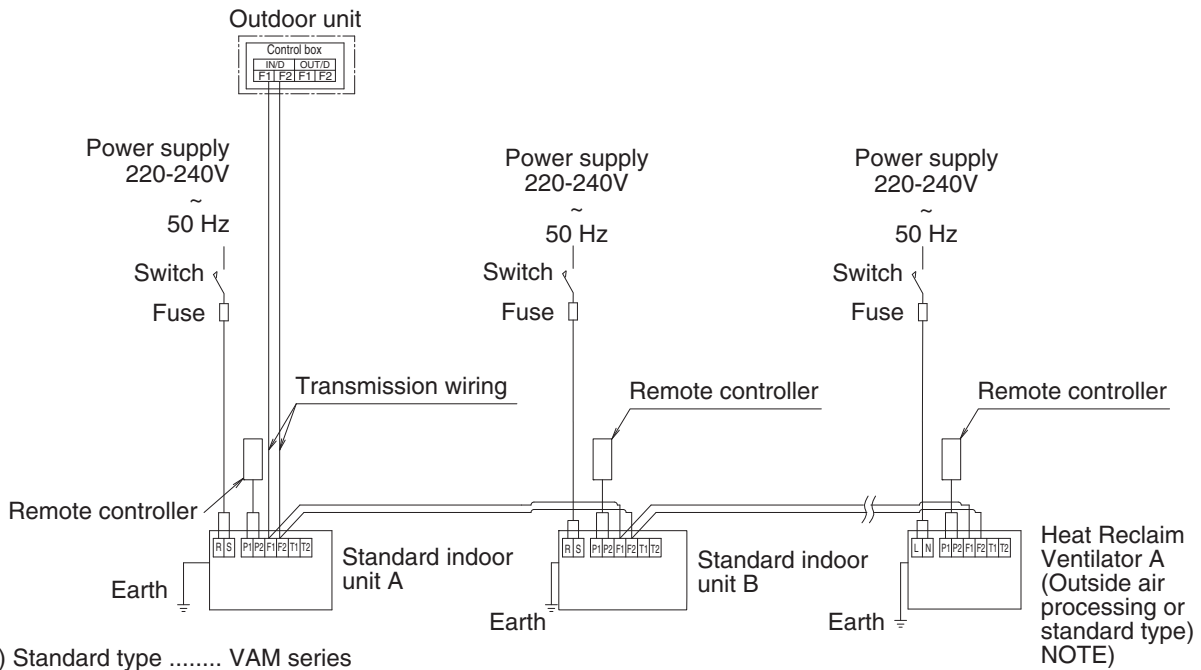

<When including a BS unit>

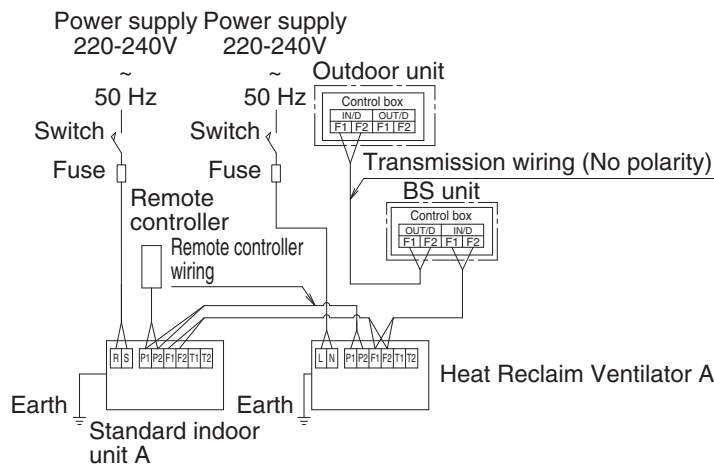

[PRECAUTIONS]

There is not need to set the indoor unit address when using group control. (It is automatically set when the power is turned on.) However, since the Heat Reclaim Ventilator (outside air processing type) uses two remote control addresses per unit, the number of units which can be group controlled is as follows.

No. of indoor air conditioner units	0	1	2	3	4	5	6	7	8	9	10	11	12	13	14
No. of Heat Reclaim Ventilator units	8	7	7	6	6	5	5	4	4	3	3	2	2	1	1

Note:

If a simultaneous cooling system is used, a single BS unit should connect to Heat Reclaim Ventilator (outdoor air-processing type) and indoor units under group control. If a single BS unit connects to the Heat Reclaim Ventilator unit only, fix the operating mode of the Heat Reclaim Ventilator unit to cooling, heating, or ventilation.

10. 6 CONTROL BY 2 REMOTE CONTROLLERS (CONTROLLING 1 INDOOR UNIT BY 2 REMOTE CONTROLLERS)

- When using 2 remote controllers, one must be set to "MAIN" and the other to "SUB".

MAIN / SUB CHANGEOVER

- Insert a flat blade screw driver into the recess between the upper and lower part of remote controller and, working from the 2 positions, pry off the upper part. (The remote controller Printed Circuit board is attached to the upper part of remote controller.)

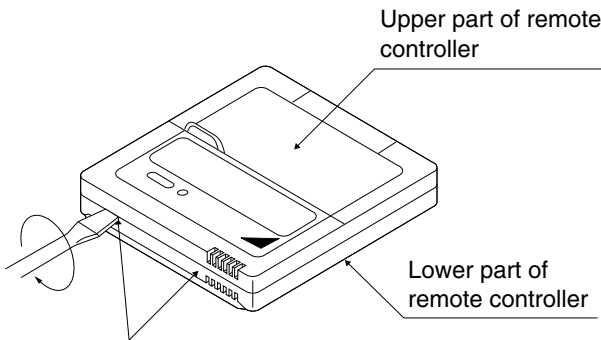

Insert the screwdriver here and gently work off the upper part of remote controller.

- Turn the MAIN/SUB changeover switch on one of the two remote controller Printed Circuit boards to "S". (Leave the switch of the other remote controller set to "M".)

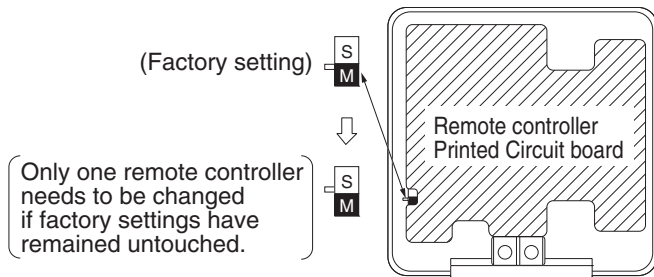

<Wiring Method> (See "9 ELECTRIC WIRING WORK".)

- Remove the control box lid.

- Add remote controller 2 (SUB) to the terminal block for remote controller (P₁, P₂) in the control box. (There is no polarity.)

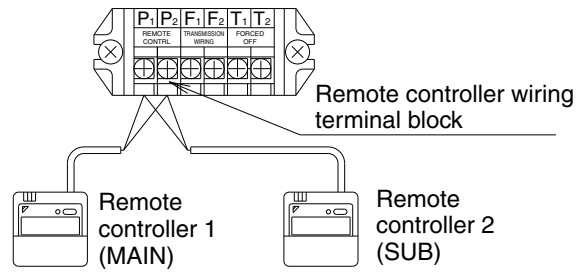

[PRECAUTIONS]

- Crossover wiring is needed when using group control and 2 remote controllers at the same time.
- Connect the indoor unit at the end of the crossover wire (P₁, P₂) to remote controller 2 (SUB).

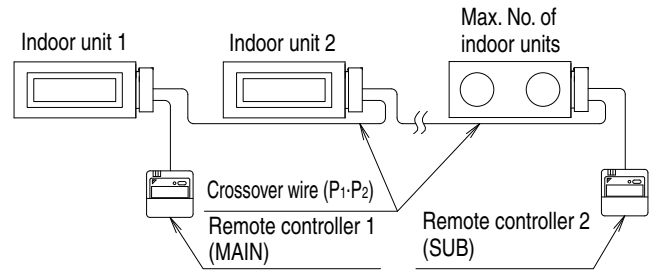

10. 7 EXTERNAL REMOTE CONTROL (FORCED OFF AND ON/OFF OPERATION)

- Wire specifications and how to perform wiring
Connect the input from outside to terminals T1 and T2 of the terminal block for remote controller.

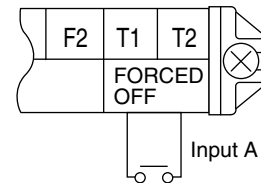

- * The equipment in Nighttime free cooling operation cannot be stopped forcibly with T1 or T2.

Wire specification	Sheathed wire (2-wire)
Gauge	0.75 - 1.25 mm ²
Length	Max. 100 m
External terminal	Contact that can ensure the minimum applicable load of 15V DC, 1mA.

- Actuation
The following table explains FORCED OFF and ON/OFF OPERATIONS in response to Input A.

FORCED OFF	ON/OFF OPERATION
Input ON stops operation (impossible by remote controllers.)	Input OFF → ON turns ON unit.
Input OFF enables control by remote controller.	Input ON → OFF turns OFF unit.

- How to select FORCED OFF and ON/OFF OPERATION
Enter the FORCED OFF and ON/OFF OPERATION selection using the local "External ON/OFF input" settings based on "11 FIELD SETTING AND TEST RUN".

10. 8 CENTRAL CONTROL

If control is performed with a central device (central management controller, etc.), group number needs to be set with the remote controller. See the manual of each central device for detail.

11 FIELD SETTING AND TEST RUN

11.1 PERFORM FIELD SETTINGS WITH THE REMOTE CONTROLLER

- (1) Make sure the control box lids are closed on the indoor and outdoor units.
- (2) Depending on the type of installation, make the field settings from the remote controller after the power is turned on, following the "Field Settings" manual which came with the remote controller.

Lastly, make sure the customer keeps the "Field Settings" manual, along with the operating manual, in a safe place.

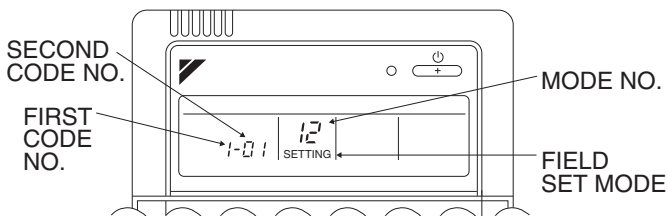

11.1.1 FIELD SETTING

Using the remote controller of the VRV-system air conditioner to make Heat Reclaim Ventilator unit settings

<Initial setting>

- "MODE NO." 17, 18 and 19: Group control of Heat Reclaim Ventilator units.
- "MODE NO." 27, 28 and 29: individual control

<Operating procedure>

The following describes the operating procedure and settings.

- (1) Press the INSPECTION/TRIAL button for more than four seconds with the unit in the normal mode to enter the local setting mode.
- (2) Use the TEMPERATURE ADJUSTMENT button to select the desired "MODE NO.". (The code display will blink.)
- (3) To make settings for individual units under group control (when mode No. 27, 28 or 29 is selected), press the TIMER SETTING ON/OFF button to select the "unit No." for which the settings are to be made. (This process is not necessary when settings are made for the entire group.)
- (4) Press the top section of the TIMER button to select the "FIRST CODE NO.".
- (5) Press the lower section of the TIMER button to select "SECOND CODE NO.".
- (6) Press the PROGRAM/CANCEL button once to enter the settings. (The code display will stop blinking and light up.)
- (7) Press the INSPECTION/TRIAL button to return to normal mode.

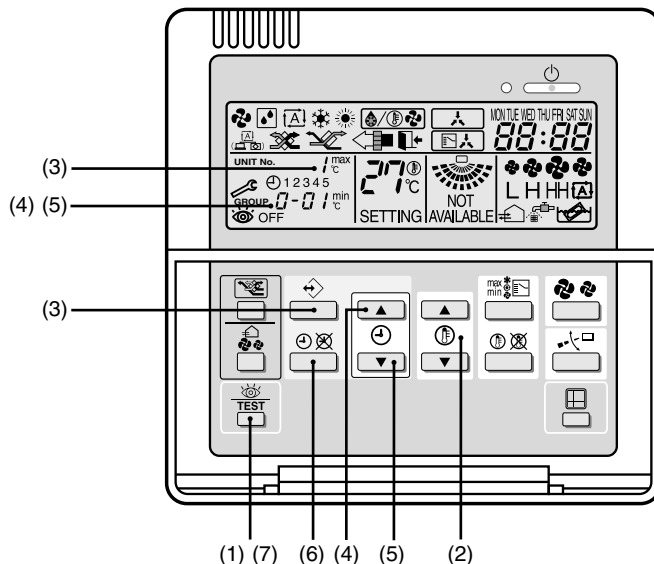

<Example>

When adjusting the ventilation air flow to low setting in the group setting mode, enter the Mode No., "19" FIRST CODE NO., "0" and SECOND CODE NO., "01".

■ SETTINGS AND SETTING NUMBERS

Description of setting	MODE NO.	FIRST CODE NO.	SECOND CODE NO.														
			01	02	03	04	05	06	07	08	09	10	11	12	13	14	15
External ON/OFF input	12	1	Forced OFF	ON/OFF operation													
Interval time for filter sign indication	17 (27)	0	Approx. 2500 hours	Approx. 1250 hours	No counting												
Nighttime free cooling operation ON/OFF and starting time		1	OFF	ON 2 hours later	ON 4 hours later	ON 6 hours later	ON 8 hours later										
Initial setting for ventilation fan		4	Normal	Ultra High	Normal	Ultra High											
Direct duct connection with VRV		5	Without duct (Setup air flow rate)	Direct duct (Fan off)	–	Without duct (Setup air flow rate)	–	Direct duct (Fan off)		Without duct (Fan off)							
Cold areas (Fan operation selection for heating thermo off)			–	–	–	Thermo OFF: L Defrost: OFF	–	Thermo OFF: L Defrost: OFF		Thermo OFF: – Defrost: OFF							
Fan for nighttime free cooling operation		6	High	Ultra High													
Display for ventilation mode	18 (28)	4	Show	Hide													
Supply Fresh-up/ Exhaust Fresh-up		7	Supply	Exhaust	Supply	Exhaust											
Low tap setting	19 (29)	1	No	–	–	–	–	–	–	Continuous running						Normal	
Fan step for supply (Air flow rate adjustment)		2	Less 01	←							Normal 08						Greater 15
Fan step for exhaust (Air flow rate adjustment)		3	Less 01	←							Normal 08						Greater 15
24-hours ventilation setting		4	No	–	–	–	–	–	–	Continuous running						Normal	
Fan residual operation when heater connected		8	Disable	Disable	Enable	Enable											
Fresh-up ON/OFF		1A	0	OFF	ON												

: Factory default setting

NOTE)

1. SECOND CODE NO. which are enclosed by bold lines are the factory settings.
 2. The settings are applied to the entire group, but if the mode no. inside the parentheses is selected, the settings can be applied to individual indoor units. However, it is only possible to check any changes made to the settings inside the parentheses in individual mode. (For group batch operation, the changes are made but the display remains as a factory setting.)
 3. Do not set anything not shown on the list. If the applicable functions are not available, they will not be displayed.
 4. When returning to normal mode, the remote controller is initialized, so the display might show "88."
 5. When "Filter sign indication setting" or "Nighttime free cooling operation setting" is changed, explain set contents to the customer.
 6. See below for details on the settings for cold areas.
- : operate at the set fan strength

	Air conditioner fan	01	02	04	06	08
Heating thermo off	Operation	–	–	Low	Low	–
Defrost	Stop	–	Stop	Stop	Stop	Stop
Oil return	Stop	–	Stop	Stop	Stop	Stop

In case of Independent operation

	Air conditioner fan	01	02	04	06	08
Heating thermo off	Operation	–	–	Low	Low	–
Defrost	Stop	–	–	Stop	Stop	Stop
Oil return	Stop	–	–	Stop	Stop	Stop

– : operate at the set fan strength

Low : operate at the weak fan strength

Defrost operation

- In heating operation, freezing of the outdoor unit's coil increases. Heating capability decreases and the system goes into defrost operation.
- The remote controller will read “ ” until the hot air starts blowing.
- It returns to the heating operation again after 6 to 8 minutes (10 at the longest).
- During defrost operation, the fans of the unit continues driving (factory setting). The purpose of this is to maintain the amount of ventilation and humidifying.
- The change of air discharge grill's location should be examined when the cold draft from air discharge grill is feared.
- Though the fan can be stopped by the setting of remote controller. Do not stop the fan in the place where no ventilation by stopping the fan may cause the influence of diffusion of air which it is dirty and moisture into another room, or the inflow from outside the room. (outflow such as viruses from the sickroom, or smell leakage from the rest room, etc.)

7. Adjustment set temperature for the local situation:

When the RA is not taken directly from the room (e.g. not connecting the RA duct), the temperature of RA might be higher than the set temperature of the standard indoor unit. In that case, be sure to adjust set temperatures of heating (humidification) and cooling in accordance with the local situation.

- Set temperature at factory setting: Heating (humidification) ...21°C, Cooling (suction temperature at refrigerant heat exchanger) ... 26°C
- Configurable range of set temperature: Heating (humidification) ...14 to 26°C, Cooling ...18 to 33°C

The correlation is as follows:

Cooling set temperature = Heating (humidification) set temperature + Temperature differential of cooling/heating thermo change-over of thermo-off cooling/heating (ex. 26°C = 21°C + 5°C)

MODE NO.	FIRST CODE NO.	Description of setting	SECOND CODE NO.												
			01	02	03	04	05	06	07	08	09	10	11	12	13
12 (22)	4	Temperature range of cooling/heating thermo changeover	0	1	2	3	4	5	6	7					
14 (24)	1	Heating (humidification) set temperature	14	15	16	17	18	19	20	21	22	23	24	25	26

In addition, when the VRV system Heat Recovery series is connected, adjust the temperature of cool/heat changeover at the automatic operation in accordance with the local situation.

- Changeover temperature at factory setting: Heating (humidification) ...15°C, Cooling (outdoor temperature) ... 25°C
- Configurable range of changeover temperature: Heating (humidification) ...10 to 18°C, Cooling ...19 to 30°C

The correlation is as follows:

Changeover temperature for cooling mode = Changeover temperature for heating mode + Temperature differential of cooling/heating mode changeover (ex. 25°C = 15°C + 10°C)

MODE NO.	FIRST CODE NO.	Description of setting	SECOND CODE NO.												
			01	02	03	04	05	06	07	08	09	10	11	12	13
14 (24)	3	Temperature differential of cooling/heating mode changeover	4	5	6	7	8	9	10	11	12	13	14	15	
	4	Changeover temperature for heating mode	10	11	12	13	14	15	16	17	18				

11. 2 PERFORM A TEST RUN ACCORDING TO THE OUTDOOR UNIT'S INSTALLATION MANUAL

- (1) Make sure the control box of the unit is closed before turning on power.
- (2) Make a test run following the operation manual of the outdoor unit.
 - The operation lamp of the remote controller will flash when an malfunction occurs. Check the malfunction code on the liquid crystal display to identify the point of trouble. An explanation of malfunction codes and the corresponding trouble is provided in "CAUTION FOR SERVICING" of the outdoor unit.

If the display shows any of the following, there is a possibility that the wiring was done incorrectly or that the power is not on, so check again.

Remote controller display	Content
"E1" is displayed.	<ul style="list-style-type: none"> • There is a short circuit at the FORCED OFF terminals (T1, T2).
"U3" is displayed.	<ul style="list-style-type: none"> • The test-run has not been performed.
"U4" is displayed. "U4" is displayed.	<ul style="list-style-type: none"> • The power on the outdoor unit is off. • The outdoor unit has not been wired for power supply. • Incorrect wiring for the transmission wiring and the wiring (the remote controller wiring or FORCED OFF wiring.) • The transmission wiring is cut.
"E8" is displayed.	<ul style="list-style-type: none"> • Damper malfunction. (Power voltage shortage)
"E8" is displayed.	<ul style="list-style-type: none"> • Fan driver malfunction. (Power voltage shortage)
"U8" is displayed.	<ul style="list-style-type: none"> • "MAIN/SUB" setting of the remote controller is wrong.
No display	<ul style="list-style-type: none"> • The power on the indoor unit and Heat Reclaim Ventilator is off. • The indoor unit and Heat Reclaim Ventilator has not been wired for power supply. • Incorrect wiring for the remote controller wiring and the wiring (the transmission wiring or the FORCED OFF wiring.) • The remote controller wiring is cut.

11. 3 RUN THE HUMIDIFIER <VKM-GBMV1 SERIES ONLY>

- (1) Check that the water supply piping is connected securely.
- (2) Open the water supply shut-off valve. (No water will be supplied at this time.)
- (3) Run the Heat Reclaim Ventilator unit in heating mode. (See the operating manual included with the indoor unit for details on how to run the unit in heating mode.)
The water supply will start and the humidifier will begin operation.
- (4) After starting heating (humidifying), the sound of the water supply solenoid valve will be heard every 3 or 4 minutes (a clicking sound), so listening for that clicking sound let the unit run for 30 minutes to make sure that humidifying operation is normal.

CAUTION

- If carpentry work is not completed when a test run is finished, tell the customer not to run the humidifier for the protection of indoor unit and Heat Reclaim Ventilator until it is completed.
- If the humidifier is run, paint, particles generated from adhesive and other materials used for carpentry work may cause Heat Reclaim Ventilator to get dirty, causing splash or leakage of water.

DAIKIN INDUSTRIES, LTD.

Head office:
Umeda Center Bldg., 2-4-12, Nakazaki-Nishi,
Kita-ku, Osaka, 530-8323 Japan

Tokyo office:
JR Shinagawa East Bldg., 2-18-1, Konan,
Minato-ku, Tokyo, 108-0075 Japan

DAIKIN EUROPE NV

Zandvoordestraat 300, B-8400 Oostende, Belgium