

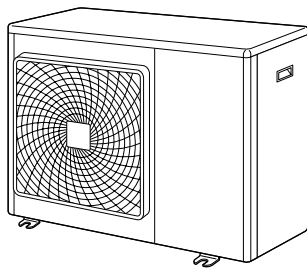

INSTALLATION MANUAL

R410A Split series



4MXS80E2V3B

5MXS90E2V3B
5MKS90E2V3B

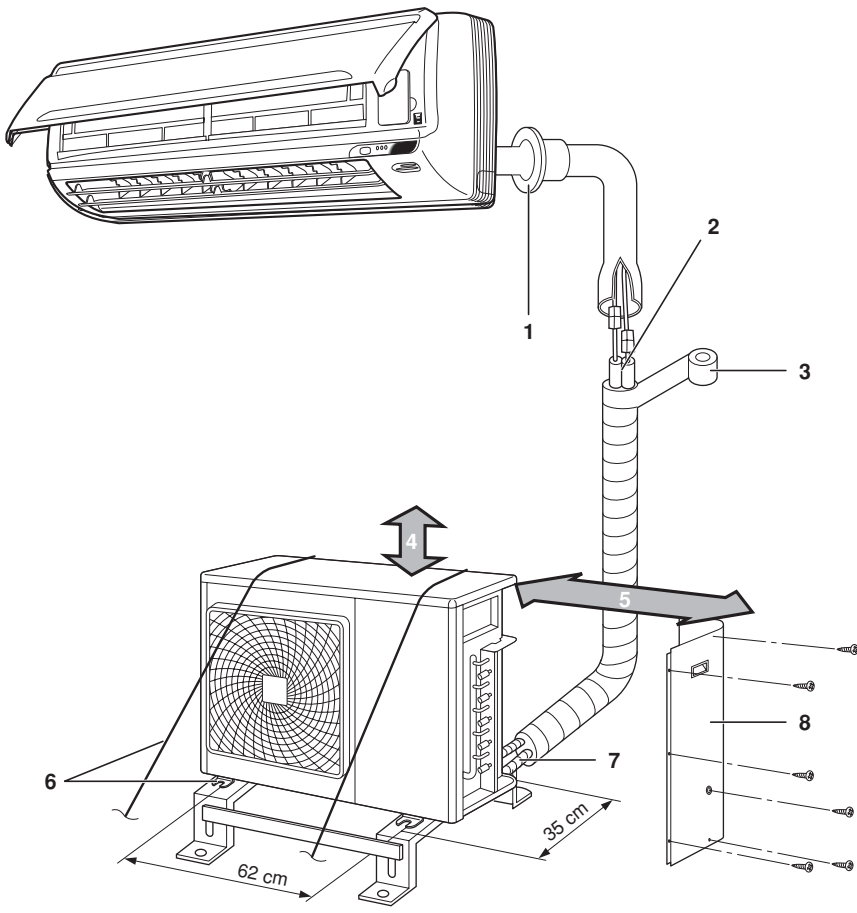

1

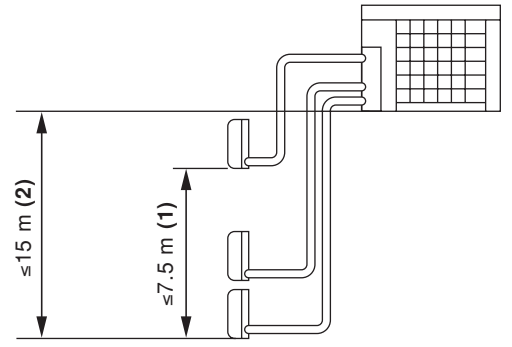

2

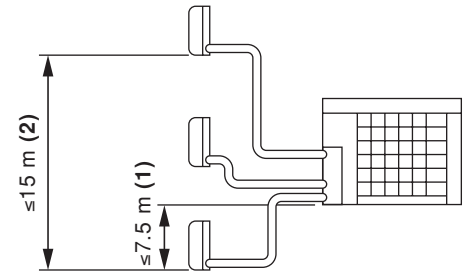

3

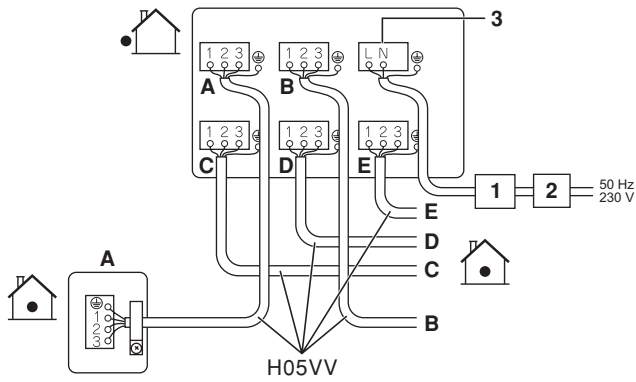

4

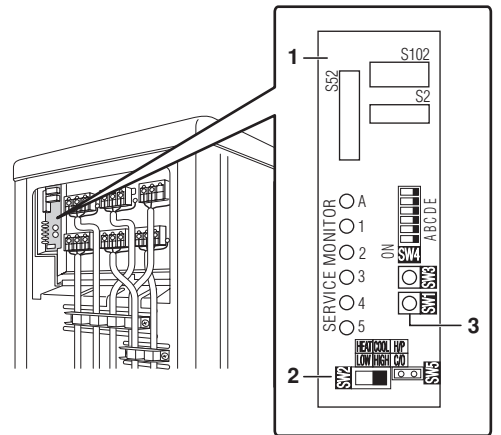

5

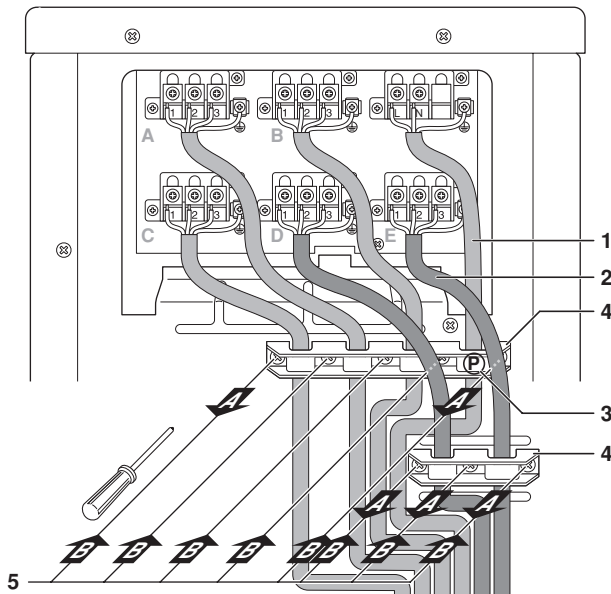

6

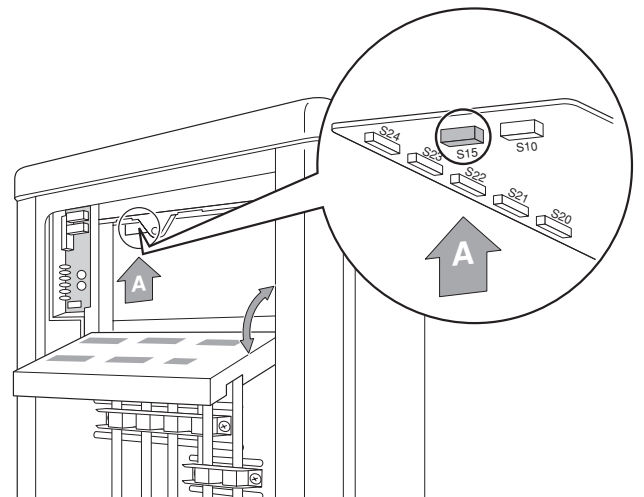

7

CONTENTS

	Page
Safety precautions.....	1
Accessories.....	2
Precautions for selecting the location.....	2
Indoor/outdoor unit installation drawings.....	3
Installation.....	3
Connections (connection port).....	3
Precautions on installation.....	4
Outdoor unit installation guidelines.....	4
Selecting a location for installation of the indoor units.....	4
Refrigerant piping work.....	4
Installing the outdoor unit.....	4
Method for installing drain piping.....	4
Refrigerant piping.....	5
Purging air and checking gas leakage.....	5
Charging refrigerant.....	6
Important information regarding the refrigerant used.....	6
Charging additional refrigerant.....	6
Refrigerant piping work.....	6
Flaring the pipe end.....	7
How to use reducers.....	7
Pump down operation.....	8
Forced operation.....	8
Wiring.....	8
Priority-room setting.....	9
Priority-room setting function.....	9
Night quiet mode setting.....	10
Night quiet mode function.....	10
COOL/HEAT mode lock <S15> (heat pump units only).....	10
Test run and final check.....	10
Wiring error check.....	10
Test run and final check.....	11
Items to check.....	11
Disposal requirements.....	11

SAFETY PRECAUTIONS

- This manual classifies the precautions into WARNING and CAUTION. Be sure to follow all the precautions below: they are all important for ensuring safety.



Failure to follow any of WARNING is likely to result in such grave consequences as death or serious injury.

Failure to follow any of CAUTION may in some cases result in grave consequences.

- The following safety symbols are used throughout this manual.



Be sure to observe this instruction.



Be sure to establish an earth connection.



Never attempt.

- After completing installation, test the unit to check for installation errors. Give the user adequate instructions concerning the use and cleaning of the unit according to the operation manual of the indoor unit.

WARNING



- Installation should be left to the dealer or another professional. Improper installation may cause water leakage, electrical shock, or fire.
- Install the air conditioner according to the instructions given in this manual. Incomplete installation may cause water leakage, electrical shock, or fire.
- Be sure to use the supplied or specified installation parts. Use of other parts may cause the unit to vibrate loose, and may cause water leakage, electrical shock, or fire.
- Install the air conditioner on a solid base that can support the weight of the unit. An inadequate base or incomplete installation may cause injury in the event the unit falls off the base.
- Electrical work should be carried out in accordance with the installation manual and the national electrical wiring rules or code of practice. Insufficient capacity or incomplete electrical work may cause electrical shock or fire.
- Be sure to use a dedicated power circuit. Never use a power supply shared by another appliance.
- For wiring, use a cable long enough to cover the entire distance with no connection. Do not use an extension cord. Do not put other loads on the power supply, use a dedicated power circuit. Failure to do so may cause abnormal heat, electric shock, or fire.
- Use the specified types of wires for electrical connections between the indoor and outdoor units. Firmly clamp the interconnecting wires so that their terminals receive no external stress. Incomplete connections or clamping may cause terminal overheating or fire.
- After connecting the interconnecting and supply wiring, be sure to shape the cables so that they do not put undue force on the electrical covers or panels. Install covers over the wires. Incomplete cover installation may cause terminal overheating, electrical shock, or fire.



READ THESE INSTRUCTIONS CAREFULLY BEFORE INSTALLATION. KEEP THIS MANUAL IN A HANDY PLACE FOR FUTURE REFERENCE.

IMPROPER INSTALLATION OR ATTACHMENT OF EQUIPMENT OR ACCESSORIES COULD RESULT IN ELECTRIC SHOCK, SHORT-CIRCUIT, LEAKS, FIRE OR OTHER DAMAGE TO THE EQUIPMENT. BE SURE ONLY TO USE ACCESSORIES MADE BY DAIKIN WHICH ARE SPECIFICALLY DESIGNED FOR USE WITH THE EQUIPMENT AND HAVE THEM INSTALLED BY A PROFESSIONAL.

IF UNSURE OF INSTALLATION PROCEDURES OR USE, ALWAYS CONTACT YOUR DAIKIN DEALER FOR ADVICE AND INFORMATION.









- If any refrigerant has leaked out during the installation work, ventilate the room.
The refrigerant produces a toxic gas if exposed to flames. 
- After all installation is complete, check to make sure that no refrigerant is leaking.
The refrigerant produces a toxic gas if exposed to flames. 
- When installing or relocating the system, be sure to keep the refrigerant circuit free from substances other than the specified refrigerant (R410A), such as air.
Any presence of air or other foreign substance in the refrigerant circuit causes an abnormal pressure rise or rupture, resulting in injury.
- During pump down operation, stop the compressor before removing the refrigerant piping.
If the compressor is still running and the stop valve is open during pump-down, air will be sucked in when the refrigerant piping is removed, causing abnormal pressure in the freezer cycle which will lead to breakage and even to injury.
- During installation, attach the refrigerant piping securely before running the compressor.
If the compressor is not attached and the stop valve is open during pump-down, air will be sucked in when the compressor is running, causing abnormal pressure in the freezer cycle which will lead to breakage and even to injury.
- Be sure to establish an earth. Do not earth the unit to a utility pipe, surge absorber, or telephone earth. 
Incomplete earth may cause electrical shock. A high surge current from lightning or other sources may cause damage to the air conditioner.
- Be sure to install an earth leakage breaker.
Failure to do so may cause electrical shock.

CAUTION

- Do not install the air conditioner in a place where there is danger of exposure to inflammable gas leakage. 
If the gas leaks and builds up around the unit, it may catch fire.
- Establish drain piping according to the instructions of this manual.
Inadequate piping may cause flooding.
- Note for installing the outdoor unit. (For heat pump model only.)
In cold areas where the outside air temperature remains below or around the freezing-point for a few days, the outdoor unit's drain may freeze. If so, it is recommended to install an electric heater in order to protect drain from freezing.
- Tighten the flare nut according to the specified method such as with a torque wrench.
If the flare nut is tightened too hard, the flare nut may crack after a long time and cause refrigerant leakage.

ACCESSORIES

Accessories supplied with the outdoor unit:

Installation manual	1	
Drain socket (A)	1	
Drain cap (B)	2	
Drain receiver (C)	3	
Insulation tape (D)	1	
Reducer assembly	1	
Fluorinated greenhouse gases label	1	
Multilingual fluorinated greenhouse gases label	1	
Screws for field installation	4	

PRECAUTIONS FOR SELECTING THE LOCATION

-  Make sure to provide adequate measures in order to prevent that the outdoor unit will be used as a shelter by small animals.
 - Small animals making contact with electrical parts can cause malfunctions, smoke or fire. Please instruct the customer to keep the area around the unit clean.
- 1 Choose a place solid enough to bear the weight and vibration of the unit, where the operation noise will not be amplified.
 - 2 Choose a location where the hot air discharged from the unit or the operation noise will not cause a nuisance to the neighbours of the user.
 - 3 Avoid places near a bedroom and the like, so that the operation noise will cause no trouble.
 - 4 There must be sufficient space for carrying the unit into and out of the site.
 - 5 There must be sufficient space for air passage and no obstructions around the air inlet and the air outlet.
 - 6 The site must be free from the possibility of flammable gas leakage in a nearby place.
Locate the unit so that the noise and the discharged hot air will not annoy the neighbours.
 - 7 Install units, power cords and inter-unit cables at least 3 m away from television and radio sets. This is to prevent interference to images and sounds.
Depending on radio wave conditions, electromagnetic interference may still occur even if installed more than 3 m away.
 - 8 In coastal areas or other places with salty atmosphere of sulfate gas, corrosion may shorten the life of the air conditioner.

- 9 Since drain flows out of the outdoor unit, do not place anything under the unit which must be kept away from moisture.

NOTE Units cannot be installed hanging from ceiling or stacked.

CAUTION

When operating the air conditioner in a low outdoor ambient temperature, be sure to follow the instructions described below.

- To prevent exposure to wind, install the outdoor unit with its suction side facing the wall.
- Never install the outdoor unit at a site where the suction side may be exposed directly to wind.
- To prevent exposure to wind, install a baffle plate on the air discharge side of the outdoor unit.
- In heavy snowfall areas, select an installation site where the snow will not affect the unit.

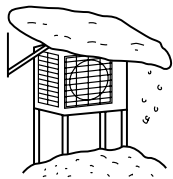

Construct a large canopy.

Construct a pedestal.

Install the unit high enough off the ground to prevent burying in snow.

INDOOR/OUTDOOR UNIT INSTALLATION

DRAWINGS (See figure 1)

For installation of the indoor units, refer to the installation manual which is provided with the units. The diagram shows a wall-mounted indoor unit.

CAUTION

- Do not connect the embedded branch piping to outdoor unit when only carrying out piping work without connecting the indoor unit (in order to add another indoor unit later).

Make sure no dirt or moisture gets into either side of the embedded branch piping.

See "Refrigerant piping work" on page 6 for details.

- Heat pump type: It is not allowed to connect 1 indoor unit only.

Be sure to connect at least 2 indoor units. Note that if a built-in indoor unit (FDBQ25) is connected, at least 3 indoor units must be connected.

Cooling only type: It is allowed to connect 1 indoor unit only.

- 1 Caulk pipe hole gap with putty.
- 2 Cut thermal insulation pipe to an appropriate length and wrap it with tape, making sure that no gap is left in the insulation pipe's cut line.
- 3 Wrap the insulation pipe with finishing tape from bottom to top.
- 4 Allow 30 cm of work space below the ceiling surface.
- 5 25 cm from wall. Allow space for piping and electrical servicing.
- 6 If there is danger of the unit falling or overturning, fix the unit with foundation bolts, or with wire or other means.
- 7 Connection of the outdoor unit
- 8 Service cover

- If the location does not have good drainage, place the unit on a level mounting base (or a plastic pedestal). Install the outdoor unit in a level position. Failure to do so may result in water leakage or accumulation.

- Also insulate the connection on the outdoor unit.

- 1 Insulation tape
- 2 Clamping material
- 3 Insulation tube
- 4 Service lid

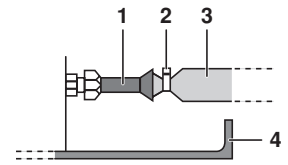

Use tape or insulating material on all connections to prevent air from getting in between the copper piping and the insulation tube. Be sure to do this if the outdoor unit is installed as shown in the figure.

INSTALLATION

- Install the unit horizontally.
- The unit may be installed directly on a concrete verandah or a solid place if drainage is good.
- If the vibration may possibly be transmitted to the building, use a vibration-proof rubber (field supply).

Connections (connection port)

Install the indoor unit according to the table below, which shows the relationship between the class of indoor unit and the corresponding port.

The total indoor unit class that can be connected to this unit:

- Heat pump type:
 - 4MXS80 - Up to 14.5 kW
 - 5MXS90 - Up to 15.6 kW
- Cooling only type:
 - 5MKS90 - Up to 15.6 kW

Model	Port				
	A	B	C	D	E
4MXS80	20	20 ⁽¹⁾	20 ⁽²⁾	20 ⁽²⁾	—
	25	25 ⁽¹⁾	25 ⁽²⁾	25 ⁽²⁾	
	35	35 ⁽¹⁾	35 ⁽²⁾	35 ⁽²⁾	
	42	42 ⁽¹⁾	42 ⁽²⁾	42 ⁽²⁾	
		50	50 ⁽³⁾	50 ⁽³⁾	
		60	60 ⁽³⁾	60 ⁽³⁾	
		71	71		
5MXS90	20	20	20 ⁽¹⁾	20 ⁽²⁾	20 ⁽²⁾
	25	25	25 ⁽¹⁾	25 ⁽²⁾	25 ⁽²⁾
	35	35	35 ⁽¹⁾	35 ⁽²⁾	35 ⁽²⁾
	42	42	42 ⁽¹⁾	42 ⁽²⁾	42 ⁽²⁾
			50	50 ⁽³⁾	50 ⁽³⁾
			60	60 ⁽³⁾	60 ⁽³⁾
		71	71	71	

- (1) Use no. 2 and 4 reducers to connect pipes.
- (2) Use no. 5 and 6 reducers to connect pipes.
- (3) Use no. 1 and 3 reducers to connect pipes.

Refer to "How to use reducers" on page 7 for information on reducer numbers and their shapes.

PRECAUTIONS ON INSTALLATION

- Check the strength and level of the installation ground so that the unit will not cause any operating vibration or noise after installation.
- Fix the unit securely by means of foundation bolts in accordance with the foundation drawing. Prepare 4 sets of M8 or M10 foundation bolts, nuts and washers each (field supply).
- It is best to screw in the foundation bolts until their length remains 20 mm above the foundation surface.

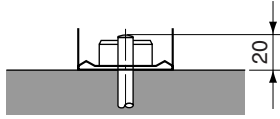

OUTDOOR UNIT INSTALLATION GUIDELINES

- Where a wall or other obstacle is in the path of the outdoor unit air intake or exhaust airflow, follow the installation guidelines below.
- For any of the installation patterns below, the wall height on the exhaust side should be ≤ 1200 mm.

Wall facing one side

Side view (unit: mm)

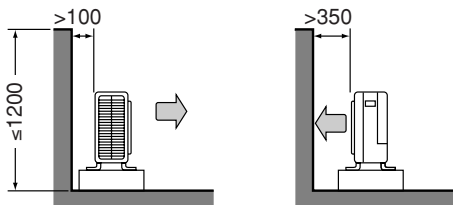

Walls facing two sides

Top view (unit: mm)

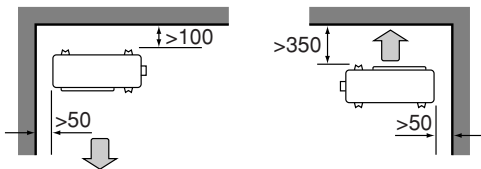

Walls facing three sides

Top view (unit: mm)

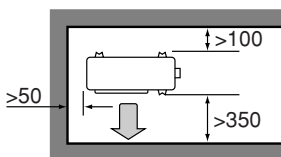

SELECTING A LOCATION FOR INSTALLATION OF THE INDOOR UNITS

The maximum allowable length of refrigerant piping, and the maximum allowable height difference between the outdoor and indoor units, are listed below.

The shorter the refrigerant piping, the better the performance. Connect so that the piping is as short as possible. **Shortest allowable length per room is 3 m.**

Outdoor unit capacity class	4MXS80	5MXS90 5MKS90
Piping to each indoor unit	≤ 25 m	
Total length of piping between all units	≤ 70 m	≤ 75 m

If the outdoor unit is positioned higher than the indoor units

(See figure 2)

If the outdoor unit is positioned otherwise (i.e. lower than one or more indoor units) (See figure 3)

- 1 Level difference: ≤ 7.5 m
- 2 Level difference: ≤ 15 m

REFRIGERANT PIPING WORK



All field piping must be installed by a licensed refrigeration technician and must comply with relevant local and national regulations.

Installing the outdoor unit

- When installing the outdoor unit, refer to "Precautions for selecting the location" on page 2 and "Indoor/outdoor unit installation drawings" on page 3.
- If drain work is necessary, follow the procedures below.

Method for installing drain piping

- Use drain plug for drainage.
- In cold areas, do not use a drain hose with the outdoor unit. Otherwise, drain water may freeze, impairing the heating performance.

- 1 See figure below for installation of the drain plug.

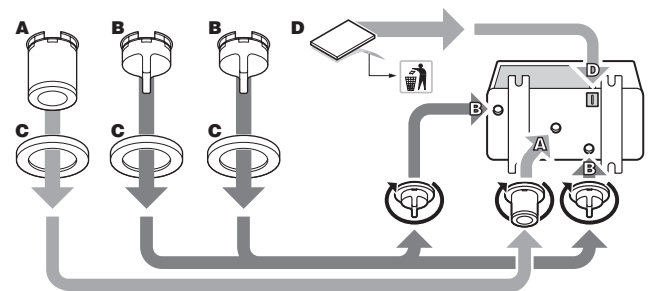

- 2 Connect a field supplied vinyl hose (internal diameter of 25 mm) to the drain socket (A).

If the hose is too long and hangs down, fix it carefully to prevent kinks.



NOTE If drain holes of the outdoor unit are covered by a mounting base or by floor surface, raise the unit in order to provide a free space of more than 100 mm under the outdoor unit.

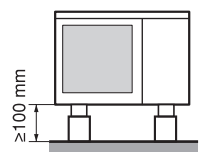

Refrigerant piping

- Align the centres of both flares and tighten the flare nuts 3 or 4 turns by hand. Then tighten them fully with torque wrenches.

Use torque wrenches when tightening the flare nuts to prevent damage to the flare nuts and to prevent escaping of gas.

- Torque wrench
- Spanner
- Piping union
- Flare nut

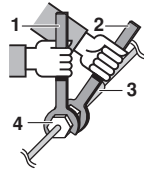

Flare nut	Flare nut tightening torque
Ø6.4	14~17 N•m
Ø9.5	33~39 N•m
Ø12.7	50~60 N•m
Ø15.9	63~75 N•m

Valve cap tightening torque	
Liquid pipe	Gas pipe
26.5~32.3 N•m	48.1~59.7 N•m

Service port cap tightening torque
10.8~14.7 N•m

- When connecting the flare nut, coat the flare inner surface with ether oil or ester oil and initially tighten 3 or 4 turns by hand before tightening firmly.

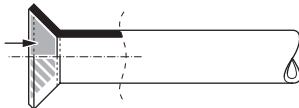

Purging air and checking gas leakage

When piping work is completed, it is necessary to purge the air and check for gas leakage.



WARNING

- Do not mix any substance other than the specified refrigerant (R410A) into the refrigeration cycle.
- When refrigerant gas leaks occur, ventilate the room as soon and as much as possible.
- R410A, as well as other refrigerants, should always be recovered and never be released directly into the environment.
- Use a vacuum pump for R410A exclusively. Using the same vacuum pump for different refrigerants may damage the vacuum pump or the unit.

- If using additional refrigerant, perform air purging from the refrigerant pipes and indoor unit using a vacuum pump, then charge additional refrigerant.
 - Use a hexagonal wrench (4 mm) to operate the stop valve rod.
 - All refrigerant pipe joints should be tightened with a torque wrench at the specified tightening torque.
- Connect the projection side (on which the worm pin is pressed) of the charging hose coming from the gauge manifold to the gas stop valve's service port.
 - Fully open the gauge manifold's low-pressure valve (Lo) and completely close its high-pressure valve (Hi).
The high-pressure valve subsequently requires no operation.
 - Apply vacuum pumping. Check that the compound pressure gauge reads -0.1 MPa (-760 mm Hg).
Evacuation for **at least 1 hour** is recommended.
 - Close the gauge manifold's low-pressure valve (Lo) and stop the vacuum pump.
Leave as is for 4-5 minutes and make sure the coupling meter needle does not go back.
If it does go back, this may indicate presence of moisture or leaking from connecting parts. Repeat steps 2 – 4 after checking all connecting parts and slightly loosening and retightening the nuts.
 - Remove covers from liquid stop valve and gas stop valve.
 - Turn the liquid stop valve's rod 90 degrees counterclockwise with a hexagonal wrench to open the valve.
Close it after 5 seconds, and check for gas leakage.
Using soapy water, check for gas leakage from indoor unit's flare and outdoor unit's flare and valve rods.
After the check is complete, wipe all soapy water off.
 - Disconnect charging hose from gas stop valve's service port, then fully open liquid and gas stop valves.
Do not attempt to turn valve rod beyond its stop.
 - Tighten valve lids and service port caps for the liquid and gas stop valves with a torque wrench at the specified torques. See "Refrigerant piping work" on page 4 for details.

Charging refrigerant

This outdoor unit is factory charged.

In case re-charge is required, refer to the nameplate of the unit. The nameplate states the type of refrigerant and necessary amount.

Precautions when adding R410A

Be sure to charge the specified amount of refrigerant in liquid state to the liquid pipe.

Since this refrigerant is a mixed refrigerant, adding it in gas form may cause the refrigerant composition to change, preventing normal operation.

- Before charging, check whether the refrigerant cylinder is equipped with a siphon tube or not.

Charge the liquid refrigerant with the cylinder in upright position.

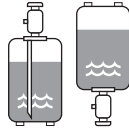

Charge the liquid refrigerant with the cylinder in up-side-down position.



- Be sure to use tools exclusively for R410A to ensure required pressure resistance and to prevent foreign materials from mixing into the system.

Important information regarding the refrigerant used

This product contains fluorinated greenhouse gases covered by the Kyoto Protocol. Do not vent gases into the atmosphere.

Refrigerant type: R410A

GWP⁽¹⁾ value: 1975

⁽¹⁾ GWP = global warming potential

Please fill in with indelible ink,

- ① the factory refrigerant charge of the product,
- ② the additional refrigerant amount charged in the field and
- ①+② the total refrigerant charge

on the fluorinated greenhouse gases label supplied with the product.

The filled out label must be adhered on the inside of the product and in the proximity of the product charging port (e.g. on the inside of the service cover).

	① = <input type="text"/> kg	1	factory refrigerant charge of the product: see unit name plate
	② = <input type="text"/> kg	2	additional refrigerant amount charged in the field
	①+② = <input type="text"/> kg	3	total refrigerant charge
		4	Contains fluorinated greenhouse gases covered by the Kyoto Protocol
		5	outdoor unit
		6	refrigerant cylinder and manifold for charging

NOTE



National implementation of EU regulation on certain fluorinated greenhouse gases may require to provide the appropriate official national language on the unit. Therefore an additional multilingual fluorinated greenhouse gases label is supplied with the unit.

Sticking instructions are illustrated on the backside of that label.

Charging additional refrigerant



When performing service on the unit requiring the refrigerant system to be opened, refrigerant must be evacuated according to local regulations.

If the total length of piping for all rooms exceeds the figure listed below, additionally charge with 20 g of refrigerant (R410A) for each additional meter of piping.

	4MXS80 5MXS90	5MKS90
Total length of piping for all rooms	30 m	65 m

Determine the weight of refrigerant to be charged additionally and fill in the amount in the service sticker on the rear side of the service cover.



CAUTION

Even though the stop valve is fully closed, the refrigerant may slowly leak out; do not leave the flare nut removed for a long period of time.

Refrigerant piping work

Cautions on pipe handling

- Protect the open end of the pipe against dust and moisture.
- All pipe bends should be as gentle as possible. Use a pipe bender for bending. Bending radius should be 30 to 40 mm or larger.

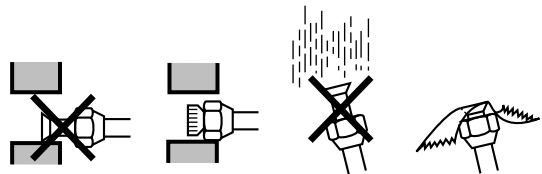

Selection of copper and heat insulation materials

When using commercial copper pipes and fittings, observe the following:

- Insulation material: polyethylene foam
Heat transfer rate: 0.041 to 0.052 W/mK (0.035 to 0.045 kcal/mh°C)
Refrigerant gas pipe's surface temperature reaches 110°C max. Choose heat insulation materials that will withstand this temperature.
- Be sure to insulate both the gas and liquid piping and to provide insulation dimensions as below.

Pipe size		Pipe insulation	
O.D. (mm)	Thickness (mm)	I.D. (mm)	Thickness (mm)
6.4	0.8	8-10	≥10
9.5		12-15	≥13
12.7			
15.9	1.0	16-20	

- Gas pipe
- Inter-unit wiring
- Liquid pipe
- Liquid pipe insulation
- Drain hose
- Finishing tape
- Gas pipe insulation

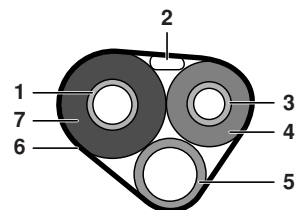

- Use separate thermal insulation pipes for gas and liquid refrigerant pipes.

Flaring the pipe end

- 1 Cut the pipe end with a pipe cutter.
- 2 Remove burrs with the cut surface facing downward so that the chips do not enter the pipe.

- 1 Cut exactly at right angles.
- 2 Remove burrs.

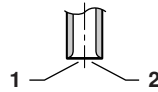

- 3 Put the flare nut on the pipe.
- 4 Flare the pipe.

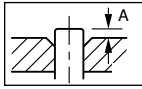

Flare tool for R410A		Conventional flare tool	
	Clutch type	Clutch type ("Rigid")	Wing nut type ("Imperial")
A	0~0.5 mm	1.0~1.5 mm	1.5~2.0 mm

Set exactly at the position shown above.

- 5 Check that the flaring is properly made.

- 1 Flare's inner surface must be flaw-free.
- 2 The pipe end must be evenly flared in a perfect circle.
- 3 Make sure that the flare nut is fitted.

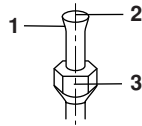

WARNING

- Do not use mineral oil on flared part.
- Prevent mineral oil from getting into the system as this would reduce the lifetime of the units.
- Never use piping which has been used for previous installations. Only use parts which are delivered with the unit.
- Do never install a drier to this R410A unit in order to guarantee its lifetime. The drying material may dissolve and damage the system.
- Incomplete flaring may cause refrigerant gas leakage.

HOW TO USE REDUCERS

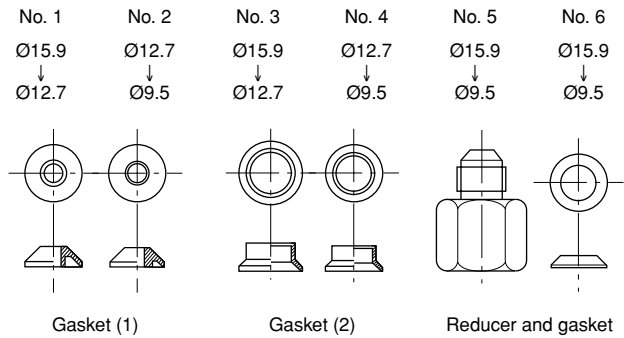

Use the reducers supplied with the unit as described below.

Connecting a pipe of $\varnothing 12.7$ to a gas pipe connection port for $\varnothing 15.9$:

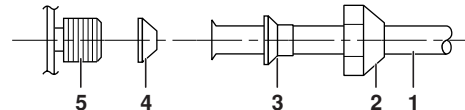

- 1 Inter-unit piping
- 2 Flare nut (for $\varnothing 15.9$)
- 3 No. 3
- 4 No. 1
Be sure to attach the gasket
- 5 Connection port of outdoor unit

Connecting a pipe of $\varnothing 9.5$ to a gas pipe connection port for $\varnothing 15.9$:

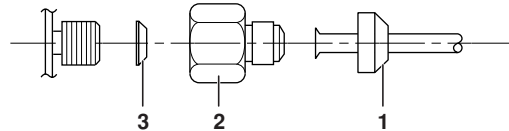

- 1 Flare nut (for $\varnothing 9.5$)
- 2 No. 5
- 3 No. 6
Be sure to attach the gasket

Connecting a pipe of $\varnothing 9.5$ to a gas pipe connection port for $\varnothing 12.7$:

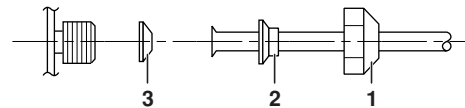

- 1 Flare nut (for $\varnothing 12.7$)
- 2 No. 4
- 3 No. 2
Be sure to attach the gasket

- When using the reducer packing shown above, be careful not to overtighten the nut, or the smaller pipe may be damaged. (Approx. 2/3 - 1x the normal torque)
- Apply a coat of refrigeration oil to the threaded connection port of the outdoor unit where the flare nut comes in.
- Use an appropriate torque wrench to avoid damaging the connection thread by overtightening the flare nut.

Flare nut	Flare nut tightening torque
$\varnothing 9.5$	32.7~39.9 N•m (333~407 kgf•cm)
$\varnothing 12.7$	49.5~60.3 N•m (505~615 kgf•cm)
$\varnothing 15.9$	61.8~75.4 N•m (630~769 kgf•cm)

PUMP DOWN OPERATION

In order to protect the environment, be sure to pump down when relocating or disposing of the unit.

- 1 Remove the valve lid from liquid stop valve and gas stop valve.
- 2 Carry out forced cooling operation.
- 3 After 5 to 10 minutes, close the liquid stop valve with a hexagonal wrench.
- 4 After 2-3 minutes, close the gas stop valve and stop forced cooling operation.

- 1 Gas stop valve
- 2 Close
- 3 Hexagonal wrench
- 4 Valve lid
- 5 Liquid stop valve

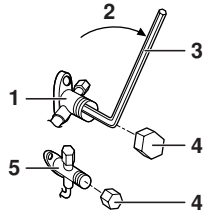

Forced operation

- 1 Turn the operation mode switch SW2 to "COOL". (Heat pump only)
- 2 Press the forced operation switch SW1 to begin forced cooling. (See figure 5)

- 1 Service PCB
- 2 Operation mode switch SW2
- 3 Forced operation switch SW1

NOTE Forced operation automatically stops approximately 15 minutes after starting.

To continue forced operation after elapse of the 15 minutes, press the forced operation switch SW1 again.

To stop forced operation immediately, press the forced operation switch SW1.

WIRING



All wiring must be performed by an authorized electrician.



WARNING

- Do not use tinned wires, stranded conductor wires (see caution 1), extension cords or connections from a star system, as they may cause overheating, electrical shock or fire.
- Do not use locally purchased electrical parts inside the product and do not branch the power for the drain pump, etc., from the terminal block. Doing this may cause electrical shock or fire.
- Be sure to install an earth leakage breaker. This unit uses an inverter, which means that an earth leakage breaker capable of handling high harmonics needs to be used in order to prevent malfunctioning of the earth leakage breaker itself.
- Use an all-pole disconnection type breaker with a contact separation of at least 3 mm inbetween all poles.

Equipment complying with EN/IEC 61000-3-12⁽¹⁾

Do not turn ON the safety breaker until all work is completed.

- 1 Strip the insulation from the wire (20 mm).
- 2 See caution 2.

Connect the connection wires between the indoor and outdoor units so that the terminal numbers match. Tighten the terminal screws securely. We recommend a flathead screwdriver to tighten the screws. (See figure 4)

- 1 Safety breaker
- 2 Earth leakage circuit breaker
- 3 Power supply
Be sure to use a dedicated power supply circuit.



- NOTE**
- If the length of a connection wire is ≥ 10 m, use $\varnothing 2.5$ mm wires.
 - Make sure that wiring connections of each individual indoor unit (room A, B, ...) match the corresponding piping connections on the outdoor unit refrigeration ports (A, B, ...).



CAUTION

1. In case the use of stranded conductor wires is unavoidable for one reason or another, make sure to install round crimp-style terminals on the tip. Place the round crimp-style terminal on the wire up to the covered part and fasten the terminal with the appropriate tool.

- 1 Stranded conductor wire
- 2 Round crimp-style terminal



2. When connecting the connection wires to the terminal board using a single core wire, be sure to perform curling.



Not executing the connections properly may cause heat and fire.

(1) European/International Technical Standard setting the limits for harmonic currents produced by equipment connected to public low-voltage systems with input current >16 A and ≤ 75 A per phase.

3 Earth terminal installation

- Use the following method when installing single core wires.

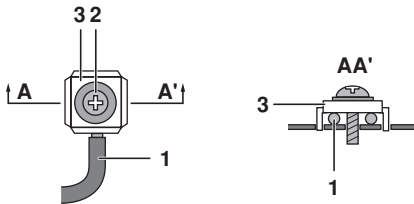

- 1 Single core wire
- 2 Screw
- 3 Flat washer

- Use the following method when using round crimp-style terminals.

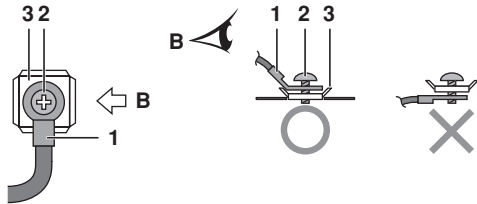

- 1 Round crimp-style terminal
- 2 Screw
- 3 Flat washer

- 4 Pull the connected wires and make sure that they do not disconnect. Then fix the wires in place in the wire clamps, by first removing the screws (A), position the cables and then fix the wire clamp again with the removed screws and the 4 delivered screws (B). Secure firmly and be sure no tension is applied to the terminals. (See figure 6)

- 1 Shape the wires so that there is no lifting of the service hatch or other structural parts.
- 2 Use the specified wires and connect them securely.
- 3 Be sure to clamp the power supply wire in this location.
- 4 Wire clamp
- 5 Secure the wiring firmly as shown in figure 6.

NOTE This air conditioner must be earthed.

For earthing, follow the applicable local standard for electrical installations.

PRIORITY-ROOM SETTING

The priority-room setting requires initial programming during installation. Explain the priority-room setting as described below to the customer, and confirm whether or not the customer wants to use priority-room setting.

Setting it in the guest and living rooms is convenient.

Priority-room setting function

The indoor unit for which priority-room setting is applied takes priority in the following cases.

Operation mode priority

The operation mode of the indoor unit which is set for priority-room takes precedence over operation mode of other indoor units. This means that in case operation mode of these other indoor units is different from the operation mode as requested in the room that is set for priority-room, these indoor units will enter standby mode.

Priority during "Powerful" operation

If the indoor unit which is set for priority-room is operating at "Powerful" operation, distribution of capacity to other indoor units will be reduced. This means that the room of which the indoor unit is set for priority-room will be cooled or heated much quicker than other rooms.

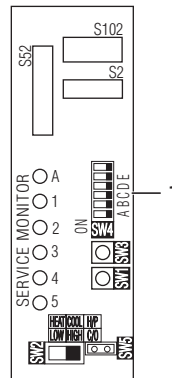

1 Priority-room setting switch SW4

Indoor or outdoor unit quiet operation priority

Pressing the "Quiet operation button" on the remote controller of the indoor unit set for priority-room, will make the outdoor unit run quietly. You do not have to set all operated indoor units to outdoor unit quiet operation in this case. Running units in outdoor unit quiet operation however, reduces the cooling/heating capacity.

Setting procedure

Slide the switch to the ON side for the switch that corresponds to the piping connected to the indoor unit to be set. (In the figure below, it is room A.)



Once the settings are complete, reset the power.



Be sure to only set 1 room as priority-room.

NIGHT QUIET MODE SETTING

The night quiet mode setting requires initial programming during installation. Explain night quiet mode, as described below, to the customer, and confirm whether or not the customer wants to use night quiet mode.

Night quiet mode function

The night quiet mode function reduces operating noise of the outdoor unit at nighttime. This function is useful if the customer is worried about the effects of the operating noise on the neighbours.

Running units in night quiet mode however, reduces the cooling/heating capacity.

Setting procedure

Remove the SW5 jumper switch.

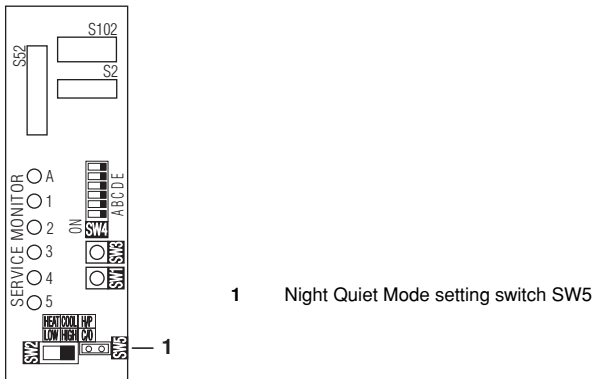

Once the settings are complete, reset the power.

NOTE Install the removed jumper switch as described below. This switch will be needed to later disable this setting.

- 1 Jumper switch
- 2 After removing

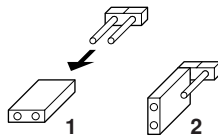

COOL/HEAT MODE LOCK <S15> (HEAT PUMP UNITS ONLY)

(See figure 7 and arrow view A in this paragraph)

Use the S15 connector to set the unit to only cool or only heat.

- 1 Setting to only heat (H): short-circuit pins 1 and 3 of the connector S15.
- 2 Setting to only cool (C): short-circuit pins 3 and 5 of the connector S15.

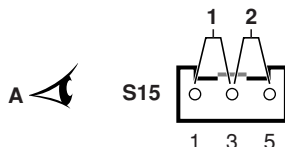

The following specifications apply to the connector housing and pins (JST products):

Housing VHR-5N

Pin SVH-21T-1,1

Remark that bridging connections are available as spare parts. Check the dedicated spare parts list.

NOTE Forced operation remains available, whatever the mode setting that has been locked.

TEST RUN AND FINAL CHECK

- Before starting the test run, measure the voltage at the primary side of the safety breaker. Check that it is 230 V.
- Check that all liquid and gas stop valves are fully open.
- Check that piping and wiring all match. The wiring error check can be conveniently used for underground wiring and other wiring that cannot be directly checked.

NOTE



Remark that during the first running period of the unit, required power input may be higher than stated on the nameplate of the unit. This phenomenon originates from the compressor that needs elapse of a 50 hours run in period before reaching smooth operation and stable power consumption.

Wiring error check

- This product is capable of automatic correction of wiring errors.
- Press the wiring error check switch SW3 on the outdoor unit service PCB. Approximately 15–20 minutes after the switch is pressed, the errors in the connection wiring will be corrected. However, the wiring error check switch will not function the first 3 minutes after the safety breaker was turned on, or depending on the outside air condition (See Note 2 on page 11).

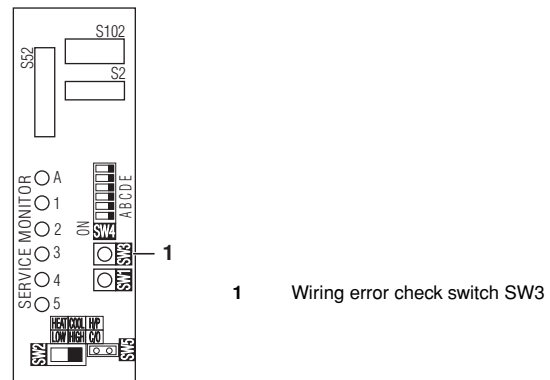

The service monitor LEDs indicate whether or not correction is possible, as shown in the table below. For details about how to read the LED display, refer to the service manual.

If self-correction is not possible, check the indoor unit wiring and piping in the usual manner.

LED	1	2	3	4	5	Message
Status	All flashing					Automatic correction is impossible
	Flashing one after another					Automatic correction is completed
	One or more of LEDs 1 to 5 are ON					Abnormal stop (See Note 4 on page 11)

Example of correction of wiring error

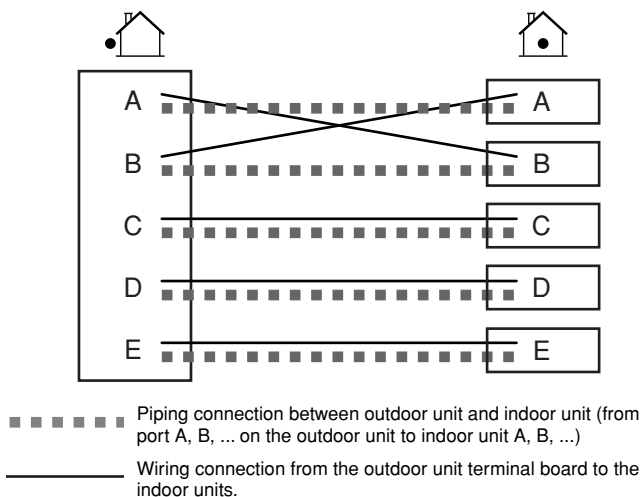

In case that the wiring error check was not interrupted, the LED lighting sequence after the automatic wiring correction in this example is 2→1→3→4→5.

NOTE



- 1 For 2 rooms, LED 3, 4 and 5 do not light up, and for 3 rooms, LED 4 and 5 do not light up. For 4 rooms, LED 5 does not light up.
- 2 If the outside air temperature is $\leq 5^{\circ}\text{C}$, the wiring error check function will not operate.
- 3 After wiring error check operation is completed, LED indication will continue until ordinary operation starts. This is normal.
- 4 Follow procedures as mentioned on the service sticker on the rear side of the service cover.

Test run and final check

- To test cooling, set for the lowest temperature. To test heating, set for the highest temperature. (Depending on the room temperature, only heating or cooling (but not both) may be possible.)
- After the unit is stopped, it will not start again (heating or cooling) for approximately 3 minutes.
- During the test run, first check the operation of each unit individually. Then also check the simultaneous operation of all indoor units.
Check both heating and cooling operation.
- After running the unit for approximately 20 minutes, measure the temperatures at the indoor unit inlet and outlet. If the measurements are above the values shown in the table below, then they are normal.

	Cooling	Heating
Temperature difference between inlet and outlet	$\pm 8^{\circ}\text{C}$	$\pm 20^{\circ}\text{C}$

- During cooling operation, frost may form on the gas stop valve or other parts. This is normal.
- Operate the indoor units in accordance with the included operation manual. Check that they operate normally.

Items to check

Check	Symptom
<input type="checkbox"/> Are the indoor units installed securely?	Falling, vibration, noise.
<input type="checkbox"/> Has an inspection been made to check for gas leakage?	No cooling, no heating.
<input type="checkbox"/> Has complete thermal insulation been done (gas pipes, liquid pipes, indoor portions of the drain hose extension)?	Water leakage.
<input type="checkbox"/> Is the drainage secure?	Water leakage.
<input type="checkbox"/> Are the earth wire connections secure?	Danger in case of an earthing fault.
<input type="checkbox"/> Are the electric wires connected correctly?	No cooling, no heating.
<input type="checkbox"/> Is the wiring in accordance with the specifications?	Operation failure, burning.
<input type="checkbox"/> Are the inlets/outlets of the indoor and outdoor units free of any obstructions? Are the stop valves open?	No cooling, no heating.
<input type="checkbox"/> Do the marks match (room A, room B) on the wiring and piping for each indoor unit?	No cooling, no heating.
<input type="checkbox"/> Is the priority-room setting set for 2 or more rooms?	The priority-room setting will not function.



ATTENTION

- Have the customer actually operate the unit while looking at the manual included with the indoor unit. Instruct the customer how to operate the unit correctly (particularly cleaning of the air filters, operation procedures, and temperature adjustment).
- Even when the air conditioner is not operating, it consumes some electric power. If the customer is not going to use the unit soon after it is installed, turn OFF the breaker to avoid wasting electricity.

DISPOSAL REQUIREMENTS

Dismantling of the unit, treatment of the refrigerant, of oil and of other parts must be done in accordance with relevant local and national legislation.

NOTES

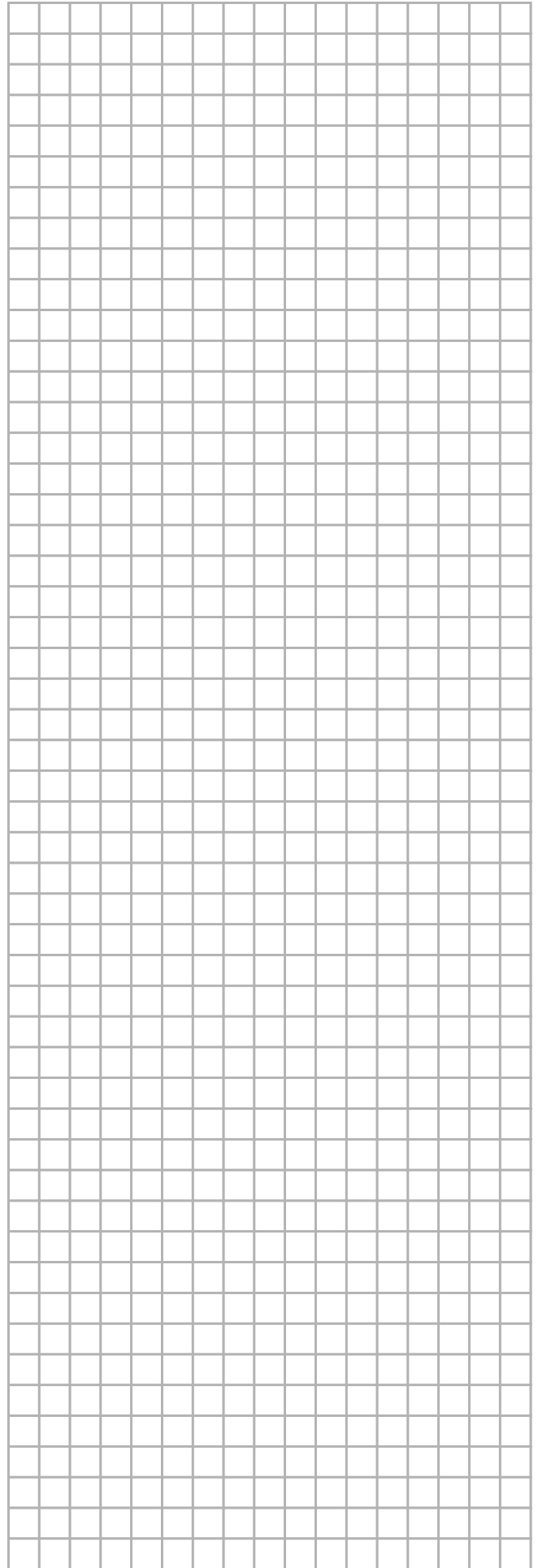



4PW46343-1 A 000000M

Copyright © Daikin

DAIKIN EUROPE N.V.

Zandvoordestraat 300, B-8400 Oostende, Belgium

4PW46343-1A