



Air Conditioners

# Technical Data

Rooftops



EEDEN11-107

UATYQ-CY1



Air Conditioners

# Technical Data

Rooftops

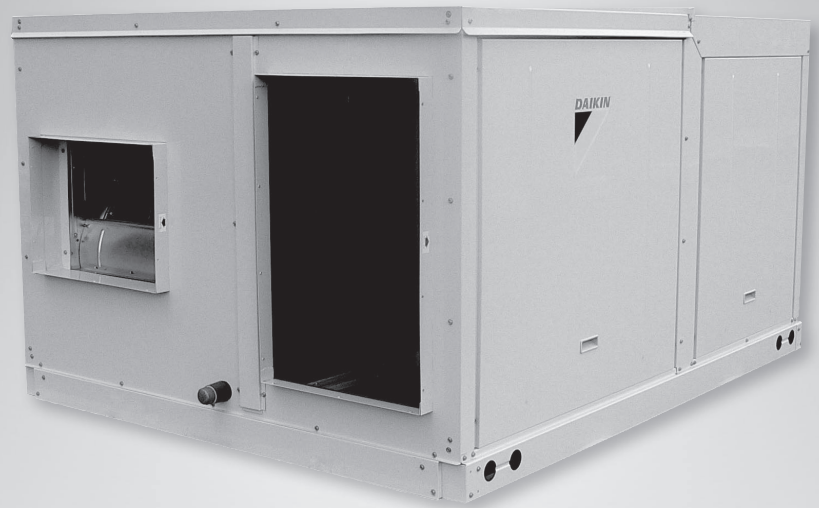

EEDEN11-107

UATYQ-BY1

# TABLE OF CONTENTS

## UATYQ-BY1

1	Specification text .....	2
2	Selection procedure .....	5
3	Features .....	11
4	Specifications .....	12
	Technical Specifications .....	12
	Electrical Specifications .....	12
5	Nomenclature .....	13
6	Safety device settings .....	14
7	Options .....	16
8	Capacity tables .....	17
	Capacity tables cooling .....	17
	Capacity tables heating .....	23
	Capacity Correction Factor .....	25
9	Dimensional drawings .....	26
10	Piping diagram .....	29
11	Wiring diagrams .....	30
	Wiring Diagrams - Three Phase .....	30
	Wiring Diagrams - Single Phase .....	33
12	Sound data .....	34
	Sound pressure spectrum .....	34
	Sound level data .....	37
13	Fan characteristics .....	38
14	Installation .....	40
	Roofcurb drawings .....	40
	Pulley .....	41

# 1 Specification text

UATYQ-CY1

## Features Write up

1. **Package Unit:** Daikin's new range of rooftop packaged units has been developed specifically to suit commercial applications and are designed to be easy to install, requiring only ducting (and associated fittings), power/ control wiring and drain piping. Along with the light grey colour, the flat top and compact design gives an aesthetic and neat appearance when installed in line of sight. The unit cabinet is made of powder coated sheet metal especially suitable for outdoor use. All parts of the structure are fastened with corrosion resistant screws and bolts.
2. **Base Beam:** The base beams are fixed and provide a rigid foundation for the entire unit. The beam has the forklift slots and rigging holes for better handling purpose. It is also designed to allow mounting on a roof curb, the dimension of the roof curb should be followed strictly in accordance with the installation manual.
3. **Flexible Air Supply:** Since all the units utilize a belt/ pulley driven supply air fan, the units are able to meet a wide range of supply air volumes and external static pressures. Furthermore, the supply air fan motors, pulleys and belts (field supplied) can be easily changed on site to meet exact air flow and ESP requirement if required.
4. **Convertible Return and Supply Air:** Unit can be easily converted from horizontal to vertical (downward) supply and return air duct configuration by relocating the panels and supply air fan mounting.
5. **Scroll Compressor:** Units are equipped with high efficiency and reliable scroll compressors. Each compressor is mounted on rubber vibration isolators in order to reduce the noise level and vibration transmissions.
6. **Powder Coated Condensate Drain Pan:** The sheet metal condensate drain pan is powder coated to resist corrosion.
7. **Slots for 2 inches Return Air Filters:** A 2 inches rail is provided as standard in instances where a field supplied filter casement need to be installed.
8. **Higher Energy Efficiency Rating:** The UATYQ series is designed in line with market requirement for better energy saving. Its' performance is claimed to be among the best in the market.

# 1 Specification text

UATYQ-CY1

## Technical Write Up:

### 1. Compressor

Compressor used in UATYQ series Packaged Units are hermetically sealed scroll type. All the compressors are provided with an internal overload protection.

### 2. Condenser

Condenser coils are manufactured from seamless inner grooved copper tubes mechanically bonded to aluminium fins to ensure optimum heat transfer. All coils are tested against by Nitrogen holding at 609psig and highly precise Helium leak test at 235psig. ALL standard coils are up to 3 rows / 14-16 FPI, 3/8" (9.52mm) O.D. tubes. Hydrophilic Gold Fin coating (NA549) is offered as standard, which has longer life span under corrosive environment.

### 3. Evaporator

Evaporator coils are manufactured from seamless inner grooved copper tubes mechanically bonded to aluminium fins to ensure optimum heat transfer. All coils are tested against by Nitrogen holding at 609psig and highly precise Helium leak test at 235psig. ALL standard coils are 3-4 rows / 14-16 FPI, 3/8" (9.52mm) O.D. tubes. Hydrophilic Gold Fin coating (NA549) is offered as standard, which has longer life span under corrosive environment.

### 4. Condenser Fan and Motor

Fans are of propeller type, direct driven by weatherproof electrical induction motors. Condenser fan motor has class F insulation and splash-proof enclosure, IP44.

### 5. Evaporator Fan and Drive

Blower is DWDI centrifugal, forward curved type. It is mechanically and dynamically balanced and being mounted on a rigid shaft in a self aligned bearing block. The motor is fitted with an adjustable V-belt drive, as standard. It has class B insulation and dripping water proof, IP22.

### 6. Refrigerant Circuit

Each refrigerant circuit shall have independent electronic expansion devices, HP/LP switch and refrigerant line service pressure ports as standard factory installed.

### 7. Expansion device:

Electronic Expansion Valve is being used to ensure accurate control of refrigerant flow.

### 8. Casing/ Structure

The unit casing used in UATYQ series is made of zinc coated galvanized steel sheets. It is further coated with an electrostatic powder coat and then oven-baked for a tough and lasting weather resistant finish. Zinc plated screws are used throughout to further reduce possibility of unit rusting.

# 1 Specification text

UATYQ-CY1

## 9. Insulation

ALL possible areas of condensation to happen are insulated by PE, Polyethelene. Panel insulation is 10mm thickness while drain pan insulation is 5mm thickness.

## 10. Control

Units shall be completely factory supplied with an integrated controlled Module, with built in resident control algorithms to make decide heating, cooling, or ventilating operations in response to electronic signals from indoor & outdoor temperature sensors.

## 11. Rooftop Panel - handset

Rooftop Panel comprises all starting, operating and safety controls setting. It is connected to the IC module PCB and supplied as standard.

## 12. Optional Features

### I. 3rd Party Thermostat

For application that requires uniform thermostat outlook with other electrical appliances. 3rd Party thermostat can be connected to the factory supplied module via the contact point available on PCB board.

### II. Basic BMS Connection

Unit's standard PCB board provides dry contact for basic BMS connection. Input signal will go to dry contact ON/OFF, COOL/HEAT, and 4 to 20 mA temperature adjuster while output signal will come from ON/OFF, COOL/HEAT, ALARM and DEFROST dry contact.

### III. Higher Level BMS Connection

Connection to higher level BMS is possible via Daikin compatible interface, DEC101/102A55.

### IV. Economizer

Field installed economizer is supplied from factory as an accessory. It is also designed to cater for horizontal or vertical down throw air discharge orientation.

### V. CO2 Sensor

Field specified CO2 sensor can be easily plug on the control board's dry contact, which is come as standard.

## 2 Selection procedure

### Calculation Steps

Interpolation method can be used to get the total capacity, TC and sensible capacity, SC and power input, PI at those temperatures which are not stated out in the table. Extrapolation method are not allowed to be used to get the TC, SC and PI.

#### Example:

**Model:** UATYQ450BY1

**Indoor Condition:** 25°C DB, 17°C WB

**Outdoor Condition:** 37°C DB

**Fan Speed:** High (5650CFM)

#### Solution:

#### Overall

Based on the Performance Table

1. Refer to the Indoor DB column,
  - **25°C** is located between 24°C and 27°C for 16°CWB (Thus, Interpolation need to be applied)
  - **25°C** is located between 24°C and 27°C for 19°CWB (Thus, Interpolation need to be applied)
2. Refer to the Indoor WB column,
  - **17°C** is located between 16°CWB and 19°CWB for 25°CDB (Thus, Interpolation need to be applied)
3. Refer to the Outdoor DB column,
  - **37°C** is located between 35°C and 40°C. (Thus, Interpolation need to be applied)

Please follow the steps below in order to get the required capacity.

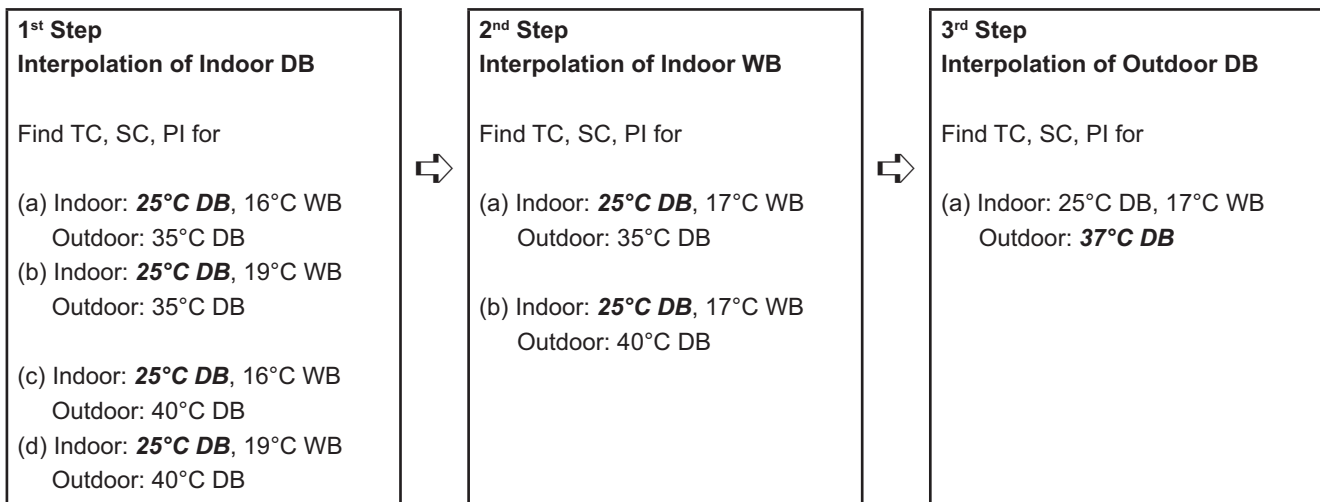

## 2 Selection procedure

**Details:**

**1<sup>st</sup> Step:**

To obtain the Total capacity and Sensible capacity and Power input for

**(a) Indoor Condition: 25°C DB, 16°C WB**

**Outdoor Condition: 35°C DB**

Indoor WB °C	Indoor DB °C	Outdoor DB, °C		
		35		
		TC (kW)	SHC (kW)	PI (kW)
16	24	41.41	35.59	12.81
	25	.....	$X_1$	$Y_1$
	27	43.48	41.63	12.94

Total capacity, TC

Interpolation Method:

$$\Rightarrow \frac{27^\circ\text{C} - 24^\circ\text{C}}{27^\circ\text{C} - 25^\circ\text{C}} = \frac{43.48\text{kW} - 41.41\text{kW}}{43.48\text{kW} - x_1\text{kW}}$$

$$\Rightarrow x_1 = 42.10\text{kW}$$

Sensible capacity, SHC

Interpolation Method:

$$\Rightarrow \frac{27^\circ\text{C} - 24^\circ\text{C}}{27^\circ\text{C} - 25^\circ\text{C}} = \frac{41.63\text{kW} - 35.59\text{kW}}{43.48\text{kW} - x_1\text{kW}}$$

$$\Rightarrow y_1 = 37.60\text{kW}$$

Power Input, PI

Interpolation Method:

$$\Rightarrow \frac{27^\circ\text{C} - 24^\circ\text{C}}{27^\circ\text{C} - 25^\circ\text{C}} = \frac{12.94\text{kW} - 12.81\text{kW}}{12.94\text{kW} - z_1\text{kW}}$$

$$\Rightarrow z_1 = 12.85\text{kW}$$



## 2 Selection procedure

**(b) Indoor Condition: 25°C DB, 16°C WB**

**Outdoor Condition: 40°C DB**

Indoor WB °C	Indoor DB °C	Outdoor DB, °C			
		40			
		TC (kW)	SHC (kW)	PI (kW)	
16	24	38.59	33.52	13.91	
	25	.....	$X_2$	$Y_2$	$Z_2$
	27	40.74	39.20	14.06	

Total capacity, TC

Interpolation Method:

$$\Rightarrow \frac{27^\circ \text{C} - 24^\circ \text{C}}{27^\circ \text{C} - 25^\circ \text{C}} = \frac{43.48\text{kW} - 41.41\text{kW}}{40.74\text{kW} - x_2\text{kW}}$$

$$\Rightarrow x_2 = 39.31\text{kW}$$

Sensible capacity, SHC

Interpolation Method:

$$\Rightarrow \frac{27^\circ \text{C} - 24^\circ \text{C}}{27^\circ \text{C} - 25^\circ \text{C}} = \frac{39.20\text{kW} - 33.52\text{kW}}{39.20\text{kW} - y_2\text{kW}}$$

$$\Rightarrow y_2 = 35.41\text{kW}$$

Power Input, PI

Interpolation Method:

$$\Rightarrow \frac{27^\circ \text{C} - 24^\circ \text{C}}{27^\circ \text{C} - 25^\circ \text{C}} = \frac{14.06\text{kW} - 13.91\text{kW}}{14.06\text{kW} - z_2\text{kW}}$$

$$\Rightarrow z_2 = 13.96\text{kW}$$

\* Repeat process (a) and (b) in 1st step for the condition below:

**(c) Indoor Condition: 25°C DB, 19°C WB**

**Outdoor Condition: 35°C DB**

$$\Rightarrow x_3 = 44.55\text{kW}$$

$$\Rightarrow y_3 = 31.63\text{kW}$$

$$\Rightarrow z_3 = 13.03\text{kW}$$

**(c) Indoor Condition: 25°C DB, 19°C WB**

**Outdoor Condition: 40°C DB**

$$\Rightarrow x_4 = 41.46\text{kW}$$

$$\Rightarrow y_4 = 31.63\text{kW}$$

$$\Rightarrow z_4 = 14.13\text{kW}$$

## 2 Selection procedure

### 2<sup>nd</sup> Step:

To obtain the Total capacity, Sensible capacity and Power Input for

**(a) Indoor Condition: 25°C DB, 17°C WB**

**Outdoor Condition: 35°C DB**

Indoor WB °C	Indoor DB °C	Outdoor DB, °C			
		35			
		TC (kW)	SHC (kW)	PI (kW)	
		⋮	⋮		
16	25	42.10	37.60	12.85	
17		.....	$X_s$	$Y_s$	$Z_s$
19		44.55	31.63	13.03	

#### Total capacity, TC

Interpolation Method:

$$\Rightarrow \frac{19^\circ\text{C} - 16^\circ\text{C}}{19^\circ\text{C} - 17^\circ\text{C}} = \frac{44.55\text{kW} - 42.10\text{kW}}{44.55\text{kW} - x_s\text{kW}}$$

$$\Rightarrow x_s = 42.92\text{kW}$$

#### Sensible capacity, SHC

Interpolation Method:

$$\Rightarrow \frac{19^\circ\text{C} - 16^\circ\text{C}}{19^\circ\text{C} - 17^\circ\text{C}} = \frac{31.63\text{kW} - 37.60\text{kW}}{31.63\text{kW} - y_s\text{kW}}$$

$$\Rightarrow y_s = 35.61\text{kW}$$

#### Power Input, PI

Interpolation Method:

$$\Rightarrow \frac{19^\circ\text{C} - 16^\circ\text{C}}{19^\circ\text{C} - 17^\circ\text{C}} = \frac{13.03\text{kW} - 12.85\text{kW}}{13.03\text{kW} - z_s\text{kW}}$$

$$\Rightarrow z_s = 12.91\text{kW}$$

## 2 Selection procedure

(b) Indoor Condition: 25°C DB, 17°C WB

Outdoor Condition: 40°C DB

Indoor WB °C	Indoor DB °C	Outdoor DB, °C			
		40			
		TC (kW)	SHC (kW)	PI (kW)	
		⋮	⋮		
16	25	39.31	35.41		13.96
17		.....	X <sub>6</sub>	Y <sub>6</sub>	Z <sub>6</sub>
19			41.46	29.99	

Total capacity, TC

Interpolation Method:

$$\Rightarrow \frac{19^\circ\text{C} - 16^\circ\text{C}}{19^\circ\text{C} - 17^\circ\text{C}} = \frac{41.46\text{kW} - 39.31\text{kW}}{41.46\text{kW} - x_6\text{kW}}$$

$$\Rightarrow x_6 = 40.03\text{kW}$$

Sensible capacity, SHC

Interpolation Method:

$$\Rightarrow \frac{19^\circ\text{C} - 16^\circ\text{C}}{19^\circ\text{C} - 17^\circ\text{C}} = \frac{29.99\text{kW} - 35.41\text{kW}}{29.99\text{kW} - y_6\text{kW}}$$

$$\Rightarrow y_6 = 33.60\text{kW}$$

Power Input, PI

Interpolation Method:

$$\Rightarrow \frac{19^\circ\text{C} - 16^\circ\text{C}}{19^\circ\text{C} - 17^\circ\text{C}} = \frac{14.13\text{kW} - 13.96\text{kW}}{14.13\text{kW} - z_6\text{kW}}$$

$$\Rightarrow z_6 = 14.02\text{kW}$$

## 2 Selection procedure

### 3<sup>rd</sup> Step:

To obtain the Total capacity and Sensible capacity for

**(a) Indoor Condition:** 25°C DB, 17°C WB

**Outdoor Condition:** 37°C DB

Indoor WB °C	Indoor DB °C	Outdoor DB, °C									
			35			35			40		
			TC (kW)	SHC (kW)	PI (kW)	TC (kW)	SHC (kW)	PI (kW)	TC (kW)	SHC (kW)	PI (kW)
25	17	.....	42.92	35.61	12.61	x	y	z	40.03	33.60	14.02

#### Total capacity, TC

Interpolation Method:

$$\Rightarrow \frac{40^{\circ}\text{C} - 35^{\circ}\text{C}}{40^{\circ}\text{C} - 37^{\circ}\text{C}} = \frac{40.03\text{kW} - 42.92\text{kW}}{40.03\text{kW} - x\text{kW}}$$

$$\Rightarrow x = 41.76\text{kW}$$

#### Sensible capacity, SHC

Interpolation Method:

$$\Rightarrow \frac{40^{\circ}\text{C} - 35^{\circ}\text{C}}{40^{\circ}\text{C} - 37^{\circ}\text{C}} = \frac{33.60\text{kW} - 35.61\text{kW}}{33.60\text{kW} - y\text{kW}}$$

$$\Rightarrow y = 34.81\text{kW}$$

#### Power Input, PI

Interpolation Method:

$$\Rightarrow \frac{40^{\circ}\text{C} - 35^{\circ}\text{C}}{40^{\circ}\text{C} - 37^{\circ}\text{C}} = \frac{14.02\text{kW} - 12.91\text{kW}}{14.02\text{kW} - z\text{kW}}$$

$$\Rightarrow z = 13.35\text{kW}$$

### 3 Features

- Easy to install 'plug and play' concept plus single installation configuration; no additional piping is required since indoor and outdoor sides are pre-connected
- High efficiency and reliable scroll compressor
- Wide operating range
- Flat top unit design allows maximum use of warehouse and container space
- Free cooling and fresh air intake possible with optional economiser
- Convertible return and supply air: fan can be mounted in two directions
- Factory pre-charged refrigerant ensures clean and efficient operation
- Belt driven fan enables air volume and static pressure to be adjusted as required.
- Adjustable fan pulley as standard to meet a wide range of supply air volumes and external static pressures
- Anti-corrosion treated coil



## 4 Specifications

4-1 Technical Specifications				UATYQ250MCY1	UATYQ350MCY1	UATYQ450MCY1	UATYQ550MCY1	UATYQ600MCY1	UATYQ700MCY1		
Cooling capacity	Nom.	kW		27.340 (3)	35.580 (3)	44.720 (3)	55.690.000 (3)	66.820 (3)	72.600 (3)		
		Btu/h		93,300 (4)	121,400 (4)	152,600 (4)	190,000 (4)	228,000 (4)	247,700 (4)		
Heating capacity	Nom.	kW		24.910 (3)	34.790 (3)	41.790 (3)	53.930 (3)	61.690 (3)	69.610 (3)		
		Btu/h		85,000 (4)	118,700 (4)	142,600 (4)	184,000 (4)	210,500 (4)	237,500 (4)		
Power input	Cooling	Nom.	kW	8.140	10.780	13.040	16.740	19.650	21.610		
	Heating	Nom.	kW	7.330	10.840	12.860	15.540	18.580	21.420		
EER				3.36	3.30	3.43	3.33	3.40	3.36		
COP				3.40	3.21	3.25	3.47	3.32	3.25		
Evaporator	Control	Air discharge		Ducted							
		Operation		Wired							
	Air flow rate	Cooling	m <sup>3</sup> /min	-							
	External static pressure		Pa	147			206				
Evaporator piping connections	Condensation drain size	OD	mm	25.4							
Condenser	Dimensions	Unit	Height	mm	1,150	1,028	1,130	1,048	1,302	1,454	
			Width	mm	1,638	2,209					
			Depth	mm	2,063	2,113			2,670		
		Packing	Height	mm	1,345	1,223	1,325	1,252	1,506	1,674	
			Width	mm	2,321	2,372	2,304				
			Depth	mm	1,758	2,304	2,372	2,929			
	Weight	Unit	kg	445	580	610	780	830	970		
	Casing	Colour		Light grey							
		Material		Electro-galvanised mild steel							
	Air flow rate	Cooling	cfm	8,230	12,000	12,100	12,900	20,200	21,200		
	Compressor	Quantity		1	2						
		Motor	Type	Scroll							
	Operation range	Cooling	Min.	°CDB	-						
Max.			°CDB	-							
Sound power level	Nom.	dBA	82	83		87	90				
Refrigerant	Type		R-410A								
	Charge	kg	6.1	5.8	7.2	8.7	10.4	11.6			
	Control		Electronic expansion valve								
	Circuits	Quantity	1	2							
Safety devices	Item	01	High pressure switch								
		02	Low pressure switch								
		03	Phase sequencer								
		04	Discharge thermostat setting								

4-2 Electrical Specifications				UATYQ250MCY1	UATYQ350MCY1	UATYQ450MCY1	UATYQ550MCY1	UATYQ600MCY1	UATYQ700MCY1
Power supply	Name		Y1						
	Phase		3~						
	Frequency	Hz	50						
	Voltage		V	380-415					
Current	Nominal running current (RLA)	Cooling	A	16.6	21.2	28.3	30.2	33.8	39.0
		Heating	A	14.8	20.8	26.9	28.8	32.3	40.2

### Notes

- (1) All specifications are subjected to change by the manufacturer without prior notice.
- (2) All units are being tested and comply to ISO5151.
- (3) Cooling: indoor temp. 27°CDB, 19°CWB; outdoor temp. 35°CDB, 24°CWB
- (4) Heating: indoor temp. 20°CDB; outdoor temp. 7°CDB, 6°CWB
- (5) Sound pressure levels are measured according to JIS B 8616 standard
- (6) All performance calculations are strictly according to Eurovent standard

# 5 Nomenclature

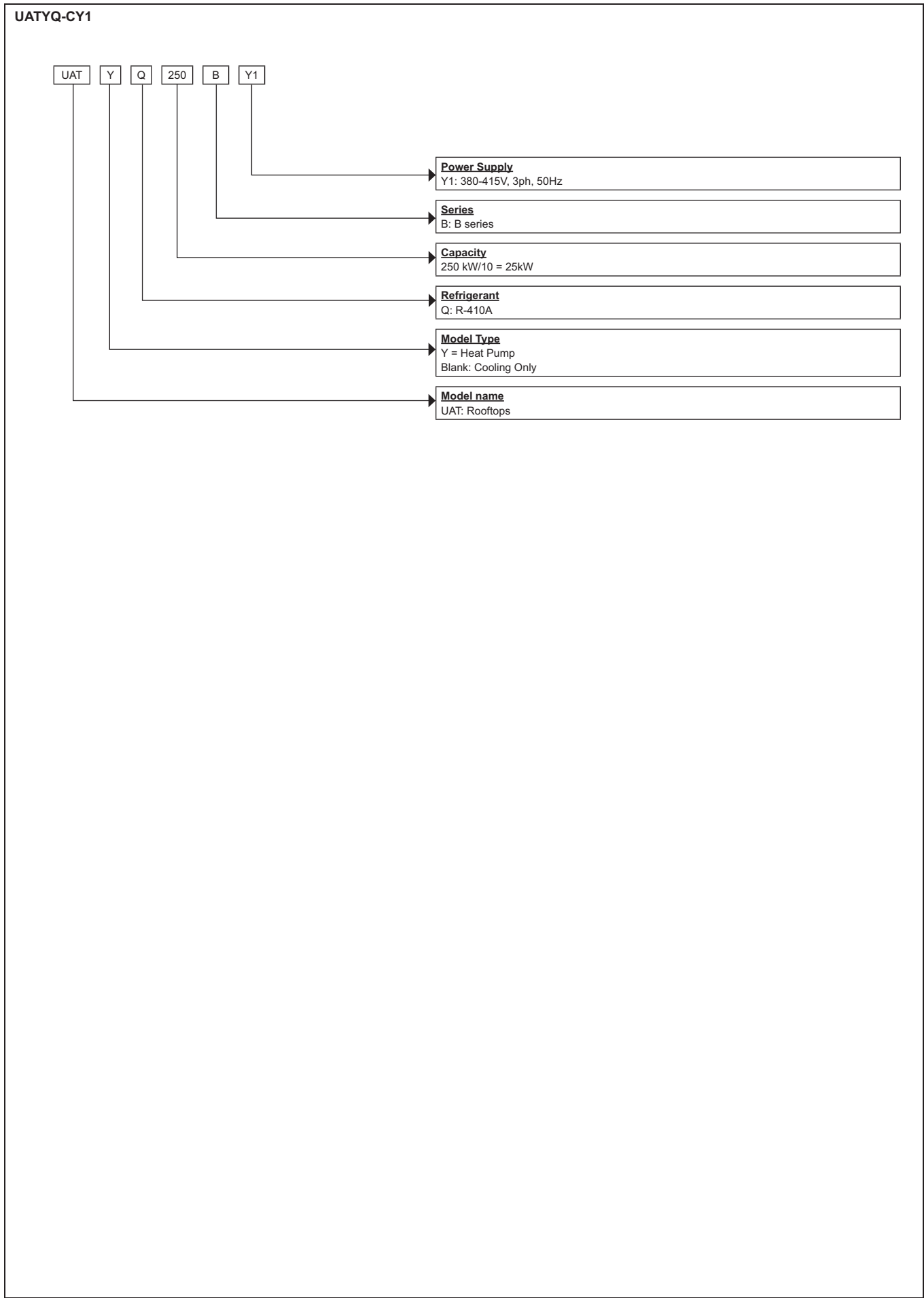

## 6 Safety device settings

### UATYQ250-350CY1

Model			UATYQ250CY1	UATYQ350CY1
Safety device	High pressure switch	Type	NC, Auto Reset	
		Open	kPa/psi	4137 / 600
		Close	kPa/psi	3309 / 480
	Low pressure switch	Type	NC, Auto Reset	
		Open	kPa/psi	124 / 18
		Close	kPa/psi	193 / 28
	Phase sequencer			YES
Discharge thermostat setting		°C/°F	120 / 248	

### UATYQ450-550CY1

Model			UATYQ450CY1	UATYQ550CY1
Safety device	High pressure switch	Type	NC, Auto Reset	
		Open	kPa/psi	4137 / 600
		Close	kPa/psi	3309 / 480
	Low pressure switch	Type	NC, Auto Reset	
		Open	kPa/psi	124 / 18
		Close	kPa/psi	193 / 28
	Phase sequencer			YES
Discharge Thermostat setting		°C/°F	120 / 248	



## 6 Safety device settings

### UATYQ600-700CY1

Model			UATYQ600CY1	UATYQ700CY1
Safety device	High pressure switch	Type	NC, Auto Reset	
		Open	kPa/psi	4137 / 600
		Close	kPa/psi	3309 / 480
	Low pressure switch	Type	NC, Auto Reset	
		Open	kPa/psi	124 / 18
		Close	kPa/psi	193 / 28
	Phase sequencer		YES	
	Discharge thermostat setting		°C/°F	120 / 248

# 7 Options

## UATYQ-CY1

Model		Classification										
		Rooftop controller	PCB	EXV	Gold Fin (NA549)	Scroll compressor	Saranet Air Filter	Side flow	Convertible	Filter Drier	High pressure switch	Low pressure switch
UATYQ-BY1	250	X	X	X	X	X	X	X	X	X	X	X
	350	X	X	X	X	X	X	X	X	X	X	X
	450	X	X	X	X	X	X	X	X	X	X	X
	550	X	X	X	X	X	X	X	X	X	X	X
	600	X	X	X	X	X	X	X	X	X	X	X
	700	X	X	X	X	X	X	X	X	X	X	X

Remarks: Economizers & CO2 sensor will be ready soon.















## 8 Capacity tables

### 8 - 2 Capacity tables heating

#### UATYQ250CY1

Indoor DB, °C	Outdoor WB, °C									
	-5		6		12		15		18	
	TC (kW)	PI (kW)	TC (kW)	PI (kW)	TC (kW)	PI (kW)	TC (kW)	PI (kW)	TC (kW)	PI (kW)
15	17.71	5.41	24.99	6.49	28.96	7.08	30.95	7.38	32.93	7.67
17	17.23	5.64	24.96	6.77	28.12	7.39	30.04	7.70	31.96	8.01
19	16.75	5.87	24.93	7.05	27.27	7.70	29.12	8.02	30.98	8.34
51	16.27	6.09	24.31	7.33	26.42	8.00	28.21	8.34	30.00	8.68
23	15.79	6.32	23.10	7.61	25.57	8.31	27.30	8.66	29.03	9.01
25	15.31	6.55	21.89	7.89	24.73	8.62	26.39	8.98	28.05	9.35
27	14.83	6.78	20.69	8.17	23.88	8.92	25.48	9.30	27.08	9.68

#### UATYQ350CY1

Indoor DB, °C	Outdoor WB, °C									
	-5		6		12		15		18	
	TC (kW)	PI (kW)	TC (kW)	PI (kW)	TC (kW)	PI (kW)	TC (kW)	PI (kW)	TC (kW)	PI (kW)
15	24.73	7.83	34.90	9.40	40.44	10.25	43.21	10.68	45.99	11.11
17	24.23	8.18	34.86	9.88	40.18	10.80	42.99	11.27	45.80	11.73
19	23.74	8.53	34.81	10.36	39.91	11.36	42.76	11.86	45.61	12.35
51	23.24	8.88	34.51	10.84	39.64	11.91	42.53	12.44	45.43	12.98
23	22.74	9.23	33.94	11.32	39.37	12.46	42.31	13.03	45.24	13.60
25	22.25	9.58	33.37	11.80	39.11	13.01	42.08	13.62	45.06	14.22
27	21.75	9.93	32.81	12.28	38.84	13.57	41.85	14.21	44.87	14.85

#### NOTES - Hinweise - Σημειώσεις - Notas - Remarques - Note - Aantekeningen - Примечания - Notlar

TC = Total Cooling Capacity (kW) - Gesamte Kühlleistung (kW) - Συνολική απόδοση ψύξης (kW) - Capacidad de refrigeración total (kW) - Puissance totale de refroidissement (kW) - Capacità di raffreddamento totale (kW) - Totaal koelvermogen (kW) - Общая охлаждающая способность (kW) - Toplam soğutma kapasitesi (kW)

PI = Power Input (kW) - Leistungsaufnahme (kW) - Είσοδος ισχύος (kW) - Consumo (kW) - Puissance absorbée (kW) - Potenza assorbita (kW) - Vermogeninput (kW) - Потребляемая мощность (kW) - Güç girişi (kW)

#### UATYQ450CY1

Indoor DB, °C	Outdoor WB, °C									
	-5		6		12		15		18	
	TC (kW)	PI (kW)	TC (kW)	PI (kW)	TC (kW)	PI (kW)	TC (kW)	PI (kW)	TC (kW)	PI (kW)
15	29.71	9.55	41.92	11.46	48.58	12.50	51.92	13.02	55.25	13.54
17	29.15	9.94	41.87	11.92	48.43	13.00	51.83	13.55	55.24	14.09
19	28.58	10.34	41.82	12.39	48.28	13.51	51.75	14.07	55.23	14.63
51	28.01	10.73	41.56	12.86	48.12	14.02	51.67	14.60	55.22	15.18
23	27.45	11.13	41.08	13.33	47.97	14.53	51.59	15.13	55.21	15.73
25	26.88	11.52	40.61	13.80	47.82	15.04	51.51	15.66	55.21	16.28
27	26.32	11.92	40.13	14.26	47.67	15.54	51.43	16.18	55.20	16.82

#### UATYQ550CY1

Indoor DB, °C	Outdoor WB, °C									
	-5		6		12		15		18	
	TC (kW)	PI (kW)	TC (kW)	PI (kW)	TC (kW)	PI (kW)	TC (kW)	PI (kW)	TC (kW)	PI (kW)
15	38.34	11.76	54.09	14.11	62.69	15.39	66.99	16.03	71.28	16.67
17	37.53	12.22	54.03	14.58	62.09	15.88	66.42	16.52	70.76	17.17
19	36.72	12.68	53.96	15.06	61.49	16.36	65.86	17.01	70.23	17.66
51	35.92	13.14	53.38	15.54	60.89	16.85	65.29	17.51	69.70	18.16
23	35.11	13.60	52.27	16.02	60.29	17.34	64.73	18.00	69.17	18.66
25	34.30	14.06	51.16	16.49	59.69	17.82	64.17	18.49	68.64	19.15
27	33.50	14.52	50.05	16.97	59.09	18.31	63.60	18.98	68.12	19.65

#### NOTES - Hinweise - Σημειώσεις - Notas - Remarques - Note - Aantekeningen - Примечания - Notlar

TC = Total Cooling Capacity (kW) - Gesamte Kühlleistung (kW) - Συνολική απόδοση ψύξης (kW) - Capacidad de refrigeración total (kW) - Puissance totale de refroidissement (kW) - Capacità di raffreddamento totale (kW) - Totaal koelvermogen (kW) - Общая охлаждающая способность (kW) - Toplam soğutma kapasitesi (kW)

PI = Power Input (kW) - Leistungsaufnahme (kW) - Είσοδος ισχύος (kW) - Consumo (kW) - Puissance absorbée (kW) - Potenza assorbita (kW) - Vermogeninput (kW) - Потребляемая мощность (kW) - Güç girişi (kW)

## 8 Capacity tables

### 8 - 2 Capacity tables heating

#### UATYQ600CY1

Indoor DB, °C	Outdoor WB, °C									
	-5		6		12		15		18	
	TC (kW)	PI (kW)	TC (kW)	PI (kW)	TC (kW)	PI (kW)	TC (kW)	PI (kW)	TC (kW)	PI (kW)
15	43.85	14.19	61.88	17.03	71.71	18.58	76.63	19.36	81.55	20.13
17	42.61	14.83	61.81	17.91	69.37	19.58	74.10	20.42	78.82	21.26
19	41.38	15.47	61.73	18.78	67.04	20.59	71.56	21.49	76.09	22.39
51	40.14	16.10	60.05	19.65	64.70	21.59	69.03	22.55	73.36	23.52
23	38.90	16.73	56.76	20.52	62.36	22.59	66.50	23.62	70.64	24.65
25	37.67	17.37	53.47	21.39	60.02	23.59	63.96	24.69	67.91	25.79
27	36.43	18.00	50.18	22.27	57.68	24.59	61.43	25.75	65.18	26.92

#### UATYQ700CY1

Indoor DB, °C	Outdoor WB, °C									
	-5		6		12		15		18	
	TC (kW)	PI (kW)	TC (kW)	PI (kW)	TC (kW)	PI (kW)	TC (kW)	PI (kW)	TC (kW)	PI (kW)
15	49.48	13.42	69.82	16.11	80.91	17.57	86.46	18.30	92.00	19.03
17	48.43	14.02	69.73	16.93	80.08	18.52	85.67	19.31	91.26	20.10
19	47.38	14.63	69.65	17.76	79.26	19.46	84.88	20.32	90.51	21.17
51	46.32	15.22	68.86	18.58	78.43	20.41	84.09	21.33	89.76	22.24
23	45.27	15.82	67.37	19.40	77.60	21.36	83.31	22.33	89.01	23.31
25	44.22	16.42	65.87	20.23	76.77	22.31	82.52	23.34	88.26	24.38
27	43.17	17.02	64.38	21.05	75.95	23.25	81.73	24.35	87.52	25.45

#### NOTES - Hinweise - Σημειώσεις - Notas - Remarques - Note - Aantekeningen - Примечания - Notlar

TC = Total Cooling Capacity (kW) - Gesamte Kühlleistung (kW) - Συνολική απόδοση ψύξης (kW) - Capacidad de refrigeración total (kW) - Puissance totale de refroidissement (kW) - Capacità di raffreddamento totale (kW) - Totaal koelvermogen (kW) - Общая охлаждающая способность (kW) - Toplam soğutma kapasitesi (kW)

PI = Power Input (kW) - Leistungsaufnahme (kW) - Είσοδος ισχύος (kW) - Consumo (kW) - Puissance absorbée (kW) - Potenza assorbita (kW) - Vermogeninput (kW) - Потребляемая мощность (kW) - Güç girişi (kW)

# 8 Capacity tables

## 8 - 3 Capacity Correction Factor

### Performance Adjustment

#### - Performance Adjustment

Performance of the unit will derate when it operates with fresh air mode and this condition depends on user's selection. Before installation, it is recommended to check the correction factor table (table 1) below in order to do a correct design selection. Noted that it has different factor used for different selection of fresh air opening, in both cool mode and heat mode.

Table 1: Correction factor for unit's performance.

Rooftop Model	Economiser Kit Model	Operation Mode	Fresh Air Opening (%)					
			0	5	10	15	20	25
UATYQ Series	ECONO Series	Cooling	1.00	0.97	0.93	0.90	0.86	0.80
		Heating	1.00	0.97	0.93	0.90	0.87	0.83

#### - Pressure Drop Table

Airflow resistance refers to pressure drop caused by the economiser kit. Before installation, it is recommended to check the pressure drop in table 2 below in order to do a correct design selection.

Table 2: Pressure drop in economiser kit

Rooftop Model	Economiser Kit Model	Standard Airflow Rate		Maximum Pressure Drop in Economiser Kit							
				Side Return (Horizontal) Application						Down Return (Vertical) Application	
		Cfm		Fresh Air Mode						Economiser Mode	Fresh Air Mode or Economiser Mode
				0% Outdoor Air Damper Opening (Pa)	5% Outdoor Air Damper Opening (Pa)	10% Outdoor Air Damper Opening (Pa)	15% Outdoor Air Damper Opening (Pa)	20% Outdoor Air Damper Opening (Pa)	25% Outdoor Air Damper Opening (Pa)		
UATYQ250	ECONO250	3300	1.56	0	3	5	10	13	15	20	0
UATYQ350	ECONO350	4300	2.03	0	5	10	13	20	30	40	0
UATYQ450	ECONO450	5650	2.67	0	7	21	38	53	58	68	0
UATYQ550	ECONO550	6700	3.16	0	15	30	50	60	65	70	0
UATYQ600	ECONO600	7300	3.45	0	20	37	52	58	61	65	0
UATYQ700	ECONO700	8300	3.92	0	5	10	13	20	32	42	15

Pressure drop in economiser kit from table 2 refers to initial resistance. An air filter that is installed in the rain hood of economiser will expose to outdoor environment and easily becomes dirty. Regular service is required for this filter (recommended at least once every two weeks). The final resistance shall not exceed the recommended value in table 3 below.

Table 3: Technical specifications for air filter in economiser rain hood.

Economiser Kit Model	Recommended Type	Quantity	Dimension (L x W x t)	* Initial Resistance (Pa)	Recommended Final Resistance
UATYQ250	Washable Saranet Filter	1	750 x 515 x 4	15	80
UATYQ350	Washable Saranet Filter	1	658 x 560 x 4	13	70
UATYQ450	Washable Saranet Filter	1	658 x 560 x 4	27	70
UATYQ550	Washable Saranet Filter	1	750 x 604 x 4	34	110
UATYQ600	Washable Saranet Filter	1	750 x 604 x 4	30	105
UATYQ700	Washable Saranet Filter	1	1088 x 690 x 4	16	110

Note: \* Initial resistance is rated based on 85% of outdoor air opening.

The resistance values mentioned in table 3 have been incorporated into pressure drop values in table 2.

Table 3 provides guidelines only on the service of filter. Thus, system sizing does not require to include these values into consideration.

#### Optional Air Filter

There is a 2" filter slot inside the unit. Optional filter (field supplied) is recommended as the second layer filtration since outdoor air damper opening may bring in dust and dirt. In order to ensure that final resistance of the filter not exceed recommended values, service the filter every 2 weeks or more frequent if necessary.

#### Limitation Of Economiser Kit In Thermostat Control

Thermostat control is used with third party controller and thus the setting temperature of specific application cannot be known. For this case, it is recommended to use remote controller to set the required setting temperature before the hardware setting for thermostat control is conducted. The minimum fresh air opening for fan mode in thermostat control operation shall follow the user's selection in hardware setting (Dip Switch 1 and Dip Switch 2), whichever is lower. Note: Refer to hardware setting guideline provided in part (v) under chapter 'control operation guide' in installation manual for mode selection.

#### Necessary For Pressure Relief

Presence of fresh air may cause building pressure rises and bring discomfort to the users. When necessary, it is recommended to install a relief damper or exhaust fan in the return air duct. The relief damper may be a gravity type or motorized type. It is used to maintain building pressurization by regulating the flow of relief air from the building. For most building, the maximum pressure is not to exceed 25Pa.

# 9 Dimensional drawings

## UATYQ250CY1

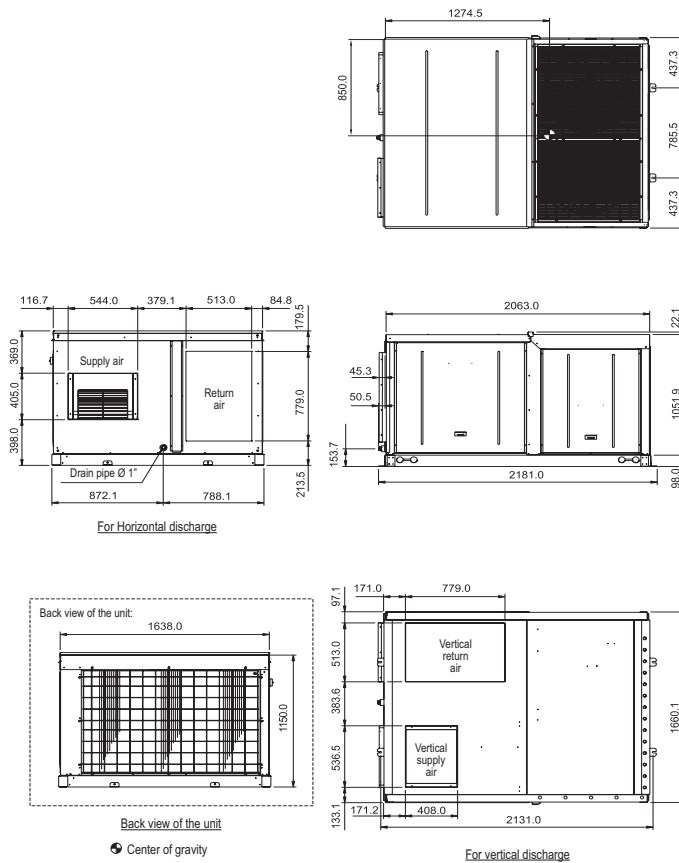

### NOTES

1 All dimensions are in mm

## UATYQ350CY1

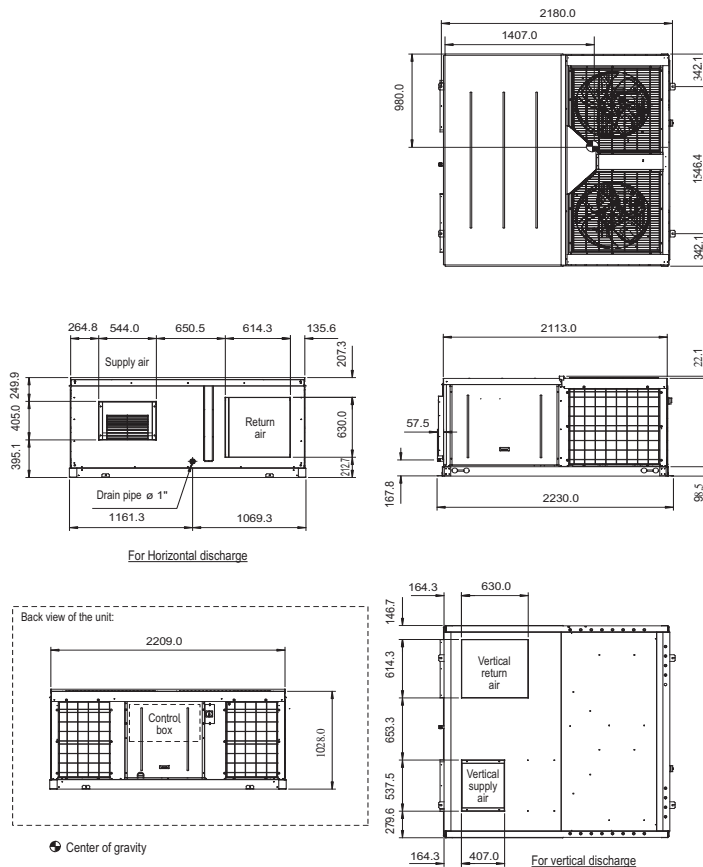

### NOTES

1 All dimensions are in mm

# 9 Dimensional drawings

## UATYQ450CY1

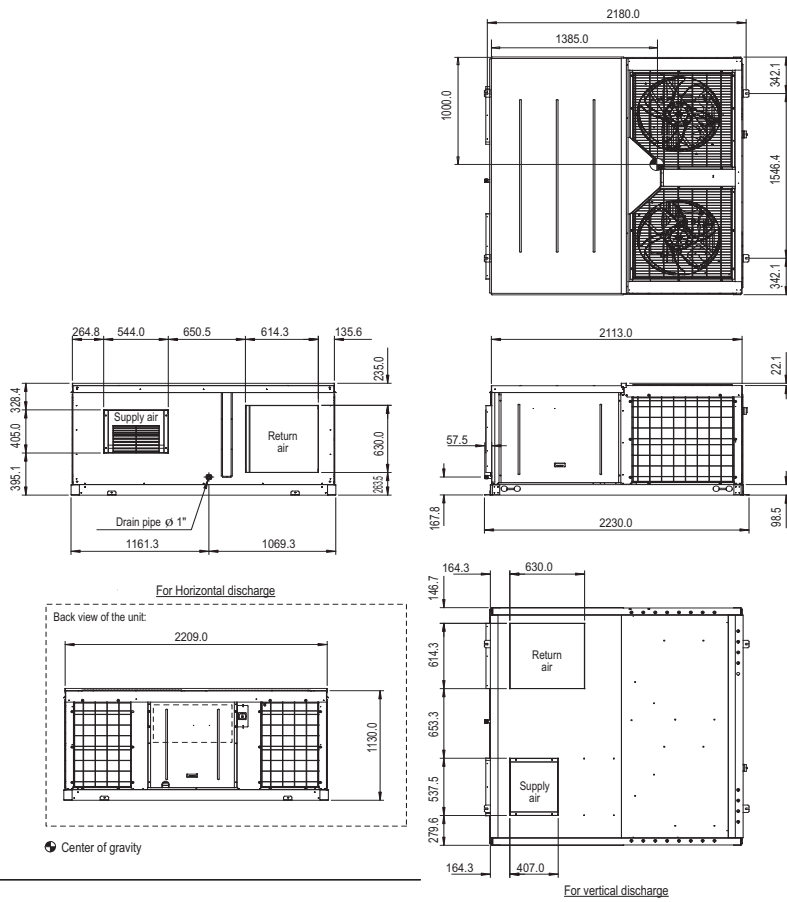

### NOTES

1 All dimensions are in mm

## UATYQ550,600,700CY1

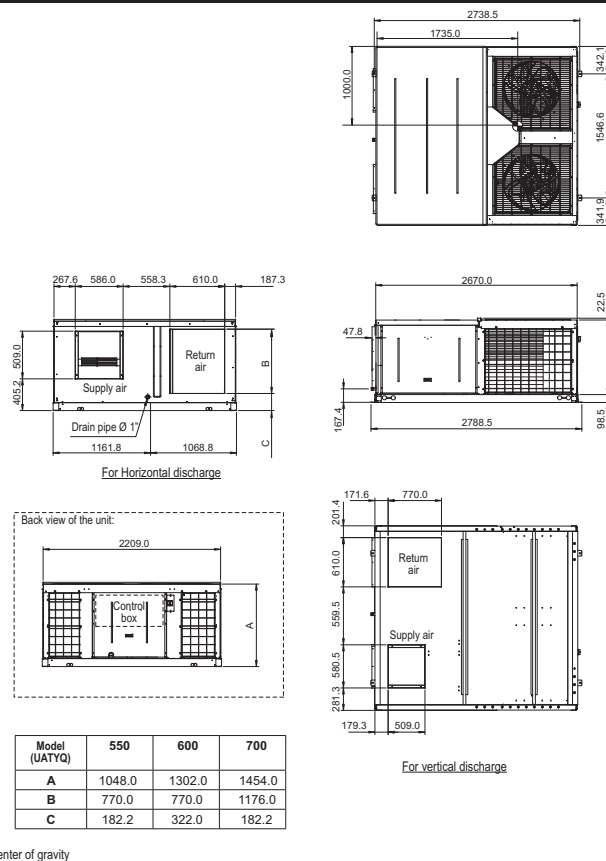

### NOTES

1 All dimensions are in mm

# 9 Dimensional drawings

## G Unit Conversion

In the case of converting standard unit to downthrow unit, follow the steps as stated below:  
**UATYQ250, 350, 450, 550, 600 & 700**

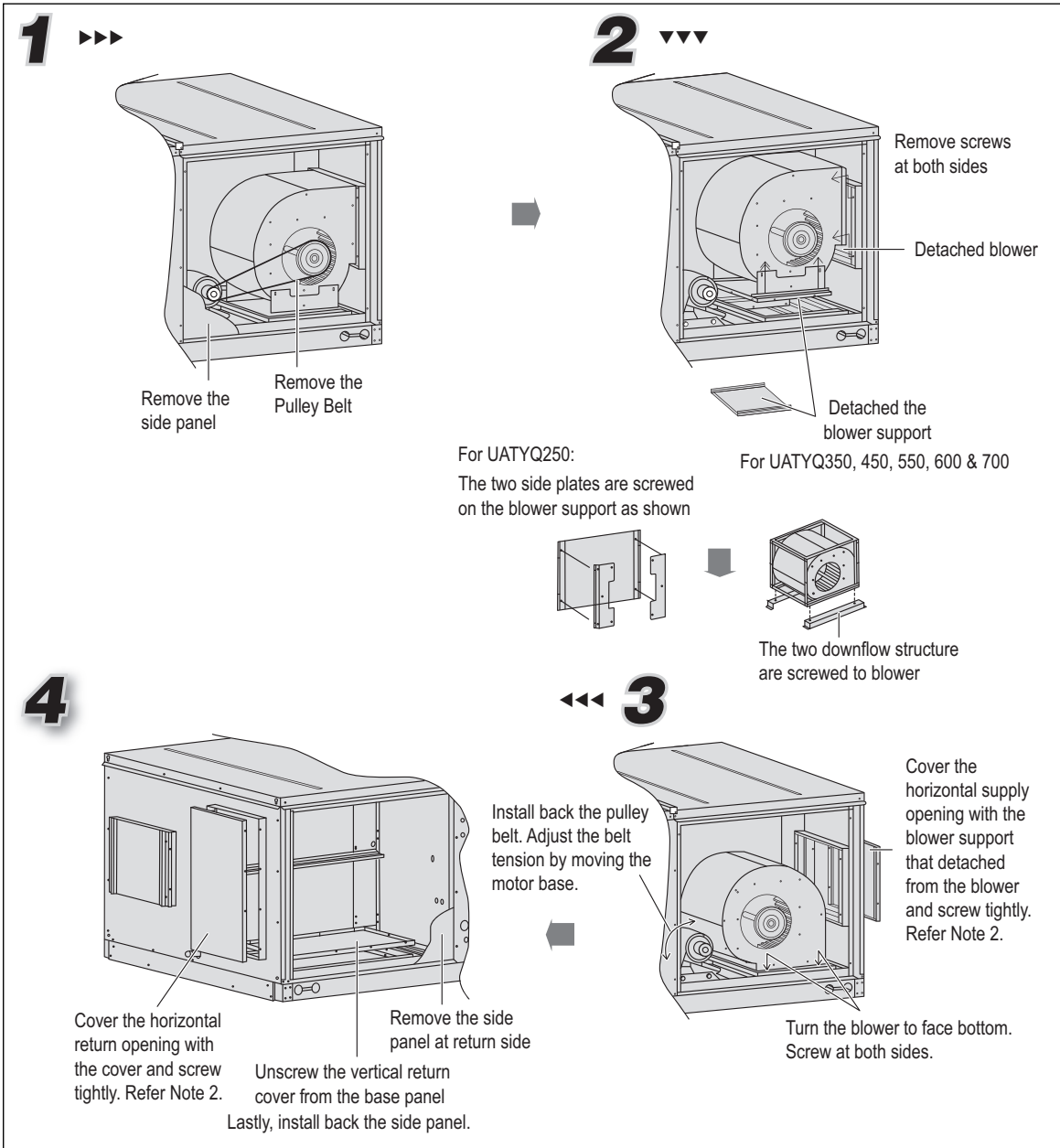

Install back the pulley belt. Adjust the belt tension. Lastly, install back the side panel. Refer Note 1.

### NOTE 1

For downthrow conversion, belt length need to be changed.  
 For unit with standard pulley, belt length = a mm  
 Shaft to shaft distance for downthrow, C-C = b mm

	UATYQ250	UATYQ350	UATYQ450	UATYQ550	UATYQ600	UATYQ700
<b>a</b>	1382	1357	1250	1382	1382	1382
<b>b</b>	375	388	375	445	445	435

### NOTE 1

Sealant such like gasket (field supply) shall be placed in between the metal cover and flange. Besides that, weather-proof silicone shall be applied on all the joints, screw holes and gaps to ensure water-tight condition.

### NOTE 1

Refer Engineering Data Book for blower curve and technical data of variable pitch pulley.

# 10 Piping diagram

UATYQ-CY1

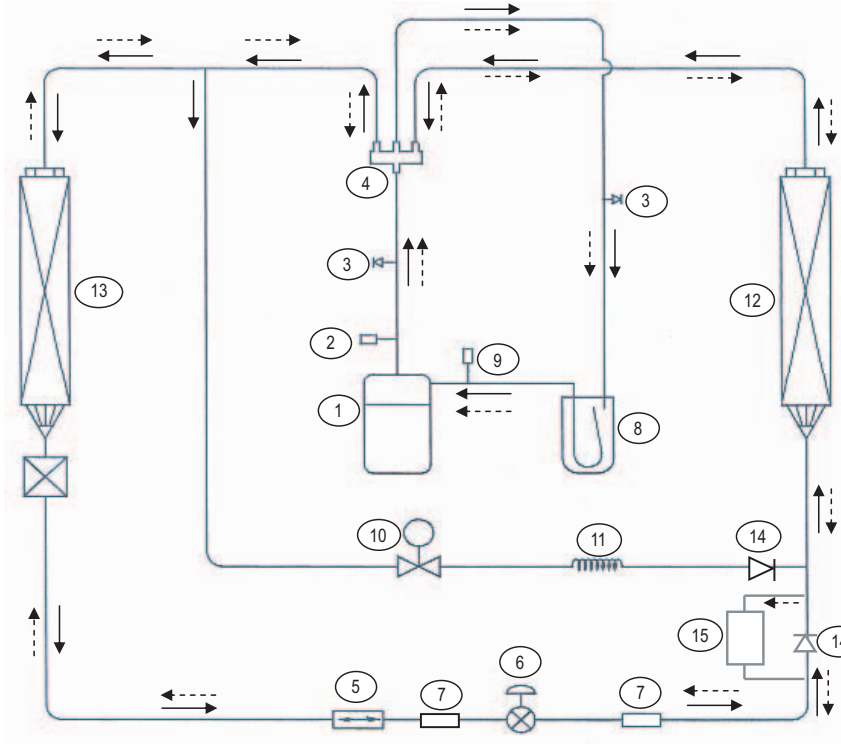

Item	Part's model / part no / size
1	Compressor
2	Pressure Switch 600PSI N/C
3	Access valve
4	4WV
5	Filter Drier
6	EXV
7	Strainer
8	Accumulator
9	Pressure Switch 18PSI N/C
10	Solenoid Valve
11	Bypass Capillary Tube
12	ID Coil
13	OD Coil
14	Check Valve
15	Compensator

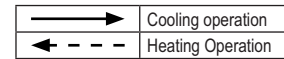

**NOTES**

- (a) UATYQ350,450,550BY1 consists of 2 circuits in the systems.
- (b) Item 15 is applicable for UATYQ350BY1 only.

# 11 Wiring diagrams

## 11 - 1 Wiring Diagrams - Three Phase

UATYQ250CY1

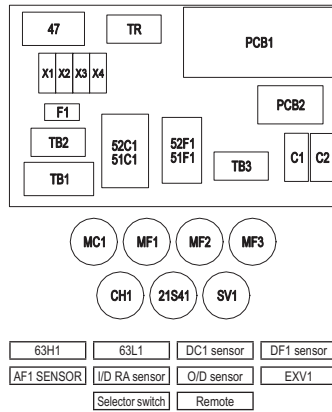
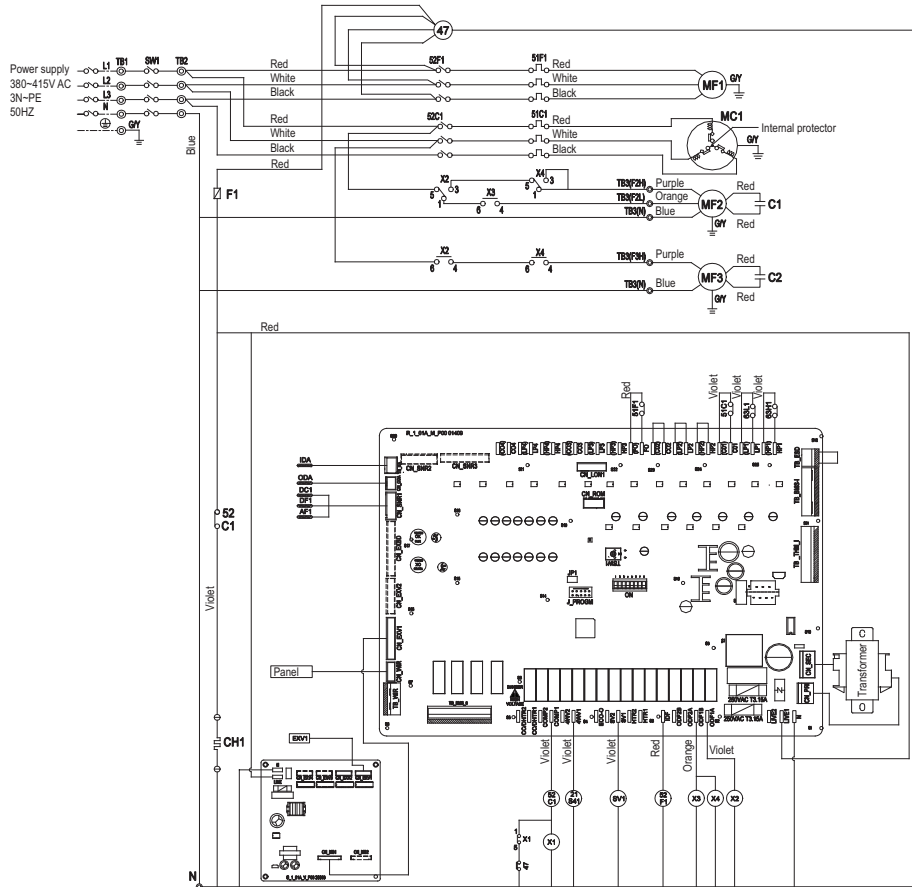

Symbol	Name
MC1/MC2	Compressor motor
MF1	Fan Motor (Indoor)
MF2,3	Fan Motor (Outdoor)
52C1/51C2	Contactors (Compressor)
TB 1,2,3,4	Terminal Block
F1	Fuse
51F1	Over current Relay (Fan I/D)
CH1/CH2	Crankcase Heater
47	Phase Protector
63H1/63H2	High Pressure Switch
63L1/63L2	Low Pressure Switch
C1, C2	Capacitor (O/D Fan Motor)
SV1/SW2	Solenoid Coil
21S41/21S42	4-Way Valve
X1,X2, X3, X4	Auxilliary Relays
SW1	Selector Switch
TR	Transformer 230V~24V
TB_RA	I/D Return Air Sensor
CN_ODA	O/D Air Sensor
CN_SNR1	Sensor DC1, DF1 & AF1
CN_SNR2	Sensor DC2, DF2 & AF2
CN_EXV1/CN_EXV2	Expansion Valve
CN_WIR	Panel Remote Control

0802 4 106498B

**NOTES**

1. The dotted lines show field wiring.
2. The figure in the parenthesis show field supply parts.
3. Color of earth wire is yellow and green twisting.
4. Specification subject to change without notice.

**CAUTION**

1. To protect Indoor Fan motor from abnormal current, Over Current Relay <51F>, is installed. Therefore, do not change factory set value of the Over Current Relay.



# 11 Wiring diagrams

## 11 - 1 Wiring Diagrams - Three Phase

UATYQ350-550CY1

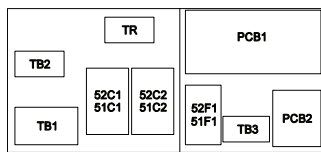
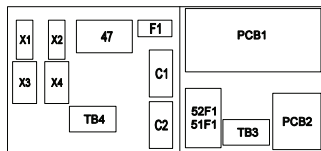
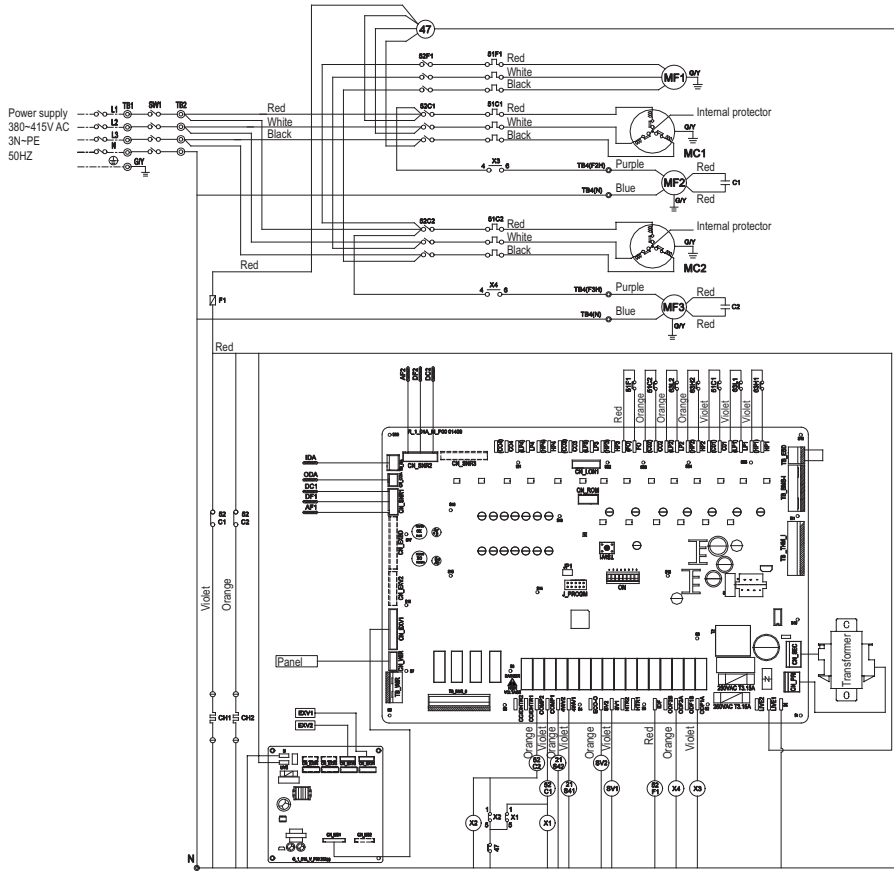

63H1	63L1	DC1 sensor	DF1 sensor
63H2	63L2	DC2 sensor	DF2 sensor
AF1 sensor	I/D RA sensor	I/D RA sensor	EXV1
AF2 sensor	Selector switch	Remote	EXV2

Symbol	Name
MC1/MC2	Compressor motor
MF1	Fan Motor (Indoor)
MF2,3	Fan Motor (Outdoor)
52C1/51C2	Contactora (Compressor)
52F1	Contactora (Fan I/D)
51C1/51C2	Over Current Relay (compressor)
TB 1,2,3,4	Terminal Block
F1	Fuse
51F1	Over current Relay (Fan I/D)
CH1/CH2	Crankcase Heater
47	Phase Protector
63H1/63H2	High Pressure Switch
63L1/63L2	Low Pressure Switch
C1, C2	Capacitor (O/D Fan Motor)
SV1/SV2	Solenoid Coil
21S41/21S42	4-Way Valve
X1,X2, X3, X4	Auxiliary Relays
SW1	Selector Switch
TR	Transformer 230V~24V
TB_RA	I/D Return Air Sensor
CN_ODA	O/D Air Sensor
CN_SNR1	Sensor DC1, DF1 & AF1
CN_SNR2	Sensor DC2, DF2 & AF2
CN_EXV1/CN_EXV2	Expansion Valve
CN_WIR	Panel Remote Control

0802 4 106505B

### NOTES

- The dotted lines show field wiring.
- The figure in the parenthesis show field supply parts.
- Color of earth wire is yellow and green twisting.
- Specification subject to change without notice.

### CAUTION

- To protect Indoor Fan motor from abnormal current, Over Current Relay <51F>, is installed. Therefore, do not change factory set value of the Over Current Relay.

# 11 Wiring diagrams

## 11 - 1 Wiring Diagrams - Three Phase

UATYQ600-700CY1

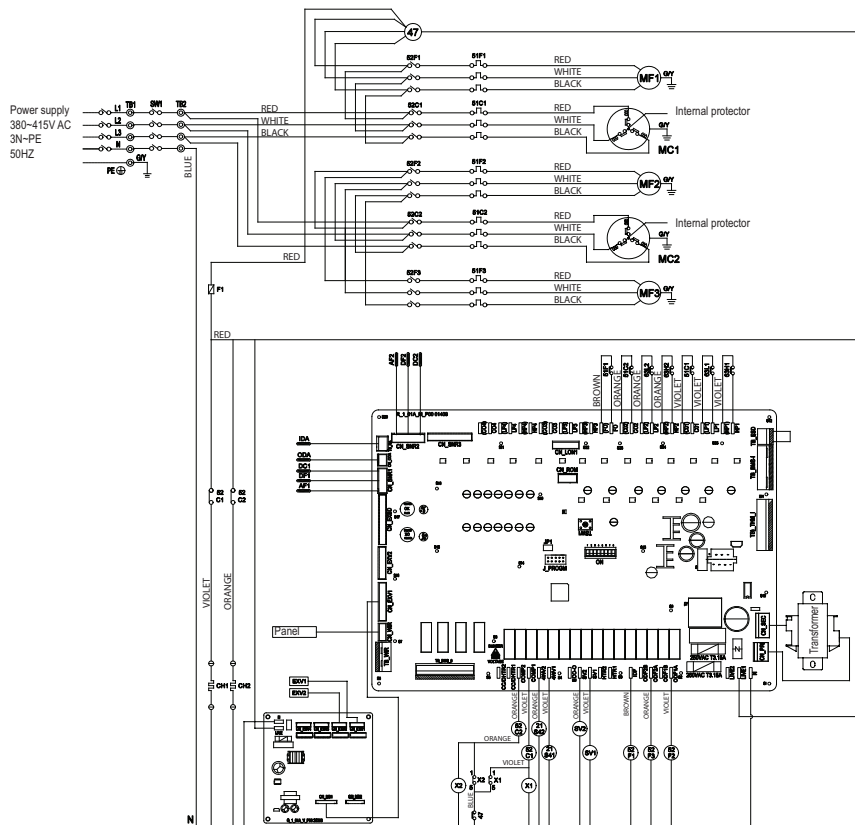

Arrangement

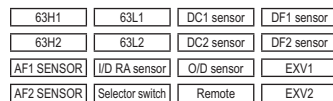
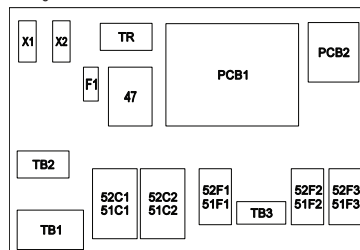

Colors

- RED : Red
- WHITE : White
- BLACK : Black
- VIOLET : Violet
- ORANGE : Orange
- BLUE : Blue

Symbol	Name
MC1/MC2	Compressor motor
MF1	Fan Motor (Indoor)
MF2,3	Fan Motor (Outdoor)
52C1/51C2	Contactora (Compressor)
52F1	Contactora (Fan I/D)
52F2/51F3	Contactora (Fan O/D)
51C1/51C2	Over Current Relay (Compressor)
TB 1,2,3,4	Terminal Block
F1	Fuse
51F1	Over current Relay (Fan I/D)
CH1/CH2	Crankcase Heater
47	Phase Protector
63H1/63H2	High Pressure Switch
63L1/63L2	Low Pressure Switch
SV1/SV2	Solenoid Coil
21S41/21S42	4-Way Valve
X1,X2	Auxilliary Relays
SW1	Selector switch
TR	Transformer 230V~24V
TB_RA	I/D Return Air Sensor
CN_ODA	O/D Air Sensor
CN_SNR1	Sensor DC1, DF1 & AF1
CN_SNR2	Sensor DC2, DF2 & AF2
CN_EXV1/CN_EXV2	Expansion Valve
CN_WIR	Panel Remote Control

0802 4 107686

NOTES

1. The dotted lines show field wiring.
2. The figure in the parenthesis show field supply parts.
3. Color of earth wire is yellow and green twisting.
4. Specification subject to change without notice.

CAUTION

1. To protect Indoor Fan motor from abnormal current, Over Current Relay <51F>, is installed. Therefore, do not change factory set value of the Over Current Relay.

# 11 Wiring diagrams

## 11 - 2 Wiring Diagrams - Single Phase

Arrangement of terminal blocks and components for controller are shown as below:

### A Control Module UATYQ250

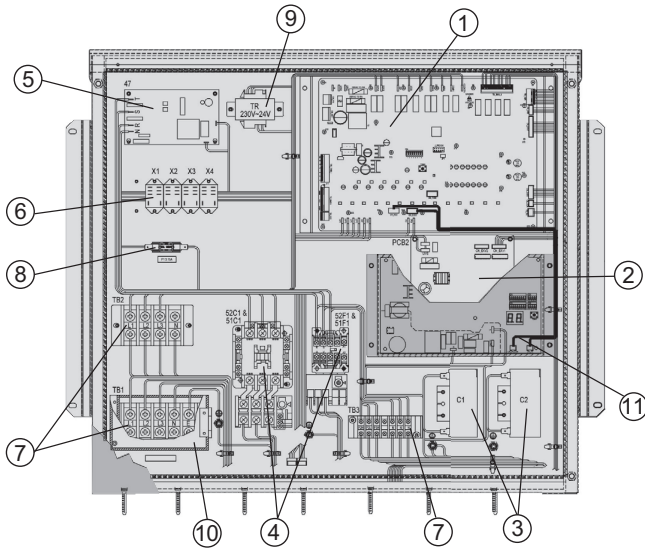

No.	Item Description
①	Controller Main Board
②	EXV Controller Board
③	Capacitor
④	Contactors
⑤	Phase Protector
⑥	Relay
⑦	Terminal Block
⑧	Fuse
⑨	Transformer
⑩	Terminal Block Cover
⑪	Economiser Controller Board

### B Control Module UATYQ350/450/550

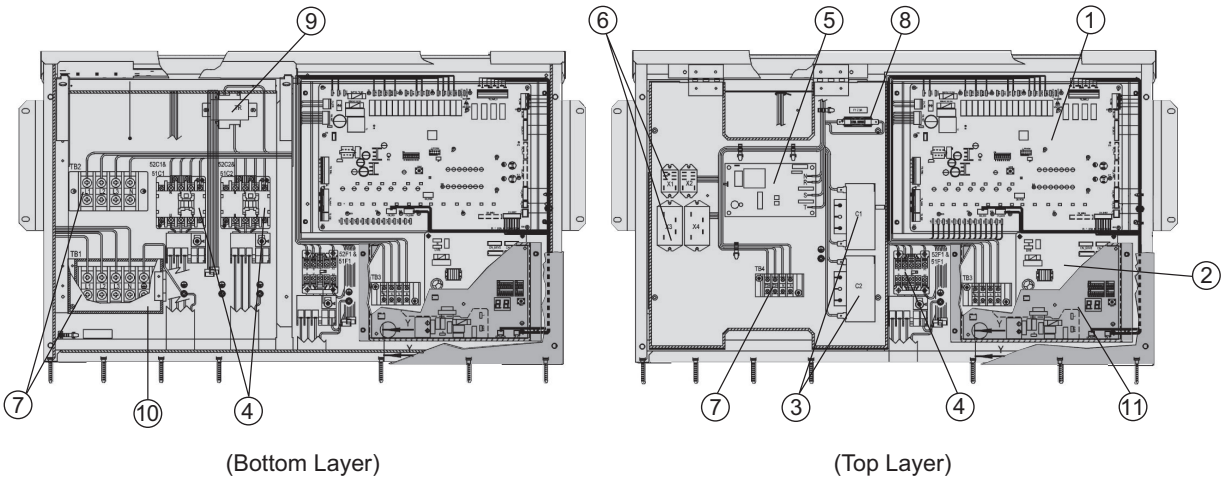

### C Control Module UATYQ600/700

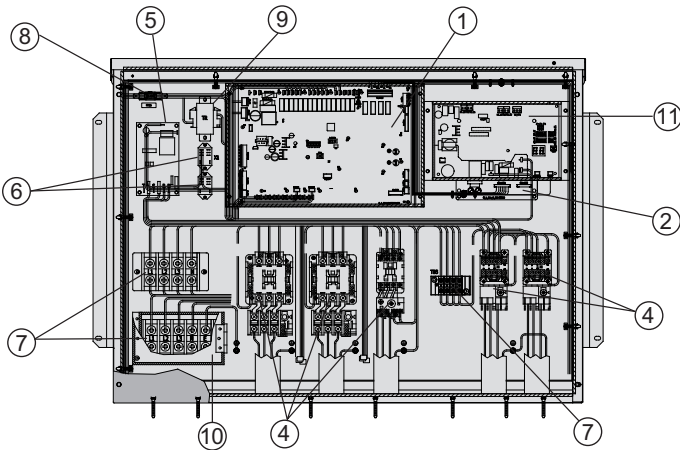

#### NOTES

Item 11 (Economiser Controller Board) shall be used together with the economiser kit which is provided separately as the accessory.

## 12 Sound data

### 12 - 1 Sound pressure spectrum

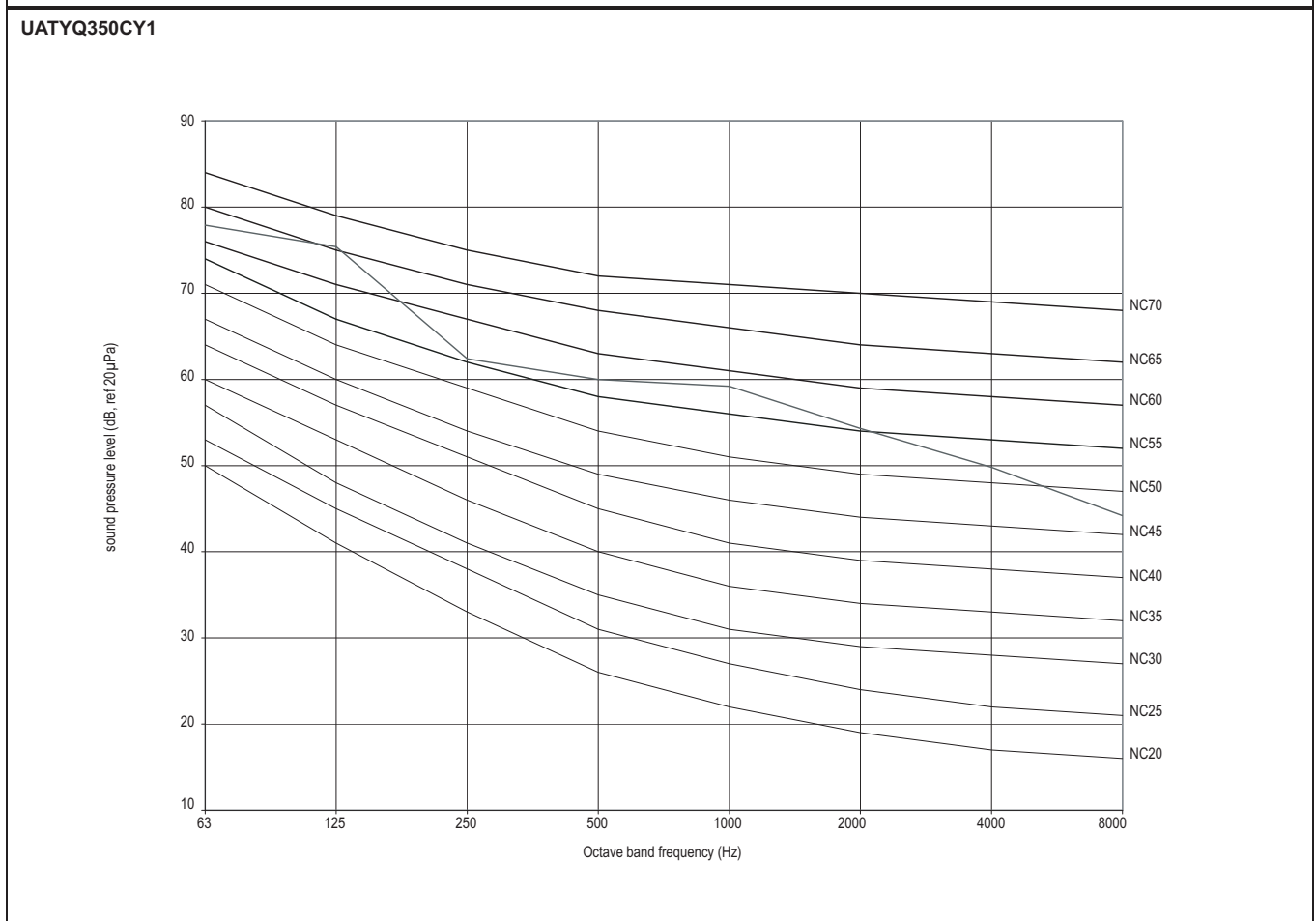
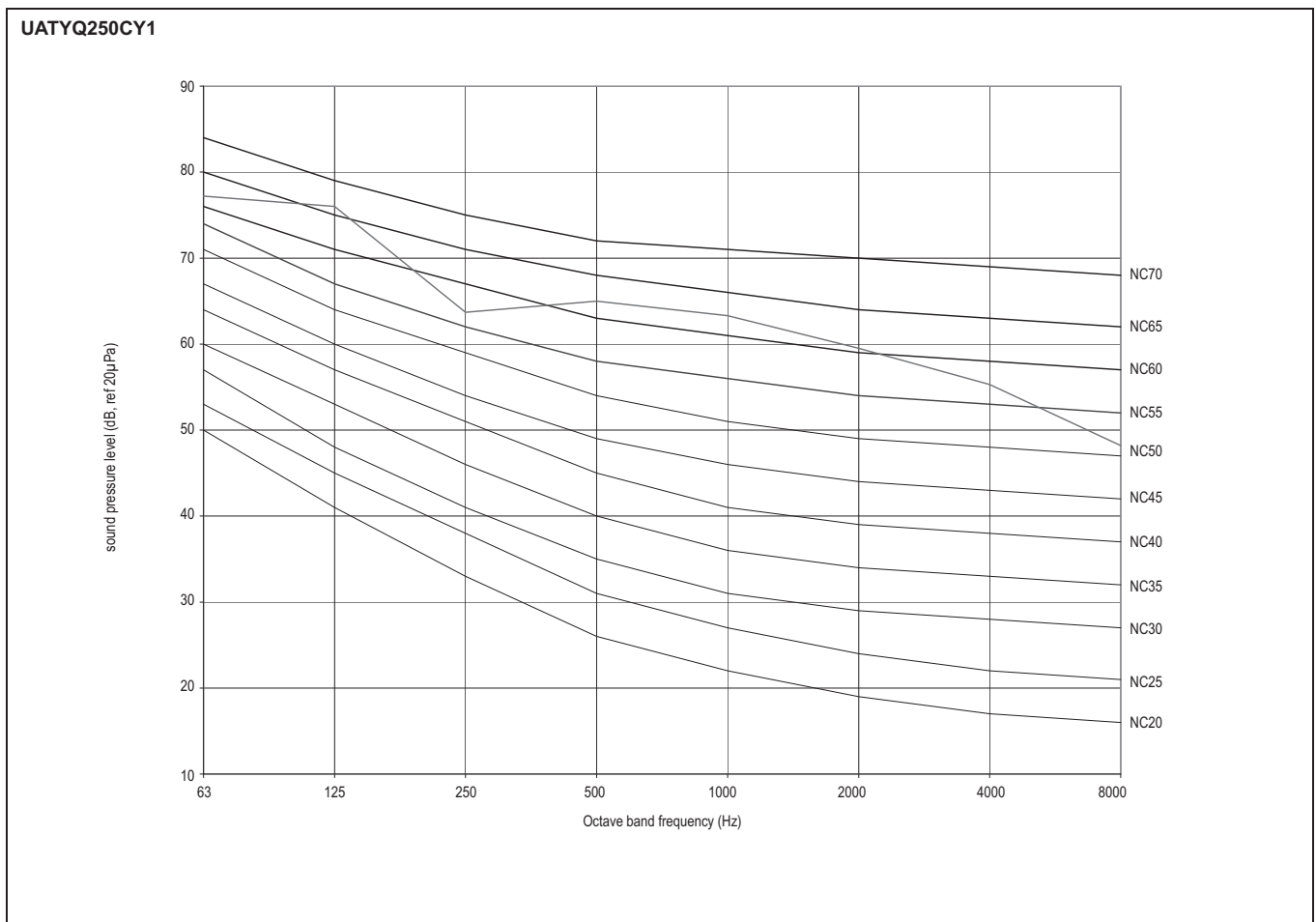

## 12 Sound data

### 12 - 1 Sound pressure spectrum

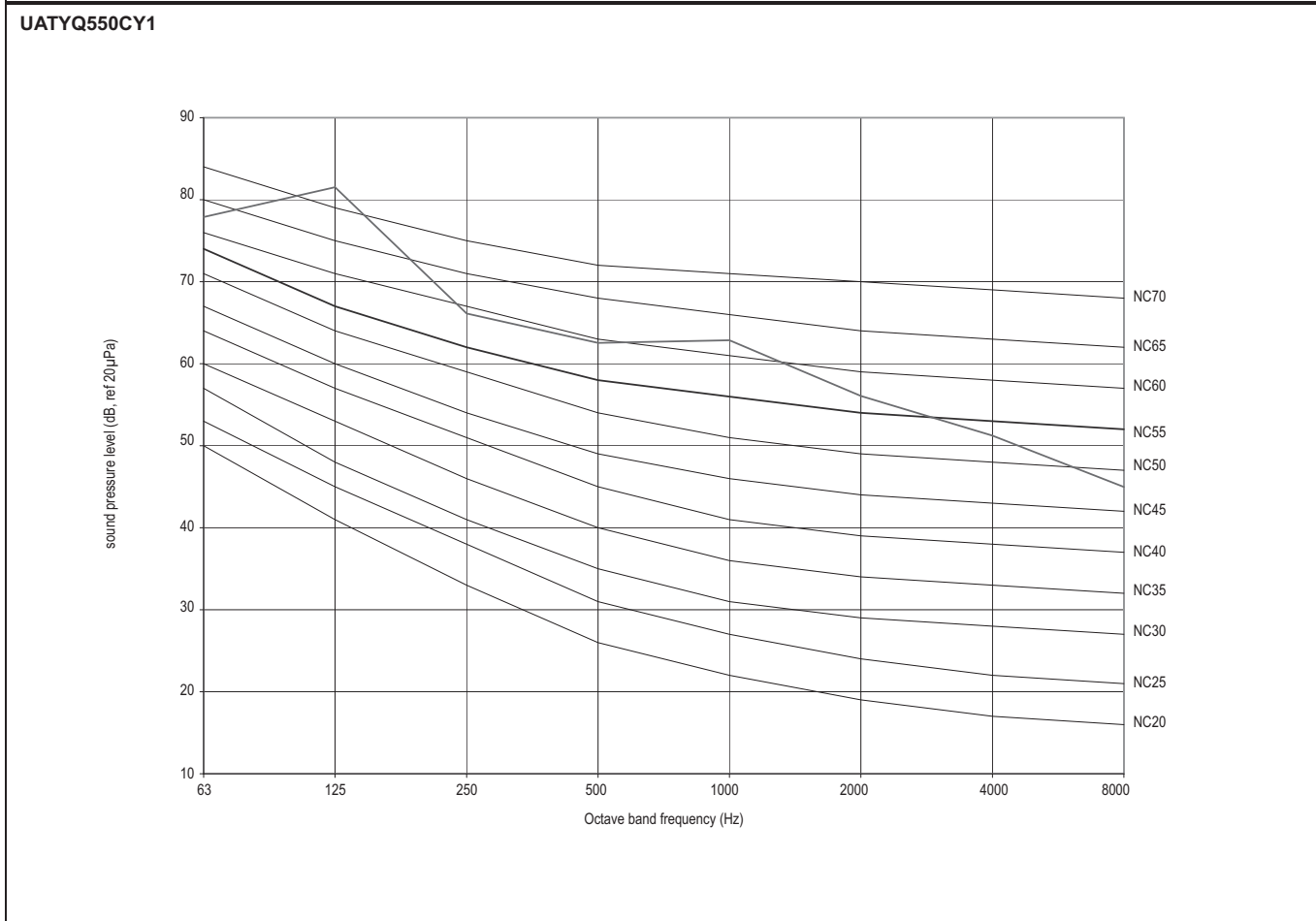
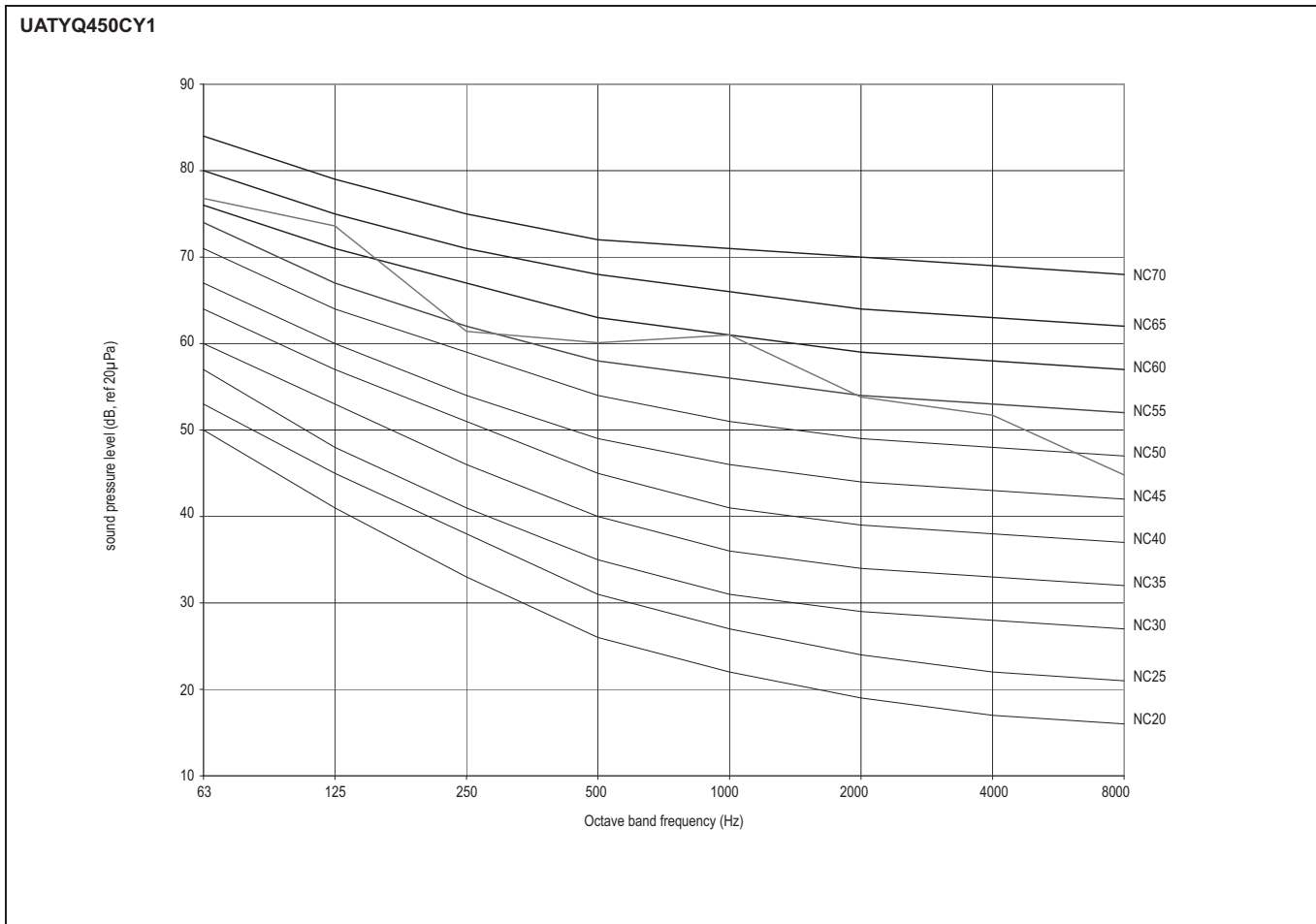

## 12 Sound data

### 12 - 1 Sound pressure spectrum

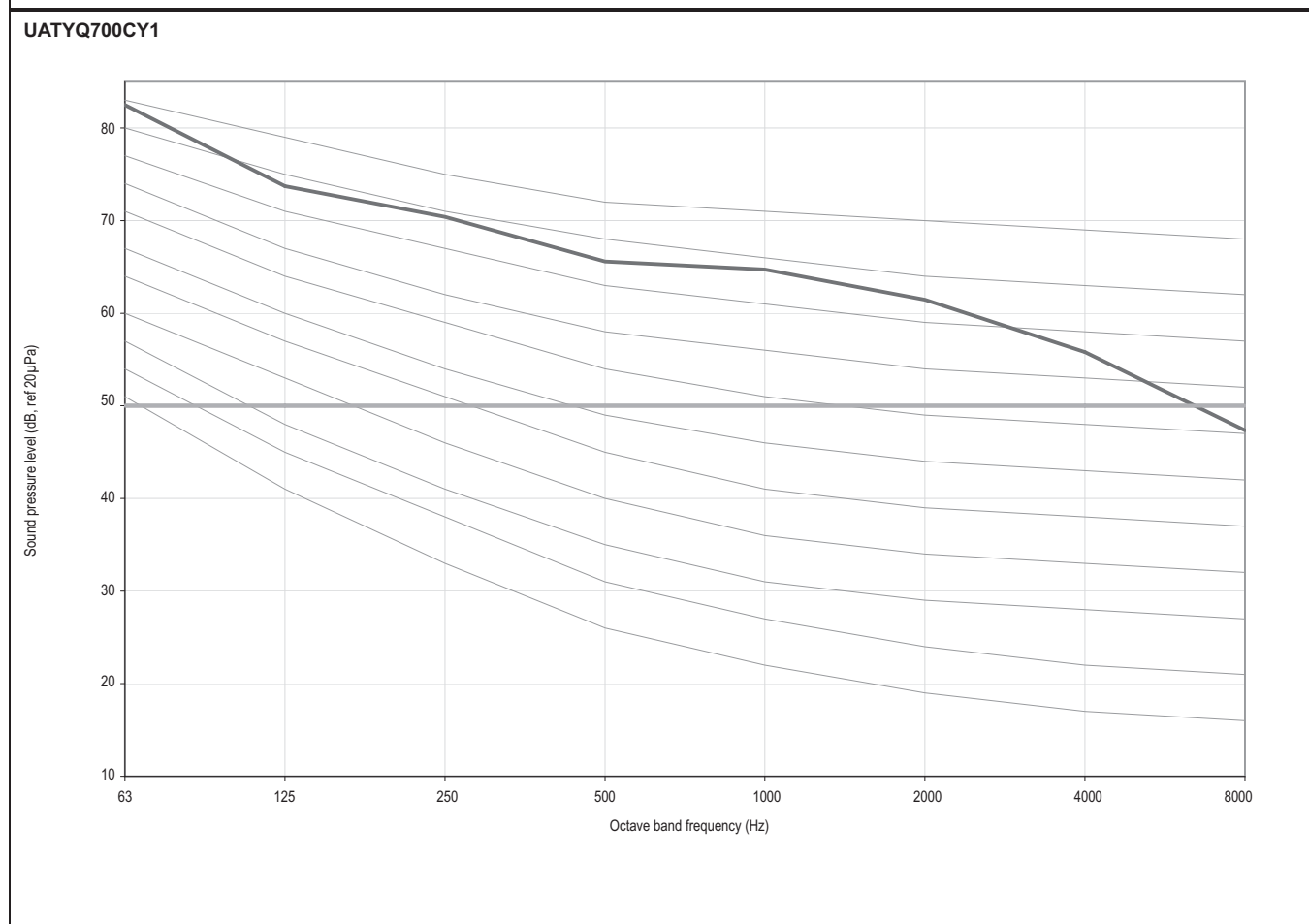
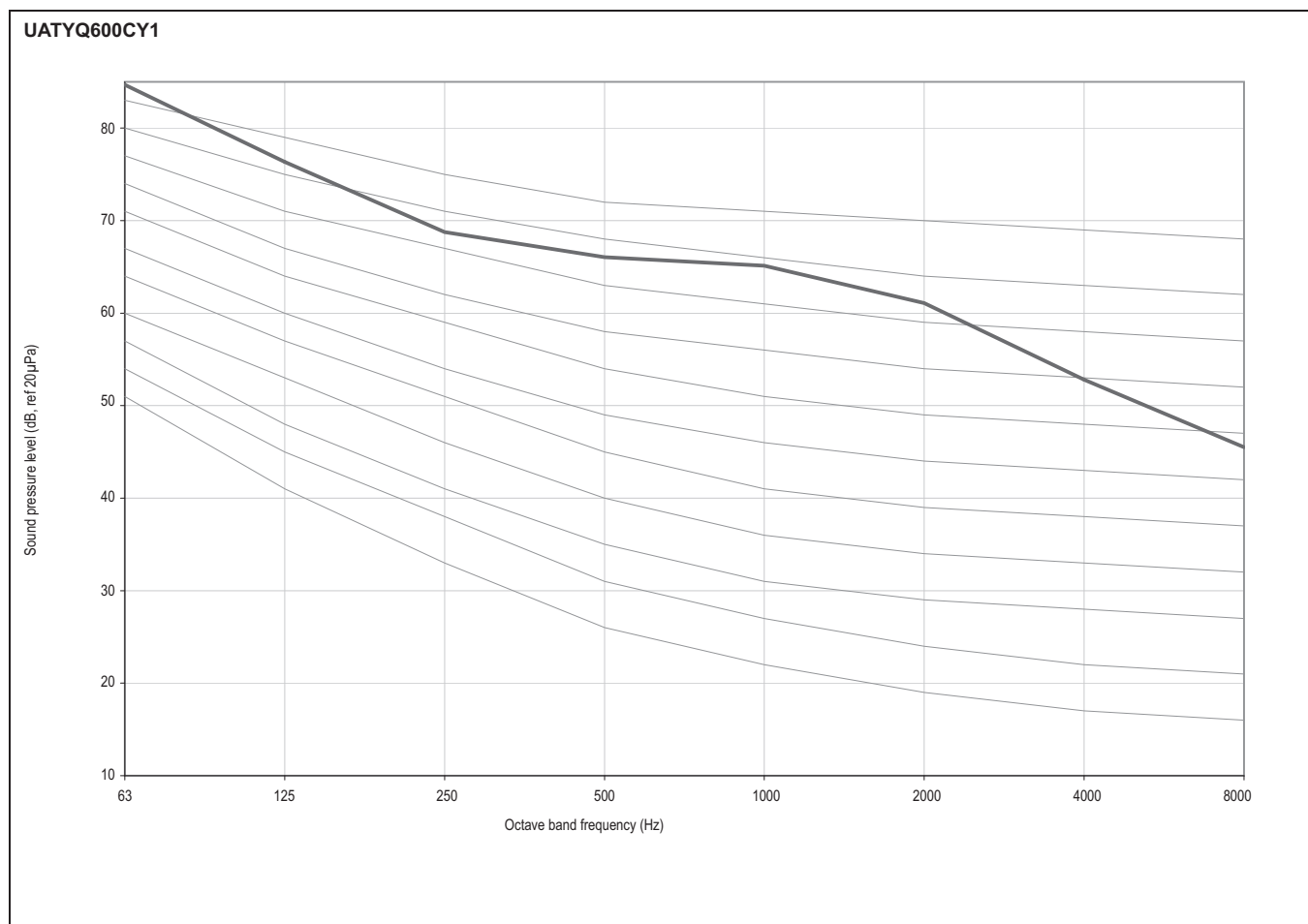

## 12 Sound data

### 12 - 2 Sound level data

#### UATYQ250-700CY1

Model	1/1 Octave Sound Pressure Level (dB, ref 20μPa)								Overall dB(A)	Noise Criteria (NC)
	63 Hz	125 Hz	250 Hz	500 Hz	1 kHz	2 kHz	4 kHz	8 kHz		
UATYQ250CY1	77	76	64	65	63	60	55	48	68	66
UATYQ350CY1	78	75	62	60	59	54	50	44	64	65
UATYQ450CY1	77	74	61	60	61	54	52	54	65	63
UATYQ550CY1	78	82	66	63	63	56	51	45	68	73
UATYQ600CY1	85	76	69	66	65	61	53	46	70	66
UATYQ700CY1	83	74	70	66	65	62	56	47	70	68

Model	1/1 Octave Sound Power Level (dB, ref 1pW)								Overall dB(A)
	63 Hz	125 Hz	250 Hz	500 Hz	1 kHz	2 kHz	4 kHz	8 kHz	
UATYQ250CY1	91	91	79	78	78	72	68	61	82
UATYQ350CY1	96	91	79	78	80	72	70	64	83
UATYQ450CY1	93	90	79	78	80	73	71	64	83
UATYQ550CY1	95	96	83	82	84	78	73	66	87
UATYQ600CY1	101	94	87	85	87	81	76	69	90
UATYQ700CY1	99	91	88	85	86	83	77	69	90

# 13 Fan characteristics

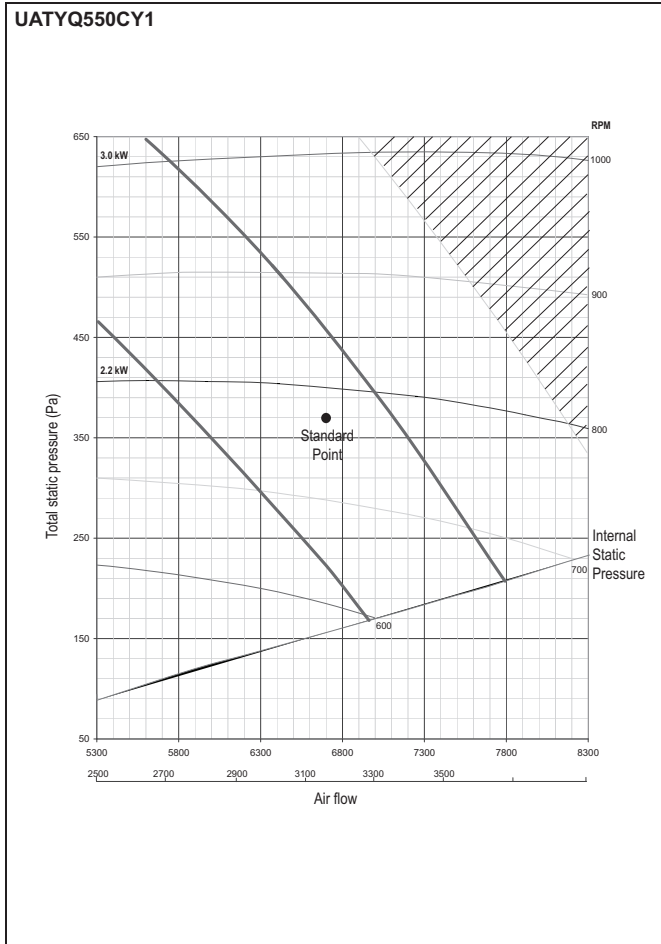
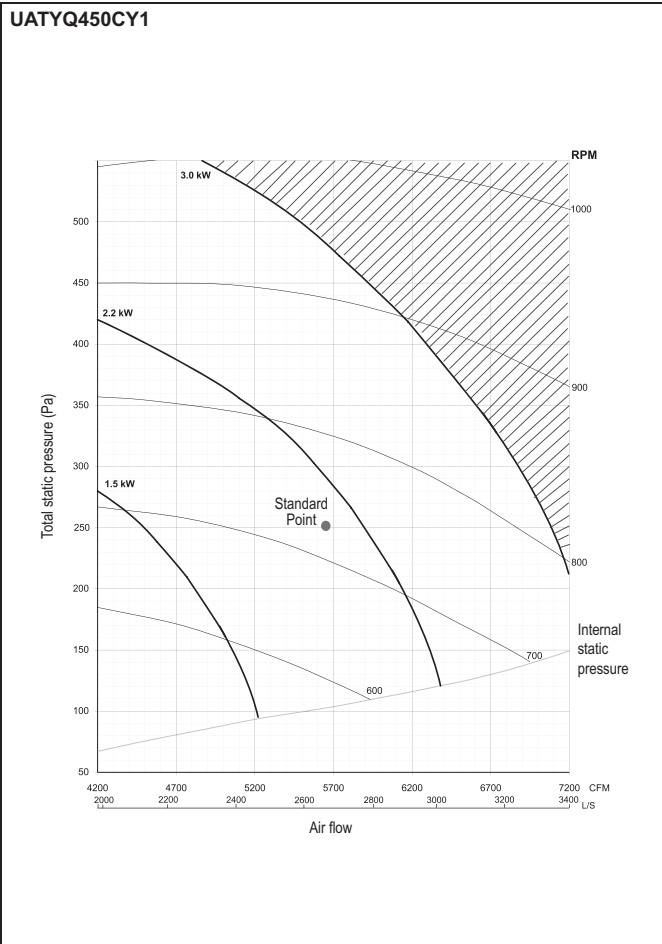
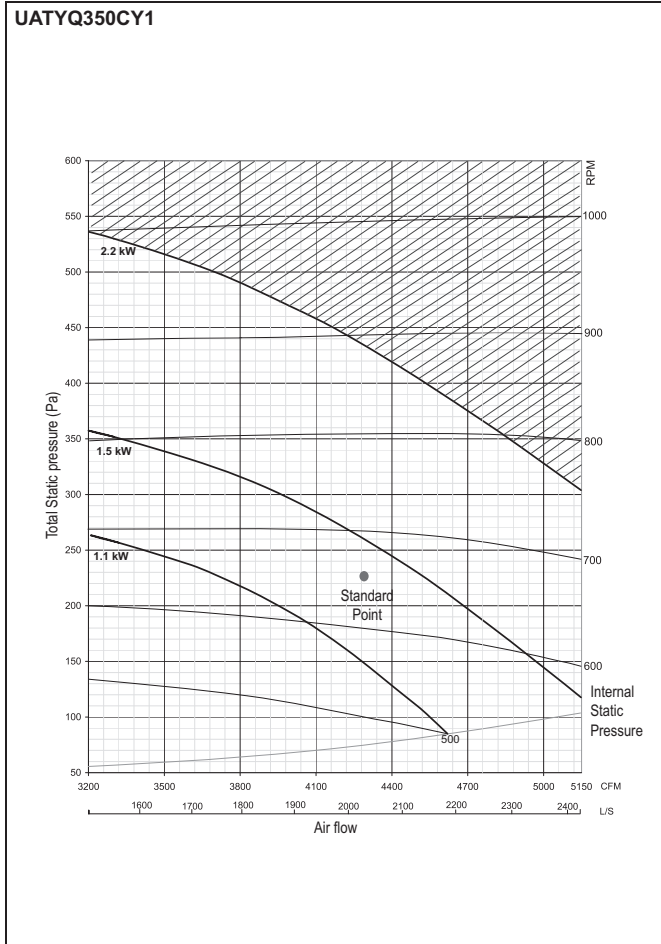
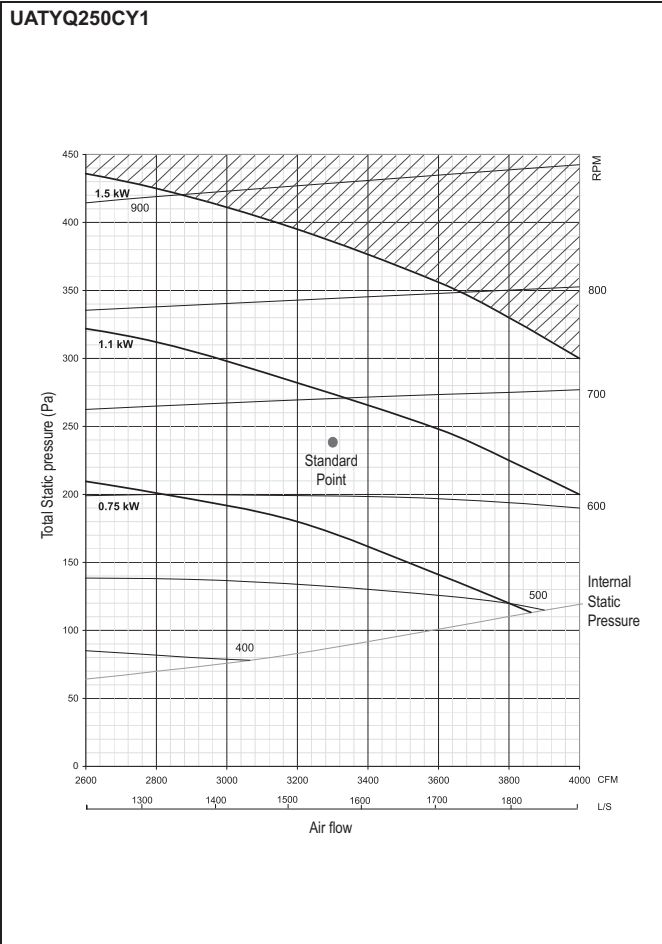



# 13 Fan characteristics

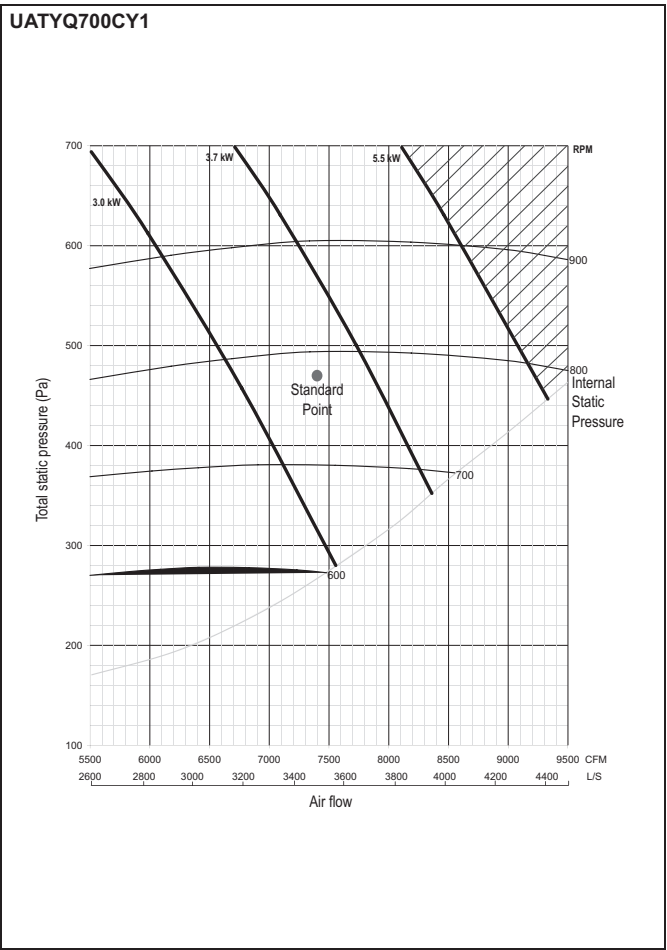
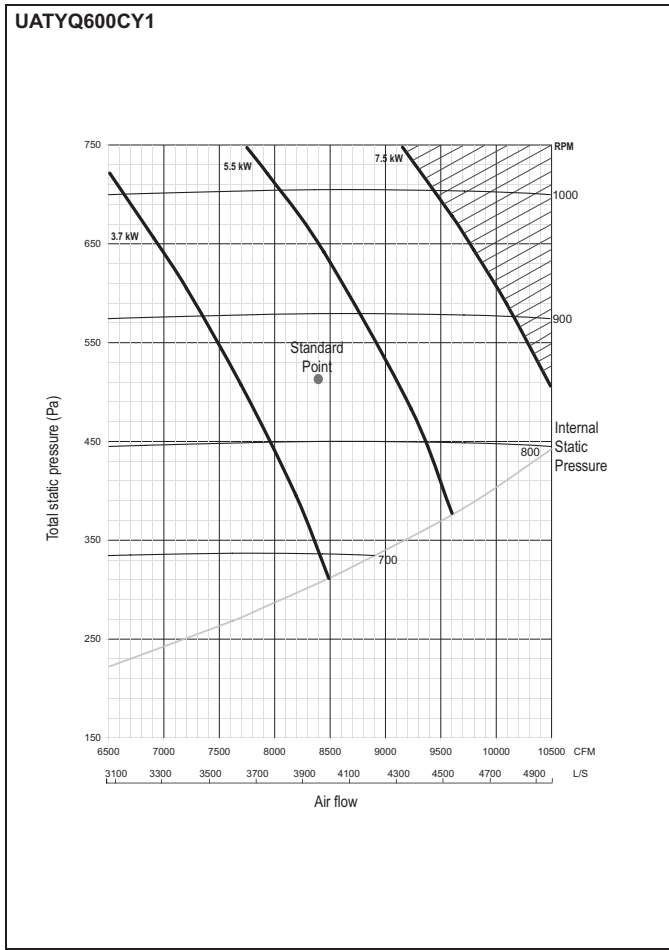

# 14 Installation

## 14 - 1 Roofcurb drawings

### UATYQ250-700CY1

Unit Support (For down throw unit only)

1. The figure shows the use of the roof curb for mounting these units.
2. The curb should be sealed and fixed to the roof by weather stripping. A suggested means of sealing the unit and roof curb as shown in the right.
3. Recommended roof curb dimension is shown below.

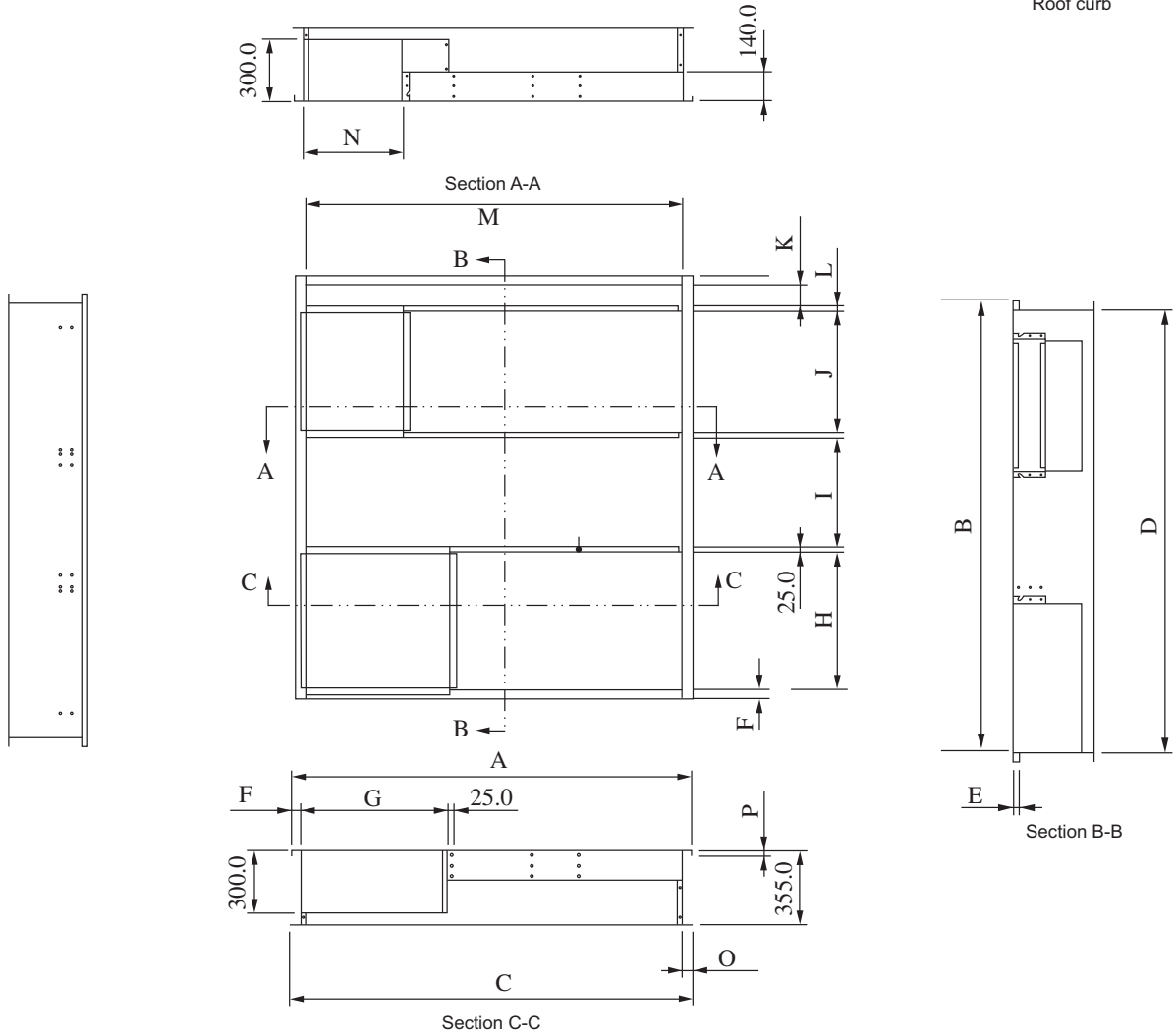
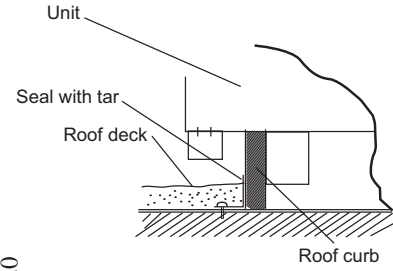

Model (UATYQ)	250	350/450	550/600/700
A	1821.0	1890.0	2448.0
B	1505.5	2081.0	2081.0
C	1881.0	1908.0	2466.0
D	1468.5	1998.0	1998.0
E	15.0	25.0	25.0
F	20.0	43.0	46.0
G	838.2	698.7	827.0
H	538.1	676.0	676.0
I	272.4	538.9	444.6
J	605.1	599.8	645.8
K	0.0	104.6	104.6
L	0.0	25.0	25.0
M	1781.0	1804.0	2362.0
N	479.7	475.7	589.0
O	50.0	52.0	52.0
P	15.0	25.0	25.0

Note: All dimensions are in mm

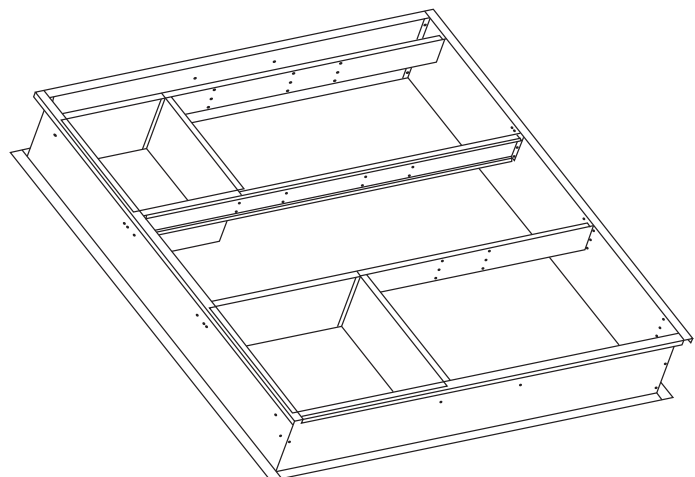

# 14 Installation

## 14 - 2 Pulley

UATYQ250,350,450,550,600,700CY1

### TECHNICAL DATA FOR UATYQ-MCY1 ROOFTOP SERIES WITH VARIABLE PITCH PULLEY:

**Motor Variable Pitch Pulley Data:**

Date is provided according to factory fitted standard motor and blower. The range of airflow & ESP must be worked within blower curve boundary.

External Static Pressure (ESP)		Model 90/120/150/180/210/250 = 100Pa																
Models R410A Rooftop	N	0	0,25	0,5	0,75	1	1,25	1,5	1,75	2	2,25	2,5	2,75	3	3,25	3,5	3,75	4
	X	0,5	1	1,5	2	2,5	3	3,5	4	4,5	5	5,5	6	6,5	7	7,5	8	8,5
250	Fan Speed (RPM)	738	733	727	722	716	711	704	698	691	683	676	670	663	656	650	643	638
	Power Input (W)	2005	1950	1890	1830	1770	1715	1660	1605	1550	1490	1420	1350	1275	1205	1130	1060	990
350	Fan Speed (RPM)	760	754	748	741	735	728	721	713	706	699	691	684	676	668	660	652	645
	Power Input (W)	2690	2590	2495	2390	2295	2190	2095	2005	1905	1815	1725	1650	1575	1515	1455	1390	1350
450	Fan Speed (RPM)	820	815	810	805	800	793	787	780	773	765	758	750	742	734	726	718	710
	Power Input (W)	3775	3660	3545	3450	3350	3250	3140	3030	2920	2810	2700	2590	2480	2370	2275	2185	2100
550	Fan Speed (RPM)	890	882	873	864	855	846	837	828	820	811	802	793	784	775	766	757	748
	Power Input (W)	5450	5300	5150	5010	4870	4720	4580	4440	4300	4160	4010	3870	3720	3570	3410	3240	3070
600	Fan Speed (RPM)	889	880	871	862	853	844	835	826	818	810	802	794	786	778	770	762	754
	Power Input (W)	5570	5460	5320	5180	5040	4900	4760	4620	4500	4380	4260	4140	4020	3900	3780	3660	3540
700	Fan Speed (RPM)	1004	994	984	974	964	954	944	933,8	924	914	904	894	884	874	864	854	844
	Power Input (W)	9430	9155	8880	8605	8330	8055	7780	7505	7230	6955	6680	6405	6130	5855	5580	5305	5030

External Static Pressure (ESP)		Model 90/120/150/180/210/250 = 150Pa																
Models R410A Rooftop	N	0	0,25	0,5	0,75	1	1,25	1,5	1,75	2	2,25	2,5	2,75	3	3,25	3,5	3,75	4
	X	0,5	1	1,5	2	2,5	3	3,5	4	4,5	5	5,5	6	6,5	7	7,5	8	8,5
250	Fan Speed (RPM)	750	744	738	733	727	721	714	708	701	693	686	678	671	664	657	650	643
	Power Input (W)	1790	1720	1645	1580	1510	1445	1375	1325	1270	1205	1130	1045	955	870	800	755	715
350	Fan Speed (RPM)	769	762	755	748	741	734	727	720	713	706	698	690	682	673	665	657	650
	Power Input (W)	2300	2205	2105	2000	1900	1800	1700	1610	1530	1460	1380	1300	1230	1160	1110	1060	1000
450	Fan Speed (RPM)	833	827	821	814	807	801	795	788	780	771	765	759	752	745	737	727	717
	Power Input (W)	3440	3330	3220	3110	3000	2890	2780	2670	2560	2450	2340	2230	2120	2020	1910	1830	1740
550	Fan Speed (RPM)	882	875	868	861	853	846	838	830	821	812	804	796	788	779	770	761	752
	Power Input (W)	5210	5050	4890	4720	4550	4400	4260	4100	3930	3770	3620	3480	3340	3190	3030	2890	2750
600	Fan Speed (RPM)	892	883	874	865	856	847	838	829	821	813	805	797	789	781	773	765	757
	Power Input (W)	5270	5160	5020	4880	4740	4600	4460	4320	4200	4080	3960	3840	3720	3600	3480	3360	3240
700	Fan Speed (RPM)	1008	998	988	978	968	958	948	938	928	918	908	898	888	878	868	858	848
	Power Input (W)	8910	8645	8380	8115	7850	7585	7320	7055	6790	6525	6260	5995	5730	5465	5200	4935	4670

External Static Pressure (ESP)		Model 90/120/150 = 200Pa, Model 180/210/250 = 210Pa																
Models R410A Rooftop	N	0	0,25	0,5	0,75	1	1,25	1,5	1,75	2	2,25	2,5	2,75	3	3,25	3,5	3,75	4
	X	0,5	1	1,5	2	2,5	3	3,5	4	4,5	5	5,5	6	6,5	7	7,5	8	8,5
250	Fan Speed (RPM)	763	757	751	744	738	733	727	721	715	708	700	693	685	677	669	661	653
	Power Input (W)	1370	1320	1265	1195	1130	1065	1000	950	905	850	790	725	650	605	555	510	460
350	Fan Speed (RPM)	776	769	762	755	748	741	733	726	718	711	703	695	687	679	671	663	655
	Power Input (W)	1910	1830	1740	1650	1560	1470	1390	1300	1210	1140	1055	985	920	850	790	740	690
450	Fan Speed (RPM)	842	836	830	823	817	811	805	796	788	781	773	764	755	746	738	731	723
	Power Input (W)	3080	2980	2890	2780	2670	2560	2450	2340	2230	2120	2020	1910	1820	1730	1620	1520	1420
550	Fan Speed (RPM)	889	882	875	868	861	853	845	837	828	819	810	801	792	783	774	765	757
	Power Input (W)	4670	4520	4370	4210	4060	3900	3750	3600	3430	3260	3090	2920	2750	2580	2470	2330	2230
600	Fan Speed (RPM)	896	887	880	873	864	855	846	837	828	819	811	802	793	784	778	768	759
	Power Input (W)	4950	4710	4570	4430	4290	4150	4010	3870	3870	3730	3590	3450	3310	3170	3030	2890	2750
700	Fan Speed (RPM)	1010	1000	990	980	970	960	950	940	930	920	910	900	890	880	870	860	850
	Power Input (W)	8180	7925	7670	7415	7160	6905	6650	6395	6140	5885	5630	5375	5120	4865	4610	4355	4100

External Static Pressure (ESP)		250Pa																
Models R410A Rooftop	N	0	0,25	0,5	0,75	1	1,25	1,5	1,75	2	2,25	2,5	2,75	3	3,25	3,5	3,75	4
	X	0,5	1	1,5	2	2,5	3	3,5	4	4,5	5	5,5	6	6,5	7	7,5	8	8,5
550	Fan Speed (RPM)	894	887	880	871	866	857	850	841	832	826	817	808	798	790	778	773	761
	Power Input (W)	4310	4120	4050	3890	3630	3560	3370	3220	3020	2930	2780	2730	2570	2370	2210	2030	1960
600	Fan Speed (RPM)	898	893	886	877	868	859	850	841	832	823	814	805	796	787	778	769	761
	Power Input (W)	4690	4550	4410	4270	4130	3990	3850	3690	3530	3370	3210	3050	2890	2730	2570	2410	2250
700	Fan Speed (RPM)	1013	1003	993	983	973	963	953	943	933	923	913	903	893	883	873	863	853
	Power Input (W)	7560	7315	7070	6825	6580	6335	6090	5845	5600	5355	5110	4865	4620	4375	4130	3885	3640

**LEGEND**

1. X: Regulation Space of Motor Pulley (mm)
2. N: Number of turns
3. ESP: External Static Pressure (mmAq)
4. : Factory Set Point
5. : Data is out of blower curve (for reference only)

# 14 Installation

## 14 - 2 Pulley

UATYQ250,350,450,550,600,700CY1

**Motor Pulley Dimensions:**

(Note: All dimensions are in mm)

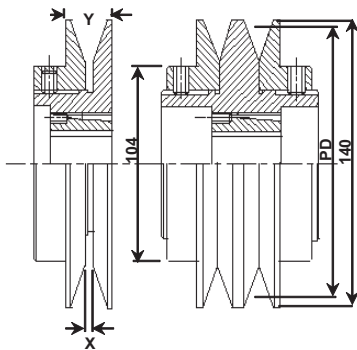

"Models R410A Rooftop (UATYQ-MCY1)"	Pulley Type	PD		Total Length	Quantity (pcs)
		Medium	Min - Max		
250	VPT139A1	121	109 - 133	35	1
350	VPT139A1	121	109 - 133	35	1
450	VPT139A2	121	109 - 133	70	2
550	VPT139A2	121	109 - 133	70	2
600	VPT139A2	121	109 - 133	70	2
700	VPT139A2	121	109 - 133	70	2

Legend: PD: Pitch Diameter of Motor Pulley (mm)

**V-Belt Dimensions:**

(Note: All dimensions are in mm)

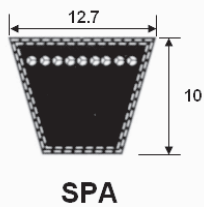

"Models R410A Rooftop (UATYQ-MCY1)"	Section	Top Width	Thickness	Angle (°)	Side flow		Down flow		Quantity (pcs)
					V-belt length	Pulley center distance(mm)	V-belt length	Pulley center distance(mm)	
						Nominal		Nominal	
250	A	12.7	10	40	1657	510	1382	375	1
350	A	12.7	10	40	1782	590	1357	388	1
450	A	12.7	10	40	1657	515	1250	375	2
550	A	12.7	10	40	1932	710	1382	445	2
600	A	12.7	10	40	1957	710	1382	445	2
700	A	12.7	10	40	1907	690	1382	435	2

In all of us,  
a green heart



Daikin's unique position as a manufacturer of air conditioning equipment, compressors and refrigerants has led to its close involvement in environmental issues. For several years Daikin has had the intention to become a leader in the provision of products that have limited impact on the environment. This challenge demands the eco design and development of a wide range of products and an energy management system, resulting in energy conservation and a reduction of waste.



The present publication is drawn up by way of information only and does not constitute an offer binding upon Daikin Europe N.V. Daikin Europe N.V. has compiled the content of this publication to the best of its knowledge. No express or implied warranty is given for the completeness, accuracy, reliability or fitness for particular purpose of its content and the products and services presented therein. Specifications are subject to change without prior notice. Daikin Europe N.V. explicitly rejects any liability for any direct or indirect damage, in the broadest sense, arising from or related to the use and/or interpretation of this publication. All content is copyrighted by Daikin Europe N.V.

Daikin products are distributed by:



Daikin Europe N.V. is participating in the EUROVENT Certification Programme. Products are as listed in the EUROVENT Directory of Certified Products. Multi units are Eurovent certified for combinations up to 2 indoor units