

DAIKIN

INSTALLATION MANUAL

R410A Split Series

INVERTER

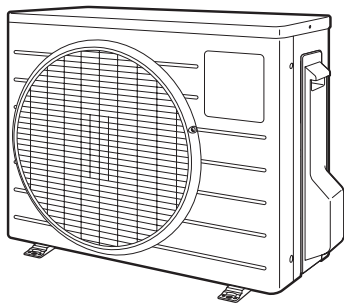

Models

ARX20J3V1B

ARX25J3V1B

ARX35J3V1B

Installation manual
R410A Split series

English

Installationsanleitung
Split-Baureihe R410A

Deutsch

Manuel d'installation
Série split R410A

Français

Montagehandleiding
R410A Split-systeem

Nederlands

Manual de instalación
Serie Split R410A

Español

Manuale d'installazione
Serie Multiambienti R410A

Italiano

Εγχειρίδιο εγκατάστασης
διαιρούμενης σειράς R410A

Ελληνικά

Manual de Instalação
Série split R410A

Portugues

CE - DECLARATION-OF-CONFORMITY
CE - KONFORMITÄTSEKTLÄRUNG
CE - DECLARATION-DE-CONFORMITE
CE - CONFORMITEITSVERKLARING

CE - DECLARACION-DE-CONFORMIDAD
CE - DICHIARAZIONE-DI-CONFORMITA
CE - ΔΗΛΩΣΗ ΣΥΜΜΟΡΦΩΣΗΣ

CE - DECLARAÇÃO-DE-CONFORMIDADE
CE - ЗАЯВЛЕНИЕ-О-СООТВЕТСТВИИ
CE - OPFYLDELSESEKTLÆRING
CE - FÖRSÄKRAN-OM-OVERENSTÄMMELSE

CE - ERKLÄRUNG OM-SAMSVAR
CE - ILMOITUS-YHDENMUKAISUDESTA
CE - PROHLÁŠENÍ-O-SHODĚ

CE - IZJAVA-O-USKLAĐENOSTI
CE - MEGFELELŐSÉGI-NYILATKOZAT
CE - DEKLARACJA-ZGODNOŚCI
CE - DECLARAȚIE-DE-CONFORMITATE

CE - IZJAVA O SKLADNOSTI
CE - VASTAVUSDEKLARATSIOON
CE - ДЕКЛАРАЦИЯ-ЗА-СЪОТВЕТСТВИЕ

CE - ATITIKTIES-DEKLARACIJA
CE - ATBLĪSTĪBAS-DEKLARĀCIJA
CE - VYHLÁSENIE-ZHODY
CE - UYUMLULUK-BİLDİRİSİ

DAIKIN INDUSTRIES CZECH REPUBLIC s.r.o.

- 01 declares under its sole responsibility that the air conditioning models to which this declaration relates:
- 02 erklärt auf seine alleinige Verantwortung daß die Modelle der Klimageräte für die diese Erklärung bestimmt ist:
- 03 déclare sous sa seule responsabilité que les appareils d'air conditionné visés par la présente déclaration:
- 04 verklaart hierbij op eigen exclusieve verantwoordelijkheid dat de airconditioning units waarop deze verklaring betrekking heeft:
- 05 declara baja su única responsabilidad que los modelos de aire acondicionado a los cuales hace referencia la declaración:
- 06 dichiara sotto sua responsabilità che i condizionatori modello a cui è riferita questa dichiarazione:
- 07 δηλώνει με αποκλειστική της ευθύνη ότι τα μοντέλα των κλιματιστικών συσκευών στα οποία αναφέρεται η παρούσα δήλωση:
- 08 declara sob sua exclusiva responsabilidade que os modelos de ar condicionado a que esta declaração se refere:
- 09 заявляет, исключительно под своею ответственностью, что модели кондиционеров воздуха, к которым относится настоящее заявление:

RX20J3V1B, RX25J3V1B, RX35J3V1B, ARX20J3V1B, ARX25J3V1B, ARX35J3V1B

- 01 are in conformity with the following standard(s) or other normative document(s), provided that these are used in accordance with our instructions:
- 02 der(den) folgenden Norm(en) oder einem anderen Normdokument oder -dokumenten entspricht/entsprechen, unter der Voraussetzung, daß sie gemäß unseren Anweisungen eingesetzt werden:
- 03 sont conformes à la/aux norme(s) ou autre(s) document(s) normatif(s), pour autant qu'ils soient utilisés conformément à nos instructions:
- 04 conform de volgende norm(en) of één of meer andere bindende documenten zijn, op voorwaarde dat ze worden gebruikt overeenkomstig onze instructies:
- 05 están en conformidad con la(s) siguiente(s) norma(s) u otro(s) documento(s) normativo(s), siempre que sean utilizados de acuerdo con nuestras instrucciones:
- 06 sono conformi a il(l) seguente(i) standard(s) o altro(i) documento(i) a carattere normativo, a patto che vengano usati in conformità alle nostre istruzioni:
- 07 είναι σύμφωνα με το(α) ακόλουθ(α) πρότυπο(α) ή άλλο έγγραφο(α) κανονισμού, υπό την προϋπόθεση ότι χρησιμοποιούνται σύμφωνα με τις οδηγίες μας:

EN60335-2-40,

- 01 following the provisions of:
- 02 gemäß den Vorschriften der:
- 03 conformément aux stipulations des:
- 04 overeenkomstig de bepalingen van:
- 05 siguiendo las disposiciones de:
- 06 secondo le prescrizioni per:
- 07 με τη/την των διατάξεων των:
- 08 de acordo com o previsto em:
- 09 в соответствии с положениями:
- 10 under iagttagelse af bestemmelserne i:
- 11 enligt villkoren i:
- 12 gitt i henhold til bestemmelse i:
- 13 noudattaa määräyksiä:
- 14 za održení ustanovení předpisu:
- 15 prema odredbama:
- 16 követi a(z):
- 17 zgodnie z postanowieniami Dyrektywy:
- 18 in urma prevederilor:
- 19 ob upoštevanju določb:
- 20 vastavalt nõuetele:
- 21 следвайки изказите на:
- 22 laikantis nuostatų, pateiktiamų:
- 23 ievērojot prasības, kas noteiktas:
- 24 održavajući ustanovenia:
- 25 bunu koşullarına uygun olarak:

- 01 **Note *** as set out in <A> and judged positively by according to the **Certificate <C>**.
- 02 **Hinweis *** wie in der <A> aufgeführt und von positiv beurteilt gemäß **Zertifikat <C>**.
- 03 **Remarque *** tel que défini dans <A> et évalué positivement par conformément au **Certificat <C>**.
- 04 **Bemerk *** zoals vermeld in <A> en positief beoordeeld door overeenkomstig **Certificaat <C>**.
- 05 **Nota *** como se establece en <A> y es valorado positivamente por de acuerdo con el **Certificado <C>**.
- 06 **Nota *** delineato nei <A> e giudicato positivamente da secondo il **Certificato <C>**.
- 07 **Σημείωση *** όπως καθορίζεται στο <A> και κρίνεται θετικά από το σύμφωνα με το **Πιστοποιητικό <C>**.
- 08 **Nota *** tal como estabelecido em <A> e com o parecer positivo de de acordo com o **Certificado <C>**.
- 09 **Примечание *** как указано в <A> и в соответствии с положительным решением согласно **Свидетельству <C>**.
- 10 **Bemærk *** som anført i <A> og positivt vurderet af i henhold til **Certifikat <C>**.

- 10 erklærer under eneansvar, at klimaenlægsmodellerne, som denne deklaration vedrører:
- 11 deklarerer i egenskab af huvudsansvarig, att luftkonditioneringsmodellerna som berörs av denna deklaration innebär att:
- 12 erklærer et fullstendig ansvar for at de luftkonditioneringsmodeller som berøres af denne deklaration innebarer at:
- 13 ilmoittaa yksinomaan omalla vastuullaan, että tämän ilmoituksen tarkoitettamat ilmastointilaitteen mallit:
- 14 prohláší ve své plné odpovědnosti, že modely klimatizace, k nimž se toto prohlášení vztahuje:
- 15 izjavljuje pod isključivo vlastitom odgovornošću da su modeli klima uređaja na koje se ova izjava odnosi:
- 16 teljes felelőssége tudatában kijelenti, hogy a klímaberendezés modellek, melyekre e nyilatkozat vonatkozik:
- 17 deklaruje na własną i wyłączną odpowiedzialność, że modele klimatyzatorów, których dotyczy niniejsza deklaracja:
- 18 deklará pe proprie răspundere că aparatele de aer condiționat la care se referă această declarație:

- 08 estão em conformidade com a(s) seguinte(s) norma(s) ou outro(s) documento(s) normativo(s), desde que estes sejam utilizados de acordo com as nossas instruções:
- 09 соответствуют следующим стандартам или другим нормативным документам, при условии их использования согласно нашим инструкциям:
- 10 overholder følgende standard(er) eller andet/andre retningsgivende dokument(er), forudsat at disse anvendes i henhold til vore instruks:
- 11 respektive ustrüstning är utförd i överensstämmelse med och följer följande standard(er) eller andra normgivande dokument, under förutsättning att användning sker i överensstämmelse med våra instruktioner:
- 12 respektive utstyr er i overensstemmelse med følgende standard(er) eller andre normgivende dokument(er), under forutsetning av at disse brukes i henhold til våre instruks:
- 13 vastaavat seuraavien standardien ja muiden ohjeellisten dokumenttien vaatimuksia edellyttäen, että niitä käytetään ohjeidemme mukaisesti:
- 14 za předpokladu, že jsou využívány v souladu s našimi pokyny, odpovídají následujícím normám nebo normativním dokumentům:
- 15 u skladu sa slijedećim standardom(ima) ili drugim normativnim dokumentom(ima), uz uvjet da se oni koriste u skladu s našim uputama:

- 01 Directives, as amended.
- 02 Direktiven, gemäß Änderung.
- 03 Directives, telles que modifiées.
- 04 Richtlijnen, zoals geamendeeerd.
- 05 Directives, según lo amendado.
- 06 Directive, come da modifica.
- 07 Οδηγών, όπως έχουν τροποποιηθεί.
- 08 Directivas, conforme alteração em.
- 09 Директив со всеми поправками.
- 10 Direktiver, med senere ændringer.
- 11 Direktiv, med foretagne ændringer.
- 12 Direktive, med foretatte ændringer.
- 13 Direktiivä, sellaisina kuin ne ovat muutettuna.
- 14 v platném znění.
- 15 Smjernice, kako je izmijenjeno.
- 16 irányelvek(ek) és módosítások rendelkezéseit.
- 17 z późniejszymi poprawkami.
- 18 Directivelor, cu amendamentele respective.

- 11 **Information *** enligt <A> og godkants av enligt **Certifikatet <C>**.
- 12 **Merk *** som det fremkommer i <A> og gjennom positiv bedømmelse av ifølge **Sertifikat <C>**.
- 13 **Huom *** jotka on esitetty asiakirjassa <A> ja jotka on hyväksynyt **Sertifikaatin <C>** mukaisesti.
- 14 **Poznámka *** jak bylo uvedeno v <A> a pozitivně zjištěno v souladu s **osvědčením <C>**.
- 15 **Napomena *** kako je izloženo u <A> i pozitivno ocijenjeno od strane prema **Certifikatu <C>**.
- 16 **Megjegyzés *** a(z) <A> alapján, a(z) igazolva a megelélelést, a(z) <C> tanúsítvány szerint.
- 17 **Uwaga *** zgodnie z dokumentacją <A>, pozytywną opinią i **Świadectwem <C>**.
- 18 **Notá *** așa cum este stabilit în <A> și apreciat pozitiv de în conformitate cu **Certificatul <C>**.
- 19 **Opomba *** kot je določeno v <A> in odobreno s strani v skladu s **certifikatom <C>**.
- 20 **Märkus *** nagu on näidatud dokumendis <A> ja heaks kiidetud järgi vastavalt **sertifikaadile <C>**.
- 21 **Забелешка *** както е изложено в <A> и оценено положително от съгласно **Сертификата <C>**.
- 22 **Pastaba *** kaip nustatyta <A> ir kaip teigiamai nuspresta pagal **Sertifikatą <C>**.
- 23 **Piezīmes *** kā norādīts <A> un atbilstoši pozitīvajam vērtējumam saskaņā ar **sertifikātu <C>**.
- 24 **Poznámka *** ako bolo uvedené v <A> a pozitívne zistené v súlade s **osvedčením <C>**.
- 25 **Not *** <A> da beilirdiligi gibi ve <C> **Sertifikasına göre ** tarafından olumlu olarak değerlendirildiği gibi.

| | |
|-----|-----------------------------------|
| <A> | DAIKIN, TCF, 015P7/07-2012 |
| | DEKRA (NB0344) |
| <C> | 74736-KRQ/EMC97-4957 |

3P 327445-7B

DAIKIN

Takayuki Fujii

Takayuki Fujii
Managing Director
1st of Nov. 2012

DAIKIN INDUSTRIES CZECH REPUBLIC s.r.o.

U Nove hospody 1/1155, 301 00 Plzen Skvrnany,
Czech Republic



Safety Precautions

- Read these Safety Precautions carefully to ensure correct installation.
- This manual classifies the precautions into WARNING and CAUTION.
Be sure to follow all the precautions below: they are all important for ensuring safety.





 **WARNING**.....Failure to follow any of WARNING is likely to result in such grave consequences as death or serious injury.



 **CAUTION**.....Failure to follow any of CAUTION may result in grave consequences in some cases.

- The following safety symbols are used throughout this manual:

| | | |
|--|---|--|
|  Be sure to observe this instruction. |  Be sure to establish an earth connection. |  Never attempt. |
|--|---|--|



- After completing installation, test the unit to check for installation errors. Give the user adequate instructions concerning the use and cleaning of the unit according to the Operation Manual.

|  WARNING | |
|--|---|
| • Installation should be left to the dealer or another professional. Improper installation may cause water leakage, electrical shock, or fire. | |
| • Install the air conditioner according to the instructions given in this manual. Incomplete installation may cause water leakage, electrical shock, or fire. | |
| • Be sure to use the supplied or specified installation parts. Use of other parts may cause the unit to come to lose, water leakage, electrical shock, or fire. | |
| • Install the air conditioner on a solid base that can support the weight of the unit. An inadequate base or incomplete installation may cause injury in the event the unit falls off the base. | |
| • Electrical work should be carried out in accordance with the installation manual and the national electrical wiring rules or code of practice. Insufficient capacity or incomplete electrical work may cause electrical shock or fire. | |
| • Be sure to use a dedicated power circuit. Never use a power supply shared by another appliance. | |
| • For wiring, use a cable length enough to cover the entire distance with no connection. Do not use an extension cord. Do not put other loads on the power supply, use a dedicated power circuit. (Failure to do so may cause abnormal heat, electric shock or fire.) | |
| • Use the specified types of wires for electrical connections between the indoor and outdoor units. Firmly clamp the interconnecting wires so their terminals receive no external stresses. Incomplete connections or clamping may cause terminal overheating or fire. | |
| • After connecting interconnecting and supply wiring be sure to shape the cables so that they do not put undue force on the electrical covers or panels. Install covers over the wires. Incomplete cover installation may cause terminal overheating, electrical shock, or fire. | |
| • If any refrigerant has leaked out during the installation work, ventilate the room. (The refrigerant produces a toxic gas if exposed to flames.) |  |
| • After all installation is complete, check to make sure that no refrigerant is leaking out. (The refrigerant produces a toxic gas if exposed to flames.) |  |
| • When installing or relocating the system, be sure to keep the refrigerant circuit free from substances other than the specified refrigerant (R410A), such as air. (Any presence of air or other foreign substance in the refrigerant circuit causes an abnormal pressure rise or rupture, resulting in injury.) | |
| • During pump-down, stop the compressor before removing the refrigerant piping. If the compressor is still running and the stop valve is open during pump-down, air will be sucked in when the refrigerant piping is removed, causing abnormal pressure in the freezer cycle which will lead to breakage and even injury. | |
| • During installation, attach the refrigerant piping securely before running the compressor. If the compressor is not attached and the stop valve is open during pump-down, air will be sucked in when the compressor is run, causing abnormal pressure in the freezer cycle which will lead to breakage and even injury. | |
| • Be sure to establish an earth. Do not earth the unit to a utility pipe, arrester, or telephone earth. Incomplete earth may cause electrical shock, or fire. A high surge current from lightning or other sources may cause damage to the air conditioner. |  |
| • Be sure to install an earth leakage breaker. Failure to install an earth leakage breaker may result in electric shocks, or fire. | |

|  CAUTION | |
|---|---|
| • Do not install the air conditioner in a place where there is danger of exposure to inflammable gas leakage. If the gas leaks and builds up around the unit, it may catch fire. |  |
| • Establish drain piping according to the instructions of this manual. Inadequate piping may cause flooding. | |
| • Tighten the flare nut according to the specified method such as with a torque wrench. If the flare nut is tightened too hard, the flare nut may crack after a long time and cause refrigerant leakage. | |
| • Make sure to provide for adequate measures in order to prevent that the outdoor unit be used as a shelter by small animals. Small animals making contact with electrical parts can cause malfunctions, smoke or fire. Please instruct the customer to keep the area around the unit clean. | |

Accessories

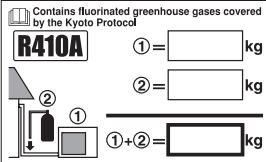
Accessories supplied with the outdoor unit:

| | | | |
|--|---|---|---|
| (A) Installation Manual | 1 | | |
| (C) Refrigerant charge label  | 1 | (B) Drain plug (Heat pump-Models)  There is on the bottom packing case. | 1 |
| (D) Multilingual fluorinated greenhouse gases label  | 1 | | |

Precautions for Selecting the Location

- 1) Choose a place solid enough to bear the weight and vibration of the unit, where the operation noise will not be amplified.
- 2) Choose a location where the hot air discharged from the unit or the operation noise will not cause a nuisance to the neighbors of the user.
- 3) Avoid places near a bedroom and the like, so that the operation noise will cause no trouble.
- 4) There must be sufficient spaces for carrying the unit into and out of the site.
- 5) There must be sufficient space for air passage and no obstructions around the air inlet and the air outlet.
- 6) The site must be free from the possibility of flammable gas leakage in a nearby place.
- 7) Install units, power cords and inter-unit cables at least 3 meter away from television and radio sets. This is to prevent interference to images and sounds. (Noises may be heard even if they are more than 3 meter away depending on radio wave conditions.)
- 8) In coastal areas or other places with salty atmosphere of sulfate gas, corrosion may shorten the life of the air conditioner.
- 9) Since drain flows out of the outdoor unit, do not place under the unit anything which must be kept away from moisture.

NOTE

Cannot be installed hanging from ceiling or stacked.

CAUTION

When operating the air conditioner in a low outdoor ambient temperature, be sure to follow the instructions described below.

- 1) To prevent exposure to wind, install the outdoor unit with its suction side facing the wall.
- 2) Never install the outdoor unit at a site where the suction side may be exposed directly to wind.
- 3) To prevent exposure to wind, it is recommended to install a baffle plate on the air discharge side of the outdoor unit.
- 4) In heavy snowfall areas, select an installation site where the snow will not affect the unit.

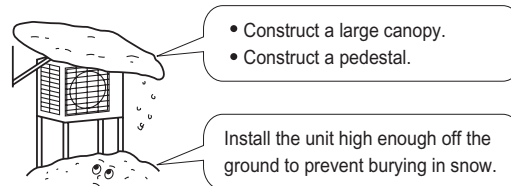

Outdoor Unit Installation Drawings

| | |
|---|------------|
| Max. allowable length | 15m |
| Min. allowable length | 1.5m |
| Max. allowable height | 12m |
| Additional refrigerant required for refrigerant pipe exceeding 10m in length. | 20g/m |
| Gas pipe | O.D. 9.5mm |
| Liquid pipe | O.D. 6.4mm |

- * Be sure to add the proper amount of additional refrigerant. Failure to do so may result in reduced performance.
- * The suggested shortest pipe length is 1.5m, in order to avoid noise from the outdoor unit and vibration.
(Mechanical noise and vibration may occur depending on how the unit is installed and the environment in which it is used.)

Wrap the insulation pipe with the finishing tape from bottom to top.

CAUTION
Set the piping length from 1.5m to 15m.

Stop valve cover

■ **How to remove the stop valve cover.**

- Remove the screw on the stop valve cover.
- Slide the lid downward to remove it.

■ **How to attach the stop valve cover.**

- Insert the upper part of the stop valve cover into the outdoor unit to install.
- Tighten the screws.

In sites with poor drainage, use block bases for outdoor unit. Adjust foot height until the unit is leveled. Otherwise, water leakage or pooling of water may occur.

Allow space for piping and electrical servicing.

Where there is a danger of the unit falling, use foot bolts, or wires.

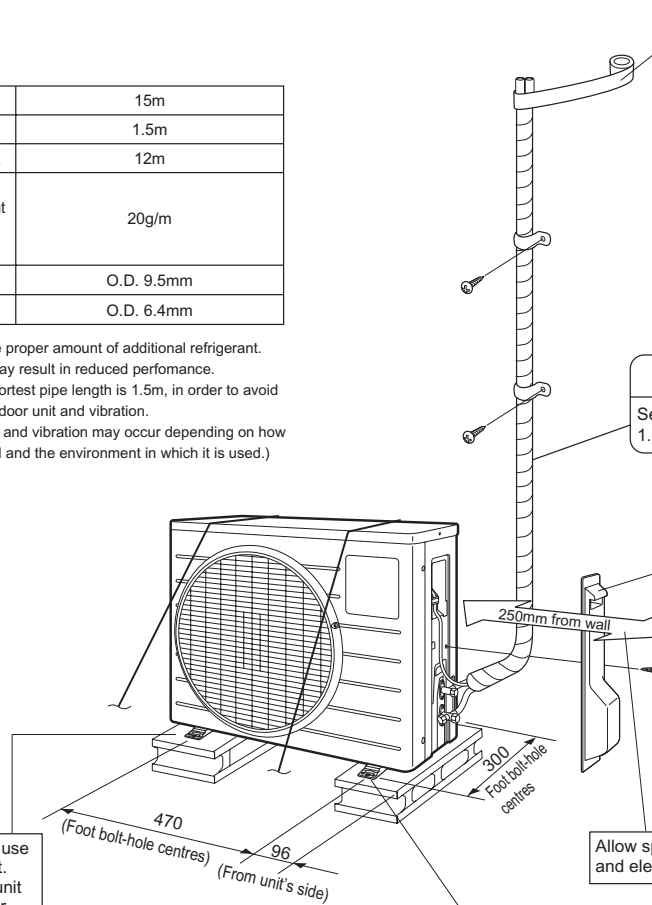

unit: mm

Installation Guidelines

- Where a wall or other obstacle is in the path of outdoor unit's intake or exhaust airflow, follow the installation guidelines below.
- For any of the below installation patterns, the wall height on the exhaust side should be 1200mm or less.

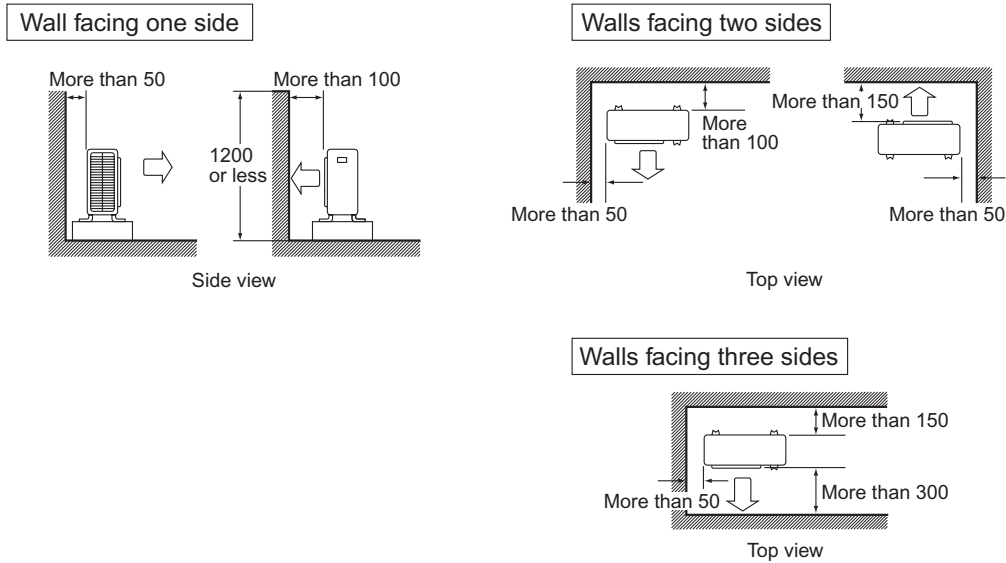

Unit: mm

Precautions on Installation

- Check the strength and level of the installation ground so that the unit will not cause any operating vibration or noise after installed.
- In accordance with the foundation drawing, fix the unit securely by means of the foundation bolts. (Prepare four sets of M8 or M10 foundation bolts, nuts and washers each which are available on the market.)
- It is best to screw in the foundation bolts until their length are 20mm from the foundation surface.

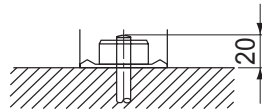

Outdoor Unit Installation

1. Installing outdoor unit.

- 1) When installing the outdoor unit, refer to "Precautions for Selecting the Location" and the "Outdoor Unit Installation Drawings."
- 2) If drain work is necessary, follow the procedures below.

2. Drain work. (Heat pump-models.)

- 1) Use drain plug for drainage.
- 2) If the drain port is covered by a mounting base or floor surface, place additional foot bases of at least 30mm in height under the outdoor unit's feet.
- 3) In cold areas, do not use a drain hose with the outdoor unit. (Otherwise, drain water may freeze, impairing heating performance.)

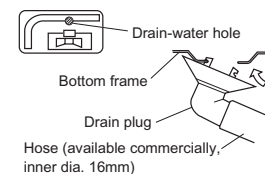

Outdoor Unit Installation

3. Flaring the pipe end.

- 1) Cut the pipe end with a pipe cutter.
- 2) Remove burrs with the cut surface facing downward so that the chips do not enter the pipe.
- 3) Put the flare nut on the pipe.
- 4) Flare the pipe.
- 5) Check that the flaring is properly made.

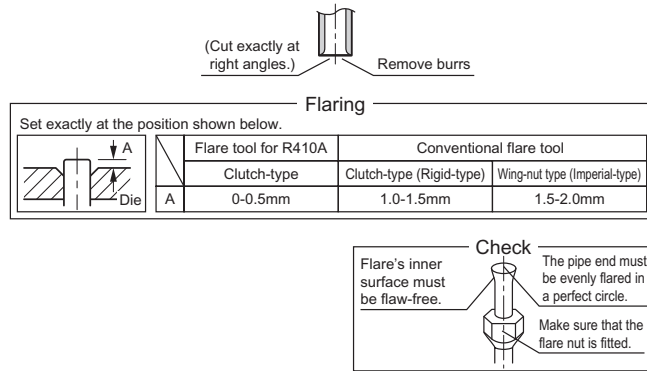

⚠ WARNING

- 1) Do not use mineral oil on flared part.
- 2) Prevent mineral oil from getting into the system as this would reduce the lifetime of the units.
- 3) Never use piping which has been used for previous installations. Only use parts which are delivered with the unit.
- 4) Do never install a drier to this R410A unit in order to guarantee its lifetime.
- 5) The drying material may dissolve and damage the system.
- 6) Incomplete flaring may cause refrigerant gas leakage.

4. Refrigerant piping.

⚠ CAUTION

- 1) Use the flare nut fixed to the main unit. (To prevent cracking of the flare nut by aged deterioration.)
- 2) To prevent gas leakage, apply refrigeration oil only to the inner surface of the flare. (Use refrigeration oil for R410A.)
- 3) Use torque wrenches when tightening the flare nuts to prevent damage to the flare nuts and gas leakage.

Align the centres of both flares and tighten the flare nuts 3 or 4 turns by hand. Then tighten them fully with the torque wrenches.

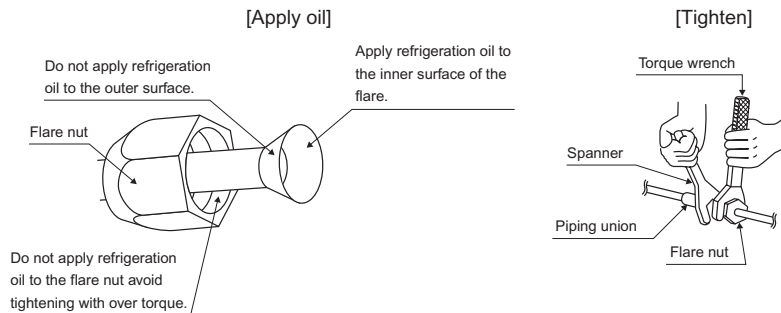

| Flare nut tightening torque | |
|-------------------------------------|-------------------------------------|
| Gas side | Liquid side |
| 3/8 inch | 1/4 inch |
| 32.7-39.9N • m (333-407kgf • cm) | 14.2-17.2N • m (144-175kgf • cm) |

| Valve cap tightening torque | |
|-------------------------------------|-------------------------------------|
| Gas side | Liquid side |
| 3/8 inch | 1/4 inch |
| 21.6-27.4N • m (220-280kgf • cm) | 21.6-27.4N • m (220-280kgf • cm) |
| Service port cap tightening torque | 10.8~14.7N • m (110~150kgf • cm) |

5. Purging air and checking gas leakage.

- When piping work is completed, it is necessary to purge the air and check for gas leakage.

⚠ WARNING

- 1) Do not mix any substance other than the specified refrigerant (R410A) into the refrigeration cycle.
- 2) When refrigerant gas leaks occur, ventilate the room as soon and as much as possible.
- 3) R410A, as well as other refrigerants, should always be recovered and never be released directly into the environment.
- 4) Use a vacuum pump for R410A exclusively. Using the same vacuum pump for different refrigerants may damage the vacuum pump or the unit.

- If using additional refrigerant, perform air purging from the refrigerant pipes and indoor unit using a vacuum pump, then charge additional refrigerant.
- Use a hexagonal wrench (4mm) to operate the stop valve rod.
- All refrigerant pipe joints should be tightened with a torque wrench at the specified tightening torque.

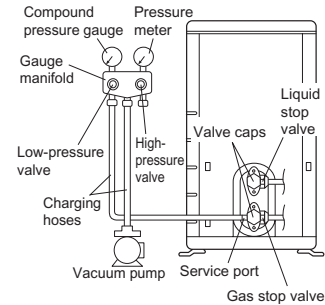

1) Connect projection side of charging hose (which comes from gauge manifold) to gas stop valve's service port.



2) Fully open gauge manifold's low-pressure valve (Lo) and completely close its high-pressure valve (Hi).
(High-pressure valve subsequently requires no operation.)



3) Do vacuum pumping and make sure that the compound pressure gauge reads -0.1MPa (-76cmHg)*1.



4) Close gauge manifold's low-pressure valve (Lo) and stop vacuum pump.
(Keep this state for a few minutes to make sure that the compound pressure gauge pointer does not swing back.)*2.



5) Remove caps from liquid stop valve and gas stop valve.



6) Turn the liquid stop valve's rod 90 degrees counterclockwise with a hexagonal wrench to open valve.
Close it after 5 seconds, and check for gas leakage.
Using soapy water, check for gas leakage from indoor unit's flare and outdoor unit's flare and valve rods.
After the check is complete, wipe all soapy water off.



7) Disconnect charging hose from gas stop valve's service port, then fully open liquid and gas stop valves.
(Do not attempt to turn valve rod beyond its stop.)



8) Tighten valve caps and service port caps for the liquid and gas stop valves with a torque wrench at the specified torques.

*1. Pipe length vs. vacuum pump run time.

| | |
|-------------|-----------------------|
| Pipe length | Up to 15 metres |
| Run time | Not less than 10 min. |

*2. If the compound pressure gauge pointer swings back, refrigerant may have water content or a loose pipe joint may exist.
Check all pipe joints and retighten nuts as needed, then repeat steps 2) through 4).

Outdoor Unit Installation

6. Refilling the refrigerant.

Check the type of refrigerant to be used on the machine nameplate.

Precautions when adding R410A

Fill from the liquid pipe in liquid form.

It is a mixed refrigerant, so adding it in gas form may cause the refrigerant composition to change, preventing normal operation.

- 1) Before filling, check whether the cylinder has a siphon attached or not. (It should have something like “liquid filling siphon attached” displayed on it.)

Filling a cylinder with an attached siphon

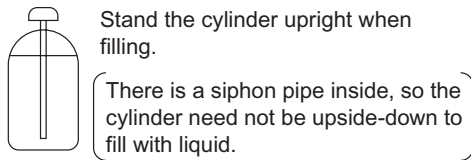

Filling other cylinders

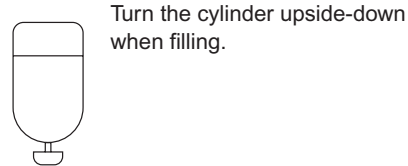

- Be sure to use the R410A tools to ensure pressure and to prevent foreign objects entering.

Important information regarding the refrigerant used

This product contains fluorinated greenhouse gases covered by the Kyoto Protocol. Do not vent gases into the atmosphere.

Refrigerant type: **R410A**

GWP⁽¹⁾ value: **1975** ⁽¹⁾ GWP = global warming potential

Please fill in with indelible ink,

- ① the factory refrigerant charge of the product,
 - ② the additional refrigerant amount charged in the field and
 - ①+② the total refrigerant charge
- on the refrigerant charge label supplied with the product.

The filled out label must be adhered in the proximity of the product charging port (e.g. onto the inside of the stop valve cover).

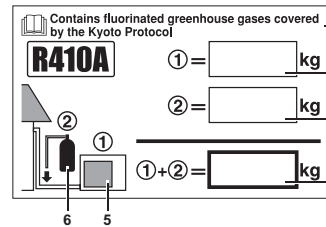

- 1 factory refrigerant charge of the product: see unit name plate
- 2 additional refrigerant amount charged in the field
- 3 total refrigerant charge
- 4 Contains fluorinated greenhouse gases covered by the Kyoto Protocol
- 5 outdoor unit
- 6 refrigerant cylinder and manifold for charging

NOTE

National implementation of EU regulation on certain fluorinated greenhouse gases may require to provide the appropriate official national language on the unit. Therefore an additional multilingual fluorinated greenhouse gases label is supplied with the unit. Sticking instructions are illustrated on the backside of that label.

7. Refrigerant piping work.

7-1 Cautions on pipe handling.

- 1) Protect the open end of the pipe against dust and moisture.
- 2) All pipe bends should be as gentle as possible. Use a pipe bender for bending.

7-2 Selection of copper and heat insulation materials.

When using commercial copper pipes and fittings, observe the following:

- 1) Insulation material: Polyethylene foam
Heat transfer rate: 0.041 to 0.052W/mK (0.035 to 0.045kcal/(mh •°C))
Refrigerant gas pipe's surface temperature reaches 110°C max.
Choose heat insulation materials that will withstand this temperature.
- 2) Be sure to insulate both the gas and liquid piping and to provide insulation dimensions as below.

| Gas side | Liquid side | Gas pipe thermal insulation | Liquid pipe thermal insulation |
|----------------------------|-------------|-----------------------------|--------------------------------|
| O.D. 9.5mm | O.D. 6.4mm | I.D. 12-15mm | I.D. 8-10mm |
| Minimum bend radius | | Thickness 10mm Min. | |
| 30mm or more | | | |
| Thickness 0.8mm (C1220T-O) | | | |

- 3) Use separate thermal insulation pipes for gas and liquid refrigerant pipes.

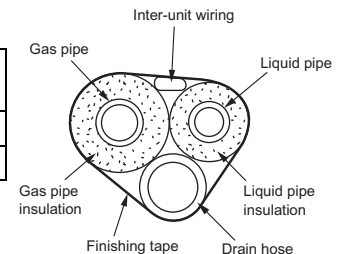
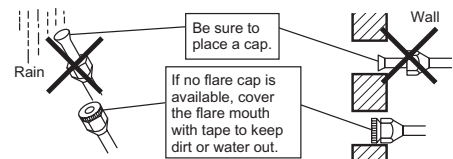

Pump Down Operation

In order to protect the environment, be sure to pump down when relocating or disposing of the unit.

- 1) Remove the valve cap from liquid stop valve and gas stop valve.
- 2) Carry out forced cooling operation.
- 3) After five to ten minutes, close the liquid stop valve with a hexagonal wrench.
- 4) After two to three minutes, close the gas stop valve and stop forced cooling operation.

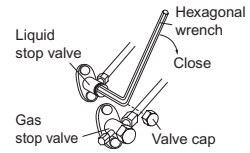

How to force cooling operation mode

■ Using the indoor unit operation/stop button

Press the indoor unit operation/stop button for at least five seconds. (Operation will start.)

- Forced cooling operation will stop automatically after around 15 minutes.
To force a test run to stop, press the indoor unit operation/stop button.

■ Using the main unit's remote controller

- 1) Press the "operation/stop" button. (Operation will start.)
- 2) Press the temperature ▲▼ button and the "operation select" button at the same time.
- 3) Press the "operation select" button twice.
(7̄ will be displayed and the unit will enter test run mode.)
- 4) Press the "operation select" button to return the operation mode to cooling.
 - Test run mode will stop automatically after around 30 minutes. To force a test run to stop, press the operation/stop button.

CAUTION

- 1) When pressing the switch, do not touch the terminal block. It has a high voltage, so doing so may cause electric shock.
- 2) After closing the liquid stop valve, close the gas stop valve within three minutes, then stop the forced operation.

Wiring

⚠ WARNING

- 1) Do not use tapped wires, stranded wires, extension cords, or starburst connections, as they may cause overheating, electrical shock, or fire.
- 2) Do not use locally purchased electrical parts inside the product. (Do not branch the power for the drain pump, etc., from the terminal block.) Doing so may cause electric shock or fire.
- 3) Be sure to install an earth leakage breaker. (One that can handle higher harmonics.)
(This unit uses an inverter, which means that it must be used an earth leakage breaker capable handling harmonics in order to prevent malfunctioning of the earth leakage breaker itself.)
- 4) Use an all-pole disconnection type breaker with at least 3mm between the contact point gaps.
- 5) Do not connect the power wire to the indoor unit. Doing so may cause electric shock or fire.

- Do not turn ON the safety breaker until all work is completed.

- 1) Strip the insulation from the wire (20mm).
- 2) Connect the connection wires between the indoor and outdoor units **so that the terminal numbers match**. Tighten the terminal screws securely. We recommend a flathead screwdriver be used to tighten the screws. The screws are packed with the terminal board.

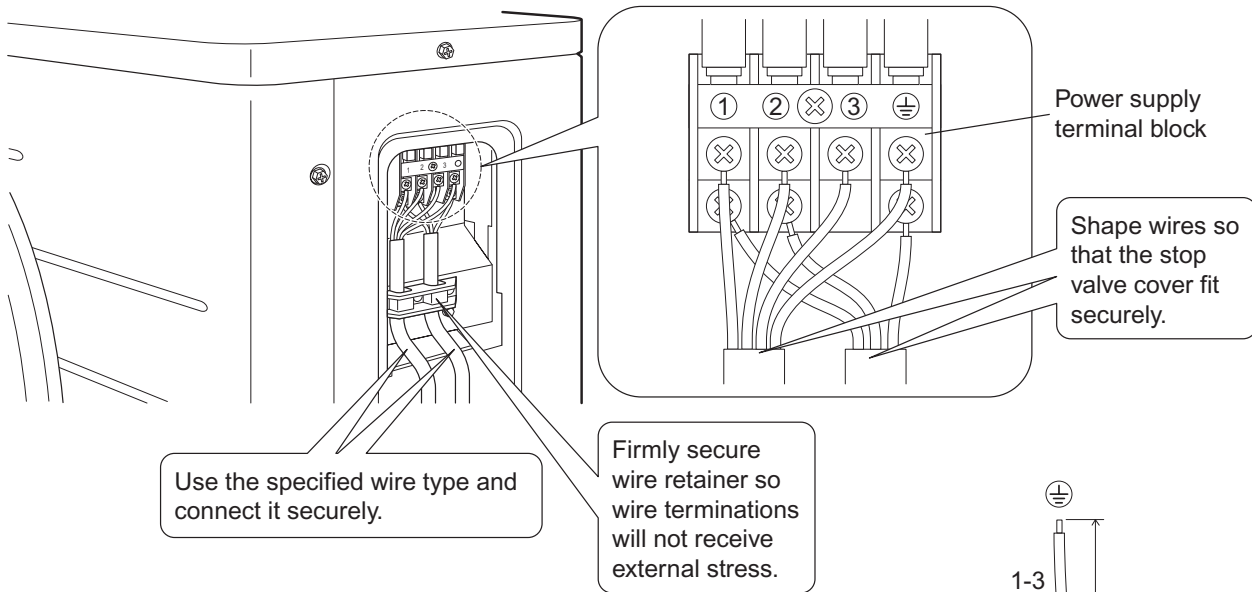
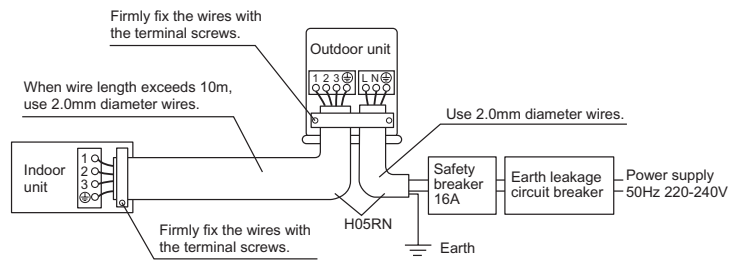

Observe the notes mentioned below when wiring to the power supply terminal board.

Precautions to be taken for power supply wiring.

Use a round crimp-style terminal for connection to the power supply terminal board. In case it cannot be used due to unavoidable reasons, be sure to observe the following instruction.

Place the round crimp-style terminals on the wires up to the covered part and secure in place.

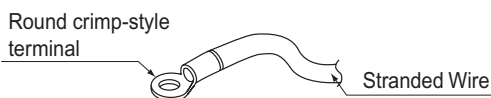
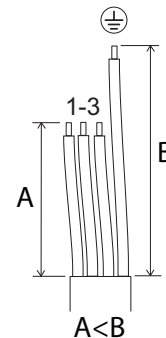

⚠ CAUTION

When connecting the connection wires to the terminal board using a single core wire, be sure to perform curling. Problems with the work may cause heat and fires.

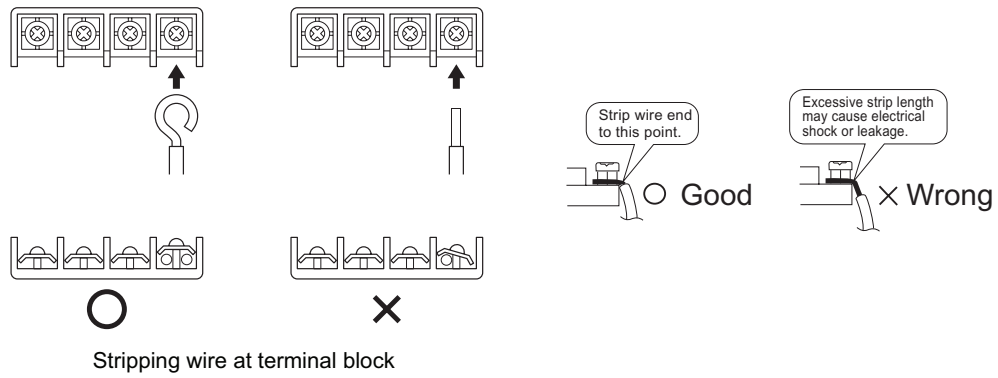

3) Pull the wire and make sure that it does not disconnect. Then fix the wire in place with a wire stop.

Test Run and Final Check

1. Trial operation and testing.

1-1 Measure the supply voltage and make sure that it falls in the specified range.

1-2 Trial operation should be carried out in either cooling or heating mode.

■ For heat pump

- In cooling mode, select the lowest programmable temperature; in heating mode, select the highest programmable temperature.

1) Trial operation may be disabled in either mode depending on the room temperature.

2) After trial operation is complete, set the temperature to a normal level (26°C to 28°C in cooling mode, 20°C to 24°C in heating mode).

3) For protection, the system disables restart operation for 3 minutes after it is turned off.

■ For cooling only

- Select the lowest programmable temperature.

1) Trial operation in cooling mode may be disabled depending on the room temperature.

2) After trial operation is complete, set the temperature to a normal level (26°C to 28°C).

3) For protection, the unit disables restart operation for 3 minutes after it is turned off.

1-3 Carry out the test operation in accordance with the operation manual to ensure that all functions and parts, such as louver movement, are working properly.

- The air conditioner requires a small amount of power in its standby mode. If the system is not to be used for some time after installation, shut off the circuit breaker to eliminate unnecessary power consumption.

- If the circuit breaker trips to shut off the power to the air conditioner, the system will restore the original operation mode when the circuit breaker is opened again.

2. Test items.

| Test items | Symptom (diagnostic display on RC) | Check |
|--|---------------------------------------|-------|
| Indoor and outdoor units are installed properly on solid bases. | Fall, vibration, noise | |
| No refrigerant gas leaks. | Incomplete cooling/heating function | |
| Refrigerant gas and liquid pipes and indoor drain hose extension are thermally insulated. | Water leakage | |
| Draining line is properly installed. | Water leakage | |
| System is properly earthed. | Electrical leakage | |
| The specified wires are used for interconnecting wire connections. | Inoperative or burn damage | |
| Indoor or outdoor unit's air intake or exhaust has clear path of air. Stop valves are opened. | Incomplete cooling/heating function | |
| Indoor unit properly receives remote controller commands. | Inoperative | |

MEMO



MEMO



MEMO



DAIKIN INDUSTRIES CZECH REPUBLIC s.r.o.

U Nove hospody 1/1155, 301 00 Pizen Skvrmany, Czech republic

DAIKIN EUROPE NV

Zandvoordestraat 300, B-8400 Ostende, Belgium

www.daikineurope.com



3P291651-10H