SPLIT SYSTEM**Air Conditioner**

English

MODELS
(Wall mounted type)

FAY71FJV1
FAY100FJV1



FAYP71BV1
FAYP100BV1

Thank you for purchasing this Daikin air conditioner. Carefully read this operation manual before using the air conditioner. It will tell you how to use the unit properly and help you if any trouble occurs. After reading the manual, file it away for future reference.

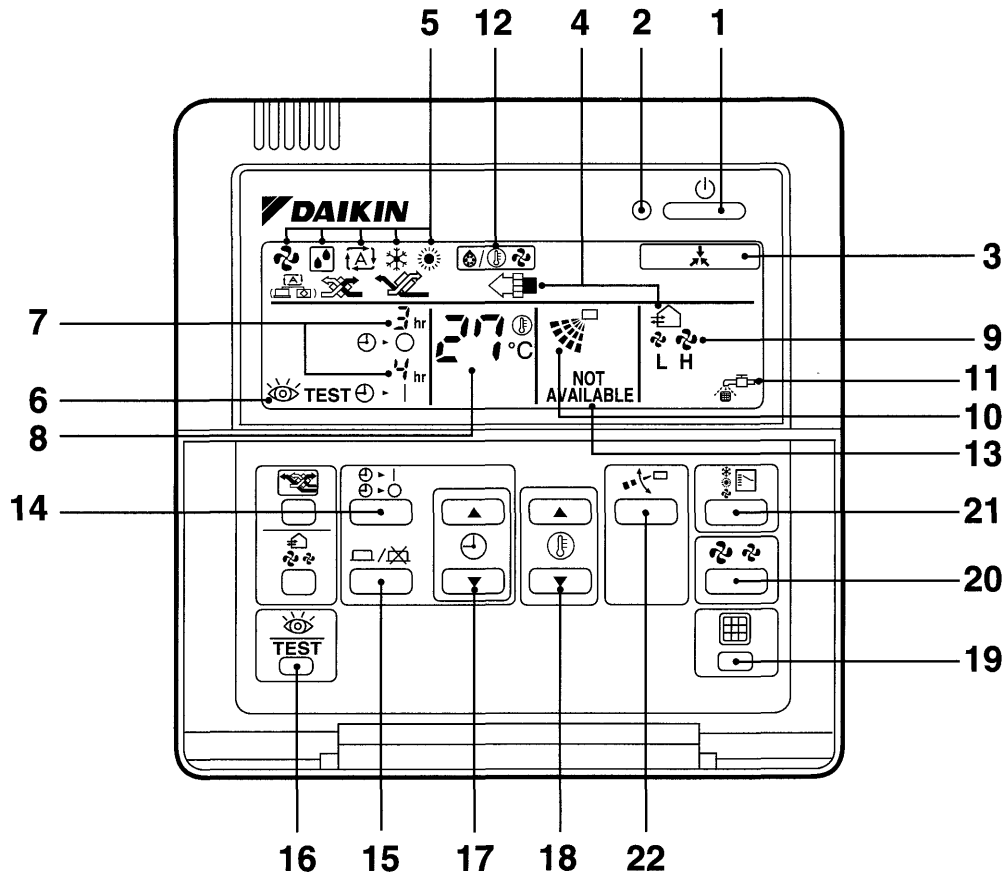

1

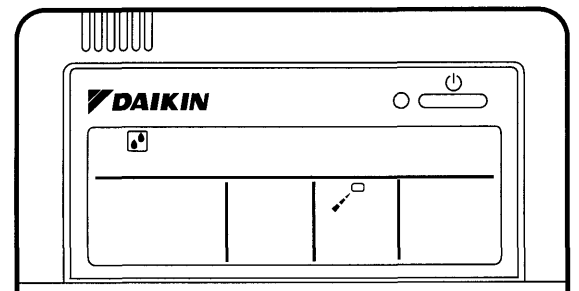
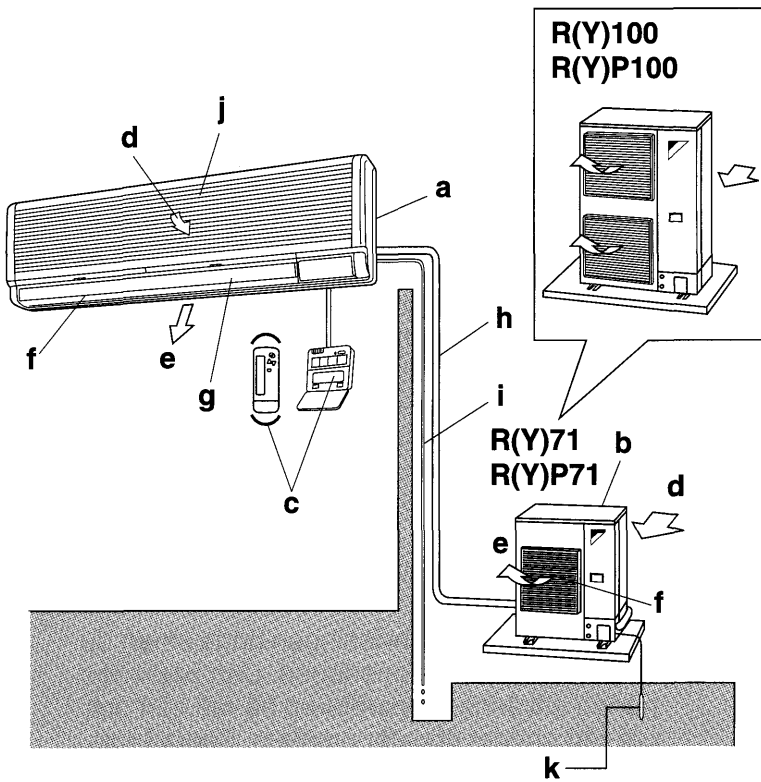

3

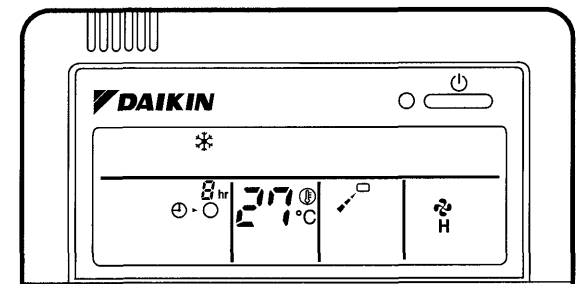

2

4

CONTENTS

ILLUSTRATION	[1]
1. WHAT TO DO BEFORE OPERATION	1
2. SAFETY CONSIDERATIONS	2
3. OPERATION RANGE	3
4. INSTALLATION SITE	3
5. NAME AND FUNCTION OF EACH SWITCH AND DISPLAY ON THE REMOTE CONTROLLER	4
6. OPERATION PROCEDURE	5
7. OPTIMUM OPERATION	7
8. MAINTENANCE (FOR SERVICE PERSONNEL)	7
9. NOT MALFUNCTION OF THE AIR CONDITIONER	8
10. TROUBLE SHOOTING	9

1. WHAT TO DO BEFORE OPERATION

This operation manual is for the following systems with standard control. Before initiating operation, contact your Daikin dealer for the operation that corresponds to your system.

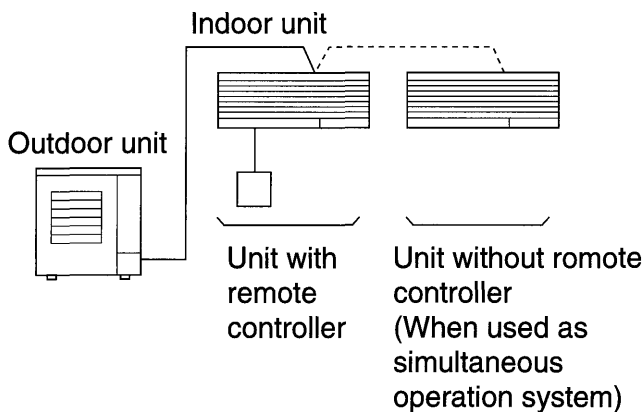

NOTE

- If the unit you purchased is controlled by a wireless remote controller, also refer to the wireless remote controller's operation manual.

If your installation has a customized control system, ask your Daikin dealer for the operation that corresponds to your system.

- Heat pump type
This system provides cooling, heating, automatic, program dry, and fan operation modes.
- Cooling only type
This system provides cooling, program dry, and fan operation modes.

PRECAUTIONS FOR GROUP CONTROL SYSTEM OR TWO REMOTE CONTROLLER CONTROL SYSTEM

This system provides two other control systems beside individual control (one remote controller controls one indoor unit) system. Confirm the following if your unit is of the following control system type.

• Group control system

- One remote controller controls up to 16 indoor units.
- All indoor units are equally set.

• Two remote controller control system

- Two remote controllers control one indoor unit (In case of group control system, one group of indoor units)
- The unit is individually operated.

NOTE

- Contact your Daikin dealer in case of changing the combination or setting of group control and two remote controller control systems.

Names and functions of parts

Refer to figure 2 on page [1]

a	Indoor unit
b	Outdoor unit
c	Remote controller
d	Inlet air
e	Discharged air
f	Air outlet
g	Air flow flap (at air outlet)
h	Refrigerant piping, connection electric wire
i	Drain pipe
j	Air inlet The built-in air filter removes dust and dirt.
k	Ground wire Wire to ground from the outdoor unit to prevent electrical shocks.

2. SAFETY CONSIDERATIONS

We recommend that you read this instruction manual carefully before use to gain full advantage of the function of the air conditioner, and to avoid malfunction due to mishandling.

This air conditioner comes under the term “appliances not accesible to the general public”.

- **The precautions described below are WARNING and CAUTION. These are very important precautions concerning safety. Be sure to observe all of them without fail.**

⚠ WARNING .. These are the matters with possibilities leading to serious consequences such as death or serious injury due to erroneous handling.

⚠ CAUTION ... These are the matters with possibilities leading to injury or material damage due to erroneous handling including probabilities leading to serious consequences in some cases.

- **After reading, keep this manual at a place where any user can read at any time. Furthermore, make certain that this operation manual is handed to a new user when he takes over the operation.**

⚠ WARNING

Avoid exposure of your body directly to the cold air for a long time, or avoid excessive exposure of your body to the cold air.

Otherwise, your physical condition may be deteriorated and/or your health may be ruined.

When the air conditioner is in abnormal conditions (smell of something burning, etc), unplug the power cord from the outlet, and contact the dealer where you purchased the air conditioner.

Continued operation under such circumstances may result in a failure, electric shock, and fire.

Ask your dealer for installation of the air conditioner.

Incomplete installation performed by yourself may result in a water leakage, electric shock, and fire.

Ask your dealer for improvement, repair, and maintenance.

Incomplete improvement, repair, and maintenance may result in a water leakage, electric shock, and fire.

Do not insert your finger, a stick, etc., into the air inlet, outlet, and fan blades.

A fan in high-speed running may result in injury.

For refrigerant leakage, consult your dealer.

When the air conditioner is to be installed in a small room, it is necessary to take proper measures so that the amount of any leaked refrigerant does not exceed the limiting concentration even when it leaks. If the refrigerant leaks exceeding the level of limiting concentration, an oxygen deficiency accident may happen.

For installation of separately sold component parts, ask a specialist.

Be sure to use the separately sold component parts designated by our company.

Incomplete installation performed by yourself may result in a water leakage, electric shock, and fire.

Ask your dealer to move and reinstall the air conditioner.

Incomplete installation may result in a water leakage, electric shock, and fire.

⚠ CAUTION

Do not use the air conditioner for other purposes.

Do not use the air conditioner for a special application such as the storage of foods, animals and plants, precision machines, and art objects as otherwise the deterioration of quality may result.

Do not remove the air outlet of the outdoor unit.

The fan may get exposed and result in injury.

When the air conditioner is used in combination with burners or heaters, perform sufficient ventilation.

Insufficient ventilation may result in an oxygen deficiency accident.

Check and make sure that foundation blocks are not damaged after a long use.

If they are left in a damaged condition, the unit may fall and result in injury.

Neither place a flammable spray bottle near the air conditioner nor perform spraying.

Doing so may result in a fire.

To clean the air conditioner, stop operation, and unplug the power cord from the outlet.

Otherwise, an electric shock and injury may result.

Do not operate the air conditioner with a wet hand.

An electric shock may result.

Do not use any fuse with improper capacity.

The use of a piece of wire and whatnot may result in a failure and fire.

Do not place a burner or heater at a place directly exposed to the wind from the air conditioner.

Incomplete combustion of the burner or heater may result.

Do not allow a child to mount on the outdoor unit or avoid placing any object on it.

Falling or tumbling may result in injury.

Do not expose animals and plants directly to the wind.

Adverse influence to animals and plants may result.

Do not wash the air conditioner with water.

An electric shock may result.

Do not install the air conditioner at any place where flammable gas may leak out.

If the gas leaks out and stays around the air conditioner, a fire may break out.

Be sure to install an earth leakage breaker.

Unless it is installed, an electric shock may result.

Be sure the air conditioner is electrically grounded.

Do not connect the grounding conductor to a gas pipe, water pipe, lightning arrester, and the grounding conductor for a telephone.

Imperfect grounding work may result in an electric shock.

Execute complete drain piping for perfect drainage.

Incomplete piping may result in a water leakage.

WB: Wet bulb temperature

The setting temperature range of the remote controller is 16°C to 32°C.

4. INSTALLATION SITE

Regarding places for installation

- **Is the air conditioner installed at a well-ventilated place where there are no obstacles around?**
- **Do not use the air conditioner in the following places.**
 - a. Filled with much mineral oil such as cutting oil
 - b. Where there is much salt such as a beach area
 - c. Where sulfured gas exists such as a hot-spring resort
 - d. Where there are considerable voltage fluctuations such as a factory or plant
 - e. Vehicles and vessels
 - f. Where there is much spray of oil and vapor such as a cookery, etc.
 - g. Where there are machines generating electromagnetic waves
 - h. Filled with acid and/or alkaline steam or vapor
- **Is a snow protection measure taken?**
For details, consult your dealer.

Regarding wiring

- **All wiring must be performed by an authorized electrician.**
To do wiring, ask your dealer. Never do it by yourself.
- **Make sure that a separate power supply circuit is provided for this air conditioner and that all electrical work is carried out by qualified personnel according to local laws and regulations.**

Pay attention to running noises, too

- **Are the following places selected?**
 - a. A place that can sufficiently withstand the weight of the air conditioner with less running noises and vibrations.
 - b. A place where the hot wind discharged from the air outlet of the outdoor unit and the running noises.
- **Are you sure that there are no obstacles near the air outlet of the outdoor unit?**
Such obstacles may result in declined performance and increased running noises.
- **If abnormal noises occur in use, consult your dealer.**

3. OPERATION RANGE

If the temperature or the humidity is beyond the following conditions, safety devices may work and the air conditioner may not operate, or sometimes, water may drop from the indoor unit.

COOLING

	OUT-DOOR UNIT	INDOOR		OUTDOOR TEMPERATURE (°C)		
		TEMPERATURE (°C)	HUMIDITY			
COOLING ONLY TYPE	R71, 100 RP71, 100	D B	20 to 35	80% or below	D B	- 15 to 46
		W B	14 to 25			
HEAT PUMP TYPE	RY71, 100 RYP71, 100	D B	18 to 35	80% or below	D B	- 5 to 46
		W B	12 to 25			

HEATING

	OUT-DOOR UNIT	INDOOR TEMPERATURE (°C)		OUTDOOR TEMPERATURE (°C)	
HEAT PUMP TYPE	RY71, 100 RYP71, 100	D B	15 to 27	D B	- 9 to 21
				W B	- 10 to 15.5

DB: Dry bulb temperature

Regarding drainage of drain piping















- Is the drain piping executed to perform complete drainage?





If proper drainage is not carried out from the outdoor drain pipes during air-conditioning operation, chances are that dust and dirt are clogged in the pipe. This may result in a water leakage from the indoor unit. Under such circumstances, stop the operation of the air conditioner, and then consult your dealer or our service station.

5. NAME AND FUNCTION OF EACH SWITCH AND DISPLAY ON THE REMOTE CONTROLLER

Refer to figure 1 on page [1]

The illustrations in this operating manual correspond to the remote control format BRC1C type. Although the display and shape of the buttons on the BRC1B type are slightly different, they may be operated in the same manner.

	ON/OFF BUTTON
1	Press the button and the system will start. Press the button again and the system will stop.
2	OPERATION LAMP (RED) The lamp lights up during operation.
3	DISPLAY “” (UNDER CENTRALIZED CONTROL) When this display shows, the system is UNDER CENTRALIZED CONTROL.
4	DISPLAY “” “” “” “” (VENTILATION/AIR CLEANING) This display shows that the total heat exchange and the air cleaning unit are in operation (These are optional accessories).
5	DISPLAY “” “” “” “” “” (OPERATION MODE) This display shows the current OPERATION MODE. For cooling only type, “  ” (Auto) and “  ” (Heating) are not installed.
6	DISPLAY “ TEST” (INSPECTION/TEST OPERATION) When the INSPECTION/TEST OPERATION BUTTON is pressed, the display shows the system mode is in.
7	DISPLAY “” (PROGRAMMED TIME) This display shows the PROGRAMMED TIME of the system start or stop.
8	DISPLAY “” (SET TEMPERATURE) This display shows the set temperature.

9	DISPLAY “” (FAN SPEED) This display shows the set fan speed.
10	DISPLAY “” (AIR FLOW FLAP) Refer to “ADJUSTING THE AIR FLOW DIRECTION”.
11	DISPLAY “” (TIME TO CLEAN AIR FILTER) Refer to “HOW TO CLEAN THE AIR FILTER”.
12	DISPLAY “” (DEFROST) Refer to “DEFROST OPERATION”.
13	NON-FUNCTIONING DISPLAY If that particular function is not available, pressing the button may display the words “NOT AVAILABLE” for a few seconds. When running multiple units simultaneously The “NOT AVAILABLE” message will only be appear if none of the indoor units is equipped with the function. If even one unit is equipped with the function, the display will not appear.
14	TIMER MODE START/STOP BUTTON Refer to “PROGRAM TIMER OPERATION”.
15	TIMER ON/OFF BUTTON Refer to “PROGRAM TIMER OPERATION”.
16	INSPECTION/TEST OPERATION BUTTON This button is used only by qualified service persons for maintenance purposes.
17	PROGRAMMING TIME BUTTON Use this button for programming “START and/or STOP” time.
18	TEMPERATURE SETTING BUTTON Use this button for SETTING TEMPERATURE.
19	FILTER SIGN RESET BUTTON Refer to “HOW TO CLEAN THE AIR FILTER”.
20	FAN SPEED CONTROL BUTTON Press this button to select the fan speed, HIGH or LOW, of your choice.
21	OPERATION MODE SELECTOR BUTTON Press this button to select OPERATION MODE.
22	AIR FLOW DIRECTION ADJUST BUTTON Refer to “ADJUSTING THE AIR FLOW DIRECTION”.
NOTE • For the sake of explanation, all indications are shown on the display in figure 1 contrary to actual running situations.	

6. OPERATION PROCEDURE

Refer to figure 1 on page [1]

- Operating procedure varies with heat pump type and cooling only type. Contact your Daikin dealer to confirm your system type.
- To protect the unit, turn on the main power switch 6 hours before operation.
- If the main power supply is turned off during operation, operation will restart automatically after the power turns back on again.

COOLING, HEATING, AUTOMATIC, FAN, AND PROGRAM DRY OPERATION

Operate in the following order.

1 OPERATION MODE SELECTOR

Press **OPERATION MODE SELECTOR** button several times and select the **OPERATION MODE** of your choice as follows.

- COOLING OPERATION “ ❄ ”
- HEATING OPERATION “ ☀ ”
- AUTOMATIC OPERATION “ Ⓜ ”
 - In this operation mode, COOL/HEAT changeover is automatically conducted.
- FAN OPERATION “ 🌀 ”
- DRY OPERATION “ 🌬 ”
 - The function of this program is to decrease the humidity in your room with the minimum temperature decrease.
 - Micro computer automatically determines TEMPERATURE and FAN SPEED.
 - This system does not go into operation if the room temperature is below 16°C.

Refer to figure 3 on page [1]

- For cooling only type, “COOLING”, “FAN” and “DRY” operation are able to select.

2 ON/OFF

Press **ON/OFF** button
OPERATION lamp lights up or goes off and the system starts or stops OPERATION.

[EXPLANATION OF HEATING OPERATION]

DEFROST OPERATION

- As the frost on the coil of an outdoor unit increase, heating effect decreases and the system goes into DEFROST OPERATION.
- The indoor unit fan stops and the remote controller display shows “ ❄🌬🌀 ”.

- After 6 to 8 minutes (maximum 10 minutes) of DEFROST OPERATION, the system returns to HEATING OPERATION.

Regarding outside air temperature and heating capacity

- The heating capacity of the air conditioner declines as the outside air temperature falls. In such a case, use the air conditioner in combination with other heating systems.
- A warm air circulating system is employed, and therefore it takes some time until the entire room is warmed up after the start of operation.
- An indoor fan runs to discharge a gentle wind automatically until the temperature inside the air conditioner reaches a certain level. At this time, the remote controller displays “ 🌬🌡🌀 ”. Leave it as it stands and wait for a while.
- When the warm air stays under the ceiling and your feet are cold, we recommend that you use a circulator (a fan to circulate the air inside the room). For details, consult your dealer.

ADJUSTMENT

For programming TEMPERATURE, FAN SPEED and AIR FLOW DIRECTION, follow the procedure shown below.



TEMPERATURE SETTING

Press **TEMPERATURE SETTING** button and program the setting temperature.

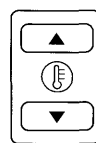

Each time this button is pressed, setting temperature rises 1°C.

Each time this button is pressed, setting temperature lowers 1°C.

- The setting is impossible for fan operation.

NOTE

- The setting temperature range of the remote controller is 16°C to 32°C.



FAN SPEED CONTROL

Press **FAN SPEED CONTROL** button.
High or Low fan speed can be selected.
The microchip may sometimes control the fan speed in order to protect the unit.



AIR FLOW DIRECTION ADJUST

- There are 2 ways of adjusting the air discharge angle.

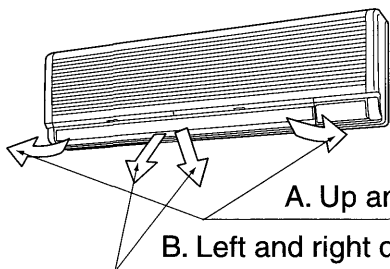

A. Up and down adjustment

B. Left and right direction

A. UP AND DOWN DIRECTION

Press the AIR FLOW DIRECTION ADJUST button to select the air direction as shown below.

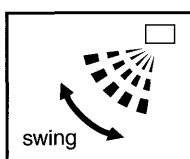

The AIR FLOW FLAP display swings as shown below and the air flow direction continuously varies. (Automatic swing setting)



Press AIR FLOW DIRECTION ADJUST button to select the air direction of your choice.

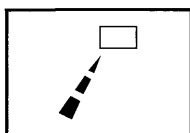

The AIR FLOW FLAP display stops swinging and the air flow direction is fixed (Fixed air flow direction setting).

MOVEMENT OF THE AIR FLOW FLAP

For the following conditions, micro computer controls the air flow direction so it may be different from the display.

Operation mode	Cooling	Heating
Operation condition	<ul style="list-style-type: none"> • When room temperature is lower than the set temperature • When operating continuously at horizontal air flow direction 	<ul style="list-style-type: none"> • When room temperature is higher than the set temperature • At defrost operation

Operation mode includes automatic operation.

Recommended flap positions

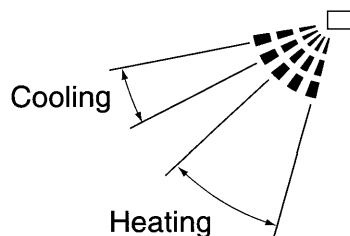

We recommend using the fan in the position listed above when fixing the fan direction.

B. LEFT AND RIGHT DIRECTION

Grasp the air flow blades at the tip and move the blades to the left and right.

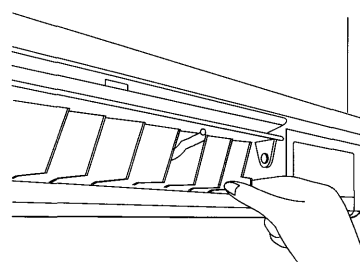

NOTE

- Only make adjustments after you have stopped the air flow direction swing in a position where adjustments are possible. Your hand may get caught if you attempt to make adjustments while the unit is swinging.

PROGRAM TIMER OPERATION

Operate in the following order.

- The timer is operated in the following two ways.
- Programming the stop time (⊕ - ○)
The system stops operating after the set time has elapsed.
- Programming the start time (⊕ - |)
The system starts operating after the set time has elapsed.
- The timer can be programmed a maximum of 72 hours.
- The start and the stop time can be simultaneously programmed.

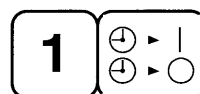

TIMER MODE START/STOP

Press the TIMER MODE START/STOP button several times and select the mode on the display.

The display flashes.

For setting the timer stop "⊕ - ○"

For setting the timer start "⊕ - |"

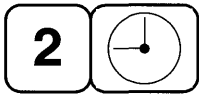

PROGRAMMING TIME

Press the **PROGRAMMING TIME** button and set the time for stopping or starting the system.

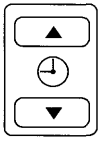

When this button is pressed, the time advances by 1 hour.

When this button is pressed, the time goes backward by 1 hour.



TIMER ON/OFF

Press the **TIMER ON/OFF** button.

The timer setting procedure ends.

The display “⊕ - ○ or ⊕ - |” changes from flashing light to a constant light.

Refer to figure 4 on page [1]

NOTE

- When setting the timer Off and On at the same time, repeat the above procedure from 1 to 3 once again.

When the timer is programmed to stop the system after 3 hours and start the system after 4 hours, the system will stop after 3 hours and then 1 hour later the system will start.

- After the timer is programmed, the display shows the remaining time.
- Press the **TIMER ON/OFF** button once again to cancel programming. The display vanishes.

7. OPTIMUM OPERATION

Observe the following precautions to ensure the system operates.

- Adjust the room temperature properly for a comfortable environment. Avoid excessive heating or cooling.
- Prevent direct sunlight from entering a room during cooling operation by using curtains or blinds.
- Ventilate the room regularly.
Using the unit for long periods of time requires attentive ventilation of the room.
- Do not place items that might be damaged by water under the indoor unit.
Water may condensate and drip if the humidity reaches 80% or if the drain exit gets clogged.

- Keep doors and windows closed. If the doors and windows remain open, room air will flow out and cause to decrease the effect of cooling and heating.
- Do not place other heaters directly below the indoor unit.
They may deform due to the heat.
- Never place objects near the air inlet and the air outlet of the unit. It may cause deterioration in the effect or stop in the operation.
- Turn off the main power supply switch when it is not used for long periods of time. When the main power switch is turned on, some watts of electricity is being used even if the system is not operating. Turn off the main power supply switch for saving energy. When reoperating, turn on the main power supply switch 6hours before operation for smooth running (Refer to MAINTENANCE).
- When the display shows “” (TIME TO CLEAN AIR FILTER), ask a qualified service person to clean the filters (Refer to MAINTENANCE).

8. MAINTENANCE (FOR SERVICE PERSONNEL)

ONLY A QUALIFIED SERVICE PERSON IS ALLOWED TO PERFORM MAINTENANCE

IMPORTANT!

- **BEFORE OBTAINING ACCESS TO TERMINAL DEVICES, ALL POWER SUPPLY CIRCUITS MUST BE INTERRUPTED**
- To clean the air conditioner, be sure to stop operation, and turn the power switch off. Otherwise, an electric shock and injury may result.
- Do not wash the air conditioner with water
Doing so may result in an electric shock.
- Be careful with a scaffold or staging
Caution must be exercised because of work at a high place.

HOW TO CLEAN THE AIR FILTER

Clean the air filter when the display shows “” (TIME TO CLEAN AIR FILTER).

Increase the frequency of cleaning if the unit is installed in a room where the air is extremely contaminated.

(As a yardstick for regulating yourself, consider cleaning the filter once every two weeks.)

1. Remove the air filters.

Pull the handle in the direction of the arrow.

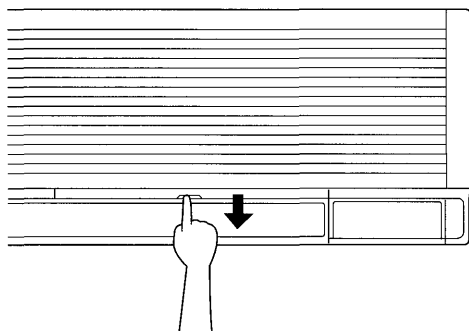

2. Clean the air filter.

Use vacuum cleaner **A)** or wash the air filter with water **B)**.

A) Using a vacuum cleaner

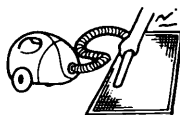

B) Washing with water

When the air filter is very dirty, use soft brush and neutral detergent.



Remove water and dry in the shade.

NOTE

- Do not wash the air conditioner with hot water of more than 50°C, as doing so may result in discoloration and/or deformation.
- Do not expose it to fire, as doing so may result in burning.

3. Reset the air filter in place.

After cleaning the filter, do not forget to put it back the way it was before.

4. Press the **FILTER RESET** button on the remote controller.

The display “” (TIME TO CLEAN AIR FILTER) vanishes.

HOW TO CLEAN AIR OUTLET AND OUTSIDE PANELS

- Clean with soft cloth.
- When it is difficult to remove stains, use water or neutral detergent.

NOTE

- Do not use gasoline, benzene, thinner, polishing powder, liquid insecticide. It may cause discoloring or warping.
- Do not use water or air of 50°C or higher for cleaning air filters and outside panels.

START UP AFTER A LONG STOP

Confirm the following

- Check that the air inlet and outlet are not blocked. Remove any obstacle.
- Check if the earth is connected. Might there be a broken wire somewhere? Contact your dealer if there are any problems.

Clean the air filter and outside panels

- After cleaning the air filter, make sure to attach it.

Turn on the main power supply switch

- The display on the remote controller will be shown when the power is turned on.
- To protect the unit, turn on the main power switch at least 6 hours before operation.

WHAT TO DO WHEN STOPPING THE SYSTEM FOR A LONG PERIOD

Turn on **FAN OPERATION** for a half day and dry the unit.

- Refer to “FAN OPERATION”.

Cut off the power supply.

- When the main power switch is turned on, some watts of electricity is being used even if the system is not operating. Turn off the main power supply switch for saving energy.
- The display on the remote controller will vanish when the main power switch is turned off.

Clean the air filter and the exterior.

- Be sure to replace the air filter to its original place after cleaning. Refer to “MAINTENANCE”.

9. NOT MALFUNCTION OF THE AIR CONDITIONER

The following symptoms do not indicate air conditioner malfunction

I. THE SYSTEM DOES NOT OPERATE

- **The system does not restart immediately after the ON/OFF button is pressed.**

If the OPERATION lamp lights, the system is in normal condition.

It does not restart immediately because a safety device operates to prevent overload of the system. After 3 minutes, the system will turn on again automatically.

- **The system does not restart immediately when TEMPERATURE SETTING button is returned to the former position after pushing the button.**

If the OPERATION lamp lights, the system is in normal condition.

It does not restart immediately because a safety device operates to prevent overload of the system. After 3 minutes, the system will turn on again automatically.

- **The system does not start when the display shows “” (UNDER CENTRALIZED CONTROL) and it flashes for few seconds after pressing an operation button.**

This is because the system is under centralized control. Flashes on the display indicates that the system cannot be controlled by the remote controller.

- **The system does not start immediately after the power supply is turned on.**

Wait one minute until the micro computer is prepared for operation.

II. WHITE MIST COMES OUT OF A UNIT

- **When humidity is high during cooling operation (In oily or dusty places)**

If the inside of an indoor unit is extremely contaminated, the temperature distribution inside a room becomes uneven. It is necessary to clean the inside of the indoor unit. Ask your Daikin dealer for details on cleaning the unit. This operation requires a qualified service person.

- **When the system is changed over to HEATING OPERATION after DEFROST OPERATION.**

Moisture generated by DEFROST becomes steam and exists.

III. NOISE OF AIR CONDITIONERS

- **A ringing sound after the unit is started.**

This sound is generated by the temperature regulator working.

It will quiet down after about a minute.

- **A continuous flow “Shuh” sound is heard when the systems is in COOLING or DEFROST OPERATION.**

This is the sound of refrigerant gas flowing through both indoor and outdoor units.

- **A “Shuh” sound which is heard at the start or immediately after the stop of operation or which is heard at the start or immediately after the stop of DEFROST OPERATION.**

This is the noise of refrigerant caused by flow stop and flow change.

- **A continuous low “Shah” sound is heard when the system is in COOLING OPERATION or at a stop.**

The noise is heard when the drain pump is in operation.

- **A “Pishi-pishi” squeaking sound is heard when the system is in operation or after the stop of operation.**

Expansion and contraction of plastic parts caused by temperature change makes this noise.

IV. DUST FROM THE UNITS

- **Dust may blow out from the unit after starting operation from long resting time.**

Dust absorbed by the unit blows out.

V. THE UNITS GIVE OFF ODORS

The unit absorbs the smell of rooms, furniture, cigarettes, etc., and then emits them.

VI. THE LIQUID CRYSTAL OF THE REMOTE CONTROLLER SHOW “”

- **It happens immediately after the main power supply switch is turned on.**

This shows that the remote controller is in normal condition.

This continues temporary.

10. TROUBLE SHOOTING

- I. **If one of the following malfunctions occurs, take the measures shown below and contact your Daikin dealer.**

The system must be repaired by a qualified service person.

WARNING

When the air conditioner is in abnormal conditions (smell of something burning, etc), unplug the power cord from the outlet, and contact your dealer

Continued operation under such circumstances may result in a failure, electric shock, and fire.

- If a safety device such as a fuse, a breaker, or an earth leakage breaker frequently actuates, or ON/OFF switch does not properly work.

Measure: Turn off the main power switch

- If water leaks from unit.

Measure: Stop the operation.

- If the display “” (INSPECTION), “UNIT No.”, and the OPERATION lamp flash and the “MAL-FUNCTION CODE” appears.

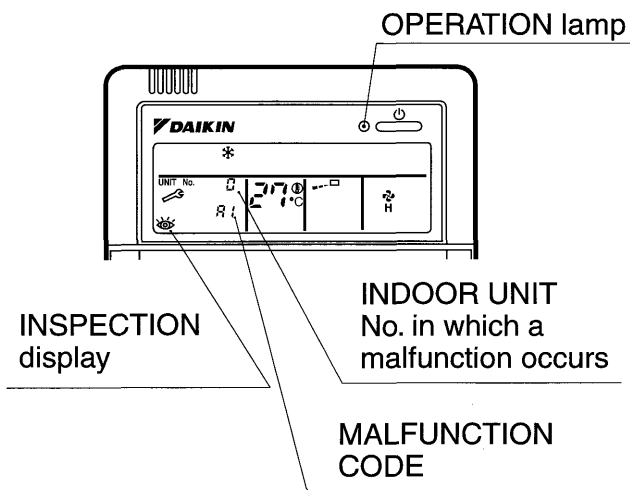

Measure: Notify your Daikin dealer and inform him/her of the display.

II. If the system does not properly operate except for the above mentioned case, and none of the above mentioned malfunctions is evident, investigate the system according to the following procedures.

1. If the system does not operate at all.

- Check if there is a power failure.
Wait until power is restored. If power failure occurs during operation, the system automatically restarts immediately after the power supply recovers.
- Check if the fuse has blown or breaker has worked.
Change the fuse or set the breaker.

2. If the system stops operating after operating the system.

- Check if the air inlet or outlet of outdoor or indoor unit is blocked by obstacles.
Remove the obstacle and make it well-ventilated.
- Check if the air filter is clogged.
Ask a qualified service person to clean the air filters (Refer to MAINTENANCE).

3. The system operates but it does not sufficiently cool or heat.

- If the air inlet or outlet of the indoor or the outdoor unit is blocked with obstacles.
Remove the obstacle and make it well-ventilated.
- If the air filter is clogged.
Ask a qualified service person to clean the air filters (Refer to MAINTENANCE).
- If the set temperature is not proper (Refer to ADJUSTMENT).
- If the FAN SPEED button is set to LOW SPEED (Refer to ADJUSTMENT).

- If the air flow angle is not proper (Refer to ADJUSTING THE AIR FLOW DIRECTION).
- If the doors or the windows are open. Shut doors or windows to prevent wind from coming in.
- If direct sunlight enters the room (when cooling).
Use curtains or blinds.
- When there are too many inhabitants in the room (when cooling).
Cooling effect decreases if heat gain of the room is too large.
- If the heat source of the room is excessive (when cooling).
Cooling effect decreases if heat gain of the room is too large.

DAIKIN INDUSTRIES, LTD.

Head office:
Umeda Center Bldg., 4-12, Nakazaki-Nishi 2 chome,
Kita-ku, Osaka, 530-8323 Japan

Tokyo office:
Shinjuku Sumitomo Bldg., 6-1 Nishi-Shinjuku
2-chome, Shinjuku-ku, Tokyo, 163-0290 Japan

DAIKIN EUROPE NV

Zandvoordestraat 300, B-8400 Oostende, Belgium