

DAIKIN



INSTALLATION MANUAL

Split System air conditioners

**FBQ35D2VEB
FBQ50D2VEB
FBQ60D2VEB
FBQ71D2VEB
FBQ100D2VEB
FBQ125D2VEB
FBQ140D2VEB**

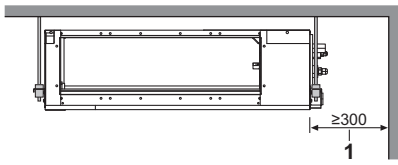

1

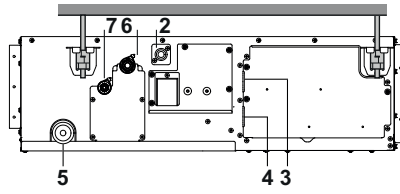

2

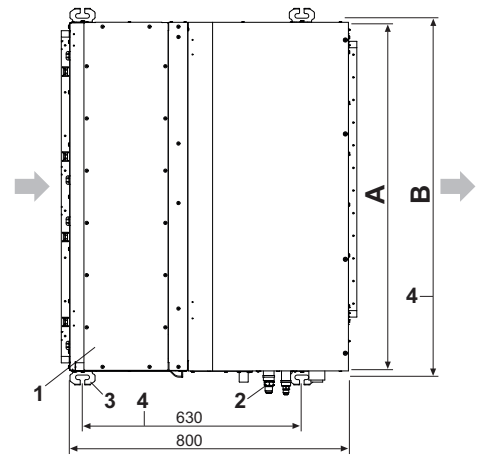

5

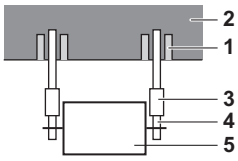

3

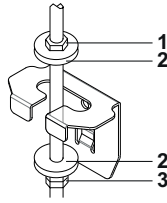

4

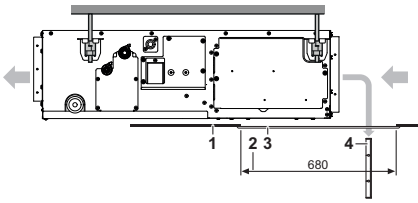

6a

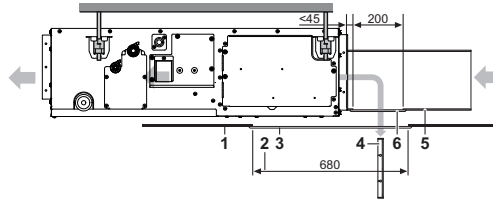

6b

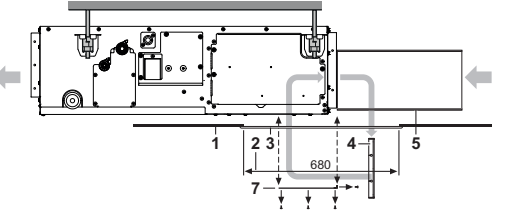

6c

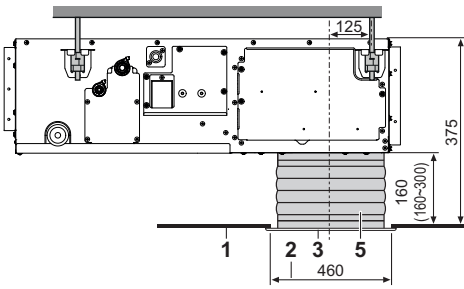

7a

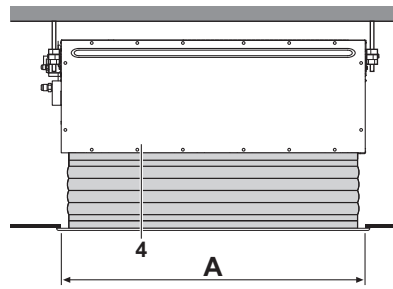

7b

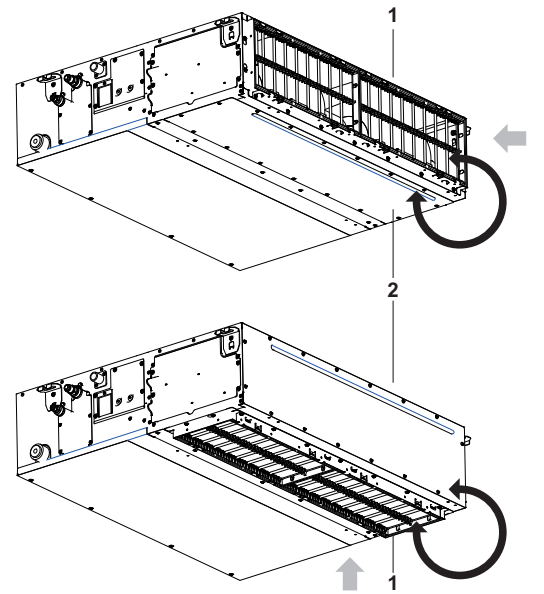

7c

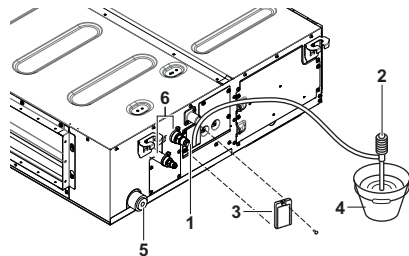

8

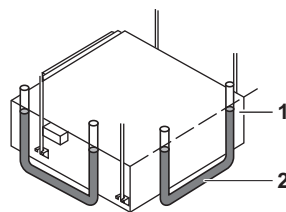

9

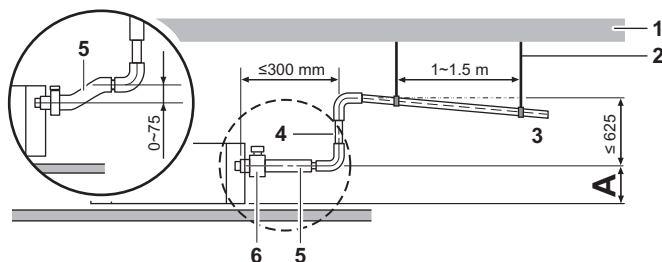

10

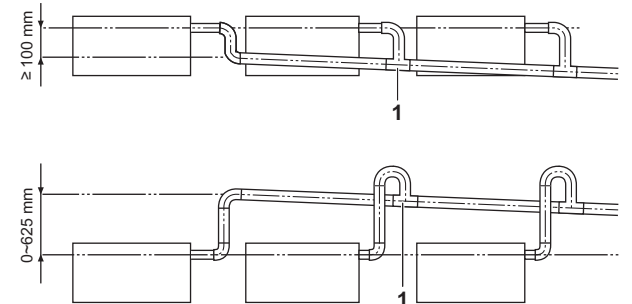

11

Contents

	Page
Before installation.....	1
Selecting installation site.....	2
Preparations before installation.....	2
Indoor unit installation.....	3
Installing the duct.....	3
Refrigerant piping work.....	4
Drain piping work.....	5
Electric wiring work.....	6
Wiring example and how to set the remote controller.....	7
Wiring example.....	8
Installation of the decoration panel.....	10
Test operation.....	10
Wiring diagram.....	11

The English text is the original instruction. Other languages are translations of the original instructions.



READ THESE INSTRUCTIONS CAREFULLY BEFORE INSTALLATION. KEEP THIS MANUAL IN A HANDY PLACE FOR FUTURE REFERENCE.

IMPROPER INSTALLATION OR ATTACHMENT OF EQUIPMENT OR ACCESSORIES COULD RESULT IN ELECTRIC SHOCK, SHORT-CIRCUIT, LEAKS, FIRE OR OTHER DAMAGE TO THE EQUIPMENT. BE SURE ONLY TO USE ACCESSORIES MADE BY DAIKIN WHICH ARE SPECIFICALLY DESIGNED FOR USE WITH THE EQUIPMENT AND HAVE THEM INSTALLED BY A PROFESSIONAL.

IF UNSURE OF INSTALLATION PROCEDURES OR USE, ALWAYS CONTACT YOUR DAIKIN DEALER FOR ADVICE AND INFORMATION.

Before installation







- Leave the unit inside its packaging until you reach the installation site. Where unpacking is unavoidable, use a sling of soft material or protective plates together with a rope when lifting, this to avoid damage or scratches to the unit. When unpacking the unit or when moving the unit after unpacking, be sure to lift the unit by holding on to the hanger bracket without exerting any pressure on other parts, especially on refrigerant piping, drain piping and other resin parts.
- Refer to the installation manual of the outdoor unit for items not described in this manual.
- Caution concerning refrigerant series R410A:
 The connectable outdoor units must be designed exclusively for R410A.

Precautions

- Do not install or operate the unit in rooms mentioned below.
 - Places with mineral oil, or filled with oil vapour or spray like in kitchens. (Plastic parts may deteriorate.)
 - Where corrosive gas like sulphurous gas exists. (Copper tubing and brazed spots may corrode.)
 - Where volatile flammable gas like thinner or gasoline is used.
 - Where machines generating electromagnetic waves exist. (Control system may malfunction.)
 - The unit should be installed at least 2.5 m from the floor.
 - Where the air contains high levels of salt such as air near the ocean and where voltage fluctuates a lot (e.g. in factories). Also in vehicles or vessels.
- Do not install accessories on the casing directly. Drilling holes in the casing may damage electrical wires and consequently cause fire.
- Sound pressure level is less than 70dB(A).

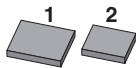
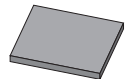
Accessories

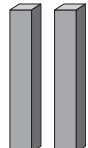
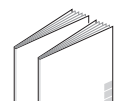
Check if the following accessories are included with your unit.

 Metal clamp 1 piece	 Drain hose 1 piece	 Washer for hanging bracket 8 pieces	 Medium sealing pad 2 pieces
 Large sealing pad 1 piece	 Insulation for fitting for liquid pipe 1 piece  for gas pipe 1 piece	 Long sealing 2 pieces	 Installation and operation manual
 Screws for duct flanges 1 set 40 pieces.			 4 tie wraps

Screws for fixing panels are attached to the air inlet panel.

Optional accessories

- There are two types of remote controllers: wired and wireless. Select a remote controller according to customers request and install in an appropriate place. Refer to catalogues and technical literature for selecting a suitable remote controller.
- When installing bottom suction: air inlet panel and canvas connection for the air inlet panel.

For the following items, take special care during construction and check after installation is finished

Tick ✓ when checked	
<input type="checkbox"/>	Is the indoor unit fixed firmly? The unit may drop, vibrate or make noise.
<input type="checkbox"/>	Is the gas leak test finished? It may result in insufficient cooling or heating.
<input type="checkbox"/>	Is the unit fully insulated and checked for air leaks? Condensate water may drip.
<input type="checkbox"/>	Does drainage flow smoothly? Condensate water may drip.
<input type="checkbox"/>	Does the power supply voltage correspond to that shown on the name plate? The unit may malfunction or components may burn out.
<input type="checkbox"/>	Are wiring and piping correct? The unit may malfunction or components may burn out.
<input type="checkbox"/>	Is the unit safely grounded? Dangerous at electric leakage.
<input type="checkbox"/>	Is the wiring size according to specifications? The unit may malfunction or components may burn out.
<input type="checkbox"/>	Is nothing blocking the air outlet or inlet of either the indoor or outdoor units? It may result in insufficient cooling or heating.
<input type="checkbox"/>	Are refrigerant piping length and additional refrigerant charge noted down? The refrigerant charge in the system might not be clear. This to avoid confusion for future maintenance and serving of the installation.
<input type="checkbox"/>	Are the air filters fixed properly (when installing with rear duct)? Maintenance of the air filters can be impossible.
<input type="checkbox"/>	Is the external static pressure set? It may result in insufficient cooling or heating.

Notes to the installer

- Read this manual carefully to ensure correct installation. Be sure to instruct the customer how to properly operate the system and show him/her the enclosed operation manual.
- Explain to the customer what system is installed on the site. Be sure to fill out the appropriate installation specifications in the chapter "What to do before operation" of the operation manual.

Selecting installation site (See figure 1 and 2)

- Select an installation site where the following conditions are fulfilled and that meets your customer's approval.
 - Where optimum air distribution can be ensured.
 - Where nothing blocks air passage.
 - Where condensate water can be properly drained.
 - Where the false ceiling is not noticeably on an incline.
 - Where sufficient clearance for maintenance and service can be ensured.
 - Where there is no risk of flammable gas leaking.
 - The equipment is not intended for use in a potentially explosive atmosphere.
 - Where piping between indoor and outdoor units is possible within the allowable limit. (Refer to the installation manual of the outdoor unit.)
 - This is a class A product. In a domestic environment this product may cause radio interference in which case the user may be required to take adequate measures.
 - Keep indoor unit, outdoor unit, power supply wiring and transmission wiring at least 1 meter away from televisions and radios. This is to prevent image interference and noise interference in those electrical appliances. (Electric noise may be generated depending on the conditions under which the electric wave is generated, even if 1 meter is kept.)
 - When installing the wireless remote controller kit, the distance between wireless remote controller and indoor unit might be shorter if there are fluorescent lights who are electrically started in the room. The indoor unit must be installed as far as possible away from fluorescent lights.

- Do not place objects that are susceptible to moisture directly beneath the indoor or outdoor units. Under certain conditions, condensation on the main unit or refrigerant pipes, air filter dirt or drain blockage may cause dripping, resulting in fouling or failure of the object concerned.

- Ensure that a protective guard is installed on air suction and air outlet side to prevent that the fan blades or heat exchanger be touched. The protection must comply with relevant European and national regulations.

- Use suspension bolts for installation. Check whether the ceiling is strong enough to support the weight of the indoor unit. If there is a risk, reinforce the ceiling before installing the unit.

- Service space
- Drain pipe
- Power supply wiring port
- Transmission wiring port
- Maintenance drain outlet
- Gas pipe
- Liquid pipe

Preparations before installation

- Relation of ceiling opening to unit and suspension bolt position. (See figure 5)

Model	A (mm)	B (mm)
35+50	700	738
60+71	1000	1038
100~140	1400	1438

- Indoor unit
- Pipe
- Suspension bolt pitch (x4)
- Suspension bolt pitch distance

For installation, choose one of the possibilities as listed further.

Standard rear suction (See figure 6a)

- Ceiling surface
- Ceiling opening
- Service access panel (optional accessory)
- Air filter
- Air inlet duct
- Duct service opening
- Interchangeable plate

Installation with rear duct and duct service opening (See figure 6b)

Installation with rear duct, no duct service opening (See figure 6c)

NOTE



Before installation of the unit (in case of installation with duct, but no duct service opening): modify the position of the air filters.

- Remove the air filter(s) at the outside of the unit
- Remove the interchangeable plate
- Install the air filter(s) from the inside of the unit
- Reinstall the interchangeable plate

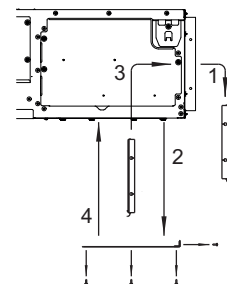

NOTE

When installing an air inlet duct, select fixing screws that shall stick out maximum 5 mm at the inside of the flange to protect the air filter from damage during maintenance of the filter.

- 1 Air inlet duct
- 2 Inside of the flange
- 3 Fixing screw

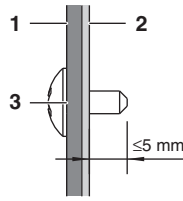

Mounting the air inlet panel with a canvas connection (See [figure 7a](#))

Mounting the air inlet panel directly (See [figure 7b](#))

- 1 Ceiling surface
- 2 Ceiling opening
- 3 Air inlet panel (Optional accessory)
- 4 Indoor unit (Back side)
- 5 Canvas connection for air inlet panel (Optional accessory)

Model	A (mm)
35+50	760
60+71	1060
100~140	1460

Bottom suction (See [figure 7c](#))

NOTE

The unit can be used with bottom suction by replacing the interchangeable plate by the air filter holding plate.

- 1 Air filter holding plate with air filter(s)
- 2 Interchangeable plate

NOTE

For other installation than standard installation, contact your Daikin dealer for details.

2. The fan speed for this indoor unit is preset to provide standard external static pressure.
If higher or lower external static pressure is required, reset the external static pressure by changing the initial setting from the remote controller.
Refer to "[External static pressure setting](#)" on page 8.
3. Install the suspension bolts.
(Use M10 size bolt for the suspension bolt.) Use anchors for existing ceilings, and a sunken insert, sunken anchors or other field supplied parts for new ceilings to reinforce the ceiling in order to bear the weight of the unit.

Installation example

(See [figure 3](#))

- 1 Anchor
- 2 Ceiling slab
- 3 Long nut or turn-buckle
- 4 Suspension bolt
- 5 Indoor unit

NOTE

- All the above parts are field supplied.
- For other installation than standard installation, contact your dealer for details.

Indoor unit installation

When installing optional accessories (except for the air inlet panel), read also the installation manual of the optional accessories. Depending on the field conditions, it may be easier to install optional accessories before the indoor unit is installed.

1. Install the indoor unit temporarily.
 - Attach the hanger bracket to the suspension bolt. Be sure to fix it securely by using a nut and washer from the upper and lower sides of the hanger bracket. (See [figure 4](#))
- 1 Nut (field supply)
 - 2 Washer for hanger bracket (supplied with the unit)
 - 3 Tighten (double nut)
2. Check if the unit is horizontally levelled.
 - Do not install the unit tilted. The indoor unit is equipped with a built-in drain pump and float switch.
(If the unit is tilted against condensate flow, the float switch may malfunction and cause water to drip.)
 - Check if the unit is levelled at all four corners with a water level or a water-filled vinyl tube as shown in [figure 9](#).
- 1 Water level
 - 2 Vinyl tube
3. Tighten the upper nut.

Installing the duct

Connect the duct supplied in the field.

Air inlet side

- Attach the duct and intake-side flange (field supply).
- Connect the flange to the main unit with accessory screws (7).
- Wrap the intake-side flange and duct connection area with aluminum tape or something similar to prevent air escaping.



When attaching a duct to the intake side, be sure to attach an air filter inside the air passage on the intake side. (Use an air filter whose dust collecting efficiency is at least 50% in a gravimetric technique.)
The included filter is not used when the intake duct is attached.

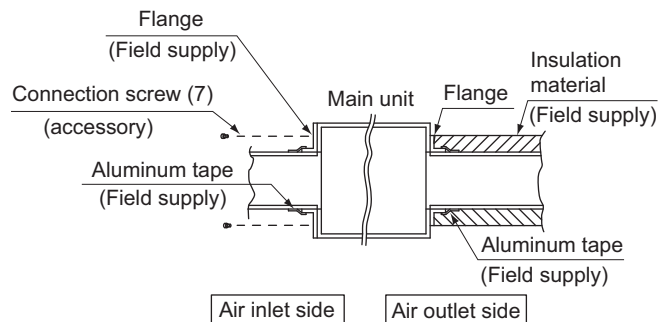

Air outlet side

- Connect the duct according to the air inside of the outlet-side flange.
- Wrap the outlet-side flange and the duct connection area with aluminum tape or something similar to prevent air escaping.



- Be sure to insulate the duct to prevent condensation from forming. (Material: glass wool or polyethylene foam, 25 mm thick)
- Use electric insulation between the duct and the wall when using metal ducts to pass metal laths of the net or fence shape or metal plating into wooden buildings.
- Be sure to explain about the way of maintaining and cleaning local procurements (air filter, grille (both air outlet and suction grille), etc.) to your customer.

Refrigerant piping work

For refrigerant piping of outdoor unit, refer to the installation manual supplied with the outdoor unit.

Execute heat insulation work completely on both sides of the gas piping and the liquid piping. Otherwise, this can sometimes result in water leakage.

Before rigging tubes, check which type of refrigerant is used.



Installation shall be done by a licensed refrigeration technician, the choice of materials and installation shall comply with the applicable national and international codes. In Europe, EN378 is the applicable standard that shall be used.

- Use a pipe cutter and flare suitable for the used refrigerant.
- To prevent dust, moisture or other foreign matter from infiltrating the tube, either pinch the end, or cover it with tape.
- Use copper alloy seamless pipes (ISO 1337).
- The outdoor unit is charged with refrigerant.
- To prevent water leakage, execute heat insulation work completely on both sides of the gas and liquid piping. When using a heat pump, the temperature of the gas piping can reach up to approximately 120°C, use insulation which is sufficiently heat resistant.
- Be sure to use both a spanner and torque wrench together when connecting or disconnecting pipes to/from the unit.

- 1 Torque wrench
- 2 Spanner
- 3 Piping union
- 4 Flare nut

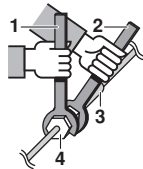

- Do not mix anything other than the specified refrigerant, such as air, etc..., inside the refrigerant circuit.
- Use annealed material only for flare connections.
- Refer to [Table 1](#) for the dimensions of flare nut spaces and the appropriate tightening torque. (Overtightening may damage the flare and cause leaks.)

Table 1

Pipe gauge	Tightening torque (N·m)	Flare dimension A (mm)	Flare shape
Ø6.4	15~17	8.7~9.1	
Ø9.5	33~39	12.8~13.2	
Ø12.7	50~60	16.2~16.6	
Ø15.9	63~75	19.3~19.7	

- When connecting the flare nut, coat the flare inner surface with ether oil or ester oil and initially tighten 3 or 4 turns by hand before tightening firmly.

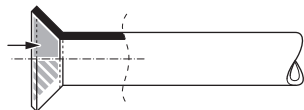

- If the refrigerant gas leaks during the work, ventilate the area. A toxic gas is emitted by the refrigerant gas being exposed to a fire.
- Make sure there is no refrigerant gas leak. A toxic gas may be released by the refrigerant gas leaking indoor and being exposed to flames from an area heater, cooking stove, etc.
- Finally, insulate as shown in the figures below.

Piping insulation procedure

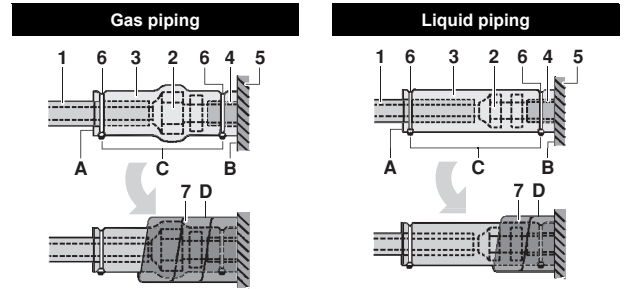

- 1 Piping insulation material (field supply)
 - 2 Flare nut connection
 - 3 Insulation for fitting (delivered with the unit)
 - 4 Piping insulation material (main unit)
 - 5 Main unit
 - 6 Clamp (field supply)
 - 7 Medium 1 sealing pad for gas piping (delivered with the unit)
Medium 2 sealing pad for liquid piping (delivered with the unit)
- A Turn seams up
B Attach to base
C Tighten the part other than the piping insulation material
D Wrap over from the base of the unit to the top of the flare nut connection



For local insulation, be sure to insulate local piping all the way into the pipe connections inside the unit. Exposed piping may cause condensation or may cause burns when touched.

Cautions for brazing

- Be sure to carry out a nitrogen blow when brazing. Brazing without carrying out nitrogen replacement or releasing nitrogen into the piping will create large quantities of oxidized film on the inside of the pipes, adversely affecting valves and compressors in the refrigerating system and preventing normal operation.
- When brazing while inserting nitrogen into the piping, nitrogen must be set to 0.02 MPa with a pressure-reducing valve (=just enough so that it can be felt on the skin).

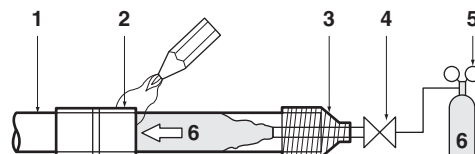

- 1 Refrigerant piping
- 2 Part to be brazed
- 3 Taping
- 4 Hands valve
- 5 Pressure-reducing valve
- 6 Nitrogen

Drain piping work

Installation of drain piping

Install the drain piping as shown in the figure and take measures against condensation. Improperly rigged piping could lead to leaks and eventually wet furniture and belongings.

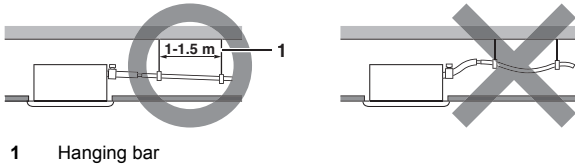

1 Hanging bar

■ Install the drain pipes.

- Keep piping as short as possible and slope it downwards at a gradient of at least 1/100 so that air may not remain trapped inside the pipe.
- Keep pipe size equal to or greater than that of the connecting pipe (vinyl pipe of 25 mm nominal diameter and 32 mm outer diameter).
- Push the supplied drain hose as far as possible over the drain socket.

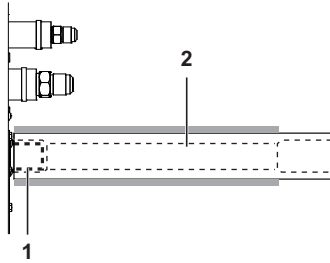

1 Drain socket (attached to the unit)
2 Drain hose (supplied with the unit)

- Tighten the metal clamp until the screw head is less than 4 mm from the metal clamp part as indicated in the illustration.

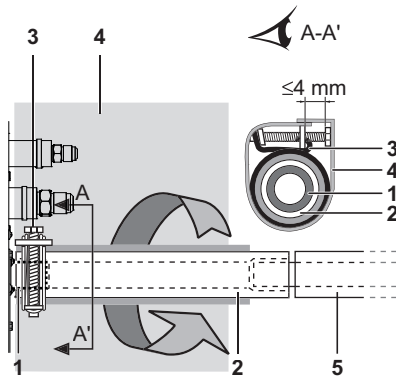

1 Drain socket (attached to the unit)
2 Drain hose (supplied with the unit)
3 Metal clamp (supplied with the unit)
4 Large sealing pad (supplied with the unit)
5 Drain piping (field supply)

- Wrap the supplied large sealing pad over the metal clamp and drain hose to insulate and fix it with clamps.
- Insulate the complete drain piping inside the building (field supply).
- If the drain hose cannot be sufficiently set on a slope, fit the hose with drain raising piping (field supply).

■ How to perform drain piping

(See figure 10)

- 1 Ceiling slab
- 2 Hanger bracket
- 3 Adjustable range
- 4 Drain raising pipe
- 5 Drain hose (supplied with the unit)
- 6 Clamp metal (supplied with the unit)

- 1 Connect the drain hose to the drain raising pipes, and insulate them.
- 2 Connect the drain hose to the drain outlet on the indoor unit, and tighten it with the clamp.

Installation	A (mm)
Rear suction installation	231
When canvas duct is installed	350-530
When air inlet panel is directly installed	231

■ Precautions

- Install the drain raising pipes at a height of less than 625 mm.
- Install the drain raising pipes at a right angle to the indoor unit and no more than 300 mm from the unit.
- To prevent air bubbles, install the drain hose level or slightly tilted up (≤ 75 mm).
- The drain pump mounted in this unit is the high lift type. The characteristic of this pump is that the higher the pump is the lower the drainage sound becomes. Therefore a drain pump height of 300mm is recommended.



NOTE The incline of attached drain hose should be 75 mm or less so that the drain socket does not have to withstand additional force.

To ensure a downward slope of 1:100, install hanging bars every 1 to 1.5 m.

When unifying multiple drain pipes, install the pipes as shown in figure 11. Select converging drain pipes whose gauge is suitable for the operating capacity of the unit.

1 T-joint converging drain pipes

Testing of drain piping

After piping work is finished, check if drainage flows smoothly.

- Add approximately 1 l of water gradually through the air discharge outlet. Check for water leaks.

Method of adding water. See figure 8.

- 1 Water inlet
- 2 Portable pump
- 3 Water inlet cover
- 4 Bucket (adding water through water inlet)
- 5 Drain outlet for maintenance (with rubber drain plug)
- 6 Refrigerant pipes



Caution for drain socket

Do not remove the drain pipe plug. Water might leak out.

The drain outlet is only used to discharge water if the drain pump is not used or before maintenance. Gently put in and out the drain plug. Excessive force may deform the drain socket of the drain pan.

■ Pulling out the plug

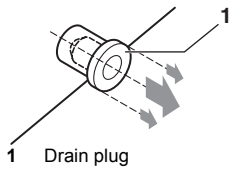

1 Drain plug

Do not wiggle the plug up and down

■ Pushing in the plug

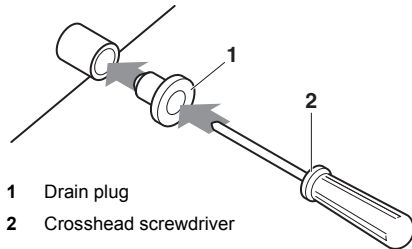

1 Drain plug

2 Crosshead screwdriver

Set the plug and push it by using a crosshead screwdriver

First perform electric wiring work as instructed in "Electric wiring work" on page 6 and how to set the remote controller as explained in "Wiring example and how to set the remote controller" on page 7.

When electric wiring work is finished

Check drainage flow during COOL running, explained in "Test operation" on page 10.

When electric wiring work is not finished

- Remove the switch box cover and connect the single-phase power supply and the remote controller to the terminals. (Refer to chapter "Electric wiring work" on page 6 for switch box attachment/detachment) (Refer to figure 12 and 13)
- Connect the single-phase power supply to connections 1 and 2 (as shown in the figure) on the power supply terminal board and confirm drain operation.

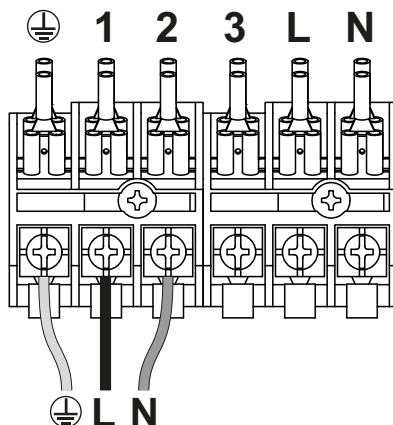

- After confirming drainage, turn off the power.

- 1 Switch box cover
- 2 Transmission wiring port
- 3 Power supply wiring port
- 4 Wiring diagram
- 5 Switch box
- 6 Plastic clamp
- 7 Remote controller wiring
- 8 Terminal board for unit transmission wiring
- 9 Power supply wiring
- 10 Indoor PCB board 1
- 11 Power supply terminal board
- 12 Transmission wiring between units
- 13 Indoor PCB board 2
- 14 Long sealing
- 15 Wiring

Electric wiring work

General instructions

- All field wiring and components must be installed by a licensed electrician and must comply with relevant European and national regulations.
- Use copper wire only.
- Follow the "Wiring diagram" attached to the unit body to wire the outdoor unit, indoor units and the remote controller. For details on hooking up the remote controller, refer to the "Installation manual of the remote controller".
- All wiring must be performed by an authorized electrician.
- Attach the earth leakage circuit breaker and fuse to the power supply line.
- A main switch or other means for disconnection, having a contact separation in all poles, must be incorporated in the fixed wiring in accordance with relevant local and national legislation. Note that the operation will restart automatically if the main power supply is turned off and then turned back on again.
- Refer to the installation manual delivered with the outdoor unit for the size of power supply electric wire connected to the outdoor unit, the capacity of the earth leakage breaker and fuse and for wiring instructions.
- Be sure to ground the air conditioner.
- Do not connect the ground wire to:
 - gas pipes: might cause explosions or fire if gas leaks.
 - telephone ground wires or lightning rods: might cause abnormally high electric potential in the ground during lightning storms.
 - plumbing pipes: no grounding effect if hard vinyl piping is used.
- Make sure that earth wire between the pull relief and terminal is longer than other wires.
- Be sure that the shape of the power supply cable and any other cable, before entering unit, should be as shown in this figure.
- All cables entering the unit should be fixed by tie wraps (accessory).
- Use long sealing (accessory) to block entrance of switch box as shown in figure 12.

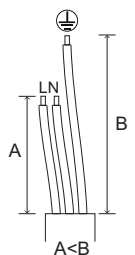

Electrical characteristics

Model	Hz	Volts	Voltage range	Power supply	
				MCA	MFA
35	50/60	220-240/220	±10%	0.8	16 A
50				0.8	
60				0.7	
71				0.7	
100				1.3	
125				1.9	
140				1.9	

MCA: Min. circuit Amps (A)

MFA: Max. Fuse Amps (A)



NOTE For details, refer to "Electrical data" in the technical data book.

Specifications for field wire

	Wire	Size (mm ²)	Length
Between indoor units	H05VV-U4G ^{(a),(b)}	2.5	—
Unit-Remote controller	Sheathed wire (2 wire) ^(c)	0.75–1.25	Max. 500 m ^(d)

- (a) Shows only in case of protected pipes. Use H07RN-F in case of no protection.
 (b) Run transmission wiring between the indoor and outdoor units through a conduit to protect against external forces, and feed the conduit through the wall together with refrigerant piping.
 (c) Use double insulation wire for remote controller (sheath thickness: ≥1 mm) or run wires through a wall or conduit so that the user cannot come in contact with them.
 (d) This length shall be the total extended length in the system of the group control.

Wiring example and how to set the remote controller

How to connect wiring

Remove the switch box cover as shown in [figure 13](#), and make the connections.

- 1 Switch box cover
- 2 Switch box low voltage wiring inlet
- 3 Switch box high voltage wiring inlet
- 4 Wiring diagram
- 5 Switch box

Precautions

1. Observe the notes mentioned below when wiring to the power supply terminal board.
 - Use a round crimp-style terminal for insulation sleeve for connection to the terminal block for wiring the units. When none are available, follow the instructions below.

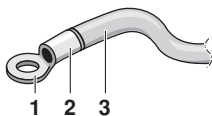

- 1 Round crimp-style terminal
- 2 Attach insulation sleeve
- 3 Wiring

- Do not connect wires of different gauge to the same power supply terminal. (Looseness in the connection may cause overheating.)
- When connecting wires of the same gauge, connect them according to the figure.



Use the specified electric wire. Connect the wire securely to the terminal. Lock the wire down without applying excessive force to the terminal. Use torques according to the table below.

Tightening torque (N·m)	
Terminal block for remote controller	0.79~0.97
Terminal block for power supply	1.18~1.44

- When attaching the control box lid, make sure not to pinch any wires.
 - After all wiring connections are done, fill in any gaps in the casing wiring holes with putty or insulation material (field supply) thus to prevent small animals or dirt from entering the unit from outside and causing short circuits in the control box.
2. Do not connect wires of different gauge to the same grounding terminal. Looseness in the connection may deteriorate the protection.
 3. Remote controller cords and wires connecting the units should be located at least 50 mm away from power supply wiring. Not following this guideline may result in malfunction due to electrical noise.
 4. For the remote controller wiring, refer to the "Installation manual of the remote controller" supplied with the remote controller.



NOTE The customer has the ability to select the remote controller thermistor.

5. Never connect the power supply wiring to the terminal board for transmission wiring. This mistake could damage the entire system.
6. Use only specified wires and tightly connect wires to the terminals. Be careful that wires do not place external stress on the terminals. Keep wiring in neat order so that they do not obstruct other equipment such as popping open the switch box cover. Make sure the cover closes tight. Incomplete connections could result in overheating, and in the worse case, electric shock or fire.

Keep total current of crossover wiring between indoor units less than 12 A. Branch the line outside the terminal block of the unit in accordance with the electrical equipment standards, when using two power wiring of a gauge greater than 2 mm² (Ø1.6).

The branch must be sheathed in order to provide an equal or greater degree of insulation as power supply wiring itself.

Wiring example

- Fit the power supply wiring of each system with a switch and fuse as shown in figure 14 and figure 15.

- Power supply
- Main switch
- Fuse
- Outdoor unit
- Indoor unit
- Remote controller (optional accessory)

Complete system example (3 systems)

When using 1 remote controller for 1 indoor unit. (Normal operation) (See figure 14 and figure 15)

Use with 2 remote controllers (See figure 16)^(a)

For group control (See figure 17)^(a)

NOTE It is not necessary to designate an indoor unit address when using group control. The address is automatically set when the power is activated.

- If combination of units is one of the following, use separate power supplies only. (See figure 15)

1x FBQ35D + RXS35L
 2x FBQ60D + RR100/125B or RQ100/125B
 2x FBQ71D + RR100/125B or RQ100/125B
 4x FBQ50D + RZQ200C
 3x FBQ60D + RZQ200C
 3x FBQ71D + RZQ200C
 2x FBQ100D + RZQ200C
 4x FBQ60D + RZQ200C
 2x FBQ125D + RZQ200C

- If the combination of units is one from Table 4, a separate powersupply according to figure 15 can be used. Not necessary to consult with distribution network operator as long as local requirements for installation exist.
- If there is requirement to use common power supply for the units from Table 4, the connection of units complies with EN/IEC 61000-3-12^(b).

This equipment complies with EN/IEC 61000-3-12 provided that short-circuit power S_{sc} is greater than or equal to S_{sc} of Table 4 at the interface point between the user's supply and the public system. It is the responsibility of the installer or user of the equipment to ensure, by consultation with the distribution network operator if necessary, that equipment is connected only to a supply with a short-circuit power S_{sc} greater than or equal to S_{sc} of Table 4.

Table 4

Combinations	FBQ35D	FBQ50D	FBQ60D	FBQ71D	FBQ100D	FBQ125D	FBQ140D
RZQG71L	2 (—)	—	—	1 (—)	—	—	—
RZQG100L	3 (2.31)	2 (1.30)	—	—	1 (0.73)	—	—
RZQG125L	4 (3.33)	3 (2.32)	2 (2.05)	—	—	1 (0.74)	—
RZQG140L	4 (3.33)	3 (2.32)	—	2 (2.05)	—	—	1 (0.74)
RZQSG71L	2 (1.10)	—	—	1 (1.22)	—	—	—
RZQSG100L	2 (1.65)	2 (—)	—	—	1 (—)	—	—
RZQSG125L	4 (3.33)	3 (2.32)	2 (2.05)	—	—	1 (0.74)	—
RZQSG140L	4 (3.33)	3 (2.32)	—	2 (2.05)	—	—	1 (0.74)

Number of indoor units (S_{sc} [MVA])

(a) Shown in figure is with common power supply. Dashed line is for separate power supply.
 (b) European/International Technical Standard setting the limits for harmonic currents produced by equipment connected to low-voltage systems with input current >16A and ≤75A per phase.

Precautions

- A single switch can be used to supply power to units on the same system. However, branch switches and branch circuit breakers must be selected carefully.
- For a group control remote controller, choose the remote controller that suits the indoor unit which has the most functions.
- All transmission wiring except for the remote controller wiring is polarized and must match the terminal symbol.
- In case of group control, perform the remote controller wiring to the master unit when connecting to the simultaneous operation system (wiring to the slave unit is unnecessary).
- When controlling the simultaneous operation system with 2 remote controllers, connect it to the master unit (wiring to the slave unit is unnecessary).
- Be sure to connect the wiring to the master unit when combining with a simultaneous operating multi-type in group control.
- Do not ground the equipment on gas pipes, water pipes, lightning rods or crossground with telephones. Improper grounding could result in electric shock.

Field setting

Field setting must be made from the remote controller in accordance with the installation condition.

- Setting can be made by changing the "Mode number", "FIRST CODE No." and "SECOND CODE No."
- For setting and operation, refer to "Field setting" in the installation manual of the remote controller.

Setting for optional accessories

In case of connecting optional accessories, refer to the operation manuals provided with the optional accessories and establish necessary settings.

External static pressure setting

Settings for external static pressure can be achieved in 2 ways:

Using the airflow automatic adjustment function

Airflow automatic adjustment is the volume of blow-off air that has been automatically adjusted to the rated quantity.

- Make sure the test run is done with a dry coil.
If the coil is not dry, run the unit for 2 hours with fan only to dry the coil.
- Check if the power supply wiring to the air conditioning unit is completed along with the duct installation.
If a closing damper is installed in the air conditioning unit, make sure that it is open.
Also check if the air filter is properly attached into the air passage on the air suction side of the air conditioning unit.
- If there is more than one air inlet and outlet, adjust the dampers so that the airflow rate of each air inlet and outlet is conform with the designed airflow rate.
Make sure the air conditioning unit is in fan operation mode. Press and set the airflow adjustment button on the remote controller to change the airflow rate to H or L.
- Setting the airflow automatic adjustment settings.

When the air conditioning unit is running in fan operation mode perform the next steps:

- stop the air conditioning unit,
- go to field setting mode,
- select mode No. 21 (or 11 in case of group setting),
- set the first code No. to "7",
- set the second code No. to "03".

Return to normal operating mode after setting these settings and press the ON/OFF operation button. The operation lamp will

light up and the air conditioning unit will start the fan operation for airflow automatic adjustment.



Do not adjust the dampers during fan operation for airflow automatic adjustment.

After 1 to 8 minutes, the air conditioning unit stops operating automatically when the fan operation for airflow automatic adjustment has been carried out, the operation lamp will be off.

Mode No.	First code No.	Second code No.	Setting content
11 (21)	7	01	Airflow adjustment is OFF
		02	Completion of airflow adjustment
		03	Start of airflow adjustment

5 When the air conditioning unit has stopped, check on an indoor unit if the second code No. of mode No. 21 is set to "02".

If the air conditioning unit does not stop operating or the second code No. is not "02", repeat step 4.

If the outdoor unit is not turned on, the display on the remote controller will show "LH" or "LH" (refer to "Test operation" on page 10). However, you can continue setting this function because these messages are only applicable to outdoor units.

After setting this function, be sure to turn on the outdoor unit before performing the test operation on the outdoor unit.

If any other error display occurs on the display of the remote controller, refer to "Test operation" on page 10 and the operation manual of the outdoor unit. Check the defective point.



- If there is no change after airflow adjustment in the ventilation paths, be sure to perform setting the automatic airflow adjustment again.
- Contact your dealer if there is no change after performing airflow adjustment in the ventilation paths, after performing the test operation of the outdoor unit or when the air conditioning unit is moved to another location.
- If booster fans, an outdoor air processing unit or HRV via duct are used, do not use automatic airflow adjustment control with a remote controller.
- If the ventilation paths have been changed, perform the setting of the airflow automatic adjustment again as described above from step 3 onwards.

Using the remote controller

Check on an indoor unit if the second code of mode No. 21 is set to "01" (= factory setting). Change the second code according to the external static pressure of the duct to be connected as shown in table 2.

NOTE

The second code No. is set to "01" by default.



Table 2

Mode No.	First code No.	Second code No.	External static pressure (Pa)						
			FBQ						
			35	50	60	71	100	125	140
13 (23)	6	01	30	30	30	30	40	50	50
		02	–	–	–	–	–	–	–
		03	30	30	30	30	–	–	–
		04	40	40	40	40	40	–	–
		05	50	50	50	50	50	50	50
		06	60	60	60	60	60	60	60
		07	70	70	70	70	70	70	70
		08	80	80	80	80	80	80	80
		09	90	90	90	90	90	90	90
		10	100	100	100	100	100	100	100
		11	110	110	110	110	110	110	110
		12	120	120	120	120	120	120	120
		13	130	130	130	130	130	130	130
		14	140	140	140	140	140	140	140
		15	150	150	150	150	150	150	150

Setting air filter sign

- Remote controllers are equipped with liquid crystal air filter signs to display the time to clean the air filter.
- Change the Second code No. depending on the amount of dirt or dust in the room. (Second code No. is factory set to "01" for air filter contamination-light.)

Air filter contamination

Setting	Display interval	Mode No.	First code No.	Second code No.
Light	±2500 hrs	10 (20)	0	01
Heavy	±1250 hrs	10 (20)	0	02
No display	–	10 (20)	3	02

Control by 2 Remote Controllers (Controlling 1 indoor unit by 2 remote controllers)

When using 2 remote controllers, one must be set to "MAIN" and the other to "SUB".

Installation of the decoration panel

Refer to the installation manual attached to the decoration panel.

After installing the decoration panel, ensure that there is no space between the unit body and decoration panel.

Test operation















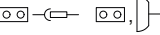

Refer to the section of ["For the following items, take special care during construction and check after installation is finished" on page 2.](#)

- After finishing the construction of refrigerant piping, drain piping, and electric wiring, conduct test operation accordingly to protect the unit.
- 1 Open the gas side stop valve.
 - 2 Open the liquid side stop valve.
 - 3 Electrify crank case heater for 6 hours.
 - 4 Set to cooling operation with the remote controller and start operation by pushing ON/OFF button.
 - 5 Press Inspection/Test Operation button 4 times and operate at Test Operation mode for 3 minutes.
 - 6 Press Inspection/Test Operation button and operate normally.
 - 7 Confirm function of unit according to the operation manual.

NOTE

If the main power supply is turned off during operation, operation will restart automatically after the power turns back on again.

Wiring diagram

Unified Wiring Diagram Legend					
For applied parts and numbering refer to the wiring diagram sticker supplied on the unit. Part numbering is realized by Arabic numbers in ascending order for each part and is represented in the overview below by symbol "n" in the part code.					
	:	CIRCUIT BREAKER		:	PROTECTIVE EARTH
	:	CONNECTION		:	PROTECTIVE EARTH (SCREW)
	:	CONNECTOR		:	RECTIFIER
	:	EARTH		:	RELAY CONNECTOR
	:	FIELD WIRING		:	SHORT CIRCUIT CONNECTOR
	:	FUSE		:	TERMINAL
	:	INDOOR UNIT		:	TERMINAL STRIP
	:	OUTDOOR UNIT		:	WIRE CLAMP
BLK : BLACK	GRN : GREEN	PNK : PINK	WHT : WHITE		
BLU : BLUE	GRY : GREY	PRP,PPL : PURPLE	YLW : YELLOW		
BRN : BROWN	ORG : ORANGE	RED : RED			
A*P	:	PRINTED CIRCUIT BOARD	PS	:	SWITCHING POWER SUPPLY
BS*	:	PUSH BUTTON ON / OFF, OPERATION SWITCH	PTC*	:	THERMISTOR PTC
BZ, H*O	:	BUZZER	Q*	:	INSULATED GATE BIPOLAR TRANSISTOR (IGBT)
C*	:	CAPACITOR	Q*DI	:	EARTH LEAK CIRCUIT BREAKER
AC*, CN*, E*, HA*, HE, HL*, HN*, HR*, MR*_A, MR*_B, S*, U, V, W, X*A	:	CONNECTION, CONNECTOR	Q*L	:	OVERLOAD PROTECTOR
D*, V*D	:	DIODE	Q*M	:	THERMO SWITCH
DB*	:	DIODE BRIDGE	R*	:	RESISTOR
DS*	:	DIP SWITCH	R*T	:	THERMISTOR
E*H	:	HEATER	RC	:	RECEIVER
F*U, FU* (FOR CHARACTERISTICS REFER TO PCB INSIDE YOUR UNIT)	:	FUSE	S*C	:	LIMIT SWITCH
FG*	:	CONNECTOR (FRAME GROUND)	S*L	:	FLOAT SWITCH
H*	:	HARNESS	S*NPH	:	PRESSURE SENSOR (HIGH)
H*P, LED*, V*L	:	PILOT LAMP, LIGHT EMITTING DIODE	S*NPL	:	PRESSURE SENSOR (LOW)
HAP	:	LIGHT EMITTING DIODE (SERVICE MONITOR GREEN)	S*PH, HPS*	:	PRESSURE SWITCH (HIGH)
HIGH VOLTAGE	:	HIGH VOLTAGE	S*PL	:	PRESSURE SWITCH (LOW)
IES	:	INTELLIGENT EYE SENSOR	S*T	:	THERMOSTAT
IPM*	:	INTELLIGENT POWER MODULE	S*W, SW*	:	OPERATION SWITCH
K*R, KCR, KFR, KHuR	:	MAGNETIC RELAY	SA*	:	SURGE ARRESTOR
L	:	LIVE	SR*, WLU	:	SIGNAL RECEIVER
L*	:	COIL	SS*	:	SELECTOR SWITCH
L*R	:	REACTOR	SHEET METAL	:	TERMINAL STRIP FIXED PLATE
M*	:	STEPPER MOTOR	T*R	:	TRANSFORMER
M*C	:	COMPRESSOR MOTOR	TC, TRC	:	TRANSMITTER
M*F	:	FAN MOTOR	V*, R*V	:	VARISTOR
M*P	:	DRAIN PUMP MOTOR	V*R	:	DIODE BRIDGE
M*S	:	SWING MOTOR	WRC	:	WIRELESS REMOTE CONTROLLER
MR*, MRCW*, MRM*, MRN*	:	MAGNETIC RELAY	X*	:	TERMINAL
N	:	NEUTRAL	X*M	:	TERMINAL STRIP (BLOCK)
n=*	:	NUMBER OF PASSES THROUGH FERRITE CORE	Y*E	:	ELECTRONIC EXPANSION VALVE COIL
PAM	:	PULSE-AMPLITUDE MODULATION	Y*R, Y*S	:	REVERSING SOLENOID VALVE COIL
PCB*	:	PRINTED CIRCUIT BOARD	Z*C	:	FERRITE CORE
PM*	:	POWER MODULE	Z*F, Z*F	:	NOISE FILTER

NOTE



1. USE COPPER CONDUCTORS ONLY.
2. WHEN USING THE CENTRAL REMOTE CONTROLLER, SEE MANUAL FOR CONNECTION TO THE UNIT.
3. WHEN CONNECTING THE INPUT WIRES FROM OUTSIDE, FORCED "OFF" OR "ON/OFF" CONTROL OPERATION CAN BE SELECTED BY THE REMOTE CONTROLLER. SEE INSTALLATION MANUAL FOR MORE DETAILS.
4. REFER TO INSTALLATION MANUAL.

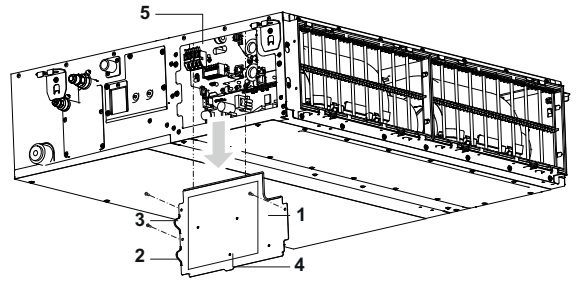
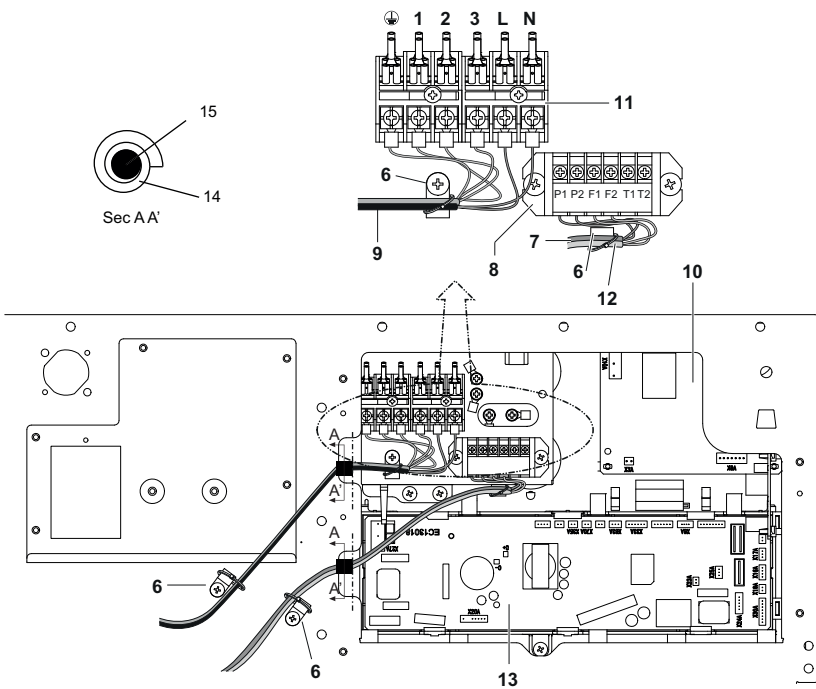

12

13

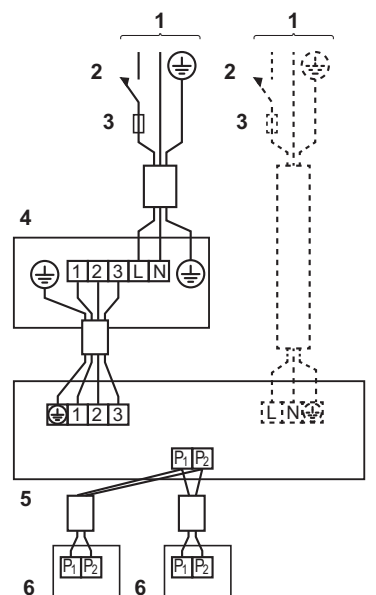
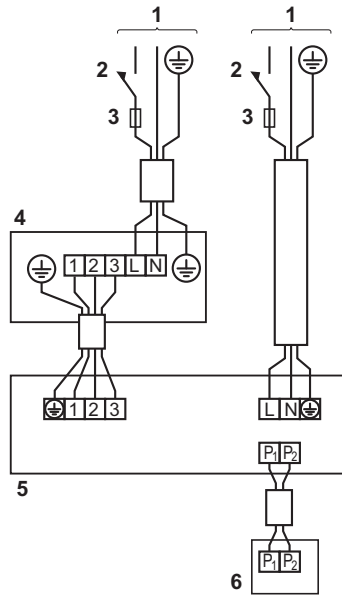
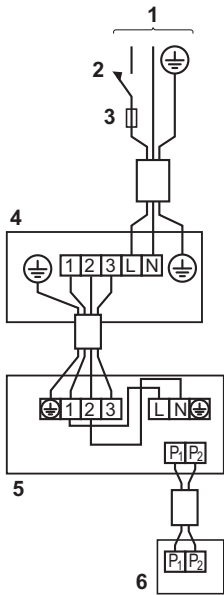

14

15

16

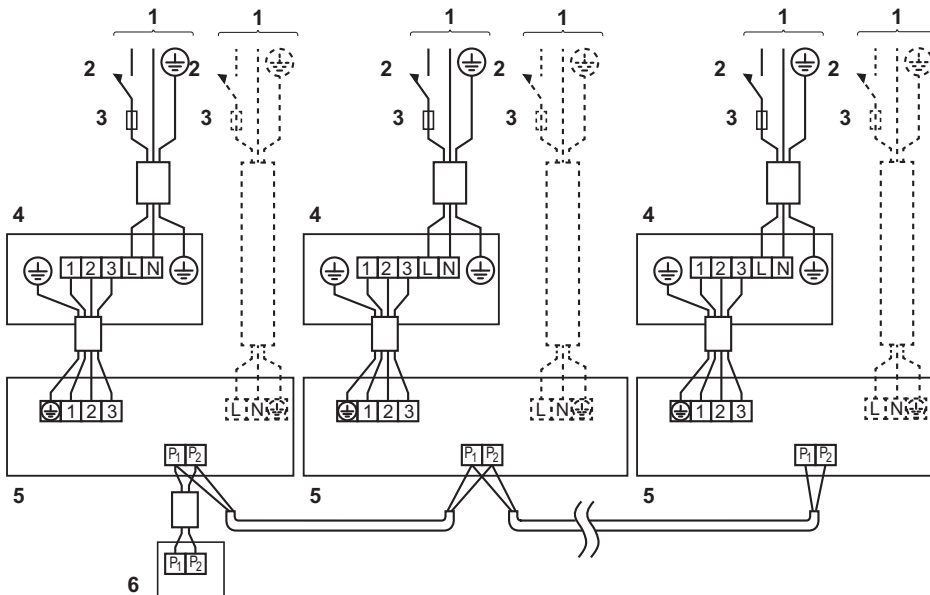

17

DAIKIN INDUSTRIES CZECH REPUBLIC s.r.o.

U Nové Hospody 1/1155, 301 00 Plzeň Skvrňany, Czech Republic

DAIKIN EUROPE N.V.

Zandvoordestraat 300, B-8400 Oostende, Belgium

Copyright 2014 Daikin

EAC

4P391818-1D 2016.04