



Installer reference guide

Split system air conditioners

FBA35A2VEB
FBA50A2VEB
FBA60A2VEB
FBA71A2VEB
FBA100A2VEB
FBA125A2VEB
FBA140A2VEB

Installer reference guide
Split system air conditioners

English

CE - DECLARACION DE CONFORMIDAD
 CE - DICHLARAZIONE DI CONFORMITA
 CE - ДИКЛАРАЦІЯ СІМПЛОФОРМІ
 CE - CONFORMITEITSVERKLARING

CE - DECLARACÃO DE CONFORMIDADE
 CE - ЗАЯВЛЕННЯ ПРО СООТВѢТСТВІЯ
 CE - OVIJESITESTIMELI ESSEKLERING
 CE - FÖRSÄKRAN OM ÖVERENSSTÄMMELSE

CE - ERKLÄRUNG ÜBER ÜBEREINSTIMMUNG
 CE - ЛІЦЕНЗІЯ НА СІМПЛОФОРМІ
 CE - DEKLARACIJA O SVADOBNOŠČI
 CE - DECLARAȚIE DE CONFORMITATE

CE - ZJAVNA OGLASILENOSTI
 CE - MEGFELHETŐSÉGI NYILATKOZAT
 CE - DEKLARACIJA ZGODNOSTI
 CE - DECLARAȚIE DE CONFORMITATE

CE - ZJAVNA OGLASILENOSTI
 CE - VASTAVUSBEKILARACIJA
 CE - ПУБЛІСАЦІЯ
 CE - UYUMLUK BEYANI

Daikin Industries Czech Republic s.r.o.

- 01 (en) declares under its sole responsibility that the air conditioning models to which this declaration relates
- 02 (en) erklärt auf seine alleinige Verantwortung, daß die Modelle der Klimaanlage für die diese Erklärung bestimmt ist:
- 03 (en) déclare sous sa seule responsabilité que les appareils dont conditionnement visés par la présente déclaration:
- 04 (en) vedkär herfor på egen eksklusivt ansvar for at de airconditioning units vedrørte i denne erklæring faktisk har:
- 05 (en) declara bajo su única responsabilidad que los modelos de aire acondicionado a los cuales hace referencia la declaración:
- 06 (en) δηλώνει με αποκλειστική του ευθύνη ότι τα προϊόντα των οποίων αφορά η παρούσα δήλωση:
- 07 (en) ovdzaruje pod svojim izključnim odgovornostjo da su modeli klima uređaja na koje se ova izjava odnosi:
- 08 (en) deklaruje na vlastitu odgovornost da su modeli klima uređaja na koje se ova izjava odnosi:

- 17 (en) deklaruje na vlastitu odgovornost, da su modeli klimatizatora, ktorých dotyczy tátoja deklarácia:
- 18 (en) deklaruje na propru odgovornost da aparatele de aer condiționare la care se referă această declarație:
- 19 (en) z svo odgovornosti izjavljam, da so modeli klimatskih naprav, na katere se izjava nanaša:
- 20 (en) kladem na oma izključno odgovornost, da klimatizacijske naprave, ki so navedene v tem izjavi, dejansko:
- 21 (en) deklaram na svoj odgovornost, da klimatizacijske naprave, ki so navedene v tem izjavi, dejansko:
- 22 (en) vyhlásím svou odpovědností, že klimatizace uvedené v tomto prohlášení skutečně:
- 23 (en) izjavim na svojo odgovornost, da klima naprave, ki so navedene v tem izjavi, dejansko:
- 24 (en) izjavim na svojo odgovornost, da klima naprave, ki so navedene v tem izjavi, dejansko:
- 25 (en) izjavim na svojo odgovornost, da klima naprave, ki so navedene v tem izjavi, dejansko:

FBA35A2VEB, FBA50A2VEB, FBA60A2VEB, FBA71A2VEB, FBA100A2VEB, FBA125A2VEB, FBA140A2VEB,

- 01 are in conformity with the following standard(s) or other normative document(s), provided that these are used in accordance with our instructions:
- 02 (en) den følgende Norm(en) eller anden anden Normdokument(er)-dokument(en) er tilsvarende, under det forudsætning, at de er brugt i overensstemmelse med vores instruktioner:
- 03 sont conformes à la(s) norme(s) ou autre(s) document(s) normatif(s), pour autant qu'ils soient utilisés conformément à nos instructions:
- 04 conform de volgende norm(en) of één of meer andere bindende document(en) zijn, op voorwaarde dat ze worden gebruikt overeenkomstig onze instructies:
- 05 están en conformidad con la(s) siguiente(s) norma(s) u otro(s) documento(s) normativo(s), siempre que sean utilizados de acuerdo con nuestras instrucciones:
- 06 sono conformi al(l) seguente(s) standard(i) o al(tro) documento(i) a carattere normativo, a patto che vengano usati in conformità alle nostre istruzioni:
- 07 євн оцворава мє то(ї) оцворава(ї) протвора(ї) (ї) або (ї)норматив(ів) конформно(ї)м, утв то(ї) протвора(ї)м з нашою інструкцією:

- 16 megfelelekes az alábbi szabvány(ok)nak, vagy egyéb irányadó dokumentum(ok)oknak, ha azokat előírás szerinti használatjának:
- 17 szerint a következő normák(n) (más néven előírások) alkalmazásával, amennyiben azok a használat során a mi utasításaink szerint:
- 18 sind in Übereinstimmung mit dem/n Norm(en) Dokument(en) Standard(e) (au alle) Dokument(e) Normativ(e), cu condiția ca acestea să fie utilizate în conformitate cu instrucțiunile noastre:
- 19 skladni z naslednjimi standardi in drugimi normativi, pod pogojem, da se uporabljajo skladu z našimi navodili:
- 20 on vastavuses järgmistele standarditele (ja või teistele normatiivsetele dokumentidele), kui need kasutatakse vastavalt meie juhenditele:
- 21 соотвѣрстват на следните стандарти или други нормативни документи, при условие, че се използват съгласно нашите инструкции:
- 22 atlika žemai nurodytus standartus ir (arba) kitus norminius dokumentus su sąlyga, kad yra naudojami pagal mūsų nurodymus:
- 23 tad, ja teibti atbilstošā standartiem nodrošinājumiem, abist sekojošiem standartiem un citiem normatīvajiem dokumentiem:
- 24 sa ir zibode s nasebovojušajiem (normatīvajiem) dokumentiem), za priekšskati, za se používaži v sllada s našim navodim:
- 25 uđinun, laimailamizaga gore kulanimasi košuljaja aspođidaki standardi va norm.befirten begetele uymuduri:

EN60335-2-40,

- 01 gemäß den Vorschriften der:
- 02 conformément aux stipulations des:
- 03 overeenkomstig de bepalingen van:
- 04 suorendon las fibraciones de:
- 05 secondo le prescrizioni per:
- 06 по предписанијем на:
- 07 в соответствии с положениями:

- 01 Direktiver, med senere ændringer:
- 02 Direktiven, med förändringar:
- 03 Direktives, telles que modifiées:
- 04 Richtlijnen, zoals gewijzigd:
- 05 Directives, según se emendado:
- 06 Direktive, come da modifica:
- 07 Одрубил, онус збав измѣнама:
- 08 Direktivas, conforme alterações em:
- 09 Директива со измененијем:
- 10 Direktiver, med senere ændringer:
- 11 Direktiven, med förändringar:
- 12 Direktives, telles que modifiées:
- 13 Richtlijnen, zoals gewijzigd:
- 14 Directives, según se emendado:
- 15 Direktive, come da modifica:
- 16 Одрубил, онус збав измѣнама:
- 17 в соответствии с положениями:
- 18 Direktiver, cu amendamentele respective:
- 19 Direktiva z isemi spremembami:
- 20 Direktivni kosi, mudiifikatsia:
- 21 Direktive, med förändringar:
- 22 Direktives, telles que modifiées:
- 23 Richtlijnen, zoals gewijzigd:
- 24 Directives, según se emendado:
- 25 Direktive, come da modifica:
- 26 Одрубил, онус збав измѣнама:
- 27 Direktivas, conforme alterações em:
- 28 Директива со измененијем:

Machinery 2006/42/EC

- 16 Megjelölés*
- 17 Úvege*
- 18 Noha*
- 19 Opomba*
- 20 Märkus*
- 21 Informator*
- 22 Merk*
- 23 Huom*
- 24 Poznámka*
- 25 Napomena*

- 21 Zabeleženka*
- 22 Pasaba*
- 23 Pločmes*
- 24 Poznámka*
- 25 Not*
- 01 Directives, amendé:
- 02 Direktiven, med förändringar:
- 03 Directives, telles que modifiées:
- 04 Richtlijnen, zoals gewijzigd:
- 05 Directives, según se emendado:
- 06 Direktive, come da modifica:
- 07 Одрубил, онус збав измѣнама:
- 08 Direktivas, conforme alterações em:
- 09 Директива со измененијем:
- 10 Direktiver, med senere ændringer:
- 11 Direktiven, med förändringar:
- 12 Direktives, telles que modifiées:
- 13 Richtlijnen, zoals gewijzigd:
- 14 Directives, según se emendado:
- 15 Direktive, come da modifica:
- 16 Одрубил, онус збав измѣнама:
- 17 в соответствии с положениями:
- 18 Direktiver, cu amendamentele respective:
- 19 Direktiva z isemi spremembami:
- 20 Direktivni kosi, mudiifikatsia:
- 21 Direktive, med förändringar:
- 22 Direktives, telles que modifiées:
- 23 Richtlijnen, zoals gewijzigd:
- 24 Directives, según se emendado:
- 25 Direktive, come da modifica:
- 26 Одрубил, онус збав измѣнама:
- 27 Direktivas, conforme alterações em:
- 28 Директива со измененијем:

**Electromagnetic Compatibility 2014/30/EU
 Low Voltage 2014/35/EU**

- 19 ob upotrebi u dobi:
- 20 nastavak robele:
- 21 nastavak uravljane na:
- 22 likovnis nastava, palekiam:
- 23 vektor nastabas, kas notakias:
- 24 održava (i) starovena:
- 25 bonun vesplarna vygini obak:

- 01 Note*
- 02 Hinweis*
- 03 Remarque*
- 04 Bemerk*
- 05 Nota*
- 06 Nota*
- 07 Zbiranje*
- 08 Zbiranje*
- 09 Zbiranje*
- 10 Note*
- 11 Hinweis*
- 12 Remarque*
- 13 Bemerk*
- 14 Nota*
- 15 Nota*
- 16 Zbiranje*
- 17 Zbiranje*
- 18 Zbiranje*
- 19 Zbiranje*
- 20 Zbiranje*
- 21 Zbiranje*
- 22 Zbiranje*
- 23 Zbiranje*
- 24 Zbiranje*
- 25 Zbiranje*

- 07** H DICz*** fikm konstrukciójn vo ovnizto tov. Teyvno popoio kromozhij.
- 08** A DICz*** está autorizada a compilar a documentação técnica de fabrico.
- 09** Kopiranje DICz*** pripisovaneho oznacen, koment. rehavovaneho dokumentacij.
- 10** DICz*** je autorizováno k vypracování technické konstrukční dokumentace.
- 11** DICz*** je autorizováno k vypracování technické konstrukční dokumentace.
- 12** DICz*** je autorizováno k vypracování technické konstrukční dokumentace.

- 07** DICz*** je autorizován k vypracování technické konstrukční dokumentace.
- 08** A DICz*** má oprávnění ke kompilaci souboru technické dokumentace.
- 09** Kopírování DICz*** je povoleno s označením, koment. rehavování dokumentace.
- 10** DICz*** je autorizován k vypracování technické konstrukční dokumentace.
- 11** DICz*** je autorizován k vypracování technické konstrukční dokumentace.
- 12** DICz*** je autorizován k vypracování technické konstrukční dokumentace.

***DICz = Daikin Industries Czech Republic s.r.o.



Tetsuya Baba
 Managing Director
 Pízen, 2nd of May 2017

(Signature)

DAIKIN INDUSTRIES CZECH REPUBLIC s.r.o.

U Nové Hospody 1/155, 301 00 Plzeň Skvrňany,
 Czech Republic

Table of Contents

1	General safety precautions	3
1.1	About the documentation	3
1.1.1	Meaning of warnings and symbols.....	3
1.2	For the installer.....	4
1.2.1	General	4
1.2.2	Installation site	4
1.2.3	Refrigerant	6
1.2.4	Brine.....	6
1.2.5	Water	6
1.2.6	Electrical	7
2	About the documentation	7
2.1	About this document.....	7
3	About the box	8
3.1	Overview: About the box	8
3.2	Indoor unit	8
3.2.1	To unpack and handle the unit.....	8
3.2.2	To remove the accessories from the indoor unit.....	8
4	About the units and options	8
4.1	Overview: About the units and options.....	8
4.2	System layout.....	8
4.3	Combining units and options	8
4.3.1	Possible options for the indoor unit.....	8
5	Preparation	8
5.1	Overview: Preparation	8
5.2	Preparing installation site	9
5.2.1	Installation site requirements of the indoor unit	9
5.3	Preparing refrigerant piping	10
5.3.1	Refrigerant piping requirements.....	10
5.3.2	Refrigerant piping insulation	10
5.4	Preparing electrical wiring	10
5.4.1	About preparing electrical wiring.....	10
6	Installation	10
6.1	Overview: Installation	10
6.2	Mounting the indoor unit.....	11
6.2.1	Precautions when mounting the indoor unit.....	11
6.2.2	Guidelines when installing the indoor unit.....	11
6.2.3	Guidelines when installing the ducting.....	12
6.2.4	Guidelines when installing the drain piping.....	12
6.3	Connecting the refrigerant piping	14
6.3.1	About connecting the refrigerant piping	14
6.3.2	Precautions when connecting the refrigerant piping ...	14
6.3.3	Guidelines when connecting the refrigerant piping	15
6.3.4	Pipe bending guidelines.....	15
6.3.5	To flare the pipe end	15
6.3.6	To braze the pipe end	15
6.3.7	To connect the refrigerant piping to the indoor unit ...	15
6.4	Connecting the electrical wiring.....	16
6.4.1	About connecting the electrical wiring.....	16
6.4.2	Precautions when connecting the electrical wiring	16
6.4.3	Guidelines when connecting the electrical wiring	16
6.4.4	To connect the electrical wiring on the indoor unit.....	16
6.4.5	Specifications of standard wiring components.....	18
7	Configuration	18
7.1	Field settings	18
8	Commissioning	19
8.1	Overview: Commissioning.....	19
8.2	Checklist before commissioning.....	19
8.3	To perform a test run.....	19
8.4	Error codes when performing a test run	20

9	Hand-over to the user	20
10	Disposal	21
11	Technical data	21
11.1	Wiring diagram	22

1 General safety precautions

1.1 About the documentation

- The original documentation is written in English. All other languages are translations.
- The precautions described in this document cover very important topics, follow them carefully.
- The installation of the system, and all activities described in the installation manual and the installer reference guide must be performed by an authorized installer.

1.1.1 Meaning of warnings and symbols

 **DANGER**
Indicates a situation that results in death or serious injury.

 **DANGER: RISK OF ELECTROCUTION**
Indicates a situation that could result in electrocution.

 **DANGER: RISK OF BURNING**
Indicates a situation that could result in burning because of extreme hot or cold temperatures.

 **DANGER: RISK OF EXPLOSION**
Indicates a situation that could result in explosion.



 **WARNING**
Indicates a situation that could result in death or serious injury.

 **WARNING: FLAMMABLE MATERIAL**

 **CAUTION**
Indicates a situation that could result in minor or moderate injury.

 **NOTICE**
Indicates a situation that could result in equipment or property damage.

 **INFORMATION**
Indicates useful tips or additional information.

Symbol	Explanation
	Before installation, read the installation and operation manual, and the wiring instruction sheet.
	Before performing maintenance and service tasks, read the service manual.
	For more information, see the installer and user reference guide.

1 General safety precautions

1.2 For the installer

1.2.1 General

If you are not sure how to install or operate the unit, contact your dealer.



NOTICE

Improper installation or attachment of equipment or accessories could result in electric shock, short-circuit, leaks, fire or other damage to the equipment. Only use accessories, optional equipment and spare parts made or approved by Daikin.



WARNING

Make sure installation, testing and applied materials comply with applicable legislation (on top of the instructions described in the Daikin documentation).



CAUTION

Wear adequate personal protective equipment (protective gloves, safety glasses,...) when installing, maintaining or servicing the system.



WARNING

Tear apart and throw away plastic packaging bags so that nobody, especially children, can play with them. Possible risk: suffocation.



DANGER: RISK OF BURNING

- Do NOT touch the refrigerant piping, water piping or internal parts during and immediately after operation. It could be too hot or too cold. Give it time to return to normal temperature. If you must touch it, wear protective gloves.
- Do NOT touch any accidental leaking refrigerant.



WARNING

Provide adequate measures to prevent that the unit can be used as a shelter by small animals. Small animals that make contact with electrical parts can cause malfunctions, smoke or fire.



CAUTION

Do NOT touch the air inlet or aluminium fins of the unit.



NOTICE

- Do NOT place any objects or equipment on top of the unit.
- Do NOT sit, climb or stand on the unit.



NOTICE

Works executed on the outdoor unit are best done under dry weather conditions to avoid water ingress.

In accordance with the applicable legislation, it might be necessary to provide a logbook with the product containing at least: information on maintenance, repair work, results of tests, stand-by periods,...

Also, at least, following information must be provided at an accessible place at the product:

- Instructions for shutting down the system in case of an emergency
- Name and address of fire department, police and hospital
- Name, address and day and night telephone numbers for obtaining service

In Europe, EN378 provides the necessary guidance for this logbook.

1.2.2 Installation site

- Provide sufficient space around the unit for servicing and air circulation.
- Make sure the installation site withstands the unit's weight and vibration.
- Make sure the area is well ventilated. Do NOT block any ventilation openings.
- Make sure the unit is level.

Do NOT install the unit in the following places:

- In potentially explosive atmospheres.
- In places where there is machinery that emits electromagnetic waves. Electromagnetic waves may disturb the control system, and cause malfunction of the equipment.
- In places where there is a risk of fire due to the leakage of flammable gases (example: thinner or gasoline), carbon fibre, ignitable dust.
- In places where corrosive gas (example: sulphurous acid gas) is produced. Corrosion of copper pipes or soldered parts may cause the refrigerant to leak.

Instructions for equipment using R32 refrigerant

If applicable.



WARNING

- Do NOT pierce or burn.
- Do NOT use means to accelerate the defrosting process or to clean the equipment, other than those recommended by the manufacturer.
- Be aware that R32 refrigerant does NOT contain an odour.



WARNING

The appliance shall be stored so as to prevent mechanical damage and in a well-ventilated room without continuously operating ignition sources (example: open flames, an operating gas appliance or an operating electric heater) and have a room size as specified below.



NOTICE

- Do NOT reuse joints which have been used already.
- Joints made in installation between parts of refrigerant system shall be accessible for maintenance purposes.



WARNING

Make sure installation, servicing, maintenance and repair comply with instructions from Daikin and with applicable legislation (for example national gas regulation) and are executed only by authorised persons.

Installation space requirements



NOTICE

- Pipework shall be protected from physical damage.
- Installation of pipework shall be kept to a minimum.



WARNING

If appliances contain R32 refrigerant, then the floor area of the room in which the appliances are installed, operated and stored must be larger than the minimum floor area defined in table below A (m²). This applies to:

- indoor units,
- outdoor units installed or stored indoors (example: winter garden, garage, machinery room),
- pipework in unventilated spaces.

To determine the minimum floor area

- 1 Determine the total refrigerant charge in the system (= factory refrigerant charge ① + ② additional refrigerant amount charged).

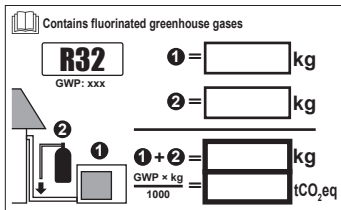

- 2 Determine which graph or table to use.
 - For indoor units: Is the unit ceiling-mounted, wall-mounted or floor-standing?
 - For outdoor units installed or stored indoors, and field piping in unventilated spaces, this depends on the installation height:

If the installation height is...	Then use the graph or table for...
<1.8 m	Floor-standing units
1.8 ≤ x < 2.2 m	Wall-mounted units
≥ 2.2 m	Ceiling-mounted units

- 3 Use the graph or table to determine the minimum floor area.

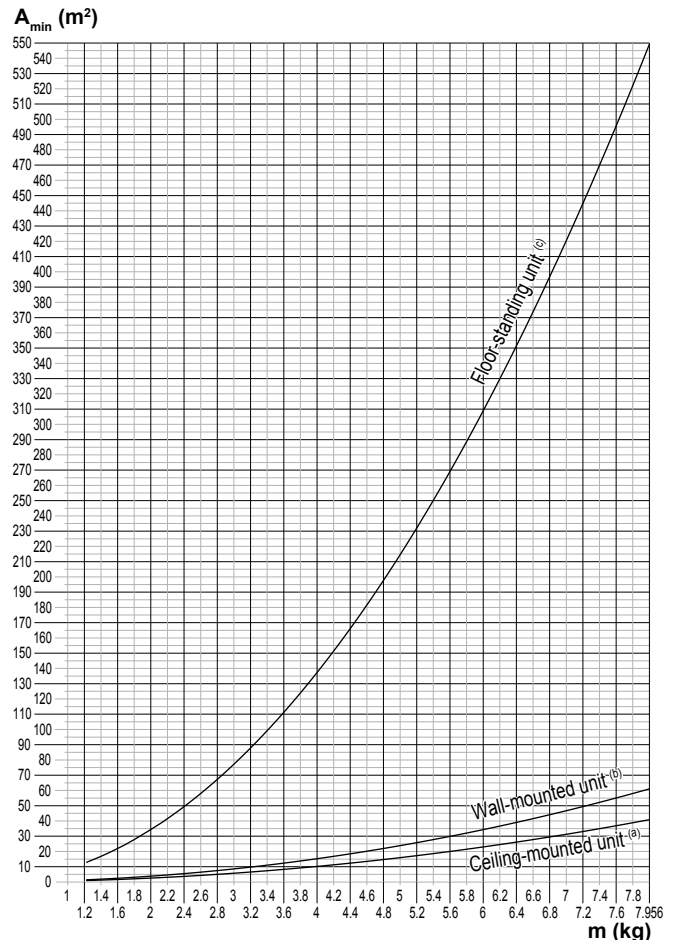

Ceiling-mounted unit ^(a)	Wall-mounted unit ^(b)	Floor-standing unit ^(c)
m (kg) — A _{min} (m ²)	m (kg) — A _{min} (m ²)	m (kg) — A _{min} (m ²)
<1.224 — —	<1.224 — —	<1.224 — —
1.225 — 0.956	1.225 — 1.43	1.225 — 12.9
1.4 — 1.25	1.4 — 1.87	1.4 — 16.8
1.6 — 1.63	1.6 — 2.44	1.6 — 22.0
1.8 — 2.07	1.8 — 3.09	1.8 — 27.8
2.0 — 2.55	2.0 — 3.81	2.0 — 34.3
2.2 — 3.09	2.2 — 4.61	2.2 — 41.5
2.4 — 3.68	2.4 — 5.49	2.4 — 49.4
2.6 — 4.31	2.6 — 6.44	2.6 — 58.0
2.8 — 5.00	2.8 — 7.47	2.8 — 67.3
3.0 — 5.74	3.0 — 8.58	3.0 — 77.2
3.2 — 6.54	3.2 — 9.76	3.2 — 87.9
3.4 — 7.38	3.4 — 11.0	3.4 — 99.2
3.6 — 8.27	3.6 — 12.4	3.6 — 111
3.8 — 9.22	3.8 — 13.8	3.8 — 124
4.0 — 10.2	4.0 — 15.3	4.0 — 137
4.2 — 11.3	4.2 — 16.8	4.2 — 151
4.4 — 12.4	4.4 — 18.5	4.4 — 166
4.6 — 13.5	4.6 — 20.2	4.6 — 182
4.8 — 14.7	4.8 — 22.0	4.8 — 198
5.0 — 16.0	5.0 — 23.8	5.0 — 215
5.2 — 17.3	5.2 — 25.8	5.2 — 232
5.4 — 18.6	5.4 — 27.8	5.4 — 250
5.6 — 20.0	5.6 — 29.9	5.6 — 269
5.8 — 21.5	5.8 — 32.1	5.8 — 289
6.0 — 23.0	6.0 — 34.3	6.0 — 309
6.2 — 24.5	6.2 — 36.6	6.2 — 330
6.4 — 26.1	6.4 — 39.1	6.4 — 351
6.6 — 27.8	6.6 — 41.5	6.6 — 374
6.8 — 29.5	6.8 — 44.1	6.8 — 397
7.0 — 31.3	7.0 — 46.7	7.0 — 420
7.2 — 33.1	7.2 — 49.4	7.2 — 445
7.4 — 34.9	7.4 — 52.2	7.4 — 470
7.6 — 36.9	7.6 — 55.1	7.6 — 496
7.8 — 38.8	7.8 — 58.0	7.8 — 522
7.956 — 40.8	7.956 — 61.0	7.956 — 549

m Total refrigerant charge in the system

1 General safety precautions

- A_{min}** Minimum floor area
- (a) Ceiling-mounted unit (= Ceiling-mounted unit)
 - (b) Wall-mounted unit (= Wall-mounted unit)
 - (c) Floor-standing unit (= Floor-standing unit)

1.2.3 Refrigerant

If applicable. See the installation manual or installer reference guide of your application for more information.



NOTICE

Make sure refrigerant piping installation complies with applicable legislation. In Europe, EN378 is the applicable standard.



NOTICE

Make sure the field piping and connections are not subjected to stress.



WARNING

During tests, NEVER pressurize the product with a pressure higher than the maximum allowable pressure (as indicated on the nameplate of the unit).



WARNING

Take sufficient precautions in case of refrigerant leakage. If refrigerant gas leaks, ventilate the area immediately. Possible risks:

- Excessive refrigerant concentrations in a closed room can lead to oxygen deficiency.
- Toxic gas may be produced if refrigerant gas comes into contact with fire.



DANGER: RISK OF EXPLOSION

Pump down – Refrigerant leakage. If you want to pump down the system, and there is a leakage in the refrigerant circuit:

- Do NOT use the unit's automatic pump down function, with which you can collect all refrigerant from the system into the outdoor unit. **Possible consequence:** Self-combustion and explosion of the compressor because of air going into the operating compressor.
- Use a separate recovery system so that the unit's compressor does NOT have to operate.



WARNING

Always recover the refrigerant. Do NOT release them directly into the environment. Use a vacuum pump to evacuate the installation.



NOTICE

After all the piping has been connected, make sure there is no gas leak. Use nitrogen to perform a gas leak detection.



NOTICE

- To avoid compressor breakdown, do NOT charge more than the specified amount of refrigerant.
- When the refrigerant system is to be opened, refrigerant must be treated according to the applicable legislation.





WARNING

Make sure there is no oxygen in the system. Refrigerant may only be charged after performing the leak test and the vacuum drying.

- In case re-charge is required, refer to the nameplate of the unit. It states the type of refrigerant and necessary amount.

- The unit is factory charged with refrigerant and depending on pipe sizes and pipe lengths some systems require additional charging of refrigerant.
- Only use tools exclusively for the refrigerant type used in the system, this to ensure pressure resistance and prevent foreign materials from entering into the system.
- Charge the liquid refrigerant as follows:

If	Then
A siphon tube is present (i.e., the cylinder is marked with "Liquid filling siphon attached")	Charge with the cylinder upright. 
A siphon tube is NOT present	Charge with the cylinder upside down. 

- Open refrigerant cylinders slowly.
- Charge the refrigerant in liquid form. Adding it in gas form may prevent normal operation.



CAUTION

When the refrigerant charging procedure is done or when pausing, close the valve of the refrigerant tank immediately. If the valve is not closed immediately, remaining pressure might charge additional refrigerant. **Possible consequence:** Incorrect refrigerant amount.

1.2.4 Brine

If applicable. See the installation manual or installer reference guide of your application for more information.



WARNING

The selection of the brine MUST be in accordance with the applicable legislation.



WARNING

Take sufficient precautions in case of brine leakage. If brine leaks, ventilate the area immediately and contact your local dealer.



WARNING

The ambient temperature inside the unit can get much higher than that of the room, e.g. 70°C. In case of a brine leak, hot parts inside the unit can create a hazardous situation.



WARNING

The use and installation of the application MUST comply with the safety and environmental precautions specified in the applicable legislation.

1.2.5 Water

If applicable. See the installation manual or installer reference guide of your application for more information.



NOTICE

Make sure water quality complies with EU directive 98/83 EC.

1.2.6 Electrical



DANGER: RISK OF ELECTROCUTION

- Turn OFF all power supply before removing the switch box cover, connecting electrical wiring or touching electrical parts.
- Disconnect the power supply for more than 1 minute, and measure the voltage at the terminals of main circuit capacitors or electrical components before servicing. The voltage MUST be less than 50 V DC before you can touch electrical components. For the location of the terminals, see the wiring diagram.
- Do NOT touch electrical components with wet hands.
- Do NOT leave the unit unattended when the service cover is removed.



WARNING

If NOT factory installed, a main switch or other means for disconnection, having a contact separation in all poles providing full disconnection under overvoltage category III condition, MUST be installed in the fixed wiring.



WARNING

- ONLY use copper wires.
- Make sure the field wiring complies with the applicable legislation.
- All field wiring must be performed in accordance with the wiring diagram supplied with the product.
- NEVER squeeze bundled cables and make sure they do not come in contact with the piping and sharp edges. Make sure no external pressure is applied to the terminal connections.
- Make sure to install earth wiring. Do NOT earth the unit to a utility pipe, surge absorber, or telephone earth. Incomplete earth may cause electrical shock.
- Make sure to use a dedicated power circuit. NEVER use a power supply shared by another appliance.
- Make sure to install the required fuses or circuit breakers.
- Make sure to install an earth leakage protector. Failure to do so may cause electric shock or fire.
- When installing the earth leakage protector, make sure it is compatible with the inverter (resistant to high frequency electric noise) to avoid unnecessary opening of the earth leakage protector.



NOTICE

Precautions when laying power wiring:

- Do not connect wiring of different thicknesses to the power terminal block (slack in the power wiring may cause abnormal heat).
- When connecting wiring which is the same thickness, do as shown in the figure below.



- For wiring, use the designated power wire and connect firmly, then secure to prevent outside pressure being exerted on the terminal board.
- Use an appropriate screwdriver for tightening the terminal screws. A screwdriver with a small head will damage the head and make proper tightening impossible.
- Over-tightening the terminal screws may break them.



WARNING

- After finishing the electrical work, confirm that each electrical component and terminal inside the electrical components box is connected securely.
- Make sure all covers are closed before starting up the unit.



NOTICE

Only applicable if the power supply is three-phase, and the compressor has an ON/OFF starting method.

If there exists the possibility of reversed phase after a momentary black out and the power goes on and off while the product is operating, attach a reversed phase protection circuit locally. Running the product in reversed phase can break the compressor and other parts.

2 About the documentation

2.1 About this document



INFORMATION

Make sure that the user has the printed documentation and ask him/her to keep it for future reference.

Target audience

Authorised installers



INFORMATION

This appliance is intended to be used by expert or trained users in shops, in light industry, and on farms, or for commercial and household use by lay persons.

Documentation set

This document is part of a documentation set. The complete set consists of:

- **General safety precautions:**
 - Safety instructions that you must read before installing
 - Format: Paper (in the box of the indoor unit)
- **Indoor unit installation manual:**
 - Installation instructions
 - Format: Paper (in the box of the indoor unit)

3 About the box

• Installer reference guide:

- Preparation of the installation, good practices, reference data,...
- Format: Digital files on <http://www.daikineurope.com/support-and-manuals/product-information/>

Latest revisions of the supplied documentation may be available on the regional Daikin website or via your dealer.

The original documentation is written in English. All other languages are translations.

Technical engineering data

- A **subset** of the latest technical data is available on the regional Daikin website (publicly accessible).
- The **full set** of latest technical data is available on the Daikin extranet (authentication required).

3 About the box

3.1 Overview: About the box

This chapter describes what you have to do after the box with the indoor unit is delivered on-site.

It contains information about:

- Unpacking and handling the units
- Removing the accessories from the units

Keep the following in mind:

- At delivery, the unit must be checked for damage. Any damage must be reported immediately to the carrier's claims agent.
- Bring the packed unit as close as possible to its final installation position to prevent damage during transport.

3.2 Indoor unit

3.2.1 To unpack and handle the unit

Use a sling of soft material or protective plates together with a rope when lifting the unit. This to avoid damage or scratches to the unit.

Lift the unit by holding on to the hanger brackets without exerting any pressure on other parts, especially on refrigerant piping, drain piping and other resin parts.

3.2.2 To remove the accessories from the indoor unit

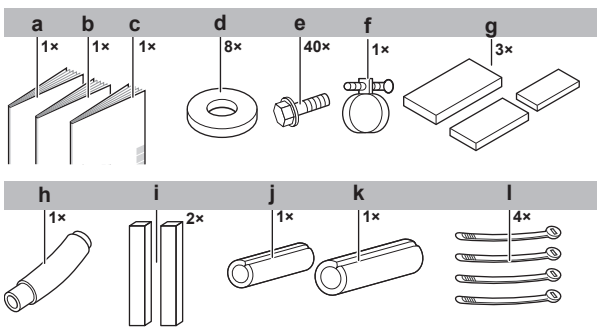

- a Installation manual
- b Operation manual
- c General safety precautions
- d Washers for hanger bracket
- e Screws for duct flanges
- f Metal clamp
- g Sealing pads: Large (drain pipe), medium 1 (gas pipe), medium 2 (liquid pipe)
- h Drain hose
- i Long sealing
- j Insulation piece: Small (liquid pipe)
- k Insulation piece: Large (gas pipe)
- l Tie wraps

4 About the units and options

4.1 Overview: About the units and options

This chapter contains information about:

- Identifying the indoor unit
- Combining outdoor and indoor units
- Combining the indoor unit with options
- Combining outdoor and indoor units
- Combining the indoor unit with options

4.2 System layout

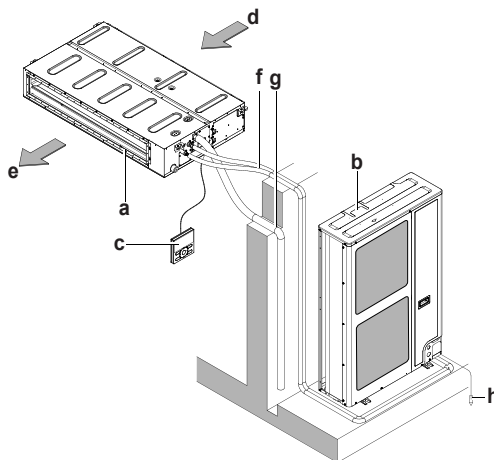

- a Indoor unit
- b Outdoor unit
- c User interface
- d Suction air
- e Discharge air
- f Refrigerant piping + interconnection cable
- g Drain pipe
- h Earth wiring

4.3 Combining units and options

4.3.1 Possible options for the indoor unit

Make sure you have the following mandatory options:

- User interface: Wired or wireless
- Air inlet panel and canvas connection for the air inlet panel (in case of bottom suction).

5 Preparation

5.1 Overview: Preparation

This chapter describes what you have to do and know before going on-site.

It contains information about:

- Preparing the installation site
- Preparing the refrigerant piping
- Preparing the electrical wiring

5.2 Preparing installation site

- Provide sufficient space around the unit for servicing and air circulation.
- Choose the installation location with sufficient place for carrying the unit in and out of the site.



WARNING

Do NOT install the air conditioner at any place where flammable gas may leak out. If the gas leaks out and stays around the air conditioner, a fire may break out.

5.2.1 Installation site requirements of the indoor unit



INFORMATION

Also read the following requirements:

- General installation site requirements. See the "General safety precautions" chapter.
- Refrigerant piping requirements (length, height difference). See further in this "Preparation" chapter.



INFORMATION

The sound pressure level is less than 70 dBA.



NOTICE

The equipment described in this manual may cause electronic noise generated from radio-frequency energy. The equipment complies to specifications that are designed to provide reasonable protection against such interference. However, there is no guarantee that interference will not occur in a particular installation.

It is therefore recommended to install the equipment and electric wires keeping proper distances away from stereo equipment, personal computers, etc.

- **Fluorescent lights.** When installing a wireless user interface in a room with fluorescent lights, mind the following to avoid interference:
 - Install the wireless user interface as close as possible to the indoor unit.
 - Install the indoor unit as far as possible from the fluorescent lights.
- Take care that in the event of a water leak, water cannot cause any damage to the installation space and surroundings.
- Choose a location where the hot/cold air discharged from the unit or the operation noise, will NOT disturb anyone.



WARNING

Do NOT place objects below the indoor and/or outdoor unit that may get wet. In this condition, condensation on the main unit or refrigerant pipes, air filter dirt or drain blockage may cause dripping. This results in fouling or failure of the object which is located beneath the unit.

- **Air flow.** Make sure nothing blocks the air flow.
- **Drainage.** Make sure condensation water can be evacuated properly.
- **Ceiling insulation.** When conditions in the ceiling exceed 30°C and a relative humidity of 80%, or when fresh air is inducted into the ceiling, then additional insulation is required (minimum 10 mm thickness, polyethylene foam).
- **Protective guards.** Make sure to install protective guards on the suction and discharge side to prevent somebody from touching the fan blades or heat exchanger.

Do NOT install the unit in the following places:

- In places where a mineral oil mist, spray or vapour may be present in the atmosphere. Plastic parts may deteriorate and fall off or cause water leakage.

It is NOT recommended to install the unit in the following places because it may shorten the life of the unit:

- Where the voltage fluctuates a lot
- In vehicles or vessels
- Where acidic or alkaline vapour is present
- Use **suspension bolts** for installation.
- **Spacing.** Mind the following requirements:

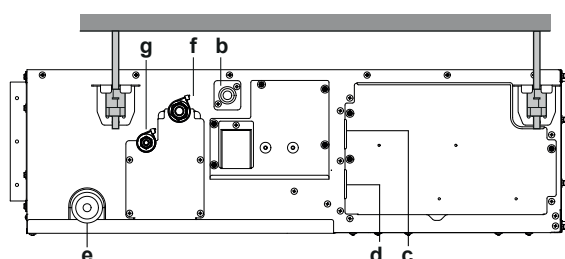
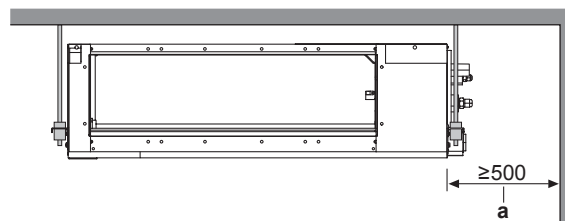

- a Service space
- b Drain pipe
- c Power supply wiring port
- d Transmission wiring port
- e Maintenance drain outlet
- f Gas pipe
- g Liquid pipe

Installation options:

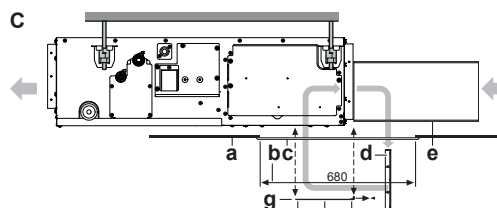
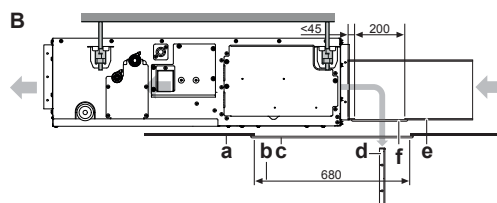
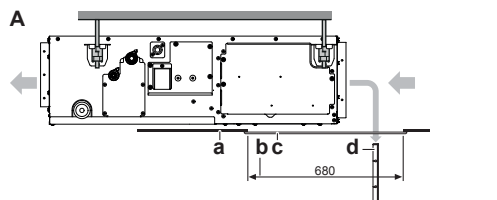

- A Standard rear suction
- B Installation with rear duct and duct service opening
- C Installation with rear duct, no duct service opening
- a Ceiling surface
- b Ceiling opening
- c Service access panel (optional accessory)
- d Air filter
- e Air inlet filter
- f Duct service opening
- g Interchangeable plate

6 Installation

5.3 Preparing refrigerant piping

5.3.1 Refrigerant piping requirements



INFORMATION

Also read the precautions and requirements in the "General safety precautions" chapter.

Refrigerant piping material

- **Piping material:** Phosphoric acid deoxidised seamless copper.
- **Piping temper grade and thickness:**

Outer diameter (Ø)	Temper grade	Thickness (t) ^(a)	
6.4 mm (1/4")	Annealed (O)	≥0.8 mm	
9.5 mm (3/8")			
12.7 mm (1/2")			
15.9 mm (5/8")			

- (a) Depending on the applicable legislation and the unit's maximum working pressure (see "PS High" on the unit name plate), larger piping thickness might be required.

- **Flare connections:** Only use annealed material.

Refrigerant piping diameter

Use the same diameters as the connections on the outdoor units:

Model	L1 liquid piping	L1 gas piping
FBA35A2VEB	Ø6.4	Ø9.5
FBA50~60A2VEB	Ø6.4	Ø12.7
FBA71~140A2VEB	Ø9.5	Ø15.9

5.3.2 Refrigerant piping insulation

- Use polyethylene foam as insulation material:
 - with a heat transfer rate between 0.041 and 0.052 W/mK (0.035 and 0.045 kcal/mh°C)
 - with a heat resistance of at least 120°C
- Insulation thickness

Pipe outer diameter (Ø _p)	Insulation inner diameter (Ø _i)	Insulation thickness (t)
6.4 mm (1/4")	8~10 mm	≥10 mm
9.5 mm (3/8")	10~14 mm	≥13 mm
12.7 mm (1/2")	14~16 mm	≥10 mm
15.9 mm (5/8")	16~20 mm	≥13 mm

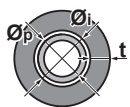

If the temperature is higher than 30°C and the humidity is higher than RH 80%, the thickness of the insulation materials should be at least 20 mm to prevent condensation on the surface of the insulation.

5.4 Preparing electrical wiring

5.4.1 About preparing electrical wiring



INFORMATION

Also read the precautions and requirements in the "General safety precautions" chapter.



WARNING

- If the power supply has a missing or wrong N-phase, equipment might break down.
- Establish proper earthing. Do NOT earth the unit to a utility pipe, surge absorber, or telephone earth. Incomplete earthing may cause electrical shock.
- Install the required fuses or circuit breakers.
- Secure the electrical wiring with cable ties so that the cables do NOT come in contact with sharp edges or piping, particularly on the high-pressure side.
- Do NOT use taped wires, stranded conductor wires, extension cords, or connections from a star system. They can cause overheating, electrical shock or fire.
- Do NOT install a phase advancing capacitor, because this unit is equipped with an inverter. A phase advancing capacitor will reduce performance and may cause accidents.



WARNING

- All wiring must be performed by an authorized electrician and must comply with the applicable legislation.
- Make electrical connections to the fixed wiring.
- All components procured on the site and all electrical construction must comply with the applicable legislation.



WARNING

ALWAYS use multicore cable for power supply cables.

6 Installation

6.1 Overview: Installation

This chapter describes what you have to do and know on-site to install the system.

Typical workflow

Installation typically consists of the following stages:

- Mounting the outdoor unit.
- Mounting the indoor unit.
- Connecting the refrigerant piping.
- Checking the refrigerant piping.
- Charging refrigerant.
- Connecting the electrical wiring.
- Finishing the outdoor installation.
- Finishing the indoor installation.



INFORMATION

This chapter only describes installation instructions specific to the indoor unit. For the other instructions, see:

- The installation manual of the outdoor unit
- The installation manual of the user interface
- The installation manual of the optional accessories

6.2 Mounting the indoor unit

6.2.1 Precautions when mounting the indoor unit

i INFORMATION

Also read the precautions and requirements in the following chapters:

- General safety precautions
- Preparation

6.2.2 Guidelines when installing the indoor unit

i INFORMATION

Optional equipment. When installing optional equipment, also read the installation manual of the optional equipment. Depending on the field conditions, it might be easier to install the optional equipment first.

- **In case of installation with duct, but no duct service opening.** Modify the position of the air filters.

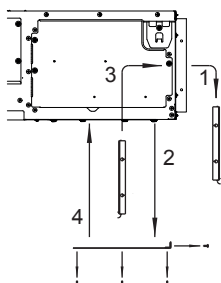

- 1 Remove the air filter(s) from the outside of the unit.
 - 2 Remove the interchangeable plate.
 - 3 Install the air filter(s) on the inside of the unit.
 - 4 Reinstall the interchangeable plate.
- When installing an air inlet duct, select fixing screws that stick out 5 mm on the inside of the flange to protect the air filter from damage during maintenance of the filter.

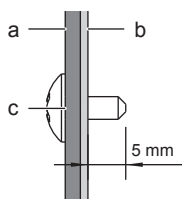

- a Air inlet duct
- b Inside of the flange
- c Fixing screw

- **Ceiling strength.** Check whether the ceiling is strong enough to support the weight of the unit. If there is a risk, reinforce the ceiling before installing the unit.
- **Installation options:**

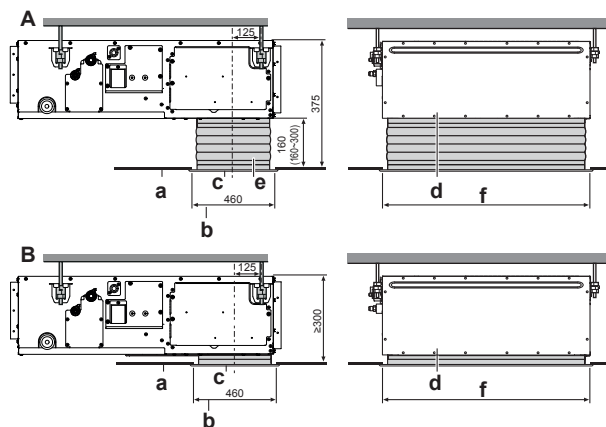

Model	f (mm)
35~50	760
60~71	1060
100~140	1460

- A Mounting the air inlet with a canvas connection
- B Mounting the air inlet panel directly
- a Ceiling surface
- b Ceiling opening
- c Air inlet panel (optional accessory)
- d Indoor unit (back side)
- e Canvas connection for air inlet panel (optional accessory)

! NOTICE

The unit can be used with bottom suction by replacing the interchangeable plate by the air filter holding plate.

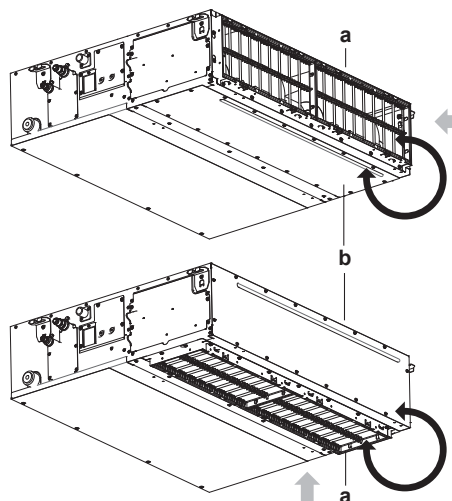

- a Air filter holding plate with air filter(s)
- b Interchangeable plate

- **Suspension bolts.** Use M10 suspension bolts for installation. Attach the hanger bracket to the suspension bolt. Fix it securely using a nut and washer from the upper and lower sides of the hanger bracket.
- **Ceiling opening size.** Make sure the ceiling opening is within the following limits:

6 Installation

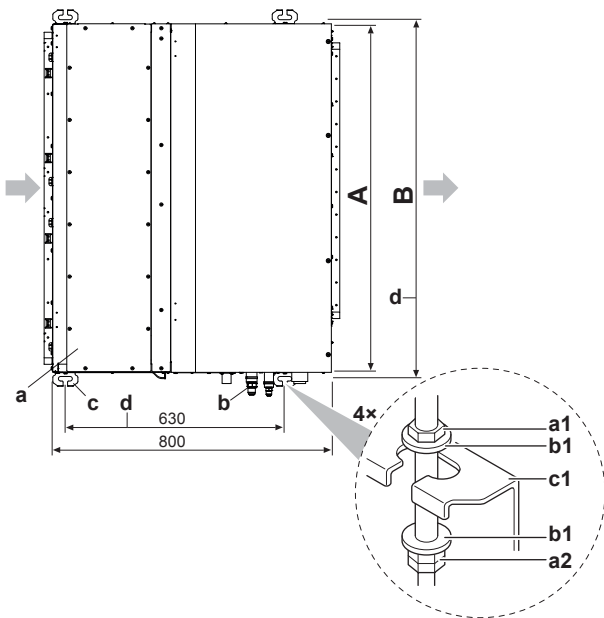

Model	A (mm)	B (mm)
35~50	700	738
60~71	1000	1038
100~140	1400	1438

- a1 Nut (field supply)
- a2 Double nut (field supply)
- b1 Washer (accessories)
- c1 Hanger bracket (attached to the unit)
- a Indoor unit
- b Pipe
- c Hanger bracket pitch (suspension)
- d Suspension bolt spacing



INFORMATION

- The fan speed of the indoor unit is preset to ensure the standard external static pressure.
- To set a higher or lower external static pressure, reset the initial setting with user interface.

Installation example:

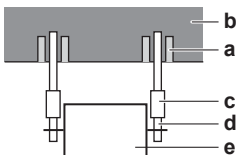

- a Anchor
- b Ceiling slab
- c Long nut or turn-buckle
- d Suspension bolt
- e Indoor unit

Install the unit temporarily.

- 5 Attach the hanger bracket to the suspension bolt.
 - 6 Fix it securely.
- **Level.** Make sure the unit is level at all four corners using a level or a water-filled vinyl tube.

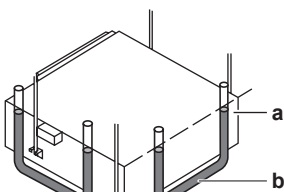

- a Water level
- b Vinyl tube

- 7 Tighten the upper nut.



NOTICE

Do NOT install the unit tilted. **Possible consequence:** If the unit is tilted against the direction of the condensate flow (the drain piping side is raised), the float switch might malfunction and cause water to drip.

6.2.3 Guidelines when installing the ducting

The ducting is to be field supplied.

- **Air inlet side.** Attach the duct and intake-side flange (field supply). For connecting the flange, use 7 accessory screws.

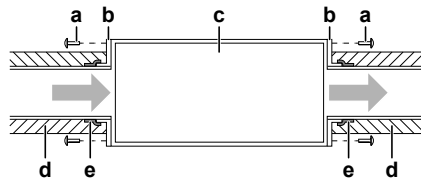

- a Connection screw (accessory)
- b Flange (field supply)
- c Main unit
- d Insulation (field supply)
- e Aluminium tape (field supply)

- **Filter.** Be sure to attach an air filter inside the air passage on the intake side. Use an air filter with dust collecting efficiency $\geq 50\%$ (gravimetric method). The included filter is not used when the intake duct is attached.
- **Air outlet side.** Connect the duct according to the inside dimension of the outlet-side flange.
- **Air leaks.** Wind aluminium tape around the intake side flange and duct connection. Make sure there are no air leaks at any other connection.
- **Insulation.** Insulate the duct to prevent condensation from forming. Use glass wool or polyethylene foam 25 mm thick.

6.2.4 Guidelines when installing the drain piping

Make sure condensation water can be evacuated properly. This involves:

- General guidelines
- Connecting the drain piping to the indoor unit
- Checking for water leaks

General guidelines

- **Drain pump.** For this "high lift type", the drainage sounds will be reduced when the drain pump is installed in a higher location. Recommended height is 300 mm.
- **Pipe length.** Keep drain piping as short as possible.
- **Pipe size.** Keep the pipe size equal to or greater than that of the connecting pipe (vinyl pipe of 25 mm nominal diameter and 32 mm outer diameter).
- **Slope.** Make sure the drain piping slopes down (at least 1/100) to prevent air from being trapped in the piping. Use hanging bars as shown.

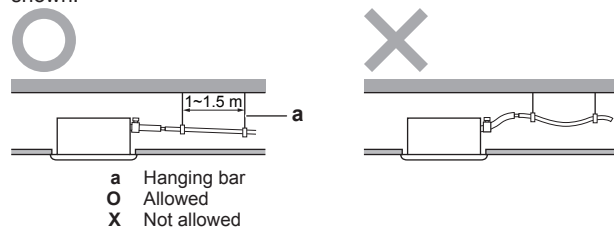

- **Condensation.** Take measures against condensation. Insulate the complete drain piping in the building.

- **Rising piping.** If necessary to make the slope possible, you can install rising piping.
 - Drain hose inclination: 0~75 mm to avoid stress on the piping and to avoid air bubbles.
 - Rising piping: ≤300 mm from the unit, ≤625 mm perpendicular to the unit.

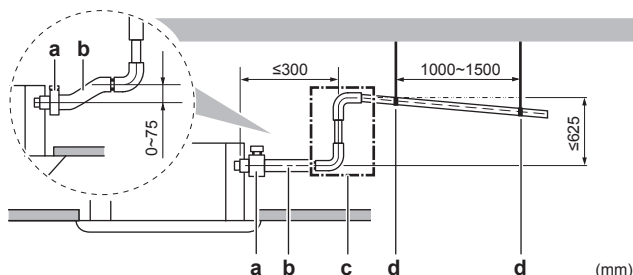

- a Metal clamp (accessory)
- b Drain hose (accessory)
- c Rising drain piping (vinyl pipe of 25 mm nominal diameter and 32 mm outer diameter) (field supply)
- d Hanging bars (field supply)

- **Combining drain pipes.** You can combine drain pipes. Make sure to use drain pipes and T-joints with the correct gauge for the operating capacity of the units.

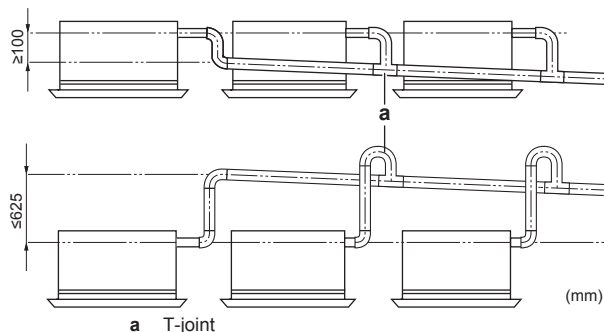

a T-joint

To connect the drain piping to the indoor unit

NOTICE

Incorrect connection of the drain hose might cause leaks, and damage the installation space and surroundings.

- 1 Push the drain hose as far as possible over the drain pipe connection.
- 2 Tighten the metal clamp until the screw head is less than 4 mm from the metal clamp part.
- 3 Check for water leaks (see "To check for water leaks" on page 13).
- 4 Install the insulation piece (drain pipe).
- 5 Wind the large sealing pad (= insulation) around the metal clamp and drain hose, and fix it with cable ties.
- 6 Connect the drain piping to the drain hose.

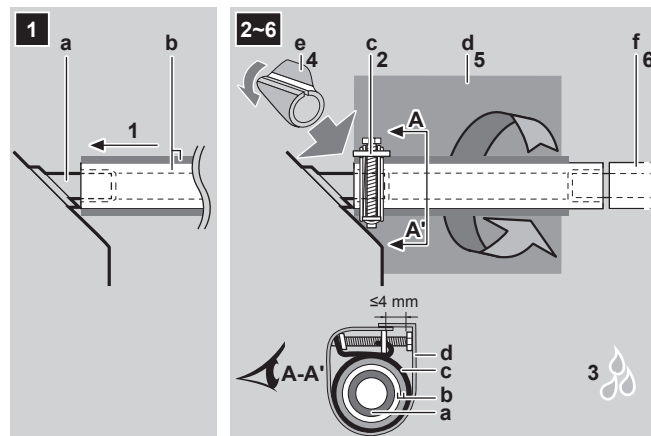

- a Drain pipe connection (attached to the unit)
- b Drain hose (accessory)
- c Metal clamp (accessory)
- d Large sealing pad (accessory)
- e Insulation piece (drain pipe) (accessory)
- f Drain piping (field supply)

NOTICE

- Do NOT remove the drain pipe plug. Water might leak out.
- Use the drain outlet only to discharge the water if the drain pump is not used or before maintenance.
- Insert and remove the drain plug gently. Excessive force may deform the drain socket of the drain pan.

Pull out the plug.

- Do NOT wiggle the plug up and down.

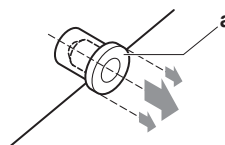

Push in the plug.

- Set the plug and push it in using a Phillips screwdriver.

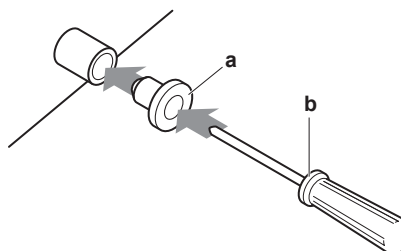

- a Drain plug
- b Phillips screwdriver

To check for water leaks

The procedure differs depending on whether electrical wiring is already finished. When electrical wiring is not finished yet, you need to temporarily connect the user interface and power supply to the unit.

When electrical wiring is not finished yet

- 1 Temporarily connect electrical wiring.
- 2 Remove the switch box cover (a).
- 3 Connect the single-phase power supply (50 Hz, 230 V) to connections No. 1 and No. 2 on the terminal block for power supply (d) and earth (c).
- 4 Reattach the switch box cover (a).

6 Installation

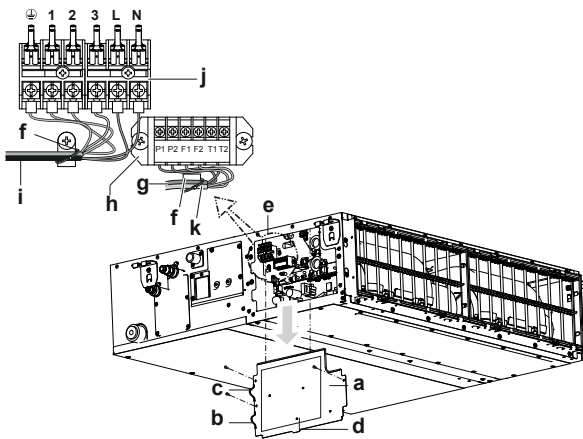

- a Switch box cover
- b Transmission wiring port
- c Power supply wiring port
- d Wiring diagram
- e Switch box
- f Plastic clamp
- g User interface wiring
- h Terminal board for unit transmission wiring
- i Power supply wiring
- j Power supply terminal board
- k Transmission wiring between units

- 5 Turn ON the power.
- 6 Start cooling operation (see To perform a test run).
- 7 Gradually put approximately 1 l of water through the air discharge outlet, and check for leaks.

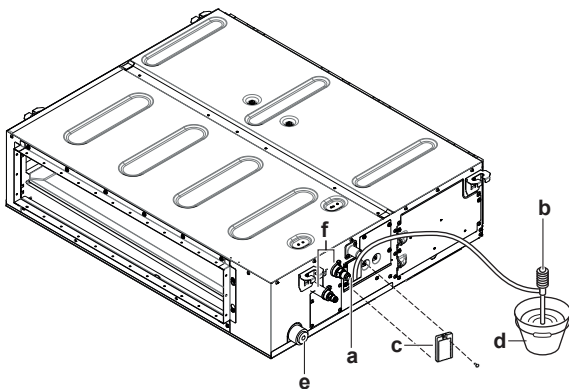

- a Water inlet
- b Portable pump
- c Water inlet cover
- d Bucket (adding water through water inlet)
- e Drain outlet for maintenance
- f Refrigerant pipes

- 8 Turn OFF the power.
- 9 Disconnect the electrical wiring.
- 10 Remove the control box cover.
- 11 Disconnect the power supply and earth.
- 12 Reattach the control box cover.

When electrical wiring is finished already

- 1 Start cooling operation (see To perform a test run).
- 2 Gradually pour approximately 1 l of water through the air discharge outlet, and check for leaks (see When electrical wiring is not finished yet).

6.3 Connecting the refrigerant piping

6.3.1 About connecting the refrigerant piping

Before connecting the refrigerant piping

Make sure the outdoor and indoor unit are mounted.

Typical workflow

Connecting the refrigerant piping involves:

- Connecting the refrigerant piping to the outdoor unit
- Connecting the refrigerant piping to the indoor unit
- Insulating the refrigerant piping
- Keeping in mind the guidelines for:
 - Pipe bending
 - Flaring pipe ends
 - Brazing
 - Using the stop valves

6.3.2 Precautions when connecting the refrigerant piping



INFORMATION

Also read the precautions and requirements in the following chapters:

- General safety precautions
- Preparation



DANGER: RISK OF BURNING



CAUTION

- Do NOT use mineral oil on flared part.
- NEVER install a drier to this unit to guarantee its lifetime. The drying material may dissolve and damage the system.



NOTICE

Take the following precautions on refrigerant piping into account:

- Avoid anything but the designated refrigerant to get mixed into the refrigerant cycle (e.g. air).
- Only use R32 or R410A^(a) when adding refrigerant.
- Only use installation tools (e.g. manifold gauge set) that are exclusively used for R32 or R410A^(a) installations to withstand the pressure and to prevent foreign materials (e.g. mineral oils and moisture) from mixing into the system.
- Install the piping so that the flare is NOT subjected to mechanical stress.
- Protect the piping as described in the following table to prevent dirt, liquid or dust from entering the piping.
- Use caution when passing copper tubes through walls (see figure below).

Refer to the outdoor unit specifications for the type of refrigerant to be used.

- (a) Refer to the outdoor unit specifications for the type of refrigerant to be used.

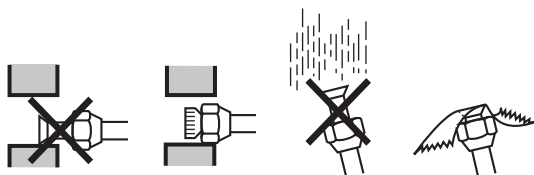

Unit	Installation period	Protection method
Outdoor unit	>1 month	Pinch the pipe
	<1 month	Pinch or tape the pipe
Indoor unit	Regardless of the period	

i INFORMATION

Do NOT open the refrigerant stop valve before checking the refrigerant piping. When you need to charge additional refrigerant it is recommended to open the refrigerant stop valve after charging.

6.3.3 Guidelines when connecting the refrigerant piping

Take the following guidelines into account when connecting pipes:

- Coat the flare inner surface with ether oil or ester oil when connecting a flare nut. Tighten 3 or 4 turns by hand, before tightening firmly.

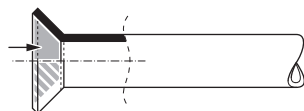

- Always use 2 wrenches together when loosening a flare nut.
- Always use a spanner and torque wrench together to tighten the flare nut when connecting the piping. This to prevent nut cracking and leaks.

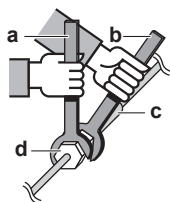

- a Torque wrench
- b Spanner
- c Piping union
- d Flare nut

Piping size (mm)	Tightening torque (N·m)	Flare dimensions (A) (mm)	Flare shape (mm)
Ø6.4	15~17	8.7~9.1	
Ø9.5	33~39	12.8~13.2	
Ø12.7	50~60	16.2~16.6	
Ø15.9	63~75	19.3~19.7	

6.3.4 Pipe bending guidelines

Use a pipe bender for bending. All pipe bends should be as gentle as possible (bending radius should be 30~40 mm or larger).

6.3.5 To flare the pipe end

! CAUTION

- Incomplete flaring may cause refrigerant gas leakage.
- Do NOT re-use flares. Use new flares to prevent refrigerant gas leakage.
- Use flare nuts that are included with the unit. Using different flare nuts may cause refrigerant gas leakage.

- Cut the pipe end with a pipe cutter.
- Remove burrs with the cut surface facing down so that the chips do not enter the pipe.



- a Cut exactly at right angles.
- b Remove burrs.

- Remove the flare nut from the stop valve and put the flare nut on the pipe.
- Flare the pipe. Set exactly at the position as shown in the following illustration.

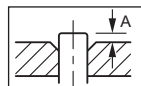

	Flare tool for R410A or R32 (clutch type)	Conventional flare tool	
		Clutch type (Ridgid-type)	Wing nut type (Imperial-type)
A	0~0.5 mm	1.0~1.5 mm	1.5~2.0 mm

- Check that the flaring is properly made.

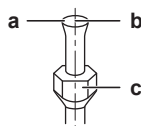

- a Flare's inner surface must be flawless.
- b The pipe end must be evenly flared in a perfect circle.
- c Make sure the flare nut is fitted.

6.3.6 To braze the pipe end

The indoor unit and outdoor unit have flare connections. Connect both ends without brazing. If brazing should be needed, take the following into account:

- When brazing, blow through with nitrogen to prevent creation of large quantities of oxidised film on the inside of the piping. This film adversely affects valves and compressors in the refrigerating system and prevents proper operation.
- Set the nitrogen pressure to 20 kPa (0.2 bar) (just enough so it can be felt on the skin) with a pressure-reducing valve.

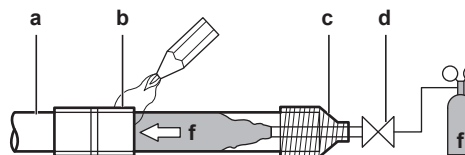

- a Refrigerant piping
- b Part to be brazed
- c Taping
- d Manual valve
- e Pressure-reducing valve
- f Nitrogen

- Do NOT use anti-oxidants when brazing pipe joints. Residue can clog pipes and break equipment.
- Do NOT use flux when brazing copper-to-copper refrigerant piping. Use phosphor copper brazing filler alloy (BCuP), which does not require flux. Flux has an extremely harmful influence on refrigerant piping systems. For instance, if chlorine based flux is used, it will cause pipe corrosion or, in particular, if the flux contains fluorine, it will deteriorate the refrigerant oil.

6.3.7 To connect the refrigerant piping to the indoor unit



WARNING: FLAMMABLE MATERIAL

The R32 refrigerant (if applicable) in this unit is mildly flammable.^(a)

- (a) Refer to the outdoor unit specifications for the type of refrigerant to be used.

6 Installation

- **Pipe length.** Keep refrigerant piping as short as possible.
- **Flare connections.** Connect refrigerant piping to the unit using flare connections.
- **Insulation.** Insulate the refrigerant piping on the indoor unit as follows:

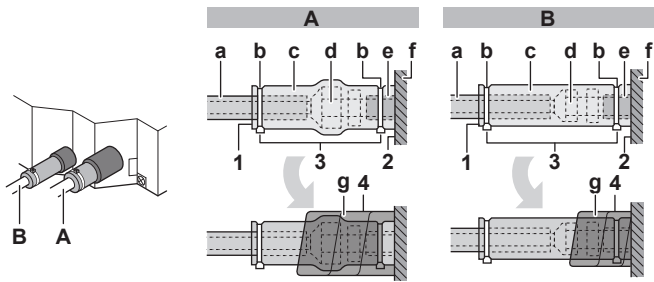

A Gas piping
B Liquid piping

- a** Insulation material (field supply)
b Cable tie (accessory)
c Insulation pieces: Large (gas pipe), small (liquid pipe) (accessories)
d Flare nut (attached to the unit)
e Refrigerant pipe connection (attached to the unit)
f Unit
g Sealing pads: Medium 1 (gas pipe), medium 2 (liquid pipe) (accessories)
- 1 Turn up the seams of the insulation pieces.
 - 2 Attach to the base of the unit.
 - 3 Tighten the cable ties on the insulation pieces.
 - 4 Wrap the sealing pad from the base of the unit to the top of the flare nut.



NOTICE

Make sure to insulate all refrigerant piping. Any exposed piping might cause condensation.

6.4 Connecting the electrical wiring

6.4.1 About connecting the electrical wiring

Typical workflow

Connecting the electrical wiring typically consists of the following stages:

- 1 Making sure the power supply system complies with the electrical specifications of the units.
- 2 Connecting the electrical wiring to the outdoor unit.
- 3 Connecting the electrical wiring to the indoor unit.
- 4 Connecting the main power supply.

6.4.2 Precautions when connecting the electrical wiring



INFORMATION

Also read the precautions and requirements in the following chapters:

- General safety precautions
- Preparation



DANGER: RISK OF ELECTROCUTION



WARNING

ALWAYS use multicore cable for power supply cables.



WARNING

If the supply cord is damaged, it must be replaced by the manufacturer, its service agent or similarly qualified persons in order to avoid a hazard.

6.4.3 Guidelines when connecting the electrical wiring

Keep the following in mind:

- If stranded conductor wires are being used, install a round crimp-style terminal on the tip. Place the round crimp-style terminal on the wire up to the covered part and fasten the terminal with the appropriate tool.

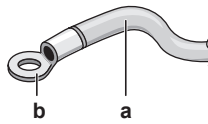

a Stranded conductor wire
b Round crimp-style terminal

- Use the following methods for installing wires:

Wire type	Installation method
Single core wire	<p>a Curled single core wire b Screw c Flat washer</p>
Stranded conductor wire with round crimp-style terminal	<p>a Terminal b Screw c Flat washer</p>

Tightening torques

Wiring	Screw size	Tightening torque (N·m)
Interconnection cable (indoor↔outdoor)	M4	1.18~1.44
User interface cable	M3.5	0.79~0.97

- If single-core wires are used, be sure to curl the end of the lead. Improper work may cause heat or fire.
- The earth wire between the pull relief and the terminal must be longer than the other wires.

6.4.4 To connect the electrical wiring on the indoor unit



NOTICE

- Follow the wiring diagram (delivered with the unit, located on the switch box cover).
- Make sure the electrical wiring does NOT obstruct proper reattachment of the service cover.

It is important to keep the power supply and the transmission wiring separated from each other. In order to avoid any electrical interference the distance between both wiring should always be at least 50 mm.



NOTICE

Be sure to keep the power line and transmission line apart from each other. Transmission wiring and power supply wiring may cross, but may not run parallel.

- 1 Remove the service cover.
- 2 **User interface cable:** Route the cable through the frame, connect the cable to the terminal block, and fix the cable with a cable tie.
- 3 **Interconnection cable** (indoor↔outdoor): Route the cable through the frame, connect the cable to the terminal block (make sure the numbers match with the numbers on the outdoor unit, and connect the earth wire), and fix the cable with a cable tie.
- 4 Divide the small sealing (accessory) and wrap it around the cables to prevent water from entering the unit. Seal all gaps to prevent small animals from entering the system.



WARNING

Provide adequate measures to prevent that the unit can be used as a shelter by small animals. Small animals that make contact with electrical parts can cause malfunctions, smoke or fire.

- 5 Reattach the service cover.

• When using 1 user interface with 1 indoor unit.

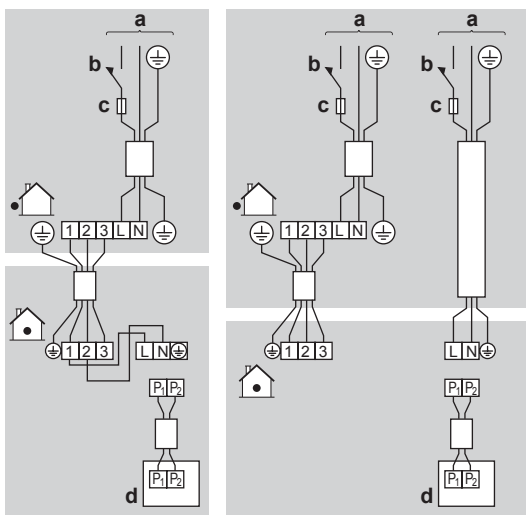

• When using 2 user interface¹

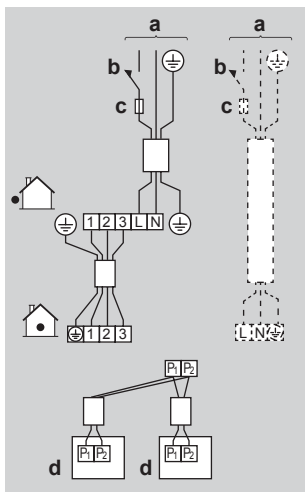

• When using group control¹

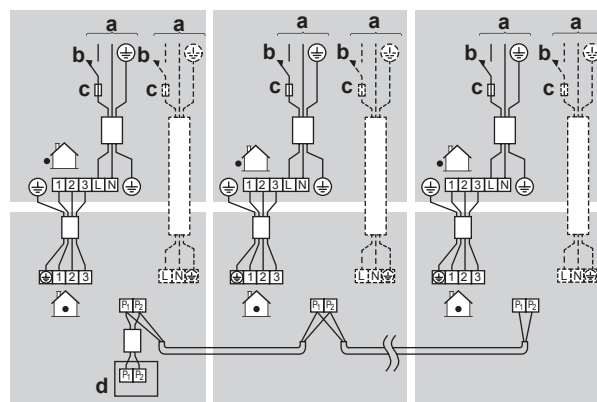

- a Power supply
- b Main switch
- c Fuse
- d User interface

- **Master unit:** Be sure to connect the wiring when combining with a simultaneously operating multi-type in group control.
- Use separate power only in case of following combination:

1×FBA35A + RXS35L or RXM35M
2×FBA60A + RR100/125B or RQ100/125B
2×FBA71A + RR100/125B or RQ100/125B
4×FBA50A + RZQ200C
3×FBA60A + RZQ200C
3×FBA71A + RZQ200C
2×FBA100A + RZQ200C
4×FBA60A + RZQ200C
2×FBA125A + RZQ200C

- **EN/IEC 61000-3-12** provided that the short-circuit power S_{sc} is greater than or equal to the minimum S_{sc} value at the interface point between the user's supply and the public system.
 - EN/IEC 61000-3-12 = European/International Technical Standard setting the limits for harmonic currents produced by equipment connected to public low-voltage systems with input current >16 A and ≤75 A per phase.
 - It is the responsibility of the installer or user of the equipment to ensure, by consultation with the distribution network operator if necessary, that the equipment is connected only to a supply with a short-circuit power S_{sc} greater than or equal to the minimum S_{sc} value.
- Ensure that equipment is connected only to a supply with a short-circuit power S_{sc} greater than or equal to S_{sc} in table below.

Combination	FBA35A	FBA50A	FBA60A	FBA71A
RZAG71M	2 (—)	—	—	1 (—)
RZQG71L				
RZAG100M	3 (2.31)	2 (1.30)	—	—
RZQG100L				
RZAG125M	4 (3.33)	3 (2.32)	2 (2.05)	—
RZQG125L				
RZAG140M	4 (3.33)	3 (2.32)	—	2 (2.05)
RZQG140L				
RZASG71M	2 (1.10)	—	—	1 (1.22)
RZQSG71L				
RZASG100M	2 (1.65)	2 (—)	—	—
RZQSG100L				

⁽¹⁾ Dashed line represents separate power supply.

7 Configuration

RZASG125M	4 (3.33)	3 (2.32)	2 (2.05)	—
RZQSG125L				
RZASG140M	4 (3.33)	3 (2.32)	—	2 (2.05)
RZQSG140L				

Combination	FBA100A	FBA125A	FBA140A
RZAG71M	—	—	—
RZQG71L			
RZAG100M	1 (0.73)	—	—
RZQG100L			
RZAG125M	—	1 (0.74)	—
RZQG125L			
RZAG140M	—	—	1 (0.74)
RZQG140L			
RZASG71M	—	—	—
RZQSG71L			
RZASG100M	1 (—)	—	—
RZQSG100L			
RZASG125M	—	1 (0.74)	—
RZQSG125L			
RZASG140M	—	—	1 (0.74)
RZQSG140L			



INFORMATION

In case of group control it is not necessary to address the indoor unit. The address is automatically set when the power is activated.

6.4.5 Specifications of standard wiring components

Component		FBA			
		35+50	60+71	100	125+140
Power supply cable	MCA ^(a)	1.4 A	1.3 A	3.5 A	3.9 A
	Voltage	220~240 V			
	Phase	1~			
	Frequency	50/60 Hz			
	Wire sizes	Must comply with applicable legislation			
Interconnection cable		Minimum cable section of 2.5 mm ² and applicable for 220~240 V			
User interface cable		Vinyl cord with 0.75 to 1.25 mm ² sheath or cables (2 core wires) Maximum 500 m			
Recommended field fuse		16 A			
Earth leakage circuit breaker		Must comply with applicable legislation			

- (a) MCA=Minimum circuit ampacity. Stated values are maximum values (see electrical data of combination with indoor units for exact values).

⁽²⁾ Field settings are defined as follows:

- **M**: Mode number – **First number**: for group of units – **Number between brackets**: for individual unit
- **C1**: First code number
- **C2**: Second code number
- **■**: Default

7 Configuration

7.1 Field settings

Make the following field settings so that they correspond with the actual installation setup and with the needs of the user:

- External static pressure setting using:
 - Airflow automatic adjustment setting
 - User interface
- Time to clean air filter

To set airflow automatic adjustment

- When the air conditioning unit is running in fan operation mode:

- 1 Stop the air conditioning unit.
- 2 Set second code number to 03.

Setting content:	Then ²		
	M	C1	C2
Airflow adjustment is OFF	11(21)	7	01
Press ON/OFF to return to normal operating mode.			03
Possible consequence: The operation lamp will light up and the unit will start the fan operation for airflow automatic adjustment.			
Operation stops after 1 to 8 minutes.			02
Possible consequence: Setting is finished and the operation lamp will be off.			

If there is no change after airflow adjustment, perform the setting again.

User interface

Check the indoor unit setting: the second code number of mode 11(21) must be set to 01.

Change the second code number according to the external static pressure of the duct to be connected as in table below.

M	C1	C2	External static pressure			
			FBA			
			35	50	60	71
13(23)	6	01	30	30	30	30
		02	—	—	—	—
		03	30	30	30	30
		04	40	40	40	40
		05	50	50	50	50
		06	60	60	60	60
		07	70	70	70	70
		08	80	80	80	80
		09	90	90	90	90
		10	100	100	100	100
		11	110	110	110	110
		12	120	120	120	120
		13	130	130	130	130
		14	140	140	140	140
		15	150	150	150	150

M	C1	C2	External static pressure		
			FBA		
			100	125	140
13(23)	6	01	40	50	50
		02	—	—	—
		03	—	—	—
		04	40	—	—
		05	50	50	50
		06	60	60	60
		07	70	70	70
		08	80	80	80
		09	90	90	90
		10	100	100	100
		11	110	110	110
		12	120	120	120
		13	130	130	130
		14	140	140	140
		15	150	150	150

Time to clean air filter

This setting must correspond with the air contamination in the room. It determines the interval at which the **TIME TO CLEAN AIR FILTER** notification is displayed on the user interface. When using a wireless user interface, you must also set the address (see the installation manual of the user interface).

If you want an interval of... (air contamination)	Then ²		
	M	C1	C2
±2500 h (light)	10(20)	0	01
±1250 h (heavy)			02
No notification		3	02

- **2 user interfaces:** When using 2 user interfaces one must be set to "MAIN" and the other to "SUB".

⁽²⁾ Field settings are defined as follows:

- **M:** Mode number – **First number:** for group of units – **Number between brackets:** for individual unit
- **C1:** First code number
- **C2:** Second code number
- **■:** Default

8 Commissioning

8.1 Overview: Commissioning

This chapter describes what you have to do and know to commission the system after it is installed.

Typical workflow

Commissioning typically consists of the following stages:

- 1 Checking the "Checklist before commissioning".
- 2 Performing a test run for the system.

8.2 Checklist before commissioning

Do NOT operate the system before the following checks are OK:

<input type="checkbox"/>	You read the complete installation instructions, as described in the installer reference guide .
<input type="checkbox"/>	The indoor units are properly mounted.
<input type="checkbox"/>	In case a wireless user interface is used: The indoor unit decoration panel with infrared receiver is installed.
<input type="checkbox"/>	The outdoor unit is properly mounted.
<input type="checkbox"/>	There are NO missing phases or reversed phases .
<input type="checkbox"/>	The system is properly earthed and the earth terminals are tightened.
<input type="checkbox"/>	The fuses or locally installed protection devices are installed according to this document, and have not been bypassed.
<input type="checkbox"/>	The power supply voltage matches the voltage on the identification label of the unit.
<input type="checkbox"/>	There are NO loose connections or damaged electrical components in the switch box.
<input type="checkbox"/>	The insulation resistance of the compressor is OK.
<input type="checkbox"/>	There are NO damaged components or squeezed pipes on the inside of the indoor and outdoor units.
<input type="checkbox"/>	There are NO refrigerant leaks .
<input type="checkbox"/>	The correct pipe size is installed and the pipes are properly insulated.
<input type="checkbox"/>	The stop valves (gas and liquid) on the outdoor unit are fully open.

8.3 To perform a test run

This task is only applicable when using the BRC1E52 or BRC1E53 user interface. When using any other user interface, see the installation manual or service manual of the user interface.



NOTICE

Do not interrupt the test run.

9 Hand-over to the user



INFORMATION

Backlight. To perform an ON/OFF action on the user interface, the backlight does not need to be lit. For any other action, it needs to be lit first. The backlight is lit for ± 30 seconds when you press a button.

1 Perform introductory steps.

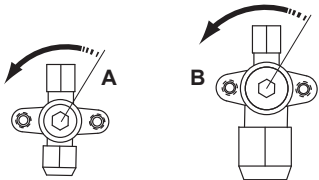
#	Action
1	Open the liquid stop valve (A) and gas stop valve (B) by removing the stem cap and turning counterclockwise with a hex wrench until it stops. 
2	Close the service cover to prevent electric shocks.
3	Turn ON power for at least 6 hours before starting operation to protect the compressor.
4	On the user interface, set the unit to cooling operation mode.

2 Start the test run

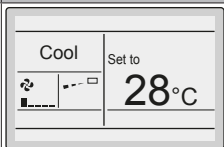
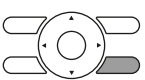
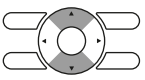
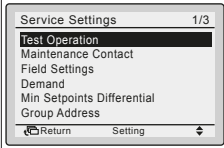
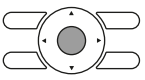
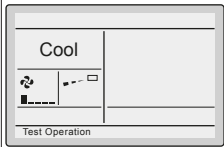
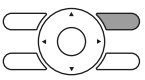
#	Action	Result
1	Go to the home menu. 	
2	Press at least 4 seconds. 	The Service Settings menu is displayed.
3	Select Test Operation. 	
4	Press. 	Test Operation is displayed on the home menu. 
5	Press within 10 seconds. 	Test run starts.

3 Check operation for 3 minutes.

4 Stop the test run.

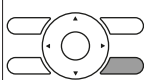
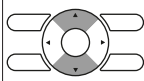
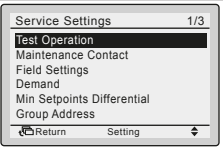
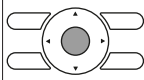
#	Action	Result
1	Press at least 4 seconds. 	The Service Settings menu is displayed.
2	Select Test Operation. 	
3	Press. 	The unit returns to normal operation, and the home menu is displayed.

8.4 Error codes when performing a test run

If the installation of the outdoor unit has NOT been done correctly, the following error codes may be displayed on the user interface:

Error code	Possible cause
Nothing displayed (the currently set temperature is not displayed)	<ul style="list-style-type: none"> The wiring is disconnected or there is a wiring error (between power supply and outdoor unit, between outdoor unit and indoor units, between indoor unit and user interface). The fuse on the outdoor or indoor unit PCB has blown.
E3, E4 or L8	<ul style="list-style-type: none"> The stop valves are closed. The air inlet or air outlet is blocked.
E7	There is a missing phase in case of three-phase power supply units. Note: Operation will be impossible. Turn OFF the power, recheck the wiring, and switch two of the three electrical wires.
L4	The air inlet or air outlet is blocked.
U0	The stop valves are closed.
U2	<ul style="list-style-type: none"> There is a voltage imbalance. There is a missing phase in case of three-phase power supply units. Note: Operation will be impossible. Turn OFF the power, recheck the wiring, and switch two of the three electrical wires.
U4 or UF	The inter-unit branch wiring is not correct.
UA	The outdoor and indoor unit are incompatible.

9 Hand-over to the user

Once the test run is finished and the unit operates properly, please make sure the following is clear for the user:

- Make sure that the user has the printed documentation and ask him/her to keep it for future reference. Inform the user that he can find the complete documentation on the url as earlier described in this manual.
- Explain the user how to properly operate the system and what to do in case of problems.
- Show the user what to do in relation to maintaining the unit.

10 Disposal



NOTICE















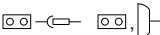

Do not try to dismantle the system yourself: the dismantling of the system, treatment of the refrigerant, oil and other parts must comply with applicable legislation. Units must be treated at a specialised treatment facility for reuse, recycling and recovery.

11 Technical data

- A **subset** of the latest technical data is available on the regional Daikin website (publicly accessible).
- The **full set** of latest technical data is available on the Daikin extranet (authentication required).

11 Technical data

11.1 Wiring diagram

Unified Wiring Diagram Legend			
For applied parts and numbering refer to the wiring diagram sticker supplied on the unit. Part numbering is realized by Arabic numbers in ascending order for each part and is represented in the overview below by symbol **n** in the part code.			
	: CIRCUIT BREAKER		: PROTECTIVE EARTH
	: CONNECTION		: PROTECTIVE EARTH (SCREW)
	: CONNECTOR		: RECTIFIER
	: EARTH		: RELAY CONNECTOR
	: FIELD WIRING		: SHORT CIRCUIT CONNECTOR
	: FUSE		: TERMINAL
	: INDOOR UNIT		: TERMINAL STRIP
	: OUTDOOR UNIT		: WIRE CLAMP
BLK : BLACK	GRN : GREEN	PNK : PINK	WHT : WHITE
BLU : BLUE	GRY : GREY	PRP,PPL : PURPLE	YLW : YELLOW
BRN : BROWN	ORG : ORANGE	RED : RED	
A*P : PRINTED CIRCUIT BOARD	PS : SWITCHING POWER SUPPLY	BS* : PUSH BUTTON ON / OFF, OPERATION SWITCH	PTC* : THERMISTOR PTC
BZ, H*O : BUZZER	Q* : INSULATED GATE BIPOLAR TRANSISTOR (IGBT)	C* : CAPACITOR	Q*DI : EARTH LEAK CIRCUIT BREAKER
AC*, CN*, E*, HA*, HE, HL*, HN*, HR*, MR*_A, MR*_B, S*, U, V, W, X*A : CONNECTION, CONNECTOR	Q*L : OVERLOAD PROTECTOR	D*, V*D : DIODE	Q*M : THERMO SWITCH
DB* : DIODE BRIDGE	R* : RESISTOR	DS* : DIP SWITCH	R*T : THERMISTOR
E*H : HEATER	RC : RECEIVER	F*U, FL* (FOR CHARACTERISTICS REFER TO PCB INSIDE YOUR UNIT) : FUSE	S*C : LIMIT SWITCH
FG* : CONNECTOR (FRAME GROUND)	S*L : FLOAT SWITCH	H* : HARNESS	S*NPH : PRESSURE SENSOR (HIGH)
H*P, LED*, V*L : PILOT LAMP, LIGHT EMITTING DIODE	S*NPL : PRESSURE SENSOR (LOW)	HAP : LIGHT EMITTING DIODE (SERVICE MONITOR GREEN)	S*PH, HPS* : PRESSURE SWITCH (HIGH)
HIGH VOLTAGE : HIGH VOLTAGE	S*PL : PRESSURE SWITCH (LOW)	IES : INTELLIGENT EYE SENSOR	S*T : THERMOSTAT
IPM* : INTELLIGENT POWER MODULE	S*W, SW* : OPERATION SWITCH	K*R, KCR, KFR, KHuR : MAGNETIC RELAY	SA* : SURGE ARRESTOR
L : LIVE	SR*, WLU : SIGNAL RECEIVER	L* : COIL	SS* : SELECTOR SWITCH
L*R : REACTOR	SHEET METAL : TERMINAL STRIP FIXED PLATE	L*R : REACTOR	T*R : TRANSFORMER
M* : STEPPER MOTOR	TC, TRC : TRANSMITTER	M*C : COMPRESSOR MOTOR	V*, R*V : VARISTOR
M*F : FAN MOTOR	V*R : DIODE BRIDGE	M*P : DRAIN PUMP MOTOR	WRC : WIRELESS REMOTE CONTROLLER
M*S : SWING MOTOR	X* : TERMINAL	MR*, MRCW*, MRM*, MRN* : MAGNETIC RELAY	X*M : TERMINAL STRIP (BLOCK)
N : NEUTRAL	Y*E : ELECTRONIC EXPANSION VALVE COIL	n=* : NUMBER OF PASSES THROUGH FERRITE CORE	Y*R, Y*S : REVERSING SOLENOID VALVE COIL
PAM : PULSE-AMPLITUDE MODULATION	Z*C : FERRITE CORE	PCB* : PRINTED CIRCUIT BOARD	ZF, Z*F : NOISE FILTER
PM* : POWER MODULE			

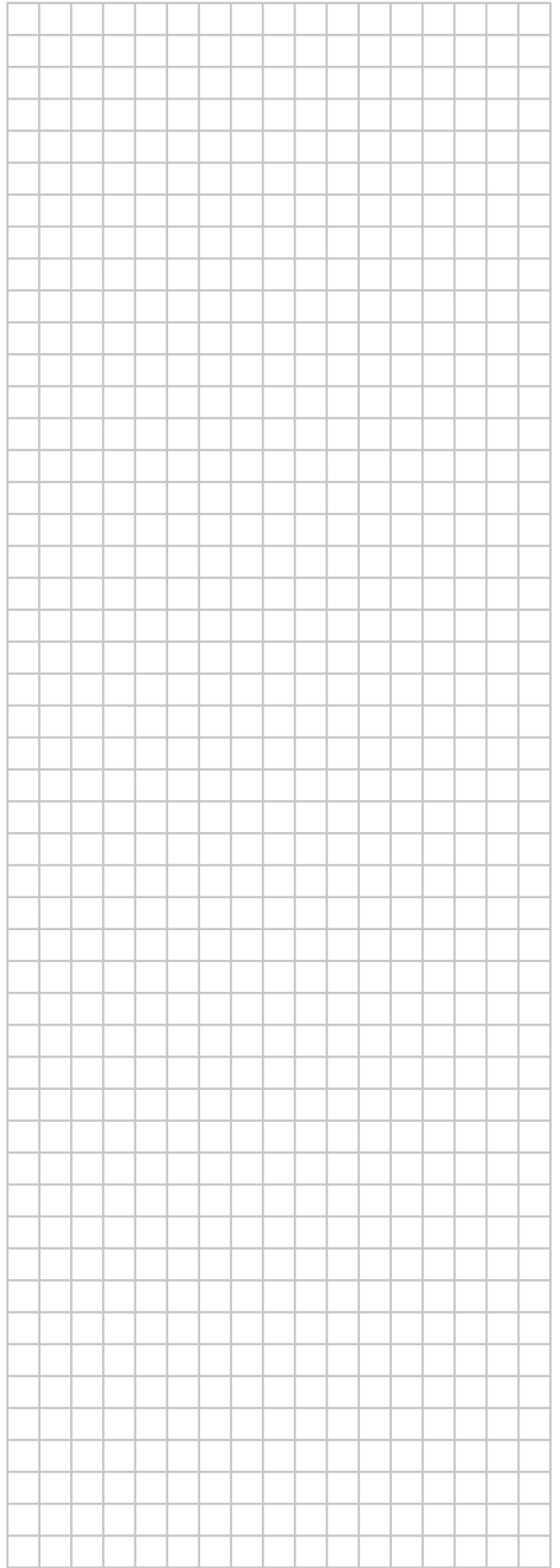

ERC

DAIKIN INDUSTRIES CZECH REPUBLIC s.r.o.
U Nové Hospody 1/1155, 301 00 Plzeň Skvrňany, Czech Republic

DAIKIN EUROPE N.V.
Zandvoordestraat 300, B-8400 Oostende, Belgium

Copyright 2017 Daikin

4P480730-1 2017.04