



Installation and operation manual

Split system air conditioners



FCAHG71FVEB
FCAHG100FVEB
FCAHG125FVEB
FCAHG140FVEB

Installation and operation manual
Split system air conditioners

English

CE - DECLARATION OF CONFORMITY
 CE - KONFORMITÄTSSERKLÄRUNG
 CE - DICHLARAZIONE DI CONFORMITÀ
 CE - ДИКЛАРАЦИЯ СООТВЕТСТВИЯ
 CE - FORSKRÄNING OMSÄMNING
 CE - DECLARACIÓN DE CONFORMIDAD
 CE - ДИХЛАРАЦИЈА СООТВЕТСТВИЈЕ
 CE - PROHLÁŠENÍ SOUHLADNOSTI
 CE - DECLARAȚIE DE CONFORMITATE

Daikin Industries Czech Republic s.r.o.

- 01 (en) declares under its sole responsibility that the air conditioning models to which this declaration relates
- 02 (en) erklärt auf seine alleinige Verantwortung, dass die Modelle der Klimaanlage für die diese Erklärung bestimmt ist:
- 03 (en) déclare sous sa seule responsabilité que les appareils d'air conditionné visés par la présente déclaration:
- 04 (en) vedkär för det egna exklusiva ansvar för att de airconditioning units värdar åzsa verktyg beträffande följt:
- 05 (en) declara bajo su única responsabilidad que los modelos de aire acondicionado a los cuales hace referencia la declaración:
- 06 (en) δηλώνει υπό την αποκλειστική ευθύνη του υπό τον τίτλο «Κυριότητα» του ονόματός του παρόντος δήλωσης:
- 07 (en) déclare sous sa seule responsabilité que les modèles de air conditionné à que essa déclaration se relate

CE - ERKLÄRUNG OMSÄMNING
 CE - KONFORMITÄTSSERKLÄRUNG
 CE - DICHLARAZIONE DI CONFORMITÀ
 CE - ДИКЛАРАЦИЯ СООТВЕТСТВИЯ
 CE - FORSKRÄNING OMSÄMNING
 CE - DECLARACIÓN DE CONFORMIDAD
 CE - ДИХЛАРАЦИЈА СООТВЕТСТВИЈЕ
 CE - PROHLÁŠENÍ SOUHLADNOSTI
 CE - DECLARAȚIE DE CONFORMITATE

- 09 (en) заявляет, исключительно под свою ответственность, что модели кондиционеров воздуха, к которым относится настоящее заявление:
- 10 (en) erklærer under eneansvar, at klimaanlægsmødelerne, som denne erklæring vedrører:
- 11 (en) déclare sur sa seule responsabilité que les modèles de climatiseurs à laquelle cette déclaration se rapporte:
- 12 (en) vedkär för det egna exklusiva ansvar för att de luftkonditioneringsmodellerna som berörs av denna erklæring innebär att:
- 13 (en) ilmoittaa yksinomaan omalla vastuullaan, että tähän ilmoituksen kohteena olleita ilmastointilaitteita mallit:
- 14 (en) prohlásuje ve své plné odpovědnosti, že modely klimatizací, k nimž se tato prohlášení vztahuje:
- 15 (en) izjavlja pod svojimi izključnimi odgovornostmi da su modeli klima uređaja na koje se ova izjava odnosi:
- 16 (en) teğis fe'aliyetşegge ihtarlamalıyımen, toğy a klimatizer modelerine bu deklaratsiyanı beren aher:

CE - ZJAVNA OSKLADNOSTI
 CE - VASTAVISEKILARAZIONE
 CE - ДЕКЛАРАЦІЯ СООТВЕТСТВИЯ
 CE - YUJUNLUK BEYANI
 CE - ZJAVNA OSKLADNOSTI
 CE - VASTAVISEKILARAZIONE
 CE - ДЕКЛАРАЦІЯ СООТВЕТСТВИЯ
 CE - YUJUNLUK BEYANI

- 17 (en) deklarije na vlastiti odgovornosti, da modely klimatizatorov, ktorých dotyczą niniejsza deklaracja:
- 18 (en) deklari på egen ansvar, att klimatisermodellerna, till vilka denna deklaras avser, är av följande beskaffenhet:
- 19 (en) deklarije na vlastiti odgovornosti, da modeli klimatizacijskih naprava, na koje se ova izjava odnosi, su sledećeg tipa:
- 20 (en) kinnabä om ägarna åsvar, att klimatisermodellerna eller klimatisermodellerna som berörs av denna deklaras innebär att:
- 21 (en) deklarije na svoji odgovornosti, da modeli klimatizacijskih naprava, na koje se ova izjava odnosi, su sledećeg tipa:
- 22 (en) vyhlásí svou odpovědností, že modely klimatizátorů, kterých se tato prohlášení týká, jsou následujícího typu:
- 23 (en) izjavlja pod svojim izključnim odgovornostmi, da modeli klima uređaja, na koje se ova izjava odnosi, su sledećeg tipa:
- 24 (en) yazarın kendi sorumluluğunda omark üzere bu bildiriimi ilgili oduğy klima modellerini aşağıdaki gibı öđüđümü beyen aher:

FCAHG71FVEB, FCAHG100FVEB, FCAHG125FVEB, FCAHG140FVEB,

- 01 are in conformity with the following standard(s) or other normative document(s), provided that these are used in accordance with our instructions:
- 02 (en) deklarije u skladu sa sledećim standardom ili drugim normativnim dokumentom, uz uvjet da se oni koriste u skladu s našim uputama:
- 03 (en) erklærer i henhold til følgende standard(er) eller andre normgivende dokument(er), under forudsætning at disse bruges i henhold til våre bruksinstruksjoner:
- 04 (en) deklarije u skladu sa sledećim standardom ili drugim normativnim dokumentom, uz uvjet da se oni koriste u skladu s našim uputama:
- 05 (en) erklærer i henhold til følgende standard(er) eller andre normgivende dokument(er), under forudsætning at disse bruges i henhold til våre bruksinstruksjoner:
- 06 (en) deklarije u skladu sa sledećim standardom ili drugim normativnim dokumentom, uz uvjet da se oni koriste u skladu s našim uputama:
- 07 (en) izjavlja u skladu sa sledećim standardom ili drugim normativnim dokumentom, uz uvjet da se oni koriste u skladu s našim uputama:
- 08 (en) deklarije u skladu sa sledećim standardom ili drugim normativnim dokumentom, uz uvjet da se oni koriste u skladu s našim uputama:
- 09 (en) deklarije u skladu sa sledećim standardom ili drugim normativnim dokumentom, uz uvjet da se oni koriste u skladu s našim uputama:
- 10 (en) deklarije u skladu sa sledećim standardom ili drugim normativnim dokumentom, uz uvjet da se oni koriste u skladu s našim uputama:
- 11 (en) deklarije u skladu sa sledećim standardom ili drugim normativnim dokumentom, uz uvjet da se oni koriste u skladu s našim uputama:
- 12 (en) deklarije u skladu sa sledećim standardom ili drugim normativnim dokumentom, uz uvjet da se oni koriste u skladu s našim uputama:
- 13 (en) deklarije u skladu sa sledećim standardom ili drugim normativnim dokumentom, uz uvjet da se oni koriste u skladu s našim uputama:
- 14 (en) deklarije u skladu sa sledećim standardom ili drugim normativnim dokumentom, uz uvjet da se oni koriste u skladu s našim uputama:
- 15 (en) deklarije u skladu sa sledećim standardom ili drugim normativnim dokumentom, uz uvjet da se oni koriste u skladu s našim uputama:
- 16 (en) deklarije u skladu sa sledećim standardom ili drugim normativnim dokumentom, uz uvjet da se oni koriste u skladu s našim uputama:
- 17 (en) deklarije u skladu sa sledećim standardom ili drugim normativnim dokumentom, uz uvjet da se oni koriste u skladu s našim uputama:
- 18 (en) deklarije u skladu sa sledećim standardom ili drugim normativnim dokumentom, uz uvjet da se oni koriste u skladu s našim uputama:
- 19 (en) deklarije u skladu sa sledećim standardom ili drugim normativnim dokumentom, uz uvjet da se oni koriste u skladu s našim uputama:
- 20 (en) deklarije u skladu sa sledećim standardom ili drugim normativnim dokumentom, uz uvjet da se oni koriste u skladu s našim uputama:
- 21 (en) deklarije u skladu sa sledećim standardom ili drugim normativnim dokumentom, uz uvjet da se oni koriste u skladu s našim uputama:
- 22 (en) deklarije u skladu sa sledećim standardom ili drugim normativnim dokumentom, uz uvjet da se oni koriste u skladu s našim uputama:
- 23 (en) deklarije u skladu sa sledećim standardom ili drugim normativnim dokumentom, uz uvjet da se oni koriste u skladu s našim uputama:
- 24 (en) deklarije u skladu sa sledećim standardom ili drugim normativnim dokumentom, uz uvjet da se oni koriste u skladu s našim uputama:
- 25 (en) deklarije u skladu sa sledećim standardom ili drugim normativnim dokumentom, uz uvjet da se oni koriste u skladu s našim uputama:

- 16 (en) deklarije u skladu sa sledećim standardom ili drugim normativnim dokumentom, uz uvjet da se oni koriste u skladu s našim uputama:
- 17 (en) deklarije u skladu sa sledećim standardom ili drugim normativnim dokumentom, uz uvjet da se oni koriste u skladu s našim uputama:
- 18 (en) deklarije u skladu sa sledećim standardom ili drugim normativnim dokumentom, uz uvjet da se oni koriste u skladu s našim uputama:
- 19 (en) deklarije u skladu sa sledećim standardom ili drugim normativnim dokumentom, uz uvjet da se oni koriste u skladu s našim uputama:
- 20 (en) deklarije u skladu sa sledećim standardom ili drugim normativnim dokumentom, uz uvjet da se oni koriste u skladu s našim uputama:
- 21 (en) deklarije u skladu sa sledećim standardom ili drugim normativnim dokumentom, uz uvjet da se oni koriste u skladu s našim uputama:
- 22 (en) deklarije u skladu sa sledećim standardom ili drugim normativnim dokumentom, uz uvjet da se oni koriste u skladu s našim uputama:
- 23 (en) deklarije u skladu sa sledećim standardom ili drugim normativnim dokumentom, uz uvjet da se oni koriste u skladu s našim uputama:
- 24 (en) deklarije u skladu sa sledećim standardom ili drugim normativnim dokumentom, uz uvjet da se oni koriste u skladu s našim uputama:
- 25 (en) deklarije u skladu sa sledećim standardom ili drugim normativnim dokumentom, uz uvjet da se oni koriste u skladu s našim uputama:

EN60335-2-40,

- 01 (en) deklarije u skladu sa sledećim standardom ili drugim normativnim dokumentom, uz uvjet da se oni koriste u skladu s našim uputama:
- 02 (en) deklarije u skladu sa sledećim standardom ili drugim normativnim dokumentom, uz uvjet da se oni koriste u skladu s našim uputama:
- 03 (en) deklarije u skladu sa sledećim standardom ili drugim normativnim dokumentom, uz uvjet da se oni koriste u skladu s našim uputama:
- 04 (en) deklarije u skladu sa sledećim standardom ili drugim normativnim dokumentom, uz uvjet da se oni koriste u skladu s našim uputama:
- 05 (en) deklarije u skladu sa sledećim standardom ili drugim normativnim dokumentom, uz uvjet da se oni koriste u skladu s našim uputama:
- 06 (en) deklarije u skladu sa sledećim standardom ili drugim normativnim dokumentom, uz uvjet da se oni koriste u skladu s našim uputama:
- 07 (en) deklarije u skladu sa sledećim standardom ili drugim normativnim dokumentom, uz uvjet da se oni koriste u skladu s našim uputama:
- 08 (en) deklarije u skladu sa sledećim standardom ili drugim normativnim dokumentom, uz uvjet da se oni koriste u skladu s našim uputama:
- 09 (en) deklarije u skladu sa sledećim standardom ili drugim normativnim dokumentom, uz uvjet da se oni koriste u skladu s našim uputama:
- 10 (en) deklarije u skladu sa sledećim standardom ili drugim normativnim dokumentom, uz uvjet da se oni koriste u skladu s našim uputama:
- 11 (en) deklarije u skladu sa sledećim standardom ili drugim normativnim dokumentom, uz uvjet da se oni koriste u skladu s našim uputama:
- 12 (en) deklarije u skladu sa sledećim standardom ili drugim normativnim dokumentom, uz uvjet da se oni koriste u skladu s našim uputama:
- 13 (en) deklarije u skladu sa sledećim standardom ili drugim normativnim dokumentom, uz uvjet da se oni koriste u skladu s našim uputama:
- 14 (en) deklarije u skladu sa sledećim standardom ili drugim normativnim dokumentom, uz uvjet da se oni koriste u skladu s našim uputama:
- 15 (en) deklarije u skladu sa sledećim standardom ili drugim normativnim dokumentom, uz uvjet da se oni koriste u skladu s našim uputama:
- 16 (en) deklarije u skladu sa sledećim standardom ili drugim normativnim dokumentom, uz uvjet da se oni koriste u skladu s našim uputama:
- 17 (en) deklarije u skladu sa sledećim standardom ili drugim normativnim dokumentom, uz uvjet da se oni koriste u skladu s našim uputama:
- 18 (en) deklarije u skladu sa sledećim standardom ili drugim normativnim dokumentom, uz uvjet da se oni koriste u skladu s našim uputama:
- 19 (en) deklarije u skladu sa sledećim standardom ili drugim normativnim dokumentom, uz uvjet da se oni koriste u skladu s našim uputama:
- 20 (en) deklarije u skladu sa sledećim standardom ili drugim normativnim dokumentom, uz uvjet da se oni koriste u skladu s našim uputama:
- 21 (en) deklarije u skladu sa sledećim standardom ili drugim normativnim dokumentom, uz uvjet da se oni koriste u skladu s našim uputama:
- 22 (en) deklarije u skladu sa sledećim standardom ili drugim normativnim dokumentom, uz uvjet da se oni koriste u skladu s našim uputama:
- 23 (en) deklarije u skladu sa sledećim standardom ili drugim normativnim dokumentom, uz uvjet da se oni koriste u skladu s našim uputama:
- 24 (en) deklarije u skladu sa sledećim standardom ili drugim normativnim dokumentom, uz uvjet da se oni koriste u skladu s našim uputama:
- 25 (en) deklarije u skladu sa sledećim standardom ili drugim normativnim dokumentom, uz uvjet da se oni koriste u skladu s našim uputama:

**Low Voltage 2014/35/EU
 Electromagnetic Compatibility 2014/30/EU
 Machinery 2006/42/EU**

- 01 (en) deklarije u skladu sa sledećim standardom ili drugim normativnim dokumentom, uz uvjet da se oni koriste u skladu s našim uputama:
- 02 (en) deklarije u skladu sa sledećim standardom ili drugim normativnim dokumentom, uz uvjet da se oni koriste u skladu s našim uputama:
- 03 (en) deklarije u skladu sa sledećim standardom ili drugim normativnim dokumentom, uz uvjet da se oni koriste u skladu s našim uputama:
- 04 (en) deklarije u skladu sa sledećim standardom ili drugim normativnim dokumentom, uz uvjet da se oni koriste u skladu s našim uputama:
- 05 (en) deklarije u skladu sa sledećim standardom ili drugim normativnim dokumentom, uz uvjet da se oni koriste u skladu s našim uputama:
- 06 (en) deklarije u skladu sa sledećim standardom ili drugim normativnim dokumentom, uz uvjet da se oni koriste u skladu s našim uputama:
- 07 (en) deklarije u skladu sa sledećim standardom ili drugim normativnim dokumentom, uz uvjet da se oni koriste u skladu s našim uputama:
- 08 (en) deklarije u skladu sa sledećim standardom ili drugim normativnim dokumentom, uz uvjet da se oni koriste u skladu s našim uputama:
- 09 (en) deklarije u skladu sa sledećim standardom ili drugim normativnim dokumentom, uz uvjet da se oni koriste u skladu s našim uputama:
- 10 (en) deklarije u skladu sa sledećim standardom ili drugim normativnim dokumentom, uz uvjet da se oni koriste u skladu s našim uputama:
- 11 (en) deklarije u skladu sa sledećim standardom ili drugim normativnim dokumentom, uz uvjet da se oni koriste u skladu s našim uputama:
- 12 (en) deklarije u skladu sa sledećim standardom ili drugim normativnim dokumentom, uz uvjet da se oni koriste u skladu s našim uputama:
- 13 (en) deklarije u skladu sa sledećim standardom ili drugim normativnim dokumentom, uz uvjet da se oni koriste u skladu s našim uputama:
- 14 (en) deklarije u skladu sa sledećim standardom ili drugim normativnim dokumentom, uz uvjet da se oni koriste u skladu s našim uputama:
- 15 (en) deklarije u skladu sa sledećim standardom ili drugim normativnim dokumentom, uz uvjet da se oni koriste u skladu s našim uputama:
- 16 (en) deklarije u skladu sa sledećim standardom ili drugim normativnim dokumentom, uz uvjet da se oni koriste u skladu s našim uputama:
- 17 (en) deklarije u skladu sa sledećim standardom ili drugim normativnim dokumentom, uz uvjet da se oni koriste u skladu s našim uputama:
- 18 (en) deklarije u skladu sa sledećim standardom ili drugim normativnim dokumentom, uz uvjet da se oni koriste u skladu s našim uputama:
- 19 (en) deklarije u skladu sa sledećim standardom ili drugim normativnim dokumentom, uz uvjet da se oni koriste u skladu s našim uputama:
- 20 (en) deklarije u skladu sa sledećim standardom ili drugim normativnim dokumentom, uz uvjet da se oni koriste u skladu s našim uputama:
- 21 (en) deklarije u skladu sa sledećim standardom ili drugim normativnim dokumentom, uz uvjet da se oni koriste u skladu s našim uputama:
- 22 (en) deklarije u skladu sa sledećim standardom ili drugim normativnim dokumentom, uz uvjet da se oni koriste u skladu s našim uputama:
- 23 (en) deklarije u skladu sa sledećim standardom ili drugim normativnim dokumentom, uz uvjet da se oni koriste u skladu s našim uputama:
- 24 (en) deklarije u skladu sa sledećim standardom ili drugim normativnim dokumentom, uz uvjet da se oni koriste u skladu s našim uputama:
- 25 (en) deklarije u skladu sa sledećim standardom ili drugim normativnim dokumentom, uz uvjet da se oni koriste u skladu s našim uputama:

- 01 (en) deklarije u skladu sa sledećim standardom ili drugim normativnim dokumentom, uz uvjet da se oni koriste u skladu s našim uputama:
- 02 (en) deklarije u skladu sa sledećim standardom ili drugim normativnim dokumentom, uz uvjet da se oni koriste u skladu s našim uputama:
- 03 (en) deklarije u skladu sa sledećim standardom ili drugim normativnim dokumentom, uz uvjet da se oni koriste u skladu s našim uputama:
- 04 (en) deklarije u skladu sa sledećim standardom ili drugim normativnim dokumentom, uz uvjet da se oni koriste u skladu s našim uputama:
- 05 (en) deklarije u skladu sa sledećim standardom ili drugim normativnim dokumentom, uz uvjet da se oni koriste u skladu s našim uputama:
- 06 (en) deklarije u skladu sa sledećim standardom ili drugim normativnim dokumentom, uz uvjet da se oni koriste u skladu s našim uputama:
- 07 (en) deklarije u skladu sa sledećim standardom ili drugim normativnim dokumentom, uz uvjet da se oni koriste u skladu s našim uputama:
- 08 (en) deklarije u skladu sa sledećim standardom ili drugim normativnim dokumentom, uz uvjet da se oni koriste u skladu s našim uputama:
- 09 (en) deklarije u skladu sa sledećim standardom ili drugim normativnim dokumentom, uz uvjet da se oni koriste u skladu s našim uputama:
- 10 (en) deklarije u skladu sa sledećim standardom ili drugim normativnim dokumentom, uz uvjet da se oni koriste u skladu s našim uputama:
- 11 (en) deklarije u skladu sa sledećim standardom ili drugim normativnim dokumentom, uz uvjet da se oni koriste u skladu s našim uputama:
- 12 (en) deklarije u skladu sa sledećim standardom ili drugim normativnim dokumentom, uz uvjet da se oni koriste u skladu s našim uputama:
- 13 (en) deklarije u skladu sa sledećim standardom ili drugim normativnim dokumentom, uz uvjet da se oni koriste u skladu s našim uputama:
- 14 (en) deklarije u skladu sa sledećim standardom ili drugim normativnim dokumentom, uz uvjet da se oni koriste u skladu s našim uputama:
- 15 (en) deklarije u skladu sa sledećim standardom ili drugim normativnim dokumentom, uz uvjet da se oni koriste u skladu s našim uputama:
- 16 (en) deklarije u skladu sa sledećim standardom ili drugim normativnim dokumentom, uz uvjet da se oni koriste u skladu s našim uputama:
- 17 (en) deklarije u skladu sa sledećim standardom ili drugim normativnim dokumentom, uz uvjet da se oni koriste u skladu s našim uputama:
- 18 (en) deklarije u skladu sa sledećim standardom ili drugim normativnim dokumentom, uz uvjet da se oni koriste u skladu s našim uputama:
- 19 (en) deklarije u skladu sa sledećim standardom ili drugim normativnim dokumentom, uz uvjet da se oni koriste u skladu s našim uputama:
- 20 (en) deklarije u skladu sa sledećim standardom ili drugim normativnim dokumentom, uz uvjet da se oni koriste u skladu s našim uputama:
- 21 (en) deklarije u skladu sa sledećim standardom ili drugim normativnim dokumentom, uz uvjet da se oni koriste u skladu s našim uputama:
- 22 (en) deklarije u skladu sa sledećim standardom ili drugim normativnim dokumentom, uz uvjet da se oni koriste u skladu s našim uputama:
- 23 (en) deklarije u skladu sa sledećim standardom ili drugim normativnim dokumentom, uz uvjet da se oni koriste u skladu s našim uputama:
- 24 (en) deklarije u skladu sa sledećim standardom ili drugim normativnim dokumentom, uz uvjet da se oni koriste u skladu s našim uputama:
- 25 (en) deklarije u skladu sa sledećim standardom ili drugim normativnim dokumentom, uz uvjet da se oni koriste u skladu s našim uputama:

- 01 Note* as set out in and judged positively by
- 02 Hinweis* wie in angegeben und von positiv beurteilt gemäß
- 03 Remarque* tel que défini dans et évalué positivement par
- 04 Bemerk* zoals vermeld in en positief beoordeeld door
- 05 Nota* como se establece en y es valorado positivamente por
- 06 Nota* as set out in and judged positively by
- 07 Zjeňování* jak je definováno v a bylo pozitivně zhodnoceno
- 08 Poznamka* kao što je određeno u i pozitivno je izloženo
- 09 Napomena* kako je izloženo u i pozitivno je ocijenjeno od strane
- 10 Bemerk* som antwortet på og positivt vurderet af

- 11 Informator* enigi och godkännt av enligt Certifikat
- 12 Merk* som det framgår i och godkännt av enligt Certifikat
- 13 Huom* jolla on esitetty ja sen on päätetty positiivisesti
- 14 Poznámka* jak bylo uvedeno v a pozitivně zhodnoceno
- 15 Napomena* kako je izloženo u i pozitivno je ocijenjeno od strane
- 16 Megjegyzés* az alapján az igazolta a megfigyelés, az tanúsítvány szerint
- 17 Uvešt* zgodno z dokumentaciją pozytywnie oceniono
- 18 Nošt* jak je určeno v a pozitivně je zhodnoceno
- 19 Opomba* kot je opredeljeno v in odobreno s strani
- 20 Märkus* nagu on määratud dokumentis ja heaks kiidetud

- 21 Zabeleženka* izkazano je v skladu s in ocenjeno pozitivno od
- 22 Pastaba* kajniščiše i kaj bėigėrai nuslytėsa pagal Sertifikaatą
- 23 Píoznámek* ka noidnėti š puzitivnėm vėrtinėjumam s a sertifikatu
- 24 Poznámka* ako bolo uvedeno v a pozitivne zistené v svedčenií
- 25 Not* izjavljeno je v skladu s i pozitivno je ocijenjeno od strane

- 07** DIC*** è autorizzato a compilare il File Tecnico di Costruzione File.
- 08** DIC*** hat die Berechtigung die Technische Konstruktionsakte zusammenzustellen.
- 09** Constatul DIC*** este autorizat să compileze Fișul Tehnic de Construcție.
- 10** DIC*** es autorizado a compilar el Archivo de Construcción Técnica.
- 11** DIC*** är behörig att sammanställa den tekniska konstruktionsfilen.
- 12** DIC*** har tillstånd til å komplettere den Tekniske konstruktionsfilen.

- 13** DIC*** on valtuutettu laatimaan Teknisen asakirjan.
- 14** Společnost DIC*** má oprávnění ke kompilaci souboru technické konstrukce.
- 15** DIC*** je ovlašćen za izradu Datoteke o tehničkoj konstrukciji.
- 16** A DIC*** posuili su mitski konstitucijski dokumenti i oszvedéklésrá.
- 17** DIC*** má autorizáciu na zberanie i opracovávanie dokumentačnej konštrukčnej fily.
- 18** DIC*** este autorizat să completeze Dosarul tehnic de construcție.

- 19** DIC*** je pooblašćen za sestavo datoteka s tehničko mapo.
- 20** DIC*** on valtuutet kosmasta tehniksi dokumentaatsioni.
- 21** DIC*** je ovlašćen za izradu Datoteke o tehničkoj konstrukciji.
- 22** DIC*** je autorizats sastaviti tehničko dokumentačnu filu.
- 23** Společnost DIC*** je oprávněna vytvořit soubor technické konstrukce.
- 24** DIC*** Teknik Tapı Dosyasını derlenmeye yetkilidir.

***DIC = Daikin Industries Czech Republic s.r.o.



Tetsuya Baba
 Managing Director
 Pilsen, 1st of March 2016

DAIKIN INDUSTRIES CZECH REPUBLIC s.r.o.
 U Nové Hospody 1/155, 301 00 Plzeň Skvrňany,
 Czech Republic

Table of Contents

1 About the documentation	3	12.1.3 To clean the air outlet and outside panels	15
1.1 About this document.....	3	12.2 About the refrigerant.....	16
For the installer	4	12.3 After-sales service and warranty	16
2 About the box	4	12.3.1 Warranty period	16
2.1 Indoor unit	4	12.3.2 Recommended maintenance and inspection	16
2.1.1 To remove the accessories from the indoor unit.....	4	13 Troubleshooting	16
3 About the units and options	4	13.1 Symptoms that are not air conditioner troubles	17
3.1 About the indoor unit	4	13.1.1 Symptom: The system does not operate	17
3.2 System layout.....	4	13.1.2 Symptom: The fan strength does not correspond to the setting	17
4 Preparation	4	13.1.3 Symptom: The fan direction does not correspond to the setting	17
4.1 Preparing installation site	4	13.1.4 Symptom: White mist comes out of a unit (Indoor unit).....	17
4.1.1 Installation site requirements of the indoor unit	4	13.1.5 Symptom: White mist comes out of a unit (Indoor unit, outdoor unit).....	17
5 Installation	5	13.1.6 Symptom: The user interface display reads "U4" or "U5" and stops, but then restarts after a few minutes..	17
5.1 Mounting the indoor unit.....	5	13.1.7 Symptom: Noise of air conditioners (Indoor unit).....	17
5.1.1 Guidelines when installing the indoor unit.....	5	13.1.8 Symptom: Noise of air conditioners (Indoor unit, outdoor unit).....	17
5.1.2 Guidelines when installing the drain piping	6	13.1.9 Symptom: Noise of air conditioners (Outdoor unit).....	17
5.2 Connecting the refrigerant piping	7	13.1.10 Symptom: Dust comes out of the unit	17
5.2.1 To connect the refrigerant piping to the indoor unit ...	7	13.1.11 Symptom: The units can give off odours.....	17
5.3 Connecting the electrical wiring.....	8	13.1.12 Symptom: The outdoor unit fan does not spin	18
5.3.1 Guidelines when connecting the electrical wiring	8	13.1.13 Symptom: The display shows "88".....	18
5.3.2 Specifications of standard wiring components.....	8	13.1.14 Symptom: The compressor in the outdoor unit does not stop after a short heating operation	18
5.3.3 To connect the electrical wiring on the indoor unit.....	8	14 Relocation	18
6 Configuration	9	15 Disposal	18
6.1 Field settings	9	1 About the documentation	
7 Commissioning	10	1.1 About this document	
7.1 Checklist before commissioning	10	Target audience	
7.2 To perform a test run	10	Authorised installers + end users	
7.3 Error codes when performing a test run	11	INFORMATION	
8 Technical data	12	This appliance is intended to be used by expert or trained users in shops, in light industry and on farms, or for commercial use by lay persons.	
8.1 Piping diagram: Indoor unit	12	Documentation set	
8.2 Wiring diagram: Indoor unit	12	This document is part of a documentation set. The complete set consists of:	
For the user	13	▪ General safety precautions:	
9 About the system	13	▪ Safety instructions that you must read before installing	
9.1 System layout.....	13	▪ Format: Paper (in the box of the indoor unit)	
10 User interface	13	▪ Indoor unit installation and operation manual:	
11 Operation	13	▪ Installation and operation instructions	
11.1 Operation range	13	▪ Format: Paper (in the box of the indoor unit)	
11.2 Operating the system	13	▪ Installer and user reference guide:	
11.2.1 About operating the system	13	▪ Preparation of the installation, technical specifications, reference data,...	
11.2.2 About cooling, heating, fan only, and automatic operation	13	▪ Detailed step-by-step instructions and background information for basic and advanced usage	
11.2.3 About the heating operation.....	14	▪ Format: Digital files on http://www.daikineurope.com/support-and-manuals/product-information/	
11.2.4 To operate the system	14		
11.3 Using the dry program.....	14		
11.3.1 About the dry program	14		
11.3.2 To use the dry program.....	14		
11.4 Adjusting the air flow direction.....	14		
11.4.1 About the air flow flap	14		
12 Maintenance and service	14		
12.1 Cleaning the air filter, suction grille, air outlet and outside panels	15		
12.1.1 To clean the air filter	15		
12.1.2 To clean the suction grille	15		

2 About the box

- **Wiring instruction sheet**
 - Instructions on how to connect the optional sensor kit and decoration panels
 - Format: Paper (in the box of the indoor unit)

Latest revisions of the supplied documentation may be available on the regional Daikin website or via your dealer.

The original documentation is written in English. All other languages are translations.

For the installer

2 About the box

2.1 Indoor unit

2.1.1 To remove the accessories from the indoor unit

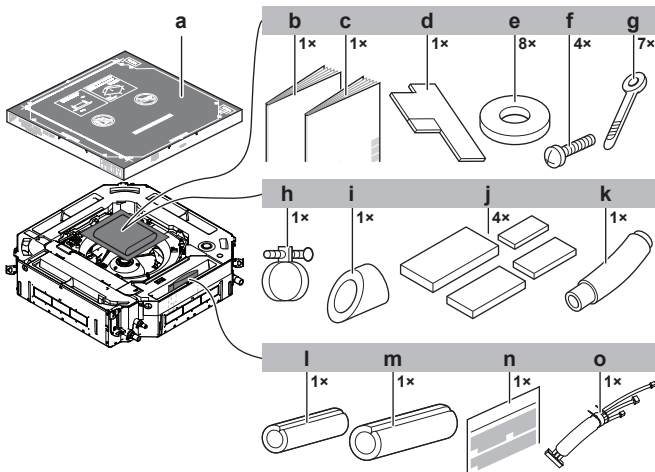

- a Paper pattern for installation (upper part of packing)
- b General safety precautions
- c Indoor unit installation and operation manual
- d Installation guide
- e Washers for hanger brackets
- f Screws (to temporarily attach the paper pattern for installation to the indoor unit)
- g Cable ties
- h Metal clamp
- i Insulation piece (drain pipe)
- j Sealing pads: Large (drain pipe), medium 1 (gas pipe), medium 2 (liquid pipe), small (electrical wiring)
- k Drain hose
- l Insulation piece: Small (liquid pipe)
- m Insulation piece: Large (gas pipe)
- n Wiring instruction sheet (for the connection of the optional sensor kit and decoration panels)
- o Wire harness for the self-cleaning decoration panel

- (a) To avoid condensation and water dripping out of the unit. If the temperature or the humidity is beyond these conditions, safety devices may be put in action and the air conditioner may not operate.

3.2 System layout



NOTICE

Design of the system must not be done at temperatures below -15°C .

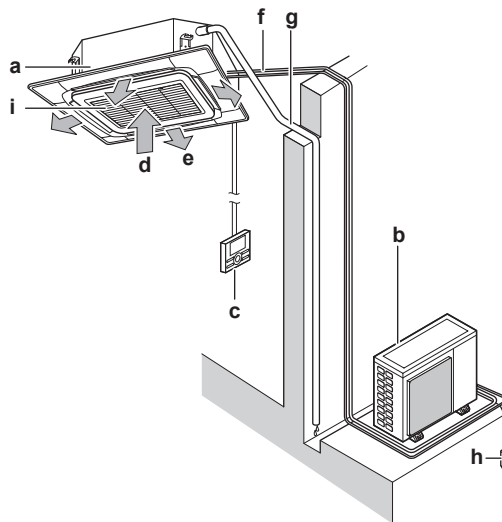

- a Indoor unit
- b Outdoor unit
- c User interface
- d Suction air
- e Discharge air
- f Refrigerant piping + interconnection cable
- g Drain pipe
- h Earth wiring
- i Suction grille and air filter

3 About the units and options

3.1 About the indoor unit

Use the system in the following temperature and humidity ranges for safe and effective operation.

	Cooling	Heating
Outdoor temperature	$-15\sim 50^{\circ}\text{C}$ DB	$-19\sim 21^{\circ}\text{C}$ DB $-20\sim 15.5^{\circ}\text{C}$ WB
Indoor temperature	$18\sim 35^{\circ}\text{C}$ DB $12\sim 28^{\circ}\text{C}$ WB	$10\sim 27^{\circ}\text{C}$ DB
Indoor humidity	$\leq 80\%$ ^(a)	

4 Preparation

4.1 Preparing installation site

4.1.1 Installation site requirements of the indoor unit



INFORMATION

The sound pressure level is less than 70 dBA.



CAUTION

Appliance not accessible to the general public, install it in a secured area, protected from easy access.

This unit, both indoor and outdoor, is suitable for installation in a commercial and light industrial environment.

- **Spacing.** Mind the following requirements:

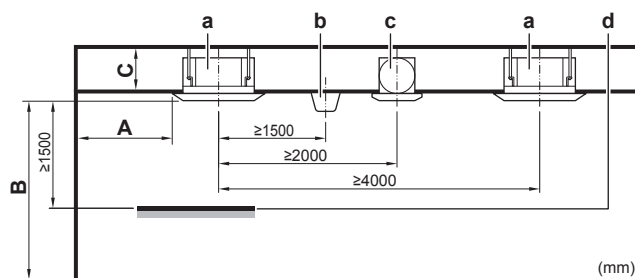

- A** Minimum distance to the wall (see below)
- B** Minimum and maximum distance to the floor (see below)
- C** **≥298 mm**: In case of installation with standard decoration panel
≥348 mm: In case of installation with fresh air intake kit
≥378 mm: In case of installation with self-cleaning decoration panel
- a** Indoor unit
- b** Lighting (the figure shows ceiling-mounted lighting, but recessed lighting is also allowed)
- c** Air fan
- d** Static volume (example: table)

- **A: Minimum distance to the wall.** Depends on the air flow directions towards the wall.

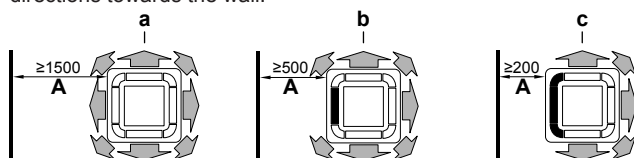

- a** Air outlet and corners open
- b** Air outlet closed, corners open (optional blocking pad kit required)
- c** Air outlet and corners closed (optional blocking pad kit required)

- **B: Minimum and maximum distance to the floor:**

- Minimum: 2.5 m to avoid accidental touching.
- Maximum: Depends on the air flow directions and the capacity class. Also make sure the "Ceiling height" field setting corresponds with the actual situation. See "6.1 Field settings" on page 9.

If air flow direction...	Then B	
	FCAHG71	FCAHG100~140
All-round	≤3.5 m	≤4.2 m
4-way ^(a)	≤4.0 m	≤4.5 m
3-way ^(a)	≤3.5 m	≤4.2 m

(a) Optional blocking kit required

5 Installation

5.1 Mounting the indoor unit

5.1.1 Guidelines when installing the indoor unit



INFORMATION

Optional equipment. When installing optional equipment, also read the installation manual of the optional equipment. Depending on the field conditions, it might be easier to install the optional equipment first.

- **In case of installation with a fresh air intake kit.** Install the fresh air intake kit always **before** installing the unit.
- **Decoration panel.** Install the decoration panel always **after** installing the unit.

- **Ceiling strength.** Check whether the ceiling is strong enough to support the weight of the unit. If there is a risk, reinforce the ceiling before installing the unit.

- For existing ceilings, use anchors.

- For new ceilings, use sunken inserts, sunken anchors or other field supplied parts.

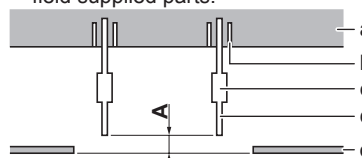

- A** **50~100 mm**: In case of installation with standard panel
100~150 mm: In case of installation with fresh air intake kit
130~180 mm: In case of installation with self-cleaning decoration panel
- a** Ceiling slab
- b** Anchor
- c** Long nut or turnbuckle
- d** Suspension bolt
- e** Suspended ceiling

- **Suspension bolts.** Use M8~M10 suspension bolts for installation. Attach the hanger bracket to the suspension bolt. Fix it securely by using a nut and washer from the upper and lower sides of the hanger bracket.

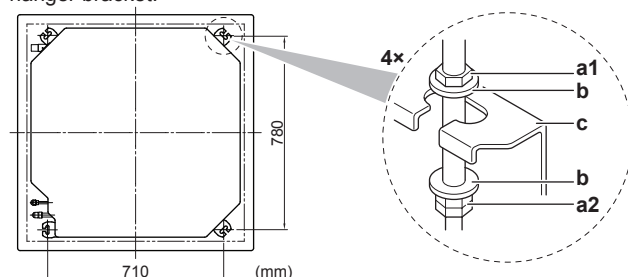

- a1** Nut (field supply)
- a2** Double nut (field supply)
- b** Washer (accessories)
- c** Hanger bracket (attached to the unit)

- **Paper pattern for installation** (upper part of the packing). Use the paper pattern to determine the correct horizontal positioning. It contains the necessary dimensions and centres. You can attach the paper pattern to the unit.

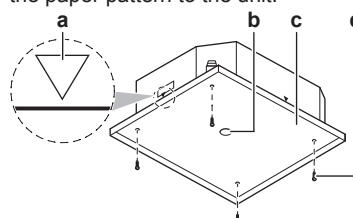

- a** Centre of the unit
- b** Centre of the ceiling opening
- c** Paper pattern for installation (upper part of the packing)
- d** Screws (accessories)

- **Ceiling opening and unit:**

- Make sure the ceiling opening is within its limits:

Minimum: 860 mm to be able to fit the unit.

Maximum: 910 mm to ensure enough overlapping between the decoration panel and the suspended ceiling. If the ceiling opening is bigger, add extra ceiling material.

- Make sure the unit and its hanger brackets (suspension) are centred within the ceiling opening.

5 Installation

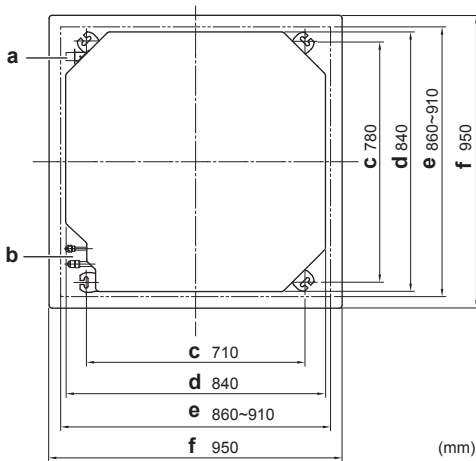

- a Drain piping
- b Refrigerant piping
- c Hanger bracket pitch (suspension)
- d Unit
- e Ceiling opening
- f Decoration panel

	If A	Then	
		B	C
	860 mm (= min.)	20 mm	35 mm
	910 mm (= max.)	35 mm	20 mm

- A Ceiling opening
- B Distance between the unit and the ceiling opening
- C Overlapping between the decoration panel and the suspended ceiling

- **Installation guide.** Use the installation guide to determine the correct vertical position.

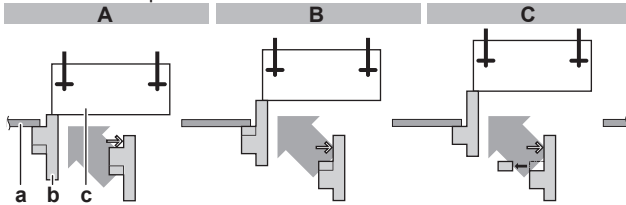

- A In case of installation with standard decoration panel
- B In case of installation with fresh air intake kit
- C In case of installation with self-cleaning decoration panel
- a Suspended ceiling
- b Installation guide (accessory)
- c Unit

- **Level.** Make sure the unit is level at all four corners using a level or a water-filled vinyl tube.

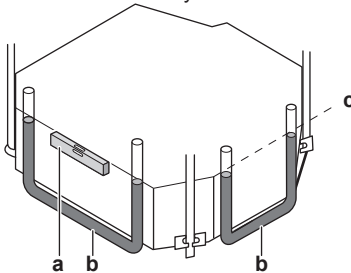

- a Level
- b Vinyl tube
- c Water level



NOTICE

Do NOT install the unit tilted. **Possible consequence:** If the unit is tilted against the direction of the condensate flow (the drain piping side is raised), the float switch might malfunction and cause water to drip.

5.1.2 Guidelines when installing the drain piping

Make sure condensation water can be evacuated properly. This involves:

- General guidelines
- Connecting the drain piping to the indoor unit
- Checking for water leaks

General guidelines

- **Pipe length.** Keep drain piping as short as possible.
- **Pipe size.** Keep the pipe size equal to or greater than that of the connecting pipe (vinyl pipe of 25 mm nominal diameter and 32 mm outer diameter).
- **Slope.** Make sure the drain piping slopes down (at least 1/100) to prevent air from being trapped in the piping. Use hanging bars as shown.

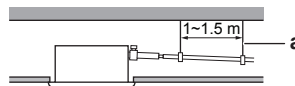

- a Hanging bar
- O Allowed
- X Not allowed

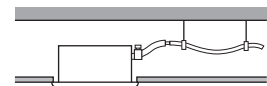

- **Rising piping.** If necessary to make the slope possible, you can install rising piping.

- Drain hose inclination: 0~75 mm to avoid stress on the piping and to avoid air bubbles.
- Rising piping: ≤300 mm from the unit, ≤675 mm perpendicular to the unit.

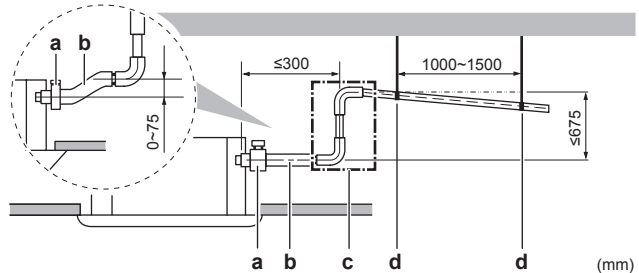

- a Metal clamp (accessory)
- b Drain hose (accessory)
- c Rising drain piping (vinyl pipe of 25 mm nominal diameter and 32 mm outer diameter) (field supply)
- d Hanging bars (field supply)

- **Condensation.** Take measures against condensation. Insulate the complete drain piping in the building.

- **Combining drain pipes.** You can combine drain pipes. Make sure to use drain pipes and T-joints with a correct gauge for the operating capacity of the units.

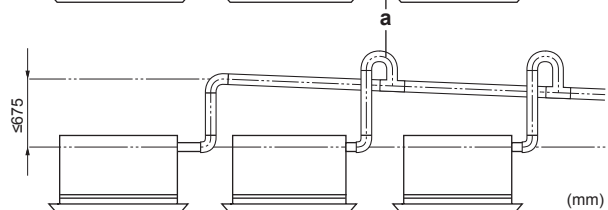
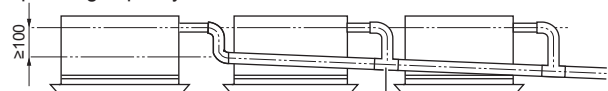

- a T-joint

To connect the drain piping to the indoor unit

NOTICE

Incorrect connection of the drain hose might cause leaks, and damage the installation space and surroundings.

- 1 Push the drain hose as far as possible over the drain pipe connection.
- 2 Tighten the metal clamp until the screw head is less than 4 mm from the metal clamp part.
- 3 Check for water leaks (see ["To check for water leaks" on page 7](#)).
- 4 Install the insulation piece (drain pipe).
- 5 Wind the large sealing pad (= insulation) around the metal clamp and drain hose, and fix it with cable ties.
- 6 Connect the drain piping to the drain hose.

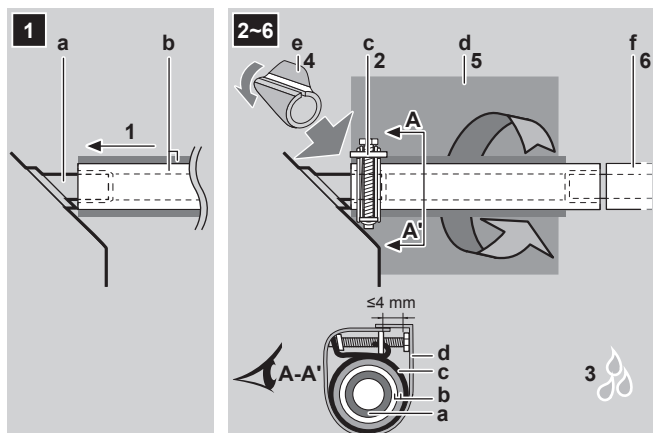

- a Drain pipe connection (attached to the unit)
- b Drain hose (accessory)
- c Metal clamp (accessory)
- d Large sealing pad (accessory)
- e Insulation piece (drain pipe) (accessory)
- f Drain piping (field supply)

To check for water leaks

The procedure differs depending on whether electrical wiring is already finished. When electrical wiring is not finished yet, you need to temporarily connect the user interface and power supply to the unit.

When electrical wiring is not finished yet

- 1 Temporarily connect electrical wiring.
 - Remove the switch box cover (a).
 - Connect the user interface (b).
 - Connect the power supply (1~ 220-240 V 50/60 Hz) and earth (c).
 - Reattach the switch box cover (a).

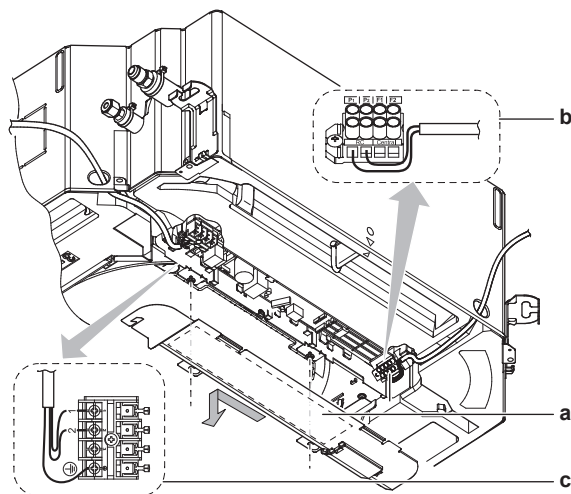

- 2 Turn ON the power.
- 3 Start cooling operation (see ["7.2 To perform a test run" on page 10](#)).
- 4 Gradually put approximately 1 l of water through the air discharge outlet, and check for leaks.

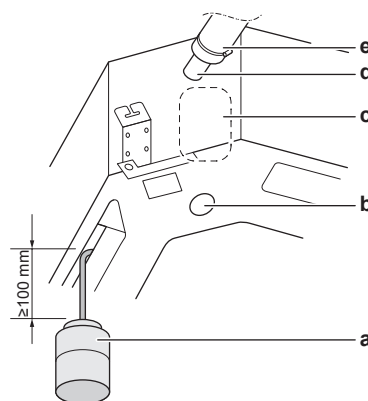

- a Plastic watering can
- b Service drain outlet (with rubber plug). Use this outlet to drain water from the drain pan.
- c Drain pump location
- d Drain pipe connection
- e Drain pipe

- 5 Turn OFF the power.
- 6 Disconnect the electrical wiring.
 - Remove the switch box cover.
 - Disconnect the power supply and earth.
 - Disconnect the user interface.
 - Reattach the switch box cover.

When electrical wiring is finished already

- 1 Start cooling operation (see ["7.2 To perform a test run" on page 10](#)).
- 2 Gradually put approximately 1 l of water through the air discharge outlet, and check for leaks (see ["When electrical wiring is not finished yet" on page 7](#)).

5.2 Connecting the refrigerant piping



DANGER: RISK OF BURNING

5.2.1 To connect the refrigerant piping to the indoor unit

- **Pipe length.** Keep refrigerant piping as short as possible.

5 Installation

- **Flare connections.** Connect refrigerant piping to the unit using flare connections.
- **Insulation.** Insulate the refrigerant piping on the indoor unit as follows:

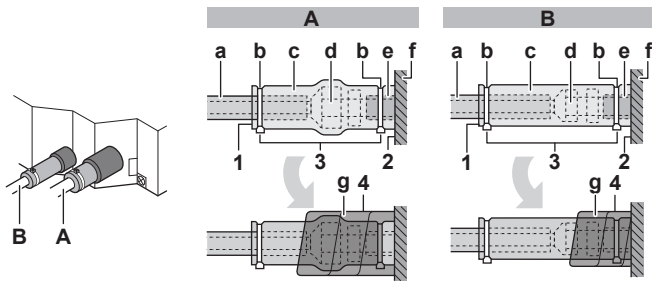

- A** Gas piping
B Liquid piping
- a** Insulation material (field supply)
b Cable tie (accessory)
c Insulation pieces: Large (gas pipe), small (liquid pipe) (accessories)
d Flare nut (attached to the unit)
e Refrigerant pipe connection (attached to the unit)
f Unit
g Sealing pads: Medium 1 (gas pipe), medium 2 (liquid pipe) (accessories)
- 1 Turn up the seams of the insulation pieces.
 - 2 Attach to the base of the unit.
 - 3 Tighten the cable ties on the insulation pieces.
 - 4 Wrap the sealing pad from the base of the unit to the top of the flare nut.

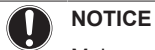

NOTICE

Make sure to insulate all refrigerant piping. Any exposed piping might cause condensation.

5.3 Connecting the electrical wiring



DANGER: RISK OF ELECTROCUTION



WARNING

ALWAYS use multicore cable for power supply cables.

5.3.1 Guidelines when connecting the electrical wiring

Tightening torques

Wiring	Screw size	Tightening torque (N·m)
Interconnection cable (indoor↔outdoor)	M4	1.18~1.44
User interface cable	M3.5	0.79~0.97

5.3.2 Specifications of standard wiring components

Component	Specification
Interconnection cable (indoor↔outdoor)	Minimum cable section of 2.5 mm ² and applicable for 230 V
User interface cable	Vinyl cords with 0.75 to 1.25 mm ² sheath or cables (2-core wires) Maximum 500 m

5.3.3 To connect the electrical wiring on the indoor unit



NOTICE

- Follow the wiring diagram (delivered with the unit, located at the inside of the service cover).
- For instructions on how to connect the decoration panel and the sensor kit, see the wiring instruction sheet (delivered with the unit, inside the accessory bag).
- Make sure the electrical wiring does NOT obstruct proper reattachment of the service cover.

It is important to keep the power supply and the transmission wiring separated from each other. In order to avoid any electrical interference the distance between both wiring should always be at least 50 mm.



NOTICE

Be sure to keep the power line and transmission line apart from each other. Transmission wiring and power supply wiring may cross, but may not run parallel.

- 1 Remove the service cover.
- 2 **User interface cable:** Route the cable through the frame, connect the cable to the terminal block, and fix the cable with a cable tie.
- 3 **Interconnection cable (indoor↔outdoor):** Route the cable through the frame, connect the cable to the terminal block (make sure the numbers match with the numbers on the outdoor unit, and connect the earth wire), and fix the cable with a cable tie.
- 4 Divide the small sealing (accessory) and wrap them around the cables to prevent water from entering the unit. Seal all gaps to prevent small animals from entering the system.



WARNING

Provide adequate measures to prevent that the unit can be used as a shelter by small animals. Small animals that make contact with electrical parts can cause malfunctions, smoke or fire.

- 5 Reattach the service cover.

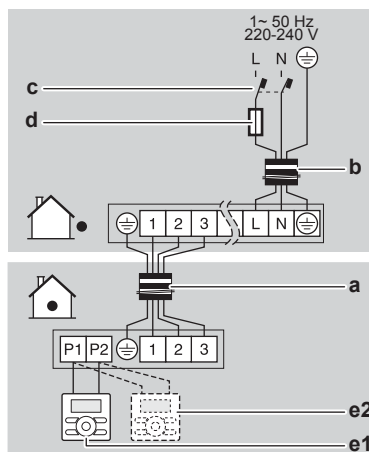

- a** Interconnection cable
b Power supply cable
c Earth leakage circuit breaker
d Fuse
e1 Main user interface
e2 Optional user interface

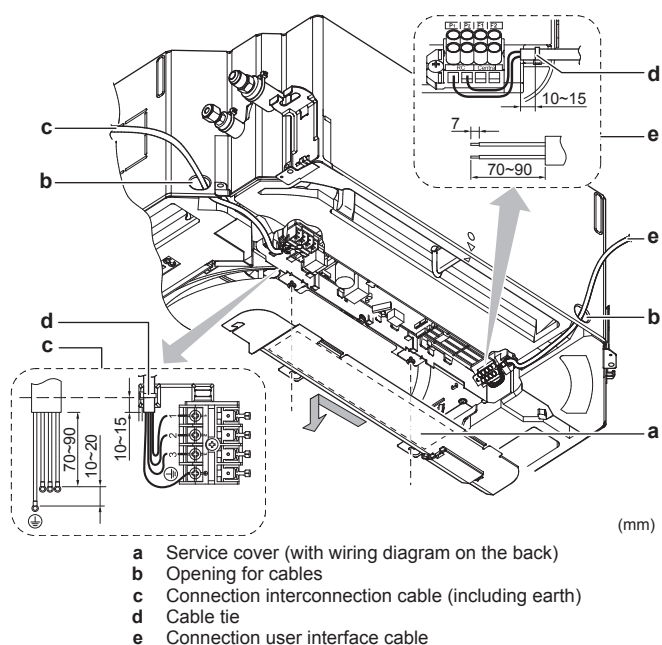

6 Configuration

6.1 Field settings

Make the following field settings so that they correspond with the actual installation setup and with the needs of the user:

- Ceiling height
- Air flow direction
- Air volume when thermostat control is OFF
- Time to clean air filter

Setting: Ceiling height

This setting must correspond with the actual distance to the floor, capacity class and air flow directions.

- For 3-way and 4-way air flows (which require an optional blocking pad kit), see the installation manual of the optional blocking pad kit.
- For all-round air flow, use the table below.

If the distance to the floor is (m)		Then ¹		
FCAHG71	FCAHG100~140	M	C1	C2
≤2.7	≤3.2	13 (23)	0	01
2.7<x≤3.0	3.2<x≤3.6			02
3.0<x≤3.5	3.6<x≤4.2			03

Setting: Air flow direction

This setting must correspond with the actual used air flow directions. See the installation manual of the optional blocking pad kit, and the manual of the user interface.

Default: 01 (= all-round air flow)

Example:

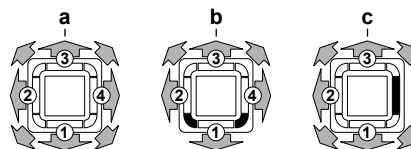

- a All-round air flow
- b 4-way air flow (all air outlets open, 2 corners closed) (optional blocking pad kit required)
- c 3-way air flow (1 air outlet closed, all corners open) (optional blocking pad kit required)

Setting: Air volume when thermostat control is OFF

This setting must correspond with the needs of the user. It determines the fan speed of the indoor unit during thermostat OFF condition.

- 1 Set how the fan has to operate during thermostat OFF condition:

If the fan has to...	Then ¹		
	M	C1	C2
Operate as normal (= according to settings in step 2)	11 (21)	2	01
Stop operation (Possible consequence: Warm air will go up, and cold air will go down. During heating operation, this might prevent the room thermistor from going to thermostat ON, and the user might experience cold feet.)			02

- 2 If you have set that the fan has to operate as normal, also set the air volume speed:

If you want		Then ¹		
		M	C1	C2
During cooling operation	LL ²	12 (22)	6	01
	Setup volume ²			02
During heating operation	LL ²	12 (22)	3	01
	Setup volume ²			02

Setting: Time to clean air filter

This setting must correspond with the air contamination in the room. It determines the interval at which the **TIME TO CLEAN AIR FILTER** notification is displayed on the user interface. When using a wireless user interface, you must also set the address (see the installation manual of the user interface).

If you want an interval of... (air contamination)	Then ¹		
	M	C1	C2
±2500 h (light)	10 (20)	0	01
±1250 h (heavy)			02
No notification		3	02

⁽¹⁾ Field settings are defined as follows:

- **M**: Mode number – **First number**: for group of units – **Number between brackets**: for individual unit
- **C1**: First code number
- **C2**: Second code number
- **■**: Default

⁽²⁾ Fan speed:

- **LL**: Low fan speed
- **Setup volume**: The fan speed corresponds to the speed the user has set (low, medium, high) using the fan speed button on the user interface.

7 Commissioning

7 Commissioning

NOTICE

NEVER operate the unit without thermistors and/or pressure sensors/switches. Burning of the compressor might result.

7.1 Checklist before commissioning

Do NOT operate the system before the following checks are OK:

<input type="checkbox"/>	You read the complete installation instructions, as described in the installer reference guide .
<input type="checkbox"/>	The indoor units are properly mounted.
<input type="checkbox"/>	In case a wireless user interface is used: The indoor unit decoration panel with infrared receiver is installed.
<input type="checkbox"/>	The outdoor unit is properly mounted.
<input type="checkbox"/>	There are NO missing phases or reversed phases .
<input type="checkbox"/>	The system is properly earthed and the earth terminals are tightened.
<input type="checkbox"/>	The fuses or locally installed protection devices are installed according to this document, and have not been bypassed.
<input type="checkbox"/>	The power supply voltage matches the voltage on the identification label of the unit.
<input type="checkbox"/>	There are NO loose connections or damaged electrical components in the switch box.
<input type="checkbox"/>	The insulation resistance of the compressor is OK.
<input type="checkbox"/>	There are NO damaged components or squeezed pipes on the inside of the indoor and outdoor units.
<input type="checkbox"/>	There are NO refrigerant leaks .
<input type="checkbox"/>	The correct pipe size is installed and the pipes are properly insulated.
<input type="checkbox"/>	The stop valves (gas and liquid) on the outdoor unit are fully open.

7.2 To perform a test run

This task is only applicable when using the BRC1E52 or BRC1E53 user interface. When using any other user interface, see the installation manual or service manual of the user interface.

NOTICE

Do not interrupt the test run.





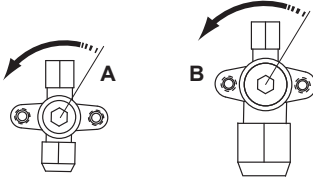

INFORMATION

Backlight. To perform an ON/OFF action on the user interface, the backlight does not need to be lit. For any other action, it needs to be lit first. The backlight is lit for ± 30 seconds when you press a button.

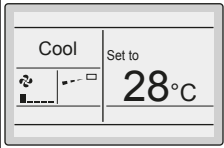
1 Perform introductory steps.

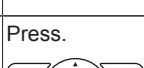
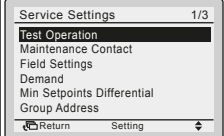

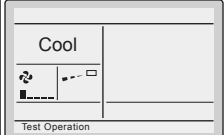
#	Action
1	Open the liquid stop valve (A) and gas stop valve (B) by removing the stem cap and turning counterclockwise with a hex wrench until it stops. 
2	Close the service cover to prevent electric shocks.
3	Turn ON power for at least 6 hours before starting operation to protect the compressor.
4	On the user interface, set the unit to cooling operation mode.

2 Start the test run

#	Action	Result
1	Go to the home menu. 	
2	Press at least 4 seconds. 	The Service Settings menu is displayed.
3	Select Test Operation. 	
4	Press. 	Test Operation is displayed on the home menu. 
5	Press within 10 seconds. 	Test run starts.

3 Check operation for 3 minutes.

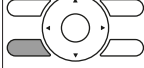
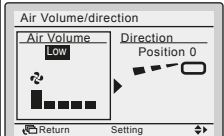
4 Check operation of the airflow direction.

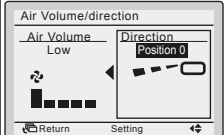
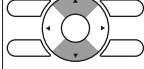
#	Action	Result
1	Press. 	
2	Select Position 0. 	
3	Change the position. 	If the airflow flap of the indoor unit moves, operation is OK. If not, operation is not OK.

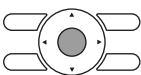
#	Action	Result
4	Press. 	The home menu is displayed.

5 Stop the test run.

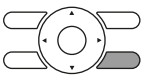
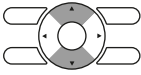
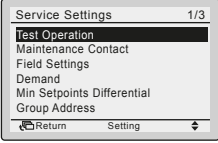
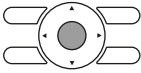
#	Action	Result
1	Press at least 4 seconds. 	The Service Settings menu is displayed.
2	Select Test Operation. 	
3	Press. 	The unit returns to normal operation, and the home menu is displayed.

7.3 Error codes when performing a test run

If the installation of the outdoor unit has NOT been done correctly, the following error codes may be displayed on the user interface:

Error code	Possible cause
Nothing displayed (the currently set temperature is not displayed)	<ul style="list-style-type: none"> The wiring is disconnected or there is a wiring error (between power supply and outdoor unit, between outdoor unit and indoor units, between indoor unit and user interface). The fuse on the outdoor unit PCB has blown out.
E3, E4 or L8	<ul style="list-style-type: none"> The stop valves are closed. The air inlet or air outlet is blocked.
E7	<p>There is a missing phase in case of three-phase power supply units.</p> <p>Note: Operation will be impossible. Turn OFF the power, recheck the wiring, and switch two of the three electrical wires.</p>
L4	The air inlet or air outlet is blocked.
U0	The stop valves are closed.
U2	<ul style="list-style-type: none"> There is a voltage imbalance. There is a missing phase in case of three-phase power supply units. Note: Operation will be impossible. Turn OFF the power, recheck the wiring, and switch two of the three electrical wires.
U4 or UF	The inter-unit branch wiring is not correct.
UA	The outdoor and indoor unit are incompatible.

8 Technical data

8 Technical data

Latest information can be found in the technical engineering data.

8.1 Piping diagram: Indoor unit

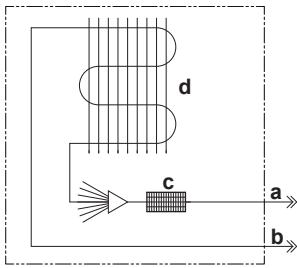

- a Liquid pipe connection
- b Gas pipe connection
- c Filter
- d Heat exchanger

8.2 Wiring diagram: Indoor unit

The wiring diagram is delivered with the unit, located at the inside of the service cover.

Notes:

- 1 In case using central remote controller, connect it to the unit in accordance with the attached installation manual.
- 2 In case of main/sub changeover. See the installation manual attached to remote controller.
- 3 Shows only in case of protected pipes. Use H07RN in case of no protection.
- 4 When connecting the input wires from outside, forced off or on/off control operation can be selected by the remote controller. See installation manual for more details.
- 5 Connect power of adapter for wiring to terminal block (X2M) of indoor unit directly.
- 6 X35A, X39A, X70A are connected when the optional accessories are being used. In case an auto cleaning panel is used, see the its wiring diagram.

Symbols:

X1M	Main terminal
-----	Earth wiring
<u>15</u>	Wire number 15
-----	Field wire
---■---	Field cable
→ **/12.2	Connection ** continues on page 12 column 2
①	Several wiring possibilities
[---]	Option
[---]	Not mounted in switch box
[---]	Wiring depending on model
[]	PCB

Colours:

BLK	Black
WHT	White
RED	Red

Legend:

A1P	Main PCB
-----	----------

A2P	Adapter PCB
A3P, A4P	* Sensor kit PCB
A5P, A6P	Receiver/display PCB
A7P	* Adapter for wiring
BS1 (A6P)	Push button (ON/Off)
C105 (A1P)	Capacitor
DS1 (A1P)	DIP switch
F1U (A7P)	Fuse B, 5 A 250 V
F2U (A7P)	Fuse B, 5 A 250 V
HAP (A1P)	Running LED (service monitor – green)
H1P (A6P)	LED (On – red)
H2P (A6P)	LED (timer – green)
H3P (A6P)	LED (filter sign – red)
H4P (A6P)	LED (defrost – orange)
H5P (A6P)	LED (element cleaning – red)
H6P (A6P)	LED (ventilation cleaning – green)
KCR (A7P)	Magnetic relay
KFR (A7P)	Magnetic relay
KHuR (A7P)	Magnetic relay (Hu)
K2R	Magnetic relay
M1F	Fan motor (indoor)
M1P	Motor (drain pump)
M*S	Motor (swing flap)
PS (A1P)	Power supply
R1T	Thermistor (air)
R2T	Thermistor (liquid piping)
R3T	Thermistor (coil)
RC (A1P)	Signal receiver circuit
SS1 (A5P)	Selector switch (emergency)
SS2 (A5P)	Selector switch (wireless address set)
S1L	Float switch
TC (A1P)	Signal transmission circuit
V1R (A1P)	Diode module
X1A (A7P)	Connector (power supply for option PCB)
X2A (A7P)	PCB connector (sensor kit)
X24A (A1P)	PCB connector (wireless remote controller)

X33A (A1P)	PCB connector (adapter for wiring)	X*Y	Connector
X35A (A1P)	PCB connector (auto clean panel)	Z*C	Noise filter (ferrit core)
X39A (A1P)	PCB connector (auto clean panel)	Z*F	Noise filter
X70A (A1P)	PCB connector (auto clean panel)	*	Optional
X*A	PCB connector	#	Field supply
X*M	Terminal strip		

For the user

9 About the system

The indoor unit of this split system air conditioner can be used for heating/cooling applications.



NOTICE

Do not use the air conditioner for other purposes. In order to avoid any quality deterioration, do not use the unit for cooling precision instruments, food, plants, animals or works of art.



NOTICE

For future modifications or expansions of your system:

A full overview of allowable combinations (for future system extensions) is available in technical engineering data and should be consulted. Contact your installer to receive more information and professional advice.

9.1 System layout

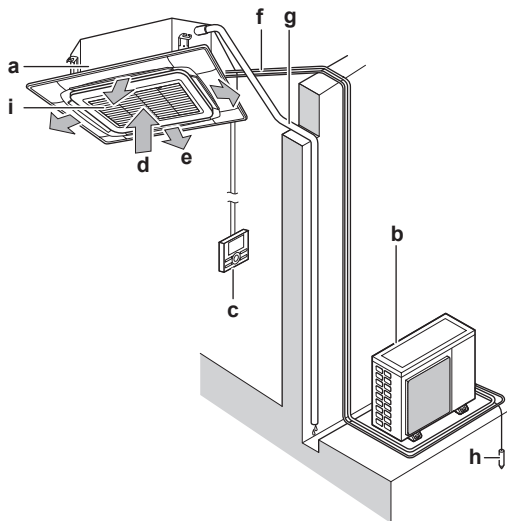

- a Indoor unit
- b Outdoor unit
- c User interface
- d Suction air
- e Discharge air
- f Refrigerant piping + interconnection cable
- g Drain pipe
- h Earth wiring
- i Suction grille and air filter

10 User interface



CAUTION

Never touch the internal parts of the controller.

Do not remove the front panel. Some parts inside are dangerous to touch and appliance problems may happen. For checking and adjusting the internal parts, contact your dealer.

This operation manual will give a non-exhaustive overview of the main functions of the system.

For more information about the user interface, see the operation manual of the installed user interface.

11 Operation

11.1 Operation range

Use the system in the following temperature and humidity ranges for safe and effective operation.

	Cooling	Heating
Outdoor temperature	-15~50°C DB	-19~21°C DB -20~15.5°C WB
Indoor temperature	18~35°C DB 12~28°C WB	10~27°C DB
Indoor humidity	≤80% ^(a)	

(a) To avoid condensation and water dripping out of the unit. If the temperature or the humidity is beyond these conditions, safety devices may be put in action and the air conditioner may not operate.

11.2 Operating the system

11.2.1 About operating the system

- To protect the unit, turn on the main power switch 6 hours before operation.
- If the main power supply is turned off during operation, operation will restart automatically after the power turns back on again.

11.2.2 About cooling, heating, fan only, and automatic operation

- The air flow rate may adjust itself depending on the room temperature or the fan may stop immediately. This is not a malfunction.

12 Maintenance and service

11.2.3 About the heating operation

It may take longer to reach the set temperature for general heating operation than for cooling operation.

The following operation is performed in order to prevent the heating capacity from dropping or cold air from blowing.

Defrost operation

In heating operation, freezing of the outdoor unit's air cooled coil increases over time, restricting the energy transfer to the outdoor unit's coil. Heating capability decreases and the system needs to go into defrost operation to be able to deliver enough heat to the indoor units:

The indoor unit will stop fan operation, the refrigerant cycle will reverse and energy from inside the building will be used to defrost the outdoor unit coil.

The indoor unit will indicate defrost operation on the displays .

Hot start

In order to prevent cold air from blowing out of an indoor unit at the start of heating operation, the indoor fan is automatically stopped. The display of the user interface shows . It may take some time before the fan starts. This is not a malfunction.

11.2.4 To operate the system

- 1 Press the operation mode selector button on the user interface several times and select the operation mode of your choice.

 Cooling operation

 Heating operation

 Fan only operation

- 2 Press the ON/OFF button on the user interface.

Result: The operation lamp lights up and the system starts operating.

11.3 Using the dry program

11.3.1 About the dry program

- The function of this program is to decrease the humidity in your room with minimal temperature decrease (minimal room cooling).
- The micro computer automatically determines temperature and fan speed (cannot be set by the user interface).
- The system does not go into operation if the room temperature is low (<20°C).

11.3.2 To use the dry program

To start

- 1 Press the operation mode selector button on the user interface several times and select  (program dry operation).
- 2 Press the ON/OFF button of the user interface.

Result: The operation lamp lights up and the system starts operating.

To stop

- 3 Press the ON/OFF button on the user interface once again.

Result: The operation lamp goes out and the system stops operating.



NOTICE

Do not turn off power immediately after the unit stops, but wait for at least 5 minutes.

11.4 Adjusting the air flow direction

Refer to the operation manual of the user interface.

11.4.1 About the air flow flap





Double flow+multi-flow units

For the following conditions, a micro computer controls the air flow direction which may be different from the display.

Cooling	Heating
<ul style="list-style-type: none">• When the room temperature is lower than the set temperature.	<ul style="list-style-type: none">• When starting operation.• When the room temperature is higher than the set temperature.• At defrost operation.
<ul style="list-style-type: none">• When operating continuously at horizontal air flow direction.• When continuous operation with downward air flow is performed at the time of cooling with a ceiling-suspended or a wall-mounted unit, the micro computer may control the flow direction, and then the user interface indication will also change.	

The air flow direction can be adjusted in one of the following ways:

- The air flow flap itself adjusts its position.
- The air flow direction can be fixed by the user.
- Automatic  and desired position .



WARNING

Never touch the air outlet or the horizontal blades while the swing flap is in operation. Fingers may become caught or the unit may break down.



NOTICE

- The movable limit of the flap is changeable. Contact your dealer for details. (only for double-flow, multi-flow, corner, ceiling-suspended and wall-mounted).
- Avoid operating in the horizontal direction . It may cause dew or dust to settle on the ceiling or flap.

12 Maintenance and service



NOTICE

Never inspect or service the unit by yourself. Ask a qualified service person to perform this work. However, as end user, you may clean the air filter, suction grille, air outlet and outside panels.



WARNING

Never replace a fuse with a fuse of a wrong ampere ratings or other wires when a fuse blows out. Use of wire or copper wire may cause the unit to break down or cause a fire.



CAUTION

Do not insert fingers, rods or other objects into the air inlet or outlet. Do not remove the fan guard. When the fan is rotating at high speed, it will cause injury.



CAUTION

After a long use, check the unit stand and fitting for damage. If damaged, the unit may fall and result in injury.



NOTICE

Do not wipe the controller operation panel with benzene, thinner, chemical dust cloth, etc. The panel may get discoloured or the coating peeled off. If it is heavily dirty, soak a cloth in water-diluted neutral detergent, squeeze it well and wipe the panel clean. Wipe it with another dry cloth.



CAUTION

Before accessing terminal devices, make sure to interrupt all power supply.



NOTICE

When cleaning the heat exchanger, make sure to remove the switch box, fan motor, drain pump and float switch. Water or detergent might deteriorate the insulation of electronic components and result in burnout of these components.

12.1 Cleaning the air filter, suction grille, air outlet and outside panels

12.1.1 To clean the air filter

When to clean the air filter:

- Rule of thumb: Clean every 6 months. If the air in the room is extremely contaminated, increase the cleaning frequency.
- Depending on the settings, the user interface can display the **TIME TO CLEAN AIR FILTER** notification. Clean the air filter when the notification is displayed.
- If the dirt becomes impossible to clean, change the air filter (= optional equipment).

How to clean the air filter:



NOTICE

Do NOT use water of 50°C or higher. **Possible consequence:** Discoloration and deformation.

- 1 Open the suction grille.

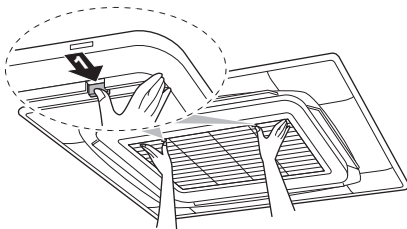

- 2 Remove the air filter.

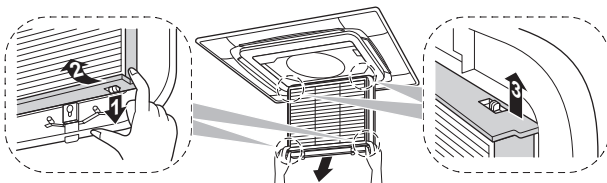

- 3 Clean the air filter. Use a vacuum cleaner or wash with water. If the air filter is very dirty, use a soft brush and neutral detergent.

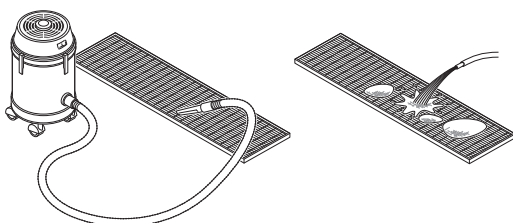

- 4 Dry the air filter in the shadow.
- 5 Reattach the air filter, and close the suction grille.
- 6 Turn ON the power.
- 7 Press the **FILTER SIGN RESET** button.

Result: The **TIME TO CLEAN AIR FILTER** notification disappears from the user interface.

12.1.2 To clean the suction grille



NOTICE

Do NOT use water of 50°C or higher. **Possible consequence:** Discoloration and deformation.

- 1 Open the suction grille.

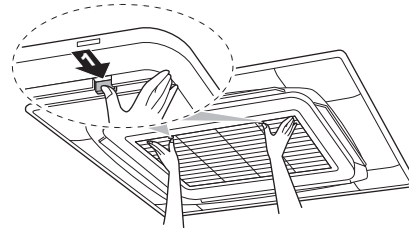

- 2 Remove the suction grille.

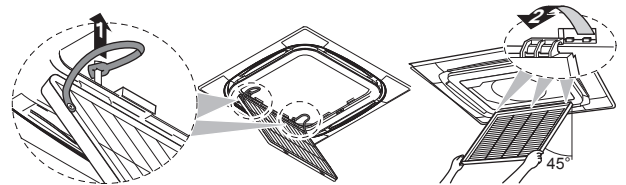

- 3 Remove the air filter.

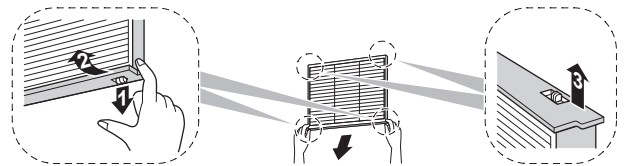

- 4 Clean the suction grille. Wash with a soft bristle brush, and water or neutral detergent. If the suction grille is very dirty, use a typical kitchen cleaner, leave it on for 10 min, then wash it with water.
- 5 Reattach the air filter and suction grille, and close the suction grille.

12.1.3 To clean the air outlet and outside panels



WARNING

Do NOT let the indoor unit get wet. **Possible consequence:** Electric shock or fire.



NOTICE

- Do NOT use gasoline, benzene, thinner polishing powder or liquid insecticide. **Possible consequence:** Discoloration and deformation.
- Do NOT use water or air of 50°C or higher. **Possible consequence:** Discoloration and deformation.
- Do NOT scrub firmly when washing the blade with water. **Possible consequence:** The surface sealing peels off.

Clean with a soft cloth. If it is difficult to remove stains, use water or neutral detergent.

13 Troubleshooting

12.2 About the refrigerant

This product contains fluorinated greenhouse gases. Do NOT vent gases into the atmosphere.

Refrigerant type: R32

Global warming potential value: 675

Periodical inspections for refrigerant leaks may be required depending on the applicable legislation. Please contact your installer for more information.



WARNING: FLAMMABLE MATERIAL

The refrigerant inside this unit is mildly flammable.



WARNING

- Do NOT pierce or burn refrigerant cycle parts.
- Do NOT use cleaning materials or means to accelerate the defrosting process other than those recommended by the manufacturer.
- Be aware that the refrigerant inside the system is odourless.



WARNING

The refrigerant inside the unit is mildly flammable, but normally does not leak. If the refrigerant leaks in the room and comes in contact with fire from a burner, a heater, or a cooker, this may result in fire, or the formation of a harmful gas.

Turn off any combustible heating devices, ventilate the room, and contact the dealer from which you purchased the unit.

Do not use the unit until a service person confirms that the portion from which the refrigerant leaked is repaired.

12.3 After-sales service and warranty

12.3.1 Warranty period

- This product includes a warranty card that was filled in by the dealer at the time of installation. The completed card has to be checked by the customer and stored carefully.
- If repairs to the air conditioner are necessary within the warranty period, contact your dealer and keep the warranty card at hand.

12.3.2 Recommended maintenance and inspection

Since dust collects when using the unit for several years, performance of the unit will deteriorate to some extent. As taking apart and cleaning interiors of units requires technical expertise and in order to ensure the best possible maintenance of your units, we recommend to enter into a maintenance and inspection contract on top of normal maintenance activities. Our network of dealers has access to a permanent stock of essential components in order to keep your air conditioner in operation as long as possible. Contact your dealer for more information.

When asking your dealer for an intervention, always state:

- The complete model name of the air conditioner.
- The manufacturing number (stated on the nameplate of the unit).
- The installation date.
- The symptoms or malfunction, and details of the defect.



WARNING

- Do not modify, disassemble, remove, reinstall or repair the unit yourself as incorrect dismantling or installation may cause an electric shock or fire. Contact your dealer.
- In case of accidental refrigerant leaks, make sure there are no naked flames. The refrigerant itself is entirely safe, non-toxic and mildly flammable, but it will generate toxic gas when it accidentally leaks into a room where combustible air from fan heaters, gas cookers, etc. is present. Always have qualified service personnel confirm that the point of leakage has been repaired or corrected before resuming operation.

13 Troubleshooting

If one of the following malfunctions occur, take the measures shown below and contact your dealer.



WARNING

Stop operation and shut off the power if anything unusual occurs (burning smells etc.).

Leaving the unit running under such circumstances may cause breakage, electric shock or fire. Contact your dealer.

The system must be repaired by a qualified service person:

Malfunction	Measure
If a safety device such as a fuse, a breaker or an earth leakage breaker frequently actuates or the ON/OFF switch does not properly work.	Turn off the main power switch.
If water leaks from the unit.	Stop the operation.
The operation switch does not work well.	Turn off the power.
If the user interface display indicates the unit number, the operation lamp flashes and the malfunction code appears.	Notify your installer and report the malfunction code.

If the system does not properly operate except for the above mentioned cases and none of the above mentioned malfunctions is evident, investigate the system according to the following procedures.

Malfunction	Measure
If the system does not operate at all.	<ul style="list-style-type: none"> Check if there is no power failure. Wait until power is restored. If power failure occurs during operation, the system automatically restarts immediately after the power supply is recovered. Check if no fuse has blown or breaker has worked. Change the fuse or reset the breaker if necessary.

Malfunction	Measure
The system operates but cooling or heating is insufficient.	<ul style="list-style-type: none"> ▪ Check if air inlet or outlet of outdoor or indoor unit is not blocked by obstacles. Remove any obstacle and make it well-ventilated. ▪ Check if the air filter is not clogged (see "12.1.1 To clean the air filter" on page 15). ▪ Check the temperature setting. ▪ Check the fan speed setting on your user interface. ▪ Check for open doors or windows. Shut doors and windows to prevent wind from coming in. ▪ Check if there are too many occupants in the room during cooling operation. Check if the heat source of the room is excessive. ▪ Check if direct sunlight enters the room. Use curtains or blinds. ▪ Check if the air flow angle is proper.

If after checking all above items, it is impossible to fix the problem yourself, contact your installer and state the symptoms, the complete model name of the air conditioner (with manufacturing number if possible) and the installation date (possibly listed on the warranty card).

13.1 Symptoms that are not air conditioner troubles

Following symptoms are not air conditioner troubles:

13.1.1 Symptom: The system does not operate

- The air conditioner does not start immediately after the ON/OFF button on the user interface is pressed. If the operation lamp lights, the system is in normal condition. To prevent overloading of the compressor motor, the air conditioner starts 5 minutes after it is turned ON again in case it was turned OFF just before. The same starting delay occurs after the operation mode selector button was used.
- If "Under Centralized Control" is displayed on the user interface, pressing the operation button causes the display to blink for a few seconds. The blinking display indicates that the user interface cannot be used.
- The system does not start immediately after the power supply is turned on. Wait one minute until the micro computer is prepared for operation.

13.1.2 Symptom: The fan strength does not correspond to the setting

The fan speed does not change even if the fan speed adjustment button is pressed. During heating operation, when the room temperature reaches the set temperature, the outdoor unit goes off and the indoor unit changes to whisper fan speed. This is to prevent cold air blowing directly on occupants of the room. The fan speed will not change if the button is pressed.

13.1.3 Symptom: The fan direction does not correspond to the setting

The fan direction does not correspond with the user interface display. The fan direction does not swing. This is because the unit is being controlled by the micro computer.

13.1.4 Symptom: White mist comes out of a unit (Indoor unit)

- When humidity is high during cooling operation. If the interior of an indoor unit is extremely contaminated, the temperature distribution inside a room becomes uneven. It is necessary to clean the interior of the indoor unit. Ask your dealer for details on cleaning the unit. This operation requires a qualified service person.
- Immediately after the cooling operation stops and if the room temperature and humidity are low. This is because warm refrigerant gas flows back into the indoor unit and generates steam.

13.1.5 Symptom: White mist comes out of a unit (Indoor unit, outdoor unit)

When the system is changed over to heating operation after defrost operation. Moisture generated by defrost becomes steam and is exhausted.

13.1.6 Symptom: The user interface display reads "U4" or "U5" and stops, but then restarts after a few minutes

This is because the user interface is intercepting noise from electric appliances other than the air conditioner. The noise prevents communication between the units, causing them to stop. Operation automatically restarts when the noise ceases.

13.1.7 Symptom: Noise of air conditioners (Indoor unit)

- A "zeen" sound is heard immediately after the power supply is turned on. The electronic expansion valve inside an indoor unit starts working and makes the noise. Its volume will reduce in about one minute.
- A continuous low "shah" sound is heard when the system is in cooling operation or at a stop. When the drain pump is in operation, this noise is heard.
- A "pishi-pishi" squeaking sound is heard when the system stops after heating operation. Expansion and contraction of plastic parts caused by temperature change make this noise.

13.1.8 Symptom: Noise of air conditioners (Indoor unit, outdoor unit)

- A continuous low hissing sound is heard when the system is in cooling or defrost operation. This is the sound of refrigerant gas flowing through both indoor and outdoor units.
- A hissing sound which is heard at the start or immediately after stopping operation or defrost operation. This is the noise of refrigerant caused by flow stop or flow change.

13.1.9 Symptom: Noise of air conditioners (Outdoor unit)

When the tone of operating noise changes. This noise is caused by the change of frequency.

13.1.10 Symptom: Dust comes out of the unit

When the unit is used for the first time in a long time. This is because dust has gotten into the unit.

13.1.11 Symptom: The units can give off odours

The unit can absorb the smell of rooms, furniture, cigarettes, etc., and then emit it again.

14 Relocation

13.1.12 Symptom: The outdoor unit fan does not spin

During operation. The speed of the fan is controlled in order to optimise product operation.

13.1.13 Symptom: The display shows "88"

This is the case immediately after the main power supply switch is turned on and means that the user interface is in normal condition. This continues for one minute.

13.1.14 Symptom: The compressor in the outdoor unit does not stop after a short heating operation

This is to prevent refrigerant from remaining in the compressor. The unit will stop after 5 to 10 minutes.

14 Relocation

Contact your dealer for removing and reinstalling the total unit. Moving units requires technical expertise.

15 Disposal

This unit uses hydrofluorocarbon. Contact your dealer when discarding this unit. It is required by law to collect, transport and discard the refrigerant in accordance with the "hydrofluorocarbon collection and destruction" regulations.

