

Service Manual

Inverter Pair Duct Connected Type C-Series

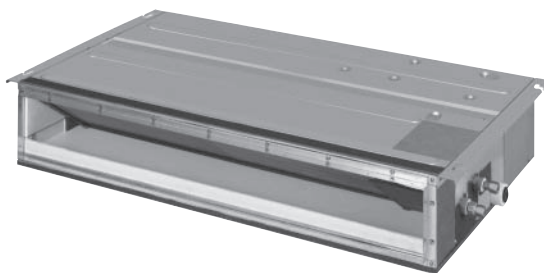

[Applied Models]

- Inverter Pair: Cooling only
- Inverter Pair: Heat Pump

Service Manual

Inverter Pair Duct Connected Type C-Series

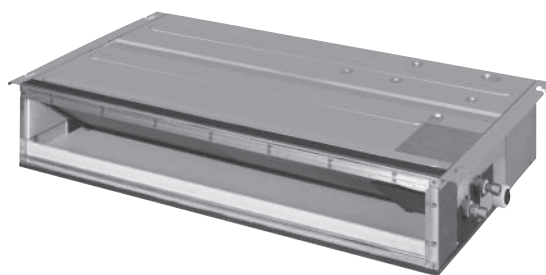

[Applied Models]

- Inverter Pair: Cooling only
- Inverter Pair: Heat Pump

Inverter Pair Duct Connected Type C-Series

●Cooling Only

Indoor Unit

FDKS50CVMB
FDKS60CVMB

Outdoor Unit

RKS50E2(3)V1B
RKS60E2(3)V1B

RKS50F2V1B
RKS60F2(3)V1B

RKS50G2V1B

●Heat Pump

Indoor Unit

FDXS50CVMB
FDXS60CVMB

Outdoor Unit

RXS50E2(3)V1B
RXS60E2(3)V1B

RXS50F2V1B
RXS60F2(3)V1B

RXS50G2V1B

1. Introduction	v
1.1 Safety Cautions	v
1.2 Used Icons	ix
Part 1 List of Functions	1
1. Functions.....	2
Part 2 Specifications	5
1. Specifications	6
1.1 Cooling Only.....	6
1.2 Heat Pump	9
Part 3 Printed Circuit Board Connector Wiring Diagram	12
1. Printed Circuit Board Connector Wiring Diagram.....	13
1.1 Indoor Unit.....	13
1.2 Outdoor Unit.....	15
Part 4 Function and Control.....	17
1. Main Functions.....	18
1.1 Temperature Control	18
1.2 Frequency Principle.....	18
1.3 Fan Speed Control for Indoor Units.....	20
1.4 Program Dry Operation	21
1.5 Automatic Operation.....	22
1.6 Thermostat Control.....	23
1.7 NIGHT SET Mode	24
1.8 HOME LEAVE Operation	25
1.9 Inverter POWERFUL Operation	26
1.10 Other Functions.....	27
2. Function of Thermistor	28
3. Control Specification	29
3.1 Mode Hierarchy	29
3.2 Frequency Control.....	30
3.3 Controls at Mode Changing / Start-up.....	32
3.4 Discharge Pipe Temperature Control.....	33
3.5 Input Current Control.....	34
3.6 Freeze-up Protection Control	35
3.7 Heating Peak-cut Control	35
3.8 Outdoor Fan Control.....	36
3.9 Liquid Compression Protection Function.....	36
3.10 Defrost Control	37
3.11 Electronic Expansion Valve Control	38
3.12 Malfunctions	41
3.13 Forced Operation Mode	42





Part 5 Operation Manual	43
1. System Configuration	44
2. Operation Manual	45
2.1 Remote Control	45
2.2 Auto Dry Cool Heat Fan Operation	46
2.3 POWERFUL Operation	48
2.4 OUTDOOR UNIT QUIET Operation	49
2.5 HOME LEAVE Operation	50
2.6 TIMER Operation	52
Part 6 Service Diagnosis	54
1. Caution for Diagnosis	55
1.1 Troubleshooting with LED	55
2. Problem Symptoms and Measures	56
3. Service Check Function	57
4. Troubleshooting	60
4.1 Error Codes and Description	60
4.2 Indoor Unit PCB Abnormality	61
4.3 Freeze-up Protection Control or Heating Peak-cut Control	62
4.4 Fan Motor (AC motor) or Related Abnormality	64
4.5 Thermistor or Related Abnormality (Indoor Unit)	65
4.6 Signal Transmission Error (between Indoor Unit and Outdoor Unit)	66
4.7 Unspecified Voltage (between Indoor Unit and Outdoor Unit)	67
4.8 Outdoor Unit PCB Abnormality	68
4.9 OL Activation (Compressor Overload)	69
4.10 Compressor Lock	70
4.11 DC Fan Lock	71
4.12 Input Overcurrent Detection	72
4.13 Four Way Valve Abnormality	73
4.14 Discharge Pipe Temperature Control	75
4.15 High Pressure Control in Cooling	76
4.16 Compressor System Sensor Abnormality	77
4.17 Position Sensor Abnormality	78
4.18 CT or Related Abnormality	80
4.19 Thermistor or Related Abnormality (Outdoor Unit)	82
4.20 Electrical Box Temperature Rise	84
4.21 Radiation Fin Temperature Rise	86
4.22 Output Overcurrent Detection	88
4.23 Refrigerant Shortage	90
4.24 Low-voltage Detection or Over-voltage Detection	92
4.25 Signal Transmission Error (on Outdoor Unit PCB)	93
5. Check	94
5.1 How to Check	94

Part 7 Removal Procedure	101
1. Outdoor Unit.....	102
1.1 Removal of Outer Panels	102
1.2 Removal of Outdoor Fan / Fan Motor.....	106
1.3 Removal of Electrical Box	110
1.4 Removal of PCB.....	115
1.5 Removal of Sound Blanket / Thermistors.....	118
1.6 Removal of Four Way Valve.....	120
1.7 Removal of Electronic Expansion Valve.....	121
1.8 Removal of Compressor.....	122
Part 8 Trial Operation and Field Settings.....	125
1. Trial Operation	126
2. Field Settings	127
2.1 When 2 Units are Installed in 1 Room.....	127
2.2 Facility Setting Switch (cooling at low outdoor temperature).....	128
2.3 Jumper and Switch Settings.....	128
3. Application of Silicon Grease to a Power Transistor and a Diode Bridge .	129
Part 9 Appendix.....	130
1. Piping Diagrams.....	131
1.1 Indoor Unit.....	131
1.2 Outdoor Unit.....	132
2. Wiring Diagrams.....	133
2.1 Indoor Unit.....	133
2.2 Outdoor Unit.....	134







1. Introduction



1.1 Safety Cautions









Cautions and Warnings

- Be sure to read the following safety cautions before conducting repair work.
- The caution items are classified into “ **Warning**” and “ **Caution**”. The “ **Warning**” items are especially important since they can lead to death or serious injury if they are not followed closely. The “ **Caution**” items can also lead to serious accidents under some conditions if they are not followed. Therefore, be sure to observe all the safety caution items described below.
- About the pictograms
 - △ This symbol indicates the item for which caution must be exercised.
The pictogram shows the item to which attention must be paid.
 - This symbol indicates the prohibited action.
The prohibited item or action is shown in the illustration or near the symbol.
 - This symbol indicates the action that must be taken, or the instruction.
The instruction is shown in the illustration or near the symbol.
- After the repair work is complete, be sure to conduct a test operation to ensure that the equipment operates normally, and explain the cautions for operating the product to the customer.











1.1.1 Cautions Regarding Safety of Workers





 Warning	
<p>Be sure to disconnect the power cable plug from the plug socket before disassembling the equipment for repair. Working on the equipment that is connected to the power supply may cause an electrical shock. If it is necessary to supply power to the equipment to conduct the repair or inspecting the circuits, do not touch any electrically charged sections of the equipment.</p>	
<p>If the refrigerant gas is discharged during the repair work, do not touch the discharged refrigerant gas. The refrigerant gas may cause frostbite.</p>	
<p>When disconnecting the suction or discharge pipe of the compressor at the welded section, evacuate the refrigerant gas completely at a well-ventilated place first. If there is a gas remaining inside the compressor, the refrigerant gas or refrigerating machine oil discharges when the pipe is disconnected, and it may cause injury.</p>	
<p>If the refrigerant gas leaks during the repair work, ventilate the area. The refrigerant gas may generate toxic gases when it contacts flames.</p>	
<p>The step-up capacitor supplies high-voltage electricity to the electrical components of the outdoor unit. Be sure to discharge the capacitor completely before conducting repair work. A charged capacitor may cause an electrical shock.</p>	
<p>Do not start or stop the air conditioner operation by plugging or unplugging the power cable plug. Plugging or unplugging the power cable plug to operate the equipment may cause an electrical shock or fire.</p>	







 Warning	
Be sure to wear a safety helmet, gloves, and a safety belt when working at a high place (more than 2 m). Insufficient safety measures may cause a fall accident.	
In case of R-410A refrigerant models, be sure to use pipes, flare nuts and tools for the exclusive use of the R-410A refrigerant. The use of materials for R-22 refrigerant models may cause a serious accident such as a damage of refrigerant cycle as well as an equipment failure.	





 Caution	
Do not repair the electrical components with wet hands. Working on the equipment with wet hands may cause an electrical shock.	
Do not clean the air conditioner by splashing water. Washing the unit with water may cause an electrical shock.	
Be sure to provide the grounding when repairing the equipment in a humid or wet place, to avoid electrical shocks.	
Be sure to turn off the power switch and unplug the power cable when cleaning the equipment. The internal fan rotates at a high speed, and cause injury.	
Be sure to conduct repair work with appropriate tools. The use of inappropriate tools may cause injury.	
Be sure to check that the refrigerating cycle section has cooled down enough before conducting repair work. Working on the unit when the refrigerating cycle section is hot may cause burns.	
Use the welder in a well-ventilated place. Using the welder in an enclosed room may cause oxygen deficiency.	

1.1.2 Cautions Regarding Safety of Users

 Warning	
<p>Be sure to use parts listed in the service parts list of the applicable model and appropriate tools to conduct repair work. Never attempt to modify the equipment. The use of inappropriate parts or tools may cause an electrical shock, excessive heat generation or fire.</p>	
<p>If the power cable and lead wires have scratches or deteriorated, be sure to replace them. Damaged cable and wires may cause an electrical shock, excessive heat generation or fire.</p>	
<p>Do not use a joined power cable or extension cable, or share the same power outlet with other electrical appliances, since it may cause an electrical shock, excessive heat generation or fire.</p>	
<p>Be sure to use an exclusive power circuit for the equipment, and follow the local technical standards related to the electrical equipment, the internal wiring regulations, and the instruction manual for installation when conducting electrical work. Insufficient power circuit capacity and improper electrical work may cause an electrical shock or fire.</p>	
<p>Be sure to use the specified cable for wiring between the indoor and outdoor units. Make the connections securely and route the cable properly so that there is no force pulling the cable at the connection terminals. Improper connections may cause excessive heat generation or fire.</p>	
<p>When wiring between the indoor and outdoor units, make sure that the terminal cover does not lift off or dismount because of the cable. If the cover is not mounted properly, the terminal connection section may cause an electrical shock, excessive heat generation or fire.</p>	
<p>Do not damage or modify the power cable. Damaged or modified power cable may cause an electrical shock or fire. Placing heavy items on the power cable, and heating or pulling the power cable may damage the cable.</p>	
<p>Do not mix air or gas other than the specified refrigerant (R-410A / R-22) in the refrigerant system. If air enters the refrigerating system, an excessively high pressure results, causing equipment damage and injury.</p>	
<p>If the refrigerant gas leaks, be sure to locate the leaking point and repair it before charging the refrigerant. After charging refrigerant, make sure that there is no refrigerant leak. If the leaking point cannot be located and the repair work must be stopped, be sure to perform pump-down and close the service valve, to prevent the refrigerant gas from leaking into the room. The refrigerant gas itself is harmless, but it may generate toxic gases when it contacts flames, such as fan and other heaters, stoves and ranges.</p>	
<p>When relocating the equipment, make sure that the new installation site has sufficient strength to withstand the weight of the equipment. If the installation site does not have sufficient strength and if the installation work is not conducted securely, the equipment may fall and cause injury.</p>	





 Warning	
Check to make sure that the power cable plug is not dirty or loose, then insert the plug into a power outlet securely. If the plug has dust or loose connection, it may cause an electrical shock or fire.	
Be sure to install the product correctly by using the provided standard installation frame. Incorrect use of the installation frame and improper installation may cause the equipment to fall, resulting in injury.	For unitary type only 
Be sure to install the product securely in the installation frame mounted on the window frame. If the unit is not securely mounted, it may fall and cause injury.	For unitary type only 
When replacing the coin battery in the remote control, be sure to disposed of the old battery to prevent children from swallowing it. If a child swallows the coin battery, see a doctor immediately.	

 Caution	
Installation of a leakage breaker is necessary in some cases depending on the conditions of the installation site, to prevent electrical shocks.	
Do not install the equipment in a place where there is a possibility of combustible gas leaks. If the combustible gas leaks and remains around the unit, it may cause a fire.	
Check to see if the parts and wires are mounted and connected properly, and if the connections at the soldered or crimped terminals are secure. Improper installation and connections may cause excessive heat generation, fire or an electrical shock.	
If the installation platform or frame has corroded, replace it. Corroded installation platform or frame may cause the unit to fall, resulting in injury.	
Check the grounding, and repair it if the equipment is not properly grounded. Improper grounding may cause an electrical shock.	

 Caution	
Be sure to measure the insulation resistance after the repair, and make sure that the resistance is 1 MΩ or higher. Faulty insulation may cause an electrical shock.	
Be sure to check the drainage of the indoor unit after the repair. Faulty drainage may cause the water to enter the room and wet the furniture and floor.	
Do not tilt the unit when removing it. The water inside the unit may spill and wet the furniture and floor.	
Be sure to install the packing and seal on the installation frame properly. If the packing and seal are not installed properly, water may enter the room and wet the furniture and floor.	For unitary type only 

1.2 Used Icons

Icons are used to attract the attention of the reader to specific information. The meaning of each icon is described in the table below:

Icon	Type of Information	Description
 Note:	Note	A “note” provides information that is not indispensable, but may nevertheless be valuable to the reader, such as tips and tricks.
 Caution	Caution	A “caution” is used when there is danger that the reader, through incorrect manipulation, may damage equipment, lose data, get an unexpected result or has to restart (part of) a procedure.
 Warning	Warning	A “warning” is used when there is danger of personal injury.
	Reference	A “reference” guides the reader to other places in this binder or in this manual, where he/she will find additional information on a specific topic.

Part 1

List of Functions

1. Functions.....2

1. Functions

Category	Functions	FDKS50/60CVMB RKS50/60E2(3)V1B		Category	Functions	FDKS50/60CVMB RKS50/60E2(3)V1B	
		FDXS50/60CVMB RXS50/60E2(3)V1B	FDXS50/60CVMB RXS50/60E2(3)V1B			FDXS50/60CVMB RXS50/60E2(3)V1B	FDXS50/60CVMB RXS50/60E2(3)V1B
Basic Function	Inverter (with Inverter Power Control)	○	○	Health & Clean	Air-Purifying Filter	—	—
	Operation Limit for Cooling (°CDB)	-10 ~46★	-10 ~46		Photocatalytic Deodorizing Filter	—	—
	Operation Limit for Heating (°CWB)	—	-15 ~18		Air-Purifying Filter with Photocatalytic Deodorizing Function	—	—
	PAM Control	○	○		Titanium Apatite Photocatalytic Air-Purifying Filter	—	—
Compressor	Oval Scroll Compressor	—	—	Air Filter (Prefilter)	○	○	
	Swing Compressor	○	○	Wipe-Clean Flat Panel	—	—	
	Rotary Compressor	—	—	Washable Grille	—	—	
	Reluctance DC Motor	○	○	Mold Proof Operation	—	—	
Comfortable Airflow	Power-Airflow Flap	—	—	Heating Dry Operation	—	—	
	Power-Airflow Dual Flaps	—	—	Good-Sleep Cooling Operation	—	—	
	Power-Airflow Diffuser	—	—	Timer	24-Hour ON/OFF TIMER	○	○
	Wide-Angle Louvers	—	—		NIGHT SET Mode	○	○
	Vertical Auto-Swing (Up and Down)	—	—	Worry Free "Reliability & Durability"	Auto-Restart (after Power Failure)	○	○
	Horizontal Auto-Swing (Right and Left)	—	—		Self-Diagnosis (Digital, LED) Display	○	○
3-D Airflow	—	—	Wiring Error Check		—	—	
Comfort Control	Auto Fan Speed	○	○		Anti-Corrosion Treatment of Outdoor Heat Exchanger	○	○
	Indoor Unit Quiet Operation	○	○	Flexibility	Multi-Split / Split Type Compatible Indoor Unit	○	○
	NIGHT QUIET Mode (Automatic)	—	—		Flexible Voltage Correspondence	—	—
	OUTDOOR UNIT QUIET Operation (Manual)	○	○		High Ceiling Application	—	—
	INTELLIGENT EYE Operation	—	—		Chargeless	10 m	10 m
	Quick Warming Function (Preheating Operation)	—	○		Either Side Drain (Right or Left)	—	—
	Hot-Start Function	—	○		Power Selection	—	—
	Automatic Defrosting	—	○		Remote Control	5-Rooms Centralized Controller (Option)	○
Operation	Automatic Operation	—	○			Remote Control Adapter (Normal Open Pulse Contact) (Option)	○
	Program Dry Operation	○	○	Remote Control Adapter (Normal Open Contact) (Option)	○	○	
Lifestyle Convenience	New POWERFUL Operation (Non-Inverter)	—	—	Remote Control	DIII-NET Compatible (Adapter) (Option)	○	○
		○	○		Wireless	○	○
	Priority-Room Setting	—	—		Wired (Option)	○	○
	COOL / HEAT Mode Lock	—	—				
	HOME LEAVE Operation	○	○				
	ECONO Operation	—	—				
	Indoor Unit ON/OFF Button	○	○				
	Signal Receiving Sign	○	○				
	Temperature Display	—	—				

Note: ○ : Holding Functions
— : No Functions

★ : Lower limit can be extended to -15°C by turning switch. (facility use only)

Category	Functions	FDKS50/60CVMB RKS50/60F2V1B	FDXS50/60CVMB RXS50/60F2V1B	Category	Functions	FDKS50/60CVMB RKS50/60F2V1B	FDXS50/60CVMB RXS50/60F2V1B
Basic Function	Inverter (with Inverter Power Control)	○	○	Health & Clean	Air-Purifying Filter	—	—
	Operation Limit for Cooling (°CDB)	-10 ~46★	-10 ~46		Photocatalytic Deodorizing Filter	—	—
	Operation Limit for Heating (°CWB)	—	-15 ~18		Air-Purifying Filter with Photocatalytic Deodorizing Function	—	—
	PAM Control	○	○		Titanium Apatite Photocatalytic Air-Purifying Filter	—	—
Compressor	Oval Scroll Compressor	—	—	Air Filter (Prefilter)	○	○	
	Swing Compressor	○	○	Wipe-Clean Flat Panel	—	—	
	Rotary Compressor	—	—	Washable Grille	—	—	
	Reluctance DC Motor	○	○	Mold Proof Operation	—	—	
Comfortable Airflow	Power-Airflow Flap	—	—	Timer	Heating Dry Operation	—	—
	Power-Airflow Dual Flaps	—	—		Good-Sleep Cooling Operation	—	—
	Power-Airflow Diffuser	—	—		24-Hour ON/OFF TIMER	○	○
	Wide-Angle Louvers	—	—	Worry Free "Reliability & Durability"	NIGHT SET Mode	○	○
	Vertical Auto-Swing (Up and Down)	—	—		Auto-Restart (after Power Failure)	○	○
	Horizontal Auto-Swing (Right and Left)	—	—		Self-Diagnosis (Digital, LED) Display	○	○
	3-D Airflow	—	—		Wiring Error Check	—	—
Comfort Control	Auto Fan Speed	○	○	Flexibility	Anti-Corrosion Treatment of Outdoor Heat Exchanger	○	○
	Indoor Unit Quiet Operation	○	○		Multi-Split / Split Type Compatible Indoor Unit	○	○
	NIGHT QUIET Mode (Automatic)	—	—		Flexible Voltage Correspondence	—	—
	OUTDOOR UNIT QUIET Operation (Manual)	○	○	High Ceiling Application	—	—	
	INTELLIGENT EYE Operation	—	—	Chargeless	10 m	10 m	
	Quick Warming Function (Preheating Operation)	—	○	Either Side Drain (Right or Left)	—	—	
	Hot-Start Function	—	○	Power Selection	—	—	
Operation	Automatic Defrosting	—	○	Remote Control	5-Rooms Centralized Controller (Option)	○	○
	Automatic Operation	—	○		Remote Control Adapter (Normal Open Pulse Contact) (Option)	○	○
	Program Dry Operation	○	○		Remote Control Adapter (Normal Open Contact) (Option)	○	○
Lifestyle Convenience	Fan Only	○	○	Remote Control	DIIII-NET Compatible (Adapter) (Option)	○	○
	New POWERFUL Operation (Non-Inverter)	—	—		Wireless	○	○
	Inverter POWERFUL Operation	○	○		Wired (Option)	○	○
	Priority-Room Setting	—	—				
	COOL / HEAT Mode Lock	—	—				
	HOME LEAVE Operation	○	○				
	ECONO Operation	—	—				
	Indoor Unit ON/OFF Button	○	○				
	Signal Receiving Sign	○	○				
Temperature Display	—	—					

Note: ○ : Holding Functions
— : No Functions

★ : Lower limit can be extended to -15°C by turning switch. (facility use only)

Category	Functions	FDKS50/60CVMB RKS50G2V1B, RKS60F3V1B	FDXS50/60CVMB RXS50G2V1B, RXS60F3V1B	Category	Functions	FDKS50/60CVMB RKS50G2V1B, RKS60F3V1B	FDXS50/60CVMB RXS50G2V1B, RXS60F3V1B	
Basic Function	Inverter (with Inverter Power Control)	○	○	Health & Clean	Air-Purifying Filter	—	—	
	Operation Limit for Cooling (°CDB)	-10 ~46★	-10 ~46		Photocatalytic Deodorizing Filter	—	—	
	Operation Limit for Heating (°CWB)	—	-15 ~18		Air-Purifying Filter with Photocatalytic Deodorizing Function	—	—	
	PAM Control	○	○		Titanium Apatite Photocatalytic Air-Purifying Filter	—	—	
Compressor	Oval Scroll Compressor	—	—	Air Filter (Prefilter)	○	○		
	Swing Compressor	○	○	Wipe-Clean Flat Panel	—	—		
	Rotary Compressor	—	—	Washable Grille	—	—		
	Reluctance DC Motor	○	○	Mold Proof Operation	—	—		
Comfortable Airflow	Power-Airflow Flap	—	—	Heating Dry Operation	—	—		
	Power-Airflow Dual Flaps	—	—	Good-Sleep Cooling Operation	—	—		
	Power-Airflow Diffuser	—	—	Timer	24-Hour ON/OFF TIMER	○	○	
	Wide-Angle Louvers	—	—		NIGHT SET Mode	○	○	
	Vertical Auto-Swing (Up and Down)	—	—	Worry Free "Reliability & Durability"	Auto-Restart (after Power Failure)	○	○	
	Horizontal Auto-Swing (Right and Left)	—	—		Self-Diagnosis (Digital, LED) Display	○	○	
3-D Airflow	—	—	Wiring Error Check		—	—		
Comfort Control	Auto Fan Speed	○	○	Anti-Corrosion Treatment of Outdoor Heat Exchanger	○	○		
	Indoor Unit Quiet Operation	○	○	Flexibility	Multi-Split / Split Type Compatible Indoor Unit	○	○	
	NIGHT QUIET Mode (Automatic)	—	—		Flexible Voltage Correspondence	—	—	
	OUTDOOR UNIT QUIET Operation (Manual)	○	○		High Ceiling Application	—	—	
	INTELLIGENT EYE Operation	—	—		Chargeless	10 m	10 m	
	Quick Warming Function (Preheating Operation)	—	○		Either Side Drain (Right or Left)	—	—	
	Hot-Start Function	—	○		Power Selection	—	—	
	Automatic Defrosting	—	○		Remote Control	5-Rooms Centralized Controller (Option)	○	○
Operation	Automatic Operation	—	○			Remote Control Adapter (Normal Open Pulse Contact) (Option)	○	○
	Program Dry Operation	○	○	Remote Control Adapter (Normal Open Contact) (Option)		○	○	
	Fan Only	○	○	DIII-NET Compatible (Adapter) (Option)	○	○		
	Lifestyle Convenience	New POWERFUL Operation (Non-Inverter)	—	—	Remote Control	Wireless	○	○
		Inverter POWERFUL Operation	○	○		Wired (Option)	○	○
		Priority-Room Setting	—	—				
		COOL / HEAT Mode Lock	—	—				
		HOME LEAVE Operation	○	○				
		ECONO Operation	—	—				
		Indoor Unit ON/OFF Button	○	○				
Signal Receiving Sign		○	○					
Temperature Display	—	—						

Note: ○ : Holding Functions
— : No Functions

★ : Lower limit can be extended to -15°C by turning switch. (facility use only)

Part 2

Specifications

1. Specifications	6
1.1 Cooling Only	6
1.2 Heat Pump	9

1. Specifications

1.1 Cooling Only

50 Hz, 230 V

Models	Indoor Units		FDKS50CVMB		FDKS60CVMB	
	Outdoor Units		RKS50E2(3)V1B		RKS60E2(3)V1B	
Capacity Rated (Min. ~ Max.)		kW	5.0 (2.0 ~ 5.3)		6.0 (2.0 ~ 6.5)	
		Btu/h	17,100 (6,800 ~ 18,100)		20,500 (6,800 ~ 22,200)	
		kcal/h	4,300 (1,720 ~ 4,560)		5,160 (1,720 ~ 5,590)	
Moisture Removal		L/h	2.9		3.9	
Running Current (Rated)		A	7.3		9.4	
Power Consumption Rated (Min. ~ Max.)		W	1,650 (500 ~ 1,930)		2,130 (500 ~ 2,490)	
Power Factor		%	98.3		98.5	
COP Rated (Min. ~ Max.)		W/W	3.03 (4.00 ~ 2.75)		2.82 (4.00 ~ 2.61)	
Piping Connections	Liquid	mm	φ 6.4		φ 6.4	
	Gas	mm	φ 12.7		φ 12.7	
	Drain	mm	VP20 (O.D. φ 26 / I.D. φ 20)		VP20 (O.D. φ 26 / I.D. φ 20)	
Heat Insulation			Both Liquid and Gas Pipes		Both Liquid and Gas Pipes	
Max. Interunit Piping Length		m	30		30	
Min. Interunit Piping Length		m	1.5		1.5	
Max. Interunit Height Difference		m	20		20	
Chargeless		m	10		10	
Amount of Additional Charge of Refrigerant		g/m	20		20	
Indoor Units			FDKS50CVMB		FDKS60CVMB	
External Static Pressure		Pa	40		40	
Airflow Rate	m ³ /min (cfm)	H	12.0 (424)		16.0 (565)	
		M	11.0 (388)		14.8 (523)	
		L	10.0 (353)		13.5 (477)	
		SL	8.4 (297)		11.2 (395)	
Fan	Type		Sirocco Fan		Sirocco Fan	
	Motor Output	W	130		130	
	Speed	Steps	5 Steps, Quiet, Auto		5 Steps, Quiet, Auto	
Air Direction Control			-		-	
Air Filter			Removable / Washable / Mildew Proof		Removable / Washable / Mildew Proof	
Running Current (Rated)		A	0.64		0.74	
Power Consumption (Rated)		W	140		160	
Power Factor		%	95.1		94.0	
Temperature Control			Microcomputer Control		Microcomputer Control	
Dimensions (H × W × D)		mm	200 × 900 × 620		200 × 1,100 × 620	
Packaged Dimensions (H × W × D)		mm	266 × 1,106 × 751		266 × 1,306 × 751	
Weight		kg	27		30	
Gross Weight		kg	34		37	
Operation Sound	H / M / L / SL	dBA	37 / 35 / 33 / 31		38 / 36 / 34 / 32	
Sound Power		dBA	55		56	
Outdoor Units			RKS50E2(3)V1B		RKS60E2(3)V1B	
Casing Color			Ivory White		Ivory White	
Compressor	Type		Hermetically Sealed Swing Type		Hermetically Sealed Swing Type	
	Model		2YC36BXD		2YC36BXD	
	Motor Output	W	1,100		1,100	
Refrigerant Oil	Type		FVC50K		FVC50K	
	Charge	L	0.65		0.65	
Refrigerant	Type		R-410A		R-410A	
	Charge	kg	1.50		1.50	
Airflow Rate	m ³ /min (cfm)	HH	50.9 (1,798)		54.2 (1,914)	
		H	48.9 (1,727)		50.9 (1,798)	
		L	41.7 (1,473)		45.0 (1,589)	
Fan	Type		Propeller		Propeller	
	Motor Output	W	53		53	
Running Current (Rated)		A	6.66		8.66	
Power Consumption (Rated)		W	1,510		1,970	
Power Factor		%	98.6		98.9	
Starting Current		A	7.3		9.4	
Dimensions (H × W × D)		mm	735 × 825 × 300		735 × 825 × 300	
Packaged Dimensions (H × W × D)		mm	797 × 960 × 390		797 × 960 × 390	
Weight		kg	47		47	
Gross Weight		kg	52		52	
Operation Sound	H / L	dBA	47 / 44		49 / 46	
Sound Power		dBA	61		63	
Conditions	Temperature		Indoor ; 27°CDB / 19°CWB Outdoor ; 35°CDB / 24°CWB		Indoor ; 27°CDB / 19°CWB Outdoor ; 35°CDB / 24°CWB	
	Piping Length		7.5		7.5	
Drawing No.			3D052134A		3D052135	

Conversion Formulae

kcal/h = kW × 860
Btu/h = kW × 3412
cfm = m³/min × 35.3

50 Hz, 230 V

Models	Indoor Units		FDKS50CVMB		FDKS60CVMB	
	Outdoor Units		RKS50F2V1B		RKS60F2V1B	
Capacity Rated (Min. ~ Max.)		kW	5.0 (1.7 ~ 5.3)		6.0 (1.7 ~ 6.5)	
		Btu/h	17,100 (5,800 ~ 18,100)		20,500 (5,800 ~ 22,200)	
		kcal/h	4,300 (1,460 ~ 4,560)		5,160 (1,460 ~ 5,590)	
Moisture Removal		L/h	2.9		3.9	
Running Current (Rated)		A	7.3		9.4	
Power Consumption Rated (Min. ~ Max.)		W	1,650 (440 ~ 1,930)		2,130 (440 ~ 2,490)	
Power Factor		%	98.3		98.5	
COP Rated (Min. ~ Max.)		W/W	3.03 (3.86 ~ 2.75)		2.82 (3.86 ~ 2.61)	
Piping Connections	Liquid	mm	φ 6.4		φ 6.4	
	Gas	mm	φ 12.7		φ 12.7	
	Drain	mm	VP20 (O.D. φ 26 / I.D. φ 20)		VP20 (O.D. φ 26 / I.D. φ 20)	
Heat Insulation			Both Liquid and Gas Pipes		Both Liquid and Gas Pipes	
Max. Interunit Piping Length		m	30		30	
Min. Interunit Piping Length		m	1.5		1.5	
Max. Interunit Height Difference		m	20		20	
Chargeless		m	10		10	
Amount of Additional Charge of Refrigerant		g/m	20		20	
Indoor Units			FDKS50CVMB		FDKS60CVMB	
External Static Pressure		Pa	40		40	
Airflow Rate	m ³ /min (cfm)	H	12.0 (424)		16.0 (565)	
		M	11.0 (388)		14.8 (523)	
		L	10.0 (353)		13.5 (477)	
		SL	8.4 (297)		11.2 (395)	
Fan	Type		Sirocco Fan		Sirocco Fan	
	Motor Output	W	130		130	
	Speed	Steps	5 Steps, Quiet, Auto		5 Steps, Quiet, Auto	
Air Direction Control			-		-	
Air Filter			Removable / Washable / Mildew Proof		Removable / Washable / Mildew Proof	
Running Current (Rated)		A	0.64		0.74	
Power Consumption (Rated)		W	140		160	
Power Factor		%	95.1		94.0	
Temperature Control			Microcomputer Control		Microcomputer Control	
Dimensions (H × W × D)		mm	200 × 900 × 620		200 × 1,100 × 620	
Packaged Dimensions (H × W × D)		mm	266 × 1,106 × 751		266 × 1,306 × 751	
Weight		kg	27		30	
Gross Weight		kg	34		37	
Operation Sound	H / M / L / SL	dBA	37 / 35 / 33 / 31		38 / 36 / 34 / 32	
Sound Power		dBA	55		56	
Outdoor Units			RKS50F2V1B		RKS60F2V1B	
Casing Color			Ivory White		Ivory White	
Compressor	Type		Hermetically Sealed Swing Type		Hermetically Sealed Swing Type	
	Model		2YC36BXD		2YC36BXD	
Refrigerant Oil	Motor Output	W	1,100		1,100	
	Type		FVC50K		FVC50K	
Refrigerant	Charge	L	0.65		0.65	
	Type		R-410A		R-410A	
Airflow Rate	m ³ /min (cfm)	HH	50.9 (1,798)		54.2 (1,914)	
		H	48.9 (1,727)		50.9 (1,798)	
		L	41.7 (1,473)		45.0 (1,589)	
		Type		Propeller		Propeller
Fan	Motor Output	W	53		53	
	Running Current (Rated)	A	6.66		8.66	
Power Consumption (Rated)		W	1,510		1,970	
Power Factor		%	98.6		98.9	
Starting Current		A	7.3		9.4	
Dimensions (H × W × D)		mm	735 × 825 × 300		735 × 825 × 300	
Packaged Dimensions (H × W × D)		mm	797 × 960 × 390		797 × 960 × 390	
Weight		kg	47		47	
Gross Weight		kg	52		52	
Operation Sound	H / L	dBA	47 / 44		49 / 46	
Sound Power	H	dBA	61		63	
Conditions	Temperature		Indoor ; 27°CDB / 19°CWB Outdoor ; 35°CDB / 24°CWB		Indoor ; 27°CDB / 19°CWB Outdoor ; 35°CDB / 24°CWB	
	Piping Length	m	7.5		7.5	
Drawing No.			3D057853		3D057855	

Conversion Formulae
kcal/h = kW × 860
Btu/h = kW × 3412
cfm = m ³ /min × 35.3

50 Hz, 230 V

Models	Indoor Units		FDKS50CVMB	FDKS60CVMB
	Outdoor Units		RKS50G2V1B	RKS60F3V1B
Capacity Rated (Min. ~ Max.)		kW	5.0 (1.7 ~ 5.3)	6.0 (1.7 ~ 6.5)
		Btu/h	17,100 (5,800 ~ 18,100)	20,500 (5,800 ~ 22,200)
		kcal/h	4,300 (1,460 ~ 4,560)	5,160 (1,460 ~ 5,590)
Moisture Removal		L/h	2.9	3.9
Running Current (Rated)		A	7.3	9.4
Power Consumption Rated (Min. ~ Max.)		W	1,650 (440 ~ 1,930)	2,130 (440 ~ 2,490)
Power Factor		%	98.3	98.5
COP Rated (Min. ~ Max.)		W/W	3.03 (3.86 ~ 2.75)	2.82 (3.86 ~ 2.61)
Piping Connections	Liquid	mm	φ 6.4	φ 6.4
	Gas	mm	φ 12.7	φ 12.7
	Drain	mm	VP20 (O.D. φ 26 / I.D. φ 20)	VP20 (O.D. φ 26 / I.D. φ 20)
Heat Insulation			Both Liquid and Gas Pipes	Both Liquid and Gas Pipes
Max. Interunit Piping Length		m	30	30
Min. Interunit Piping Length		m	1.5	1.5
Max. Interunit Height Difference		m	20	20
Chargeless		m	10	10
Amount of Additional Charge of Refrigerant		g/m	20	20
Indoor Units			FDKS50CVMB	FDKS60CVMB
External Static Pressure		Pa	40	40
Airflow Rate	m ³ /min (cfm)	H	12.0 (424)	16.0 (565)
		M	11.0 (388)	14.8 (523)
		L	10.0 (353)	13.5 (477)
		SL	8.4 (297)	11.2 (395)
Fan	Type		Sirocco Fan	Sirocco Fan
	Motor Output	W	130	130
	Speed	Steps	5 Steps, Quiet, Auto	5 Steps, Quiet, Auto
Air Direction Control			-	-
Air Filter			Removable / Washable / Mildew Proof	Removable / Washable / Mildew Proof
Running Current (Rated)		A	0.64	0.74
Power Consumption (Rated)		W	140	160
Power Factor		%	95.1	94.0
Temperature Control			Microcomputer Control	Microcomputer Control
Dimensions (H × W × D)		mm	200 × 900 × 620	200 × 1,100 × 620
Packaged Dimensions (H × W × D)		mm	266 × 1,106 × 751	266 × 1,306 × 751
Weight		kg	27	30
Gross Weight		kg	34	37
Operation Sound	H / M / L / SL	dBA	37 / 35 / 33 / 31	38 / 36 / 34 / 32
Sound Power		dBA	55	56
Outdoor Units			RKS50G2V1B	RKS60F3V1B
Casing Color			Ivory White	Ivory White
Compressor	Type		Hermetically Sealed Swing Type	Hermetically Sealed Swing Type
	Model		2YC36BXD	2YC36BXD
	Motor Output	W	1,100	1,100
Refrigerant Oil	Type		FVC50K	FVC50K
	Charge	L	0.65	0.65
Refrigerant	Type		R-410A	R-410A
	Charge	kg	1.70	1.50
Airflow Rate	m ³ /min (cfm)	HH	-	54.2 (1,914)
		H	50.9 (1,797)	50.9 (1,798)
		L	-	45.0 (1,589)
		SL	48.9 (1,727)	-
Fan	Type		Propeller	Propeller
	Motor Output	W	53	53
Running Current (Rated)		A	6.63	8.66
Power Consumption (Rated)		W	1,494	1,970
Power Factor		%	98.0	98.9
Starting Current		A	7.1	10.2
Dimensions (H × W × D)		mm	735 × 825 × 300	735 × 825 × 300
Packaged Dimensions (H × W × D)		mm	797 × 960 × 390	797 × 960 × 390
Weight		kg	47	48
Gross Weight		kg	52	53
Operation Sound	H / L	dBA	48 / 44	49 / 46
Sound Power	H	dBA	62	63
Conditions	Temperature		Indoor ; 27°CDB / 19°CWB Outdoor ; 35°CDB / 24°CWB	Indoor ; 27°CDB / 19°CWB Outdoor ; 35°CDB / 24°CWB
	Piping Length	m	5.0	7.5
Drawing No.			3D060040	3D065479

Conversion Formulae
kcal/h = kW × 860
Btu/h = kW × 3412
cfm = m ³ /min × 35.3

1.2 Heat Pump

50 Hz, 230 V

Models	Indoor Units		FDXS50CVMB		FDXS60CVMB	
	Outdoor Units		RXS50E2(3)V1B		RXS60E2(3)V1B	
			Cooling	Heating	Cooling	Heating
Capacity Rated (Min. ~ Max.)	kW		5.0 (2.0 ~ 5.3)	5.8 (2.0 ~ 6.0)	6.0 (2.0 ~ 6.5)	7.0 (2.0 ~ 8.0)
	Btu/h		17,100 (6,800 ~ 18,100)	19,800 (6,800 ~ 20,500)	20,500 (6,800 ~ 22,200)	23,900 (6,800 ~ 27,300)
	kcal/h		4,300 (1,720 ~ 4,560)	4,990 (1,720 ~ 5,160)	5,160 (1,720 ~ 5,590)	6,020 (1,720 ~ 6,880)
Moisture Removal	L/h		2.9	—	3.9	—
Running Current (Rated)	A		7.3	8.5	9.4	10.2
Power Consumption Rated (Min. ~ Max.)	W		1,650 (500 ~ 1,930)	1,920 (500 ~ 2,040)	2,130 (500 ~ 2,490)	2,320 (500 ~ 3,180)
Power Factor	%		98.3	98.2	98.5	98.9
COP Rated (Min. ~ Max.)	W/W		3.03 (4.00 ~ 2.75)	3.02 (4.00 ~ 2.94)	2.82 (4.00 ~ 2.61)	3.02 (4.00 ~ 2.52)
Piping Connections	Liquid	mm	φ 6.4		φ 6.4	
	Gas	mm	φ 12.7		φ 12.7	
	Drain	mm	VP20 (O.D. φ 26 / I.D. φ 20)		VP20 (O.D. φ 26 / I.D. φ 20)	
Heat Insulation			Both Liquid and Gas Pipes		Both Liquid and Gas Pipes	
Max. Interunit Piping Length	m		30		30	
Min. Interunit Piping Length	m		1.5		1.5	
Max. Interunit Height Difference	m		20		20	
Chargeless	m		10		10	
Amount of Additional Charge of Refrigerant	g/m		20		20	
Indoor Units			FDXS50CVMB		FDXS60CVMB	
External Static Pressure	Pa		40		40	
Airflow Rate	m ³ /min (cfm)	H	12.0 (424)	12.0 (424)	16.0 (565)	16.0 (565)
		M	11.0 (388)	11.0 (388)	14.8 (523)	14.8 (523)
		L	10.0 (353)	10.0 (353)	13.5 (477)	13.5 (477)
		SL	8.4 (297)	8.4 (297)	11.2 (395)	11.2 (395)
Fan	Type		Sirocco Fan		Sirocco Fan	
	Motor Output	W	130		130	
	Speed	Steps	5 Steps, Quiet, Auto		5 Steps, Quiet, Auto	
Air Direction Control		-		-		
Air Filter		Removable / Washable / Mildew Proof		Removable / Washable / Mildew Proof		
Running Current (Rated)	A		0.64	0.64	0.74	0.74
Power Consumption (Rated)	W		140	140	160	160
Power Factor	%		95.1	95.1	94.0	94.0
Temperature Control			Microcomputer Control		Microcomputer Control	
Dimensions (H × W × D)	mm		200 × 900 × 620		200 × 1,100 × 620	
Packaged Dimensions (H × W × D)	mm		266 × 1,106 × 751		266 × 1,306 × 751	
Weight	kg		27		30	
Gross Weight	kg		34		37	
Operation Sound	H / M / L / SL	dBA	37 / 35 / 33 / 31	37 / 35 / 33 / 31	38 / 36 / 34 / 32	38 / 36 / 34 / 32
Sound Power		dBA	55	55	56	56
Outdoor Units			RXS50E2(3)V1B		RXS60E2(3)V1B	
Casing Color			Ivory White		Ivory White	
Compressor	Type		Hermetically Sealed Swing Type		Hermetically Sealed Swing Type	
	Model		2YC36BXD		2YC36BXD	
	Motor Output	W	1,100		1,100	
Refrigerant Oil	Type		FVC50K		FVC50K	
	Charge	L	0.65		0.65	
Refrigerant	Type		R-410A		R-410A	
	Charge	kg	1.50		1.50	
Airflow Rate	m ³ /min (cfm)	HH	50.9 (1,798)	—	54.2 (1,914)	—
		H	48.9 (1,727)	45.0 (1,589)	50.9 (1,798)	46.3 (1,635)
		L	41.7 (1,473)	45.0 (1,589)	45.0 (1,589)	46.3 (1,635)
Fan	Type		Propeller		Propeller	
	Motor Output	W	53		53	
Running Current (Rated)	A		6.66	7.86	8.66	9.46
Power Consumption (Rated)	W		1,510	1,780	1,970	2,160
Power Factor	%		98.6	98.5	98.9	99.3
Starting Current	A		8.5		10.2	
Dimensions (H × W × D)	mm		735 × 825 × 300		735 × 825 × 300	
Packaged Dimensions (H × W × D)	mm		797 × 960 × 390		797 × 960 × 390	
Weight	kg		48		48	
Gross Weight	kg		53		53	
Operation Sound	H / L	dBA	47 / 44	48 / 45	49 / 46	49 / 46
Sound Power	H	dBA	61	62	63	63
Conditions	Temperature		Indoor; 27°CDB/19°CWB Outdoor; 35°CDB/24°CWB	Indoor; 20°CDB Outdoor; 7°CDB / 6°CWB	Indoor; 27°CDB/19°CWB Outdoor; 35°CDB/24°CWB	Indoor; 20°CDB Outdoor; 7°CDB / 6°CWB
	Piping Length	m	7.5		7.5	
Drawing No.			3D052132		3D052133	

Conversion Formulae

kcal/h = kW × 860
 Btu/h = kW × 3412
 cfm = m³/min × 35.3

50 Hz, 230 V

Models	Indoor Units		FDXS50CVMB		FDXS60CVMB	
	Outdoor Units		RXS50F2V1B		RXS60F2V1B	
			Cooling	Heating	Cooling	Heating
Capacity Rated (Min. ~ Max.)	kW		5.0 (1.7 ~ 5.3)	5.8 (1.7 ~ 6.0)	6.0 (1.7 ~ 6.5)	7.0 (1.7 ~ 8.0)
	Btu/h		17,100 (5,800 ~ 18,100)	19,800 (5,800 ~ 20,500)	20,500 (5,800 ~ 22,200)	23,900 (5,800 ~ 27,300)
	kcal/h		4,300 (1,460 ~ 4,560)	4,990 (1,460 ~ 5,160)	5,160 (1,460 ~ 5,590)	6,020 (1,460 ~ 6,880)
Moisture Removal	L/h		2.9	—	3.9	—
Running Current (Rated)	A		7.3	8.5	9.4	10.2
Power Consumption Rated (Min. ~ Max.)	W		1,650 (440 ~ 1,930)	1,920 (400 ~ 2,040)	2,130 (440 ~ 2,490)	2,320 (400 ~ 3,180)
Power Factor	%		98.3	98.2	98.5	98.9
COP Rated (Min. ~ Max.)	W/W		3.03 (3.86 ~ 2.75)	3.02 (4.25 ~ 2.94)	2.82 (3.86 ~ 2.61)	3.02 (4.25 ~ 2.52)
Piping Connections	Liquid	mm	φ 6.4		φ 6.4	
	Gas	mm	φ 12.7		φ 12.7	
	Drain	mm	VP20 (O.D. φ 26 / I.D. φ 20)		VP20 (O.D. φ 26 / I.D. φ 20)	
Heat Insulation			Both Liquid and Gas Pipes		Both Liquid and Gas Pipes	
Max. Interunit Piping Length	m		30	30	30	30
Min. Interunit Piping Length	m		1.5	1.5	1.5	1.5
Max. Interunit Height Difference	m		20	20	20	20
Chargeless	m		10	10	10	10
Amount of Additional Charge of Refrigerant	g/m		20	20	20	20
Indoor Units			FDXS50CVMB		FDXS60CVMB	
External Static Pressure		Pa	40		40	
Airflow Rate	m³/min (cfm)	H	12.0 (424)	12.0 (424)	16.0 (565)	16.0 (565)
		M	11.0 (388)	11.0 (388)	14.8 (523)	14.8 (523)
		L	10.0 (353)	10.0 (353)	13.5 (477)	13.5 (477)
		SL	8.4 (297)	8.4 (297)	11.2 (395)	11.2 (395)
Fan	Type		Sirocco Fan		Sirocco Fan	
	Motor Output	W	130		130	
	Speed	Steps	5 Steps, Quiet, Auto		5 Steps, Quiet, Auto	
Air Direction Control			—		—	
Air Filter			Removable / Washable / Mildew Proof		Removable / Washable / Mildew Proof	
Running Current (Rated)	A		0.64	0.64	0.74	0.74
Power Consumption (Rated)	W		140	140	160	160
Power Factor	%		95.1	95.1	94.0	94.0
Temperature Control			Microcomputer Control		Microcomputer Control	
Dimensions (H × W × D)	mm		200 × 900 × 620		200 × 1,100 × 620	
Packaged Dimensions (H × W × D)	mm		266 × 1,106 × 751		266 × 1,306 × 751	
Weight	kg		27		30	
Gross Weight	kg		34		37	
Operation Sound	H / M / L / SL	dBA	37 / 35 / 33 / 31	37 / 35 / 33 / 31	38 / 36 / 34 / 32	38 / 36 / 34 / 32
Sound Power		dBA	55	55	56	56
Outdoor Units			RXS50F2V1B		RXS60F2V1B	
Casing Color			Ivory White		Ivory White	
Compressor	Type		Hermetically Sealed Swing Type		Hermetically Sealed Swing Type	
	Model		2YC36BXD		2YC36BXD	
	Motor Output	W	1,100		1,100	
Refrigerant Oil	Type		FVC50K		FVC50K	
	Charge	L	0.65		0.65	
Refrigerant	Type		R-410A		R-410A	
	Charge	kg	1.50		1.50	
Airflow Rate	m³/min (cfm)	HH	50.9 (1,798)	—	54.2 (1,914)	—
		H	48.9 (1,727)	45.0 (1,589)	50.9 (1,798)	46.3 (1,635)
		L	41.7 (1,473)	45.0 (1,589)	45.0 (1,589)	46.3 (1,635)
Fan	Type		Propeller		Propeller	
	Motor Output	W	53		53	
Running Current (Rated)	A		6.66	7.86	8.66	9.46
Power Consumption (Rated)	W		1,510	1,780	1,970	2,160
Power Factor	%		98.6	98.5	98.9	99.3
Starting Current	A		8.5		10.2	
Dimensions (H × W × D)	mm		735 × 825 × 300		735 × 825 × 300	
Packaged Dimensions (H × W × D)	mm		797 × 960 × 390		797 × 960 × 390	
Weight	kg		48		48	
Gross Weight	kg		53		53	
Operation Sound	H / L	dBA	47 / 44	48 / 45	49 / 46	49 / 46
Sound Power	H	dBA	61	62	63	63
Conditions	Temperature		Indoor; 27°CDB/19°CWB Outdoor; 35°CDB/24°CWB	Indoor; 20°CDB Outdoor; 7°CDB / 6°CWB	Indoor; 27°CDB/19°CWB Outdoor; 35°CDB/24°CWB	Indoor; 20°CDB Outdoor; 7°CDB / 6°CWB
	Piping Length	m	7.5		7.5	
Drawing No.			3D057852		3D057854	

Conversion Formulae
kcal/h = kW × 860
Btu/h = kW × 3412
cfm = m³/min × 35.3

50 Hz, 230 V

Models	Indoor Units		FDXS50CVMB		FDXS60CVMB	
	Outdoor Units		RXS50G2V1B		RXS60F3V1B	
			Cooling	Heating	Cooling	Heating
Capacity Rated (Min. ~ Max.)	kW		5.0 (1.7 ~ 5.3)	5.8 (1.7 ~ 6.0)	6.0 (1.7 ~ 6.5)	7.0 (1.7 ~ 8.0)
	Btu/h		17,100 (5,800 ~ 18,100)	19,800 (5,800 ~ 20,500)	20,500 (5,800 ~ 22,200)	23,900 (5,800 ~ 27,300)
	kcal/h		4,300 (1,460 ~ 4,560)	4,990 (1,460 ~ 5,160)	5,160 (1,460 ~ 5,590)	6,020 (1,460 ~ 6,880)
Moisture Removal	L/h		2.9	—	3.9	—
Running Current (Rated)	A		7.3	8.5	9.4	10.2
Power Consumption Rated (Min. ~ Max.)	W		1,650 (440 ~ 1,930)	1,920 (400 ~ 2,040)	2,130 (440 ~ 2,490)	2,320 (400 ~ 3,180)
Power Factor	%		98.3	98.2	98.5	98.9
COP Rated (Min. ~ Max.)	W/W		3.03 (3.86 ~ 2.75)	3.02 (4.25 ~ 2.94)	2.82 (3.86 ~ 2.61)	3.02 (4.25 ~ 2.52)
Piping Connections	Liquid	mm	φ 6.4		φ 6.4	
	Gas	mm	φ 12.7		φ 12.7	
	Drain	mm	VP20 (O.D. φ 26 / I.D. φ 20)		VP20 (O.D. φ 26 / I.D. φ 20)	
Heat Insulation			Both Liquid and Gas Pipes		Both Liquid and Gas Pipes	
Max. Interunit Piping Length	m		30		30	
Min. Interunit Piping Length	m		1.5		1.5	
Max. Interunit Height Difference	m		20		20	
Chargeless	m		10		10	
Amount of Additional Charge of Refrigerant	g/m		20		20	
Indoor Units		FDXS50CVMB		FDXS60CVMB		
External Static Pressure	Pa		40		40	
Airflow Rate	m³/min (cfm)	H	12.0 (424)	12.0 (424)	16.0 (565)	16.0 (565)
		M	11.0 (388)	11.0 (388)	14.8 (523)	14.8 (523)
		L	10.0 (353)	10.0 (353)	13.5 (477)	13.5 (477)
		SL	8.4 (297)	8.4 (297)	11.2 (395)	11.2 (395)
Fan	Type		Sirocco Fan		Sirocco Fan	
	Motor Output	W	130		130	
	Speed	Steps	5 Steps, Quiet, Auto		5 Steps, Quiet, Auto	
Air Direction Control			—		—	
Air Filter			Removable / Washable / Mildew Proof		Removable / Washable / Mildew Proof	
Running Current (Rated)	A		0.64	0.64	0.74	0.74
Power Consumption (Rated)	W		140	140	160	160
Power Factor	%		95.1	95.1	94.0	94.0
Temperature Control			Microcomputer Control		Microcomputer Control	
Dimensions (H × W × D)	mm		200 × 900 × 620		200 × 1,100 × 620	
Packaged Dimensions (H × W × D)	mm		266 × 1,106 × 751		266 × 1,306 × 751	
Weight	kg		27		30	
Gross Weight	kg		34		37	
Operation Sound	H / M / L / SL	dBA	37 / 35 / 33 / 31	37 / 35 / 33 / 31	38 / 36 / 34 / 32	38 / 36 / 34 / 32
Sound Power		dBA	55	55	56	56
Outdoor Units		RXS50G2V1B		RXS60F3V1B		
Casing Color			Ivory White		Ivory White	
Compressor	Type		Hermetically Sealed Swing Type		Hermetically Sealed Swing Type	
	Model		2YC36BXD		2YC36BXD	
	Motor Output	W	1,100		1,100	
Refrigerant Oil	Type		FVC50K		FVC50K	
	Charge	L	0.65		0.65	
Refrigerant	Type		R-410A		R-410A	
	Charge	kg	1.70		1.50	
Airflow Rate	m³/min (cfm)	HH	—	—	54.2 (1,914)	—
		H	50.9 (1,798)	45.0 (1,589)	50.9 (1,798)	46.3 (1,635)
		L	—	—	45.0 (1,589)	46.3 (1,635)
		SL	48.9 (1,727)	43.1 (1,522)	—	—
Fan	Type		Propeller		Propeller	
	Motor Output	W	53		53	
Running Current (Rated)	A		6.63	6.82	8.66	9.46
Power Consumption (Rated)	W		1,494	1,538	1,970	2,160
Power Factor	%		98.0	98.0	98.9	99.3
Starting Current	A		7.3		10.2	
Dimensions (H × W × D)	mm		735 × 825 × 300		735 × 825 × 300	
Packaged Dimensions (H × W × D)	mm		797 × 960 × 390		797 × 960 × 390	
Weight	kg		48		48	
Gross Weight	kg		53		53	
Operation Sound	H / L	dBA	48 / 44	48 / 45	49 / 46	49 / 46
Sound Power	H	dBA	62	62	63	63
Conditions	Temperature		Indoor; 27°CDB/19°CWB Outdoor; 35°CDB/24°CWB	Indoor; 20°CDB Outdoor; 7°CDB / 6°CWB	Indoor; 27°CDB/19°CWB Outdoor; 35°CDB/24°CWB	Indoor; 20°CDB Outdoor; 7°CDB / 6°CWB
	Piping Length	m	5.0		7.5	
Drawing No.			3D060033		3D065477	

Conversion Formulae
kcal/h = kW × 860
Btu/h = kW × 3412
cfm = m³/min × 35.3

Part 3

Printed Circuit Board

Connector Wiring Diagram

1. Printed Circuit Board Connector Wiring Diagram.....	13
1.1 Indoor Unit.....	13
1.2 Outdoor Unit.....	15

1. Printed Circuit Board Connector Wiring Diagram

1.1 Indoor Unit

Connectors and Other Parts

PCB(1): Control PCB

1) S1	Connector for AC fan motor
2) S7	Connector for AC fan motor (Hall IC)
3) S21	Connector for centralized control (HA)
4) S26	Connector for display PCB
5) S32	Connector for indoor heat exchanger thermistor
6) H1, H2, H3	Connector for terminal board
7) GND	Connector for terminal board (earth)
8) JA	Address setting jumper
	* Refer to page 127 for detail.
JB	Fan speed setting when compressor stops for thermostat OFF
JC	Power failure recovery function (auto-restart)
	* Refer to page 128 for more detail.
9) LED A	LED for service monitor (green)
10) FU1(F1U)	Fuse (3.15A, 250V)
11) V1(V1TR)	Varistor

PCB(2): Display PCB

1) S1	Connector for control PCB
2) SW1 (S1W)	Forced operation ON/OFF button
3) LED1 (H1P)	LED for HOME LEAVE operation (red)
4) LED2 (H2P)	LED for timer (yellow)
5) LED3 (H3P)	LED for operation (green)
6) RTH1 (R1T)	Room temperature thermistor

PCB Detail

PCB (1): Control PCB

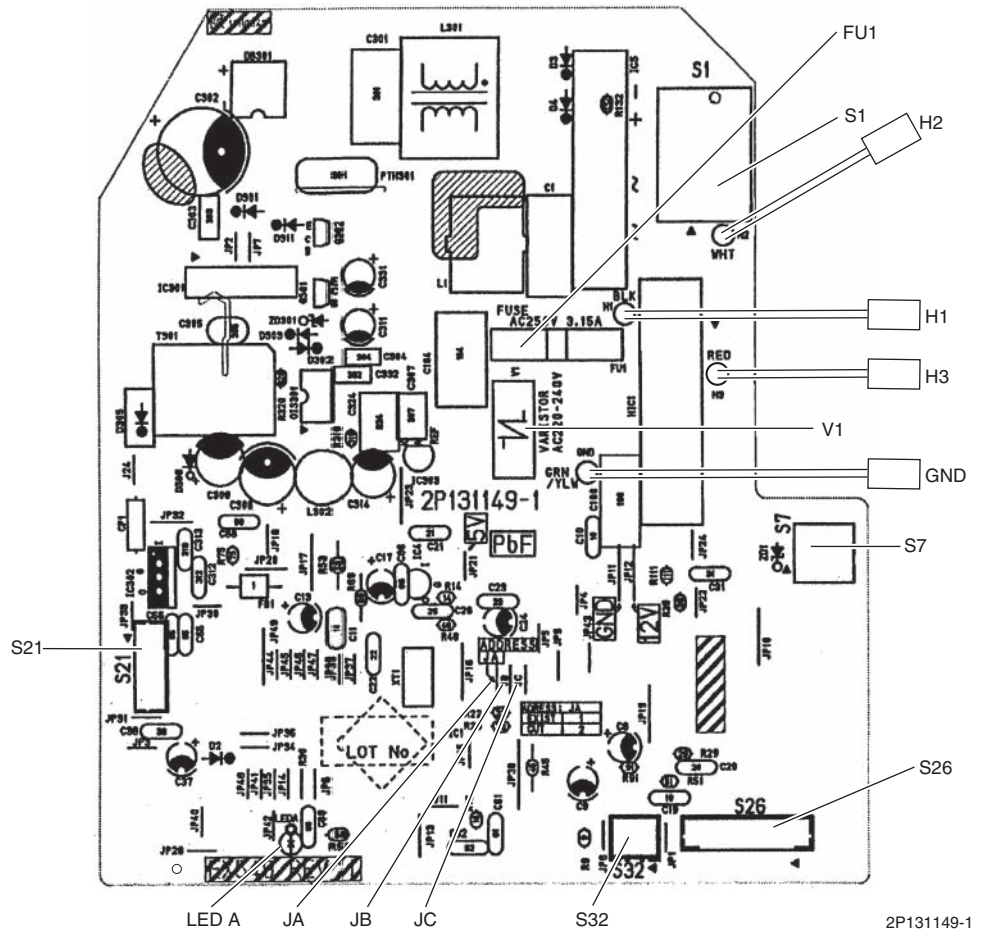

PCB (2): Display PCB

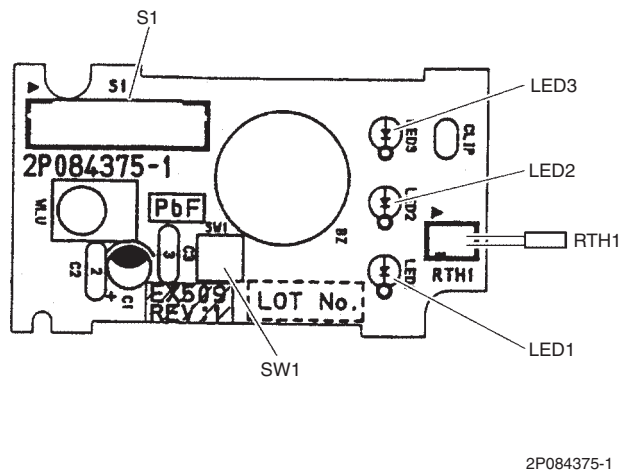

1.2 Outdoor Unit

Connectors and Other Parts

PCB (1): Main PCB

1) S10	Connector for terminal board (indoor - outdoor transmission)
2) S20	Connector for electronic expansion valve coil
3) S40	Connector for overload protector
4) S51, S101	Connector for service monitor PCB
5) S70	Connector for fan motor
6) S80	Connector for four way valve coil
7) S90	Connector for thermistors (outdoor temperature, outdoor heat exchanger, discharge pipe)
8) AC1, AC2	Connector for terminal board (power supply)
9) HR1, HR2	Connector for reactor
10) E1, E2	Connector for earth
11) U, V, W	Connector for compressor
12) FU1	Fuse (30 A, 250 V)
13) FU2, FU3	Fuse (3.15 A, 250 V)
14) V2, V3, V5, V6, V11	Varistor

PCB (2): Service Monitor PCB

1) S52, S102	Connector for main PCB
2) LED A	LED for service monitor (green)
3) SW1	Forced operation ON/OFF button
4) SW4-B	Switch for facility setting * Refer to page 128 for detail.
5) SW4-C	Switch for improvement of defrost performance * Refer to page 128 for detail.

PCB Detail

PCB (1): Main PCB

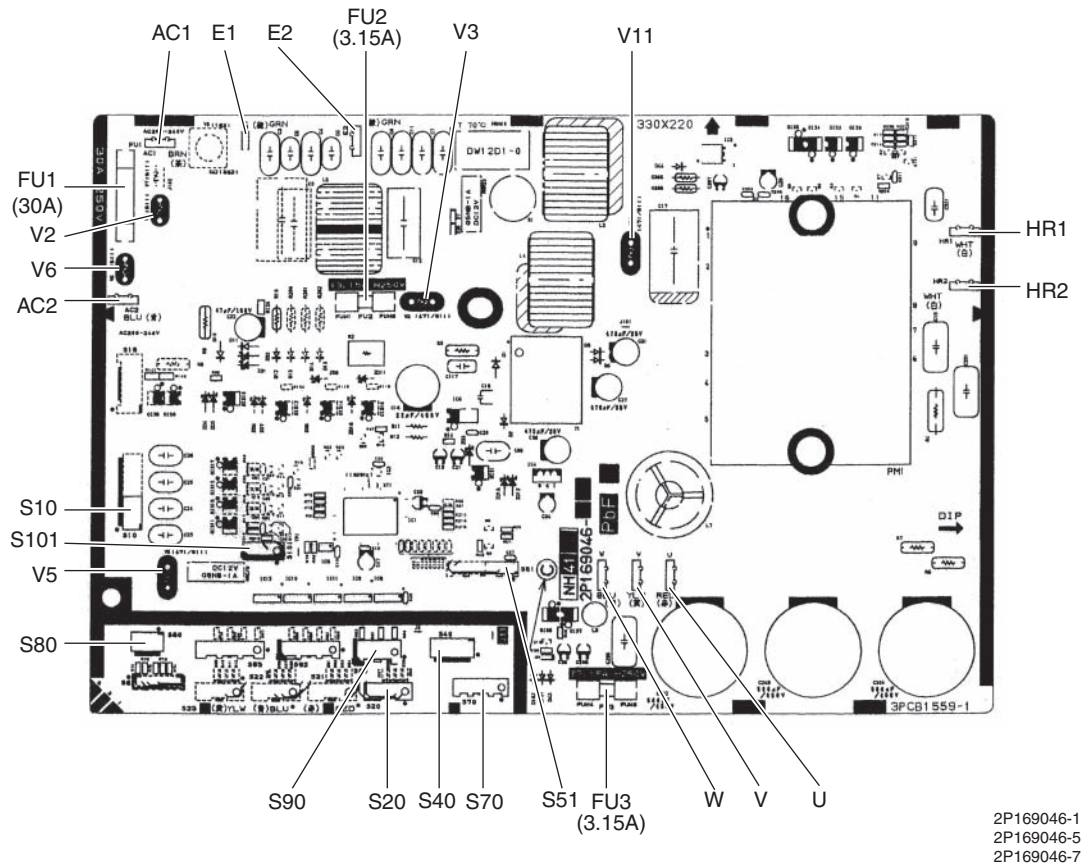

PCB (2): Service Monitor PCB

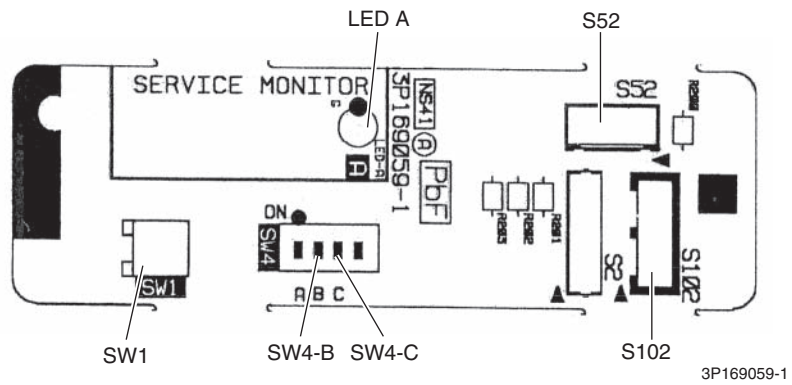

Part 4

Function and Control

1. Main Functions	18
1.1 Temperature Control	18
1.2 Frequency Principle.....	18
1.3 Fan Speed Control for Indoor Units.....	20
1.4 Program Dry Operation	21
1.5 Automatic Operation.....	22
1.6 Thermostat Control.....	23
1.7 NIGHT SET Mode	24
1.8 HOME LEAVE Operation	25
1.9 Inverter POWERFUL Operation	26
1.10 Other Functions.....	27
2. Function of Thermistor	28
3. Control Specification	29
3.1 Mode Hierarchy	29
3.2 Frequency Control.....	30
3.3 Controls at Mode Changing / Start-up.....	32
3.4 Discharge Pipe Temperature Control.....	33
3.5 Input Current Control.....	34
3.6 Freeze-up Protection Control	35
3.7 Heating Peak-cut Control	35
3.8 Outdoor Fan Control.....	36
3.9 Liquid Compression Protection Function.....	36
3.10 Defrost Control	37
3.11 Electronic Expansion Valve Control	38
3.12 Malfunctions	41
3.13 Forced Operation Mode	42

1. Main Functions

1.1 Temperature Control

Definitions of Temperatures

The definitions of temperatures are classified as following.

- ◆ Room temperature: temperature of lower part of the room
- ◆ Set temperature: temperature set by remote control
- ◆ Room thermistor temperature: temperature detected by room temperature thermistor
- ◆ Target temperature: temperature determined by microcomputer

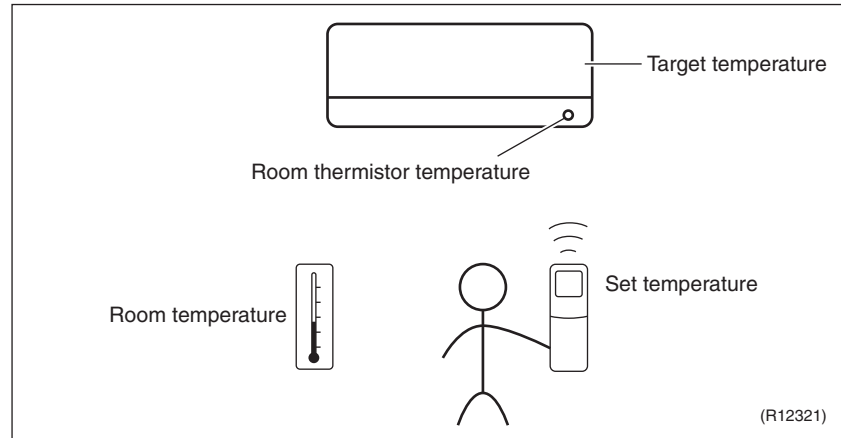

★ The illustration is for wall mounted type as representative.

Temperature Control

The temperature of the room is detected by the room temperature thermistor. However, there is difference between the “temperature detected by room temperature thermistor” and the “temperature of lower part of the room”, depending on the type of the indoor unit or installation condition. Practically, the temperature control is done by the “target temperature appropriately adjusted for the indoor unit” and the “temperature detected by room temperature thermistor”.

1.2 Frequency Principle

Main Control Parameters

The compressor is frequency-controlled during normal operation. The target frequency is set by the following 2 parameters coming from the operating indoor unit:

- The load condition of the operating indoor unit
- The difference between the room thermistor temperature and the target temperature

Additional Control Parameters

The target frequency is adapted by additional parameters in the following cases:

- Frequency restrictions
- Initial settings
- Forced cooling operation

Inverter Principle

To regulate the capacity, a frequency control is needed. The inverter makes it possible to vary the rotation speed of the compressor. The following table explains the conversion principle:

Phase	Description
1	The supplied AC power source is converted into the DC power source for the present.
2	The DC power source is reconverted into the three phase AC power source with variable frequency. <ul style="list-style-type: none"> ■ When the frequency increases, the rotation speed of the compressor increases resulting in an increased refrigerant circulation. This leads to a higher amount of the heat exchange per unit. ■ When the frequency decreases, the rotation speed of the compressor decreases resulting in a decreased refrigerant circulation. This leads to a lower amount of the heat exchange per unit.

Drawing of Inverter

The following drawing shows a schematic view of the inverter principle:

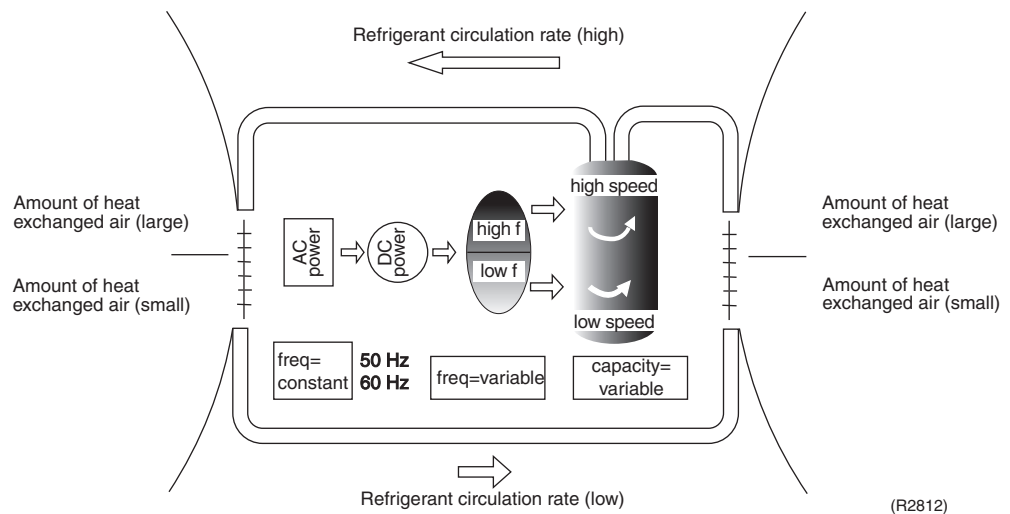

Inverter Features

The inverter provides the following features:

- The regulating capacity can be changed according to the changes in the outdoor temperature and cooling / heating load.
- Quick heating and quick cooling
The compressor rotational speed is increased when starting the heating (or cooling). This enables to reach the set temperature quickly.
- Even during extreme cold weather, the high capacity is achieved. It is maintained even when the outdoor temperature is 2°C.
- Comfortable air conditioning
A fine adjustment is integrated to keep the room temperature constant.
- Energy saving heating and cooling
Once the set temperature is reached, the energy saving operation enables to maintain the room temperature at low power.

Frequency Limits

The following functions regulate the minimum and maximum frequency:

Frequency	Functions
Low	<ul style="list-style-type: none"> ■ Four way valve operation compensation. Refer to page 32.
High	<ul style="list-style-type: none"> ■ Compressor protection function. Refer to page 33. ■ Discharge pipe temperature control. Refer to page 33. ■ Input current control. Refer to page 34. ■ Freeze-up protection control. Refer to page 35. ■ Heating peak-cut control. Refer to page 35. ■ Defrost control. Refer to page 37.

Forced Cooling Operation

Refer to "Forced operation mode" on page 42 for detail.

1.3 Fan Speed Control for Indoor Units

Outline

Phase control and fan speed control contains 9 steps: LLL, LL, SL, L, ML, M, MH, H, and HH. The airflow rate can be automatically controlled depending on the difference between the room thermistor temperature and the target temperature. This is done through phase control and Hall IC control.



For more information about Hall IC, refer to the troubleshooting for fan motor on page 64.

Automatic Fan Speed Control

In automatic fan speed operation, the step "SL" is not available.

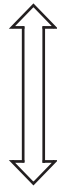
Step	Cooling	Heating
LLL	 (R11505)	 (R6834)
LL		
L		
ML		
M		
MH		
H		
HH (POWERFUL)		

 = The airflow rate is automatically controlled within this range when the FAN setting button is set to automatic.

<Cooling>

The following drawing explains the principle of fan speed control for cooling.

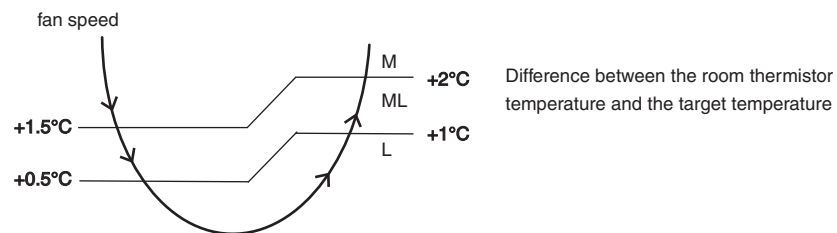

(R12390)

<Heating>

On heating mode, the fan speed is regulated according to the indoor heat exchanger temperature and the difference between the room thermistor temperature and the target temperature.



- Note:**
1. During POWERFUL operation, the fan rotates at H tap + 50 rpm.
 2. The fan stops during defrost operation.

1.4 Program Dry Operation

Outline

Program dry operation removes humidity while preventing the room temperature from lowering. Since the microcomputer controls both the temperature and airflow rate, the temperature adjustment and fan adjustment buttons are inoperable in this mode.

Detail

The microcomputer automatically sets the temperature and airflow rate. The difference between the room thermistor temperature at start-up and the target temperature is divided into two zones. Then, the unit operates in the dry mode with an appropriate capacity for each zone to maintain the temperature and humidity at a comfortable level.

Room thermistor temperature at start-up	Target temperature X	Thermostat OFF point Y	Thermostat ON point Z
24°C or more	Room thermistor temperature at start-up	$X - 2.5^{\circ}\text{C}$	$X - 0.5^{\circ}\text{C}$ or $Y + 0.5^{\circ}\text{C}$ (zone B) continues for 10 min.
23.5°C ∴ 18°C		$X - 2.0^{\circ}\text{C}$	$X - 0.5^{\circ}\text{C}$ or $Y + 0.5^{\circ}\text{C}$ (zone B) continues for 10 min.
17.5°C ∴	18°C	$X - 2.0^{\circ}\text{C}$	$X - 0.5^{\circ}\text{C} = 17.5^{\circ}\text{C}$ or $Y + 0.5^{\circ}\text{C}$ (zone B) continues for 10 min.

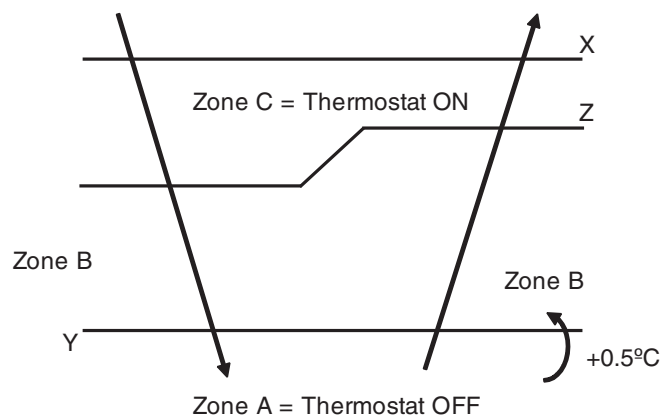

(R11581)

1.5 Automatic Operation

Outline

Automatic Cooling / Heating Function

When the AUTO mode is selected with the remote control, the microcomputer automatically determines the operation mode as cooling or heating according to the room temperature and the set temperature at start-up, and automatically operates in that mode.

The unit automatically switches the operation mode to maintain the room temperature at the set temperature.

Detail

Ts: set temperature (set by remote control)

Tt: target temperature (determined by microcomputer)

Tr: room thermistor temperature (detected by room temperature thermistor)

C: correction value

- The set temperature (Ts) determines the target temperature (Tt).
(Ts = 18 ~ 30°C).
- The target temperature (Tt) is calculated as;
 $Tt = Ts + C$
where C is the correction value.
C = 0°C
- Thermostat ON/OFF point and mode switching point are as follows.
Tr means the room thermistor temperature.
 - Heating → Cooling switching point:
 $Tr \geq Tt + 2.5^\circ\text{C}$
 - Cooling → Heating switching point:
 $Tr < Tt - 2.5^\circ\text{C}$
 - Thermostat ON/OFF point is the same as the ON/OFF point of cooling or heating operation.
- During initial operation
 - $Tr \geq Ts$: Cooling operation
 - $Tr < Ts$: Heating operation

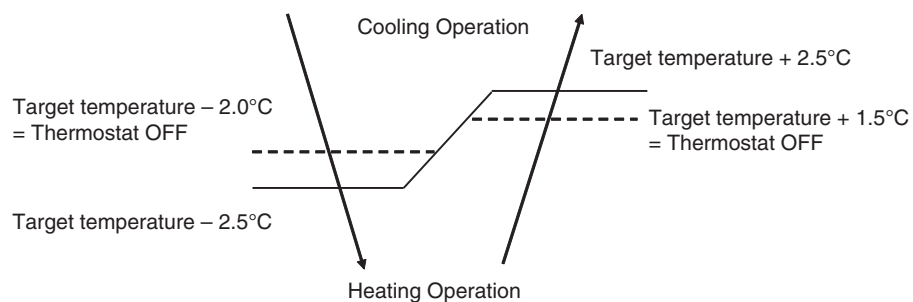

(R11893)

Ex: When the target temperature is 25°C

Cooling → 23°C: Thermostat OFF → 22°C: Switch to heating

Heating → 26.5°C: Thermostat OFF → 27.5°C: Switch to cooling

1.6 Thermostat Control

Thermostat control is based on the difference between the room thermistor temperature and the target temperature.

Thermostat OFF Condition

- ◆ The temperature difference is in the zone A.

Thermostat ON Condition

- ◆ The temperature difference returns to the zone C after being in the zone A.
- ◆ The system resumes from defrost control in any zones except A.
- ◆ The operation turns on in any zones except A.
- ◆ The monitoring time has passed while the temperature difference is in the zone B.
(Cooling / Dry : 10 minutes, Heating : 10 seconds)

Cooling / Dry

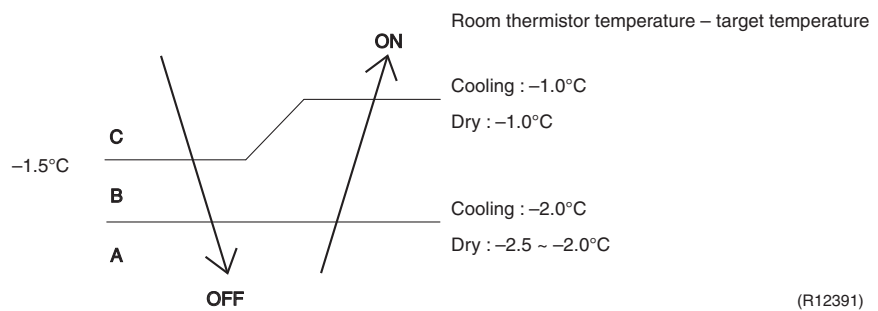

Heating

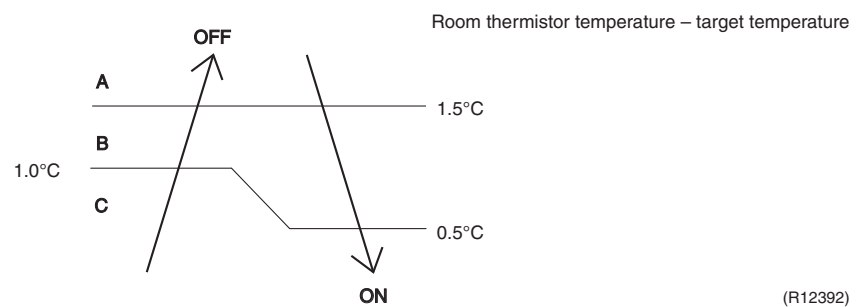

Refer to "Temperature Control" on page 18 for detail.

1.7 NIGHT SET Mode

Outline

When the OFF timer is set, the NIGHT SET Mode is automatically activated. The NIGHT SET Mode keeps the airflow rate setting.

Detail

The NIGHT SET Mode continues operation at the target temperature for the first one hour, then automatically raises the target temperature slightly in the case of cooling, or lowers it slightly in the case of heating. This prevents excessive cooling in summer and excessive heating in winter to ensure comfortable sleeping conditions, and also conserves electricity.

Cooling

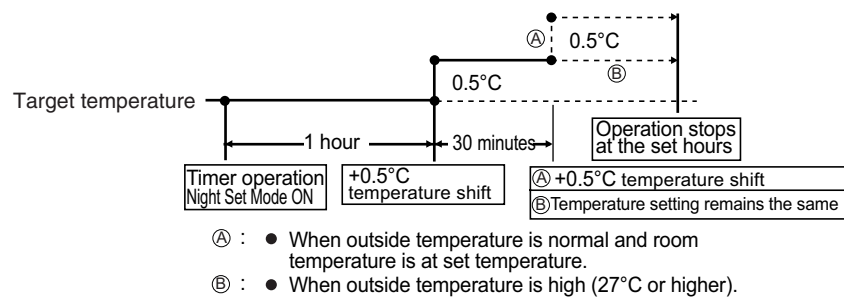

Heating

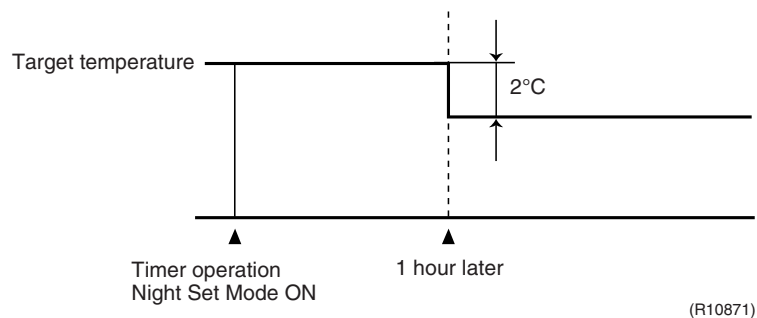

1.8 HOME LEAVE Operation

Outline

HOME LEAVE operation is a function that allows you to record your favorite set temperature and airflow rate. You can start your favorite operation mode simply by pressing the [HOME LEAVE] button on the remote control.

Detail

1. Start of Function

The function starts when the [HOME LEAVE] button is pressed in cooling mode, heating mode (including POWERFUL operation), or while the operation is stopped. If this button is pressed in POWERFUL operation, the POWERFUL operation is canceled and this function becomes effective.

- The [HOME LEAVE] button is ineffective in dry mode and fan mode.

2. Details of Function

A mark representing HOME LEAVE is indicated on the display of the remote control. The indoor unit is operated according to the set temperature and airflow rate for HOME LEAVE which were pre-set in the memory of the remote control.

The LED (red) of indoor unit representing HOME LEAVE lights up. (It goes out when the operation is stopped.)

3. End of Function

The function ends when the [HOME LEAVE] button is pressed again during HOME LEAVE operation or when the [POWERFUL] button is pressed.

<Cooling>



“HOME LEAVE operation”
set temp.



<Heating>



Set temp.
“HOME LEAVE operation”
set temp.



Others

The set temperature and airflow rate are memorized in the remote control. When the remote control is reset due to replacement of battery, it is necessary to set the temperature and airflow rate again for HOME LEAVE operation.

1.9 Inverter POWERFUL Operation

Outline

In order to exploit the cooling and heating capacity to full extent, operate the air conditioner by increasing the indoor fan rotating speed and the compressor frequency.

Detail

When POWERFUL button is pressed, the fan speed and target temperature are converted to the following states for 20 minutes.

Operation mode	Fan speed	Target temperature
COOL	H tap + 50 rpm	18°C
DRY	Dry rotating speed + 50 rpm	Lowered by 2.5°C
HEAT	H tap + 50 rpm	30°C
FAN	H tap + 50 rpm	—
AUTO	Same as cooling / heating in POWERFUL operation	The target temperature is kept unchanged.

Ex.) : POWERFUL operation in cooling mode.

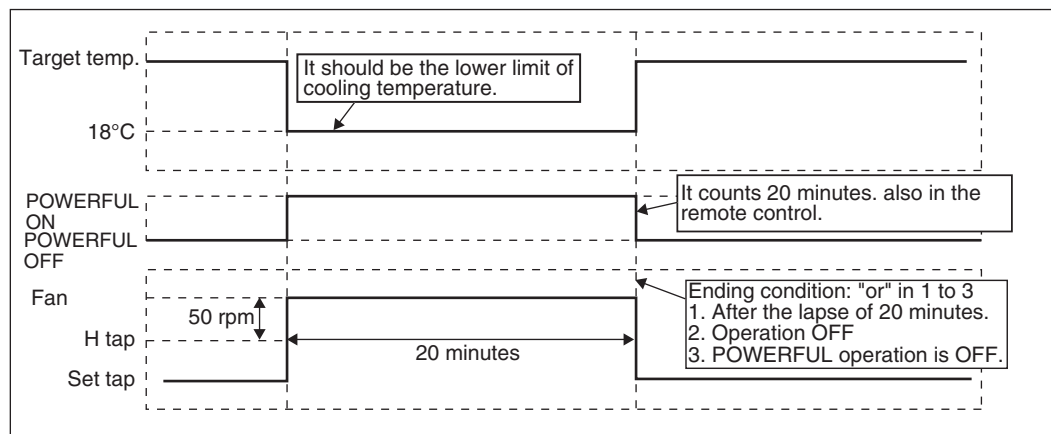

1.10 Other Functions

1.10.1 Hot-Start Function

In order to prevent the cold air blast that normally comes when heating operation is started, the temperature of the indoor heat exchanger is detected, and either the airflow is stopped or is made very weak thereby carrying out comfortable heating of the room.

*The cold air blast is also prevented using a similar control when the defrosting operation is started or when the thermostat is turned ON.

1.10.2 Signal Receiving Sign

When the indoor unit receives a signal from the remote control, the unit emits a signal receiving sound.

1.10.3 Indoor Unit ON/OFF Button

An ON/OFF button is provided on the display of the unit.

- Press this button once to start operation. Press once again to stop it.
- This button is useful when the remote control is missing or the battery has run out.
- The operation mode refers to the following table.

	Mode	Temperature setting	Airflow rate
Cooling Only	COOL	22°C	Automatic
Heat Pump	AUTO	25°C	Automatic

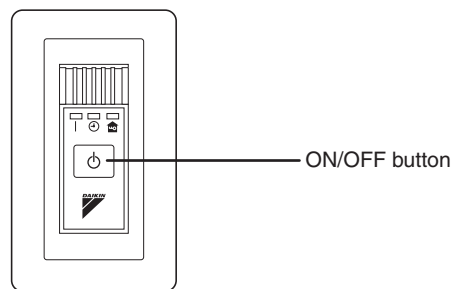

(R4133)

<Forced operation mode>

Forced operation mode can be started by pressing the ON/OFF button for 5 to 9 seconds while the unit is not operating.

Refer to "Forced operation mode" on page 42 for detail.



Note: When the ON/OFF button is pressed for 10 seconds or more, the forced operation is stopped.

1.10.4 Auto-restart Function

Even if a power failure (including one for just a moment) occurs during the operation, the operation restarts automatically when the power is restored in the same condition as before the power failure.



Note: It takes 3 minutes to restart the operation because the 3-minute standby function is activated.

2. Function of Thermistor

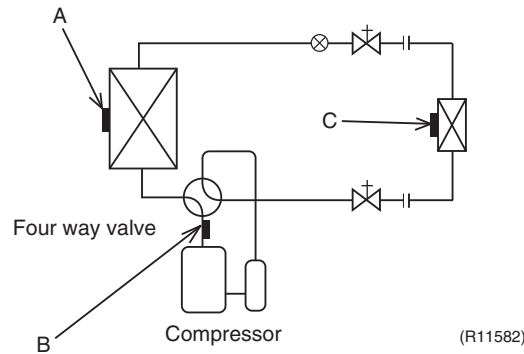

A Outdoor Heat Exchanger Thermistor

1. The outdoor heat exchanger thermistor is used for controlling target discharge pipe temperature. The system sets the target discharge pipe temperature according to the outdoor and indoor heat exchanger temperature, and controls the electronic expansion valve opening so that the target discharge pipe temperature can be obtained.
2. In cooling operation, the outdoor heat exchanger thermistor is used for detecting disconnection of the discharge pipe thermistor. When the discharge pipe temperature becomes lower than the outdoor heat exchanger temperature, the discharge pipe thermistor is judged as disconnected.
3. In cooling operation, the outdoor heat exchanger thermistor is used for high pressure protection.

B Discharge Pipe Thermistor

1. The discharge pipe thermistor is used for controlling discharge pipe temperature. If the discharge pipe temperature (used in place of the inner temperature of the compressor) rises abnormally, the operating frequency becomes lower or the operation halts.
2. The discharge pipe thermistor is used for detecting disconnection of the discharge pipe thermistor.

C Indoor Heat Exchanger Thermistor

1. The indoor heat exchanger thermistor is used for controlling target discharge pipe temperature. The system sets the target discharge pipe temperature according to the outdoor and indoor heat exchanger temperature, and controls the electronic expansion valve opening so that the target discharge pipe temperature can be obtained.
2. In cooling operation, the indoor heat exchanger thermistor is used for freeze-up protection control. If the indoor heat exchanger temperature drops abnormally, the operating frequency becomes lower or the operation halts.
3. In heating operation, the indoor heat exchanger thermistor is used for detecting disconnection of the discharge pipe thermistor. When the discharge pipe temperature becomes lower than the indoor heat exchanger temperature, the discharge pipe thermistor is judged as disconnected.

3. Control Specification

3.1 Mode Hierarchy

Outline

There are two modes; the one is the normal operation mode and the other is the forced operation mode for installation and providing service.

Detail

For Cooling Only Model

There are following modes; stop and cooling (including drying).

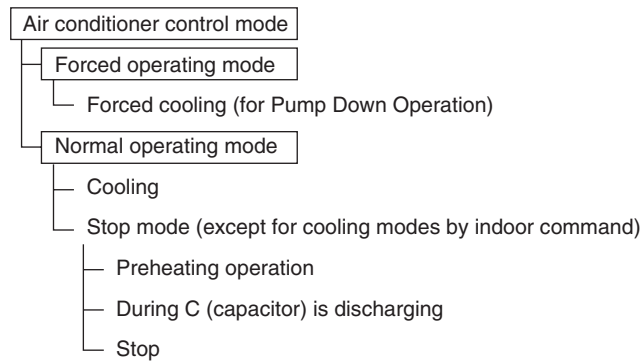

(R2830)

For Heat Pump Model

There are following modes; stop, cooling (includes drying), heating (include defrosting)

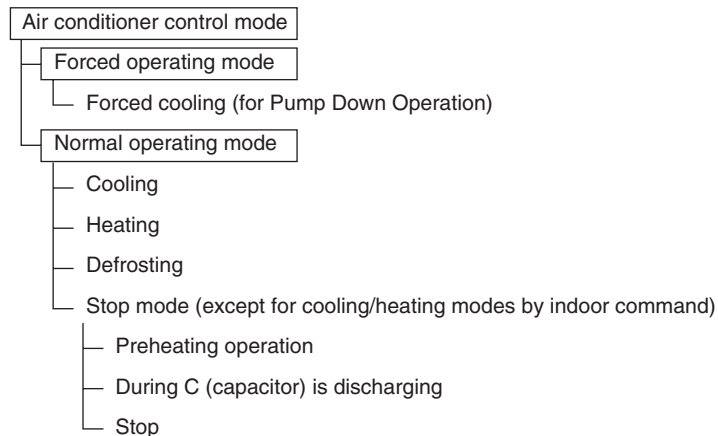

(R2829)



Note: Unless specified otherwise, an indoor dry operation command is regarded as cooling operation.

3.2 Frequency Control

Outline

Frequency is determined according to the difference between the room thermistor temperature and the target temperature.

The function is explained as follows.

1. How to determine frequency
2. Frequency command from the indoor unit (Difference between the room thermistor temperature and the target temperature)
3. Frequency initial setting
4. PI control

When the shift of the frequency is less than zero ($\Delta F < 0$) by PI control, the target frequency is used as the command frequency.

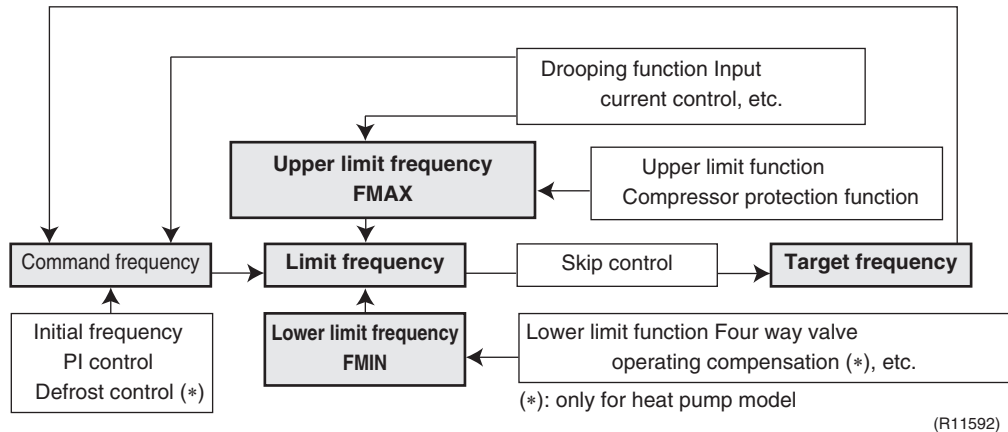

Detail

How to Determine Frequency

The compressor's frequency is determined by taking the following steps.

For Cooling Only Model

1. Determine command frequency

- ◆ Command frequency is determined in the following order of priority.

1. Forced cooling
2. Indoor frequency command

2. Determine upper limit frequency

- ◆ The minimum value is set as an upper limit frequency among the frequency upper limits of the following functions:
Compressor protection, input current, discharge pipe temperature, freeze-up protection.

3. Determine lower limit frequency

- ◆ The maximum value is set as a lower limit frequency among the frequency lower limits of the following function:
Pressure difference upkeep.

4. Determine prohibited frequency

- ◆ There is a certain prohibited frequency such as a power supply frequency.

For Heat Pump Model

1. Determine command frequency

- ◆ Command frequency is determined in the following order of priority.

1. Limiting defrost control time
2. Forced cooling
3. Indoor frequency command

2. Determine upper limit frequency

- ◆ The minimum value is set as an upper limit frequency among the frequency upper limits of the following functions:
Compressor protection, input current, discharge pipe temperature, heating peak-cut, freeze-up protection, defrost.

3. Determine lower limit frequency

- ◆ The maximum value is set as a lower limit frequency among the frequency lower limits of the following functions:
Four way valve operation compensation, draft prevention, pressure difference upkeep.

4. Determine prohibited frequency

- ◆ There is a certain prohibited frequency such as a power supply frequency.

Indoor Frequency Command (ΔD signal)

The difference between the room thermistor temperature and the target temperature is taken as the " ΔD signal" and is used for frequency command.

Temperature difference (°C)	ΔD signal	Temperature difference (°C)	ΔD signal	Temperature difference (°C)	ΔD signal	Temperature difference (°C)	ΔD signal
-2.0	*Th OFF	0	4	2.0	8	4.0	C
-1.5	1	0.5	5	2.5	9	4.5	D
-1.0	2	1.0	6	3.0	A	5.0	E
-0.5	3	1.5	7	3.5	B	5.5	F

*Th OFF = Thermostat OFF

Frequency Initial Setting**<Outline>**

When starting the compressor, the frequency is initialized according to the ΔD value and the Q value of the indoor unit.

Q value: Indoor unit output determined from indoor unit volume, airflow rate and other factors.

PI Control (Determine Frequency Up / Down by ΔD Signal)**1. P control**

The ΔD value is calculated in each sampling time (20 seconds), and the frequency is adjusted according to its difference from the frequency previously calculated.

2. I control

If the operating frequency does not change for more than a certain fixed time, the frequency is adjusted according to the ΔD value.

When the ΔD value is small, the frequency is lowered.

When the ΔD value is large, the frequency is increased.

3. Frequency management when other controls are functioning

- ◆ When frequency is drooping;
Frequency management is carried out only when the frequency droops.
- ◆ For limiting lower limit
Frequency management is carried out only when the frequency rises.

4. Upper and lower limit of frequency by PI control

The frequency upper and lower limits are set according to the command on indoor unit.

When the indoor or outdoor unit quiet operation command comes from the indoor unit, the upper limit frequency is lowered than the usual setting.

3.3 Controls at Mode Changing / Start-up

3.3.1 Preheating Operation

Outline The inverter operation in open phase starts with the conditions of the outdoor temperature, the discharge pipe temperature, and the radiation fin temperature (internal temperature of PM1).

Detail Outdoor temperature $\geq 10^{\circ}\text{C}$ → Control A (preheating for normal state)
Outdoor temperature $< 10^{\circ}\text{C}$ → Control B (preheating of increased capacity)

Control A

- ◆ ON condition
 - Discharge pipe temperature $< 6^{\circ}\text{C}$
 - Radiation fin temperature $< 85^{\circ}\text{C}$
- ◆ OFF condition
 - Discharge pipe temperature $> 8^{\circ}\text{C}$
 - Radiation fin temperature $\geq 90^{\circ}\text{C}$

Control B

- ◆ ON condition
 - Discharge pipe temperature $< 10.5^{\circ}\text{C}$
 - Radiation fin temperature $< 85^{\circ}\text{C}$
- ◆ OFF condition
 - Discharge pipe temperature $> 12^{\circ}\text{C}$
 - Radiation fin temperature $\geq 90^{\circ}\text{C}$

3.3.2 Four Way Valve Switching

Outline In heating operation, current is conducted, and in cooling and defrosting, current is not conducted. In order to eliminate the switching sound when the heating is stopped, as the four way valve coil switches from ON to OFF, the OFF delay switch of the four way valve is carried out after the operation stopped.

Detail **OFF delay switch of four way valve:**
The four way valve coil is energized for 150 seconds after the operation is stopped.

3.3.3 Four Way Valve Operation Compensation

Outline At the beginning of the operation as the four way valve is switched, the differential pressure to activate the four way valve is acquired by having output frequency which is more than a certain fixed frequency, for a certain fixed time.

Detail **Starting Conditions**

1. When starting compressor for heating.
2. When the operation mode changes to cooling from heating.
3. When starting compressor for defrosting or resetting.
4. When starting compressor for the first time after the reset with the power is ON.
5. When starting compressor for heating next to the suspension of defrosting.
6. When starting compressor next to the fault of switching over cooling / heating.

Set the lower limit frequency A Hz for B seconds with any conditions 1 through 6 above.

A (Hz)	B (seconds)
48	70

3.3.4 3-minute Standby

Turning on the compressor is prohibited for 3 minutes after turning it off.
(Except when defrosting.)

3.3.5 Compressor Protection Function

When turning the compressor from OFF to ON, the upper limit of frequency is set as follows.
(The function is not activated when defrosting.)

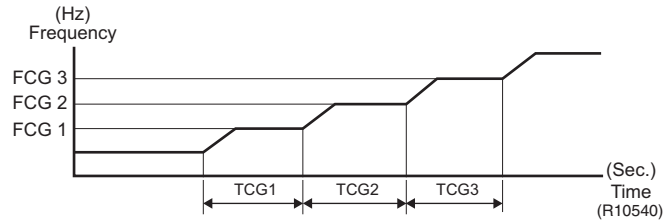

FCG 1	55	Hz
FCG 2	70	
FCG 3	85	
TCG 1	120	seconds
TCG 2	200	
TCG 3	470	

3.4 Discharge Pipe Temperature Control

Outline

The discharge pipe temperature is used as the internal temperature of the compressor. If the discharge pipe temperature rises above a certain level, the upper limit of frequency is set to keep this temperature from going up further.

Detail

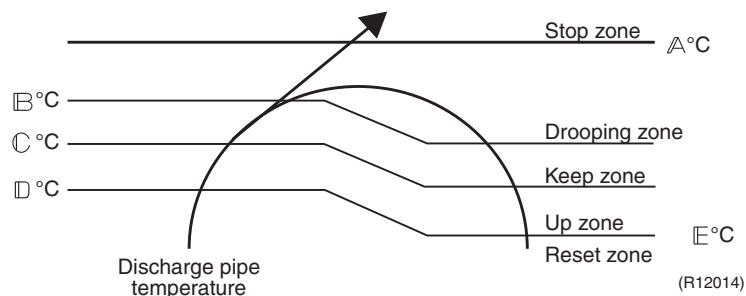

Zone	Control
Stop zone	When the temperature reaches the stop zone, the compressor stops.
Drooping zone	The timer starts, and the frequency is drooping.
Keep zone	The upper limit of frequency is kept.
Up zone	The upper limit of frequency is increased.
Reset zone	The upper limit of frequency is canceled.

A (°C)	110
B (°C)	103
C (°C)	101.5
D (°C)	100
E (°C)	95

3.5 Input Current Control

Outline

The microcomputer calculates the input current during the compressor is running, and sets the frequency upper limit from the input current.

In case of heat pump model, this control which is the upper limit control of the frequency takes priority to the lower limit of control of four way valve operation compensation.

Detail

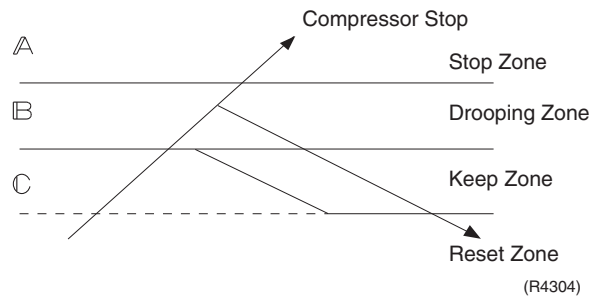

Frequency control in each zone

Stop zone

- ◆ After 2.5 seconds in this zone, the compressor is stopped.

Drooping zone

- ◆ The upper limit of the compressor frequency is defined as operation frequency – 2 Hz.
- ◆ After this, the output frequency is pulled down by 2 Hz every second until it reaches the keep zone.

Keep zone

- ◆ The present maximum frequency goes on.

Reset zone

- ◆ Limit of the frequency is canceled.

	50 class		60 class	
	Cooling	Heating	Cooling	Heating
Ⓐ (A)	20.0		20.0	
Ⓑ (A)	10.0	15.0	12.0	16.0
Ⓒ (A)	9.0	14.0	11.0	15.0

Limitation of current drooping and stop value according to the outdoor temperature

- ◆ The current droops when outdoor temperature becomes higher than a certain level (depending on the model).

3.6 Freeze-up Protection Control

Outline

During cooling operation, the signal sent from the indoor unit controls the operating frequency limitation and prevents freezing of the indoor heat exchanger. (The signal from the indoor unit is divided into zones.)

Detail

The operating frequency limitation is judged with the indoor heat exchanger temperature.

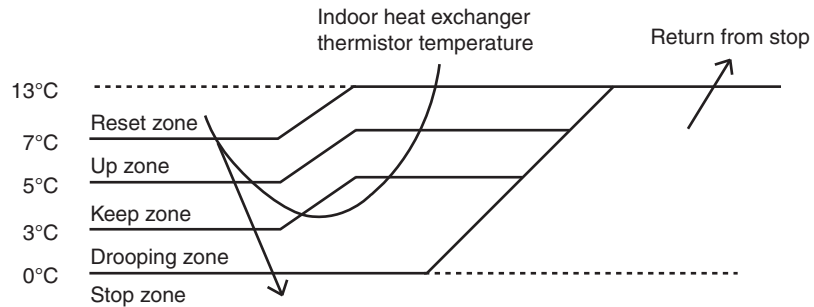

(R4561)

3.7 Heating Peak-cut Control

Outline

During heating operation, the indoor heat exchanger temperature determines the frequency upper limit to prevent abnormal high pressure.

Detail

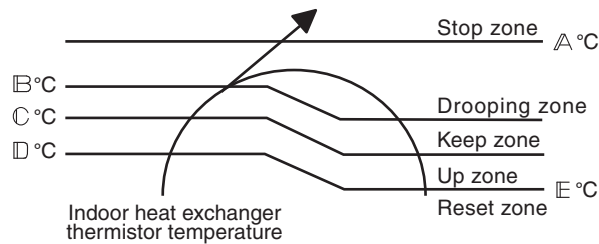

(R1380)

Zone	Control
Stop zone	When the temperature reaches the stop zone, the compressor stops.
Drooping zone	The timer starts, and the frequency is drooping.
Keep zone	The upper limit of frequency is kept.
Up zone	The upper limit of frequency is increased.
Reset zone	The upper limit of frequency is canceled.

A (°C)	65
B (°C)	56
C (°C)	55
D (°C)	53
E (°C)	51

3.8 Outdoor Fan Control

1. Fan OFF delay when stopped

The outdoor fan is turned OFF 60 seconds after the compressor stops.

2. Fan ON control to cool down the electrical box

The outdoor fan is turned ON when the electrical box temperature is high while the compressor is OFF.

3. Fan OFF control while defrosting

The outdoor fan is turned OFF while defrosting.

4. Fan ON/OFF control when operation starts / stops

The outdoor fan is turned ON when the operation starts. The outdoor fan is turned OFF when the operation stops.

5. Fan control while forced operation

The outdoor fan is controlled as well as normal operation while the forced operation.

6. Fan speed control while indoor / outdoor quiet operation

The rotation speed of the outdoor fan is reduced by the command of the indoor/outdoor quiet operation.

7. Fan control for POWERFUL operation

The rotation speed of the outdoor fan is increased while the POWERFUL operation.

8. Fan speed control for pressure difference upkeep

The rotation speed of the outdoor fan is controlled for keeping the pressure difference while cooling with low outdoor temperature.

- ◆ When the pressure difference is small, the rotation speed of the outdoor fan is reduced.
- ◆ When the pressure difference is large, the rotation speed of the outdoor fan is increased.

3.9 Liquid Compression Protection Function

Outline

In order to obtain the dependability of the compressor, the compressor is stopped according to the outdoor temperature and temperature of the outdoor heat exchanger.

Detail

- Operation stops depending on the outdoor temperature

Compressor turns off under the conditions that the system is in cooling operation and outdoor temperature is below -12°C .

3.10 Defrost Control

Outline

Defrosting is carried out by the cooling cycle (reverse cycle). The defrosting time or outdoor heat exchanger temperature must be more than a certain value to finish.

Detail

Conditions for Starting Defrost

- The starting conditions is determined with the outdoor temperature and the outdoor heat exchanger temperature.
- The system is in heating operation.
- The compressor operates for 6 minutes.
- 44 minutes of accumulated time pass since the start of the operation, or ending of the previous defrosting.

Conditions for Canceling Defrost

The judgment is made with outdoor heat exchanger temperature. (4°C ~ 12°C)

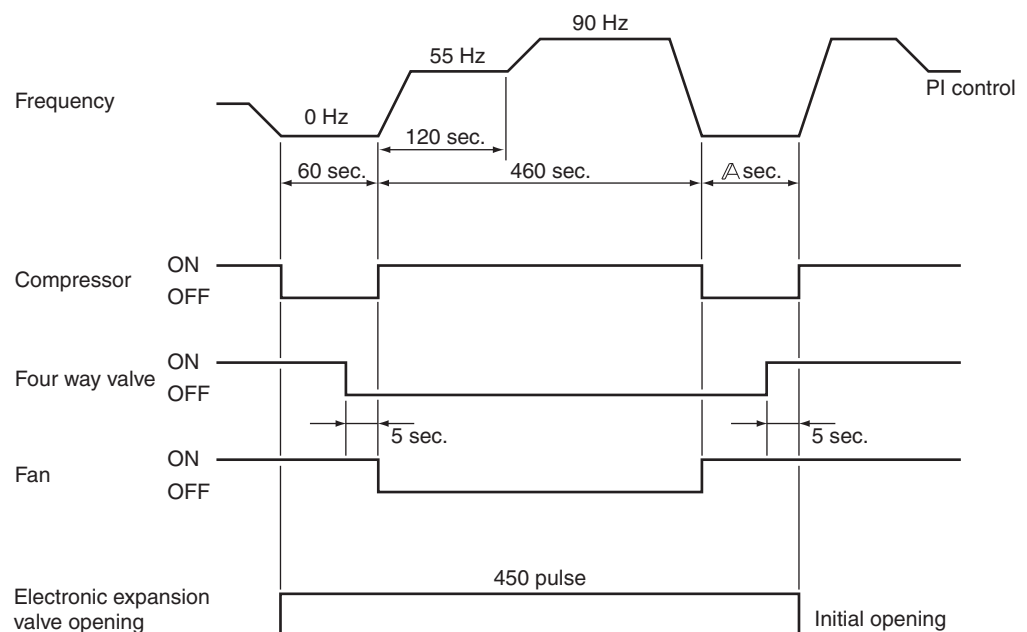

(R12238)

	50 class	60 class
Δ (seconds)	30	50

3.11 Electronic Expansion Valve Control

Outline

The following items are included in the electronic expansion valve control.

Electronic expansion valve is fully closed

1. Electronic expansion valve is fully closed when turning on the power.
2. Pressure equalizing control

Open Control

1. Electronic expansion valve control when starting operation
2. Electronic expansion valve control when frequency changed
3. Electronic expansion valve control for defrosting
4. Electronic expansion valve control when the discharge pipe temperature is abnormally high
5. Electronic expansion valve control when the discharge pipe thermistor is disconnected

Feedback Control

1. Discharge pipe temperature control

Detail

The followings are the examples of control which function in each mode by the electronic expansion valve control.

Operation pattern		Control when frequency changed	Control for abnormally high discharge pipe temperature
When power is turned ON	○ : function × : not function		
↓	Fully closed when power is turned ON	×	×
Cooling operation	Open control when starting	×	○
↓	(Control of target discharge pipe temperature)	○	○
Stop	Pressure equalizing control	×	×
Heating operation	Open control when starting	×	○
↓	(Control of target discharge pipe temperature)	○	○
↓	(Defrost control)	×	×
Stop	Pressure equalizing control	×	×
Heating operation	Open control when starting	×	○
↓	Continue	×	×
Control of discharge pipe thermistor disconnection			
↓	Pressure equalizing control	×	×
Stop			

(R2833)

3.11.1 Fully Closing with Power ON

The electronic expansion valve is initialized when turning on the power. The opening position is set and the pressure equalization is developed.

3.11.2 Pressure Equalization Control

When the compressor is stopped, the pressure equalization control is activated. The electronic expansion valve opens, and develops the pressure equalization.

3.11.3 Opening Limit

Outline

A maximum and minimum opening of the electronic expansion valve are limited.

Detail

Maximum opening (pulse)	480
Minimum opening (pulse)	54

The electronic expansion valve is fully closed when cooling is stopped and is opened at fixed degree during defrosting.

3.11.4 Starting Operation Control

The electronic expansion valve opening is controlled when the operation starts, and prevents the superheating or liquid compression.

3.11.5 High Discharge Pipe Temperature

When the compressor is operating, if the discharge pipe temperature exceeds a certain value, the electronic expansion valve opens and the refrigerant runs to the low pressure side. This procedure lowers the discharge pipe temperature.

3.11.6 Disconnection of the Discharge Pipe Thermistor

Outline

The disconnection of the discharge pipe thermistor is detected by comparing the discharge pipe temperature with the condensation temperature. If the discharge pipe thermistor is disconnected, the electronic expansion valve opens according to the outdoor temperature and the operation frequency, and operates for a specified time, and then stops.

After 3 minutes of waiting, the operation restarts and checks if the discharge pipe thermistor is disconnected. If the discharge pipe thermistor is disconnected, the system stops after operating for a specified time.

If the disconnection is detected 4 times in succession, then the system is shut down. When the compressor runs for 60 minutes without any error, the error counter is reset.

Detail

Detect Disconnection

When the starting control (cooling : 640 seconds, heating : 660 seconds) finishes, the following adjustment is made.

1. When the operation mode is cooling

When the following condition is fulfilled, the discharge pipe thermistor disconnection is ascertained.

Discharge pipe temperature + 6°C < outdoor heat exchanger temperature

2. When the operation mode is heating

When the following condition is fulfilled, the discharge pipe thermistor disconnection is ascertained.

Discharge pipe temperature + 6°C < indoor heat exchanger temperature

Adjustment when the thermistor is disconnected

When the disconnection is ascertained, the compressor continues operation for 9 minutes and then stops.

When the compressor stops repeatedly, the system is shut down.

3.11.7 Control when frequency is changed

When the target discharge pipe temperature control is active, if the target frequency is changed for a specified value in a certain time period, the target discharge pipe temperature control is canceled and the target opening of the electronic expansion valve is changed according to the shift.

3.11.8 Target Discharge Pipe Temperature Control

The target discharge pipe temperature is obtained from the indoor and outdoor heat exchanger temperature, and the electronic expansion valve opening is adjusted so that the actual discharge pipe temperature becomes close to the target discharge pipe temperature. (Indirect SH (superheating) control using the discharge pipe temperature)

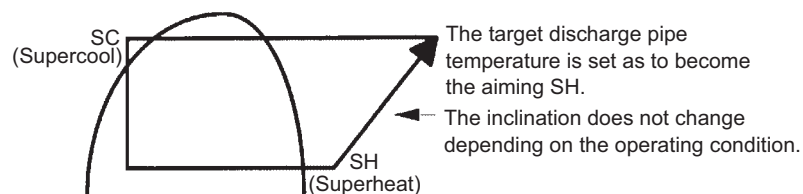

The electronic expansion valve opening and the target discharge pipe temperature are adjusted every 20 seconds. The target discharge pipe temperature is controlled by indoor heat exchanger temperature and outdoor heat exchanger temperature. The opening degree of the electronic expansion valve is controlled by followings.

- ◆ Target discharge pipe temperature
- ◆ Actual discharge pipe temperature
- ◆ Previous discharge pipe temperature

3.12 Malfunctions

3.12.1 Sensor Malfunction Detection

Sensor malfunction may occur in the thermistor.

Relating to Thermistor Malfunction

1. Outdoor heat exchanger thermistor
2. Discharge pipe thermistor
3. Radiation fin thermistor
4. Outdoor temperature thermistor

Relating to CT Malfunction

When the output frequency is more than Δ Hz and the input current is below B A, it is judged as malfunction.

Δ (Hz)	B (A)
55	0.5

3.12.2 Detection of Overcurrent and Overload

Outline

An excessive output current is detected and, the OL temperature is observed to protect the compressor.

Detail

- If the OL (compressor head) temperature exceeds about 120°C (depending on the model), the system shuts down the compressor.
- If the inverter current exceeds 20 A, the system shuts down the compressor.

3.12.3 Refrigerant Shortage Control

Outline

I Detecting by power consumption

If the power consumption is below the specified value and the frequency is higher than the specified frequency, it is regarded as refrigerant shortage.

The power consumption is small comparing with that in the normal operation when refrigerant is insufficient, and refrigerant shortage is detected by checking a power consumption.

Δ (Hz)
55

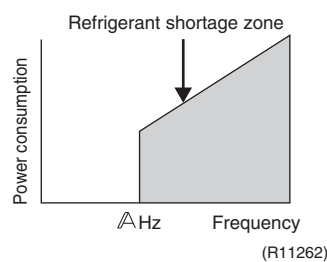

II Detecting by discharge pipe temperature

If the discharge pipe temperature is higher than the target discharge pipe temperature, and the electronic expansion valve is fully open for more than the specified time, it is regarded as refrigerant shortage.

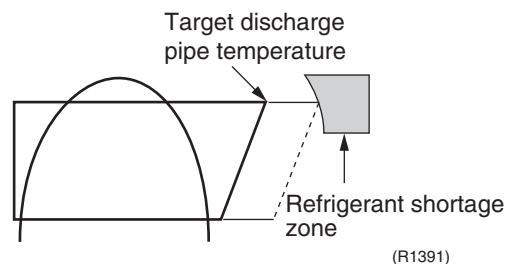

Refer to "Refrigerant shortage" on page 90 for detail.

3.13 Forced Operation Mode

Outline

Forced operation mode includes only forced cooling.

Detail

Item	Forced Cooling
Conditions	1) The outdoor unit is not abnormal and not in the 3-minute standby mode.
	2) The outdoor unit is not operating.
	The forced operation is allowed when the above both conditions are met.
Start	Press the forced operation ON/OFF button (SW1) on the indoor unit for 5 seconds.
Command frequency	66 Hz
End	1) Press the forced operation ON/OFF button (SW1) on the indoor unit again.
	2) Press the ON/OFF button on the remote control.
	3) The operation ends automatically after 15 minutes.
Others	The protection functions are prior to all others in the forced operation.

Part 5

Operation Manual

1. System Configuration.....	44
2. Operation Manual.....	45
2.1 Remote Control	45
2.2 AUTO · DRY · COOL · HEAT · FAN Operation	46
2.3 POWERFUL Operation	48
2.4 OUTDOOR UNIT QUIET Operation.....	49
2.5 HOME LEAVE Operation	50
2.6 TIMER Operation	52

1. System Configuration

After the installation and test operation of the room air conditioner have been completed, it should be operated and handled as described below. Every user would like to know the correct method of operation of the room air conditioner, to check if it is capable of cooling (or heating) well, and to know a clever method of using it.

In order to meet this expectation of the users, giving sufficient explanations taking enough time can be said to reduce about 80% of the requests for servicing. However good the installation work is and however good the functions are, the customer may blame either the room air conditioner or its installation work because of improper handling. The installation work and handing over of the unit can only be considered to have been completed when its handling has been explained to the user without using technical terms but giving full knowledge of the equipment.

2. Operation Manual

2.1 Remote Control

■ Remote control

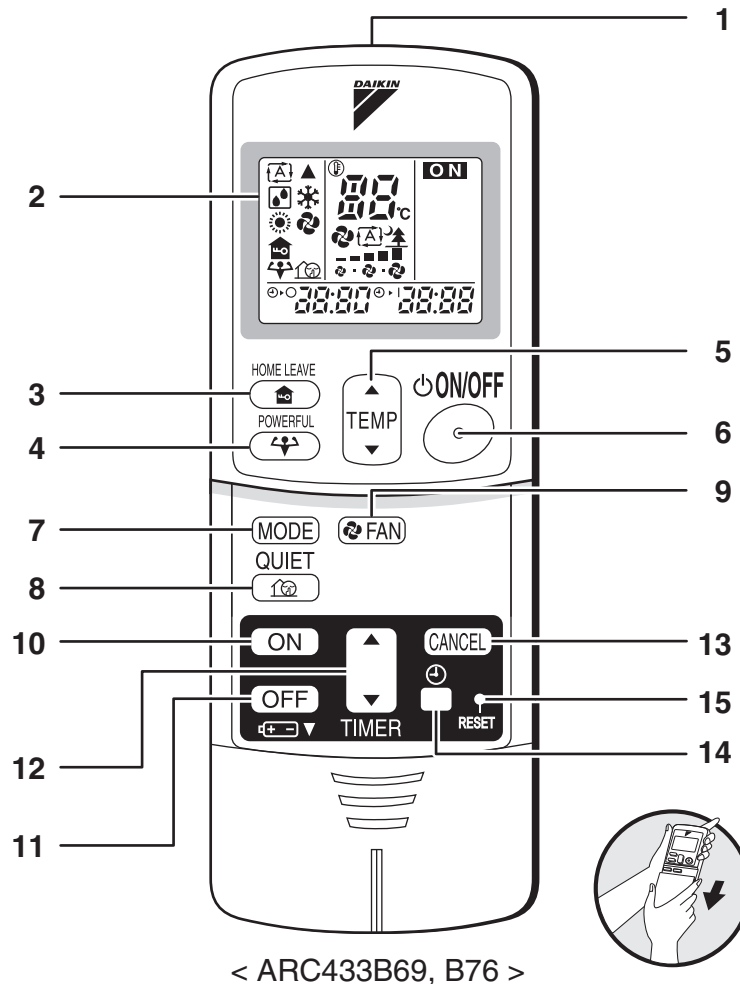

- | | |
|--|--|
| <p>1. Signal transmitter:</p> <ul style="list-style-type: none"> It sends signals to the indoor unit. <p>2. Display:</p> <ul style="list-style-type: none"> It displays the current settings.
(In this illustration, each section is shown with all its displays ON for the purpose of explanation) <p>3. HOME LEAVE button:
HOME LEAVE operation</p> <p>4. POWERFUL button:
POWERFUL operation</p> <p>5. TEMPERATURE adjustment buttons:</p> <ul style="list-style-type: none"> It changes the temperature setting. <p>6. ON/OFF button:</p> <ul style="list-style-type: none"> Press this button once to start operation. Press once again to stop it. | <p>7. MODE selector button:</p> <ul style="list-style-type: none"> It selects the operation mode.
(AUTO/DRY/COOL/HEAT/FAN) <p>8. QUIET button: OUTDOOR UNIT QUIET operation</p> <p>9. FAN setting button:</p> <ul style="list-style-type: none"> It selects the air flow rate setting. <p>10. ON TIMER button</p> <p>11. OFF TIMER button</p> <p>12. TIMER Setting button:</p> <ul style="list-style-type: none"> It changes the timer setting. <p>13. TIMER CANCEL button:</p> <ul style="list-style-type: none"> It cancels the timer setting. <p>14. CLOCK button</p> <p>15. RESET button:</p> <ul style="list-style-type: none"> Restart the unit if it freezes. Use a thin object to push. |
|--|--|

2.2 Auto Dry Cool Heat Fan Operation

The air conditioner operates with the operation mode of your choice. From the next time on, the air conditioner will operate with the same operation mode.

■ To start operation

1. Press “MODE selector button” and select a operation mode.
 - Each pressing of the button advances the mode setting in sequence.

Ⓐ : AUTO

☐ : DRY

❄ : COOL

☀ : HEAT

🌀 : FAN

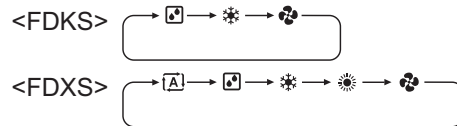

2. Press “ON/OFF button” .
 - The OPERATION lamp lights up.

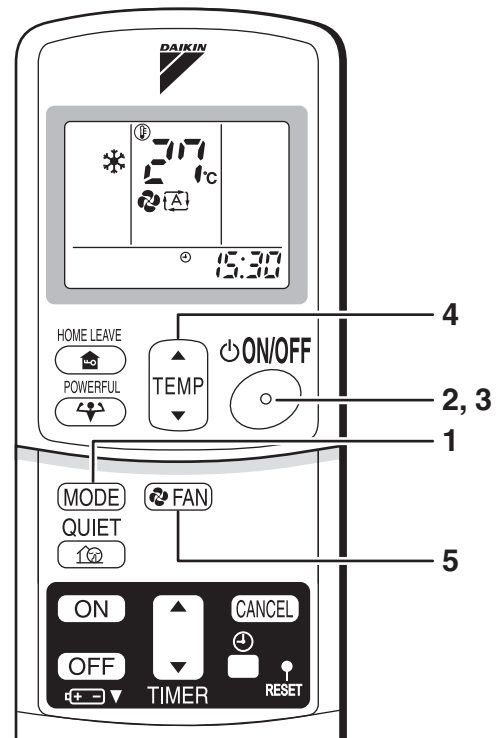
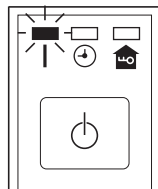

■ To stop operation

3. Press “ON/OFF button” again.
 - Then OPERATION lamp goes off.

■ To change the temperature setting

4. Press “TEMPERATURE adjustment button”.

DRY or FAN mode	AUTO or COOL or HEAT mode
The temperature setting is not variable.	Press “▲” to raise the temperature and press “▼” to lower the temperature.
	Set to the temperature you like

■ To change the air flow rate setting

5. Press “FAN setting button”.

DRY mode	AUTO or COOL or HEAT or FAN mode
The air flow rate setting is not variable	Five levels of air flow rate setting from “ ” to “ ” plus “ [A] ” “ ” are available. 

- Indoor unit quiet operation

When the air flow is set to “ ”, the noise from the indoor unit will become quieter.

Use this when making the noise quieter.

The unit might lose power when the fan strength is set to a weak level.

NOTE

■ Note on HEAT operation

- Since this air conditioner heats the room by taking heat from outdoor air to indoors, the heating capacity becomes smaller in lower outdoor temperatures.
If the heating effect is insufficient, it is recommended to use another heating appliance in combination with the air conditioner.
- The heat pump system heats the room by circulating hot air around all parts of the room. After the start of heating operation, it takes some time before the room gets warmer.
- In heating operation, frost may occur on the outdoor unit and lower the heating capacity. In that case, the system switches into defrosting operation to take away the frost.
- During defrosting operation, hot air does not flow out of indoor unit.

■ Note on DRY operation

- The computer chip works to rid the room of humidity while maintaining the temperature as much as possible. It automatically controls temperature and fan strength, so manual adjustment of these functions is unavailable.

■ Note on AUTO operation

- In AUTO operation, the system selects a temperature setting and an appropriate operation mode (COOL or HEAT) based on the room temperature at the start of the operation.
- The system automatically reselects setting at a regular interval to bring the room temperature to user-setting level.
- If you do not like AUTO operation, you can manually select the operation mode and setting you like.

■ Note on air flow rate setting

- At smaller air flow rates, the cooling (heating) effect is also smaller.

2.3 POWERFUL Operation

POWERFUL operation quickly maximizes the cooling (heating) effect in any operation mode. You can get the maximum capacity

■ To start POWERFUL operation

1. Press "POWERFUL button".
 - POWERFUL operation ends in 20 minutes. Then the system automatically operates again with the settings which were used before POWERFUL operation.
 - When using POWERFUL operation, there are some functions which are not available.
 - "  " is displayed on the LCD.

■ To cancel POWERFUL operation

2. Press "POWERFUL button" again.
 - "  " disappears from the LCD.

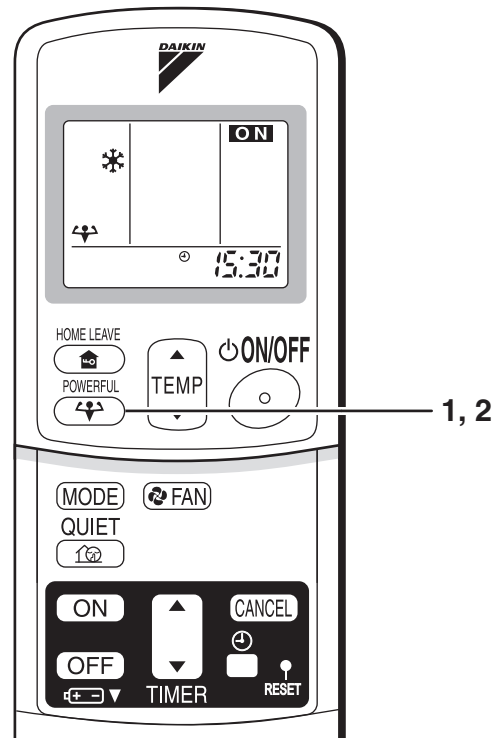

NOTE

■ Notes on POWERFUL operation

- **In COOL and HEAT mode**
To maximize the cooling (heating) effect, the capacity of outdoor unit must be increased and the air flow rate be fixed to the maximum setting. The temperature and air flow settings are not variable.
- **In DRY mode**
The temperature setting is lowered by 2.5°C and the air flow rate is slightly increased.
- **In FAN mode**
The air flow rate is fixed to the maximum setting.

2.4 OUTDOOR UNIT QUIET Operation

OUTDOOR UNIT QUIET operation lowers the noise level of the outdoor unit by changing the frequency and fan speed on the outdoor unit. This function is convenient during night.

■ To start OUTDOOR UNIT QUIET operation

1. Press “QUIET button”.
 - “” is displayed on the LCD.

■ To cancel OUTDOOR UNIT QUIET operation

2. Press “QUIET button” again.
 - “” disappears from the LCD.

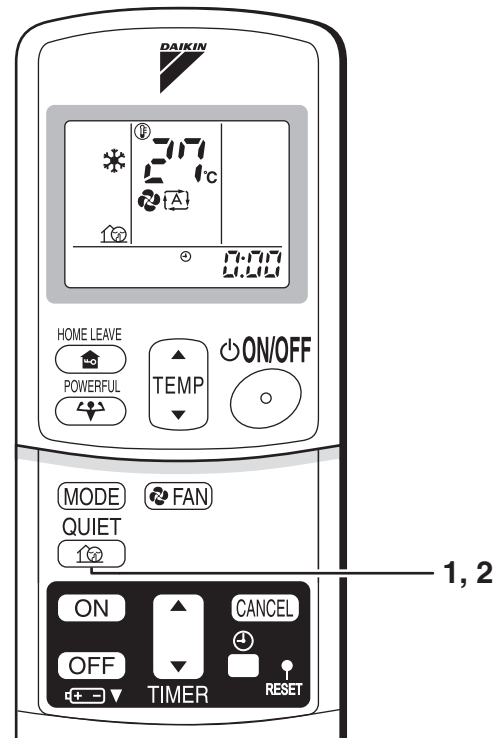

NOTE

■ Note on OUTDOOR UNIT QUIET operation

- This function is available in COOL, HEAT, and AUTO modes. (This is not available in FAN and DRY mode.)
- POWERFUL operation and OUTDOOR UNIT QUIET operation cannot be used at the same time. Priority is given to POWERFUL operation.
- If operation is stopped using the remote control or the main unit ON/OFF switch when using OUTDOOR UNIT QUIET operation, “” will remain on the remote control display.

2.5 HOME LEAVE Operation

HOME LEAVE operation is a function which allows you to record your preferred temperature and air flow rate settings.

■ To start HOME LEAVE operation

1. Press “HOME LEAVE button”.
 - “” is displayed on the LCD.
 - The HOME LEAVE lamp lights up.

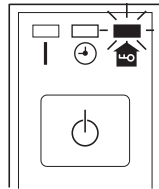

■ To cancel HOME LEAVE operation

2. Press “HOME LEAVE button” again.
 - The HOME LEAVE lamp goes off.
 - “” disappears from the LCD.

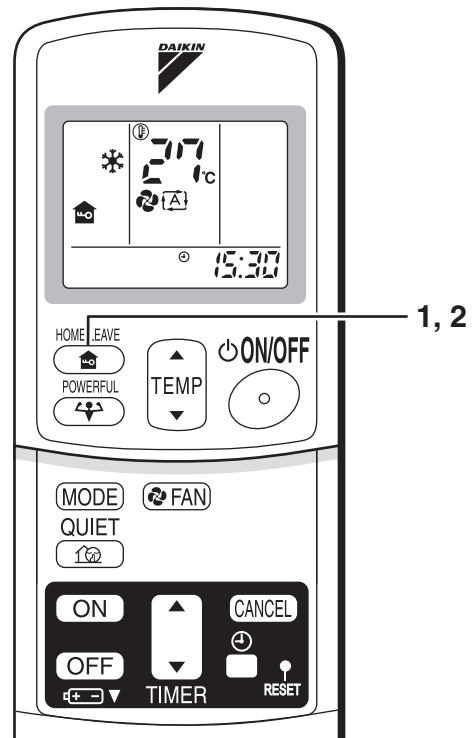

Before using HOME LEAVE operation

■ To set the temperature and air flow rate for HOME LEAVE operation

When using HOME LEAVE operation for the first time, please set the temperature and air flow rate for HOME LEAVE operation. Record your preferred temperature and air flow rate.

	Initial setting		Selectable range	
	temperature	Air flow rate	temperature	Air flow rate
Cooling	25°	AUTO	18-32°C	5 step, AUTO and QUIET
Heating	25°	AUTO	10-30°C	5 step, AUTO and QUIET

1. Press “HOME LEAVE button”. Make sure “” is displayed in the remote control display.
2. Adjust the set temperature with “” or “” as you like.
3. Adjust the air flow rate with “FAN” setting button as you like.

Home leave operation will run with these settings the next time you use the unit. To change the recorded information, repeat steps 1 – 3.

■ What's the HOME LEAVE operation

Is there a set temperature and air flow rate which is most comfortable, a set temperature and air flow rate which you use the most? HOME LEAVE operation is a function that allows you to record your favorite set temperature and air flow rate. You can start your favorite operation mode simply by pressing the HOME LEAVE button on the remote control. This function is convenient in the following situations.

■ Useful in these cases

1. Use as an energy-saving mode

Set the temperature 2-3°C higher (cooling) or lower (heating) than normal. Setting the fan strength to the lowest setting allows the unit to be used in energy-saving mode. Also convenient for use while you are out or sleeping.

• Every day before you leave the house...

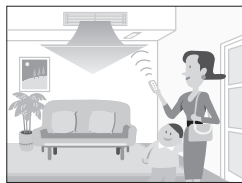

When you go out, push the "HOME LEAVE Operation" button, and the air conditioner will adjust capacity to reach the preset temperature for HOME LEAVE Operation.



When you return, you will be welcomed by a comfortably air conditioned room.

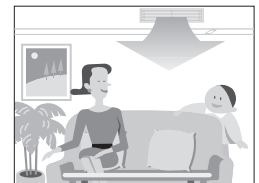

Push the "HOME LEAVE Operation" button again, and the air conditioner will adjust capacity to the set temperature for normal operation.

• Before bed...

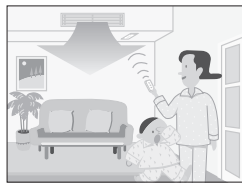

Set the unit to HOME LEAVE Operation before leaving the living room when going to bed.



The unit will maintain the temperature in the room at a comfortable level while you sleep.

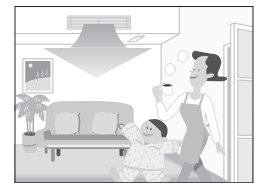

When you enter the living room in the morning, the temperature will be just right. Disengaging HOME LEAVE Operation will return the temperature to that set for normal operation. Even the coldest winters will pose no problem!

2. Use as a favorite mode

Once you record the temperature and air flow rate settings you most often use, you can retrieve them by pressing HOME LEAVE button. You do not have to go through troublesome remote control operations.

NOTE

- Once the temperature and air flow rate for HOME LEAVE operation are set, those settings will be used whenever HOME LEAVE operation is used in the future. To change these settings, please refer to the "Before using HOME LEAVE operation" section above.
- HOME LEAVE operation is only available in COOL and HEAT mode. Cannot be used in AUTO, DRY, and FAN mode.
- HOME LEAVE operation runs in accordance with the previous operation mode (COOL or HEAT) before using HOME LEAVE operation.
- HOME LEAVE operation and POWERFUL operation cannot be used at the same time. Last button that was pressed has priority.
- The operation mode cannot be changed while HOME LEAVE operation is being used.
- When operation is shut off during HOME LEAVE operation, using the remote control or the indoor unit ON/OFF switch, "🏠" will remain on the remote control display.

2.6 TIMER Operation

Timer functions are useful for automatically switching the air conditioner on or off at night or in the morning. You can also use OFF TIMER and ON TIMER in combination.

■ To use OFF TIMER operation

- Check that the clock is correct.
If not, set the clock to the present time.
- 1. Press “OFF TIMER button”.
0:00 is displayed.
⊙-1 blinks.
- 2. Press “TIMER Setting button” until the time setting reaches the point you like.
 - Every pressing of either button increases or decreases the time setting by 10 minutes. Holding down either button changes the setting rapidly.
- 3. Press “OFF TIMER button” again.
 - The TIMER lamp lights up.

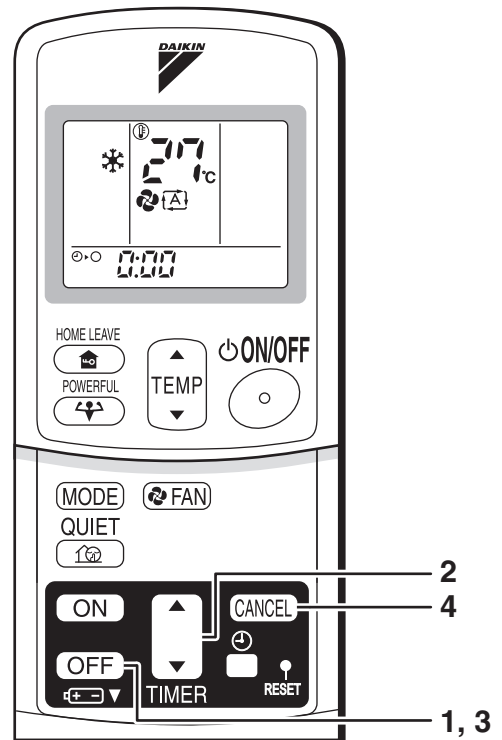
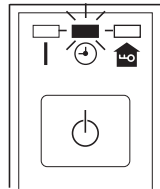

■ To cancel the OFF TIMER operation

- 4. Press “CANCEL button”.
 - The TIMER lamp goes off.

NOTE

- When TIMER is set, the present time is not displayed.
- Once you set ON, OFF TIMER, the time setting is kept in the memory. (The memory is canceled when remote control batteries are replaced.)
- When operating the unit via the ON/OFF Timer, the actual length of operation may vary from the time entered by the user. (Maximum approx. 10 minutes)

■ NIGHT SET MODE

When the OFF TIMER is set, the air conditioner automatically adjusts the temperature setting (0.5°C up in COOL, 2.0°C down in HEAT) to prevent excessive cooling (heating) for your pleasant sleep.

■ To use ON TIMER operation

- Check that the clock is correct. If not, set the clock to the present time.
1. Press “ON TIMER button”.
 - 6:00 is displayed.
 - “” blinks.
 2. Press “TIMER Setting button” until the time setting reaches the point you like.
 - Every pressing of either button increases or decreases the time setting by 10 minutes. Holding down either button changes the setting rapidly.
 3. Press “ON TIMER button” again.
 - The TIMER lamp lights up..

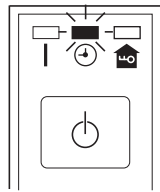

■ To cancel the ON TIMER operation

4. Press “CANCEL button”.
 - The TIMER lamp goes off.

■ To combine ON TIMER and OFF TIMER

- A sample setting for combining the two timers is shown below

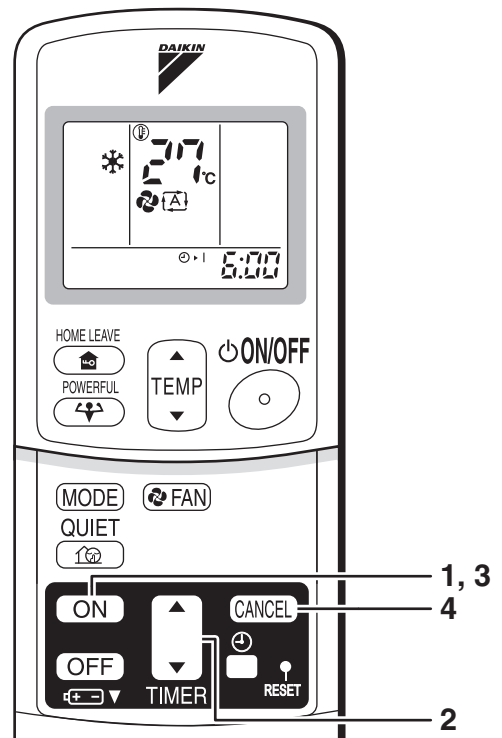
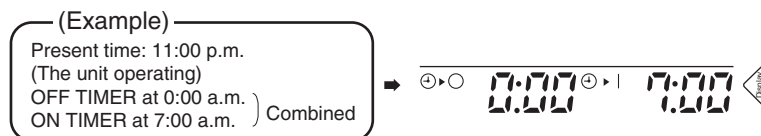

ATTENTION

- In the following cases, set the timer again.
 - After a breaker has turned OFF.
 - After a power failure.
 - After replacing batteries in the remote control.

Part 6

Service Diagnosis

1. Caution for Diagnosis	55
1.1 Troubleshooting with LED	55
2. Problem Symptoms and Measures	56
3. Service Check Function	57
4. Troubleshooting	60
4.1 Error Codes and Description	60
4.2 Indoor Unit PCB Abnormality	61
4.3 Freeze-up Protection Control or Heating Peak-cut Control	62
4.4 Fan Motor (AC motor) or Related Abnormality	64
4.5 Thermistor or Related Abnormality (Indoor Unit)	65
4.6 Signal Transmission Error (between Indoor Unit and Outdoor Unit)	66
4.7 Unspecified Voltage (between Indoor Unit and Outdoor Unit)	67
4.8 Outdoor Unit PCB Abnormality	68
4.9 OL Activation (Compressor Overload)	69
4.10 Compressor Lock	70
4.11 DC Fan Lock	71
4.12 Input Overcurrent Detection	72
4.13 Four Way Valve Abnormality	73
4.14 Discharge Pipe Temperature Control	75
4.15 High Pressure Control in Cooling	76
4.16 Compressor System Sensor Abnormality	77
4.17 Position Sensor Abnormality	78
4.18 CT or Related Abnormality	80
4.19 Thermistor or Related Abnormality (Outdoor Unit)	82
4.20 Electrical Box Temperature Rise	84
4.21 Radiation Fin Temperature Rise	86
4.22 Output Overcurrent Detection	88
4.23 Refrigerant Shortage	90
4.24 Low-voltage Detection or Over-voltage Detection	92
4.25 Signal Transmission Error (on Outdoor Unit PCB)	93
5. Check	94
5.1 How to Check	94

1. Caution for Diagnosis

1.1 Troubleshooting with LED

Indoor Unit

The operation lamp blinks when any of the following errors is detected.

1. When a protection device of the indoor unit or the outdoor unit is activated, or when the thermistor malfunctions.
 2. When a signal transmission error occurs between the indoor unit and the outdoor units.
- In either case, conduct the diagnostic procedure described in the following pages.

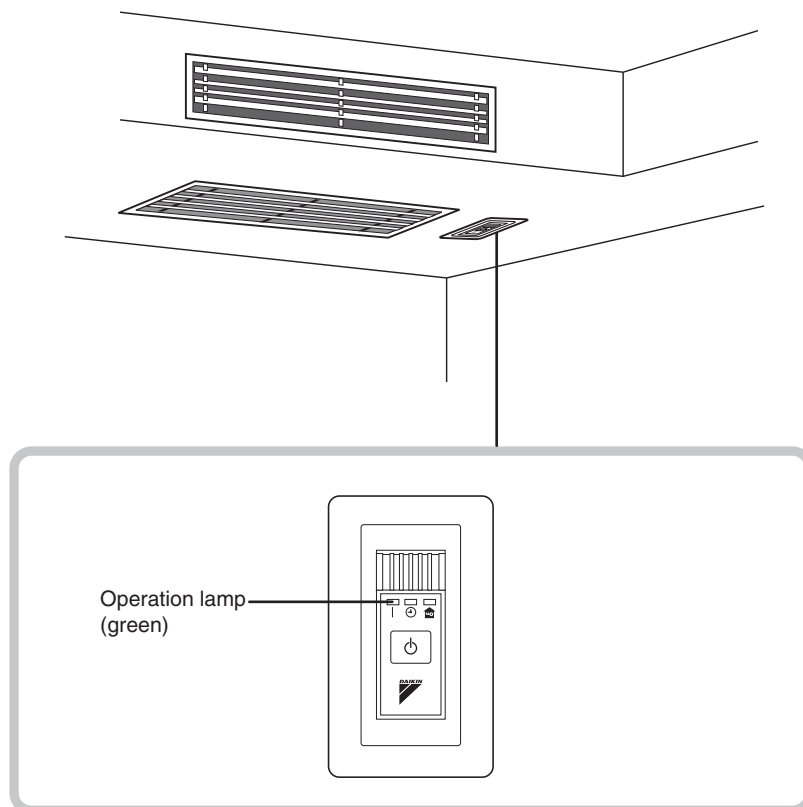

(R4134)

Outdoor Unit

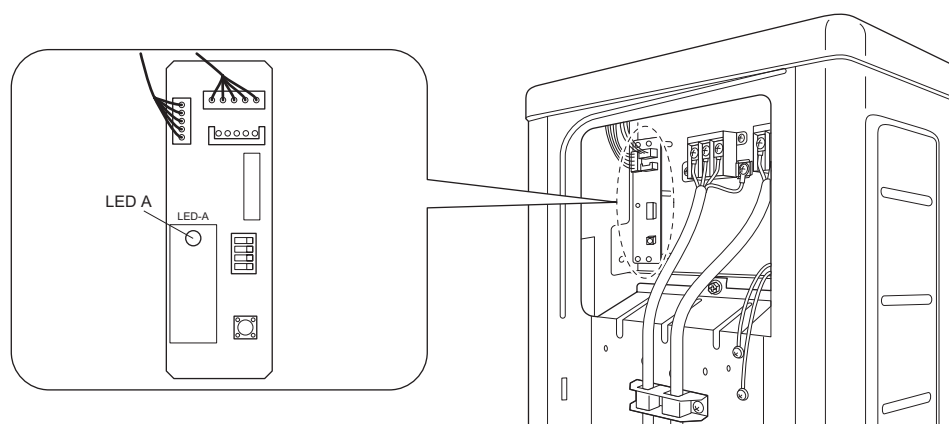

(R6980)

The outdoor unit has one green LED (LED A) on the PCB. When the LED A blinks, the microcomputer works in order.

2. Problem Symptoms and Measures

Symptom	Check Item	Details of Measure	Reference Page
The units does not operate.	Check the power supply.	Check to make sure that the rated voltage is supplied.	—
	Check the type of the indoor units.	Check to make sure that the indoor unit type is compatible with the outdoor unit.	—
	Check the outdoor temperature.	Heating operation cannot be used when the outdoor temperature is 18°C or higher, and cooling operation cannot be used when the outdoor temperature is below -10°C.	—
	Diagnose with remote control indication.	—	60
	Check the remote control addresses.	Check to make sure that address settings for the remote control and indoor unit are correct.	—
Operation sometimes stops.	Check the power supply.	A power failure of 2 to 10 cycles stops air conditioner operation. (Operation lamp OFF)	—
	Check the outdoor temperature.	Heating operation cannot be used when the outdoor temperature is 18°C or higher, and cooling operation cannot be used when the outdoor temperature is below -10°C.	—
	Diagnose with remote control indication.	—	60
The unit operates but does not cool, or does not heat.	Check for wiring and piping errors in the connection between the indoor and outdoor units.	Conduct the wiring/piping error check described on the product diagnosis label.	—
	Check for thermistor detection errors.	Check to make sure that the thermistor is mounted securely.	—
	Check for faulty operation of the electronic expansion valve.	Set the units to cooling operation, and check the temperature of the liquid pipe to see if the electronic expansion valve works.	—
	Diagnose with remote control indication.	—	60
	Diagnose by service port pressure and operating current.	Check for refrigerant shortage.	90
Large operating noise and vibrations	Check the output voltage of the power module.	—	99
	Check the power module.	—	—
	Check the installation condition.	Check to make sure that the required spaces for installation (specified in the installation manual, etc.) are provided.	—

3. Service Check Function

Check Method 1

1. When the timer cancel button is held down for 5 seconds, "00" indication appears on the temperature display section.

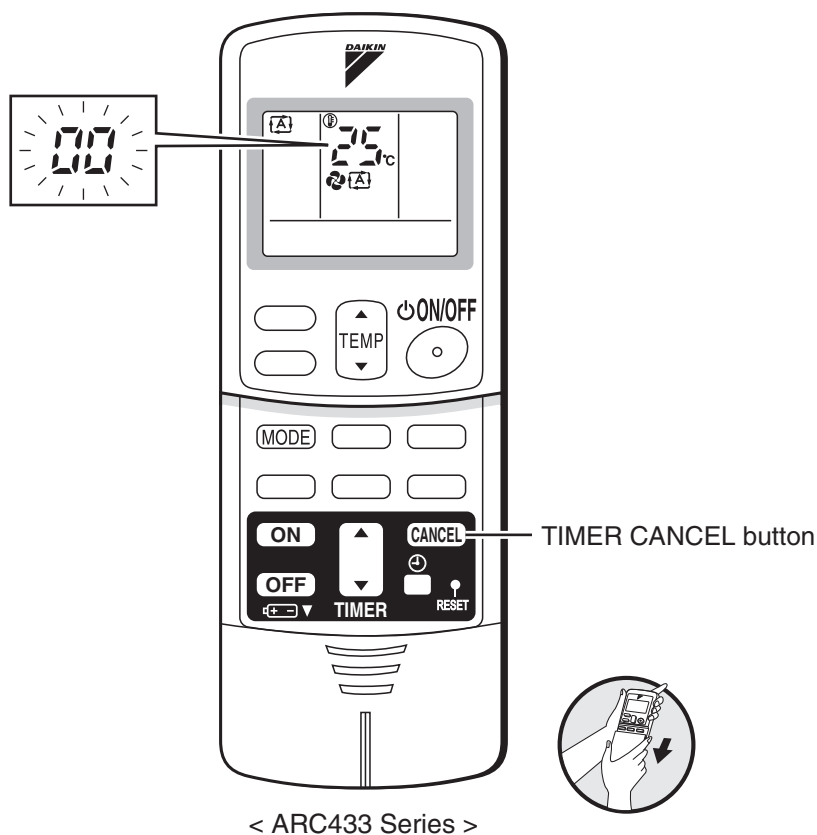

(R11506)

2. Press the timer cancel button repeatedly until a long beep sounds.

■ The code indication changes in the sequence shown below.

No.	Code	No.	Code	No.	Code
1	00	12	C7	23	H0
2	U4	13	H8	24	E1
3	F3	14	J3	25	P4
4	E6	15	R3	26	L3
5	L5	16	R1	27	L4
6	R6	17	C4	28	H6
7	E5	18	C5	29	H7
8	F6	19	H9	30	U2
9	C9	20	J6	31	UH
10	U0	21	UR	32	ER
11	E7	22	R5	33	RH



Note:

1. A short beep "pi" and two consecutive beeps "pi pi" indicate non-corresponding codes.
2. To return to the normal mode, hold the timer cancel button down for 5 seconds. When the remote control is left untouched for 60 seconds, it also returns to the normal mode.

Check Method 2

1. Press the center of the TEMP button and the MODE button at the same time.

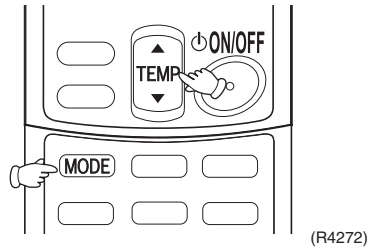

The figure of the ten's place blinks.

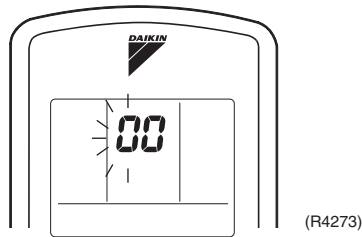

2. Press the TEMP▲ or ▼ button and change the figure until you hear the sound of "beep" or "pi pi".

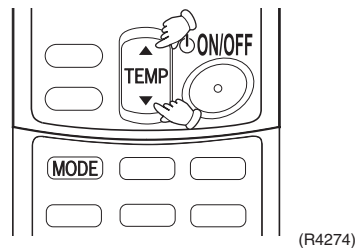

3. Diagnose by the sound.
 - ★"pi" : The figure of the ten's place does not accord with the error code.
 - ★"pi pi" : The figure of the ten's place accords with the error code but the one's not.
 - ★"beep" : The both figures of the ten's and one's place accord with the error code.
 (→ See 7.)

4. Press the MODE button.

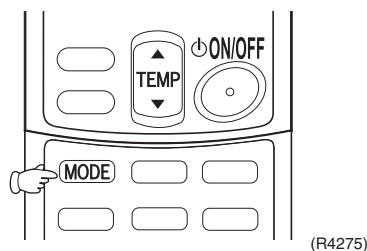

The figure of the one's place blinks.

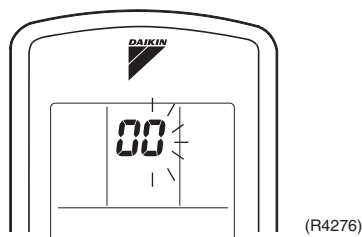

5. Press the TEMP▲ or ▼ button and change the figure until you hear the sound of “beep”.

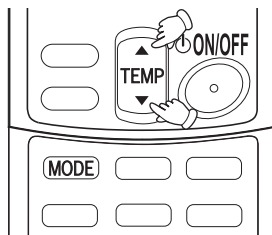

(R4277)

6. Diagnose by the sound.
- ★“pi” : The figure of the ten’s place does not accord with the error code.
 - ★“pi pi” : The figure of the ten’s place accords with the error code but the one’s not.
 - ★“beep” : The both figures of the ten’s and one’s place accord with the error code.
7. Determine the error code.
The figures indicated when you hear the “beep” sound are error code.
(Error codes and description → Refer to page 60.)

8. Press the MODE button to exit from the diagnosis mode.

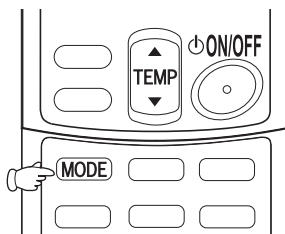

(R4278)

The display “ 7 ” means the trial operation mode.
(Refer to page 126 for trial operation.)

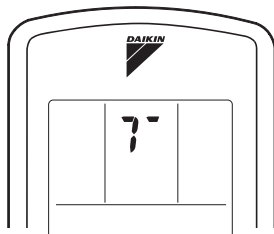

(R9669)

9. Press the ON/OFF button twice to return to the normal mode.

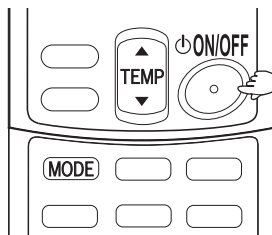

(R9670)



Note: When the remote control is left untouched for 60 seconds, it returns to the normal mode.

4. Troubleshooting

4.1 Error Codes and Description

	Error Codes	Description	Reference Page
System	00	Normal	—
	U0★	Refrigerant shortage	90
	U2	Low-voltage detection or over-voltage detection	92
	U4	Signal transmission error (between indoor unit and outdoor unit)	66
	UR	Unspecified voltage (between indoor unit and outdoor unit)	67
Indoor Unit	R1	Indoor unit PCB abnormality	61
	R5	Freeze-up protection control or heating peak-cut control	62
	R6	Fan motor (AC motor) or related abnormality	64
	C4	Indoor heat exchanger thermistor or related abnormality	65
	C9	Room temperature thermistor or related abnormality	65
Outdoor Unit	E1	Outdoor unit PCB abnormality	68
	E5★	OL activation (compressor overload)	69
	E6★	Compressor lock	70
	E7	DC fan lock	71
	E8	Input overcurrent detection	72
	ER	Four way valve abnormality	73
	F3	Discharge pipe temperature control	75
	F6	High pressure control in cooling	76
	H0	Compressor system sensor abnormality	77
	H6	Position sensor abnormality	78
	H8	CT or related abnormality	80
	H9	Outdoor temperature thermistor or related abnormality	82
	J3	Discharge pipe thermistor or related abnormality	82
	J6	Outdoor heat exchanger thermistor or related abnormality	82
	L3	Electrical box temperature rise	84
	L4	Radiation fin temperature rise	86
	L5	Output overcurrent detection	88
	P4	Radiation fin thermistor or related abnormality	82
	U7	Signal transmission error (on outdoor unit PCB)	93

★: Displayed only when system-down occurs.

4.2 Indoor Unit PCB Abnormality

Remote Control
Display

A1

Method of
Malfunction
Detection

Evaluation of zero-cross detection of power supply by the indoor unit PCB.

Malfunction
Decision
Conditions

There is no zero-cross detection in approximately 10 seconds.

Supposed
Causes

- Wrong models interconnected
- Defective indoor unit PCB
- Disconnection of connector

Troubleshooting



Caution

Be sure to turn off the power switch before connecting or disconnecting connectors, or parts may be damaged.

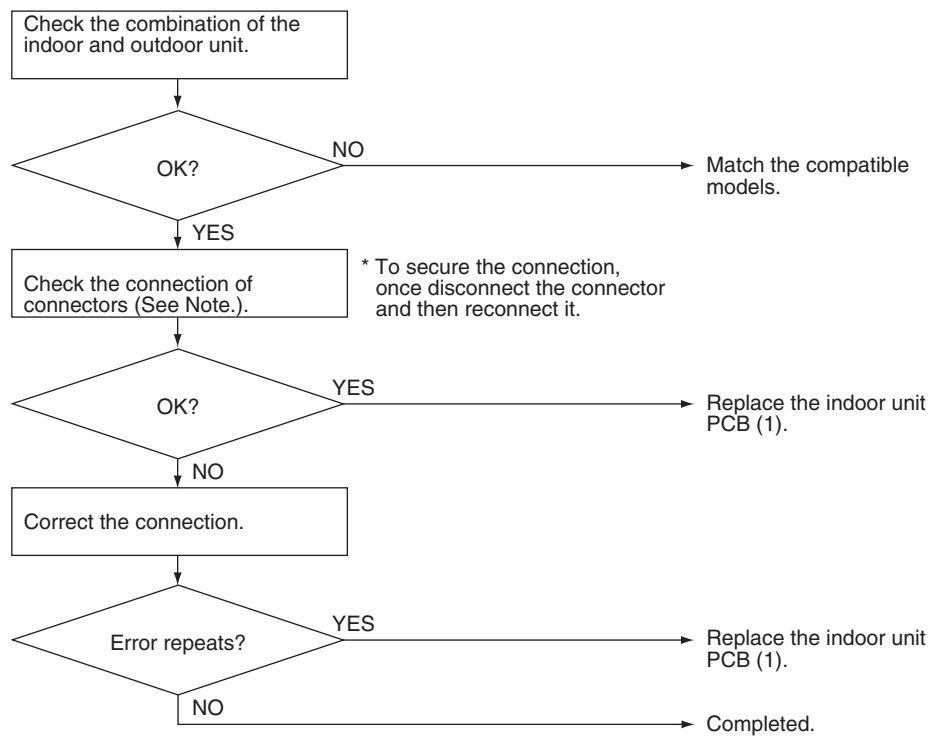

Note: Check the following connector.

Model Type	Connector
Duct connected type	Terminal board ~ Control PCB

(R11704)

4.3 Freeze-up Protection Control or Heating Peak-cut Control

Remote Control *RS*
 Display

Method of Malfunction Detection

- Freeze-up protection control
 During cooling operation, the freeze-up protection control (operation halt) is activated according to the temperature detected by the indoor heat exchanger thermistor.
- Heating peak-cut control
 During heating operation, the temperature detected by the indoor heat exchanger thermistor is used for the heating peak-cut control (operation halt, outdoor fan stop, etc.)

Malfunction Decision Conditions

- Freeze-up protection control
 During cooling operation, the indoor heat exchanger temperature is below 0°C.
- Heating peak-cut control
 During heating operation, the indoor heat exchanger temperature is above 65°C

Supposed Causes

- Short-circuited air
- Clogged air filter of the indoor unit
- Dust accumulation on the indoor heat exchanger
- Defective indoor heat exchanger thermistor
- Defective indoor unit PCB

Troubleshooting



Check No.06
Refer to P.96

**Caution**

Be sure to turn off the power switch before connecting or disconnecting connectors, or parts may be damaged.

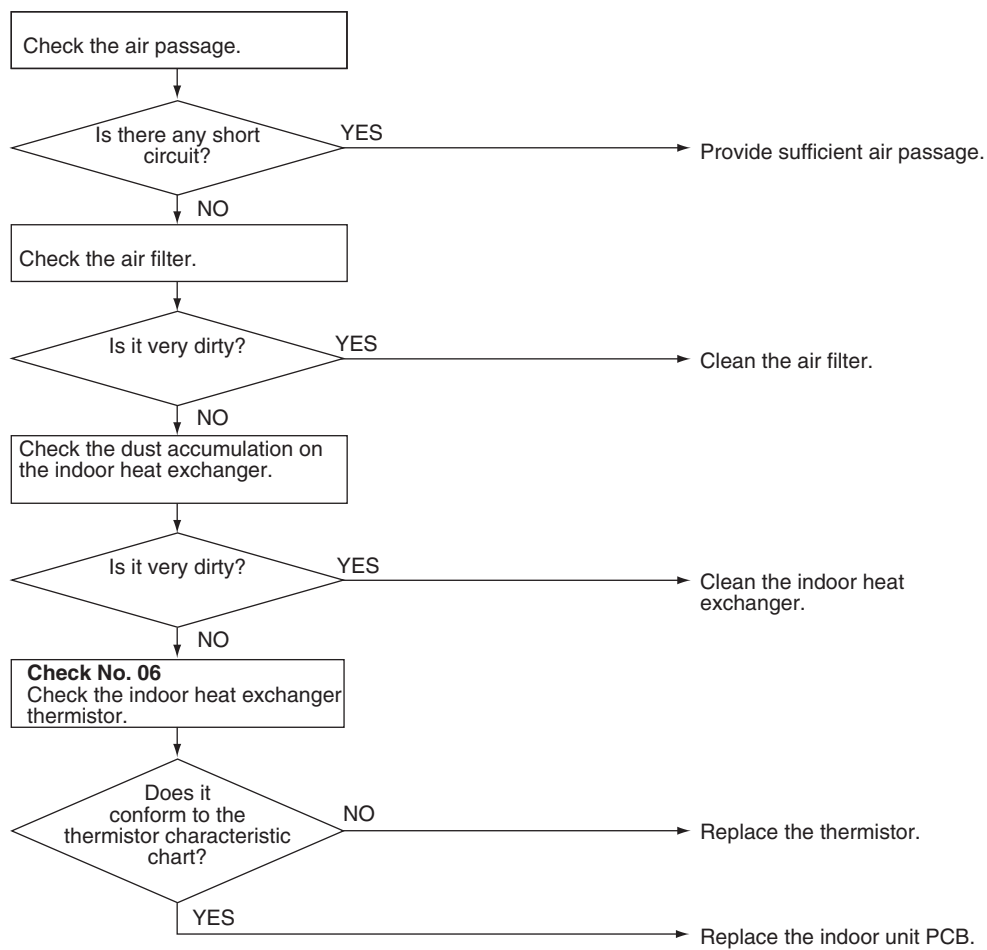

(R7131)

4.4 Fan Motor (AC motor) or Related Abnormality

Remote Control Display *AB*

Method of Malfunction Detection
The rotation speed is detected by the Hall IC while the fan motor is operating. The rotation speed determines the error.

Malfunction Decision Conditions
The detected rotation speed does not reach the demanded rotation speed of the target tap, and is less than 50% of the maximum fan motor rotation speed.

- Supposed Causes**
- Layer short inside the fan motor winding
 - Breaking of wire inside the fan motor
 - Breaking of the fan motor lead wires
 - Defective capacitor of the fan motor
 - Defective indoor unit PCB

Troubleshooting



Check No.16
Refer to P.100



Caution Be sure to turn off the power switch before connecting or disconnecting connectors, or parts may be damaged.

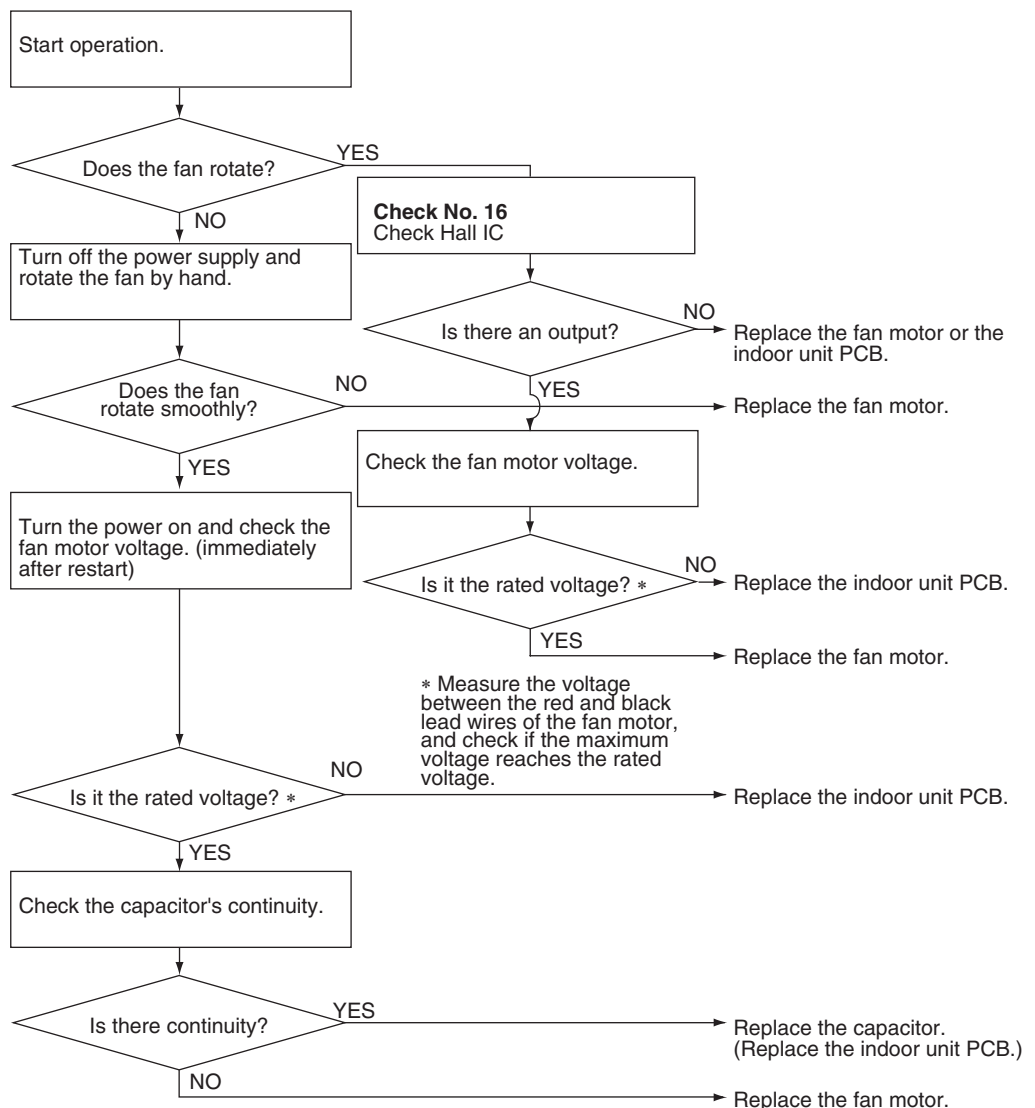

(R11411)

4.5 Thermistor or Related Abnormality (Indoor Unit)

Remote Control Display $\overline{E4.E9}$

Method of Malfunction Detection

The temperatures detected by the thermistors determine thermistor errors.

Malfunction Decision Conditions

The thermistor input is more than 4.96 V or less than 0.04 V during compressor operation.

Supposed Causes

- Disconnection of connector
- Defective thermistor
- Defective indoor unit PCB

Troubleshooting



Check No.06
Refer to P.96



Caution

Be sure to turn off the power switch before connecting or disconnecting connectors, or parts may be damaged.

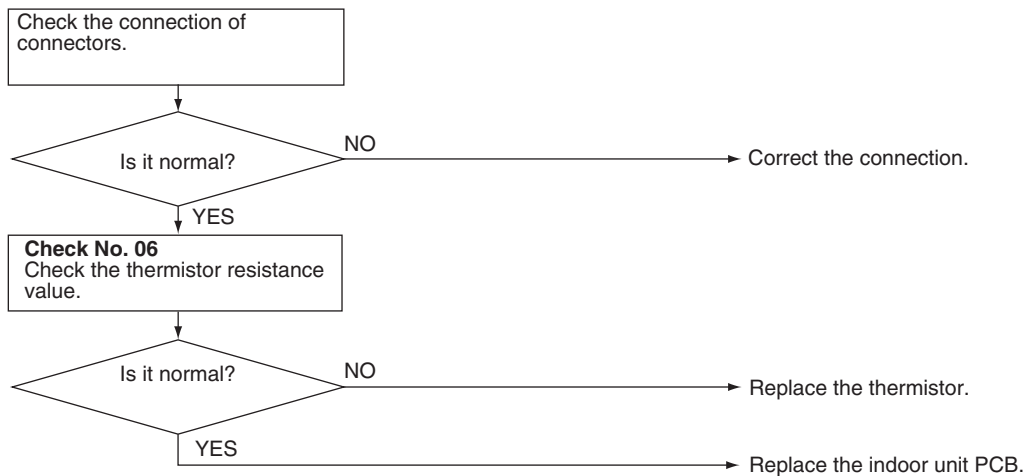

(R7134)

$\overline{E4}$: Indoor heat exchanger thermistor
 $\overline{E9}$: Room temperature thermistor

4.6 Signal Transmission Error (between Indoor Unit and Outdoor Unit)

Remote Control Display

U4

Method of Malfunction Detection

The data received from the outdoor unit checked whether it is normal.

Malfunction Decision Conditions

The data sent from the outdoor unit cannot be received normally, or the content of the data is abnormal.

Supposed Causes

- Wiring error
- Breaking of the connection wires between the indoor and outdoor units (wire No. 3)
- Defective outdoor unit PCB
- Defective indoor unit PCB
- Disturbed power supply waveform

Troubleshooting

Check No.10
Refer to P.98

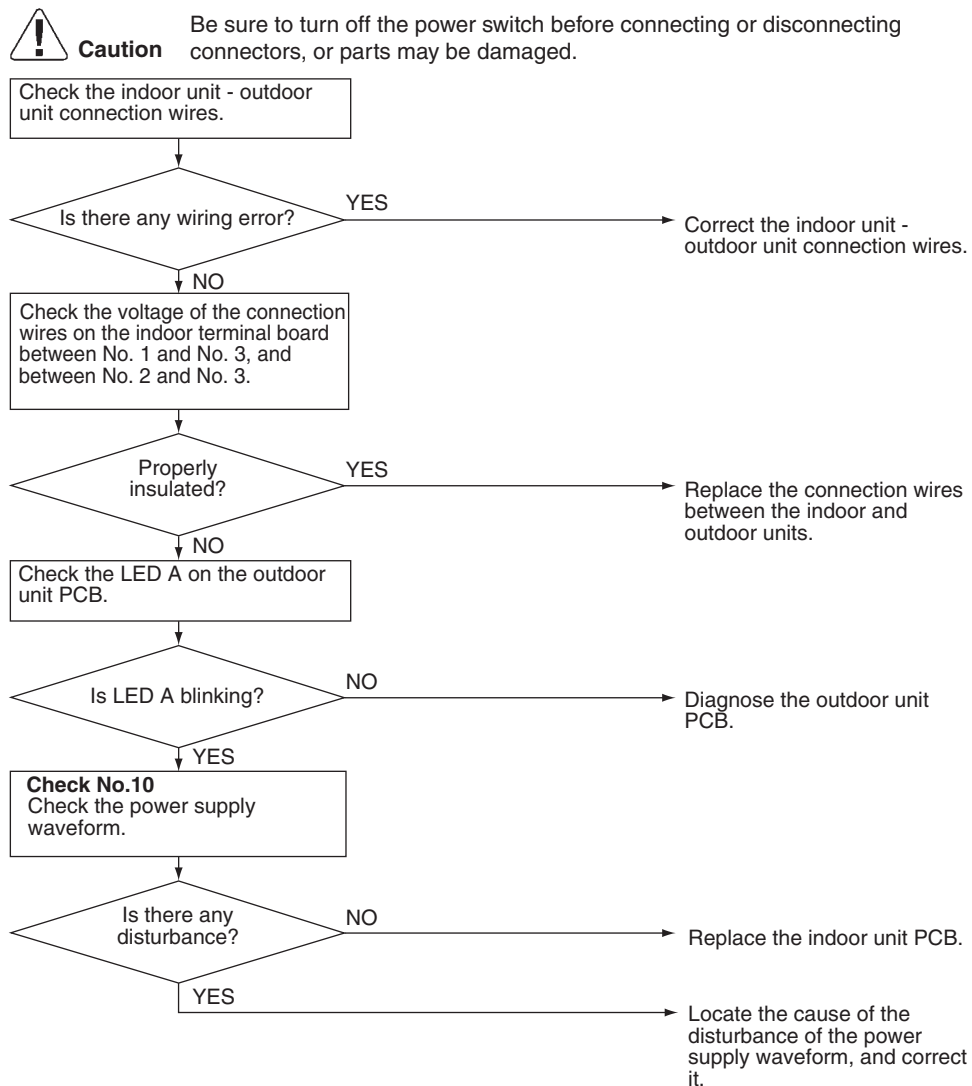

(R12028)

4.7 Unspecified Voltage (between Indoor Unit and Outdoor Unit)

Remote Control Display

UR

Method of Malfunction Detection

The supply power is detected for its requirements (different from pair type and multi type) by the indoor / outdoor transmission signal.

Malfunction Decision Conditions

The pair type and multi type are interconnected.

Supposed Causes

- Wrong models interconnected
- Wrong wiring of connection wires
- Wrong indoor unit PCB or outdoor unit PCB mounted
- Defective indoor unit PCB
- Defective outdoor unit PCB

Troubleshooting

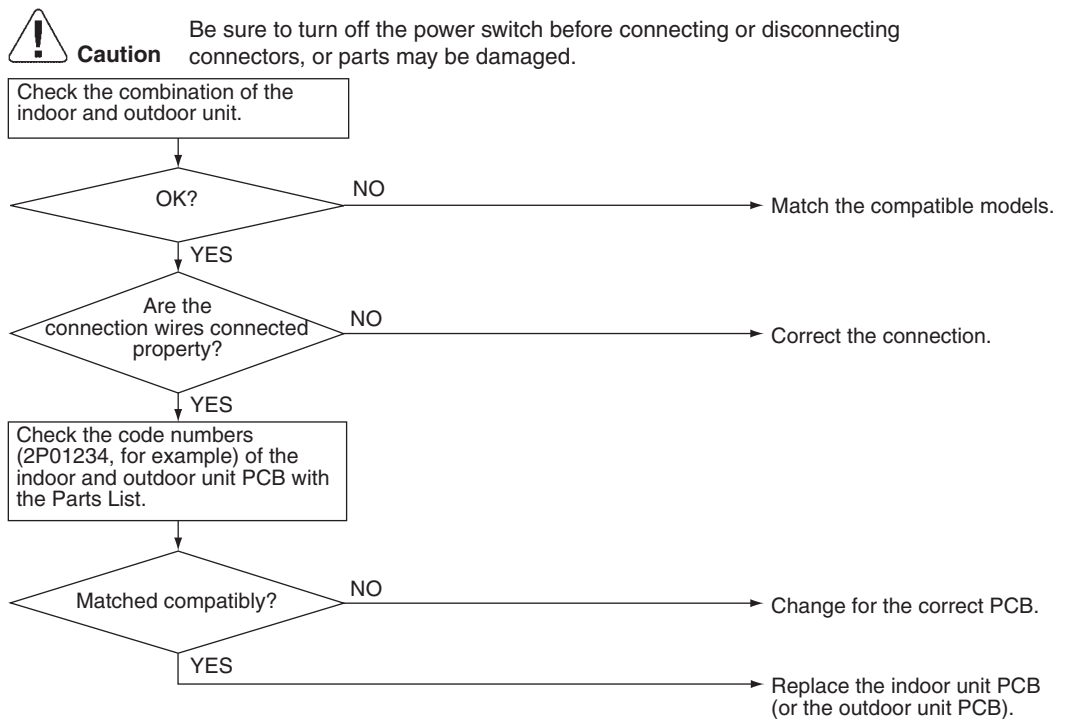

(R11707)

4.8 Outdoor Unit PCB Abnormality

Remote Control Display

E1

Method of Malfunction Detection

- Detection within the program of the microcomputer

Malfunction Decision Conditions

- The program of the microcomputer is in abnormal running order.

Supposed Causes

- Defective outdoor unit PCB
- Noise
- Momentary fall of voltage
- Momentary power failure

Troubleshooting

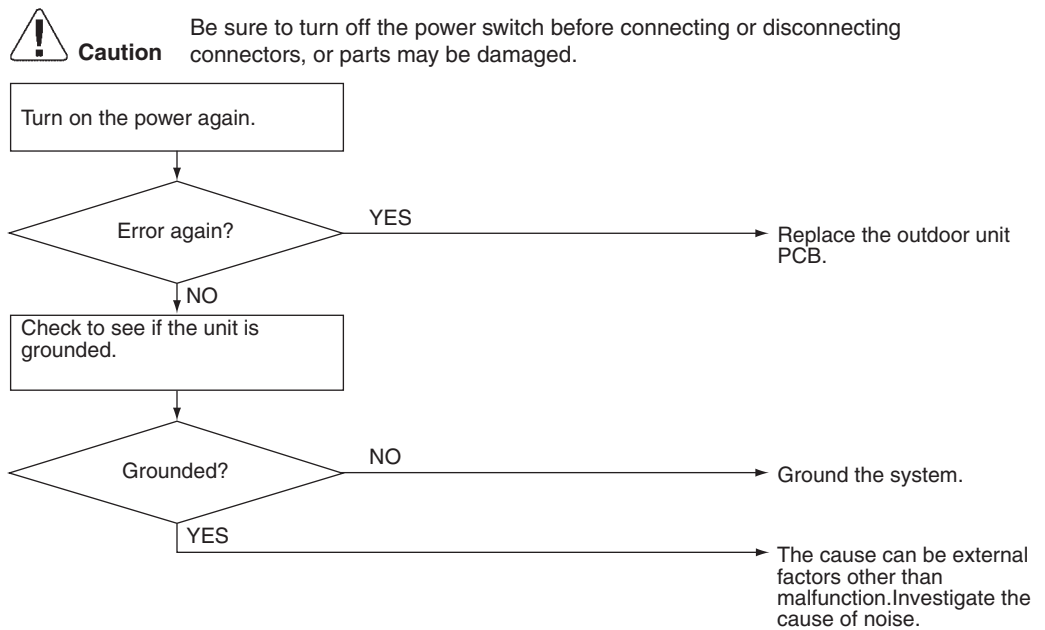

(R7183)

4.9 OL Activation (Compressor Overload)

Remote Control
Display

E5

Method of
Malfunction
Detection

A compressor overload is detected through compressor OL.

Malfunction
Decision
Conditions

- If the error repeats twice, the system is shut down.
- Reset condition: Continuous run for about 60 minutes without any other error
- * The operating temperature condition is not specified.

Supposed
Causes

- Defective discharge pipe thermistor
- Defective electronic expansion valve or coil
- Defective four way valve or coil
- Defective outdoor unit PCB
- Refrigerant shortage
- Water mixed in refrigerant
- Defective stop valve

Troubleshooting

Check No.04
Refer to P.94

Check No.05
Refer to P.95

Check No.06
Refer to P.96

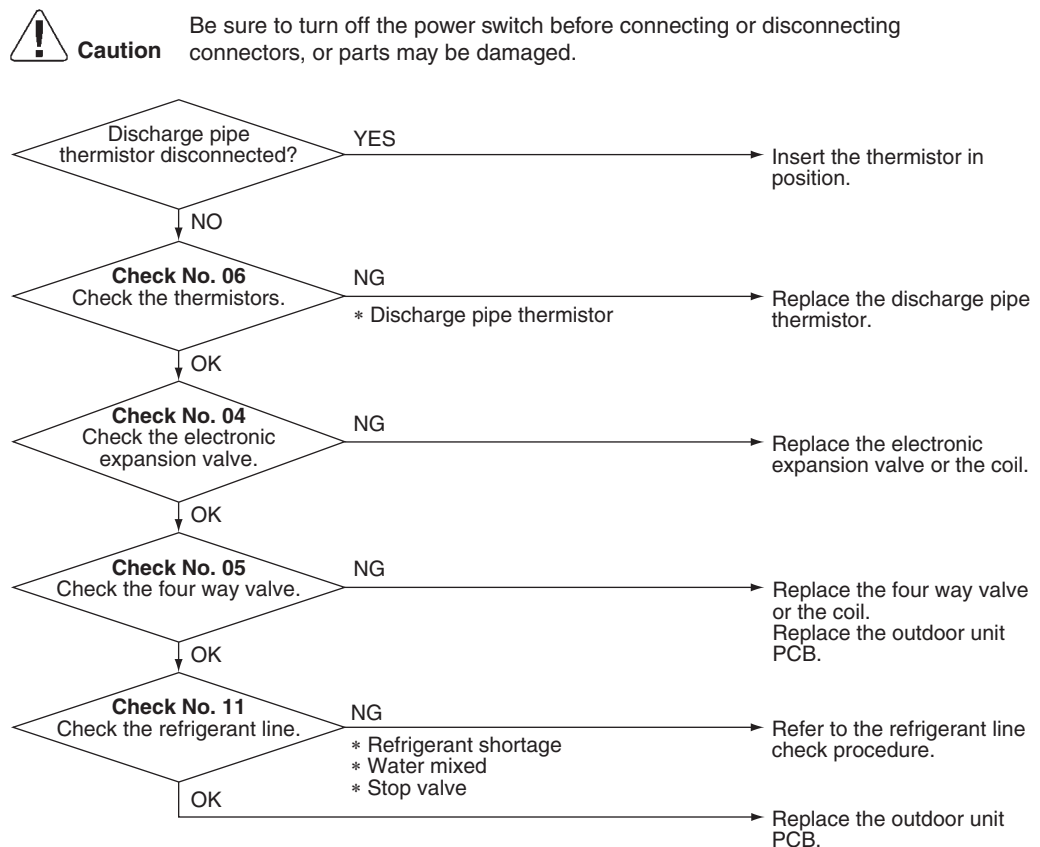

Check No.11
Refer to P.98



4.10 Compressor Lock

Remote Control Display	EE
Method of Malfunction Detection	A compressor lock is detected by checking the compressor running condition through the position detection circuit.
Malfunction Decision Conditions	<ul style="list-style-type: none"> ■ Judging from the current waveform generated when high-frequency voltage is applied to the compressor. ■ If the error repeats 16 times, the system is shut down. ■ Reset condition: Continuous run for about 5 minutes without any other error
Supposed Causes	<ul style="list-style-type: none"> ■ Compressor locked ■ Disconnection of compressor harness

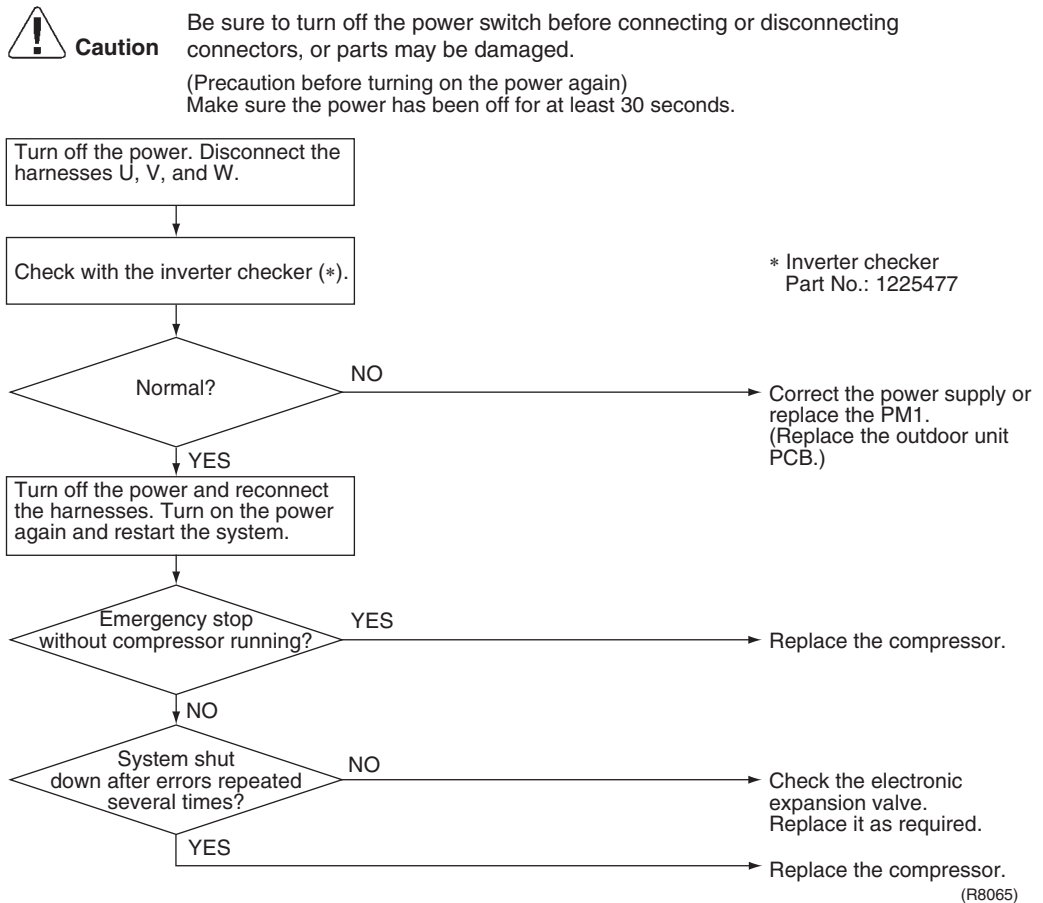
Troubleshooting



4.11 DC Fan Lock

Remote Control Display **E7**

Method of Malfunction Detection

An error is determined with the high-voltage fan motor rotation speed detected by the Hall IC.

Malfunction Decision Conditions

- The fan does not start in 30 seconds even when the fan motor is running.
- If the error repeats 16 times, the system is shut down.
- Reset condition: Continuous run for about 5 minutes without any other error

Supposed Causes

- Disconnection of the fan motor
- Foreign matters stuck in the fan
- Defective fan motor
- Defective outdoor unit PCB

Troubleshooting

Check No.15
 Refer to P.100

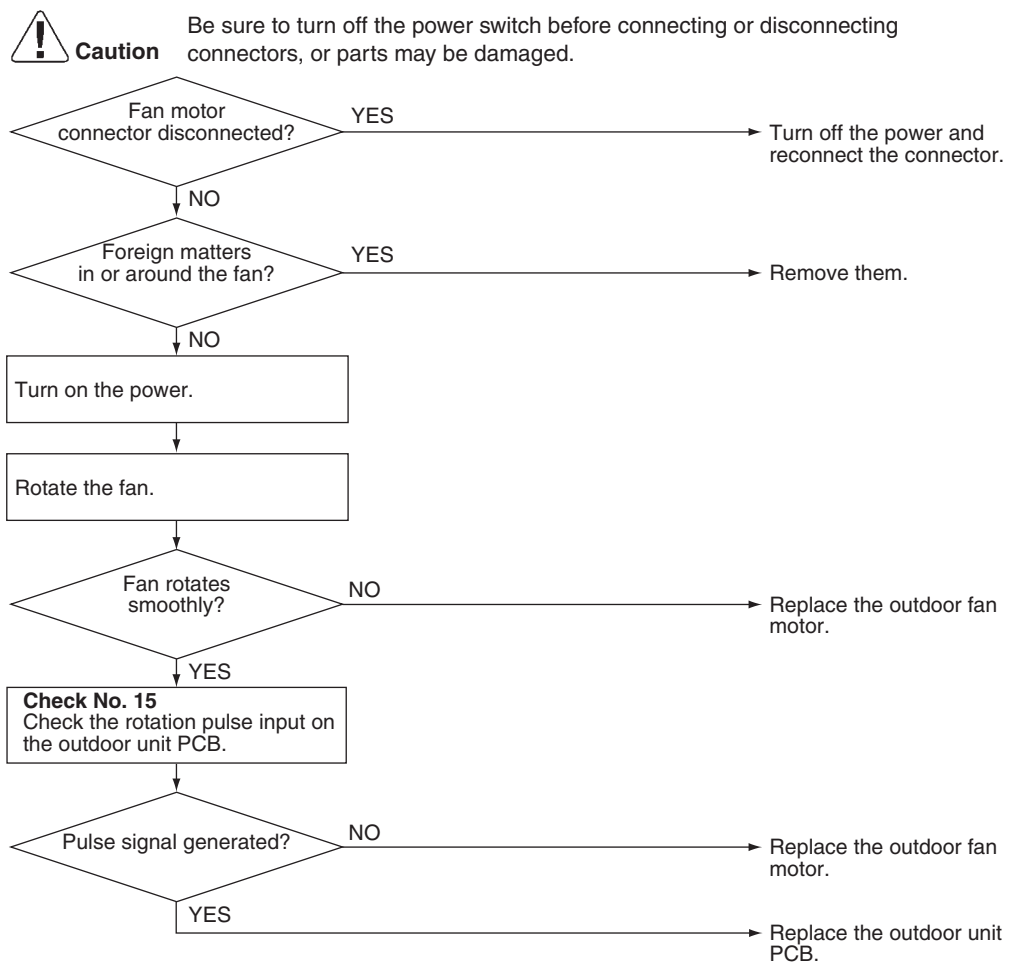

4.12 Input Overcurrent Detection

Remote Control Display **EE**

Method of Malfunction Detection

An input overcurrent is detected by checking the input current value being detected by CT with the compressor running.

Malfunction Decision Conditions

- The following CT input with the compressor running continues for 2.5 seconds.
CT input : Above 20 A

Supposed Causes

- Defective compressor
- Defective power module
- Defective outdoor unit PCB
- Short circuit

Troubleshooting



Check No.07
Refer to P.97

Check No.08
Refer to P.97

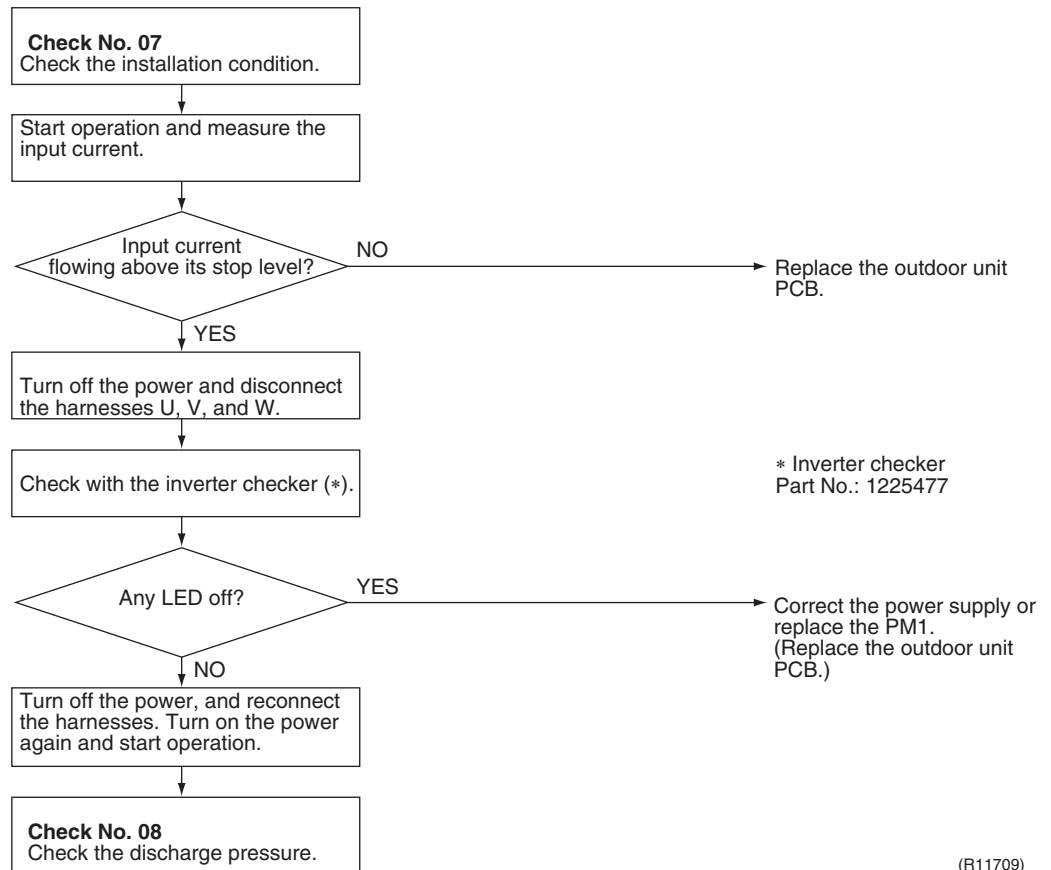

Caution Be sure to turn off the power switch before connecting or disconnecting connectors, or parts may be damaged.

* An input overcurrent may result from wrong internal wiring. If the wires have been disconnected and reconnected for part replacement, for example, and the system is interrupted by an input overcurrent, take the following procedure.



4.13 Four Way Valve Abnormality

Remote Control
Display

EA

Method of
Malfunction
Detection

The room temperature thermistor, the indoor heat exchanger thermistor, the outdoor temperature thermistor, and the outdoor heat exchanger thermistor are checked if they function within their normal ranges in each operation mode.

Malfunction
Decision
Conditions

A following condition continues over 1 minute after operating for 10 minutes.

- Cooling / Dry
(room thermistor temp. – indoor heat exchanger temp.) < -5°C
- Heating
(indoor heat exchanger temp. – room thermistor temp.) < -5°C
- If the error repeats 5 times, the system is shut down.
- Reset condition: Continuous run for about 60 minutes without any other error

Supposed
Causes

- Disconnection of four way valve coil
- Defective four way valve, coil, or harness
- Defective outdoor unit PCB
- Defective thermistor
- Refrigerant shortage
- Water mixed in refrigerant
- Defective stop valve

Troubleshooting



Check No.05
 Refer to P.95

Check No.06
 Refer to P.96

Check No.11
 Refer to P.98

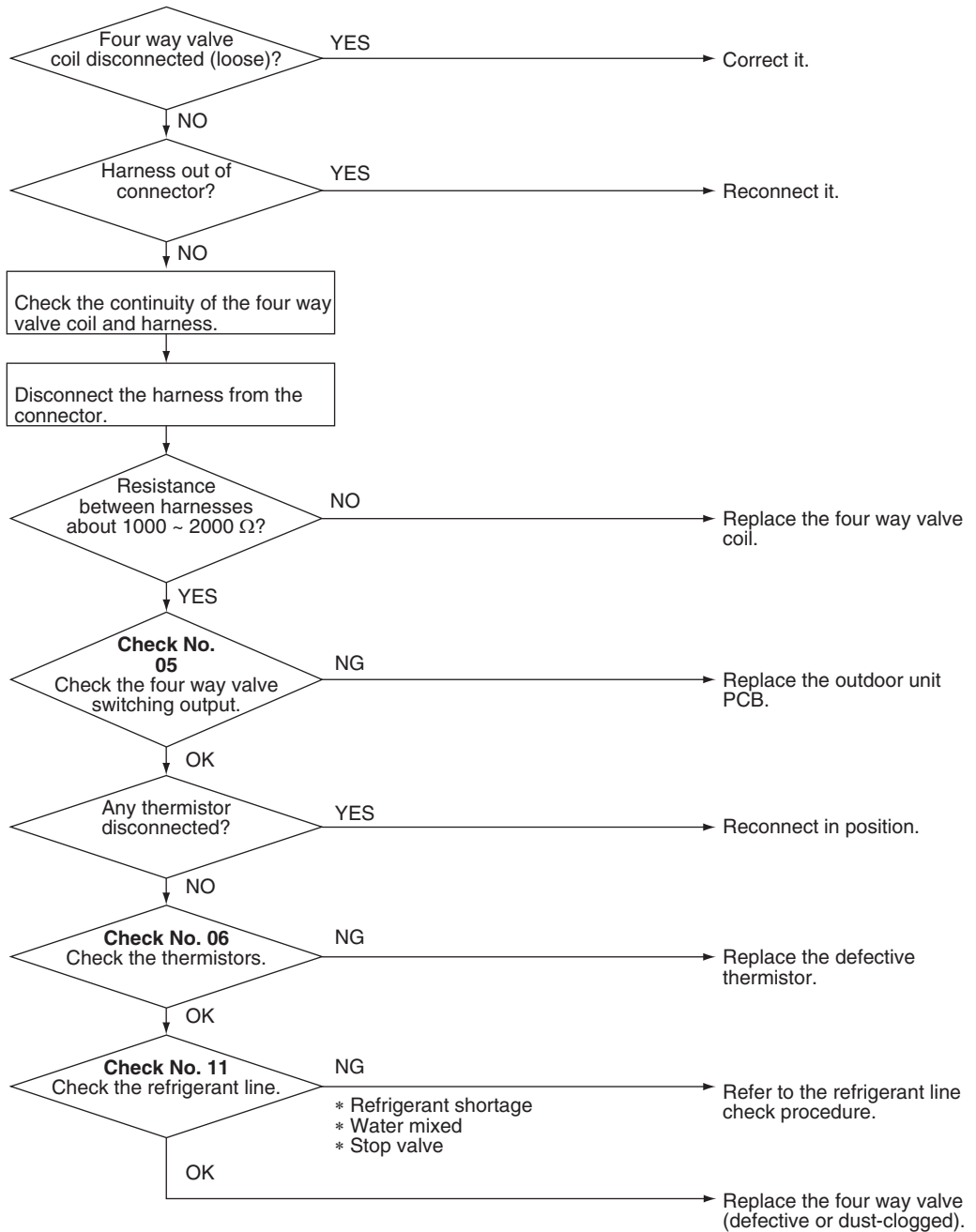

Caution Be sure to turn off the power switch before connecting or disconnecting connectors, or parts may be damaged.



(R11710)

4.14 Discharge Pipe Temperature Control

Remote Control Display **F3**

Method of Malfunction Detection

An error is determined with the temperature detected by the discharge pipe thermistor.

Malfunction Decision Conditions

- If the temperature detected by the discharge pipe thermistor rises above Δ °C, the compressor stops.
- The error is cleared when the temperature is dropped below B °C.

Δ (°C)	B (°C)
110	95

- If the error repeats 6 times, the system is shut down.
- Reset condition: Continuous run for about 60 minutes without any other error

Supposed Causes

- Defective discharge pipe thermistor
(Defective outdoor heat exchanger thermistor or outdoor temperature thermistor)
- Defective electronic expansion valve or coil
- Refrigerant shortage
- Defective four way valve
- Water mixed in refrigerant
- Defective stop valve
- Defective outdoor unit PCB

Troubleshooting

Check No.04
Refer to P.94

Check No.06
Refer to P.96

Check No.11
Refer to P.98

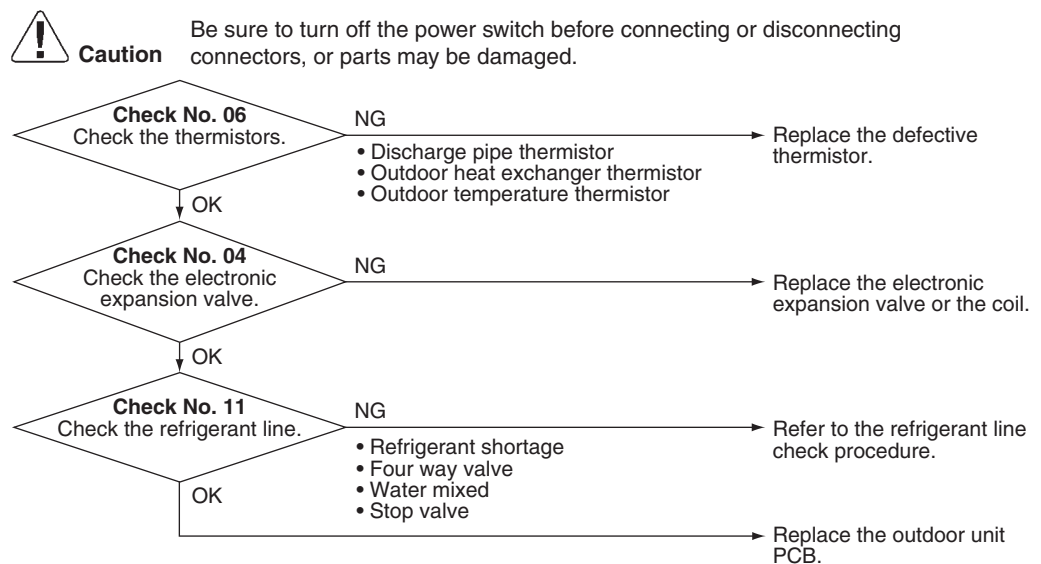

(R7141)

4.15 High Pressure Control in Cooling

Remote Control Display

FG

Method of Malfunction Detection

High-pressure control (operation half, frequency drop, etc.) is activated in cooling mode if the temperature sensed by the outdoor heat exchanger thermistor exceeds the limit.

Malfunction Decision Conditions

- The temperature sensed by the outdoor heat exchanger thermistor rises above about 60°C.
- The error is cleared when the temperature drops below about 50°C.

Supposed Causes

- The installation space is not large enough.
- Dirty outdoor heat exchanger
- Defective outdoor fan motor
- Defective stop valve
- Defective electronic expansion valve or coil
- Defective outdoor heat exchanger thermistor
- Defective outdoor unit PCB

Troubleshooting

- 

Check No.04
Refer to P.94
- 

Check No.06
Refer to P.96
- 

Check No.07
Refer to P.97
- 

Check No.08
Refer to P.97
- 

Check No.09
Refer to P.98

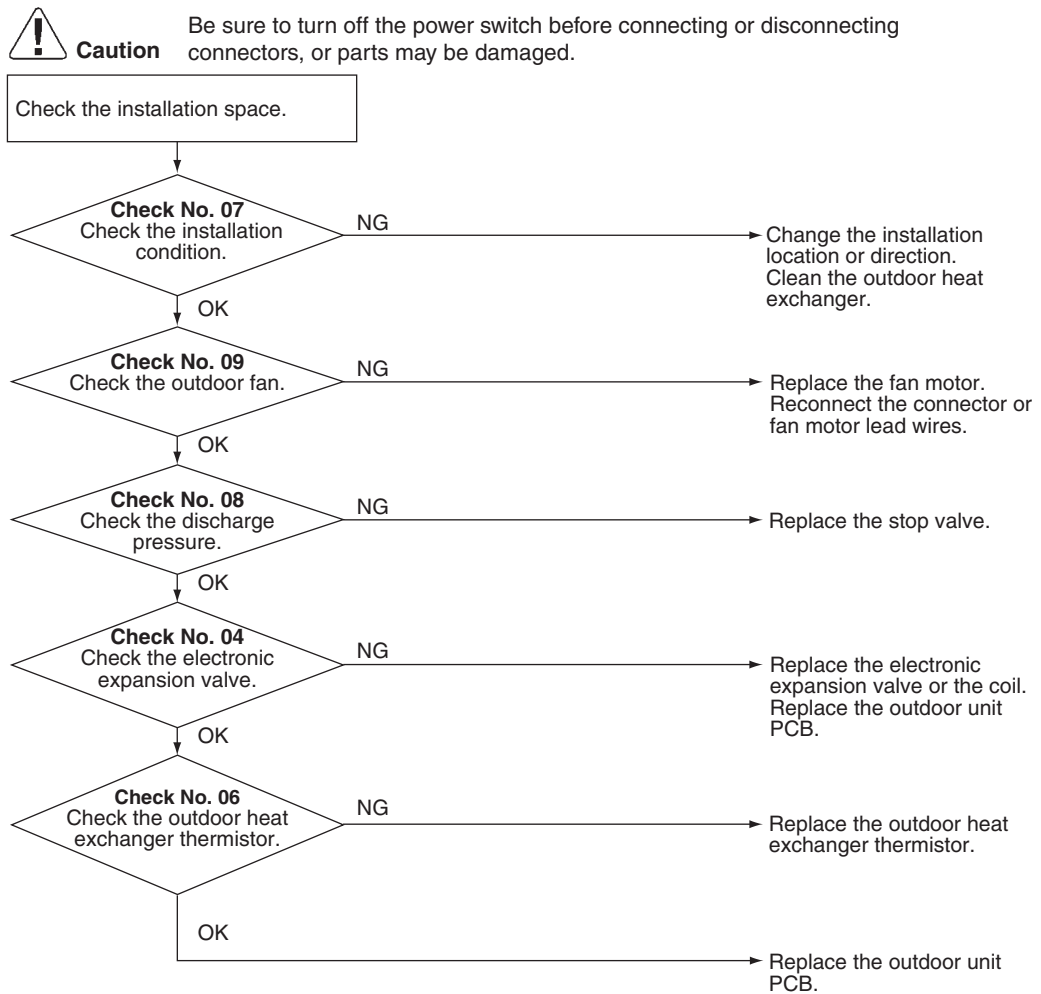

(R11897)

4.16 Compressor System Sensor Abnormality

Remote Control
Display

HO

Method of
Malfunction
Detection

- The system checks the supply voltage and the DC voltage before the compressor starts.
- The system checks the compressor current right after the compressor starts.

Malfunction
Decision
Conditions

- The supply voltage and the DC voltage is obviously low or high.
- The compressor current does not run when the compressor starts.

Supposed
Causes

- Disconnection of reactor
- Disconnection of compressor harness
- Defective outdoor unit PCB
- Defective compressor

Troubleshooting

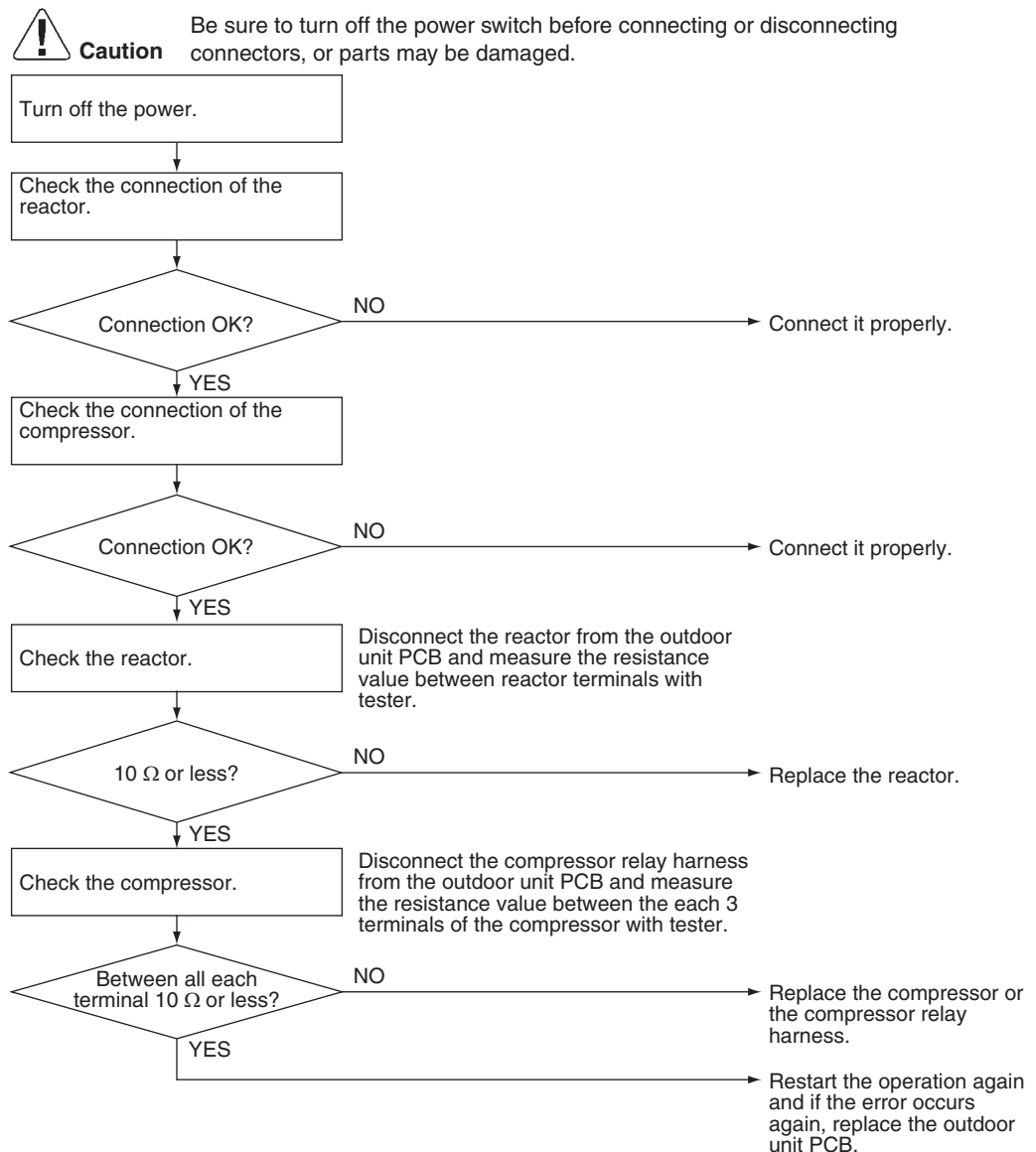

(R7174)

4.17 Position Sensor Abnormality

Remote Control
Display

H6

Method of
Malfunction
Detection

A compressor start-up failure is detected by checking the compressor running condition through the position detection circuit.

Malfunction
Decision
Conditions

- If the error repeats 8 times, the system is shut down.
 - Reset condition: Continuous run for about 5 minutes without any other error
-

Supposed
Causes

- Disconnection of the compressor relay cable
- Defective compressor
- Defective outdoor unit PCB
- Start-up failure caused by the closed stop valve
- Input voltage out of specification

Troubleshooting

**Caution**

Be sure to turn off the power switch before connecting or disconnecting connectors, or parts may be damaged.

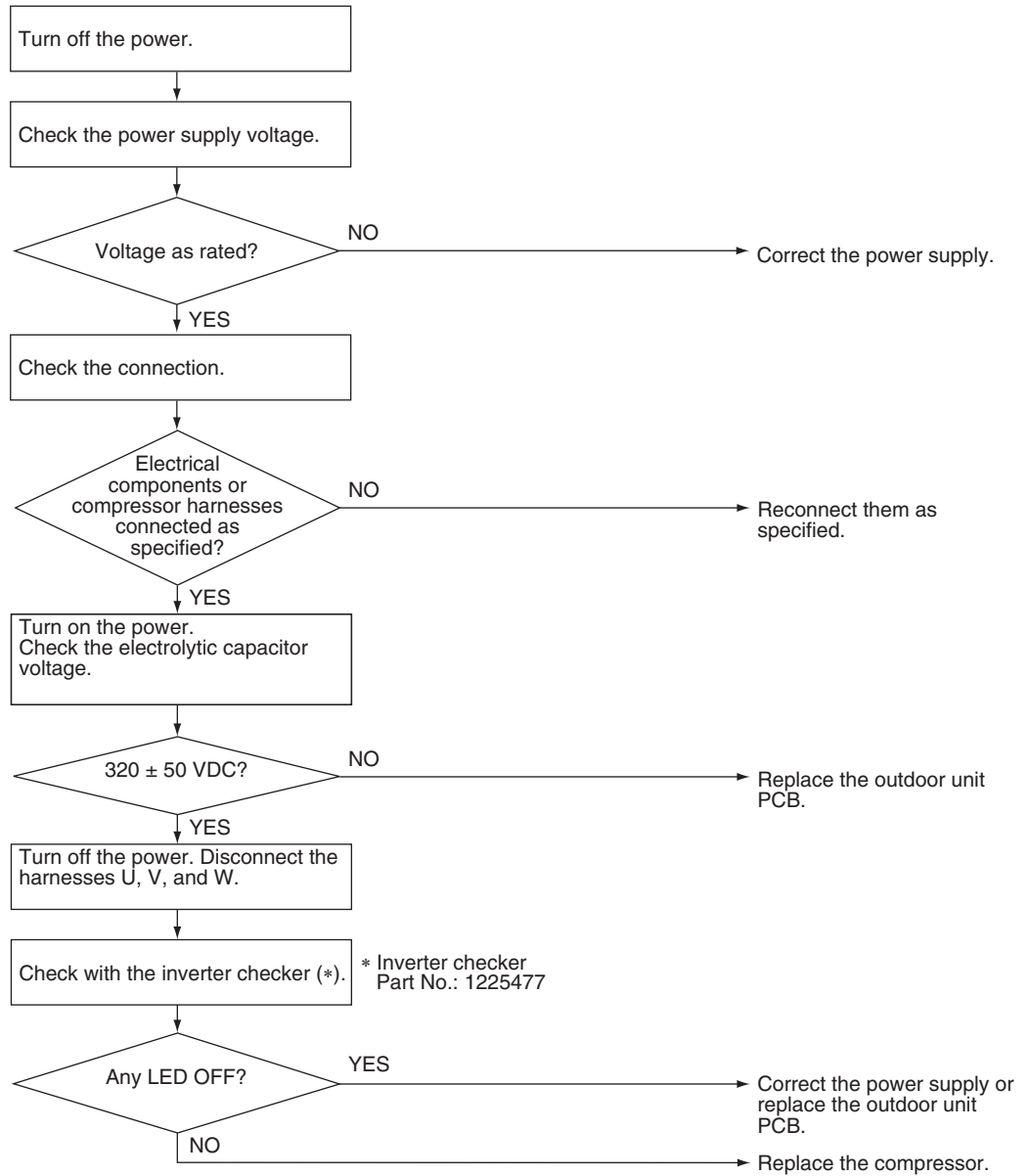

(R11471)

4.18 CT or Related Abnormality

Remote Control Display *H8*

Method of Malfunction Detection A CT or related error is detected by checking the compressor running frequency and CT-detected input current.

Malfunction Decision Conditions ■ The compressor running frequency is more than Δ Hz, and the CT input current is below B A.

Δ (Hz)	B (A)
55	0.5

- If the error repeats 4 times, the system is shut down.
- Reset condition: Continuous run for about 60 minutes without any other error

Supposed Causes

- Defective power module
- Breakage of wiring or disconnection
- Defective reactor
- Defective outdoor unit PCB

Troubleshooting

Check No.12
Refer to P.99



Caution

Be sure to turn off the power switch before connecting or disconnecting connectors, or parts may be damaged.

Turn off the power and turn it on again.

Start operation.

* Running current as shown at right with relay cable 1 or 2?

YES

Replace the outdoor unit PCB.

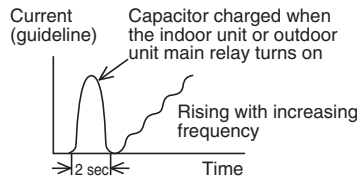

Check No. 12
Check the capacitor voltage.

320 ± 50 VDC?

YES

Turn off the power. Disconnect the harnesses U, V, and W.

Check with the inverter checker (*).

* Inverter checker
Part No.: 1225477

Any LED OFF?

YES

Correct the power supply or replace the PM1.
(Replace the outdoor unit PCB.)

NO

Turn off the power and reconnect the harnesses. Then turn on the power again and restart operation.

Compressor running?

YES

Replace the outdoor unit PCB.

NO

Replace the compressor.

Voltage within the allowable range (Supply voltage ± 15%)?

YES

Replace the outdoor unit PCB.

NO

Check the supply voltage.

(R11134)

4.19 Thermistor or Related Abnormality (Outdoor Unit)

Remote Control Display

H9, J3, J6, P4

Method of Malfunction Detection

This type of error is detected by checking the thermistor input voltage to the microcomputer. A thermistor error is detected by checking the temperature sensed by each thermistor.

Malfunction Decision Conditions

- The thermistor input voltage is above 4.96 V or below 0.04 V with the power on.
- *J3* error is judged if the discharge pipe temperature is lower than the outdoor heat exchanger temperature.

Supposed Causes

- Disconnection of the connector for the thermistor
- Defective thermistor
- Defective heat exchanger thermistor in the case of *J3* error (outdoor heat exchanger thermistor in cooling operation, or indoor heat exchanger thermistor in heating operation)
- Defective outdoor unit PCB
- Defective indoor unit PCB

Troubleshooting

In case of "*P4*"



Caution

Be sure to turn off the power switch before connecting or disconnecting connectors, or parts may be damaged.

Replace the outdoor unit PCB.

P4 : Radiation fin thermistor

Troubleshooting



Check No.06
Refer to P.96

In case of "H9" "J3" "J5"



Caution

Be sure to turn off the power switch before connecting or disconnecting connectors, or parts may be damaged.

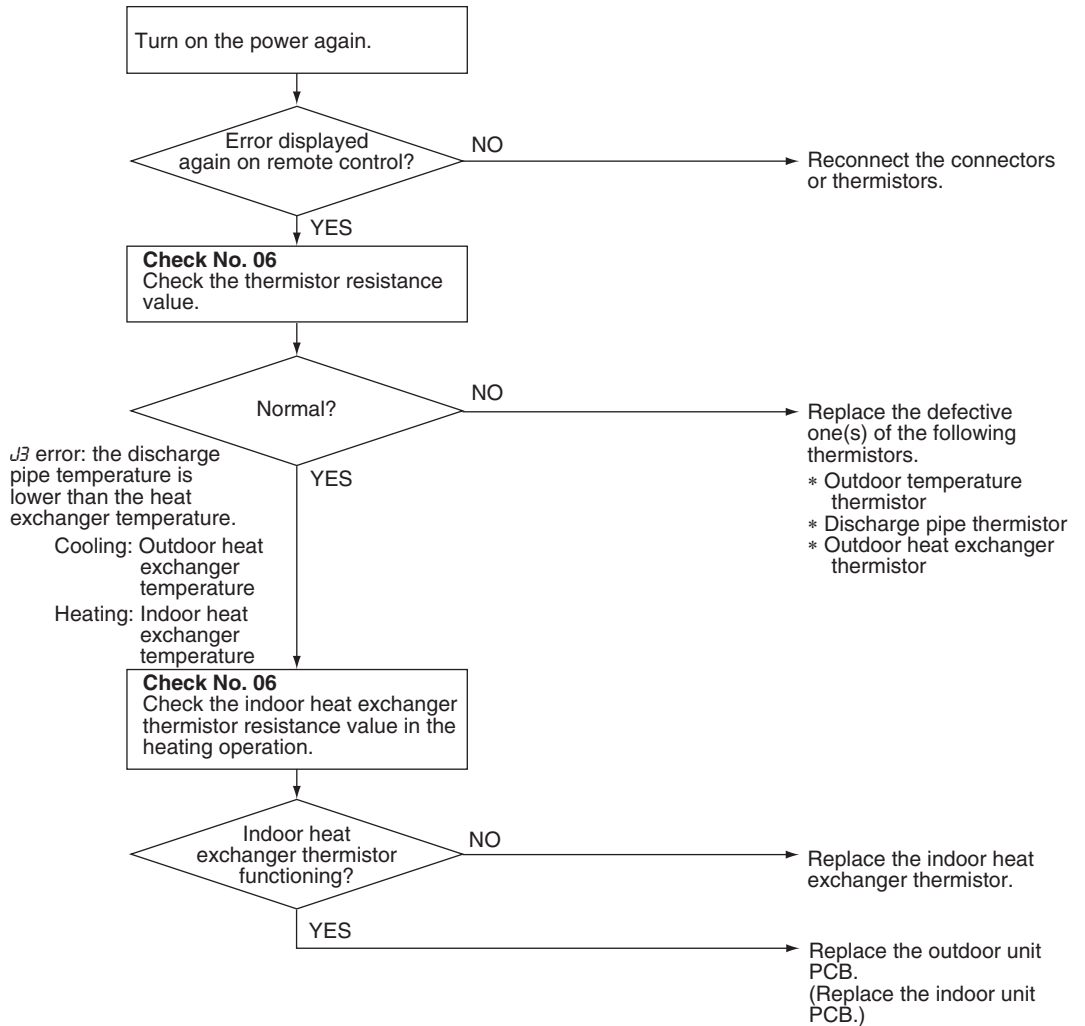

(R11905)

H9 : Outdoor temperature thermistor

J3 : Discharge pipe thermistor

J5 : Outdoor heat exchanger thermistor

4.20 Electrical Box Temperature Rise

Remote Control Display **L3**

Method of Malfunction Detection An electrical box temperature rise is detected by checking the radiation fin thermistor with the compressor off.

Malfunction Decision Conditions

- With the compressor off, the radiation fin temperature is above **A** °C.
- The error is cleared when the radiation fin temperature drops below **B** °C.
- To cool the electrical components, the outdoor fan starts when the radiation fin temperature rises above **C** °C and stops when it drops below **B** °C.

A (°C)	95
B (°C)	80
C (°C)	85

Supposed Causes

- Defective outdoor fan motor
- Short circuit
- Defective radiation fin thermistor
- Disconnection of connector
- Defective outdoor unit PCB

Troubleshooting

Check No.07
 Refer to P.97

Check No.09
 Refer to P.98

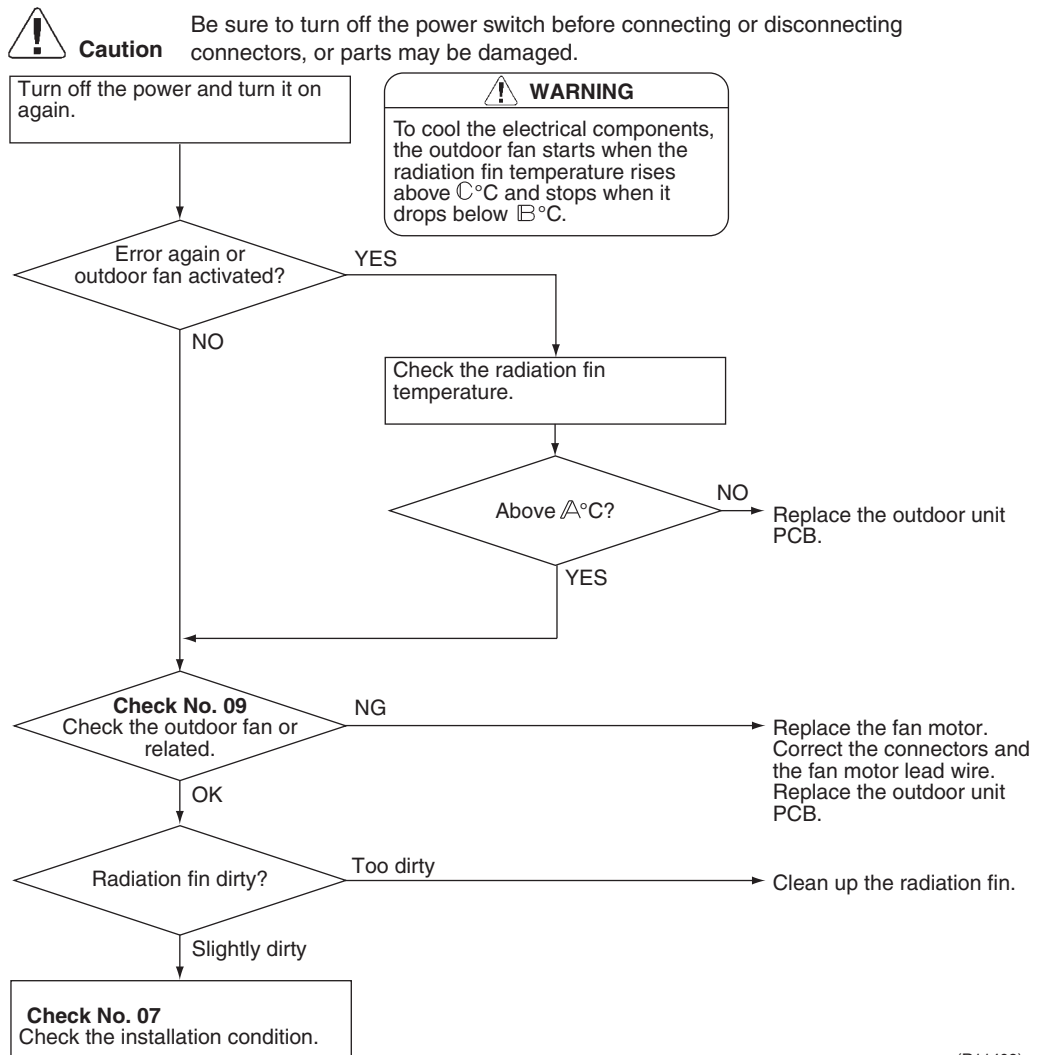

(R11409)

A (°C)	95
B (°C)	80
C (°C)	85

4.21 Radiation Fin Temperature Rise

Remote Control
Display

L4

Method of
Malfunction
Detection

A radiation fin temperature rise is detected by checking the radiation fin temperature with the compressor on.

Malfunction
Decision
Conditions

- The radiation fin temperature with the compressor on is above A °C.
- The error is cleared when the radiation fin temperature drops below B °C.

A (°C)	105
B (°C)	99

- If the error repeats, the system is shut down.
- Reset condition: Continuous run for about 60 minutes without any other error

Supposed
Causes

- Defective outdoor fan motor
- Short circuit
- Defective radiation fin thermistor
- Disconnection of connector
- Defective outdoor unit PCB
- Silicon grease is not applied properly on the radiation fin after replacing the outdoor unit PCB.

Troubleshooting

Check No.07
 Refer to P.97

Check No.09
 Refer to P.98

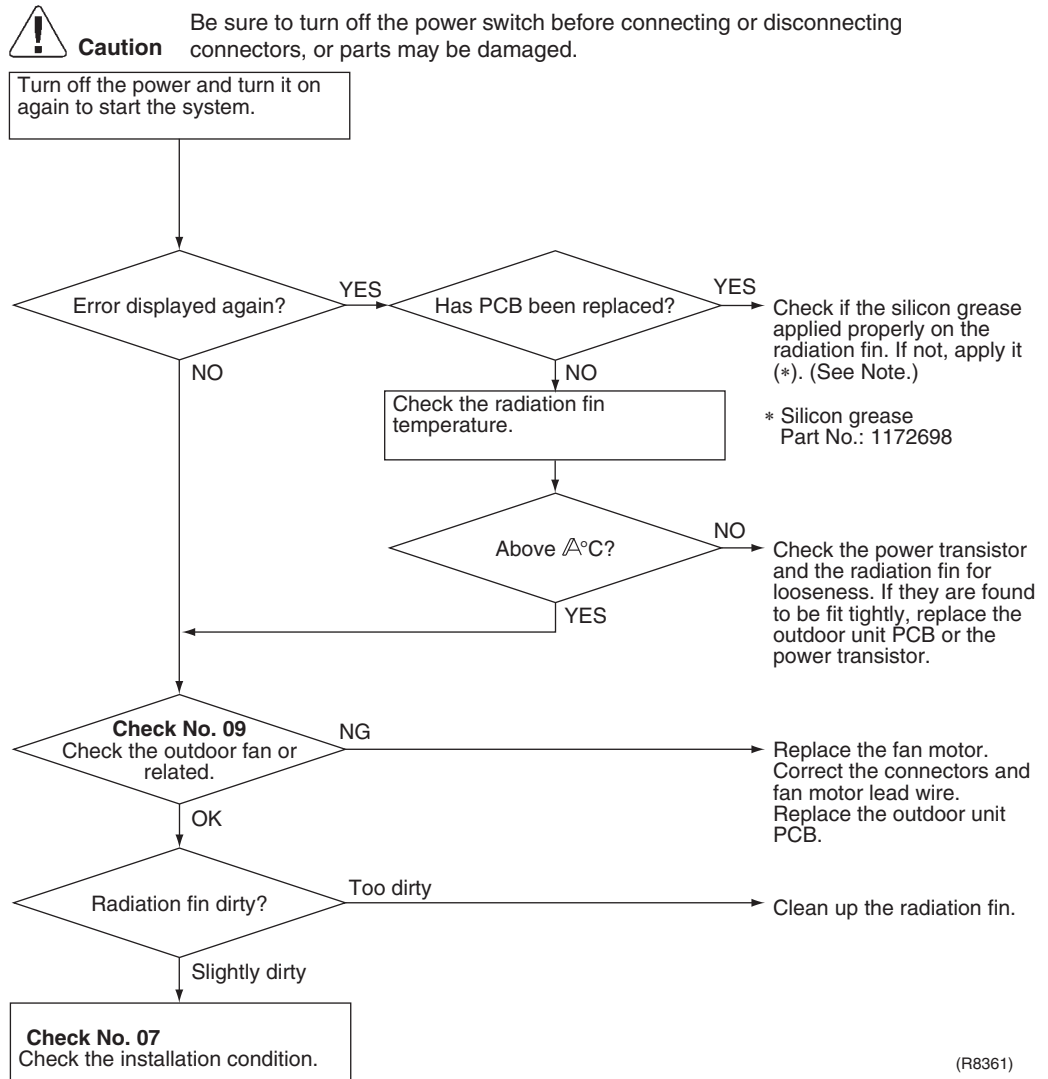

Δ (°C)	105
--------	-----

 **Note1:** Refer to “Application of silicon grease to a power transistor and a diode bridge” on page 129 for detail.

4.22 Output Overcurrent Detection

Remote Control Display *L5*

Method of Malfunction Detection

An output overcurrent is detected by checking the current that flows in the inverter DC section.

Malfunction Decision Conditions

- A position signal error occurs while the compressor is running.
 - A speed error occurs while the compressor is running.
 - An output overcurrent signal is fed from the output overcurrent detection circuit to the microcomputer.
 - If the error repeats 16 times, the system is shut down.
 - Reset condition: Continuous run for about 5 minutes without any other error
-

Supposed Causes

- Poor installation condition
- Closed stop valve
- Defective power module
- Wrong internal wiring
- Abnormal supply voltage
- Defective outdoor unit PCB
- Defective compressor

Troubleshooting



Check No.07
 Refer to P.97

Check No.08
 Refer to P.97

Check No.13
 Refer to P.99

 **Caution** Be sure to turn off the power switch before connecting or disconnecting connectors, or parts may be damaged.

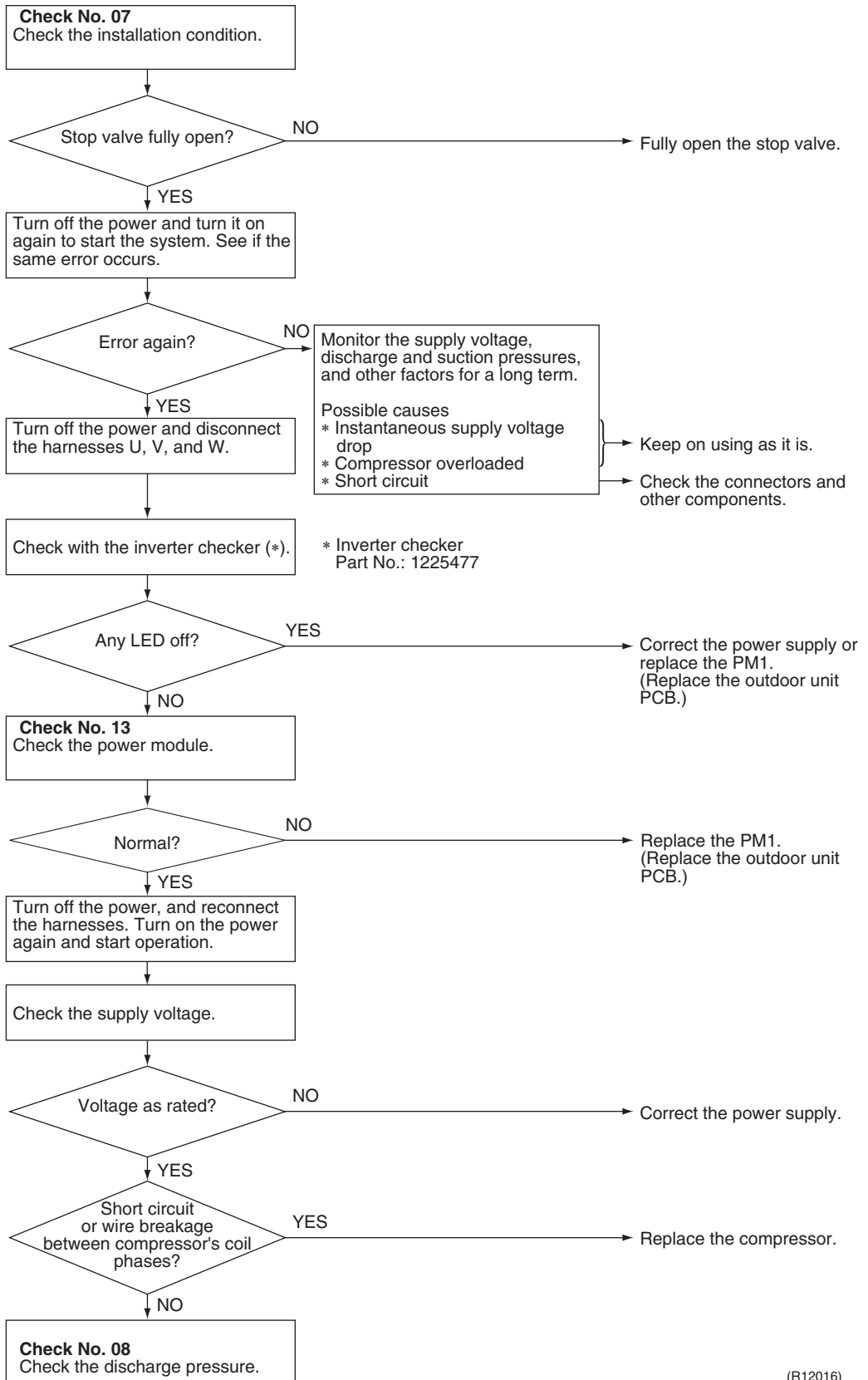
* An output overcurrent signal may result from wrong internal wiring. If the wires have been disconnected and reconnected and the system is interrupted by an output overcurrent, take the following procedure.



(R12016)

4.23 Refrigerant Shortage

Remote Control Display **U0**

Method of Malfunction Detection

Refrigerant shortage detection I:

Refrigerant shortage is detected by checking the input current value and the compressor output frequency. If the refrigerant is short, the input current is smaller than the normal value.

Refrigerant shortage detection II:

Refrigerant shortage is detected by checking the discharge pipe temperature and the opening of the electronic expansion valve. If the refrigerant is short, the discharge pipe temperature tends to rise.

Malfunction Decision Conditions

Refrigerant shortage detection I:

The following conditions continue for 7 minutes.

- ◆ DC current $\leq A \times$ Output frequency + B
- ◆ Output frequency $> C$

A (-)	B (A)	C (Hz)
18/1000	0.7	55

Refrigerant shortage detection II:

The following conditions continue for 80 seconds.

- ◆ Target opening of the electronic expansion valve $\geq D$
- ◆ Discharge pipe temperature $> E \times$ target discharge pipe temperature + F

	D (pulse)	E (-)	F (°C)
50 class	480	128/128	Cooling: 20, Heating: 45
60 class	480	128/128	Cooling: 60, Heating: 45

- If the error repeats 4 times, the system is shut down.
- Reset condition: Continuous run for about 60 minutes without any other error

Supposed Causes

- Disconnection of the discharge pipe thermistor, indoor or outdoor heat exchanger thermistor, room or outdoor temperature thermistor
- Closed stop valve
- Refrigerant shortage (refrigerant leakage)
- Poor compression performance of compressor
- Defective electronic expansion valve

Troubleshooting

Check No.04
 Refer to P.94

Check No.06
 Refer to P.96

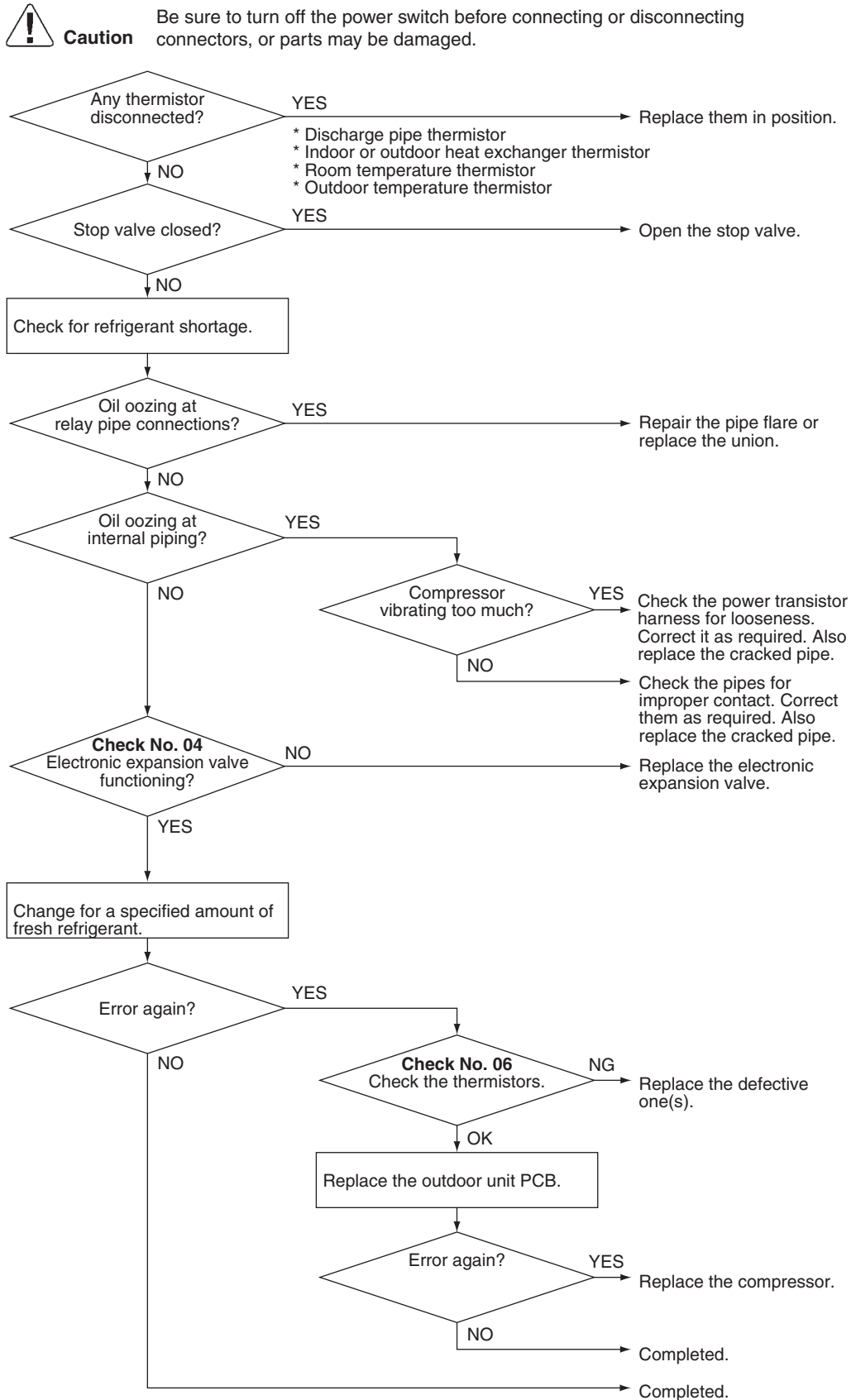

(R12027)

4.24 Low-voltage Detection or Over-voltage Detection

Remote Control Display

U2

Method of Malfunction Detection

Low-voltage detection:
An abnormal voltage drop is detected by the DC voltage detection circuit.

Over-voltage detection:
An abnormal voltage rise is detected by the over-voltage detection circuit.

Malfunction Decision Conditions

Low-voltage detection:

- The voltage detected by the DC voltage detection circuit is below 150 V.
- If the error repeats 16 times, the system is shut down.
- Reset condition: Continuous run for about 60 minutes without any other error

Over-voltage detection:

- An over-voltage signal is fed from the over-voltage detection circuit to the microcomputer.
- The compressor stops if the error occurs, and restarts automatically after 3-minute standby.

Supposed Causes

- Supply voltage is not as specified.
- Defective DC voltage detection circuit
- Defective over-voltage detection circuit
- Defective PAM control part
- Layer short inside the fan motor winding

Troubleshooting

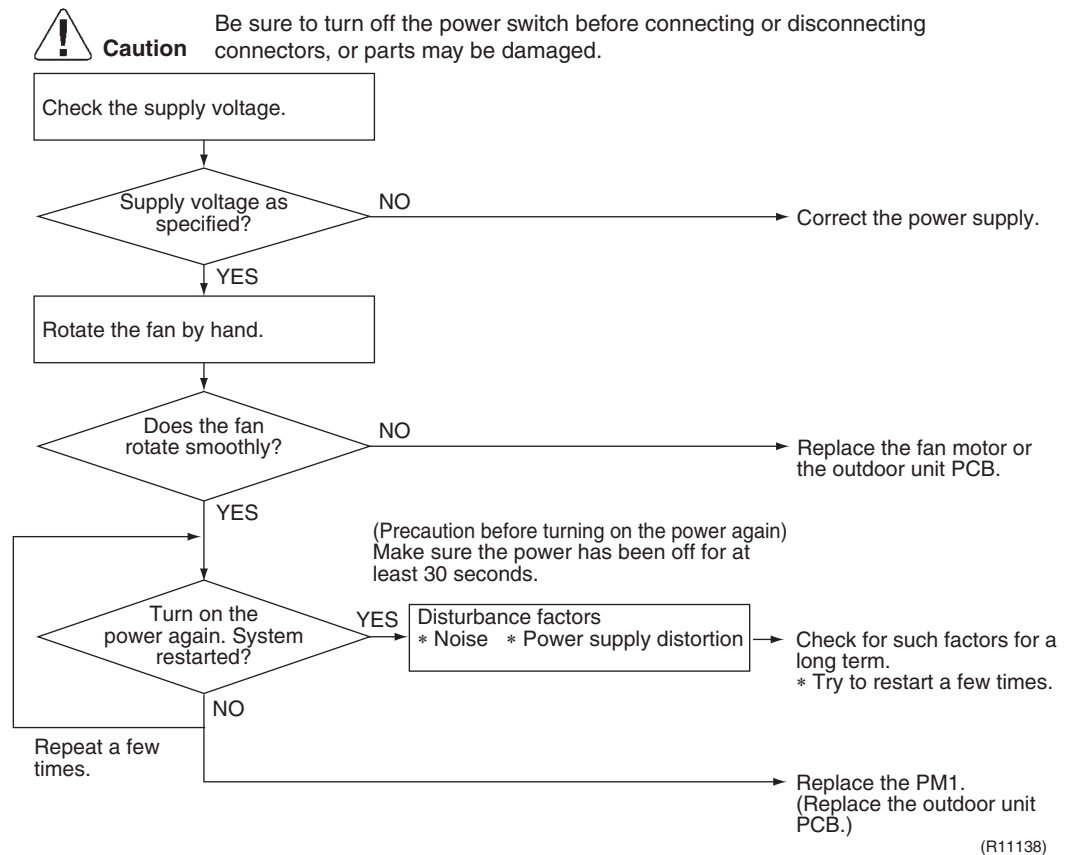

4.25 Signal Transmission Error (on Outdoor Unit PCB)

Remote Control
Display

U7

Method of
Malfunction
Detection

Communication error between microcomputer mounted on the main microcomputer and PM1.

Malfunction
Decision
Conditions

- The abnormality is determined when the data sent from the PM1 can not be received for 9 seconds.
- The error counter is reset when the data from the PM1 can be successfully received.

Supposed
Causes

- Defective outdoor unit PCB

Troubleshooting



Caution

Be sure to turn off the power switch before connecting or disconnecting connectors, or parts may be damaged.

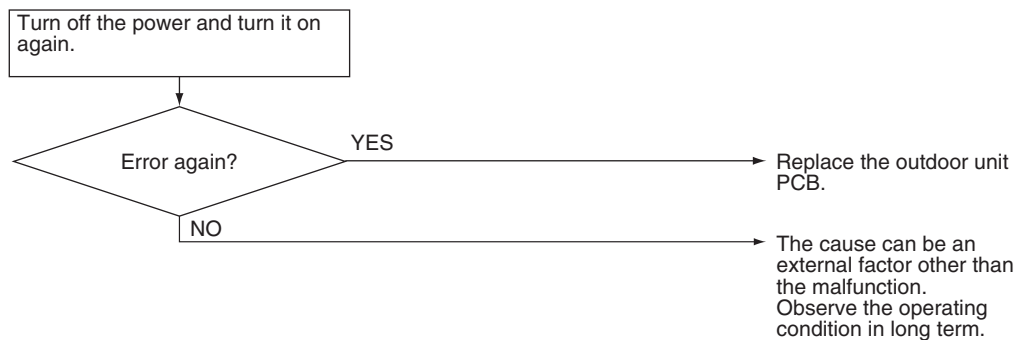

(R7185)

5. Check

5.1 How to Check

5.1.1 Electronic Expansion Valve Check

Check No.04

Conduct the followings to check the electronic expansion valve (EV).

1. Check to see if the EV connector is correctly connected to the PCB.
2. Turn the power off and on again, and check to see if the EV generate latching sound.
3. If the EV does not generate latching sound in the above step 2, disconnect the connector and check the continuity using a tester.
4. Check the continuity between the pins 1 - 6 and 3 - 6, and between the pins 2 - 5 and 4 - 5. If there is no continuity between the pins, the EV coil is faulty.

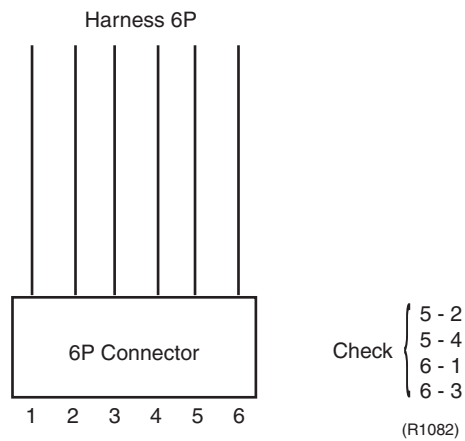

5. If the continuity is confirmed in the above step 3, the outdoor unit PCB is faulty.



Note: Please note that the latching sound varies depending on the valve type.

5.1.2 Four Way Valve Performance Check

Check No.05

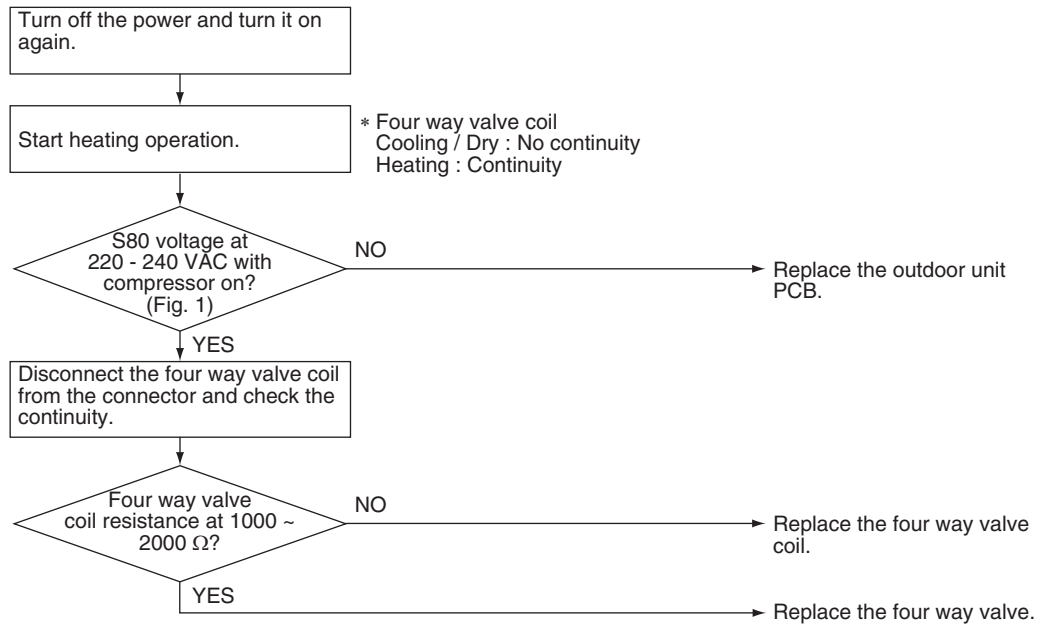

(R11903)

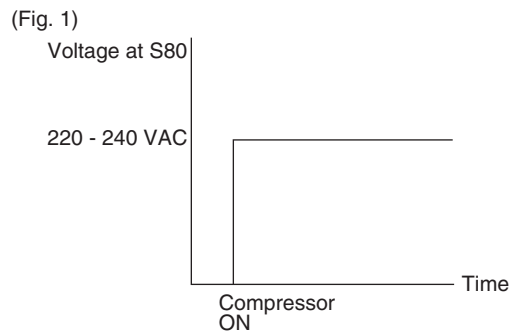

(R11904)

5.1.3 Thermistor Resistance Check

Check No.06

Disconnect the connectors of the thermistors from the PCB, and measure the resistance of each thermistor using tester.

The relationship between normal temperature and resistance is shown in the table and the graph below.

Temperature (°C)	Thermistor R25°C = 20 kΩ, B = 3950
-20	211.0 (kΩ)
-15	150.0
-10	116.5
-5	88.0
0	67.2
5	51.9
10	40.0
15	31.8
20	25.0
25	20.0
30	16.0
35	13.0
40	10.6
45	8.7
50	7.2

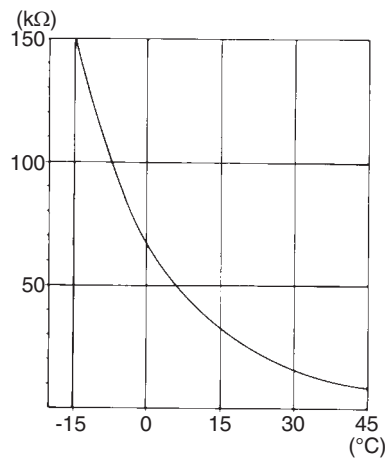

(R1190)

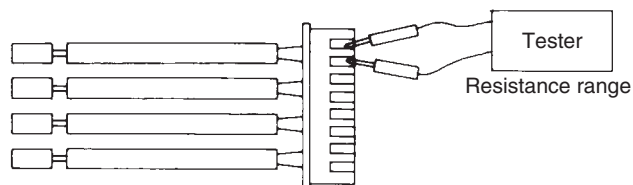

(R11906)

- For the models in which the thermistor is directly mounted on the PCB, disconnect the connector for the PCB and measure.

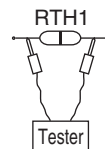

(R3460)

5.1.4 Installation Condition Check

Check No.07

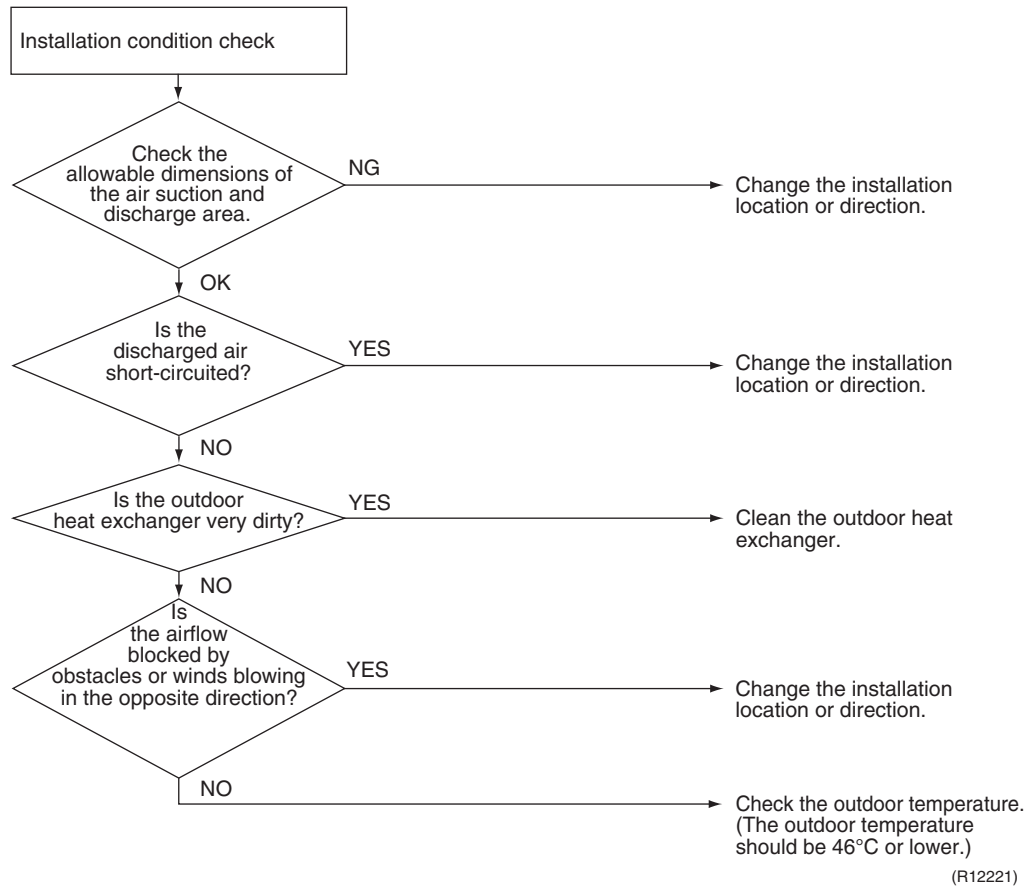

5.1.5 Discharge Pressure Check

Check No.08

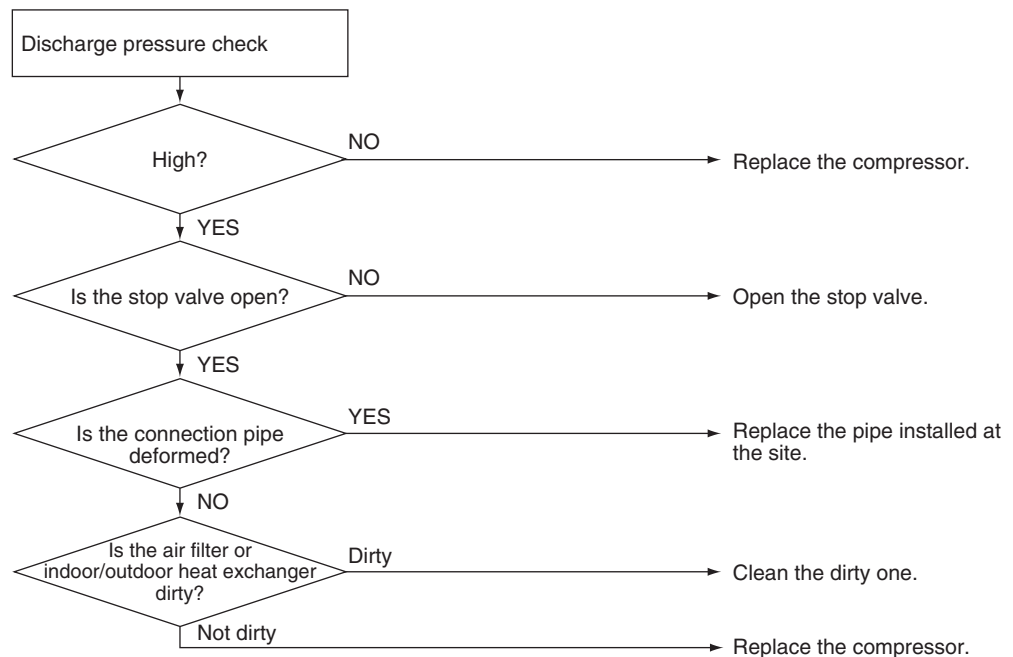

5.1.6 Outdoor Fan System Check

Check No.09

DC motor

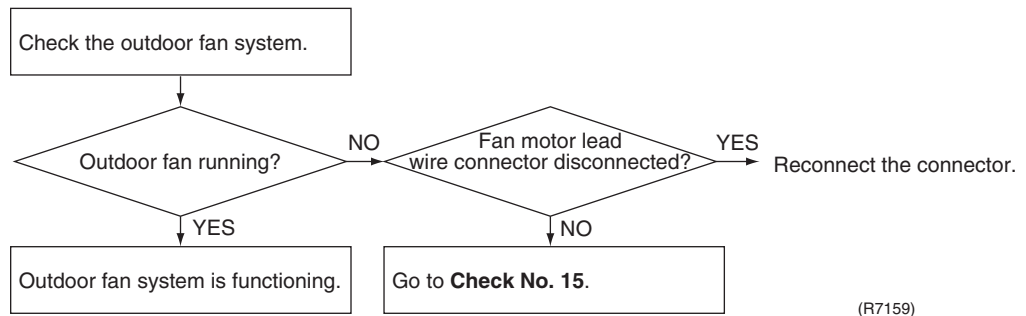

(R7159)

5.1.7 Power Supply Waveforms Check

Check No.10

Measure the power supply waveform between No.1 and No.2 on the terminal board, and check the waveform disturbance.

- Check to see if the power supply waveform is a sine wave. (Fig.1)
- Check to see if there is waveform disturbance near the zero cross. (sections circled in Fig.2)

Fig.1

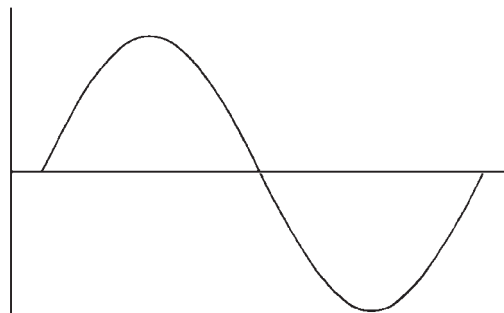

(R1736)

Fig.2

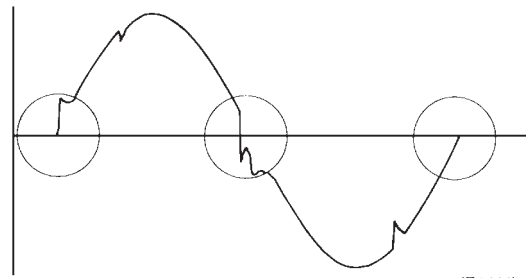

(R1444)

5.1.8 Inverter Units Refrigerant System Check

Check No.11

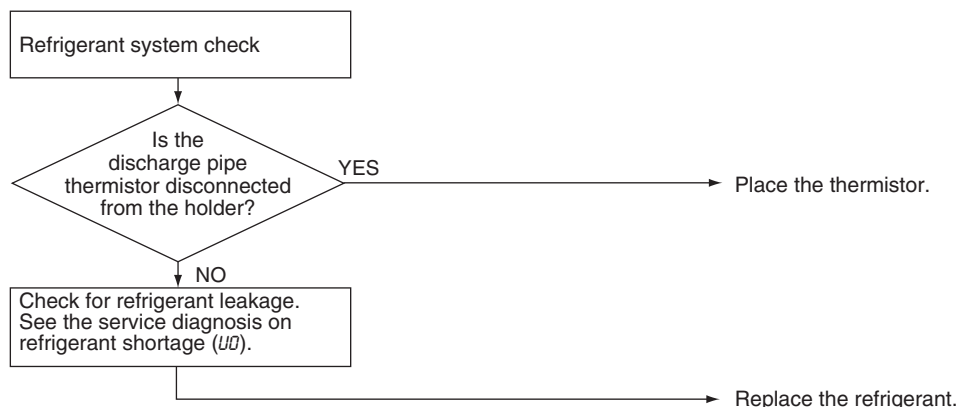

(R8380)

5.1.9 Capacitor Voltage Check

Check No.12

Before this check, be sure to check the main circuit for short circuit.
 With the circuit breaker still on, measure the voltage according to the drawing of the model in question. Be careful never to touch any live parts.

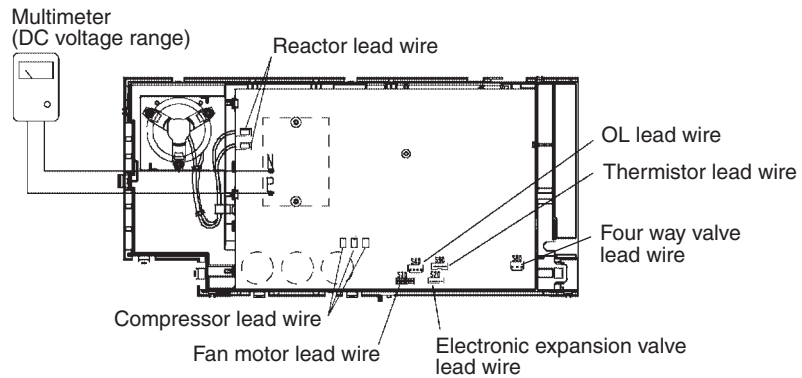

(R5222)

5.1.10 Power Module Check

Check No.13



Note: Check to make sure that the voltage between (+) and (-) of the diode bridge (DB1) is approx. 0 V before checking.

- Disconnect the compressor harness connector from the outdoor unit PCB. To disengage the connector, press the protrusion on the connector.
- Follow the procedure below to measure resistance between the terminals of the DB1 and the terminals of the compressor with a multi-tester. Evaluate the measurement results for a judgment.

Negative (-) terminal of tester (positive terminal (+) for digital tester)	DB1 (+)	UVW	DB1 (-)	UVW
Positive (+) terminal of tester (negative terminal (-) for digital tester)	UVW	DB1 (+)	UVW	DB1 (-)
Resistance in OK	several kΩ ~ several MΩ			
Resistance in NG	0 Ω or ∞			

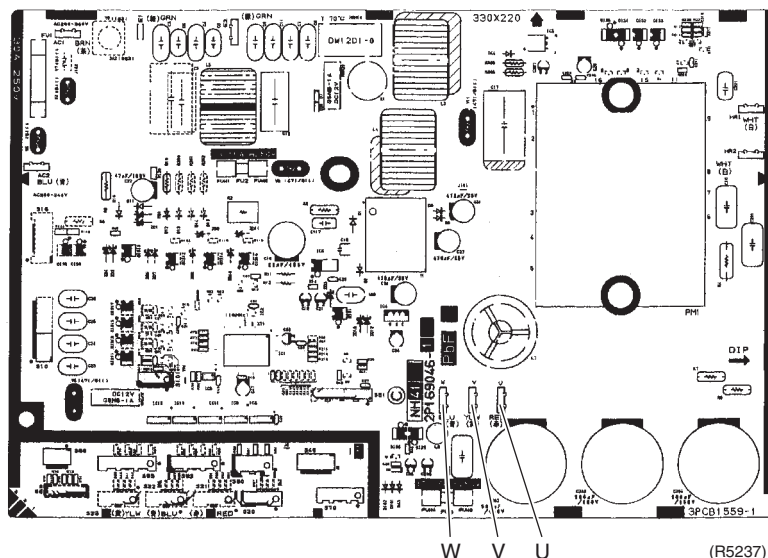

(R5237)

5.1.11 Rotation Pulse Input on the Outdoor Unit PCB Check

Check No.15

<Outdoor fan motor>

Make sure that the voltage of 320 ± 30 V is applied.

1. Set operation off and power off. Disconnect the connector S70.
2. Check that the voltage between the pins 4 - 7 is 320 VDC.
3. Check that the control voltage between the pins 3 - 4 is 15 VDC.
4. Check that the rotation command voltage between the pins 2 - 4 is 0 ~ 15 VDC.
5. Keep operation off and power off. Connect the connector S70.
6. Check whether 2 pulses (0 ~ 15 VDC) are output at the pins 1 - 4 when the fan motor is rotated 1 turn by hand.

When the fuse is melted, check the outdoor fan motor for proper function.

If NG in step 2 → Defective PCB → Replace the outdoor unit PCB.

If NG in step 4 → Defective Hall IC → Replace the outdoor fan motor.

If OK in both steps 2 and 4 → Replace the outdoor unit PCB.

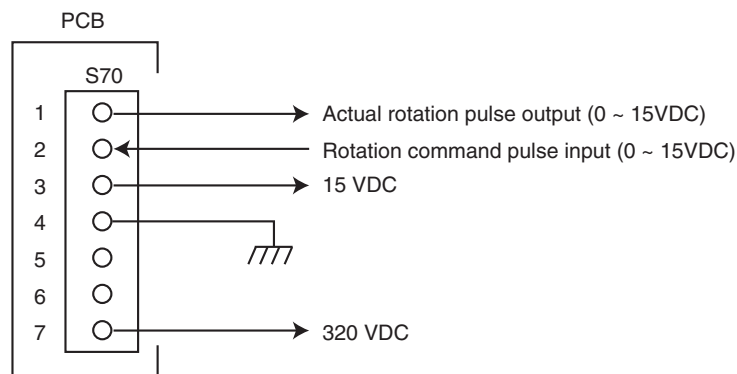

(R10811)

5.1.12 Hall IC Check

Check No.16

1. Check the connector connection.
2. With the power on, operation off, and the connector connected, check the following.
 - *Output voltage of about 5 V between pins 1 and 3.
 - *Generation of 3 pulses between pins 2 and 3 when the fan motor is operating.

If NG in step 1 → Defective PCB → Replace the PCB.

If NG in step 2 → Defective Hall IC → Replace the fan motor.

If OK in both steps 1 and 2 → Replace the PCB.

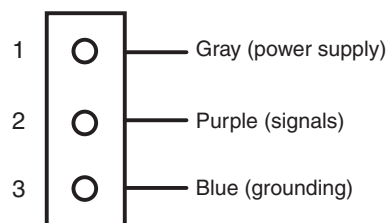

(R1990)

Part 7

Removal Procedure

1. Outdoor Unit.....	102
1.1 Removal of Outer Panels	102
1.2 Removal of Outdoor Fan / Fan Motor.....	106
1.3 Removal of Electrical Box	110
1.4 Removal of PCB.....	115
1.5 Removal of Sound Blanket / Thermistors.....	118
1.6 Removal of Four Way Valve.....	120
1.7 Removal of Electronic Expansion Valve.....	121
1.8 Removal of Compressor.....	122

1. Outdoor Unit

1.1 Removal of Outer Panels

Procedure



Warning

Be sure to wait for 10 minutes or more after turning off all power supplies before disassembling work.

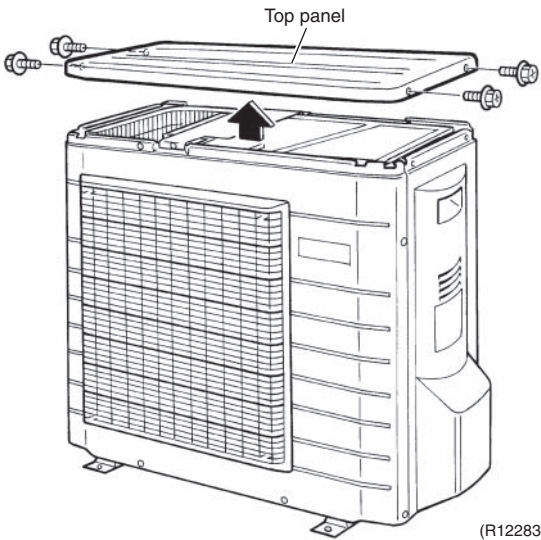
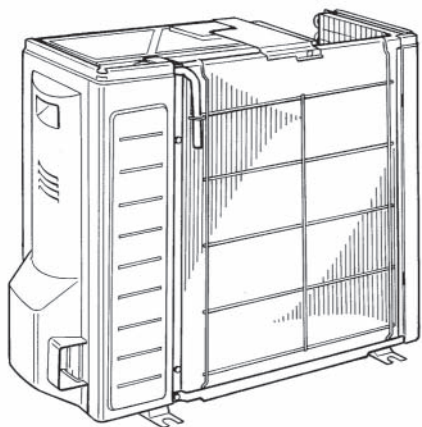
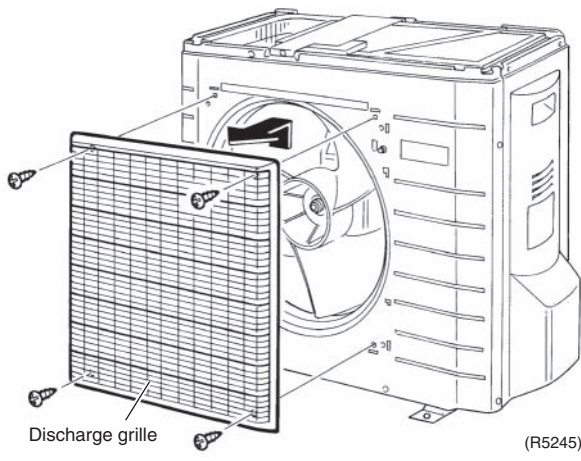
Step	Procedure	Points
1. Remove the panels.		
1	<p>Remove the 4 screws and lift the top panel.</p>  <p>(R12283)</p>  <p>(R12315)</p>	<ul style="list-style-type: none"> ■ Take care not to cut your finger by the fins of the outdoor heat exchanger.
2	<p>Remove the 4 screws and remove the discharge grille.</p>  <p>Discharge grille (R5245)</p>	<ul style="list-style-type: none"> ■ Slide the discharge grille upwards and remove it.

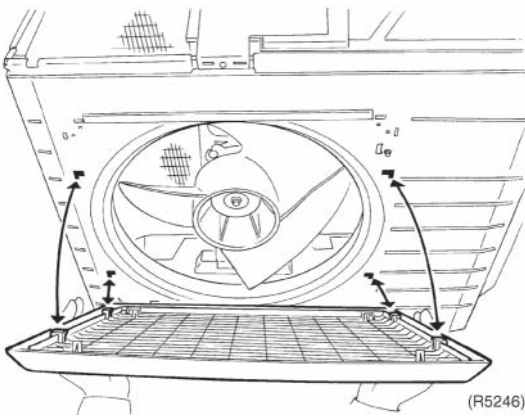
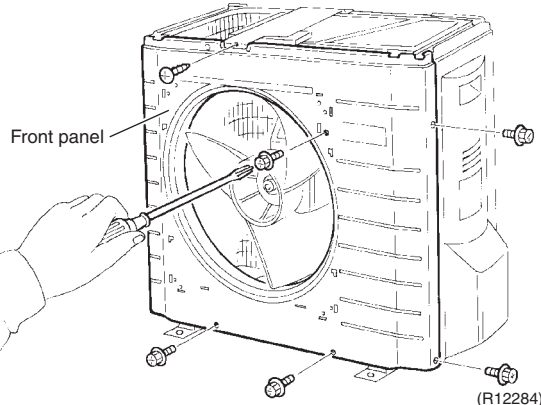
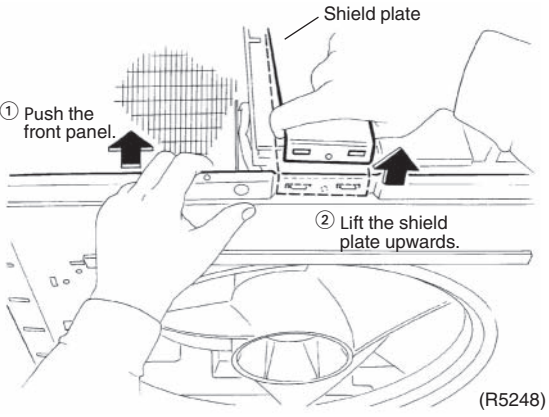
Step		Procedure	Points
3	Remove the 6 screws of the front panel.	 <p>(R5246)</p>  <p>Front panel</p> <p>(R12284)</p>	<ul style="list-style-type: none"> ■ The discharge grille has 4 hooks.
4	Push the front panel and lift the shield plate to unfasten the hooks.	 <p>Shield plate</p> <p>① Push the front panel.</p> <p>② Lift the shield plate upwards.</p> <p>(R5248)</p>	

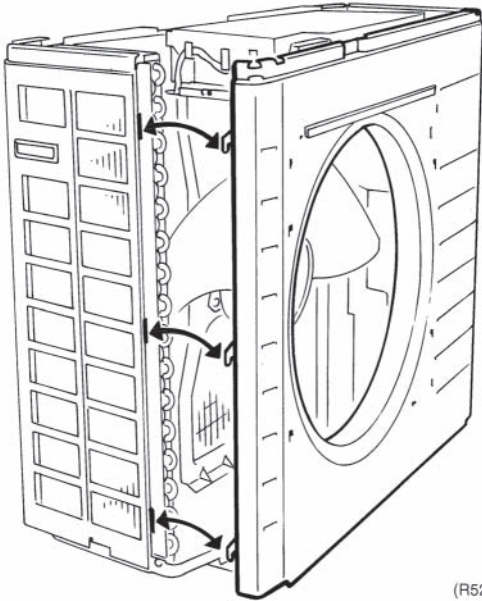
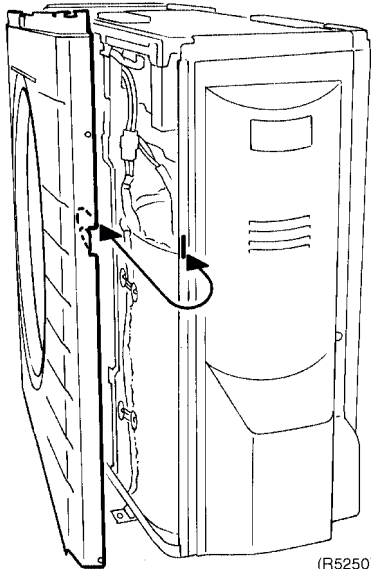
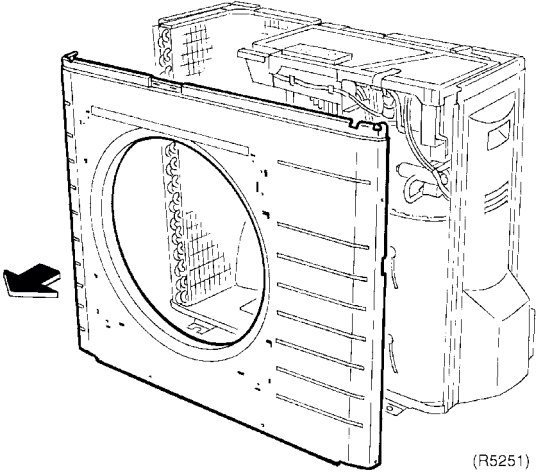
Step	Procedure	Points
<p>5</p>	<p>Unfasten the left side hooks, and then the right side hook. Remove the front panel.</p>  <p>(R5249)</p>  <p>(R5250)</p>  <p>(R5251)</p>	<ul style="list-style-type: none"> ■ Lift the front panel while pushing the left side panel inwards. ■ Lift the front panel and unfasten the right side hook. ■ When reassembling, fit the right side of the front panel first.

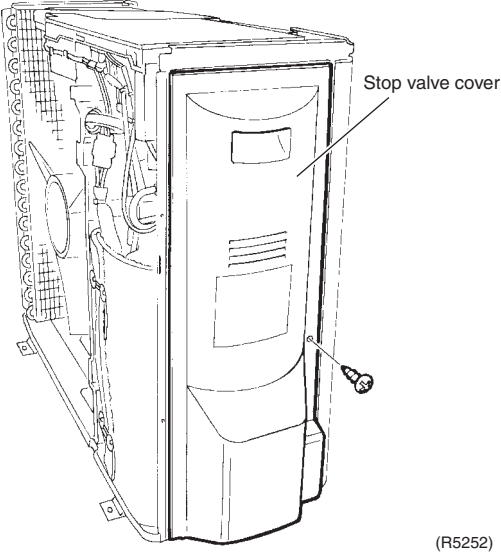
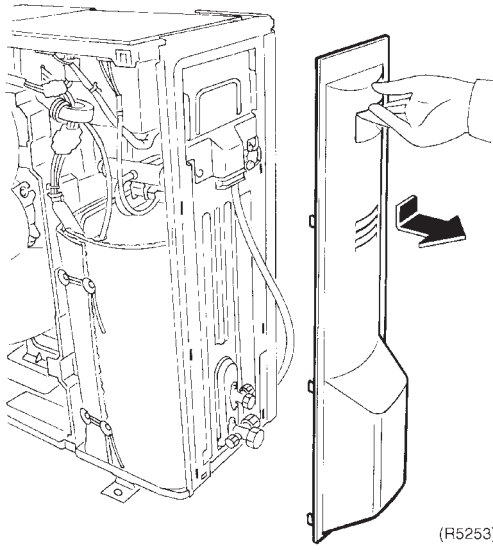
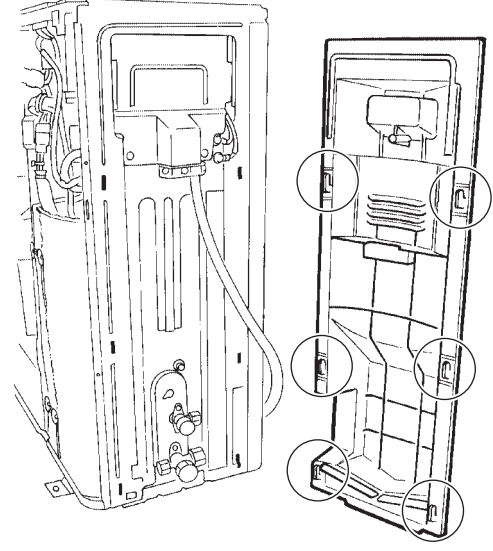
Step	Procedure	Points
2.	Remove the stop valve cover.	
1	<p>Remove the screw of the stop valve cover.</p>  <p>(R5252)</p>	
2	<p>Pull down the stop valve cover to unfasten the hooks and remove it.</p>  <p>(R5253)</p>  <p>(R5254)</p>	<p>■ The stop valve cover has 6 hooks.</p>

1.2 Removal of Outdoor Fan / Fan Motor

Procedure



Warning Be sure to wait for 10 minutes or more after turning off all power supplies before disassembling work.

Step	Procedure	Points
1. Remove the electrical box cover.		
1 Remove the screw of the shield plate.	<p style="text-align: right;">(R5255)</p>	<p>Preparation</p> <ul style="list-style-type: none"> ■ Remove the top panel and the front panel according to the "Removal of Outer Panels". ■ This procedure is not necessary to remove the outdoor fan only.
2 Unfasten the 2 hooks and remove the shield plate.	<p style="text-align: right;">(R12029)</p>	
3 Unfasten the 4 hooks of the electrical box cover and remove it.	<p style="text-align: right;">(R5257)</p>	

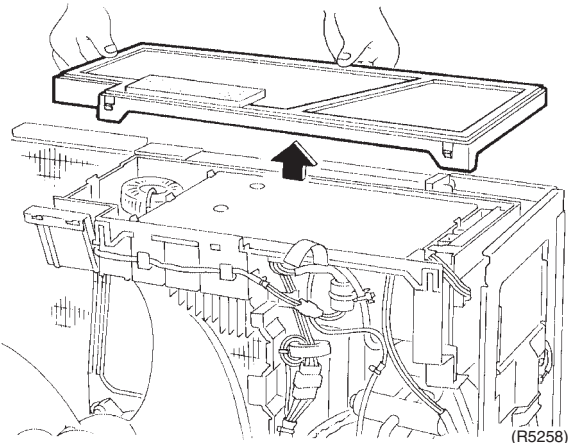
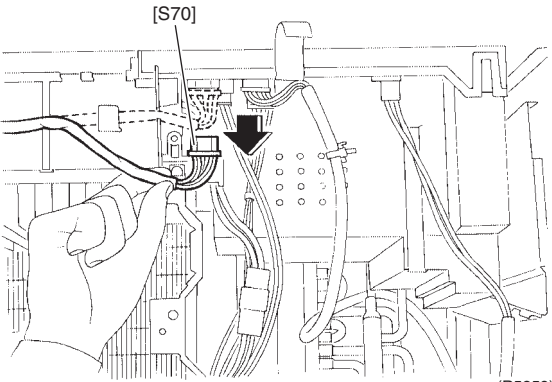
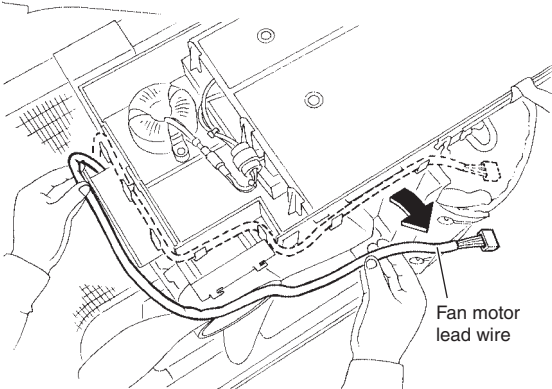
Step	Procedure	Points
	 <p style="text-align: right;">(R5258)</p>	
<p>2. Remove the fan motor.</p> <p>1</p> <p>2</p>	<p>1 Disconnect the connector for the fan motor [S70].</p>  <p style="text-align: right;">(R5259)</p> <p>2 Release the fan motor lead wire from the 7 hooks.</p>  <p style="text-align: right;">(R5260)</p>	

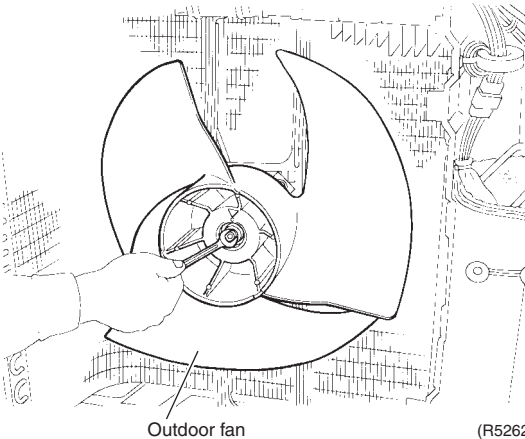
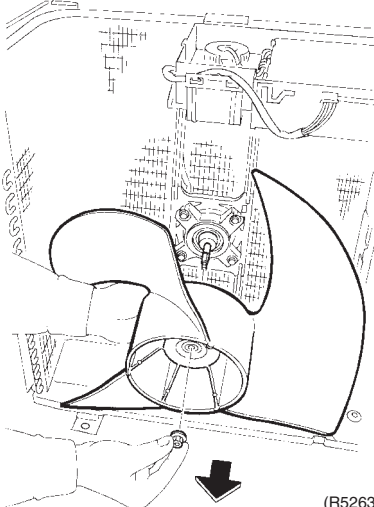
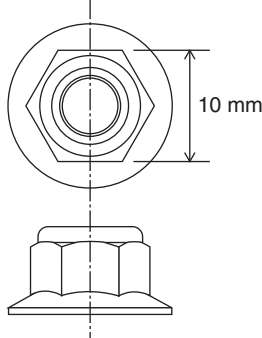
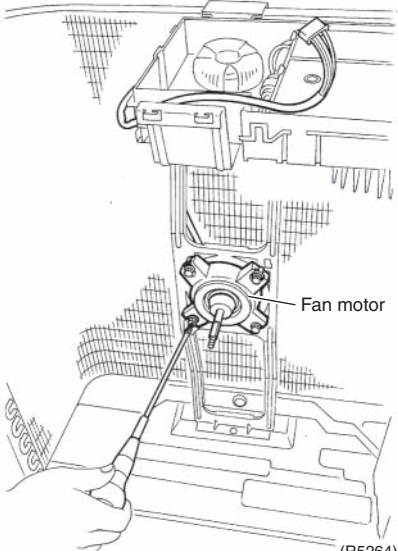
Step	Procedure	Procedure	Points
3	Remove the washer-fitted nut of the outdoor fan.	 <p>Outdoor fan (R5262)</p>  <p>(R5263)</p>	<ul style="list-style-type: none"> ■ The screw has reverse winding. ■ Nut size: M6  <p>(R12236)</p> <ul style="list-style-type: none"> ■ When reassembling, align ▼ mark of the outdoor fan with D-cut section of the motor shaft.
4	Remove the lower 2 screws from the fan motor first.	 <p>Fan motor (R5264)</p>	<ul style="list-style-type: none"> ■ Be sure to remove the lower screws first. If the upper screws are removed first, the fan motor, the center of gravity of which is toward the front, may tilt down or fall, getting you injured.
5	Then, remove the upper 2 screws.		

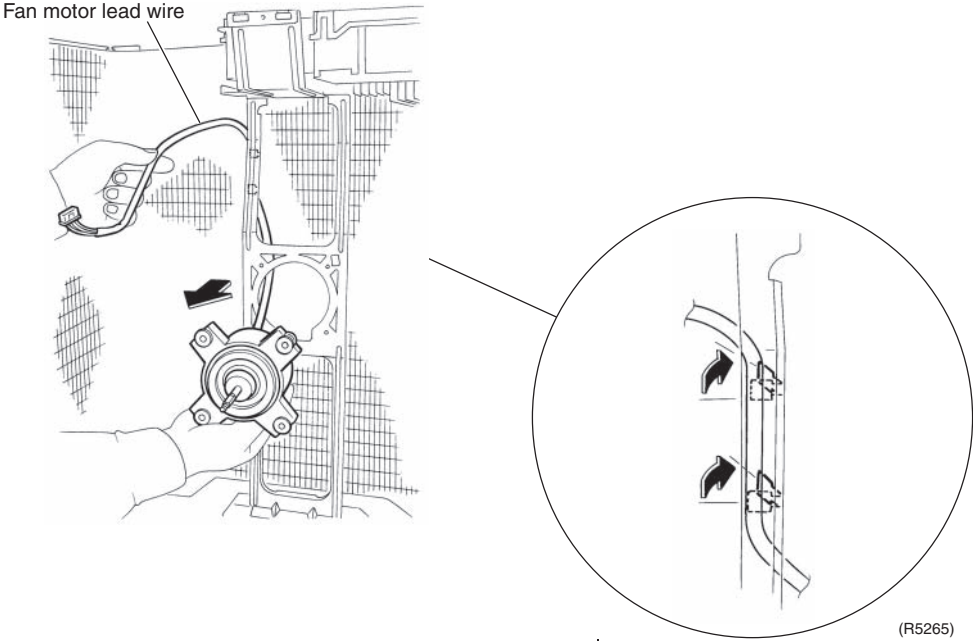
Step	Procedure	Points
6	<p data-bbox="199 219 454 340">Release the fan motor lead wire from the 2 hooks and pull the fan motor out.</p>  <p data-bbox="486 425 670 448">Fan motor lead wire</p> <p data-bbox="1380 1041 1444 1064">(R5265)</p>	<ul data-bbox="1093 219 1452 376" style="list-style-type: none">■ When reassembling, put the fan motor lead wire through the back of the fan motor (so as not to be entangled with the outdoor fan).

1.3 Removal of Electrical Box

Procedure



Warning Be sure to wait for 10 minutes or more after turning off all power supplies before disassembling work.

Step	Procedure	Procedure	Points
1	Remove the 2 screws of the shield plate.	<p style="text-align: right;">(R5266)</p>	<p>Preparation</p> <ul style="list-style-type: none"> Remove the top panel and the front panel according to the "Removal of Outer Panels".
2	Slide the shield plate upward to unfasten the 1 hook on the bottom left, and then remove the shield plate.	<p style="text-align: right;">(R5267)</p>	
3	Disconnect the 2 power supply cables and the 1 earth wire.	<p style="text-align: right;">(R5268)</p>	

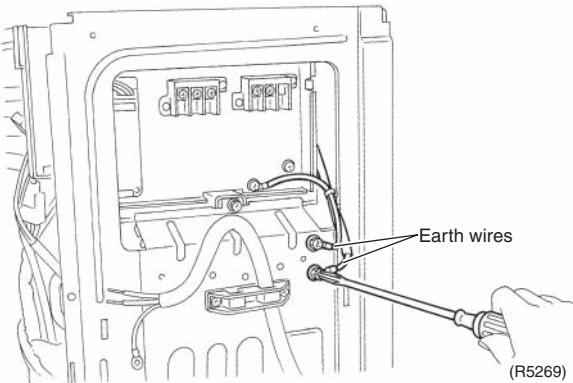
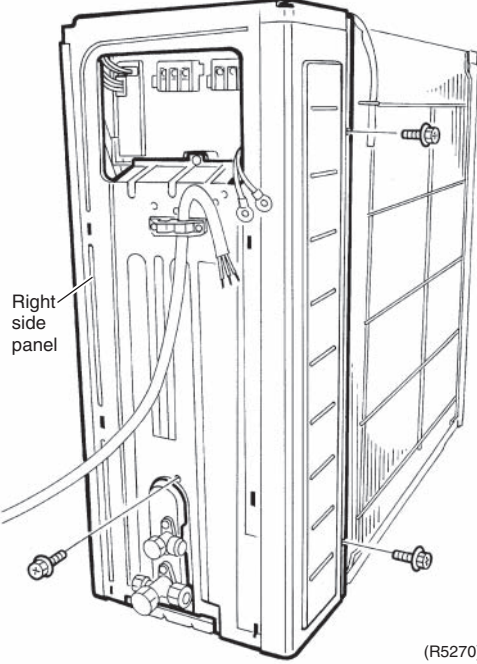
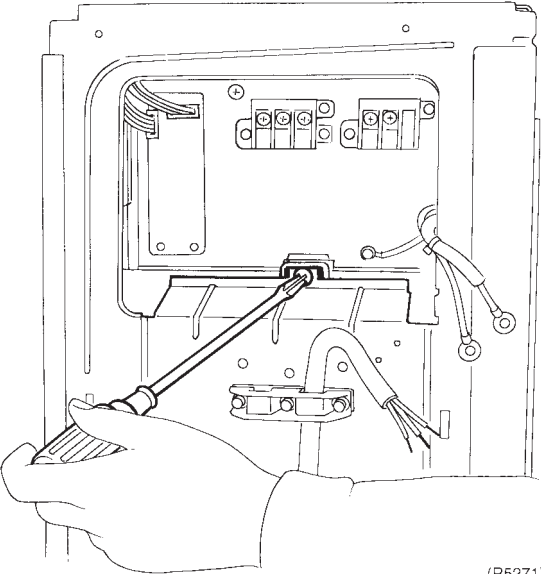
Step	Procedure	Points
4	<p>Disconnect the 2 earth wires.</p>  <p>(R5269)</p>	
5	<p>Remove the 3 screws of the right side panel.</p>  <p>(R5270)</p>	
6	<p>Remove the screw of the electrical box.</p>  <p>(R5271)</p>	

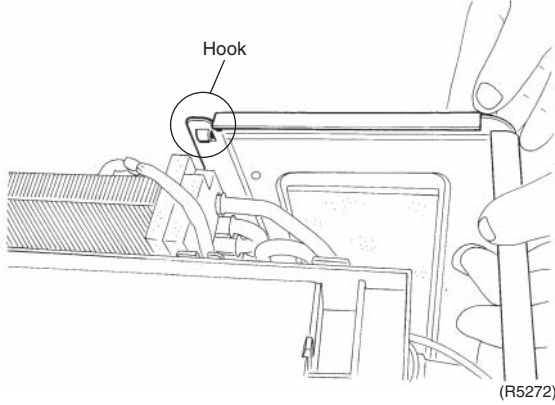
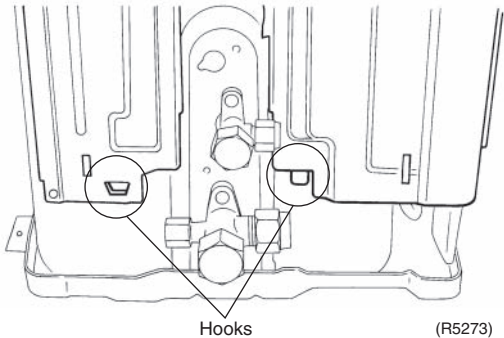
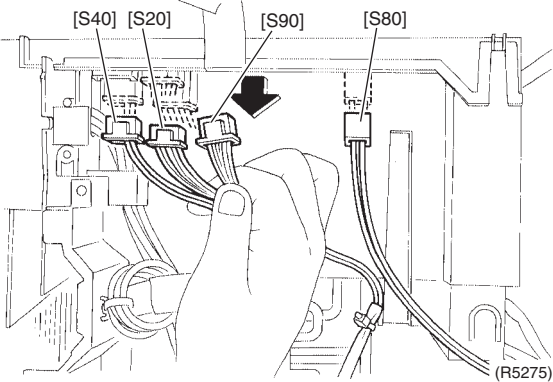
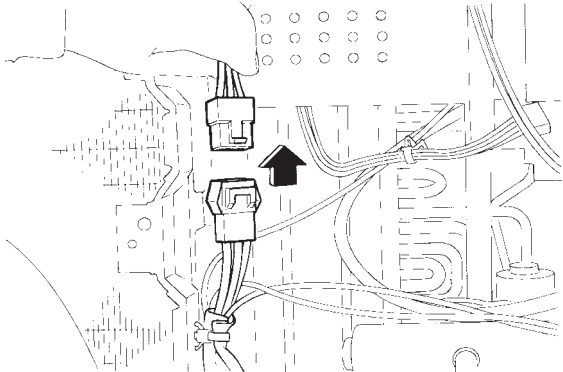
Step	Procedure	Points
7	<p>Unfasten the hooks and remove the right side panel.</p>  	<ul style="list-style-type: none"> When reassembling, insert the 2 hooks of the lower part and the 1 hook of the upper back.
8	<p>Disconnect the connectors of the front side.</p> <p>[S20]: electronic expansion valve coil [S40]: overload protector [S80]: four way valve coil [S90]: thermistors</p> 	
9	<p>Disconnect the relay connector for the compressor.</p> 	

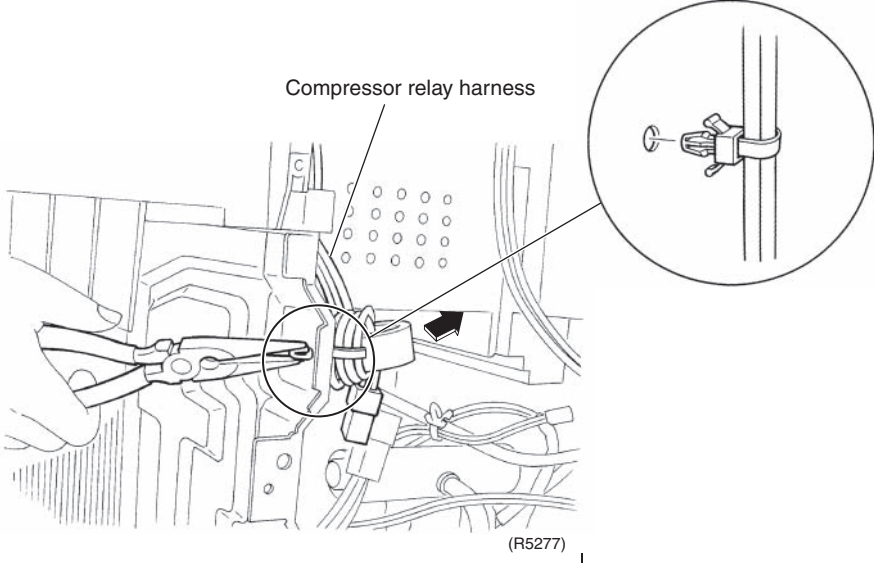
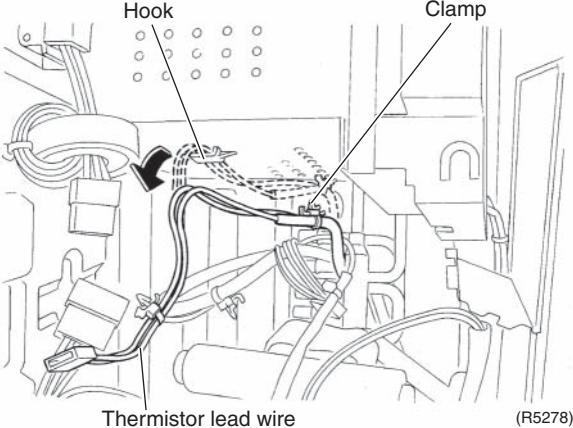
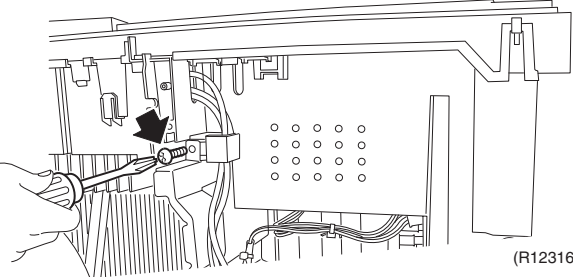
Step	Procedure	Points
10	<p>Release the clamp of the compressor relay harness with pliers.</p> 	
11	<p>Detach the clamp and release the thermistor lead wires from the hook.</p> 	
12	<p>Remove the screw.</p> 	

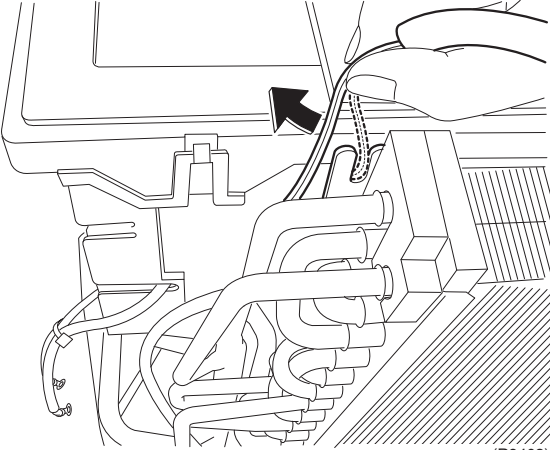
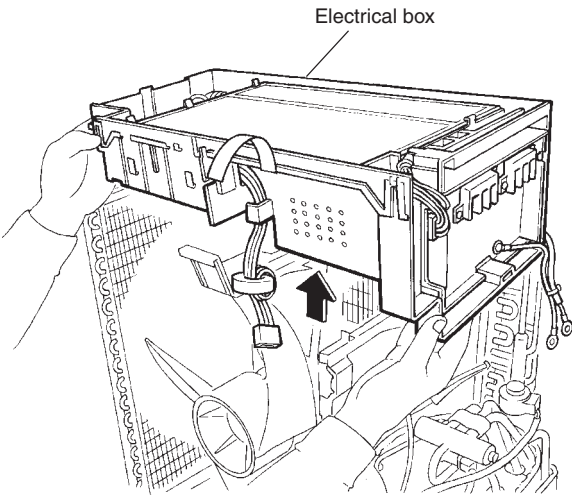
Step	Procedure	Points
13	Release the harness of the outdoor temperature thermistor from the hook.	
	 <p>(R9403)</p>	
14	Lift and remove the electrical box.	
	 <p>Electrical box</p> <p>(R5279)</p>	

1.4 Removal of PCB

Procedure



Warning Be sure to wait for 10 minutes or more after turning off all power supplies before disassembling work.

Step	Procedure	Procedure	Points
1	Disconnect the connectors from the service monitor PCB [S52] [S102].		<p>Preparation</p> <ul style="list-style-type: none"> Remove the electrical box according to the "Removal of Electrical Box".
2	Detach the 4 clamps with pliers.		
3	Remove the screws of the terminal board and the earth wire.		

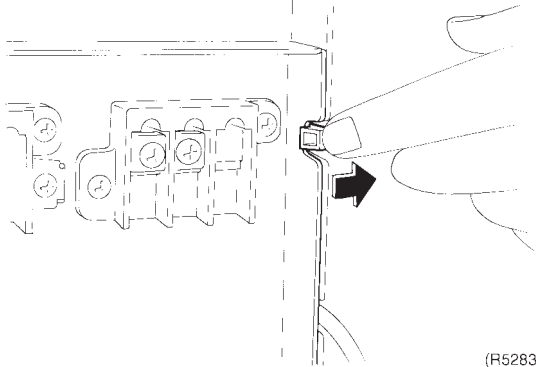
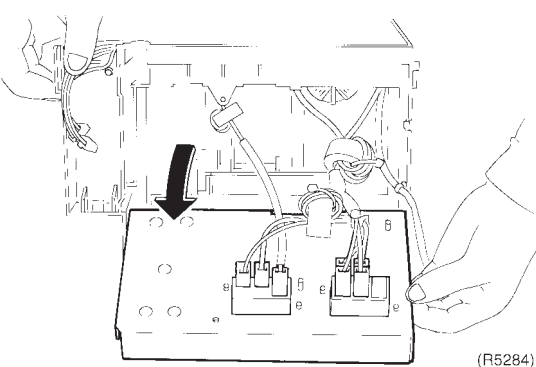
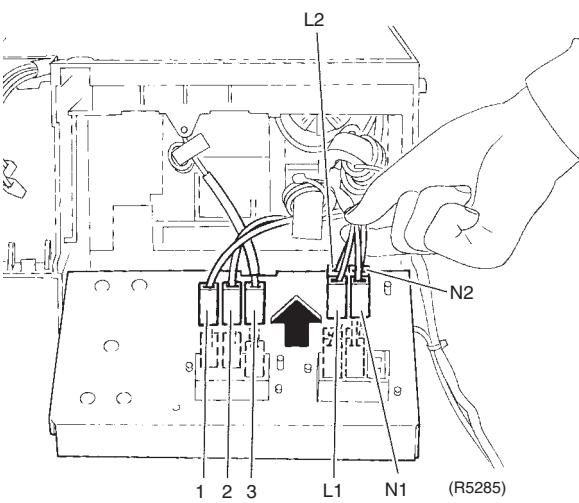
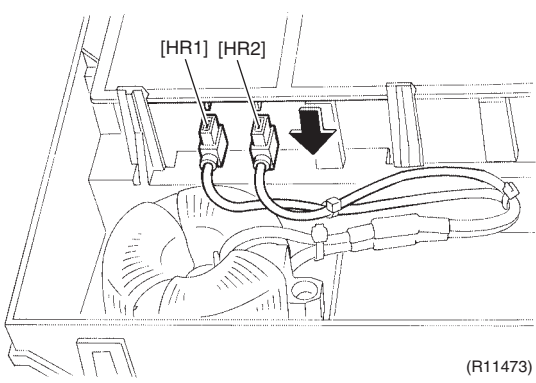
Step	Procedure	Procedure	Points
4	Unfasten the hook on the right.	 <p>(R5283)</p>	
5	Open the terminal board.	 <p>(R5284)</p>	
6	Disconnect the harnesses.	 <p>(R5285)</p>	<p>1: Black 2: White 3: Red L1: Black L2: Brown N1: White N2: Blue</p>
7	Disconnect the 2 connectors for the reactor [HR1] [HR2].	 <p>(R11473)</p>	

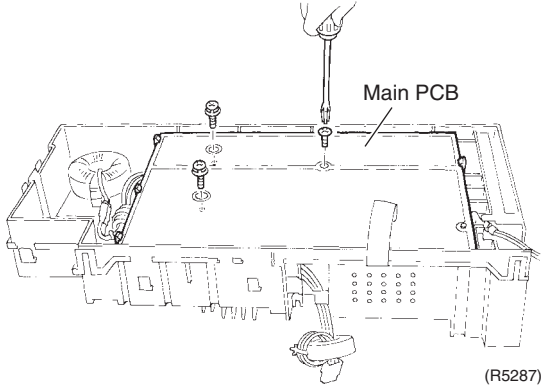
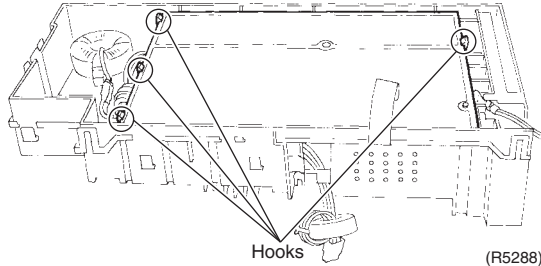
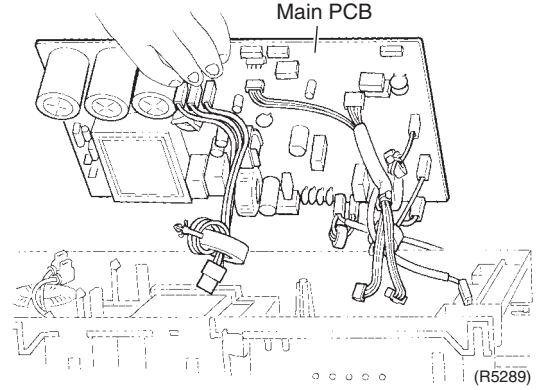
Step	Procedure	Points
8	<p>Remove the 3 screws of the main PCB.</p>  <p>(R5287)</p>	
9	<p>Unfasten the 4 hooks.</p>  <p>(R5288)</p>	
10	<p>Lift up and remove the main PCB.</p>  <p>(R5289)</p>	<p>■ Refer to page 16 for detail.</p>

1.5 Removal of Sound Blanket / Thermistors

Procedure



Warning Be sure to wait for 10 minutes or more after turning off all power supplies before disassembling work.

Step	Procedure	Procedure	Points
1	Remove the sound blanket (back).	<p>(R11161)</p>	
2	Remove the sound blanket (outer).	<p>(R5293)</p>	<ul style="list-style-type: none"> ■ Since the piping ports are torn easily, remove the sound blanket carefully.
3	Remove the sound blanket (top upper).	<p>(R5294)</p>	

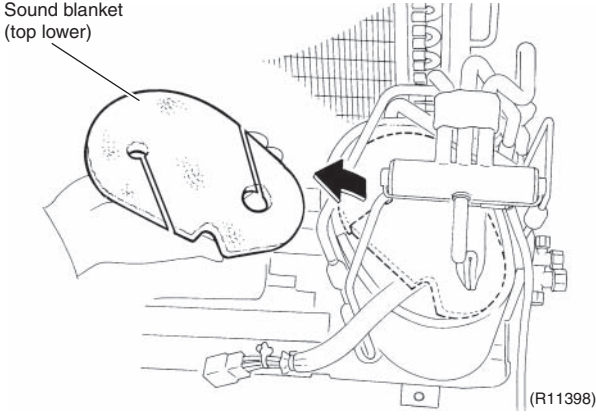
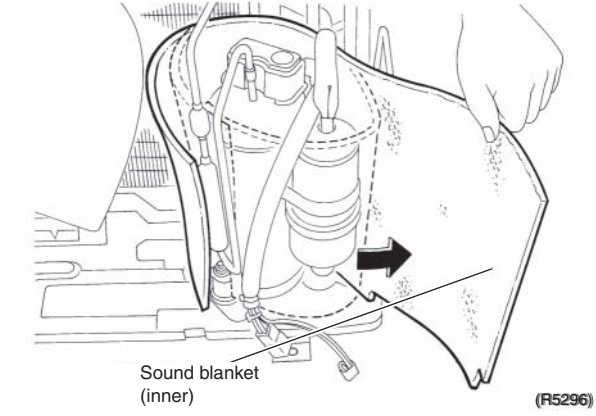
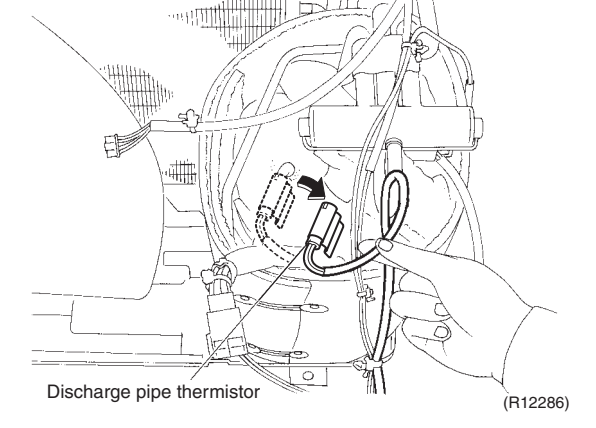
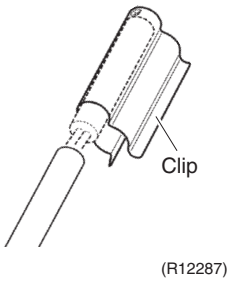
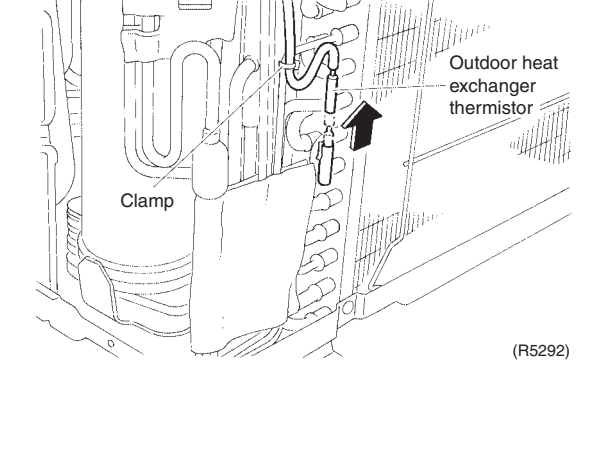
Step	Procedure	Points
4	<p>Remove the sound blanket (top lower).</p> 	
5	<p>Remove the sound blanket (inner).</p> 	
6	<p>Release the discharge pipe thermistor.</p> 	<p>■ Be careful not to lose the clip for the thermistor.</p> 
7	<p>Cut the clamp and pull out the outdoor heat exchanger thermistor.</p> 	

1.6 Removal of Four Way Valve

Procedure

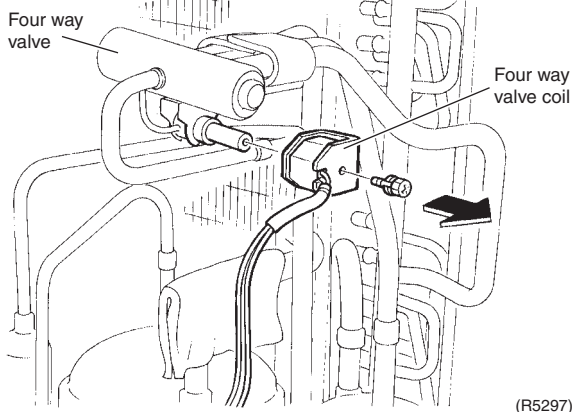
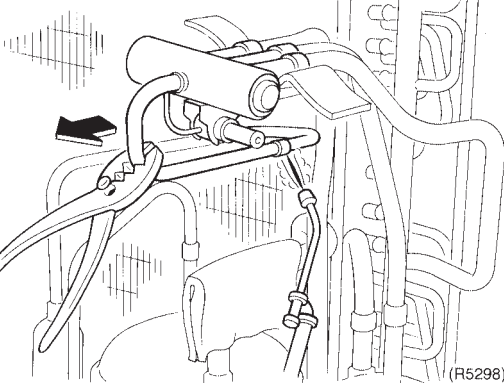
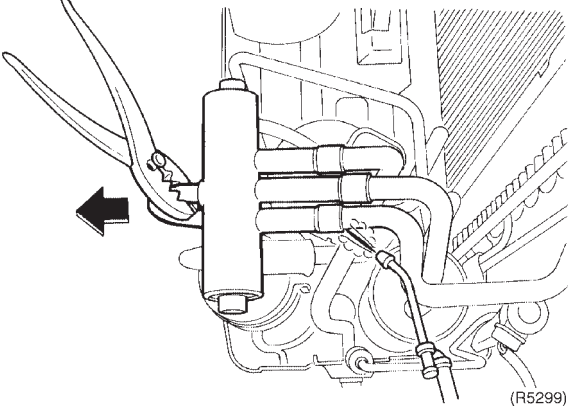

Warning Be sure to wait 10 minutes or more after turning off all power supplies before disassembling work.

Step	Procedure	Points
1	<p>Remove the screw and remove the four way valve coil.</p>  <p>(R5297)</p>	<p>Warning Be careful not to get yourself burnt with the pipes and other parts that are heated by the gas brazing machine.</p> <p>Warning If the refrigerant gas leaks during work, ventilate the room. (If the refrigerant gas is exposed to flames, toxic gas may be generated.)</p> <p>Caution From the viewpoint of global environment protection, do not discharge the refrigerant gas in the atmosphere. Make sure to collect all the refrigerant gas.</p>
<ul style="list-style-type: none"> ■ Before working, make sure that the refrigerant gas is empty in the circuit. ■ Be sure to apply nitrogen replacement when heating up the brazed part. 	 <p>(R5298)</p>	<p>Cautions for restoration</p> <ol style="list-style-type: none"> 1. Restore the piping by non-oxidation brazing. 2. It is required to prevent the carbonization of the oil inside the four way valve and the deterioration of the gaskets affected by heat. (Keep below 120°C.) For the sake of this, wrap the four way valve with wet cloth and provide water so that the cloth does not dry.
2	<p>Heat up the brazed part of the four way valve and disconnect.</p>	<p>Note:</p> <ul style="list-style-type: none"> ■ Do not use a metal saw for cutting pipes by all means because the sawdust comes into the circuit. ■ When withdrawing the pipes, be careful not to pinch them firmly with pliers. The pipes may get deformed. ■ Provide a protective sheet or a steel plate so that the brazing flame cannot influence peripheries.
3	<p>Heat up every brazed part in turn and disconnect.</p>  <p>(R5299)</p>	

1.7 Removal of Electronic Expansion Valve

Procedure

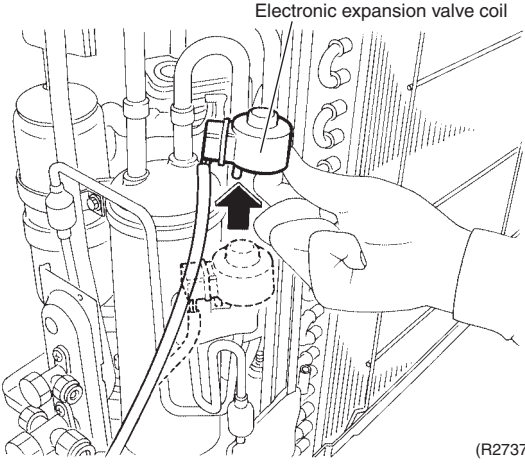
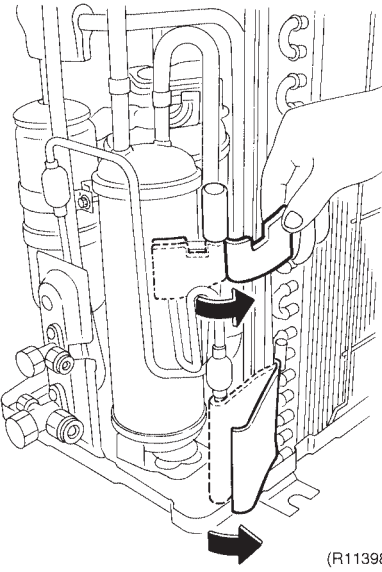
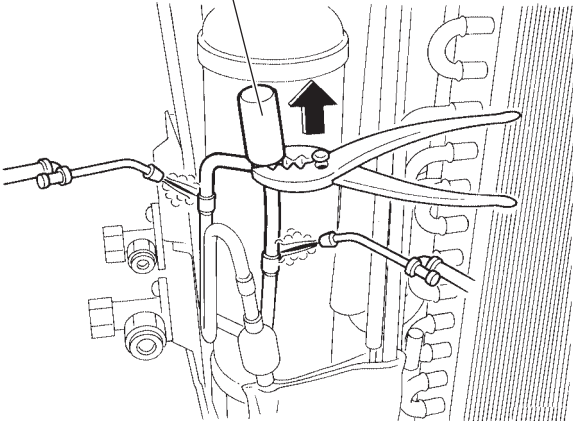

Warning Be sure to wait for 10 minutes or more after turning off all power supplies before disassembling work.

Step	Procedure	Procedure	Points
1	Pull out the electronic expansion valve coil.	 <p style="text-align: right;">(R2737)</p>	
2	Remove the sheets of putty.	 <p style="text-align: right;">(R11398)</p>	
<ul style="list-style-type: none"> ■ Before working, make sure that the refrigerant gas is empty in the circuit. ■ Be sure to apply nitrogen replacement when heating up the brazed part. 		 <p style="text-align: right;">(R2739)</p>	<p>Warning Be careful not to get yourself burnt with the pipes and other parts that are heated by the gas brazing machine.</p>
3	Heat up the 2 brazed parts of the electronic expansion valve and remove it.		<p>Warning If the refrigerant gas leaks during work, ventilate the room. (If the refrigerant gas is exposed to flames, toxic gas may be generated.)</p> <p>Caution From the viewpoint of global environment protection, do not discharge the refrigerant gas in the atmosphere. Make sure to collect all the refrigerant gas.</p>

1.8 Removal of Compressor

Procedure



Warning Be sure to wait for 10 minutes or more after turning off all power supplies before disassembling work.

Step	Procedure	Procedure	Points
1	Remove the terminal cover.	<p>(R5301)</p> <p>(R5302)</p>	
2	Disconnect the lead wires of the compressor.	<p>(R12204)</p>	

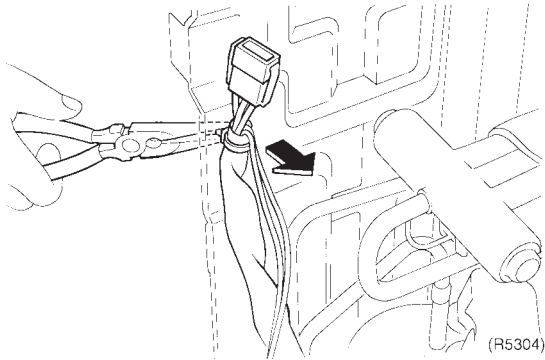
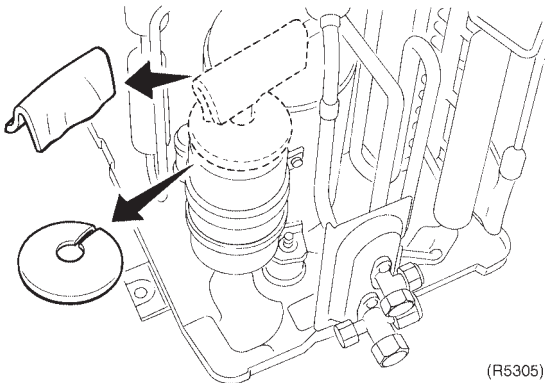
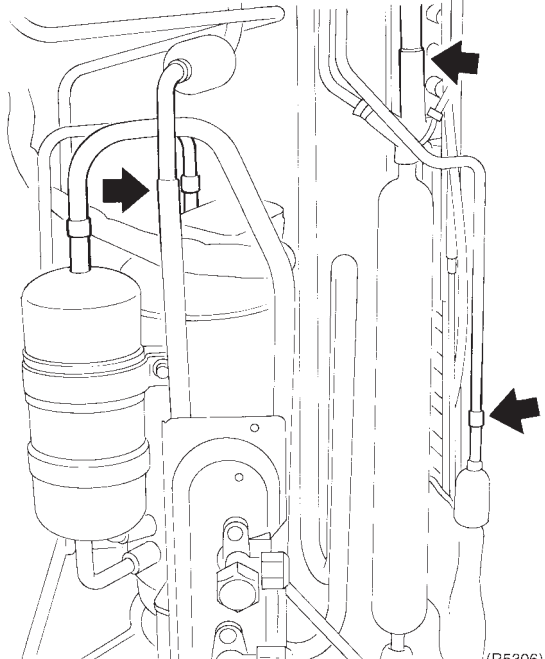
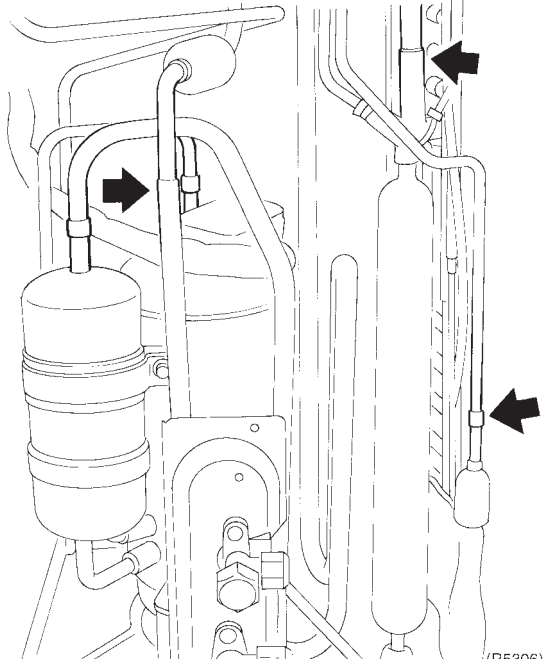
Step	Procedure	Points
<p>3 Release the clamp with pliers to detach the compressor lead wires.</p>	 <p>(R5304)</p>	
<p>4 Remove the putty.</p>	 <p>(R5305)</p>	
<ul style="list-style-type: none"> ■ Before working, make sure that the refrigerant gas is empty in the circuit. ■ Be sure to apply nitrogen replacement when heating up the brazed part. 	 <p>(R5306)</p>	<p>Warning Be careful not to get yourself burnt with the pipes and other parts that are heated by the gas brazing machine.</p>
<p>5 Heat up the brazed parts indicated by the arrows.</p>	 <p>(R5306)</p>	<p>Warning If the refrigerant gas leaks during work, ventilate the room. (If the refrigerant gas is exposed to flames, toxic gas may be generated.)</p> <p>Warning Since it may happen that the refrigerant oil in the compressor catches fire, prepare wet cloth so as to extinguish fire immediately.</p> <p>Caution From the viewpoint of global environment protection, do not discharge the refrigerant gas in the atmosphere. Make sure to collect all the refrigerant gas.</p>

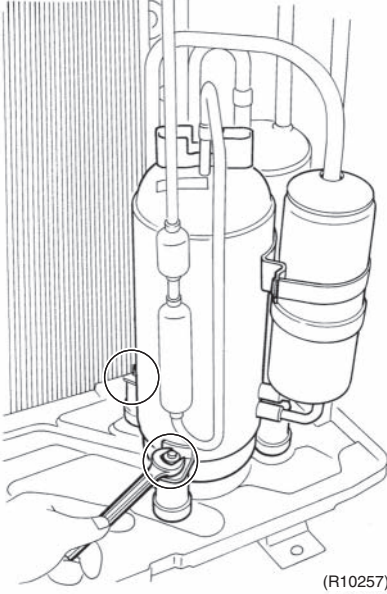
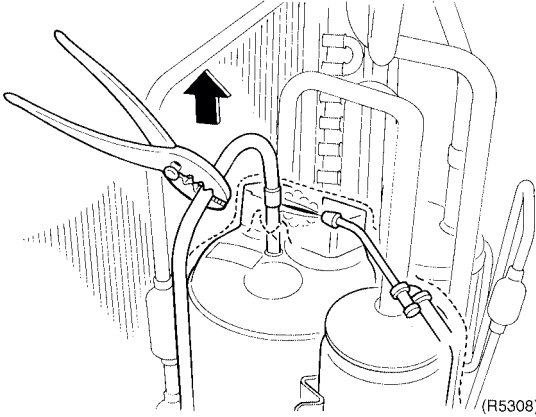
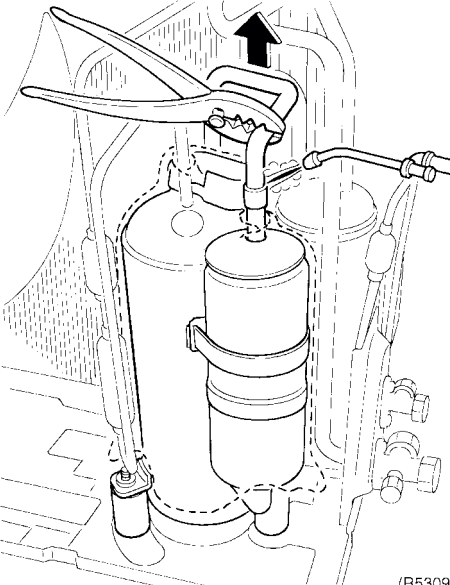
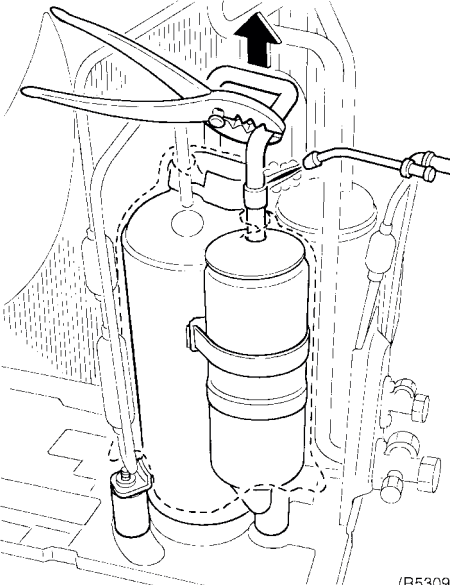
Step	Procedure	Procedure	Points
6	Remove the 2 nuts of the compressor.	 <p>(R10257)</p>	<p>Cautions for restoration</p> <ol style="list-style-type: none"> 1. Restore the piping by non-oxidation brazing. 2. It is required to prevent the carbonization of the oil inside the four way valve and the deterioration of the gaskets affected by heat. (Keep below 120°C.) For the sake of this, wrap the four way valve with wet cloth and provide water so that the cloth does not dry. <p>In case of difficulty with gas brazing machine</p> <ol style="list-style-type: none"> 1. Disconnect the brazed part where is easy to disconnect and restore. 2. Cut pipes on the main unit with a tube cutter in order to make it easy to disconnect.
7	Heat up the brazed part of the discharge side and disconnect.	 <p>(R5308)</p>	<p>Note:</p> <ul style="list-style-type: none"> ■ Do not use a metal saw for cutting pipes by all means because the sawdust comes into the circuit. ■ When withdrawing the pipes, be careful not to pinch them firmly with pliers. The pipes may get deformed.
8	Heat up the brazed part of the suction side and disconnect.	 <p>(R5309)</p>	<ul style="list-style-type: none"> ■ Provide a protective sheet or a steel plate so that the brazing flame cannot influence peripheries. ■ Be careful so as not to burn the compressor terminals, the name plate, the heat exchanger fin.
9	Lift the compressor up and remove it.	 <p>(R5309)</p>	

Part 8

Trial Operation and Field Settings

1. Trial Operation	126
2. Field Settings	127
2.1 When 2 Units are Installed in 1 Room.....	127
2.2 Facility Setting Switch (cooling at low outdoor temperature).....	128
2.3 Jumper and Switch Settings.....	128
3. Application of Silicon Grease to a Power Transistor and a Diode Bridge	129

1. Trial Operation

Outline

1. Measure the supply voltage and make sure that it falls in the specified range.
2. Trial operation should be carried out in either cooling or heating mode.
3. Carry out the trial operation in accordance with the operation manual to ensure that all functions and parts, such as flap movement, are working properly.
 - The air conditioner requires a small amount of power in its standby mode. If the system is not to be used for some time after installation, shut off the circuit breaker to eliminate unnecessary power consumption.
 - If the circuit breaker trips to shut off the power to the air conditioner, the system backs up the operation mode. The system then restarts operation with the previous mode when the circuit breaker is restored.

In cooling mode, select the lowest programmable temperature; in heating mode, select the highest programmable temperature.

- Trial operation may be disabled in either mode depending on the room temperature.
- After trial operation is complete, set the temperature to a normal level.
(26°C to 28°C in cooling mode, 20°C to 24°C in heating mode)
- For protection, the system does not start for 3 minutes after it is turned off.

Detail

ARC433 Series

- (1) Press the ON/OFF button to turn on the system.
- (2) Press the center of the TEMP button and the MODE button at the same time.
- (3) Press the MODE button twice.
(“T” appears on the display to indicate that trial operation is selected.)
- (4) Press the MODE button and select operation mode.
- (5) Trial operation terminates in approx. 30 minutes and switches into normal mode. To quit a trial operation, press the ON/OFF button.

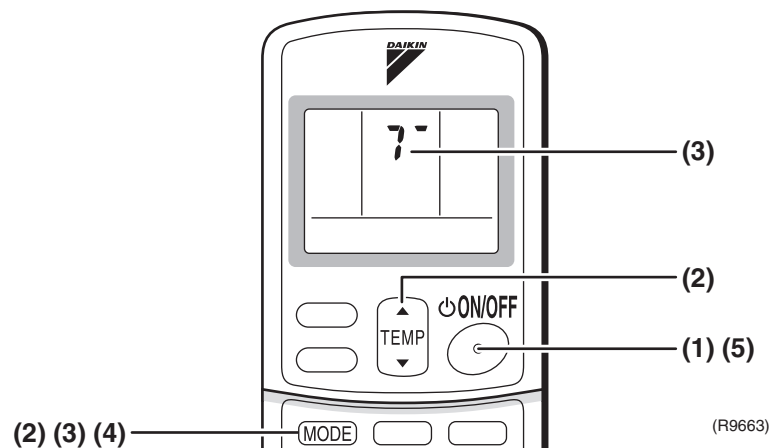

2. Field Settings

2.1 When 2 Units are Installed in 1 Room

When 2 indoor units are installed in 1 room, 1 of the 2 pairs of indoor unit and infrared remote control can be set for different addresses.

Both the indoor unit PCB and the infrared remote control need alteration.

Indoor Unit PCB

- Cut the jumper JA on PCB.

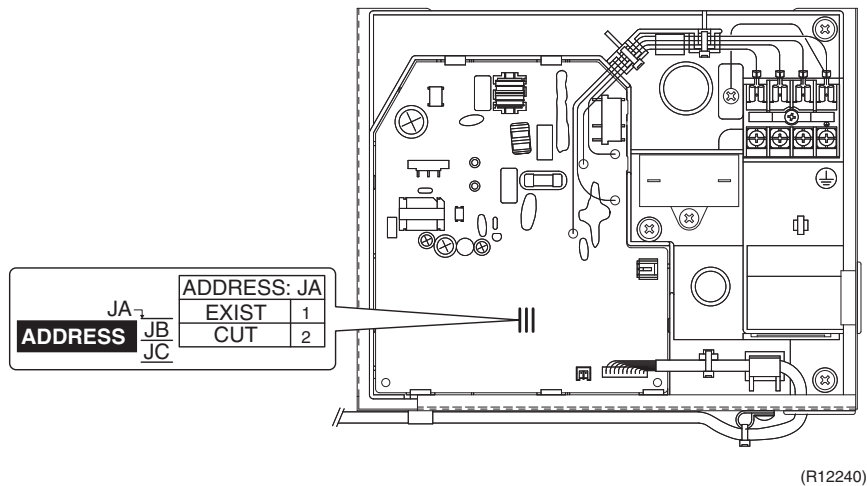

Infrared remote control

- Cut the jumper J4.

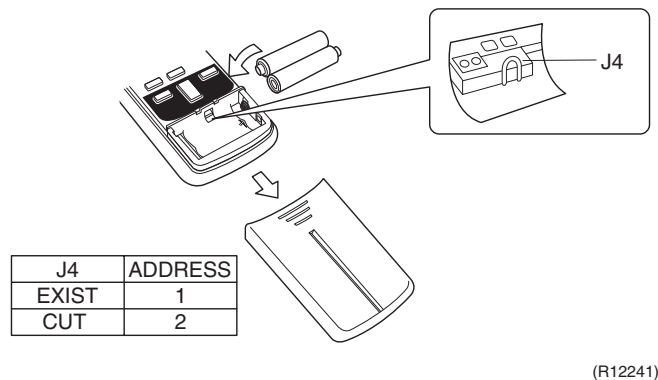

2.2 Facility Setting Switch (cooling at low outdoor temperature)

Outline

For Cooling Only Model

This function is limited only for facilities (the target of air conditioning is equipment (such as computer)). Never use it in a residence or office (the space where there is a human).

Detail

You can expand the operation range to -15°C by turning on the switch (SW4-B) on the service monitor PCB. If the outdoor temperature falls to -20°C or lower, the operation stops. If the outdoor temperature rises, the operation starts again.

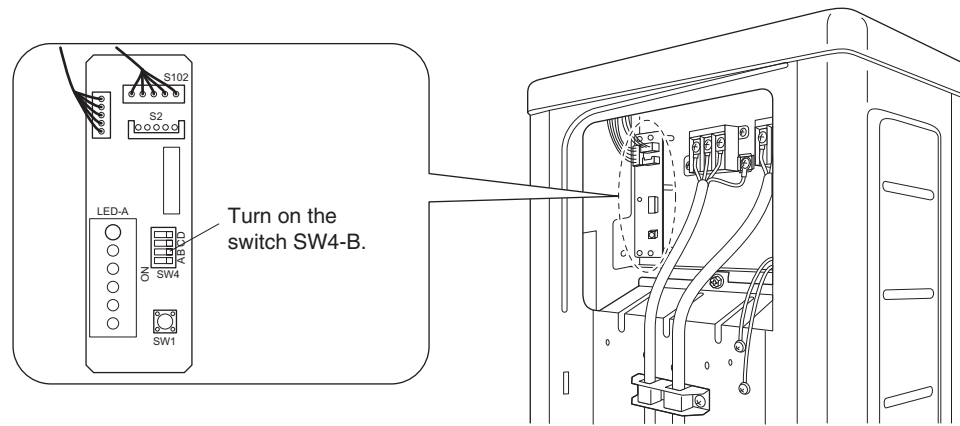

(R12157)



Caution

1. If the outdoor unit is installed where the outdoor heat exchanger of the unit is exposed to direct wind, provide a windbreak wall.
2. Intermittent noises may be produced by the indoor unit due to the outdoor fan turning on and off when using facility settings.
3. Do not place humidifiers or other items which might raise the humidity in rooms where facility settings are being used.
A humidifier might cause dew jumping from the indoor unit outlet vent.
4. Use the indoor unit at the highest level of airflow rate.

2.3 Jumper and Switch Settings

Jumper	Function	When connected (factory set)	When cut
JB (on indoor unit PCB)	Fan speed setting when compressor stops for thermostat OFF. (effective only at cooling operation)	Fan speed setting ; remote control setting	Fan speed setting; "0" (The fan stops.)
JC (on indoor unit PCB)	Power failure recovery function	Auto-restart	The unit does not resume operation after recovering from a power failure. Timer settings are cleared.



For the location of the jumper, refer to page 14.

Switch	Function	OFF (factory set)	ON
SW4-C (on outdoor unit PCB)	Improvement of defrost performance	Standard control	Reinforced control (ex. The frequency increases, the duration time of defrost lengthens.)



For the location of the switch, refer to page 16.

3. Application of Silicon Grease to a Power Transistor and a Diode Bridge

Applicable Models

All outdoor units using inverter type compressor for room air conditioner.

When the printed circuit board (PCB) of an outdoor unit is replaced, it is required that silicon grease (*1) is certainly applied to the heat radiation part (the contact point to the radiation fin) of the power transistor and diode bridge.

*1: Parts number of the silicon grease – 1172698 (Drawing number 3FB03758-1)

Details

The silicon grease is an essential article for encouraging the heat radiation of the power transistor and the diode bridge. Applying the paste should be implemented in accordance with the following instruction.

Remark: There is the possibility of failure with smoke in case of bad heat radiation.

- Wipe off the old silicon grease completely on a radiation fin.
- Apply the silicon grease evenly to the whole.
- Do not leave any foreign object such as solder or paper waste between the power transistor and the radiation fin, and also the diode bridge, and the radiation fin.
- Tighten the screws of the power transistor and the diode bridge, and contact to the radiation fin without any gap.

<Example>

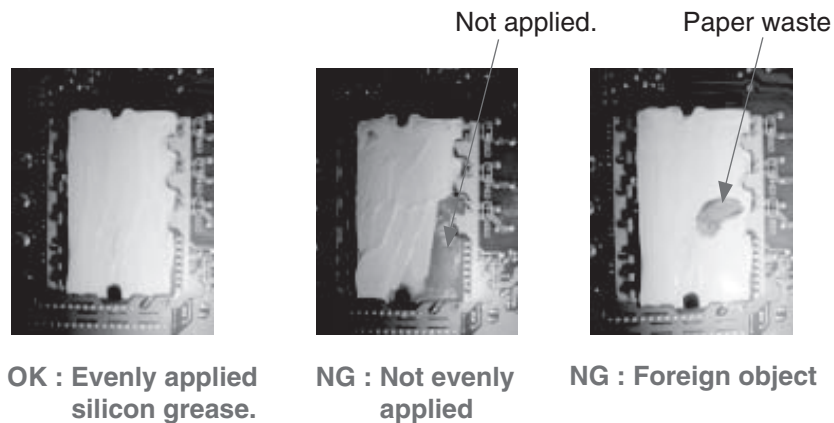
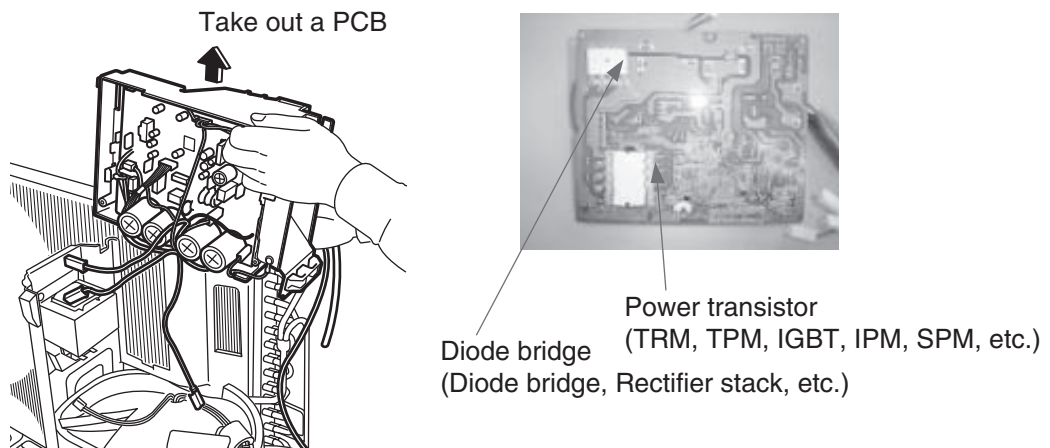

(R9056)

Part 9

Appendix

1. Piping Diagrams.....	131
1.1 Indoor Unit.....	131
1.2 Outdoor Unit.....	132
2. Wiring Diagrams.....	133
2.1 Indoor Unit.....	133
2.2 Outdoor Unit.....	134

1. Piping Diagrams

1.1 Indoor Unit

FDKS50/60CVMB, FDXS50/60CVMB

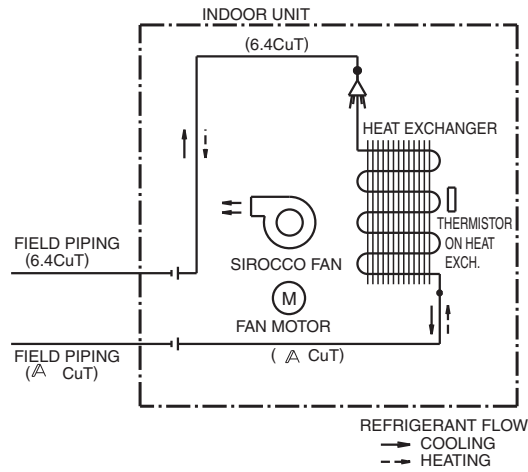

	Δ
FDXS50CVMB	12.7
FDXS60CVMB	
FDKS50CVMB	
FDKS60CVMB	

C: 4D045449L

1.2 Outdoor Unit

1.2.1 Cooling Only

RKS50/60E2(3)V1B, RKS50/60F2V1B, RKS50G2V1B, RKS60F3V1B

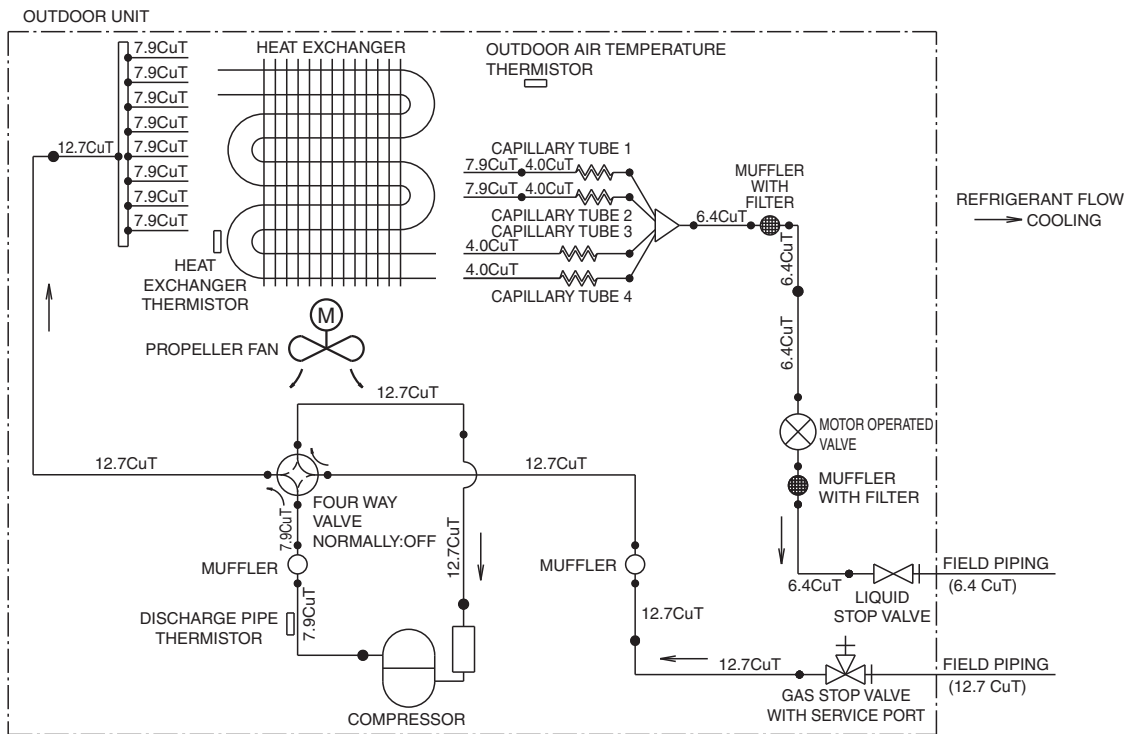

3D051636N

1.2.2 Heat Pump

RXS50/60E2(3)V1B, RXS50/60F2V1B, RXS50G2V1B, RXS60F3V1B

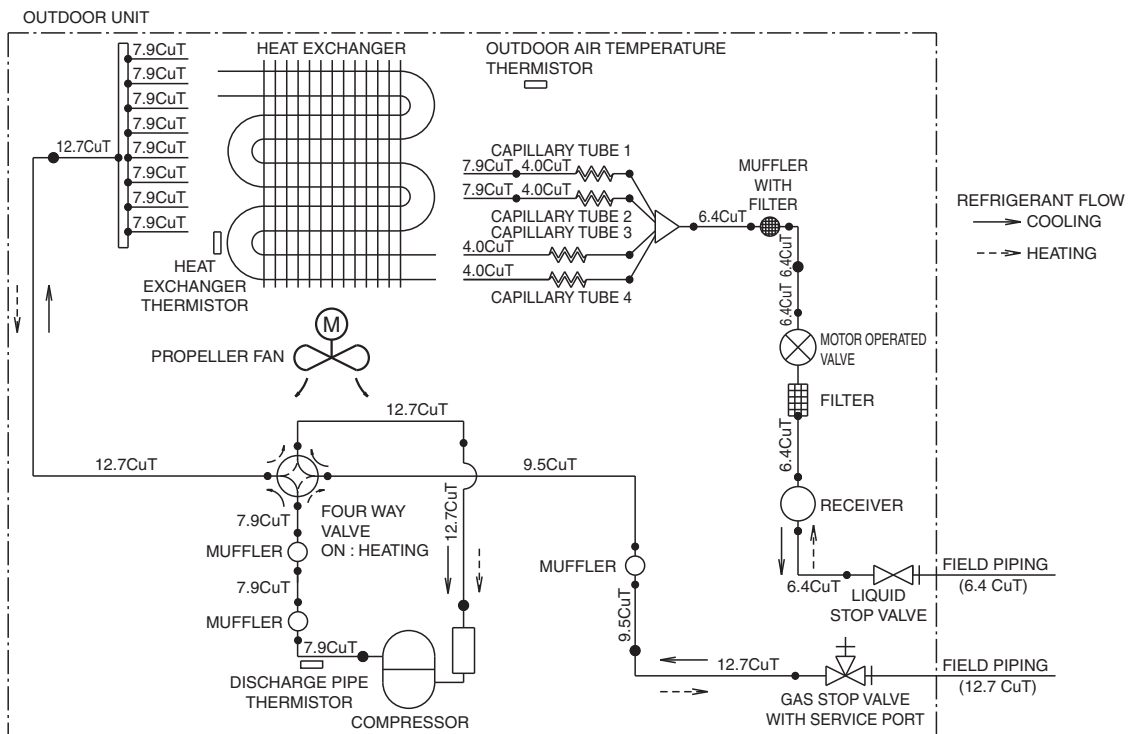

3D051637Q

2. Wiring Diagrams

2.1 Indoor Unit

FDKS50/60CVMB, FDXS50/60CVMB

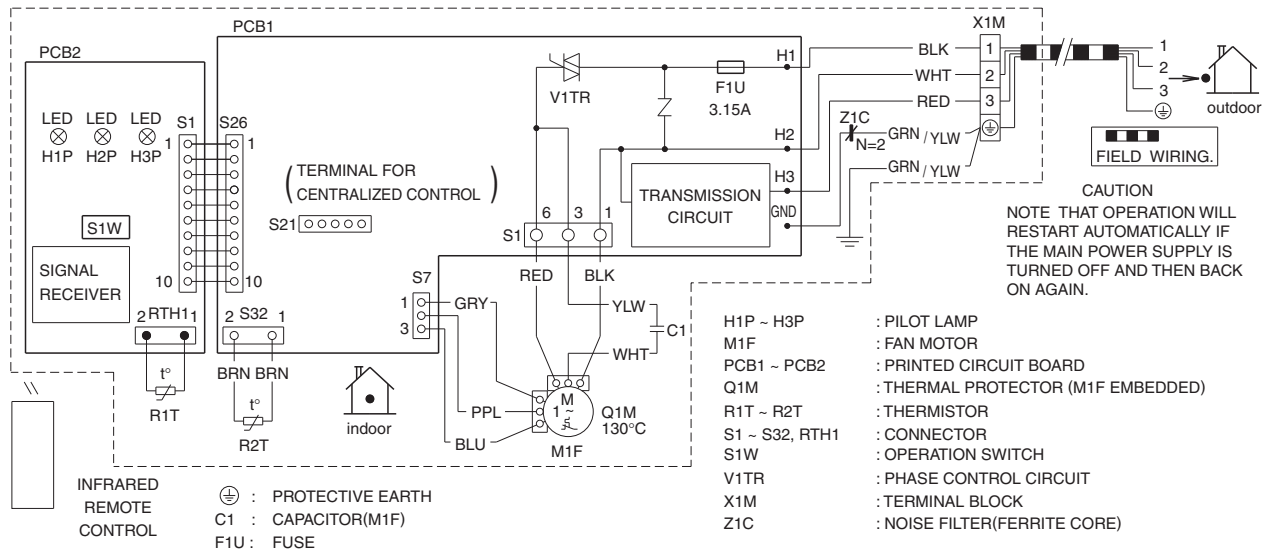

3D045012L

2.2 Outdoor Unit

2.2.1 Cooling Only

RKS50F2V1B, RKS50G2V1B

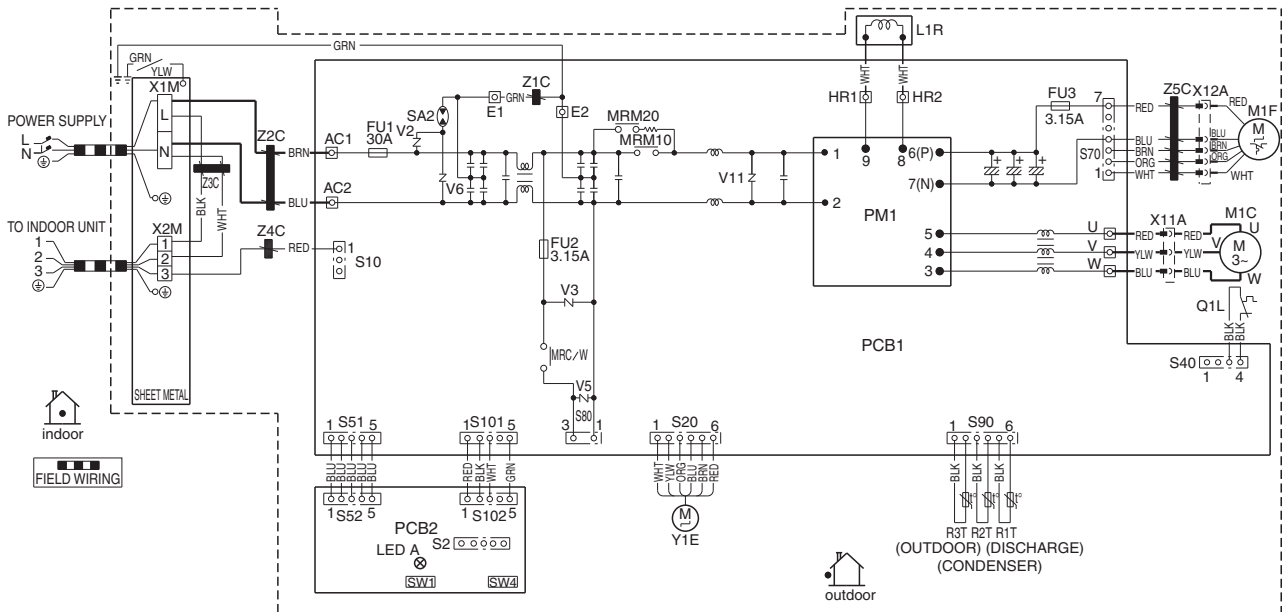

- | | | | | | | | |
|---------------------|-----------------------------------|--------------|------------------|-----|------------------------------------|-------------|------------------------------|
| Z1C - Z5C | : FERRITE CORE | MRM10, MRM20 | : MAGNETIC RELAY | L | : LIVE | M1C | : COMPRESSOR MOTOR |
| X1M, X2M | : TERMINAL STRIP | MRC/W | : THERMISTOR | N | : NEUTRAL | M1F | : FAN MOTOR |
| Y1E | : ELECTRONIC EXPANSION VALVE COIL | R1T - R3T | : THERMISTOR | SW1 | : FORCED OPERATION ON/OFF SW (SW1) | L1R | : REACTOR |
| V2, V3, V5, V6, V11 | : VARISTOR | S2 - S102 | : CONNECTOR | SW4 | : LOCAL SETTING SW (SW4) | Q1L | : OVERLOAD PROTECTOR |
| SA2 | : SURGE ARRESTER | LED A | : PILOT LAMP | | | PM1 | : POWER MODULE |
| FU1, FU2, FU3 | : FUSE | | | | | PCB1, 2 | : PRINTED CIRCUIT BOARD |
| AC1, AC2 | | | | | | STEEL METAL | : TERMINAL STRIP FIXED PLATE |
| U, V, W, X11A, X12A | | | | | | | |
| E1, E2 | | | | | | | |
| HR1, HR2 | : CONNECTOR | | | | | | |

3D056145A

RKS50/60E2(3)V1B, RKS60F2V1B

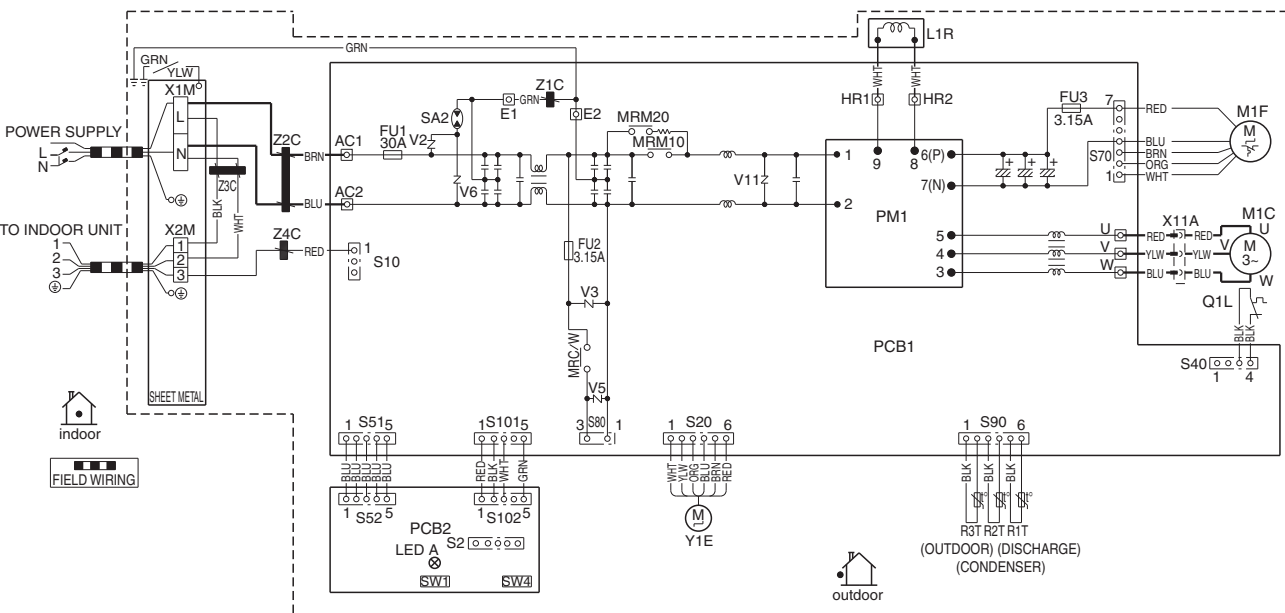

- | | | | | | | | |
|---------------------|-----------------------------------|--------------|------------------|-----|------------------------------------|-------------|------------------------------|
| Z1C - Z4C | : FERRITE CORE | MRM10, MRM20 | : MAGNETIC RELAY | L | : LIVE | M1C | : COMPRESSOR MOTOR |
| X1M, X2M | : TERMINAL STRIP | MRC/W | : THERMISTOR | N | : NEUTRAL | M1F | : FAN MOTOR |
| Y1E | : ELECTRONIC EXPANSION VALVE COIL | R1T - R3T | : THERMISTOR | SW1 | : FORCED OPERATION ON/OFF SW (SW1) | L1R | : REACTOR |
| V2, V3, V5, V6, V11 | : VARISTOR | S2 - S102 | : CONNECTOR | SW4 | : LOCAL SETTING SW (SW4) | Q1L | : OVERLOAD PROTECTOR |
| SA2 | : SURGE ARRESTER | LED A | : PILOT LAMP | | | PM1 | : POWER MODULE |
| FU1, FU2, FU3 | : FUSE | | | | | PCB1, 2 | : PRINTED CIRCUIT BOARD |
| AC1, AC2 | | | | | | STEEL METAL | : TERMINAL STRIP FIXED PLATE |
| U, V, W, X11A | | | | | | | |
| E1, E2 | | | | | | | |
| HR1, HR2 | : CONNECTOR | | | | | | |

3D050981L

RKS60F3V1B

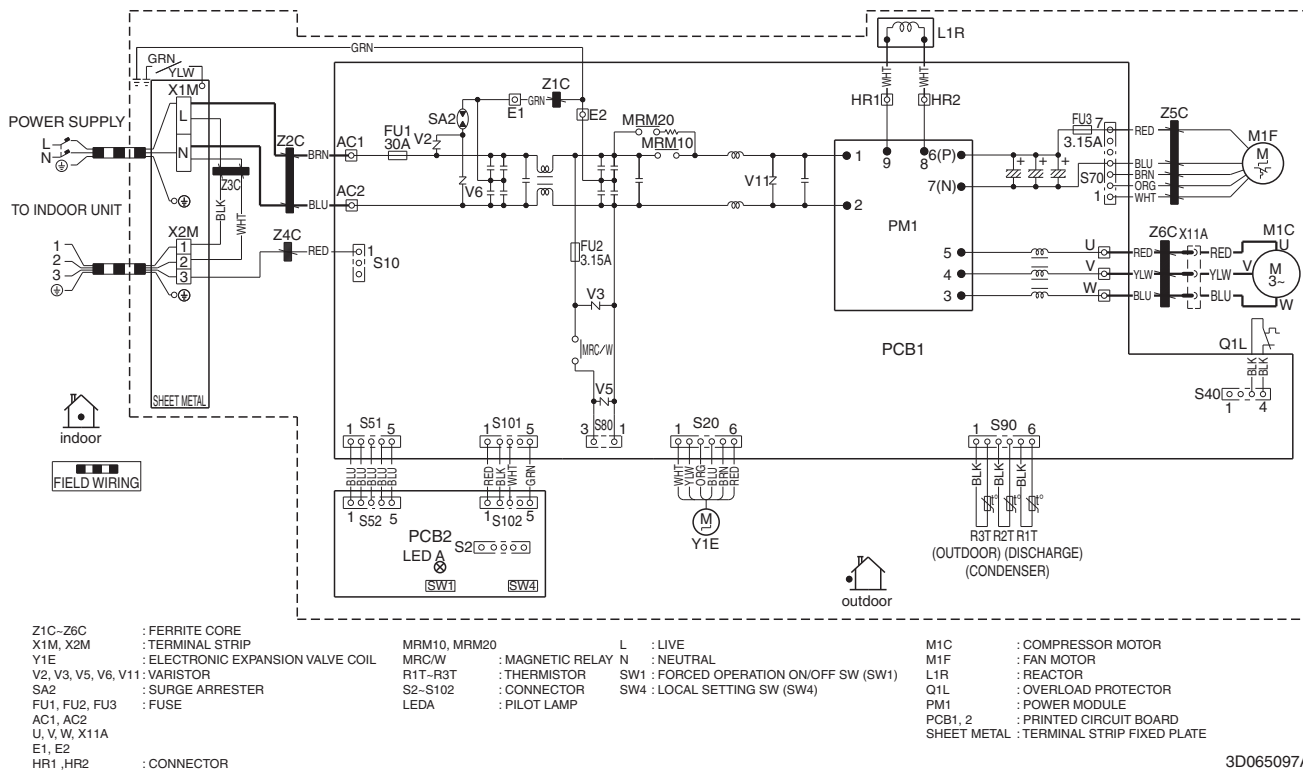

2.2.2 Heat Pump

RXS50F2V1B, RXS50G2V1B

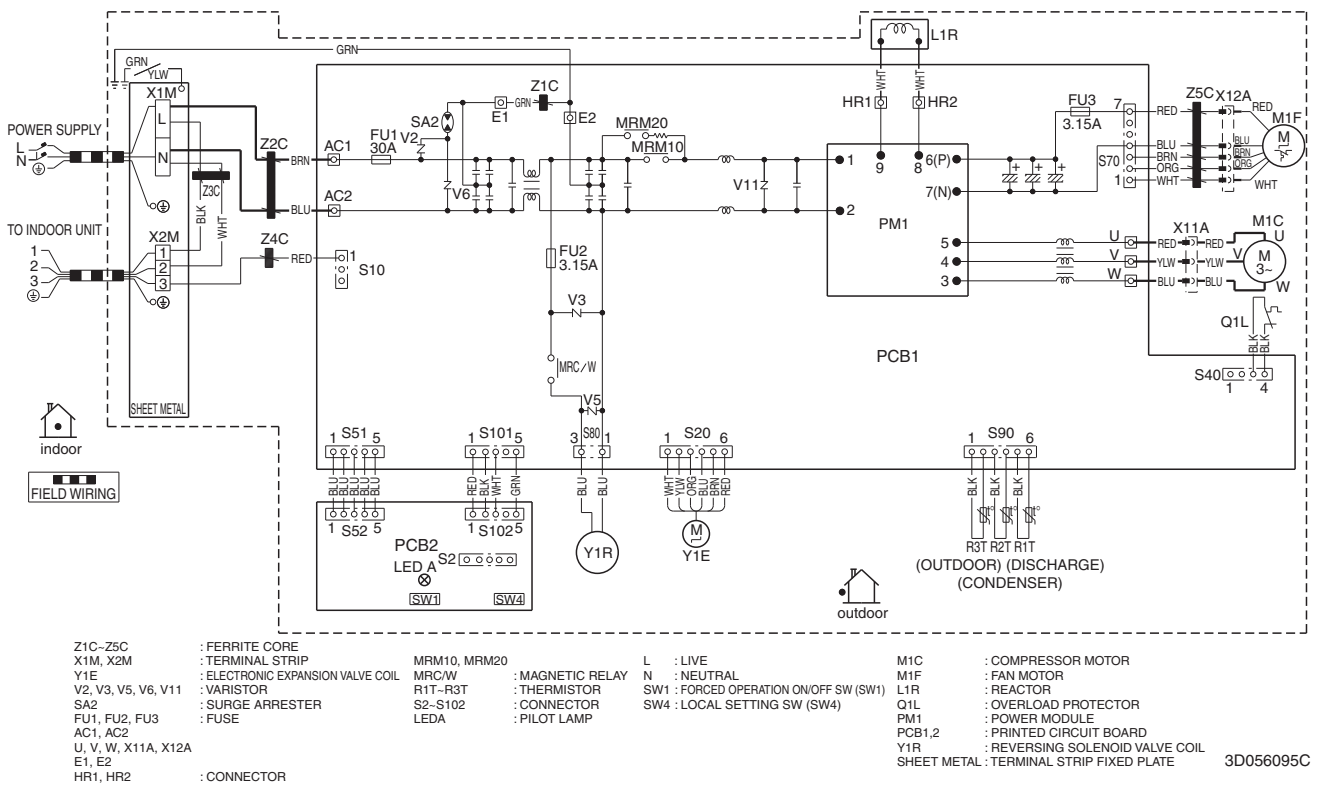

RXS50/60E2(3)V1B, RXS60F2V1B

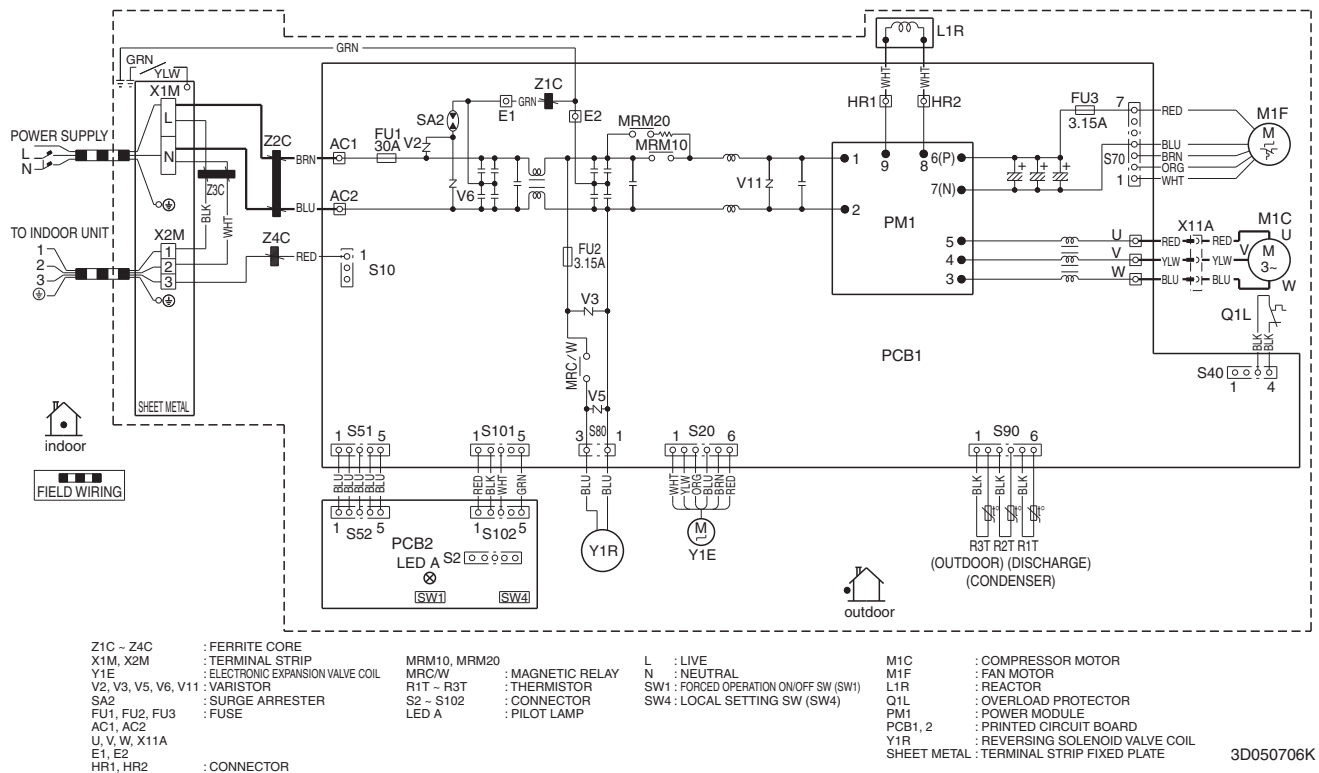

RXS60F3V1B

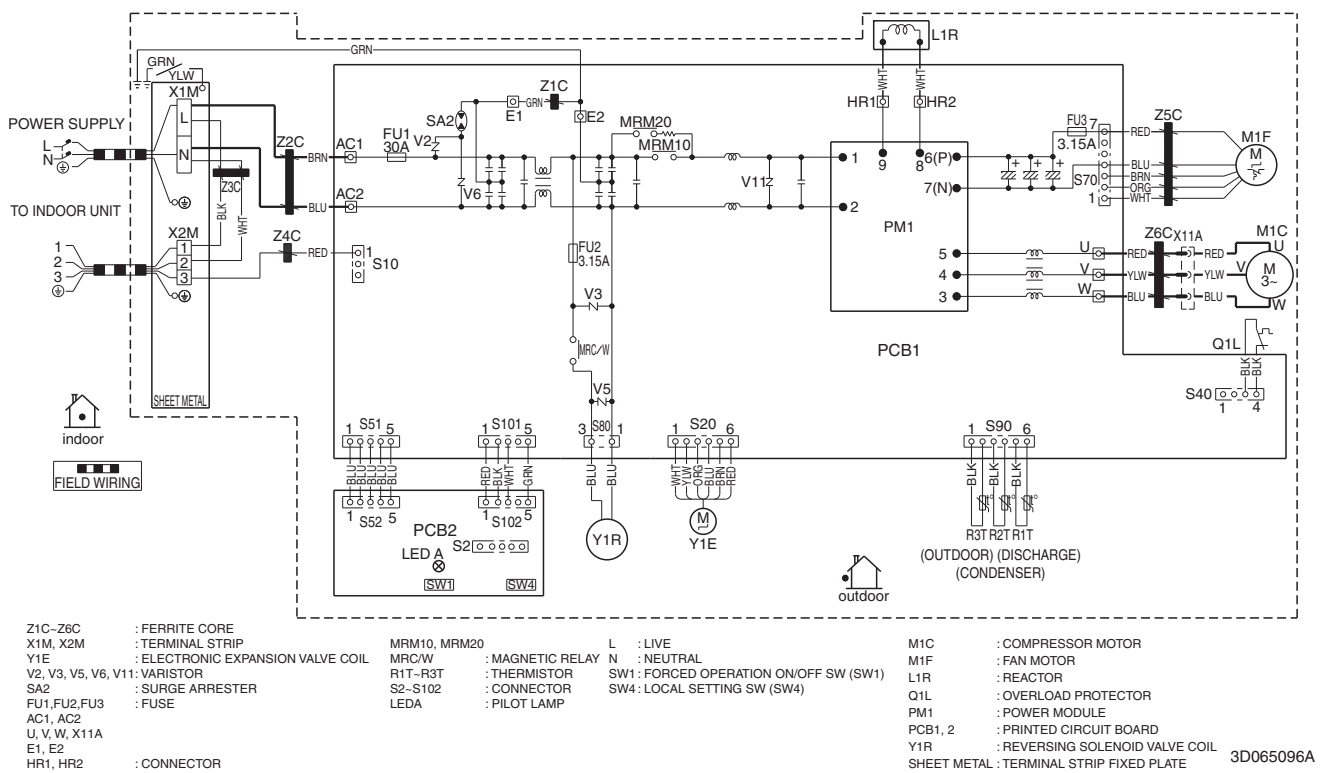

In all of us,
a green heart



Daikin's unique position as a manufacturer of air conditioning equipment, compressors and refrigerants has led to its close involvement in environmental issues. For several years Daikin has had the intension to become a leader in the provision of products that have limited impact on the environment. This challenge demands the eco design and development of a wide range of products and an energy management system, resulting in energy conservation and a reduction of waste.



Daikin Europe N.V. is approved by LRQA for its Quality Management System in accordance with the ISO9001 standard. ISO9001 pertains to quality assurance regarding design, development, manufacturing as well as to services related to the product.



ISO14001 assures an effective environmental management system in order to help protect human health and the environment from the potential impact of our activities, products and services and to assist in maintaining and improving the quality of the environment.



Daikin units comply with the European regulations that guarantee the safety of the product.



Daikin Europe N.V. is participating in the EUROVENT Certification Programme. Products are as listed in the EUROVENT Directory of Certified Products.

"The present publication is drawn up by way of information only and does not constitute an offer binding upon Daikin Europe N.V.. Daikin Europe N.V. has compiled the content of this publication to the best of its knowledge. No express or implied warranty is given for the completeness, accuracy, reliability or fitness for particular purpose of its content and the products and services presented therein. Specifications are subject to change without prior notice. Daikin Europe N.V. explicitly rejects any liability for any direct or indirect damage, in the broadest sense, arising from or related to the use and/or interpretation of this publication. All content is copyrighted by Daikin Europe N.V.."

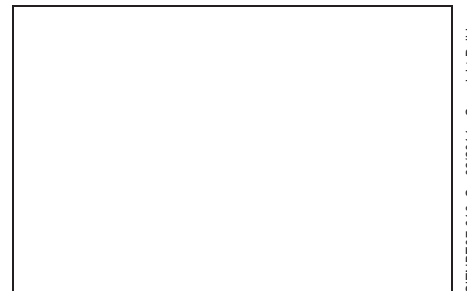

DAIKIN EUROPE N.V.
Naamloze Vennootschap
Zandvoordestraat 300
B-8400 Oostende - Belgium
www.daikin.eu
BE 0412 120 336
RPR Oostende



SIENBE07-618_C