

**DAIKIN**

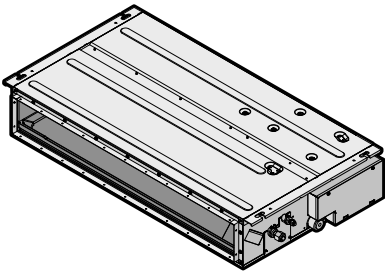

# Installation manual

## Split system air conditioners



**FDXM25F3V1B**  
**FDXM35F3V1B**  
**FDXM50F3V1B**  
**FDXM60F3V1B**

**FDXM25F3V1B9**  
**FDXM35F3V1B9**  
**FDXM50F3V1B9**  
**FDXM60F3V1B9**

Installation manual  
Split system air conditioners

English





# Table of Contents

<b>1</b>	<b>About the documentation</b>	<b>4</b>
1.1	About this document.....	4
<b>2</b>	<b>About the box</b>	<b>4</b>
2.1	Indoor unit .....	4
2.1.1	To remove the accessories from the indoor unit.....	4
<b>3</b>	<b>About the units and options</b>	<b>5</b>
3.1	System layout.....	5
<b>4</b>	<b>Preparation</b>	<b>5</b>
4.1	Preparing the installation site .....	5
4.1.1	Installation site requirements of the indoor unit .....	5
<b>5</b>	<b>Installation</b>	<b>5</b>
5.1	Mounting the indoor unit.....	5
5.1.1	Guidelines when installing the indoor unit.....	5
5.1.2	Guidelines when installing the ducting.....	6
5.1.3	Guidelines when installing the drain piping.....	7
5.2	Connecting the refrigerant piping .....	8
5.2.1	To connect the refrigerant piping to the indoor unit ....	8
5.2.2	To check for leaks.....	8
5.3	Connecting the electrical wiring.....	8
5.3.1	To connect the electrical wiring on the indoor unit.....	8
5.3.2	Specifications of standard wiring components.....	9
<b>6</b>	<b>Commissioning</b>	<b>9</b>
6.1	Checklist before commissioning.....	9
6.2	To perform a test run.....	9
6.3	Error codes when performing a test run .....	10
<b>7</b>	<b>Disposal</b>	<b>10</b>
<b>8</b>	<b>Technical data</b>	<b>10</b>
8.1	Wiring diagram .....	11

## 1 About the documentation

### 1.1 About this document



**INFORMATION**

Make sure that the user has the printed documentation and ask him/her to keep it for future reference.

**Target audience**

Authorised installers



**INFORMATION**

This appliance is intended to be used by expert or trained users in shops, in light industry, and on farms, or for commercial and household use by lay persons.

**Documentation set**

This document is part of a documentation set. The complete set consists of:

- **General safety precautions:**
  - Safety instructions that you **MUST** read before installing
  - Format: Paper (in the box of the indoor unit)
- **Indoor unit installation manual:**
  - Installation instructions
  - Format: Paper (in the box of the indoor unit)

- **Installer reference guide:**
  - Preparation of the installation, good practices, reference data,...
  - Format: Digital files on <http://www.daikineurope.com/support-and-manuals/product-information/>

Latest revisions of the supplied documentation may be available on the regional Daikin website or via your dealer.

The original documentation is written in English. All other languages are translations.

**Technical engineering data**

- A **subset** of the latest technical data is available on the regional Daikin website (publicly accessible).
- The **full set** of latest technical data is available on the Daikin extranet (authentication required).

## 2 About the box

### 2.1 Indoor unit

**WARNING: FLAMMABLE MATERIAL**

The R32 refrigerant (if applicable) in this unit is mildly flammable. Refer to the outdoor unit specifications for the type of refrigerant to be used.

#### 2.1.1 To remove the accessories from the indoor unit

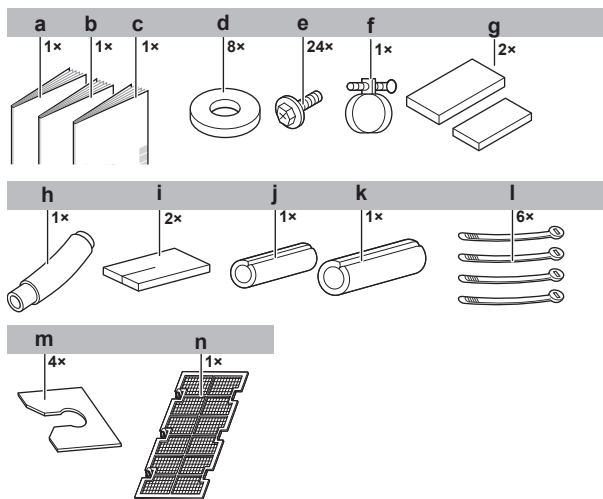

- a Installation manual
- b Operation manual
- c General safety precautions
- d Washers for hanger bracket
- e Screws for duct flanges
- f Metal clamp
- g Sealing pads: small and large
- h Drain hose
- i Sealing material
- j Insulation piece: Small (liquid pipe)
- k Insulation piece: Large (gas pipe)
- l Tie wraps
- m Washer fixing plate
- n Air filter

### 3 About the units and options

#### 3.1 System layout

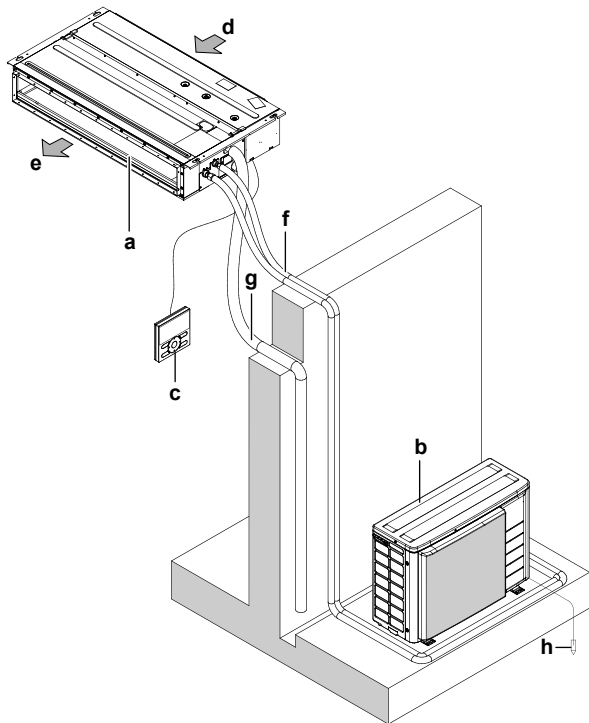

- a Indoor unit
- b Outdoor unit
- c User interface
- d Suction air
- e Discharge air
- f Refrigerant piping + interconnection cable
- g Drain pipe
- h Earth wiring

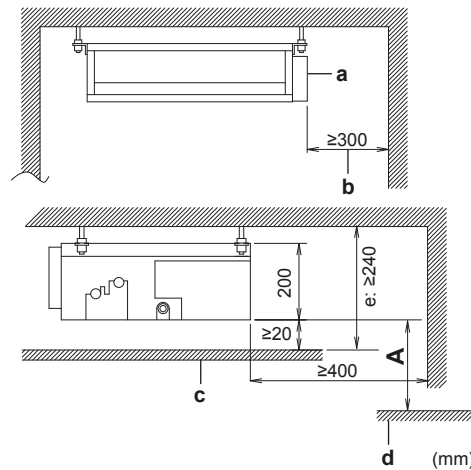

- A Minimum distance to the floor:**  
2.7 m to avoid accidental touching.  
2.5 m in case the fan is covered (e.g. false ceiling, grille, ...)
- a Control box
- b Maintenance space
- c Ceiling
- d Floor surface
- e Select the dimension to ensure downward slope of at least 1/100

### 4 Preparation

#### 4.1 Preparing the installation site

- Provide sufficient space around the unit for servicing and air circulation.
- Choose the installation location with sufficient space for carrying the unit in and out of the site.



**WARNING**

Do NOT install the air conditioner at any place where flammable gas may leak out. If the gas leaks out and stays around the air conditioner, a fire may break out.

#### 4.1.1 Installation site requirements of the indoor unit



**INFORMATION**

The sound pressure level is less than 70 dBA.

- Use **suspension bolts** for installation.
- **Spacing.** Mind the following requirements:

### 5 Installation

#### 5.1 Mounting the indoor unit

##### 5.1.1 Guidelines when installing the indoor unit



**INFORMATION**

**Optional equipment.** When installing optional equipment, also read the installation manual of the optional equipment. Depending on the field conditions, it might be easier to install the optional equipment first.

- **Ceiling strength.** Check whether the ceiling is strong enough to support the weight of the unit. If there is a risk, reinforce the ceiling before installing the unit.
  - For existing ceilings, use anchors.
  - For new ceilings, use sunken inserts, sunken anchors or other field supplied parts.
- **Suspension bolts.** Use W3/8 M10 suspension bolts for installation. Attach the hanger bracket to the suspension bolt. Fix it securely using a nut and washer from the upper and lower sides of the hanger bracket.

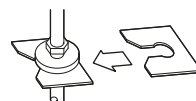

- **Ceiling opening size.** Make sure the ceiling opening is within the following limits:

## 5 Installation

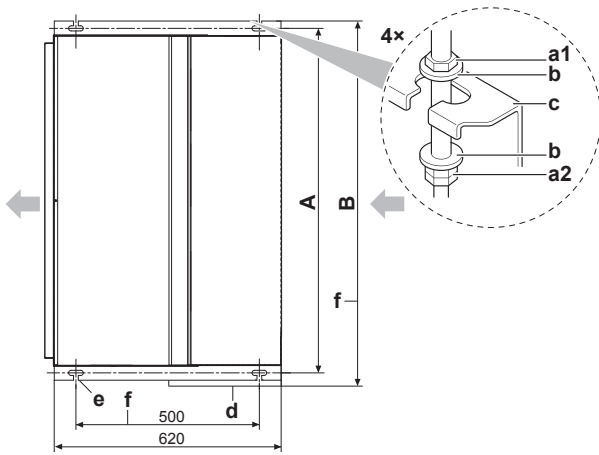

Class	A (mm)	B (mm)
FDXM25+35	740	790
FDXM50+60	1140	1190

- a1 Nut (field supply)
- a2 Double nut (field supply)
- b Washer (accessories)
- c Hanger bracket
- d Control box
- e Suspension bolt pitch
- f Overall dimension

• **External static pressure.** Refer to technical documentation to ensure that the unit's external static pressure is not exceeded.

• **Ceiling opening.** (Ceiling with opening for installation)

- 1 Pass all pipes and wiring through the unit's piping and wiring holes.
- 2 Make sure that the ceiling is level.

• **Installation example:**

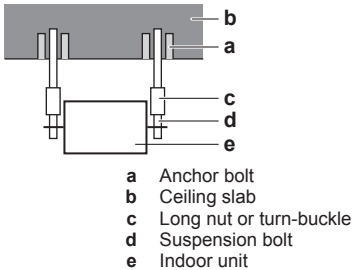

- a Anchor bolt
- b Ceiling slab
- c Long nut or turn-buckle
- d Suspension bolt
- e Indoor unit

• **Install suction cover and air filter (accessory)** In case of bottom suction:

- 3 Remove the suction cover.

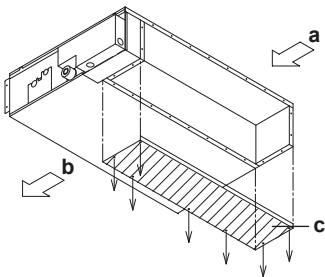

- 4 Reattach the removed suction cover.

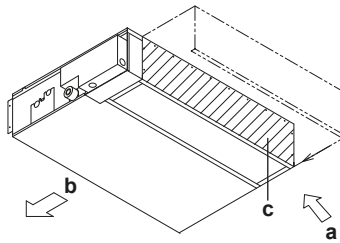

- a Air inlet
- b Air outlet
- c Suction cover

- 5 Attach the air filter (accessory) by pushing down the hooks (2 hooks for 25+35 type, 3 hooks for 50+60 type).

rear suction

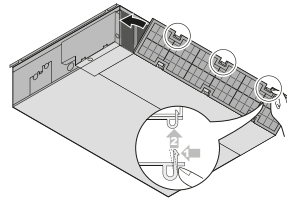

bottom suction

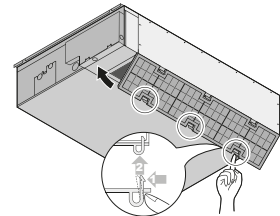

• **Install the unit temporarily.**

- 6 Attach the hanger bracket to the suspension bolt.

- 7 Fix the unit securely.

• **Level.** Make sure the unit is level at all four corners using a level or a water-filled vinyl tube.

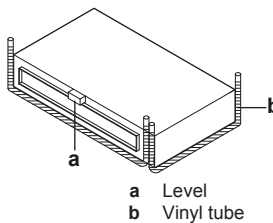

- a Level
- b Vinyl tube

- 8 Tighten the upper nut.



### NOTICE

Do NOT install the unit tilted. **Possible consequence:** If the unit is tilted against the direction of the condensate flow (the drain piping side is raised), the float switch might malfunction and cause water to drip.

### 5.1.2 Guidelines when installing the ducting



#### WARNING

If the one or more rooms are connected with the unit via duct system make sure:

- there are no operating ignition sources (example: open flames, an operating gas appliance or an operating electric heater) in case the floor area is less than  $A_{min}$  specified in the General safety precautions;
- no auxiliary devices, which may be a potential ignition source, are installed in the duct work (example: hot surfaces with a temperature exceeding 700°C and electric switching device);
- only auxiliary devices approved by manufacturer are used in the duct work.



#### WARNING

Do NOT install operating ignition sources (example: open flames, an operating gas appliance or an operating electric heater) in the duct work.

The ducting is to be field supplied.

- **Air inlet side.** Attach the duct and intake-side flange (field supply). For connecting the flange, use 7 accessory screws.

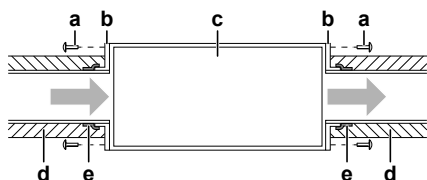

- a Connection screw (accessory)
- b Flange (field supply)
- c Main unit
- d Insulation (field supply)
- e Aluminium tape (field supply)

- **Filter.** Be sure to attach an air filter inside the air passage on the intake side. Use an air filter with dust collecting efficiency  $\geq 50\%$  (gravimetric method). The included filter is not used when the intake duct is attached.
- **Air outlet side.** Connect the duct according to the inside dimension of the outlet-side flange.
- **Air leaks.** Wind aluminium tape around the intake side flange and duct connection. Make sure there are no air leaks at any other connection.
- **Insulation.** Insulate the duct to prevent condensation from forming. Use glass wool or polyethylene foam 25 mm thick.

### 5.1.3 Guidelines when installing the drain piping

#### General guidelines

- **Drain pump.** For this "high lift type", the drainage sounds will be reduced when the drain pump is installed in a higher location. Recommended height is 300 mm.
- **Pipe length.** Keep drain piping as short as possible.
- **Pipe size.** Keep the pipe size equal to or greater than that of the connecting pipe (vinyl pipe of 20 mm nominal diameter and 26 mm outer diameter).
- **Slope.** Make sure the drain piping slopes down (at least 1/100) to prevent air from being trapped in the piping. Use hanging bars as shown.

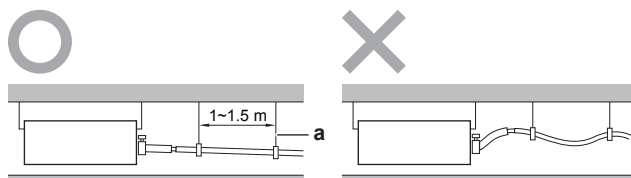

- a Hanging bar
- O Allowed
- X Not allowed

- **Condensation.** Take measures against condensation. Insulate the complete drain piping in the building.

#### To connect the drain piping to the indoor unit



#### NOTICE

Incorrect connection of the drain hose might cause leaks, and damage the installation space and surroundings.

- 1 Push the drain hose as far as possible over the drain pipe connection.
- 2 Tighten the metal clamp until the screw head is less than 4 mm from the metal clamp part.
- 3 Check for water leaks (see "To check for water leaks" on page 7).
- 4 Install the insulation piece (drain pipe).

- 5 Wind the large sealing pad (= insulation) around the metal clamp and drain hose, and fix it with cable ties.
- 6 Connect the drain piping to the drain hose.

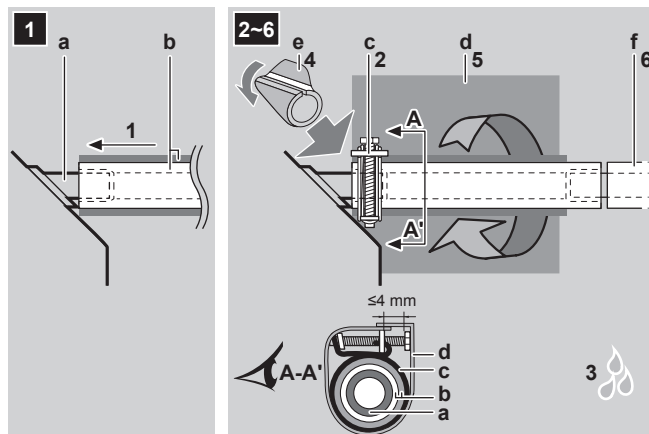

- a Drain pipe connection (attached to the unit)
- b Drain hose (accessory)
- c Metal clamp (accessory)
- d Large sealing pad (accessory)
- e Insulation piece (drain pipe) (accessory)
- f Drain piping (field supply)



#### NOTICE

- Do NOT remove the drain pipe plug. Water might leak out.
- Use the drain outlet only to discharge the water if the drain pump is not used or before maintenance.
- Insert and remove the drain plug gently. Excessive force may deform the drain socket of the drain pan.

#### Pull out the plug.

- Do NOT wiggle the plug up and down.

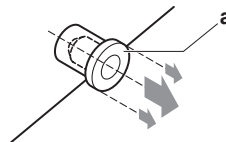

#### Push in the plug.

- Set the plug and push it in using a Phillips screwdriver.

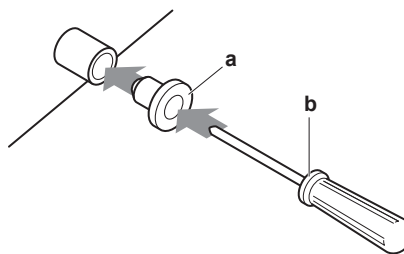

- a Drain plug
- b Phillips screwdriver

#### To check for water leaks

Gradually pour approximately 1 l of water in the drain pan, and check for water leaks.

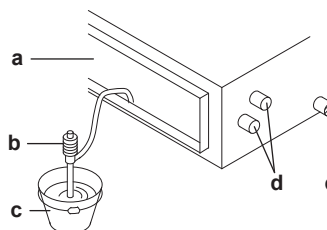

- a Air outlet
- b Portable pump

## 5 Installation

- c Bucket
- d Refrigerant pipes
- e Drain outlet

### 5.2 Connecting the refrigerant piping



**DANGER: RISK OF BURNING**

#### 5.2.1 To connect the refrigerant piping to the indoor unit



**CAUTION**

Install refrigerating pipe or components in a position where they are unlikely to be exposed to any substance which may corrode refrigerant containing components, unless the components are constructed of materials which are inherently resistant to being corroded or are suitably protected against being so corroded.



**WARNING: FLAMMABLE MATERIAL**

The R32 refrigerant (if applicable) in this unit is mildly flammable. Refer to the outdoor unit specifications for the type of refrigerant to be used.

- **Pipe length.** Keep refrigerant piping as short as possible.
- **Flare connections.** Connect refrigerant piping to the unit using flare connections.
- **Insulation.** Insulate the refrigerant piping on the indoor unit as follows:

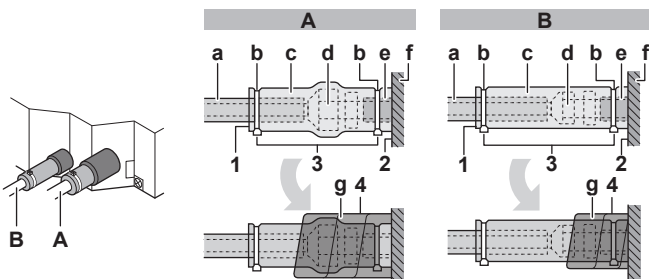

- A Gas piping
- B Liquid piping

- a Insulation material (field supply)
- b Cable tie (accessory)
- c Insulation pieces: Large (gas pipe), small (liquid pipe) (accessories)
- d Flare nut (attached to the unit)
- e Refrigerant pipe connection (attached to the unit)
- f Unit
- g Sealing pads: Medium 1 (gas pipe), medium 2 (liquid pipe) (accessories)

- 1 Turn up the seams of the insulation pieces.
- 2 Attach to the base of the unit.
- 3 Tighten the cable ties on the insulation pieces.
- 4 Wrap the sealing pad from the base of the unit to the top of the flare nut.



**NOTICE**

Make sure to insulate all refrigerant piping. Any exposed piping might cause condensation.

#### 5.2.2 To check for leaks



**NOTICE**

Do NOT exceed the unit's maximum working pressure (see "PS High" on the unit name plate).



**NOTICE**

Make sure to use a recommended bubble test solution from your wholesaler. Do not use soap water, which may cause cracking of flare nuts (soap water may contain salt, which absorbs moisture that will freeze when the piping gets cold), and/or lead to corrosion of flared joints (soap water may contain ammonia which causes a corrosive effect between the brass flare nut and the copper flare).

- 1 Charge the system with nitrogen gas up to a gauge pressure of at least 200 kPa (2 bar). It is recommended to pressurize to 3000 kPa (30 bar) in order to detect small leaks.
- 2 Check for leaks by applying the bubble test solution to all connections.
- 3 Discharge all nitrogen gas.

### 5.3 Connecting the electrical wiring



**DANGER: RISK OF ELECTROCUTION**



**WARNING**

ALWAYS use multicore cable for power supply cables.



**WARNING**

If the supply cord is damaged, it MUST be replaced by the manufacturer, its service agent or similarly qualified persons in order to avoid a hazard.

#### 5.3.1 To connect the electrical wiring on the indoor unit

It is important to keep the power supply and the transmission wiring separated from each other. In order to avoid any electrical interference the distance between both wirings should ALWAYS be at least 50 mm.



**NOTICE**

Be sure to keep the power line and transmission line apart from each other. Transmission wiring and power supply wiring may cross, but may NOT run parallel.

- 1 Remove the service cover.

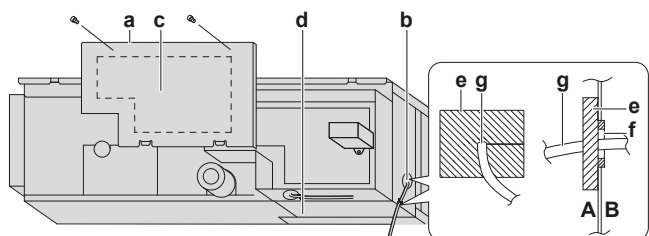

- A Outside the unit
- B Inside the unit
- a Control box cover
- b Connection of interconnection cable (including earth)
- c Wiring diagram
- d Connection of user interface wiring
- e Sealing material (accessory)
- f Opening for cables
- g Wire

- 2 **User interface cable:** Route the cable through the frame, connect the cable to the terminal block, and fix the cable with a cable tie.
- 3 **Interconnection cable (indoor→outdoor):** Route the cable through the frame, connect the cable to the terminal block (make sure the numbers match with the numbers on the outdoor unit, and connect the earth wire), and fix the cable with a cable tie.



- Wrap the cables with the sealing material (accessory) to prevent water from entering the unit. Seal all gaps to prevent small animals from entering the system.

**WARNING**

Provide adequate measures to prevent that the unit can be used as a shelter by small animals. Small animals that make contact with electrical parts can cause malfunctions, smoke or fire.

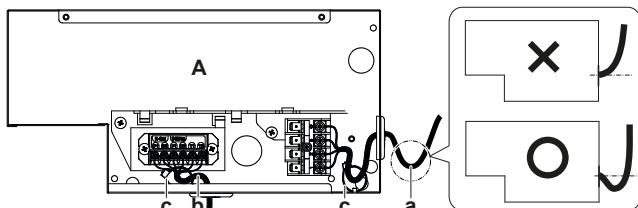

- A Indoor PCB (ASSY)
- a Power supply and earth wiring
- b Transmission and user interface wiring
- c Clamps
- X Not allowed
- O Allowed

- Reattach the service cover.

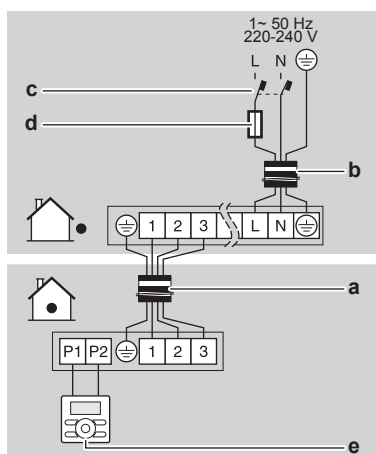

- a Interconnection cable
- b Power supply cable
- c Earth leakage circuit breaker
- d Fuse
- e User interface

### 5.3.2 Specifications of standard wiring components

Component	Specification
Interconnection cable (indoor↔outdoor)	Minimum cable section of 2.5 mm <sup>2</sup> and applicable for 230 V
User interface cable	Vinyl cords with 0.75 to 1.25 mm <sup>2</sup> sheath or cables (2-core wires) Maximum 500 m

## 6 Commissioning



### NOTICE

NEVER operate the unit without thermistors and/or pressure sensors/switches. Burning of the compressor might result.

### 6.1 Checklist before commissioning

After the installation of the unit, first check the following items. Once all below checks are fulfilled, the unit MUST be closed, ONLY then can the unit be powered up.

<input type="checkbox"/>	You read the complete installation instructions, as described in the <b>installer reference guide</b> .
<input type="checkbox"/>	The <b>indoor units</b> are properly mounted.
<input type="checkbox"/>	In case a wireless user interface is used: The <b>indoor unit decoration panel</b> with infrared receiver is installed.
<input type="checkbox"/>	The <b>outdoor unit</b> is properly mounted.
<input type="checkbox"/>	There are <b>NO missing phases</b> or <b>reversed phases</b> .
<input type="checkbox"/>	The system is properly <b>earthed</b> and the earth terminals are tightened.
<input type="checkbox"/>	The <b>fuses</b> or locally installed protection devices are installed according to this document, and have <b>NOT</b> been bypassed.
<input type="checkbox"/>	The <b>power supply voltage</b> matches the voltage on the identification label of the unit.
<input type="checkbox"/>	There are <b>NO loose connections</b> or damaged electrical components in the switch box.
<input type="checkbox"/>	The <b>insulation resistance</b> of the compressor is OK.
<input type="checkbox"/>	There are <b>NO damaged components</b> or <b>squeezed pipes</b> on the inside of the indoor and outdoor units.
<input type="checkbox"/>	There are <b>NO refrigerant leaks</b> .
<input type="checkbox"/>	The correct pipe size is installed and the <b>pipes</b> are properly insulated.
<input type="checkbox"/>	The <b>stop valves</b> (gas and liquid) on the outdoor unit are fully open.

### 6.2 To perform a test run

This task is only applicable when using the BRC1E52 or BRC1E53 user interface. When using any other user interface, see the installation manual or service manual of the user interface.



### NOTICE

Do not interrupt the test run.



### INFORMATION

**Backlight.** To perform an ON/OFF action on the user interface, the backlight does not need to be lit. For any other action, it needs to be lit first. The backlight is lit for ±30 seconds when you press a button.



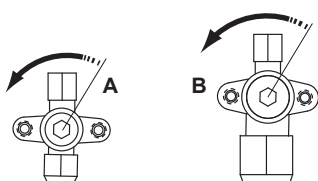



- Perform introductory steps.

#	Action
1	Open the liquid stop valve (A) and gas stop valve (B) by removing the stem cap and turning counterclockwise with a hex wrench until it stops. 
2	Close the service cover to prevent electric shocks.
3	Turn ON power for at least 6 hours before starting operation to protect the compressor.

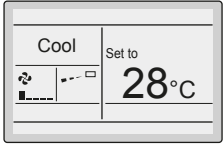
## 7 Disposal

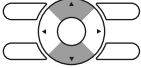
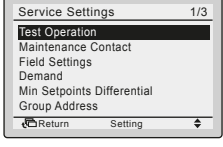

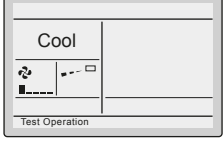
#	Action
4	On the user interface, set the unit to cooling operation mode.

### 2 Start the test run

#	Action	Result
1	Go to the home menu.	
2	Press at least 4 seconds. 	The Service Settings menu is displayed.
3	Select Test Operation. 	
4	Press. 	Test Operation is displayed on the home menu. 
5	Press within 10 seconds. 	Test run starts.

### 3 Check operation for 3 minutes.

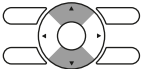
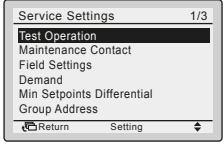
### 4 Stop the test run.

#	Action	Result
1	Press at least 4 seconds. 	The Service Settings menu is displayed.
2	Select Test Operation. 	
3	Press. 	The unit returns to normal operation, and the home menu is displayed.

## 6.3 Error codes when performing a test run

If the installation of the outdoor unit has NOT been done correctly, the following error codes may be displayed on the user interface:

Error code	Possible cause
Nothing displayed (the currently set temperature is not displayed)	<ul style="list-style-type: none"> <li>The wiring is disconnected or there is a wiring error (between power supply and outdoor unit, between outdoor unit and indoor units, between indoor unit and user interface).</li> <li>The fuse on the outdoor or indoor unit PCB has blown.</li> </ul>
E3, E4 or L8	<ul style="list-style-type: none"> <li>The stop valves are closed.</li> <li>The air inlet or air outlet is blocked.</li> </ul>
E7	There is a missing phase in case of three-phase power supply units. <b>Note:</b> Operation will be impossible. Turn OFF the power, recheck the wiring, and switch two of the three electrical wires.
L4	The air inlet or air outlet is blocked.
U0	The stop valves are closed.
U2	<ul style="list-style-type: none"> <li>There is a voltage imbalance.</li> <li>There is a missing phase in case of three-phase power supply units. <b>Note:</b> Operation will be impossible. Turn OFF the power, recheck the wiring, and switch two of the three electrical wires.</li> </ul>
U4 or UF	The inter-unit branch wiring is not correct.
UA	The outdoor and indoor unit are incompatible.

## 7 Disposal

















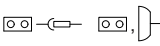

### NOTICE

Do NOT try to dismantle the system yourself: dismantling of the system, treatment of the refrigerant, oil and other parts MUST comply with applicable legislation. Units MUST be treated at a specialised treatment facility for reuse, recycling and recovery.

## 8 Technical data

- A **subset** of the latest technical data is available on the regional Daikin website (publicly accessible).
- The **full set** of latest technical data is available on the Daikin extranet (authentication required).

## 8.1 Wiring diagram

Unified Wiring Diagram Legend					
For applied parts and numbering, refer to the wiring diagram on the unit. Part numbering is by Arabic numbers in ascending order for each part and is represented in the overview below by symbol "*" in the part code.					
	:	CIRCUIT BREAKER		:	PROTECTIVE EARTH
	:	CONNECTION		:	PROTECTIVE EARTH (SCREW)
	:	CONNECTOR		:	RECTIFIER
	:	EARTH		:	RELAY CONNECTOR
	:	FIELD WIRING		:	SHORT-CIRCUIT CONNECTOR
	:	FUSE		:	TERMINAL
	:	INDOOR UNIT		:	TERMINAL STRIP
	:	OUTDOOR UNIT		:	WIRE CLAMP
BLK : BLACK	GRN : GREEN	PNK : PINK	WHT : WHITE		
BLU : BLUE	GRY : GREY	PRP, PPL : PURPLE	YLW : YELLOW		
BRN : BROWN	ORG : ORANGE	RED : RED			
A*P : PRINTED CIRCUIT BOARD	PS : SWITCHING POWER SUPPLY				
BS* : PUSHBUTTON ON/OFF, OPERATION SWITCH	PTC* : THERMISTOR PTC				
BZ, H*O : BUZZER	Q* : INSULATED GATE BIPOLAR TRANSISTOR (IGBT)				
C* : CAPACITOR	Q*DI : EARTH LEAK CIRCUIT BREAKER				
AC*, CN*, E*, HA*, HE*, HL*, HN* : CONNECTION, CONNECTOR	Q*L : OVERLOAD PROTECTOR				
HR*, MR*_A, MR*_B, S*, U, V, W, X*A, K*R_*	Q*M : THERMO SWITCH				
D*, V*D : DIODE	R* : RESISTOR				
DB* : DIODE BRIDGE	R*T : THERMISTOR				
DS* : DIP SWITCH	RC : RECEIVER				
E*H : HEATER	S*C : LIMIT SWITCH				
F*U, FU* (FOR CHARACTERISTICS, REFER TO PCB INSIDE YOUR UNIT)	S*L : FLOAT SWITCH				
FG* : CONNECTOR (FRAME GROUND)	S*NPH : PRESSURE SENSOR (HIGH)				
H* : HARNESS	S*NPL : PRESSURE SENSOR (LOW)				
H*P, LED*, V*L : PILOT LAMP, LIGHT EMITTING DIODE	S*PH, HPS* : PRESSURE SWITCH (HIGH)				
HAP : LIGHT EMITTING DIODE (SERVICE MONITOR GREEN)	S*PL : PRESSURE SWITCH (LOW)				
HIGH VOLTAGE : HIGH VOLTAGE	S*T : THERMOSTAT				
IES : INTELLIGENT EYE SENSOR	S*RH : HUMIDITY SENSOR				
IPM* : INTELLIGENT POWER MODULE	S*W, SW* : OPERATION SWITCH				
K*R, KCR, KFR, KHuR, K*M : MAGNETIC RELAY	SA*, F1S : SURGE ARRESTOR				
L : LIVE	SR*, WLU : SIGNAL RECEIVER				
L* : COIL	SS* : SELECTOR SWITCH				
L*R : REACTOR	SHEET METAL : TERMINAL STRIP FIXED PLATE				
M* : STEPPER MOTOR	T*R : TRANSFORMER				
M*C : COMPRESSOR MOTOR	TC, TRC : TRANSMITTER				
M*F : FAN MOTOR	V*, R*V : VARISTOR				
M*P : DRAIN PUMP MOTOR	V*R : DIODE BRIDGE				
M*S : SWING MOTOR	WRC : WIRELESS REMOTE CONTROLLER				
MR*, MRCW*, MRM*, MRN* : MAGNETIC RELAY	X* : TERMINAL				
N : NEUTRAL	X*M : TERMINAL STRIP (BLOCK)				
n=*, N=* : NUMBER OF PASSES THROUGH FERRITE CORE	Y*E : ELECTRONIC EXPANSION VALVE COIL				
PAM : PULSE-AMPLITUDE MODULATION	Y*R, Y*S : REVERSING SOLENOID VALVE COIL				
PCB* : PRINTED CIRCUIT BOARD	Z*C : FERRITE CORE				
PM* : POWER MODULE	ZF, Z*F : NOISE FILTER				

ERC



**DAIKIN INDUSTRIES CZECH REPUBLIC s.r.o.**  
U Nové Hospody 1/1155, 301 00 Plzeň Skvrňany, Czech Republic

**DAIKIN EUROPE N.V.**  
Zandvoordestraat 300, B-8400 Oostende, Belgium

Copyright 2017 Daikin

4P472267-1B 2018.07