

**DAIKIN**



# INSTALLATION MANUAL

**Split System air conditioners**

FFQ25C2VEB  
FFQ35C2VEB  
FFQ50C2VEB  
FFQ60C2VEB

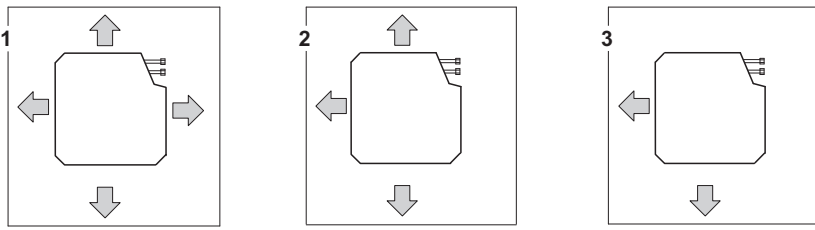

1

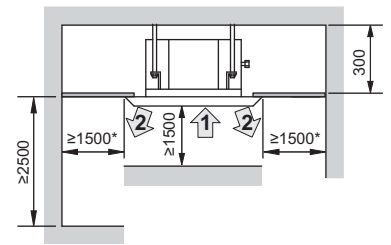

2

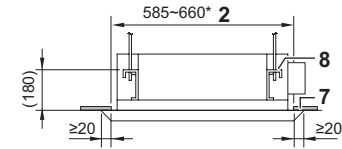
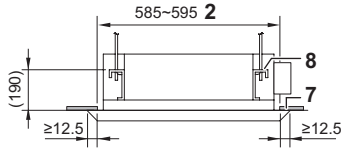
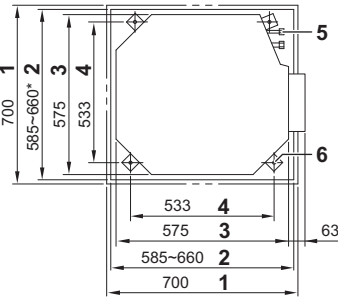
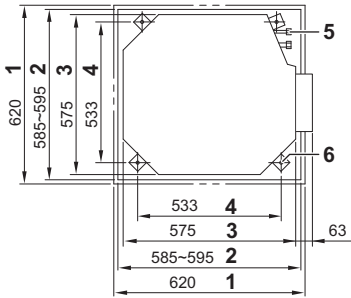

3.1

3.2

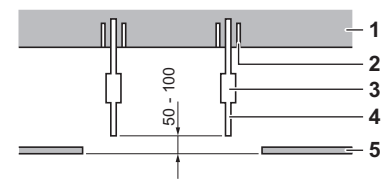

4

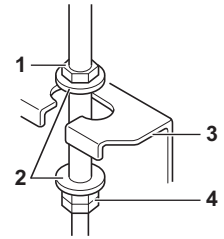

5

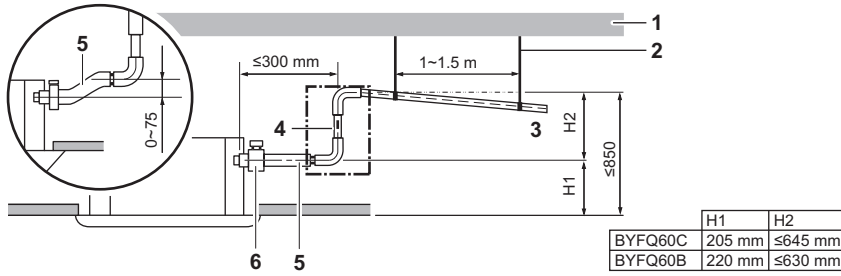

6

7

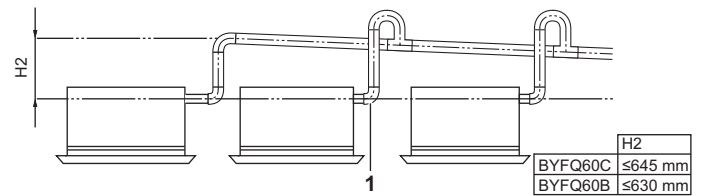
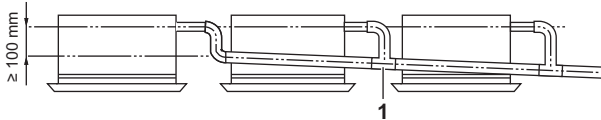
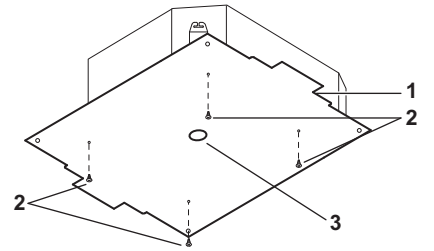

8

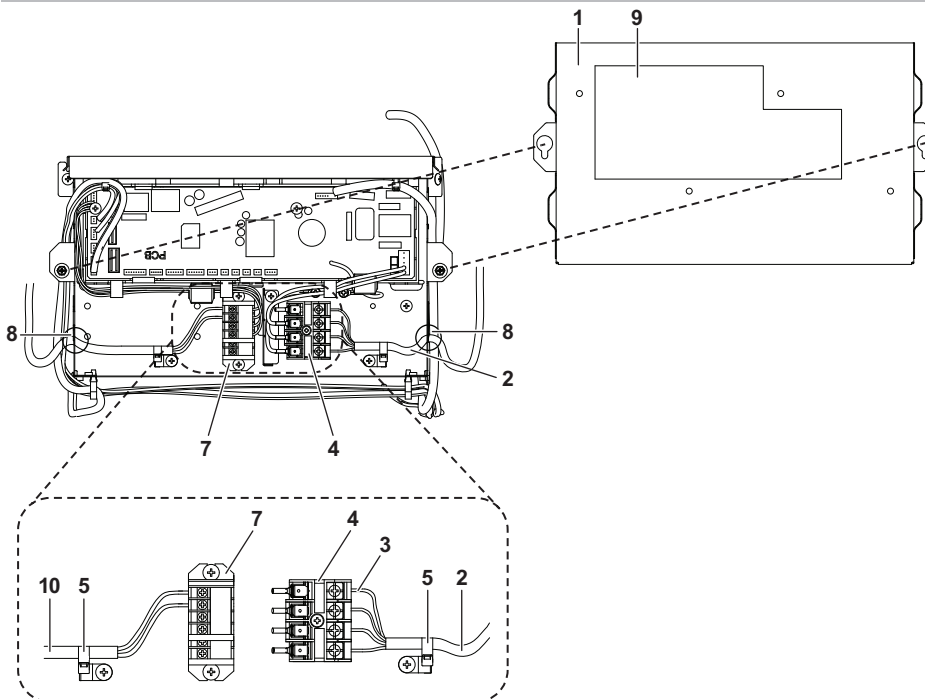

9

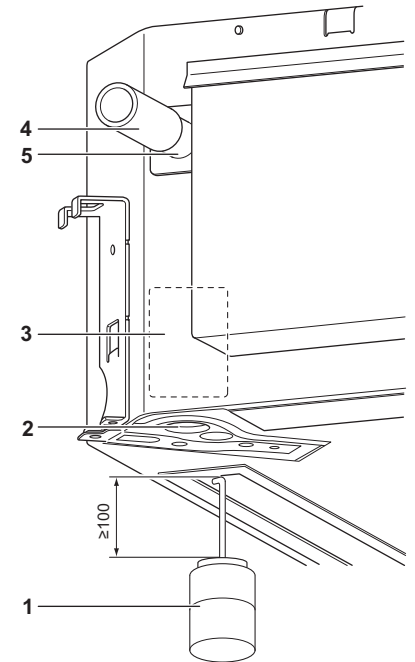

10



**Contents**

	Page
Before installation.....	1
Selecting installation site.....	2
Preparations before installation.....	3
Indoor unit installation.....	3
Refrigerant piping work.....	4
Drain piping work.....	5
Electric wiring work.....	6
Wiring example and how to set the remote controller.....	7
Wiring example.....	8
Installation of the decoration panel.....	8
Field setting.....	8
Test operation.....	9
Wiring diagram.....	10

**!** READ THESE INSTRUCTIONS CAREFULLY BEFORE INSTALLATION. KEEP THIS MANUAL IN A HANDY PLACE FOR FUTURE REFERENCE.

IMPROPER INSTALLATION OR ATTACHMENT OF EQUIPMENT OR ACCESSORIES COULD RESULT IN ELECTRIC SHOCK, SHORT-CIRCUIT, LEAKS, FIRE OR OTHER DAMAGE TO THE EQUIPMENT. BE SURE ONLY TO USE ACCESSORIES MADE BY DAIKIN WHICH ARE SPECIFICALLY DESIGNED FOR USE WITH THE EQUIPMENT AND HAVE THEM INSTALLED BY A PROFESSIONAL.

IF UNSURE OF INSTALLATION PROCEDURES OR USE, ALWAYS CONTACT YOUR DAIKIN DEALER FOR ADVICE AND INFORMATION.

The English text is the original instruction. Other languages are translations of the original instructions.

**Before installation**

- Leave the unit inside its packaging until you reach the installation site. Where unpacking is unavoidable, use a sling of soft material or protective plates together with a rope when lifting, this to avoid damage or scratches to the unit. When unpacking the unit or when moving the unit after unpacking, be sure to lift the unit by holding on to the hanger bracket without exerting any pressure on other parts, especially on refrigerant piping, drain piping and other resin parts.
- Refer to the installation manual of the outdoor unit for items not described in this manual.
- Caution concerning refrigerant series R410A:  
The connectable outdoor units must be designed exclusively for R410A.

**Precautions**

- Do not install or operate the unit in rooms mentioned below.
  - Places with mineral oil, or filled with oil vapour or spray like in kitchens. (Plastic parts may deteriorate.)
  - Where corrosive gas like sulphurous gas exists. (Copper tubing and brazed spots may corrode.)
  - Where volatile flammable gas like thinner or gasoline is used.
  - Where machines generating electromagnetic waves exist. (Control system may malfunction.)
  - Where the air contains high levels of salt such as air near the ocean and where voltage fluctuates a lot (e.g. in factories). Also in vehicles or vessels.
- When selecting the installation site, use the supplied paper pattern for installation.
- Do not install accessories on the casing directly. Drilling holes in the casing may damage electrical wires and consequently cause fire.

**Accessories**

Check if the following accessories are included with your unit.

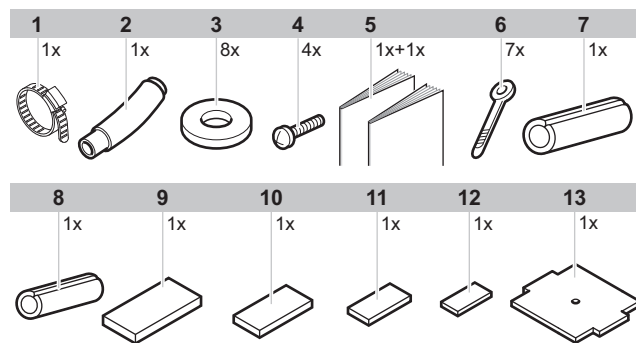

- 1 Metal clamp
- 2 Drain hose
- 3 Washer for hanger bracket
- 4 Screw
- 5 Installation manual and Operation manual
- 6 Clamp
- 7 Insulation for fitting for gas pipe
- 8 Insulation for fitting for liquid pipe
- 9 Large sealing pad
- 10 Medium 1 sealing pad
- 11 Medium 2 sealing pad
- 12 Small sealing pad
- 13 Paper pattern for installation (cut out from upper part of packing)

**Optional accessories**

- There are two types of remote controllers: wired and wireless. Select a remote controller according to customers request and install in an appropriate place. Refer to catalogues and technical literature for selecting a suitable remote controller.
- This indoor unit requires installation of an optional decoration panel.

**For the following items, take special care during construction and check after installation is finished**

Tick ✓ when checked	
<input type="checkbox"/>	Is the indoor unit fixed firmly? The unit may drop, vibrate or make noise.
<input type="checkbox"/>	Is the gas leak test finished? It may result in insufficient cooling or heating.
<input type="checkbox"/>	Is the unit fully insulated? Condensate water may drip.
<input type="checkbox"/>	Does drainage flow smoothly? Condensate water may drip.
<input type="checkbox"/>	Does the power supply voltage correspond to that shown on the name plate? The unit may malfunction or components may burn out.
<input type="checkbox"/>	Are wiring and piping correct? The unit may malfunction or components may burn out.
<input type="checkbox"/>	Is the unit safely grounded? Dangerous at electric leakage.
<input type="checkbox"/>	Is the wiring size according to specifications? The unit may malfunction or components may burn out.
<input type="checkbox"/>	Is nothing blocking the air outlet or inlet of either the indoor or outdoor units? It may result in insufficient cooling or heating.
<input type="checkbox"/>	Are refrigerant piping length and additional refrigerant charge noted down? The refrigerant charge in the system might not be clear.

**Notes to the installer**

- Read this manual carefully to ensure correct installation. Be sure to instruct the customer how to properly operate the system and show him/her the enclosed operation manual.
- Explain to the customer what system is installed on the site. Be sure to fill out the appropriate installation specifications in the chapter "What to do before operation" of the outdoor unit operation manual.

**Selecting installation site**

When the conditions in the ceiling are exceeding 30°C and a relative humidity of 80%, or when fresh air is inducted into the ceiling, an additional insulation is required (minimum 10 mm thickness, polyethylene foam).

For this unit you can select different air flow directions. It is necessary to purchase an optional blocking pad kit to discharge the air in 3 or 4 (closed corners) directions.

Install the unit so that air vents, lights, or machines near the unit do not interfere with the air flow.

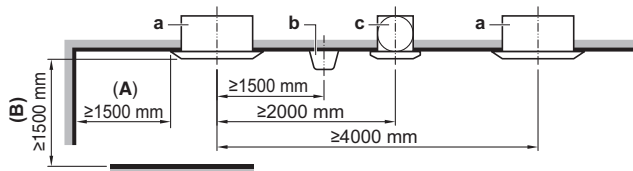

- a Indoor unit
- b Lighting  
The figure describes about a ceiling lighting, but a recessed ceiling light is not restricted.
- c Air fan
- A If the air outlet is closed, space marked (A) should be 500 mm at least. In addition, if both the right and left corner of this air outlet are closed, space marked (A) should be 200 mm at least.
- B  $\geq 1500$  mm from any static volume

- 1 Select an installation site where the following conditions are fulfilled and that meets your customer's approval.
  - Where optimum air distribution can be ensured.
  - Where nothing blocks air passage.
  - Where condensate water can be properly drained.
  - Where the false ceiling is not noticeably on an incline.
  - Where sufficient clearance for maintenance and service can be ensured.
  - Where there is no risk of flammable gas leaking.
  - The equipment is not intended for use in a potentially explosive atmosphere.
  - Where piping between indoor and outdoor units is possible within the allowable limit. (Refer to the installation manual of the outdoor unit.)
  - Keep indoor unit, outdoor unit, inter unit wiring and remote controller wiring at least 1 meter away from televisions and radios. This is to prevent image interference and noise in those electrical appliances. (Noise may be generated depending on the conditions under which the electric wave is generated, even if 1 meter is kept.)
  - When installing the wireless remote controller kit, the distance between wireless remote controller and indoor unit might be shorter if there are fluorescent lights who are electrically started in the room. The indoor unit must be installed as far as possible away from fluorescent lights.

**2 Ceiling height**

This indoor unit may be installed on ceilings up to 3.5 m in height. However, it becomes necessary to make field settings using the remote controller when installing the unit at a height over 2.7 m.

To avoid accidental touching, it is recommended to install the unit higher than 2.5 m.

Refer to "Field setting" on page 8 and to the decoration panel installation manual.

**3 Air flow directions**

Select the air flow directions best suited to the room and point of installation. (For air discharge in 3 directions, it is necessary to make field settings by means of the remote controller and to close the air outlet(s). Refer to the installation manual of the optional blocking pad kit and to "Field setting" on page 8. (See figure 1) (↑: air flow direction)

- 1 All-round air discharge
- 2 Air discharge in 4 directions
- 3 Air discharge in 3 directions

**NOTE** Air flow directions as shown in figure 1 merely serve as examples of possible air flow directions.

**4 Use suspension bolts for installation. Check whether the ceiling is strong enough to support the weight of the indoor unit. If there is a risk, reinforce the ceiling before installing the unit.**

(The installation pitch is marked on the paper pattern for installation. Refer to it to check for points requiring reinforcing.) Space required for installation see figure 2 (↑: air flow direction)

- 1 Air discharge
- 2 Air inlet

**NOTE** Leave 200 mm or more space where marked with \*, on sides where the air outlet is closed.

## Preparations before installation

### 1 Relation of ceiling opening to unit and suspension bolt position.

In case of decoration panel

BYFQ60C: See figure 3.1

BYFQ60B: See figure 3.2

- 1 Decoration panel dimensions
- 2 Ceiling opening dimensions
- 3 Indoor unit dimensions
- 4 Suspension bolt pitch dimensions
- 5 Refrigerant piping
- 6 Suspension bolt (x4)
- 7 False ceiling
- 8 Hanger bracket

- Install the inspection opening on the control box side where maintenance and inspection of the control box and drain pump are easy.

- 1 Inspection opening

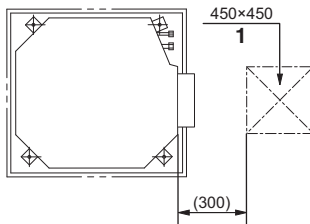

In case of decoration panel BYFQ60B

#### NOTE



Installation is possible with a ceiling dimension of 660 mm (marked with\*). However, to achieve a ceiling-panel overlapping dimension of 20 mm, the spacing between the ceiling and the unit should be 45 mm or less. If the spacing between ceiling and the unit is over 45 mm, attach ceiling material to the part or recover the ceiling.

### 2 Make the ceiling opening needed for installation where applicable. (For existing ceilings.)

- Refer to the paper pattern for installation for the ceiling opening dimensions.
- Create the ceiling opening required for installation. From the side of the opening to the casing outlet or inspection opening, implement the refrigerant and drain piping and wiring for remote controller (unnecessary for wireless type). Refer to each piping or wiring section.
- After making an opening in the ceiling, it may be necessary to reinforce ceiling beams to keep the ceiling level and to prevent it from vibrating. Consult the builder for details.

### 3 Install the suspension bolts. (Use either a M8~M10 size bolt.)

Use anchors for existing ceilings, and a sunken insert, sunken anchors or other field supplied parts for new ceilings to reinforce the ceiling in order to bear the weight of the unit. Adjust clearance from the ceiling before proceeding further.

Installation example (See figure 4)

- 1 Ceiling slab
- 2 Anchor
- 3 Long nut or turn-buckle
- 4 Suspension bolt
- 5 False ceiling

#### NOTE



- All the above parts are field supplied.
- For other installation than standard installation, contact your dealer for details.

## Indoor unit installation

When installing optional accessories (except for the decoration panel), read also the installation manual of the optional accessories. Depending on the field conditions, it may be easier to install optional accessories before the indoor unit is installed. However, for existing ceilings, always install fresh air intake kit before installing the unit.

### 1 Install the unit in the ceiling opening.

- Attach the hanger bracket to the suspension bolt. Be sure to fix it securely by using a nut and washer from the upper and lower sides of the hanger bracket.
- Securing the hanger bracket (See figure 5)

- 1 Nut (field supply)
- 2 Washer (supplied with the unit)
- 3 Hanger bracket
- 4 Double nut (field supply, tighten)

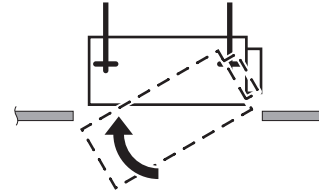

### 2 Fix the paper pattern for installation. (For new ceilings only.)

- The paper pattern for installation corresponds with the measurements of the ceiling opening. Consult the builder for details.
- The centre of the ceiling opening is indicated on the paper pattern for installation. The centre of the unit is indicated on the unit casing.
- The printing pattern can be rotated by 90° to be able to indicate the correct dimensions on all 4 sides.
- After cutting of the printing pattern for installation from packing, attach the paper pattern for installation to the unit with the attached screws as shown in figure 7.

- 1 Paper pattern for installation
- 2 Screws (supplied with the unit)
- 3 Centre of the ceiling opening

### 3 Adjust the unit to the right position for installation.

(See "Preparations before installation" on page 3.)

### 4 Check if the unit is horizontally levelled.

- Do not install the unit tilted. The indoor unit is equipped with a built-in drain pump and float switch. (If the unit is tilted against the direction of the condensate flow (the drain piping side is raised), the float switch may malfunction and cause water to drip.)
- Check if the unit is levelled at all four corners with a water level or a water-filled vinyl tube as shown in figure 11.

- 1 Water level
- 2 Vinyl tube

### 5 Remove the paper pattern for installation. (For new ceilings only.)

## Refrigerant piping work

For refrigerant piping of outdoor unit, refer to the installation manual supplied with the outdoor unit.

Execute heat insulation work completely on both sides of the gas piping and liquid piping. Otherwise, this can sometimes result in water leakage.

Before rigging tubes, check which type of refrigerant is used.



Installation shall be done by a licensed refrigeration technician, the choice of materials and installation shall comply with the applicable national and international codes. In Europe, EN378 is the applicable standard that shall be used.

- Use a pipe cutter and flare suitable for R410A refrigerant.
- To prevent dust, moisture or other foreign matter from infiltrating the tube, either pinch the end, or cover it with tape.
- The outdoor unit is charged with refrigerant.
- To prevent water leakage, execute heat insulation work completely on both sides of the gas and liquid piping. When using a heat pump, the temperature of the gas piping can reach up to approximately 120°C, use insulation which is sufficiently heat resistant.
- Be sure to use both a spanner and torque wrench together when connecting or disconnecting pipes to/from the unit.

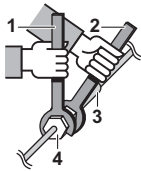

- 1 Torque wrench
- 2 Spanner
- 3 Piping union
- 4 Flare nut

- Do not mix anything other than the specified refrigerant, such as air, etc. inside the refrigerant circuit.
- Only use annealed material for flare connections.
- Refer to Table 1 for the dimensions of flare nut spaces and the appropriate tightening torque. (Overtightening may damage the flare and cause leaks.)

Table 1

Pipe gauge	Tightening torque	Flare dimension A (mm)	Flare shape
Ø6.4	15~17 N·m	8.7~9.1	
Ø9.5	33~39 N·m	12.8~13.2	
Ø12.7	50~60 N·m	16.2~16.6	

- When connecting the flare nut, coat the flare inner surface with ether oil or ester oil and initially tighten 3 or 4 turns by hand before tightening firmly.



- If the refrigerant gas leaks during the work, ventilate the area. A toxic gas is emitted by the refrigerant gas being exposed to a fire.
- Make sure there is no refrigerant gas leak. A toxic gas may be released by the refrigerant gas leaking indoors and being exposed to flames from an area heater, cooking stove, etc.

- Finally, insulate as shown in the figure below (use the supplied accessory parts)

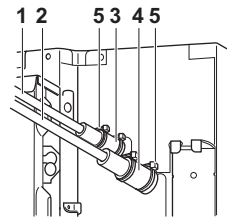

- 1 Liquid pipe
- 2 Gas pipe
- 3 Insulation for fitting for liquid pipe
- 4 Insulation for fitting for gas pipe
- 5 Clamps (use 2 clamps per insulation)

### Piping insulation procedure

#### Gas piping

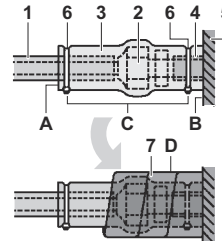

#### Liquid piping

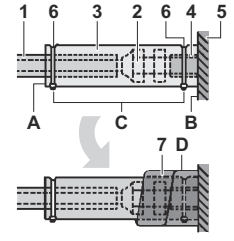

- 1 Piping insulation material (field supply)
  - 2 Flare nut connection
  - 3 Insulation for fitting (delivered with the unit)
  - 4 Piping insulation material (main unit)
  - 5 Main unit
  - 6 Clamp (field supply)
  - 7 Medium 1 sealing pad for gas piping (delivered with the unit)  
Medium 2 sealing pad for liquid piping (delivered with the unit)
- A Turn seams up  
B Attach to base  
C Tighten the part other than the piping insulation material  
D Wrap over from the base of the unit to the top of the flare nut connection



- For local insulation, be sure to insulate local piping all the way into the pipe connections inside the unit. Exposed piping may cause condensation or may cause burns when touched.
- Make sure that no oil remains on plastic parts of the decoration panel (optional equipment). Oil may cause degradation and damage to plastic parts.

## Cautions for brazing

- Be sure to carry out a nitrogen blow when brazing. Brazing without carrying out nitrogen replacement or releasing nitrogen into the piping will create large quantities of oxidized film on the inside of the pipes, adversely affecting valves and compressors in the refrigerating system and preventing normal operation.
- When brazing while inserting nitrogen into the piping, nitrogen must be set to 0.02 MPa with a pressure-reducing valve (=just enough so that it can be felt on the skin).

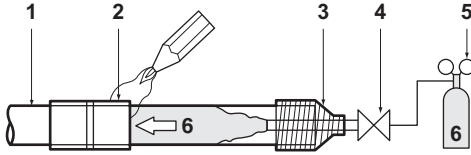

- Refrigerant piping
- Part to be brazed
- Taping
- Hands valve
- Pressure-reducing valve
- Nitrogen

- After the testing of drain piping is finished, attach the drain sealing pad (4) supplied with the unit over the uncovered part of the drain socket (= between drain hose and unit body).

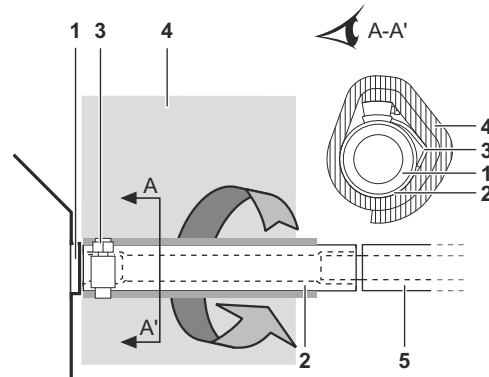

- Drain socket (attached to the unit)
- Drain hose (supplied with the unit)
- Metal clamp (supplied with the unit)  
NOTE: Bend the tip of the metal clamp without tearing the sealing.
- Large sealing pad (supplied with the unit)
- Drain piping (field supply)

## Drain piping work

### Installation of drain piping

Install the drain piping as shown in the figure and take measures against condensation. Improperly rigged piping could lead to leaks and eventually wet furniture and belongings.

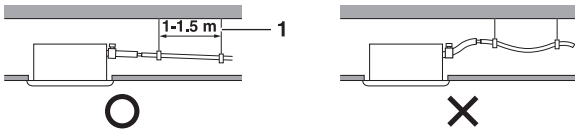

- Hanging bar

- Install the drain pipes.
  - Keep piping as short as possible and slope it downwards at a gradient of at least 1/100 so that air may not remain trapped inside the pipe.
  - Keep pipe size equal to or greater than that of the connecting pipe (vinyl pipe of 20 mm nominal diameter and 26 mm outer diameter).
  - Push the supplied drain hose as far as possible over the drain socket.

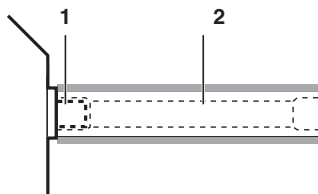

- Drain socket (attached to the unit)
- Drain hose (supplied with the unit)

- Tighten the metal clamp as indicated in the illustration.

- Wrap the supplied large sealing pad over the metal clamp and drain hose to insulate and fix it with clamps.
- Insulate the complete drain piping inside the building (field supply).
- If the drain hose cannot be sufficiently set on a slope, fit the hose with drain raising piping (field supply).

- How to perform piping (See figure 6)

- Ceiling slab
- Hanger bracket
- Adjustable range
- Drain raising pipe (nominal diameter of vinyl pipe = 25 mm)
- Drain hose (supplied with the unit)
- Metal clamp (supplied with the unit)

- Connect the drain hose to the drain raising pipes, and insulate them.
- Connect the drain hose to the drain outlet on the indoor unit, and tighten it with the clamp.

- Precautions

- Install the drain raising pipes at a height of less than H2.
- Install the drain raising pipes at a right angle to the indoor unit and no more than 300 mm from the unit.
- To prevent air bubbles, install the drain hose level or slightly tilted up ( $\leq 75$  mm).
- Drain pump mounted in this unit is high lift type. Characteristic of this pump is that the higher pump is the lower drainage sound becomes. Therefore drain pump height of 300mm is recommended.

Decoration panel	H2
BYFQ60C	645 mm
BYFQ60B	630 mm

**NOTE** The incline of attached drain hose should be 75 mm or less so that the drain socket does not have to withstand additional force.

To ensure a downward slope of 1:100, install hanging bars every 1 to 1.5 m.

When unifying multiple drain pipes, install the pipes as shown in figure 8. Select converging drain pipes whose gauge is suitable for the operating capacity of the unit.

- T-joint converging drain pipes



## Testing of drain piping

After the piping work is finished, check if drainage flows smoothly.

- Add approximately 1 l of water gradually through the air discharge outlet.

Method of adding water (See figure 10)

- 1 Plastic watering can (tube should be about 100 mm long)
- 2 Service drain outlet (with rubber plug) (Use this outlet to drain water from the drain pan)
- 3 Drain pump location
- 4 Drain pipe
- 5 Drain socket (water flow view point)

- Check the drainage flow.

- In case electric wiring work is finished

Check drainage flow during COOL running, explained in "Test operation" on page 9.

- In case electric wiring work is not finished

- Remove the control box lid by means of two screws. Connect the single-phase power supply (50 Hz, 230 V) to connections No. 1 and No. 2 on the inter unit wiring terminal block and connect the ground wire firmly (see figure 9).
- Reattach the control box lid and turn on the power.
- Do not touch the drain pump. It may result in electric shock.

- 1 Control box lid
- 2 Inter unit wiring
- 3 Earth cable
- 4 Terminal block for power supply
- 5 Clamp
- 6 Transmission wiring
- 7 Terminal board for transmission wiring
- 8 Opening for cables
- 9 Wiring diagram label (on the back side of the control box lid)
- 10 Remote controller wiring

Terminal block for power supply (4)

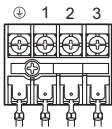

- Confirm the drain operation looking at the drain socket.
- After checking the drainage flow, turn off power, remove the control box lid and disconnect the single phase power supply from the inter unit wiring terminal block again. Attach the control box lid as before.

## Electric wiring work

### General instructions

- All field wiring and components must be installed by a licensed electrician and must comply with relevant European and national regulations.
- Use copper wire only.
- Follow the 'Wiring diagram' attached to the unit body to wire the outdoor unit, indoor units and the remote controller. For details on hooking up the remote controller, refer to the "Installation manual of the remote controller".
- All wiring must be performed by an authorized electrician.
- A main switch or other means for disconnection, having a contact separation in all poles, must be incorporated in the fixed wiring in accordance with relevant local and national legislation. Note that the operation will restart automatically if the main power supply is turned off and then turned back on again.
- Refer to the installation manual attached to the outdoor unit for the size of power supply electric wire connected to the outdoor unit, the capacity of the earth leakage circuit breaker and fuse, and wiring instructions.
- Be sure to ground the air conditioner.
- Do not connect the ground wire to:
  - gas pipes: might cause explosions or fire if gas leaks.
  - telephone ground wires or lightning rods: might cause abnormally high electric potential in the ground during lightning storms.
  - plumbing pipes: no grounding effect if hard vinyl piping is used.
- Be sure that the shape of the power supply cable and any other cable, before entering unit, should be as shown in this figure.

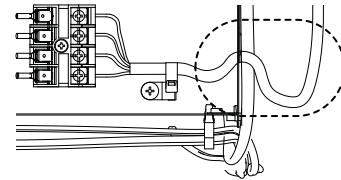

### Electrical characteristics

**NOTE** For details, refer to "Electrical data".



### Specifications for field wire

	Wire	Size (mm <sup>2</sup> )	Length
Between indoor units	H05VV-U4G <sup>(1),(2)</sup>	2,5	—
Unit-Remote controller	Sheathed wire (2 wire) <sup>(3)</sup>	0.75-1.25	≤500 m <sup>(4)</sup>

- (1) Shows only in case of protected pipes. Use H07RN-F in case of no protection.
- (2) Run transmission wiring between the indoor and outdoor units through a conduit to protect against external forces, and feed the conduit through the wall together with refrigerant piping.
- (3) Use double insulation wire for remote controller (sheath thickness: ≥1 mm) or run wires through a wall or conduit so that the user cannot come in contact with them.
- (4) This length is the total maximum extended length in the system in case of group control.

# Wiring example and how to set the remote controller

## How to connect wiring (See figure 9)

- **Inter unit wiring**  
Remove the control box lid (1) and connect the inter unit wiring terminal block inside with the matching numbers and connect the ground wire to the grounding terminal. While doing this, pull the wires inside through the hole in the control box lid and clamp the wires as indicated in the figure.
- **Remote controller wiring**  
Remove the control box lid (1) and pull the wires inside through the hole in the control box lid and connect to the remote controller wiring terminal block. Securely fix the wiring using a clamp as indicated in the figure.
- **After connection**  
Attach the small sealing (supplied with the unit) around the cables to prevent infiltrating of water from the outside into the unit. If two or more cables are used, divide the small sealing into the required number of pieces and wrap them around all the cables.
- **Attach the control box lid**
  - 1 Control box lid
  - 2 Inter unit wiring
  - 3 Earth cable
  - 4 Terminal block for power supply
  - 5 Clamp (field supply)
  - 6 Remote controller wiring
  - 7 Remote controller wiring terminal block
  - 8 Opening for cables
  - 9 Wiring diagram label (on the back side of the control box lid)

### Precautions

- 1 Observe the notes mentioned below when wiring to the power supply terminal board.
  - Use a round crimp-style terminal for insulation sleeve for connection to the terminal block for wiring the units. When none are available, follow the instructions below.



- Do not connect wires of different gauge to the same power supply terminal. (Looseness in the connection may cause overheating.)
- When clamping wiring, use the clamps (delivered with the unit) to prevent outside pressure being exerted on the wiring connections. Tie up firmly. When doing the wiring, make sure the wiring is neat and does not cause the control box to stick up. Close the cover firmly.
- When connecting wires of the same gauge, connect them according to the figure.



Use the specified electric wire. Connect the wire securely to the terminal. Lock the wire down without applying excessive force to the terminal. Use torques according to the table below.

Tightening torque (N·m)	
Terminal block for remote controller	0.79~0.97
Terminal block for wiring the units	1.18~1.44

- When attaching the control box lid, make sure not to pinch any wires.
- After all wiring connections are done, fill in any gaps in the casing wiring holes with putty or insulation material (field supply) thus to prevent small animals or dirt from entering the unit from outside and causing short circuits in the control box.

- 2 Keep total current of crossover wiring between indoor units less than 12 A. Branch the line outside the terminal block of the unit in accordance with electrical equipment standards, when using two power wiring of a gauge greater than 2 mm<sup>2</sup> (Ø1.6).  
The branch must be sheathed in order to provide an equal or greater degree of insulation as power supply wiring itself.
- 3 Do not connect wires of different gauge to the same grounding terminal. Looseness in the connection may deteriorate the protection.
- 4 Remote controller wiring should be located at least 50 mm away from inter unit wiring and other wiring. Not following this guideline may result in malfunction due to electrical noise.
- 5 For the remote controller wiring, refer to the "Installation manual of the remote controller" supplied with the remote controller.

**NOTE** The customer has the ability to select the remote controller thermistor.

- 6 Never connect the inter unit wiring to the remote controller wiring. This mistake could damage the entire system.
- 7 Use only specified wires and tightly connect wires to the terminals. Be careful that wires do not place external stress on the terminals. Keep wiring in neat order so that they do not obstruct other equipment such as popping open the service cover. Make sure the cover closes tight. Incomplete connections could result in overheating, and in the worst case, electric shock or fire.

## Wiring example

For the wiring of outdoor units, refer to the installation manual attached to the outdoor units.

Confirm the system type:

- Pair type or multi system: 1 remote controller controls 1 indoor unit (standard system).
- Simultaneous operation system: 1 remote controller controls 2 indoor units (2 indoor units operate equally)
- Group control: 1 remote controller controls up to 16 indoor units (All indoor units operate according to the remote controller).
- 2 remote controller control: 2 remote controllers control 1 indoor unit.

---

Pair type or multi system (See figure 12)

---



---

Simultaneous operation system (See figure 13)

---



---

Group control (See figure 14)

---



---

2 remote controller control (See figure 15)

---

- |   |  |
|---|--|
| 1 | Main power supply                        |
| 2 | Main switch                              |
| 3 | Fuse                                     |
| 4 | Remote controller (optional accessories) |
| 5 | Indoor unit (Master)                     |
| 6 | Indoor unit (Slave)                      |

**NOTE**  It is not necessary to designate indoor unit address when using group control. The address is automatically set when the power is activated.

### Precautions

- 1 All transmission wiring except for the remote controller wiring is polarized and must match the terminal symbol.
- 2 In case of group control, perform the remote controller wiring to the master unit when connecting to the simultaneous operation system (wiring to the slave unit is unnecessary).
- 3 For group control remote controller, choose the remote controller that suits the indoor unit which has the most functions (as attached swing flap).
- 4 When controlling the simultaneous operation system with 2 remote controllers, connect it to the master unit (wiring to the slave unit is unnecessary).
- 5 Be sure to connect the wiring to the master unit when combining with a simultaneous operating multi-type in group control.
- 6 Do not ground the equipment on gas pipes, water pipes, lightning rods or crossground with telephones. Improper grounding could result in electric shock.

## Installation of the decoration panel

Refer to the installation manual delivered with the decoration panel.

After installing the decoration panel, ensure that there is no space between the unit body and decoration panel. Otherwise air may leak through the gap and cause dew drop.

## Field setting

Field setting must be made from the remote controller in accordance with the installation condition.

- Setting can be made by changing the "Mode No.", "First code No." and "Second code No."
- For setting and operation, refer to "Field setting" in the installation manual of the remote controller.

### Setting ceiling height

Adjust the Second code No. according to the table below so that it corresponds to the ceiling height of your installation. (Second code No. is factory set to "01")

Ceiling height (m)	Mode No.	First code No.	Second code No.
≤2.7	N	13 (23)	0
>2.7 or ≤3.0	H	13 (23)	0
>3.0 or ≤3.5	S	13 (23)	0

The figure of ceiling height is for air discharge in all directions.

### Setting air discharge direction

For changing air discharge direction (3 or 4 directions), refer to the option handbook of the optional blocking pad kit. (Second code No. is factory set to "01" for all-round air discharge)

### Setting air volume when thermostat control is OFF

Before setting thermostat control, consult with the customer regarding whether that is responding to their environment. (Second code No. is "02" at cooling thermostat OFF and others are "01" as factory setting.)

Setting		Mode <sup>(1)</sup> No.	First code No.	Second code No.
Fan stops at thermostat OFF (cooling/heating)	Normal	11(21)	2	01
	Stop			02
Air volume at cooling thermostat OFF	LL	12(22)	6	01
	Setup volume			02
Air volume at heating thermostat OFF	LL	12(22)	3	01
	Setup volume			02

(1) Mode No. setting is done in a batch for the group. To make or confirm settings for an individual unit, set the Mode No. shown in parentheses

### Setting air filter sign

Remote controllers are equipped with liquid crystal air filter signs to display the time to clean the air filter.

Change the Second code No. Depending on the amount of dirt or dust in the room. (Second code No. is factory set to "01" for air filter contamination-light)

Air filter contamination

Setting	Display interval	Mode No.	First code No.	Second code No.
Light	±2500 hrs	10 (20)	0	01
Heavy	±1250 hrs	10 (20)	0	02
No display	—	10 (20)	3	02

When using wireless remote controllers it is necessary to use address setting. Refer to the installation manual attached to the wireless remote controller for the setting instructions.

## Setting indoor unit number of simultaneous operation system

When using in simultaneous operation system mode, change the Second code No. as shown in the table. (Second code No. is factory set to "01" for 1 connected unit.)

Setting	Mode No.	First code No.	Second code No.
Pair system (1 unit)	11 (21)	0	01
Simultaneous operation system (2 unit)			02
Simultaneous operation system (3 unit)			03
Simultaneous operation system (4 unit)			04

When using in simultaneous operation system mode, refer to "Simultaneous operation system individual setting" on page 9 to set master and slave units separately.

### When using wireless remote controllers

When using wireless remote controllers, wireless remote controller address setting is necessary. Refer to the installation manual attached to the wireless remote controller for setting instructions.

## Simultaneous operation system individual setting

It is easier if the optional remote controller is used when setting the slave unit.

Perform the following procedures when setting the master and slave unit separately.

### Procedure (See figure 16)

- 1 Main power supply
  - 2 Main switch
  - 3 Fuse
  - 4 Remote controller (optional accessories)
  - 5 Indoor unit (Master)
  - 6 Indoor unit (Slave)
- 1 Change the Second code No. to "02", individual setting, so that the slave unit can be individually set. (Second code No. is factory set to "01", unified setting.)

Setting	Mode No.	First code No.	Second code No.
Unified setting	11 (21)	1	01
Individual setting			02

- 2 Perform field setting for the master unit.
- 3 Turn off the main power supply switch after (2).
- 4 Detach remote controller from the master unit and connect it to the slave unit.
- 5 Turn on the main power supply switch again, and as in (1), change the Second code No. to "02", individual setting.
- 6 Perform field setting for the slave unit.
- 7 Turn off the main power supply switch after (6).  
In case there are 2 or more slave units, repeat steps (4) to (7) for all slave units.
- 8 Detach the remote controller from the slave unit after the setting, and reattach to the master unit. This is the end of the setting procedure.



You do not need to rewire the remote controller from the master unit if the optional remote controller for slave unit is used. (However, remove the wires attached to the remote controller terminal board of the master unit.)

## Test operation

Refer to "For the following items, take special care during construction and check after installation is finished" on page 2.

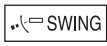

After finishing the construction of refrigerant piping, drain piping, and electric wiring, conduct test operation accordingly to protect the unit.

### Test operation after installing decoration panel

- 1 Open the gas side stop valve.
- 2 Open the liquid side stop valve.
- 3 Electrify crank case heater for 6 hours.
- 4 Set to cooling operation with the remote controller and start operation by pushing ON/OFF button.
- 5 Press Inspection/Test Operation button  4 times (2 times for wireless remote controller) and operate at Test Operation mode for 3 minutes.
- 6 Push air flow direction adjust button  to make sure the unit is in operation.
- 7 Press Inspection/Test Operation button  and operate normally.
- 8 Confirm function of unit according to the operation manual.

### Test operation before installing decoration panel

**NOTE** Do not touch the drain pump, this may cause electrical shock.

- 1 Open the gas side stop valve.
- 2 Open the liquid side stop valve.
- 3 Electrify crank case heater for 6 hours.
- 4 Set to cooling operation with the wired remote controller and start operation by pushing ON/OFF button.
- 5 Press Inspection/Test Operation button  4 times and operate at Test Operation mode for 3 minutes.
- 6 Press Inspection/Test Operation button  and operate normally.
- 7 Confirm function of unit according to the operation manual.
- 8 Turn off the main power supply after operation.

### Precautions

- 1 In case something is wrong with the unit and it does not operate, refer to the installation manual attached to the outdoor unit or contact your dealer.
- 2 Refer to the installation manual attached to the outdoor unit in case of Individual Operation System type.
- 3 Conduct test operation after installing decoration panel if the wireless remote controller is used.

# Wiring diagram

## Indoor unit

A1P	Printed circuit board
C105	Capacitor (M1F)
DS1	Dip switch on PCB
F1U	Fuse (F, 5 A, 250 V)
HAP	Flashing lamp (service monitor green)
K2R	Magnetic relay
M1F	Fan motor
M1P	Drain pump motor
M1S-M4S	Swing motor
R1T	Thermistor (air)
R2T,R3T	Thermistor (coil)
S1L	Float switch
V1R	Diode bridge
X1M	Terminal block
X2M	Terminal block
Z1F	Noise filter
Z1C	Ferrite core
Z2C	Ferrite core
PS	Switching power supply
RC	Receiver
TC	Transmitter

## Wireless remote controller (receiver/display unit)

A2P	Printed circuit board
A3P	Printed circuit board
BS1	Push button switch on PCB
H1P	Pilot lamp (on-red)
H2P	Pilot lamp (timer-green)
H3P	Pilot lamp (filter sign-green)
H4P	Pilot lamp (defrost-orange)
SS1	Selector switch (main/sub)
SS2	Selector switch (wireless address set)

## Sensor kit

A4P	Printed circuit board
A5P	Printed circuit board



## Wired remote controller

R4T	Thermistor (air)
-----	------------------

## Connector for optional parts

X24A	Connector (wiring remote controller)
X33A	Connector (adaptor for wiring)
X35A	Connector (power supply for adaptor)
X81A	Connector (sensor kit)

## Notes

1  : Terminal       : Connector       : Field wiring

2 In case of using a central remote controller, connect it to the unit in accordance with the attached installation manual.

3 X2A, X8A, X33A, X35A, X36A are connected when the optional accessories are being used.  
In case of using a self cleaning decoration panel, see the wiring diagram of the self cleaning decoration panel.

4 Connect power of ADAPTOR FOR WIRING to terminal block (X2M) of indoor unit directly.

5 In case of main/sub change-over, see the installation manual supplied with the remote controller.

6 Colour legend

BLK	: Black	BLU	: Blue	BRN	: Brown
GRN	: Green	GRY	: Gray	ORG	: Orange
PNK	: Pink	RED	: Red	WHT	: White
YLW	: Yellow				

In case of simultaneous operation system : In case of simultaneous operation system

Indoor unit (Master)/(Slave) : Indoor unit (Master)/(Slave)

To outdoor unit : To outdoor unit

Remote controller : Remote controller

Control box : Control box

Receiver/display unit : Receiver/display unit

Central remote controller : Central remote controller

Wired remote controller : Wired remote controller

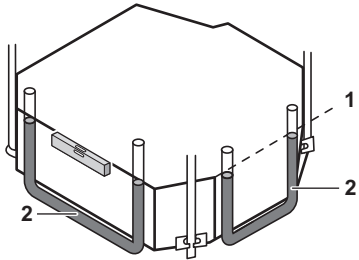

11

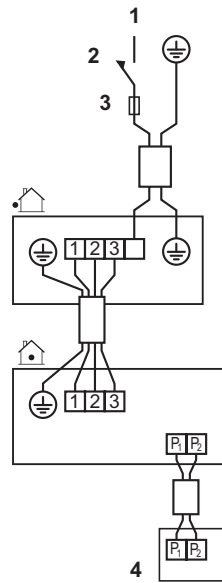

12

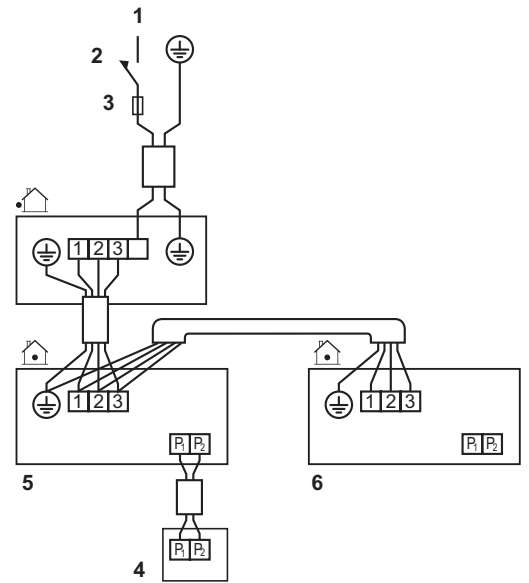

13

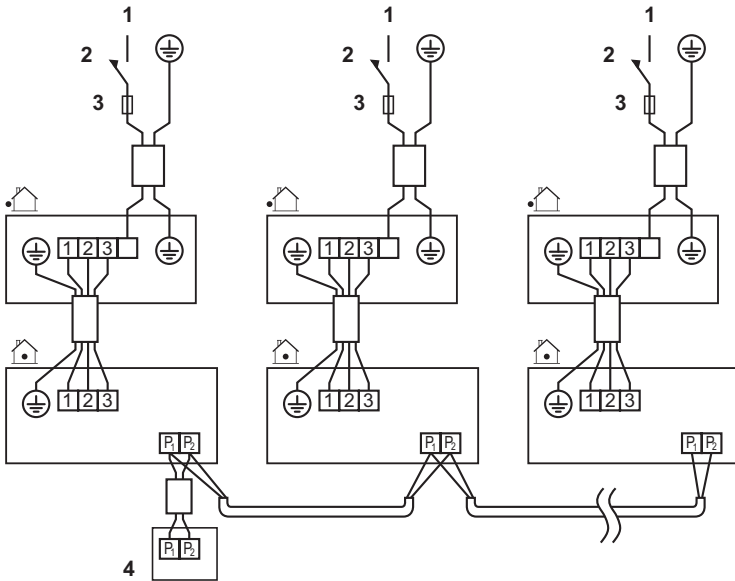

14

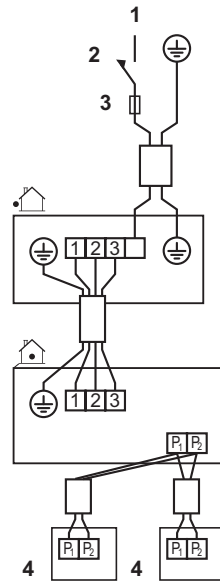

15

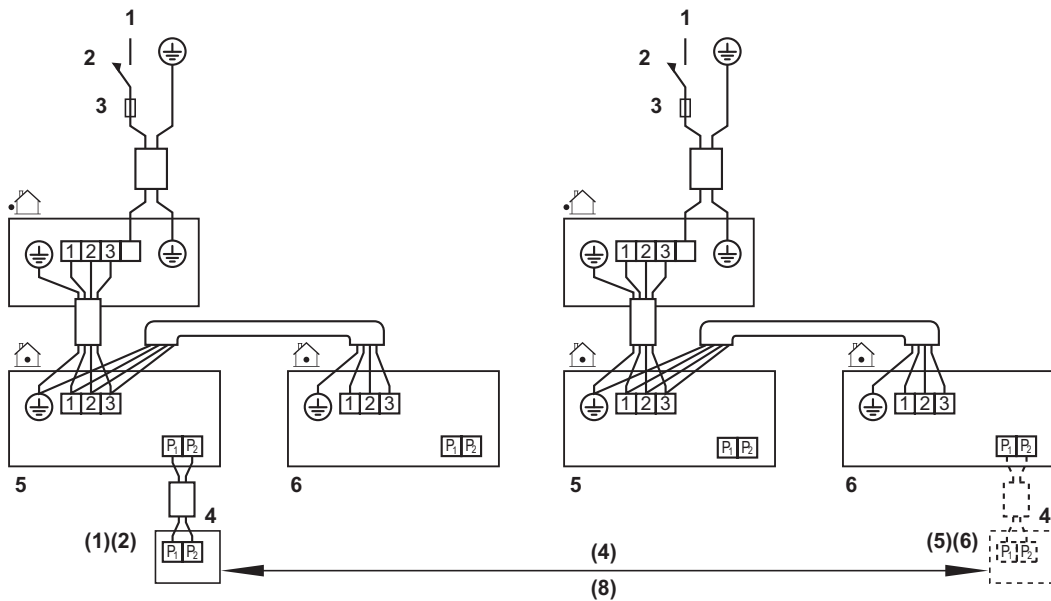

16

**DAIKIN INDUSTRIES CZECH REPUBLIC s.r.o.**

U Nové Hospody 1/1155, 301 00 Plzeň Skvrňany, Czech Republic

**DAIKIN EUROPE N.V.**

Zandvoordestraat 300, B-8400 Oostende, Belgium

Copyright 2013 Daikin



4P341094-1E 2015.06