



# INSTALLATION MANUAL

## Split System air conditioners

Installation manual  
Split System air conditioners

English

<b>FHC35B7V1</b>	<b>FHYC35B7V1</b>
<b>FHC45B7V1</b>	<b>FHYC45B7V1</b>
<b>FHC60B7V1</b>	<b>FHYC60B7V1</b>
	<b>FHYC71B7V1</b>
	<b>FHYC100B7V1</b>
	<b>FHYC125B7V1</b>



<b>FHC35BZ7V1</b>	<b>FHYCP35B7V1</b>
<b>FHC45BZ7V1</b>	<b>FHYCP45B7V1</b>
<b>FHC60BZ7V1</b>	<b>FHYCP60B7V1</b>
	<b>FHYCP71B7V1</b>
<b>FHYC35BZ7V1</b>	<b>FHYCP100B7V1</b>
<b>FHYC45BZ7V1</b>	<b>FHYCP125B7V1</b>

Daikin Europe N.V.

declares under its sole responsibility that the air conditioning models to which this declaration relates:  
erklärt auf seine alleinige Verantwortung daß die Modelle der Klimageräte für die diese Erklärung bestimmt ist:  
déclare sous sa seule responsabilité que les appareils d'air conditionné visés par la présente déclaration:

verklaart hierbij op eigen exclusieve verantwoordelijkheid dat de airconditioning units waarop deze verklaring betrekking heeft:  
declara baja su única responsabilidad que los modelos de aire acondicionado a los cuales hace referencia la declaración:  
dichiara sotto sua responsabilità che i condizionatori modello a cui è riferita questa dichiarazione:

δηλώνει με α αποκλειστική της ευθύνη ότι τα μοντέλα των κλιματιστικών συσκευών στα ο οία αναφέρεται η αρούσα δήλωση:  
declara sob sua exclusiva responsabilidade que os modelos de ar condicionado a que esta declaração se refere:  
erklærer under eneansvar, at klimaanlægmodellerne, som denne deklaration vedrører:

deklarerer i egenskap av huvudansvarig, att luftkonditioneringsmodellerna som berörs av denna deklaration innebär att:  
erklærer et fullstendig ansvar for at de luftkondisjoneringsmodeller som berøres av denne deklarasjon innebærer at:  
ilmoittaa yksinomaan omalla vastuullaan, että tämän ilmoituksen tarkoitamat ilmastointilaitteiden mallit:

FHC35B7V1, FHC45B7V1, FHC60B7V1,  
FHYC35B7V1, FHYC45B7V1, FHYC60B7V1, FHYC71B7V1, FHYC100B7V1, FHYC125B7V1,  
FHC35BZ7V1, FHC45BZ7V1, FHC60BZ7V1, FHYC35BZ7V1, FHYC45BZ7V1,  
FHYCP35B7V1, FHYCP45B7V1, FHYCP60B7V1, FHYCP71B7V1, FHYCP100B7V1, FHYCP125B7V1,

are in conformity with the following standard(s) or other normative document(s), provided that these are used in accordance with our instructions:  
der/den folgenden Norm(en) oder einem anderen Normdokument oder -dokumenten entspricht/entsprechen, unter der Voraussetzung, daß sie gemäß unseren Anweisungen eingesetzt werden:  
sont conformes à la/aux norme(s) ou autre(s) document(s) normatif(s), pour autant qu'ils soient utilisés conformément à nos instructions:

conform de volgende norm(en) of één of meer andere bindende documenten zijn, op voorwaarde dat ze worden gebruikt overeenkomstig onze instructies:  
están en conformidad con la(s) siguiente(s) norma(s) u otro(s) documento(s) normativo(s), siempre que sean utilizados de acuerdo con nuestras instrucciones:  
sono conformi al(i) seguente(i) standard(s) o altro(i) documento(i) a carattere normativo, a patto che vengano usati in conformità alle nostre istruzioni:

είναι σύμφωνα με το(α) ακόλουθο(α) ρότυ ο(α) ή άλλο έγγραφο(α) κανονισμών, υ ό την ρού όθεση όπι χρησημο οιούνται σύμφωνα με τις οδηγίες μας:  
estão em conformidade com a(s) seguinte(s) norma(s) ou outro(s) documento(s) normativo(s), desde que estes sejam utilizados de acordo com as nossas instruções:  
overholder følgende standard(er) eller andet/andre retningsgivende dokument(er), forudsat at disse anvendes i henhold til vore instrukser:

respektive utrustning är utförd i överensstämmelse med och följer följande standard(er) eller andra normgivande dokument, under förutsättning att användning sker i överensstämmelse med våra instruktioner :  
respektive utstyr er i overensstemmelse med følgende standard(er) eller andre normgivende dokument(er), under forutsetning av at disse brukes i henhold til våre instrukser:  
vastaavat seuraavien standardien ja muiden ohjeellisten dokumenttien vaatimuksia edellyttäen, että niitä käytetään ohjeidemme mukaisesti:

EN60335-2-40,

following the provisions of:  
gemäß den Vorschriften der:  
conformément aux stipulations des:

overeenkomstig de bepalingen van:  
siguiendo las disposiciones de:  
secondo le prescrizioni per:

με τήρηση των διατάξεων των:  
de acordo com o previsto em:  
under iagttagelse af bestemmelserne i:

enligt villkoren i:  
gitt i henhold til bestemmelsene i:  
noudattaa määräyksiä:

Low Voltage 73/23/EEC  
Machinery Safety 89/392/EEC  
Electromagnetic Compatibility 89/336/EEC \*

Directives, as amended.  
Direktiven, gemäß Änderung.  
Directives, telles que modifiées.

Richtlijnen, zoals geamendeerd.  
Directivas, según lo enmendado.  
Direttive, come da modifica.

✓δηγιών, ό ως έχουν τρο ο οηθεί.  
Directivas, conforme alteração em.  
Direktiver, med senere ændringer.

Direktiv, med företagna ändringar.  
Direktiver, med foretatte endringer.  
Direktiivellä, sellaisina kuin ne ovat muutettuina.

* Note	as set out in the Technical Construction File <b>DAIKIN.TCF.004 / DAIKIN.TCF.016</b> and judged positively by <b>KEMA</b> according to the <b>Certificate 59277-KRQ/ECM95-4233 / 81728-KRQ/EMC98-4341</b> .
Hinweis	wie in der Technischen Konstruktionsakte <b>DAIKIN.TCF.004 / DAIKIN.TCF.016</b> aufgeführt und von <b>KEMA</b> positiv ausgezeichnet gemäß <b>Zertifikat 59277-KRQ/ECM95-4233 / 81728-KRQ/EMC98-4341</b> .
Remarque	tel que stipulé dans le Fichier de Construction Technique <b>DAIKIN.TCF.004 / DAIKIN.TCF.016</b> et jugé positivement par <b>KEMA</b> conformément au <b>Certificat 59277-KRQ/ECM95-4233 / 81728-KRQ/EMC98-4341</b> .
Bemerk	zoals vermeld in het Technisch Constructiedossier <b>DAIKIN.TCF.004 / DAIKIN.TCF.016</b> en in orde bevonden door <b>KEMA</b> overeenkomstig <b>Certificaat 59277-KRQ/ECM95-4233 / 81728-KRQ/EMC98-4341</b> .
Nota	tal como se expone en el Archivo de Construcción Técnica <b>DAIKIN.TCF.004 / DAIKIN.TCF.016</b> y juzgado positivamente por <b>KEMA</b> según el <b>Certificado 59277-KRQ/ECM95-4233 / 81728-KRQ/EMC98-4341</b> .
Nota	delineato nel File Tecnico di Costruzione <b>DAIKIN.TCF.004 / DAIKIN.TCF.016</b> e giudicato positivamente da <b>KEMA</b> secondo il <b>Certificato 59277-KRQ/ECM95-4233 / 81728-KRQ/EMC98-4341</b> .
Σημείωση	ό ως ροοδιορίζεται στο «ρχείο Δεχνικής / ατασκευής <b>DAIKIN.TCF.004 / DAIKIN.TCF.016</b> και κρίνεται θετικά α ό το <b>KEMA</b> σύμφωνα με το <b>Πιστο οητικό 59277-KRQ/ECM95-4233 / 81728-KRQ/EMC98-4341</b> .
Nota	tal como estabelecido no Ficheiro Técnico de Construção <b>DAIKIN.TCF.004 / DAIKIN.TCF.016</b> e com o parecer positivo de <b>KEMA</b> de acordo com o <b>Certificado 59277-KRQ/ECM95-4233 / 81728-KRQ/EMC98-4341</b> .
Bemærk	som anført i den Tekniske Konstruktionsfil <b>DAIKIN.TCF.004 / DAIKIN.TCF.016</b> og positivt vurderet af <b>KEMA</b> i henhold til <b>Certifikat 59277-KRQ/ECM95-4233 / 81728-KRQ/EMC98-4341</b> .
Information	utrustningen är utförd i enlighet med den Tekniska Konstruktionsfilen <b>DAIKIN.TCF.004 / DAIKIN.TCF.016</b> som positivt intygats av <b>KEMA</b> vilket också framgår av <b>Certifikat 59277-KRQ/ECM95-4233 / 81728-KRQ/EMC98-4341</b> .
Merk	som det fremkommer i den Tekniske Konstruktionsfilen <b>DAIKIN.TCF.004 / DAIKIN.TCF.016</b> og gennem positiv bedømmelse av <b>KEMA</b> ifølge <b>Sertifikat 59277-KRQ/ECM95-4233 / 81728-KRQ/EMC98-4341</b> .
Huom	jotka on esitetty Teknisessä Asiakirjassa <b>DAIKIN.TCF.004 / DAIKIN.TCF.016</b> ja jotka <b>KEMA</b> on hyväksynyt <b>Sertifikaatin 59277-KRQ/ECM95-4233 / 81728-KRQ/EMC98-4341</b> mukaisesti.



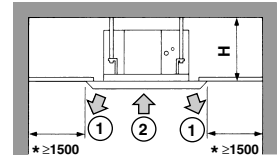
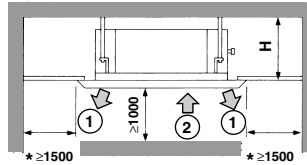
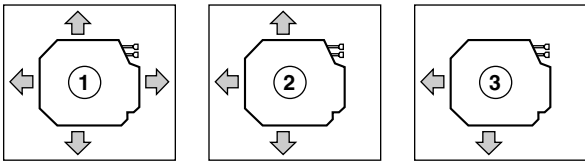

1

2

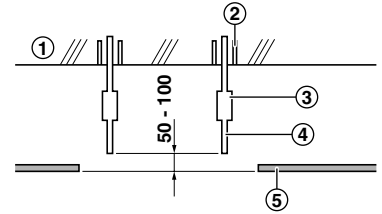
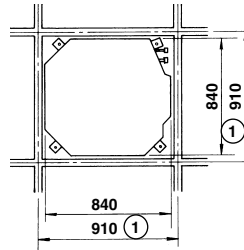
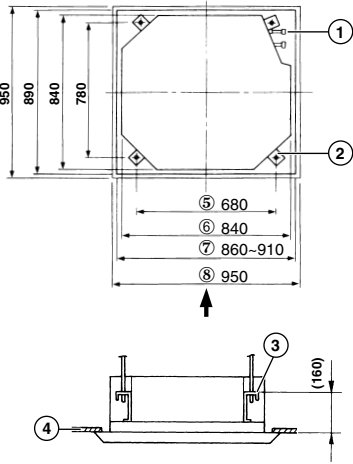

5

3

4

6

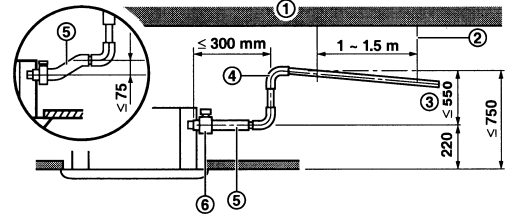
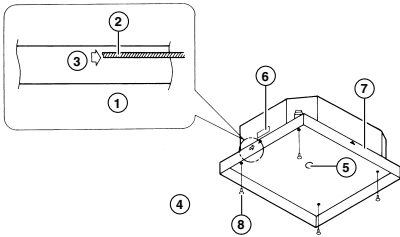
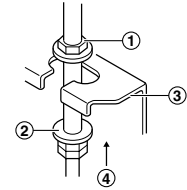
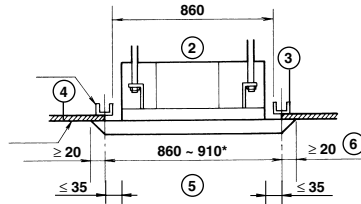

7

8

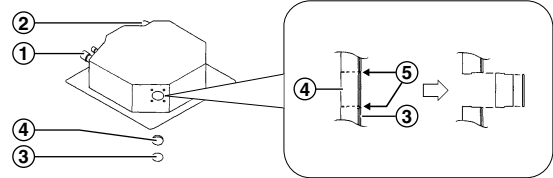
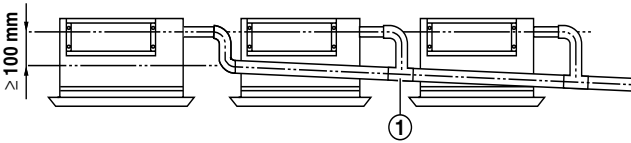

10

9

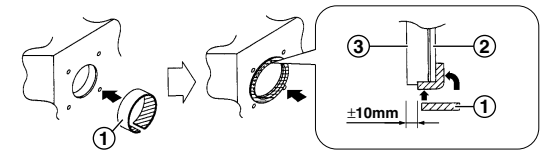

11

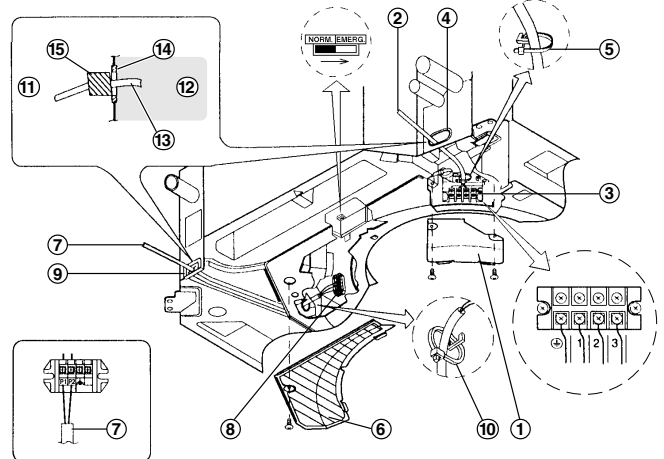
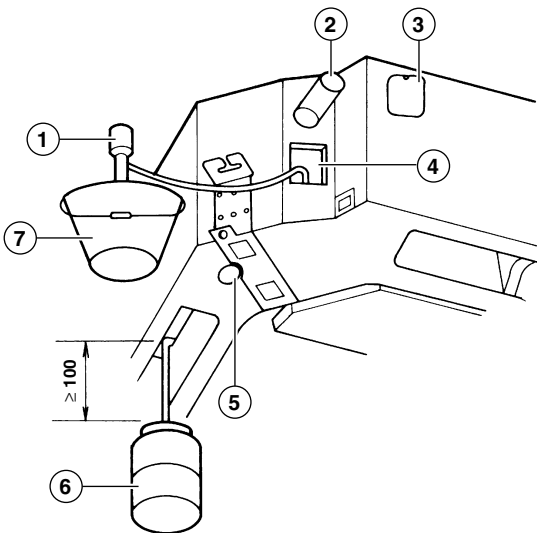

12

13

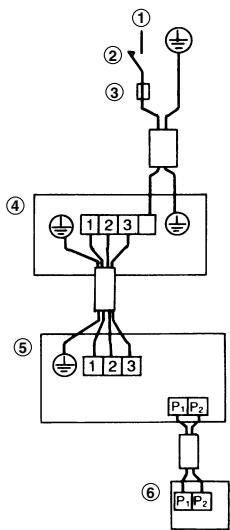

15

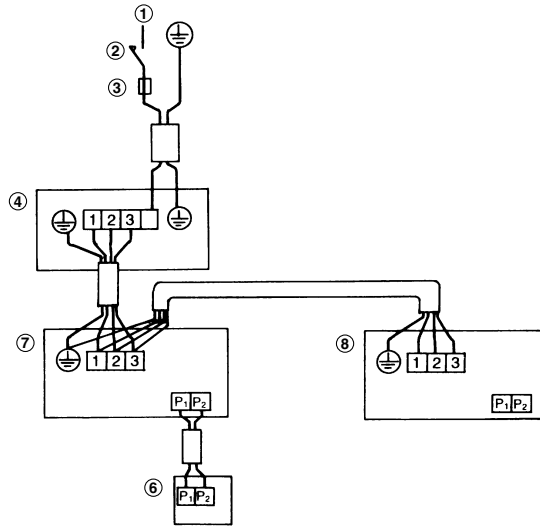

16

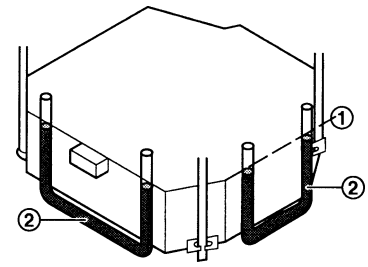

14

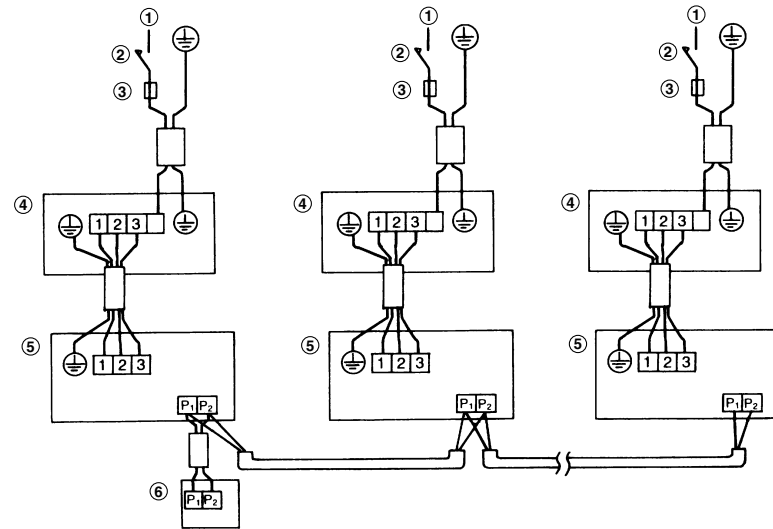

17

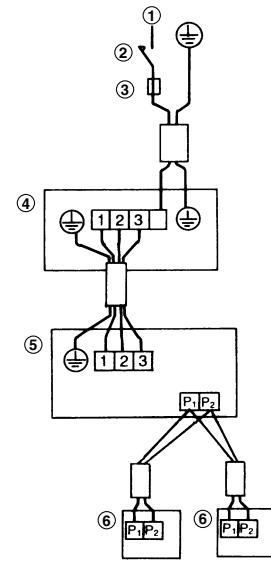

18

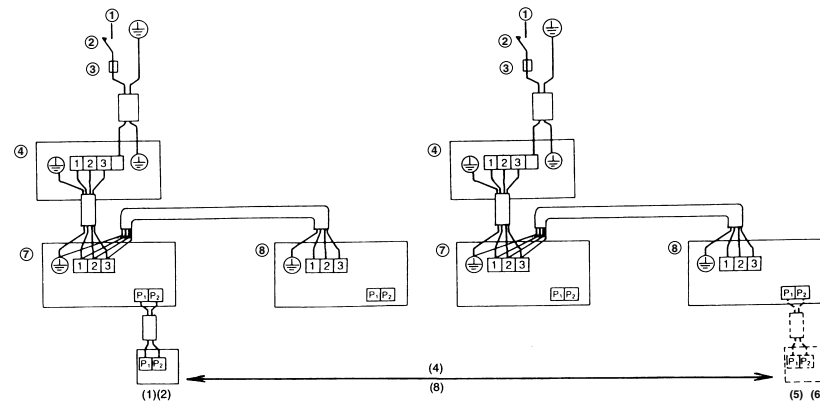

19

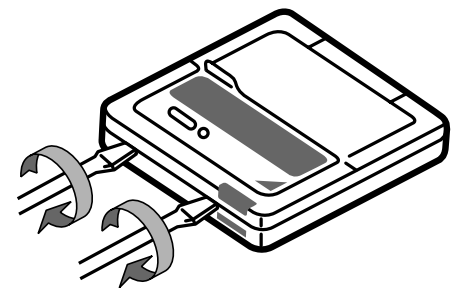

20

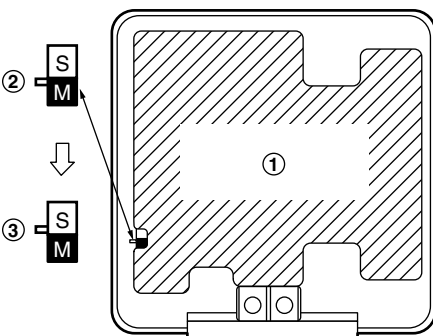

21

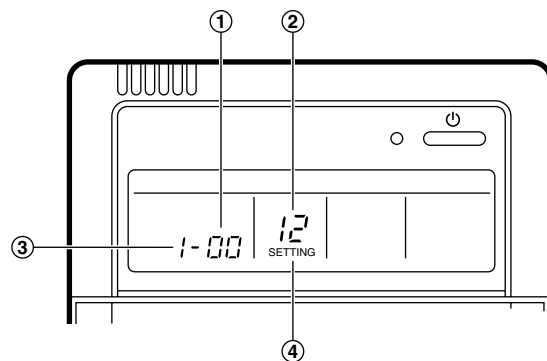

22

	<u>page</u>
Before installation .....	1
Selecting installation site .....	2
Preparations before installation .....	3
Installation procedure for fresh air intake duct connection .....	3
Indoor unit installation .....	3
Refrigerant piping work .....	4
Drain piping work .....	4
Electric wiring work .....	5
Wiring example and how to set the remote controller .....	6
Wiring example .....	6
Field setting .....	7
Installation of the decoration panel .....	8
Test operation .....	8
Wiring diagram .....	9



READ THESE INSTRUCTIONS CAREFULLY BEFORE INSTALLATION. KEEP THIS MANUAL IN A HANDY PLACE FOR FUTURE REFERENCE. IMPROPER INSTALLATION OR ATTACHMENT OF EQUIPMENT OR ACCESSORIES COULD RESULT IN ELECTRIC SHOCK, SHORT-CIRCUIT, LEAKS, FIRE OR OTHER DAMAGE TO THE EQUIPMENT. BE SURE ONLY TO USE ACCESSORIES MADE BY DAIKIN WHICH ARE SPECIFICALLY DESIGNED FOR USE WITH THE EQUIPMENT AND HAVE THEM INSTALLED BY A PROFESSIONAL. IF UNSURE OF INSTALLATION PROCEDURES OR USE, ALWAYS CONTACT YOUR DAIKIN DEALER FOR ADVICE AND INFORMATION.

## BEFORE INSTALLATION







- Leave the unit inside its packaging until you reach the installation site. Where unpacking is unavoidable, use a sling of soft material or protective plates together with a rope when lifting, this to avoid damage or scratches to the unit.
- Refer to the installation manual of the outdoor unit for items not described in this manual.
- Caution concerning refrigerant series R407C:
  - The connectable outdoor units must be designed exclusively for R407C.
  - If outdoor units for R22 are connected, the system will not work properly.

## Precautions

- Do not install or operate the unit in rooms mentioned below.
  - Places with mineral oil, or filled with oil vapour or spray like in kitchens. (Plastic parts may deteriorate.)
  - Where corrosive gas like sulphurous gas exists. (Copper tubing and brazed spots may corrode.)
  - Where volatile flammable gas like thinner or gasoline is used.
  - Where machines generating electromagnetic waves exist. (Control system may malfunction.)
  - Where the air contains high levels of salt such as air near the ocean and where voltage fluctuates a lot (e.g. in factories). Also in vehicles or vessels.
- When selecting the installation site, use the supplied paper pattern for installation.
- Do not install accessories on the casing directly. Drilling holes in the casing may damage electrical wires and consequently cause fire.

## Accessories

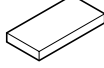
Check if the following accessories are included with your unit.

 Clamp 1 pc.	Also used as packing material  Paper pattern for installation 1 pc.	 Drain hose 1 pc.
 Screws M5 For paper pattern for installation 4 pcs.	 Washer for hanging bracket 8 pcs.	 Sealing 2 pcs.
Insulation for fitting 1 each		Other: installation and operation manual
 for gas pipe	 for liquid pipe	

## Optional accessories

- There are two types of remote controllers: wired and wireless. Select a remote controller according to customers request and install in an appropriate place. Refer to catalogues and technical literature for selecting a suitable remote controller.
- A decoration panel is also required for this indoor unit.

**For the following items, take special care during construction and check after installation is finished**

Tick  when checked

- Is the indoor unit fixed firmly?  
The unit may drop, vibrate or make noise.
- Is the gas leak test finished?  
It may result in insufficient cooling.
- Is the unit fully insulated?  
Condensate water may drip.
- Does drainage flow smoothly?  
Condensate water may drip.
- Does the power supply voltage correspond to that shown on the name plate?  
The unit may malfunction or components may burn out.
- Are wiring and piping correct?  
The unit may malfunction or components may burn out.
- Is the unit safely grounded?  
Dangerous at electric leakage.
- Is the wiring size according to specifications?  
The unit may malfunction or components may burn out.
- Is nothing blocking the air outlet or inlet of either the indoor or outdoor units?  
It may result in insufficient cooling.
- Are refrigerant piping length and additional refrigerant charge noted down?  
The refrigerant charge in the system might not be clear.

**Notes to the installer**

- Read this manual carefully to ensure correct installation. Be sure to instruct the customer how to properly operate the system and show him/her the enclosed operation manual.
- Explain to the customer what system is installed on the site. Be sure to fill out the appropriate installation specifications in the chapter "What to do before operation" of the outdoor unit operation manual.

**SELECTING INSTALLATION SITE**

When the conditions in the ceiling are exceeding 30°C and a relative humidity of 80%, or when fresh air is inducted into the ceiling, an additional insulation is required (minimum 10mm thickness, polyethylene foam).

For this unit you can select different air flow directions. It is necessary to purchase an optional blocking pad kit to discharge the air in 2 or 3 directions.

**1. Select an installation site where the following conditions are fulfilled and that meets your customer's approval.**

- Where optimum air distribution can be ensured.
- Where nothing blocks air passage.
- Where condensate water can be properly drained.
- Where the false ceiling is not noticeably on an incline.
- Where sufficient clearance for maintenance and service can be ensured.
- Where piping between indoor and outdoor units is possible within the allowable limit. (Refer to the installation manual of the outdoor unit.)
- Keep indoor unit, outdoor unit, power supply wiring and transmission wiring at least 1 meter away from televisions and radios. This is to prevent image interference and noise in those electrical appliances.  
(Noise may be generated depending on the conditions under which the electric wave is generated, even if 1 meter is kept.)

**2. Ceiling height**

This indoor unit may installed on ceilings up to 3.5m in height (for 80~125 units: 4.2m). However, it becomes necessary to make field settings using the remote controller when installing the unit at a height over 2.7m (for 80~125 units: 3.2 m). To avoid accidental touching, it is recommended to install the unit higher than 2.5m.

Refer to the chapter "Field setting" and to the decoration panel installation manual.

**3. Air flow directions**

Select the air flow directions best suited to the room and point of installation. (For air discharge in 2 or 3 directions, it is necessary to make field settings by means of the remote controller and to close the air outlet(s). Refer to the installation manual of the optional blocking pad kit and to the chapter "Field setting".

see figure 1 (⇧: air flow direction)

- 1 Air discharge in 4 directions
- 2 Air discharge in 3 directions
- 3 Air discharge in 2 directions

**4. Use suspension bolts for installation. Check whether the ceiling is strong enough to support the weight of the indoor unit. If there is a risk, reinforce the ceiling before installing the unit.**

(The installation pitch is marked on the paper pattern for installation. Refer to it to check for points requiring reinforcing.) Space required for installation see figure 2 (⇧: air flow direction)

- 1 Air discharge
- 2 Air inlet

**NOTE** 

- Leave 200mm or more space where marked with \*, on sides where the air outlet is closed.

Model	H
FH(Y)C(P)35-71	≥240
FHYC(P)100•125	≥298

## PREPARATIONS BEFORE INSTALLATION

### 1. Relation of ceiling opening to unit and suspension bolt position. (see figure 3)

- 1 Refrigerant piping
- 2 Suspension bolt (x4)
- 3 Hanger bracket
- 4 False ceiling
- 5 Suspension bolt pitch
- 6 Indoor unit
- 7 Ceiling opening
- 8 Decoration panel

- Installation is possible when opening dimensions are as follows.

When installing the unit within the frame for fixing ceiling materials.

see figure 4

- 1 Dimensions inside frame
- 2 Opening dimension inside the frame for ceiling
- 3 Frame
- 4 Ceiling material
- 5 Ceiling opening dimension
- 6 Ceiling-panel overlapping dimension

### NOTE

- Installation is possible with a ceiling dimension of 910mm (marked with\*). However, to achieve a ceiling-panel overlapping dimension of 20mm, the spacing between the ceiling and the unit should be 35mm or less. If the spacing between ceiling and the unit is over 35mm, attach ceiling material to the part or recover the ceiling.

### 2. Make the ceiling opening needed for installation where applicable. (For existing ceilings.)

- Refer to the paper pattern for installation for the ceiling opening dimensions.
- Create the ceiling opening required for installation. From the side of the opening to the casing outlet, implement the refrigerant and drain piping and wiring for remote controller (unnecessary for wireless type). Refer to each piping or wiring section.
- After making an opening in the ceiling, it may be necessary to reinforce ceiling beams to keep the ceiling level and to prevent it from vibrating. Consult the builder for details.

### 3. Install the suspension bolts. (Use either a W3/8 or M10 size bolt.)

Use anchors for existing ceilings, and a sunken insert, sunken anchors or other field supplied parts for new ceilings to reinforce the ceiling in order to bear the weight of the unit. Adjust clearance from the ceiling before proceeding further.

Installation example see figure 5

- 1 Ceiling slab
- 2 Anchor
- 3 Long nut or turn-buckle
- 4 Suspension bolt
- 5 False ceiling

### NOTE

- All the above parts are field supplied.
- For other installation than standard installation, contact your Daikin dealer for details.

## INSTALLATION PROCEDURES FOR FRESH AIR INTAKE DUCT CONNECTION

### 1. Preparing the connection hole (see figure 10).

- Cut off the knockout hole on the side plate with a nipper.
- Cut the insulation of the hole portion with a cutter.

- 1 Piping
- 2 Drain pipe
- 3 Side plate
- 4 Inner insulation
- 5 Slit

### 2. Placing the insulation (see figure 11).

- Put the insulation tightly around the hole of the unit as shown. The ends of the side plate and the inner insulation must be completely adhered without leaving any clearance along the circumference of the hole.  
Make sure the inner surface of insulation tightly contacts the inner insulation edge and the side plate.

- 1 Insulation (field supply)
- 2 Side plate
- 3 Inner insulation

## INDOOR UNIT INSTALLATION

When installing optional accessories (except for the decoration panel), read also the installation manual of the optional accessories. Depending on the field conditions, it may be easier to install optional accessories before the indoor unit is installed. However, for existing ceilings, install fresh air inlet component kit and branch duct before installing the unit.

### 1. Install the indoor unit temporarily.

- Attach the hanger bracket to the suspension bolt. Be sure to fix it securely by using a nut and washer from the upper and lower sides of the hanger bracket.

Securing the hanger bracket see figure 6

- 1 Nut (field supply)
- 2 Washer (supplied with the unit)
- 3 Hanger bracket
- 4 Tighten (double nut)

### 2. Fix the paper pattern for installation. (For new ceilings only.)

- The paper pattern for installation corresponds with the measurements of the ceiling opening. Consult the builder for details.
- The centre of the ceiling opening is indicated on the paper pattern for installation. The centre of the unit is indicated on the unit casing and on the paper pattern for installation.
- After removing the packaging material from the paper pattern for installation, attach the paper pattern for installation to the unit with the attached screws as shown in figure 7.

- 1 Height adjustment of the unit
- 2 Ceiling material
- 3 Lower surface of ceiling
- 4 Installation of paper pattern for installation (supplied with the unit)
- 5 Centre of the ceiling opening
- 6 Centre of the unit
- 7 Paper pattern for installation
- 8 Screws (supplied with the unit)

- The ceiling height is shown on the side of the paper pattern for installation. Adjust the height of the unit according to this indication.

### 3. Adjust the unit to the right position for installation.

(Refer to the chapter "Preparations before installation".)

### 4. Check if the unit is horizontally levelled.

- Do not install the unit tilted. The indoor unit is equipped with a built-in drain pump and float switch. (If the unit is tilted against condensate flow, the float switch may malfunction and cause water to drip.)
- Check if the unit is levelled at all four corners with a water level or a water-filled vinyl tube as shown in figure 14.

- 1 Water level
- 2 Vinyl tube

### 5. Remove the paper pattern for installation. (For new ceilings only.)

## REFRIGERANT PIPING WORK

For refrigerant piping of outdoor unit, refer to the installation manual supplied with the outdoor unit.

Before rigging tubes, check which type of refrigerant is used.



All field piping must be provided by a licensed refrigeration technician and must comply with the relevant local and national codes.

- Use a pipe cutter and flare suitable for the used refrigerant.
- If R407C refrigerant is used, apply ether oil or ester oil around the flare portions before connecting.
- To prevent dust, moisture or other foreign matter from infiltrating the tube, either pinch the end, or cover it with tape.
- The outdoor unit is charged with refrigerant.
- Be sure to use both a spanner and torque wrench together when connecting or disconnecting pipes to/from the unit.

- 1 Torque wrench
- 2 Spanner
- 3 Piping union
- 4 Flare nut

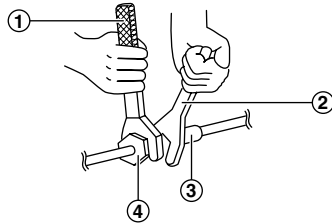

- Do not mix anything other than the specified refrigerant, such as air, etc., inside the refrigerant circuit.
- Refer to Table 1 for the dimensions of flare nut spaces and the appropriate tightening torque. (Overtightening may damage the flare and cause leaks.)

Table 1

Pipe gauge	Tightening torque	Flare dimension A (mm)	Flare shape
Ø 6.4	1420~1720 N•cm (144~176 kgf•cm)	8.3~8.7	
Ø 9.5	3270~3990 N•cm (333~407 kgf•cm)	12.0~12.4	
Ø 12.7	4950~6030 N•cm (504~616 kgf•cm)	15.4~15.8	
Ø 15.9	6180~7540 N•cm (630~770 kgf•cm)	18.6~19.0	
Ø 19.1	9720~11860 N•cm (990~1210 kgf•cm)	22.9~23.3	

- When connecting the flare nut, coat the flare both inside and outside with refrigerating machine oil and initially tighten by hand 3 or 4 turns before tightening firmly.

- 1 Coat here with refrigerating machine oil

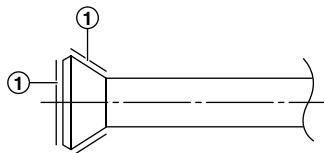

- Check the pipe connector for gas leaks, then insulate it as shown in the figure below.

- 1 Liquid pipe
- 2 Gas pipe
- 3 Insulation for fitting of liquid line (supplied with the unit)
- 4 Insulation for fitting of gas line (supplied with the unit)
- 5 Clamps (use 2 clamps per insulation)

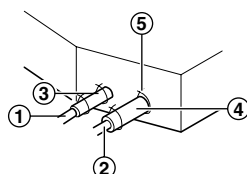

- If the refrigerant gas leaks during the work, ventilate the area. A toxic gas is emitted by the refrigerant gas being exposed to a fire.
- Finally make sure there is no refrigerant gas leak. A toxic gas may be released by the refrigerant gas leaking indoor and being exposed to flames from an area heater, cooking stove, etc.

## DRAIN PIPING WORK

Rig the drain piping as shown in figure and take measures against condensation. Improperly rigged piping could lead to leaks and eventually wet furniture and belongings.

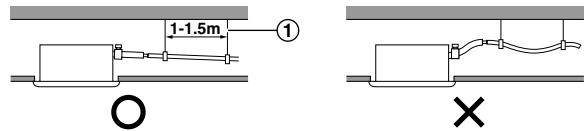

- 1 Hanging bar

### 1. Install the drain pipes.

- Keep piping as short as possible and slope it downwards so that air may not remain trapped inside the pipe.
- Keep pipe size equal to or greater than that of the connecting pipe (Vinyl pipe of 25mm nominal diameter and 32mm outer diameter).
- Insert the supplied drain hose into the drain socket, up to the white tape.
- Tighten the clamp until the screw head is less than 4mm from the hose.

- 1 Clamp metal (supplied with the unit)
- 2 Drain hose (supplied with the unit)
- 3 White tape (field supply)

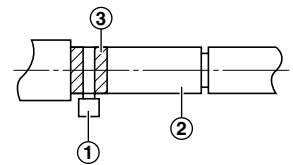

- Insulate the drain piping inside the building.
- If the drain hose cannot be sufficiently set on a slope, fit the hose with drain raising piping (field supply).

### HOW TO PERFORM PIPING (see figure 8)

- 1 Ceiling slab
- 2 Hanger bracket
- 3 Adjustable range
- 4 Drain raising pipe
- 5 Drain hose (supplied with the unit)
- 6 Clamp metal (supplied with the unit)

- 1 Connect the drain hose to the drain raising pipes, and insulate them.
- 2 Connect the drain hose to the drain outlet on the indoor unit, and tighten it with the clamp.

### PRECAUTIONS

- Install the drain raising pipes at a height of less than 550mm.
- Install the drain raising pipes at a right angle to the indoor unit and no more than 300mm from the unit.



**NOTE** 

- The incline of attached drain hose should be 75mm or less so that the drain socket does not have to stand additional force.
- To ensure a downward slope of 1:100, install hanging bars every 1 to 1.5m.
- If unifying multiple drain pipes, install the pipes as shown in figure 9. Select converging drain pipes whose gauge is suitable for the operating capacity of the unit.

1 T-joint converging drain pipes

**2. After piping work is finished, check if drainage flows smoothly.**

- Open the water inlet lid, add approximately 2l of water gradually and check the drainage flow.

Method of adding water: see figure 12

- 1 Portable pump
- 2 Drain pipe
- 3 Service cover
- 4 Inspection opening
- 5 Service drain outlet (with rubber plug) (Use this outlet to drain water from the drain pan)
- 6 Plastic watering can (Tube should be about 100mm long.) (Adding water through air discharge outlet)
- 7 Bucket (Adding water from inspection opening)

---

**WHEN ELECTRIC WIRING WORK IS FINISHED**

---

Check drainage flow during COOL running, explained in chapter "TEST OPERATION".

---

**WHEN ELECTRIC WIRING WORK IS NOT FINISHED**

---

- Remove the control box lid and change the emergency switch above the PC board assembly of the indoor unit from "Normal" to "Emergency". Connect the single-phase power supply (50 Hz, 230 V) to connections No. 1 and No. 3 on the power supply terminal board and confirm drain operation. Be sure to change the switch before turning on the power.
- Be aware that the fan will turn during the operation.
- After confirming drainage, turn off the power and be sure to change the emergency switch back to "Normal".

see figure 13

- 1 Switch box lid (1)
- 2 Power supply
- 3 Power supply terminal board
- 4 Rubber bush A
- 5 Clamp A
- 6 Switch box lid (2) with wiring diagram label
- 7 Transmission wiring
- 8 Terminal board for transmission wiring
- 9 Rubber bush B
- 10 Clamp B
- 11 Outside of the unit
- 12 Inside of the unit
- 13 Cable (power supply or transmission wiring)
- 14 Opening for the cable
- 15 Small sealing

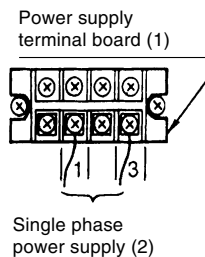

## ELECTRIC WIRING WORK

### General instructions

- All field supplied parts and materials and electric works must conform to local codes.
- Use copper wire only.
- Follow the 'Wiring diagram' attached to the unit body to wire the outdoor unit, indoor units and the remote controller. For details on hooking up the remote controller, refer to the "Installation manual of the remote controller".
- All wiring must be performed by an authorized electrician.
- A circuit breaker capable of shutting down power supply to the entire system must be installed.
- Note that the operation will restart automatically if the main power supply is turned off and then turned back on again.
- Refer to the installation manual attached to the outdoor unit for the size of power supply electric wire connected to the outdoor unit, the capacity of the circuit breaker and switch, and wiring instructions.

### Electrical characteristics

**NOTE** 

- For details, refer to "Electrical data".

### Specifications for field wire

	Wire	Size (mm <sup>2</sup> )	Length
Between indoor units	H05VV-U4G (NOTE 1)	local codes	-
Unit-Remote controller	Sheathed wire (2 wire)	0.75 - 1.25	Max. 500m

**NOTE:** Shows only in case of protected pipes. Use HO7RN-F in case of no protection.

# WIRING EXAMPLE AND HOW TO SET THE REMOTE CONTROLLER

## How to connect wiring (see figure 13)

- Power supply wiring  
Remove the switch box lid (1) and connect the wires to the power supply terminal board inside. While doing this, pull the wires inside through the rubber bush A and clamp the wires along with other wires using clamp A, untightening the clip of clamp A by pressing. After the connection, tighten clamp A as before.
  - Unit wiring and remote controller wiring  
Remove the switch box lid (2) and pull the wires inside through the rubber bush B and connect to the terminal board for unit transmission wiring.
  - After connection  
Attach the small sealing (supplied with the unit) around the cables to prevent infiltrating of water from the outside into the unit. If two or more cables are used, divide the small sealing into the required number of pieces and wrap them around all the cables.
- 1 Switch box lid (1)
  - 2 Power supply
  - 3 Power supply terminal board
  - 4 Rubber bush A
  - 5 Clamp A
  - 6 Switch box lid (2) with wiring diagram label
  - 7 Transmission wiring
  - 8 Terminal board for transmission wiring
  - 9 Rubber bush B
  - 10 Clamp B
  - 11 Outside of the unit
  - 12 Inside of the unit
  - 13 Cable (power supply or transmission wiring)
  - 14 Opening for the cable
  - 15 Small sealing

## PRECAUTIONS

- 1 Observe the notes mentioned below when wiring to the power supply terminal board.
  - Do not connect wires of different gauge to the same power supply terminal. (Looseness in the connection may cause overheating.)
  - When connecting wires of the same gauge, connect them according to the figure.



Use the specified electric wire. Connect the wire securely to the terminal. Lock the wire down without applying excessive force to the terminal. (Tightening torque: 131Ncm ±10%).

- 2 Keep total current of crossover wiring between indoor units less than 12A. Branch the line outside the terminal board of the unit in accordance with electrical equipment standards, when using two power wiring of a gauge greater than 2mm<sup>2</sup> (Ø1.6).  
The branch must be sheathed in order to provide an equal or greater degree of insulation as power supply wiring itself.
- 3 Do not connect wires of different gauge to the same grounding terminal. Looseness in the connection may deteriorate the protection.
- 4 Remote controller cords and wires connecting the units should be located at least 50mm away from power supply wiring. Not following this guideline may result in malfunction due to electrical noise.

- 5 For the remote controller wiring, refer to the "Installation manual of the remote controller" supplied with the remote controller.

## Note

The customer has the ability to select the remote controller thermistor (only for FHYCP35~125B7V1).

- 6 Never connect the power supply wiring to the terminal board for transmission wiring. This mistake could damage the entire system.
- 7 Use only specified wires and tightly connect wires to the terminals. Be careful that wires do not place external stress on the terminals. Keep wiring in neat order so that they do not obstruct other equipment such as popping open the service cover. Make sure the cover closes tight. Incomplete connections could result in overheating, and in the worse case, electric shock or fire.

## WIRING EXAMPLE

For the wiring of outdoor units, refer to the installation manual attached to the outdoor units.

Confirm the system type:

- Pair type: 1 remote controller controls 1 indoor unit (standard system).
- Simultaneous operation system: 1 remote controller controls 2 indoor units (2 indoor units operate equally)
- Group control: 1 remote controller controls up to 16 indoor units (All indoor units operate according to the remote controller).
- 2 remote controller control: 2 remote controllers control 1 indoor unit.

Pair type (figure 15)

---

Simultaneous operation system (figure 16)

---

Group control (figure 17)

---

2 remote controller control (figure 18)

---

- 1 Main power supply
- 2 Main switch
- 3 Fuse
- 4 Outdoor unit
- 5 Indoor unit
- 6 Remote controller (optional accessories)
- 7 Indoor unit (Master)
- 8 Indoor unit (Slave)

## NOTE

- It is not necessary to designate indoor unit address when using group control. The address is automatically set when the power is activated.

## PRECAUTIONS

1. All transmission wiring except for the remote controller wires is polarized and must match the terminal symbol.
2. In case of group control, perform the remote controller wiring to the master unit when connecting to the simultaneous operation system (wiring to the slave unit is unnecessary).
3. For group control remote controller, choose the remote controller that suits the indoor unit which has the most functions (as attached swing flap).
4. When controlling the simultaneous operation system with 2 remote controllers, connect it to the master unit (wiring to the slave unit is unnecessary).
5. Be sure to connect the wiring to the master unit when combining with a simultaneous operating multi-type in group control.
6. Do not ground the equipment on gas pipes, water pipes, lightning rods or crossground with telephones. Improper grounding could result in electric shock.

## FIELD SETTING

Field setting must be made from the remote controller in accordance with the installation condition.

- Setting can be made by changing the "Mode number", "FIRST CODE No." and "SECOND CODE No."
- For setting and operation, refer to the "Field setting" in the installation manual of the remote controller.

### Setting ceiling height

- Select the SECOND CODE No. that corresponds to the ceiling height. (SECOND CODE No. is factory set to "01" for a ceiling height of 2.7m or less.)

Ceiling height (m)		Mode n°	1st code n°	2nd code n°	
units 35~71	units 100~125				
<2.7	<3.2	N	13 (23)	0	01
>2.7 or <3.0	<3.2 or <3.6	H	13 (23)	0	02
>3.0 or <3.5	<3.6 or 4.2	S	13 (23)	0	03

The figure of ceiling height is for air discharge in 4 directions.

### Setting air discharge direction

- For changing air discharge direction (2 or 3 directions), refer to the option handbook of the optional blocking pad kit. (SECOND CODE No. is factory set to "01" for air discharge in 4 directions.)

### Setting when installing high performance filters

- In case of installing high performance filters, refer to the option handbook of the high performance filters.

### Setting air filter sign

- Remote controllers are equipped with liquid crystal air filter signs to display the time to clean the air filter.
- Change the SECOND CODE No. Depending on the amount of dirt or dust in the room. (SECOND CODE No. is factory set to "01" for air filter contamination-light)

### Air Filter contamination

Setting	Display interval	Mode n°	1st code n°	2nd code n°
Light	±2500 hrs	10 (20)	0	01
Heavy	±1250 hrs	10 (20)	0	02

- When using wireless remote controllers it is necessary to use address setting. Refer to the installation manual attached to the wireless remote controller for the setting instructions.

### Setting indoor unit number of simultaneous operation system

- When using in simultaneous operation system mode, change the SECOND CODE No. as shown in the table. (SECOND CODE No. is factory set to "01" for 1 connected unit.)

Setting	Mode No.	FIRST CODE No.	SECOND CODE No.
Pair system (1 unit)	11 (21)	0	01
Simultaneous operation system (2-unit)			02
Simultaneous operation system (3-unit)			03
Simultaneous operation system (4-unit)			04

- When using in simultaneous operation system mode, refer to "Simultaneous Operation System Individual Setting" section to set master and slave units separately.

### When using wireless remote controllers

- When using wireless remote controllers, wireless remote controller address setting is necessary. Refer to the installation manual attached to the wireless remote controller for setting instructions.

### Simultaneous operation system individual setting

It is easier if the optional remote controller is used when setting the slave unit.

Perform the following procedures when setting the master and slave unit separately.

#### Procedure (see figure 19)

1. Change the SECOND CODE No. to "02", individual setting, so that the slave unit can be individually set. (SECOND CODE No. is factory set to "01", unified setting.)

Setting	Mode No.	FIRST CODE No.	SECOND CODE No.
Unified setting	11 (21)	1	01
Individual setting			02

2. Perform field setting for the master unit.
3. Turn off the main power supply switch after (2).
4. Detach remote controller from the master unit and connect it to the slave unit.
5. Turn on the main power supply switch again, and as in (1), change the Position No. to "02", individual setting.
6. Perform field setting for the slave unit.
7. Turn off the main power supply switch after (6).

8. Detach the remote controller from the slave unit after the setting, and reattach to the master unit. This is the end of the setting procedure.
- You do not need to rewire the remote controller from the master unit if the optional remote controller for slave unit is used. (However, remove the wires attached to the remote controller terminal board of the master unit.)

### Control by 2 Remote Controllers (Controlling 1 indoor unit by 2 remote controllers)

- When using 2 remote controllers, one must be set to "MAIN" and the other to "SUB".

### MAIN/SUB CHANGEOVER

1. Insert a wedge-head screwdriver into the recess between the upper and lower part of the remote controller and, working from the 2 positions, pry off the upper part. (see figure 20)  
(The remote controller PC board is attached to the upper part of the remote controller.)
2. Turn the main/sub changeover switch on one of the two remote controller PC boards to "S". (see figure 22)  
(Leave the switch of the other remote controller set to "M".)
  - 1 Remote controller PC board
  - 2 Factory setting
  - 3 Only one remote controller needs to be changed

### NOTE

For simultaneous operating system, connect the remote controller cord to the master unit.

## INSTALLATION OF THE DECORATION PANEL

Refer to the installation manual attached to the decoration panel.

After installing the decoration panel, ensure that there is no space between the unit body and decoration panel. Otherwise air may leak through the gap and cause dew drop.

## TEST OPERATION

Refer to the section of "FOR THE FOLLOWING ITEMS, TAKE SPECIAL CARE DURING CONSTRUCTION AND CHECK AFTER INSTALLATION IS FINISHED" (p. 2).

- After finishing the construction of refrigerant piping, drain piping, and electric wiring, conduct test operation accordingly to protect the unit.

### TEST OPERATION AFTER INSTALLING DECORATION PANEL

1. Open the gas side stop valve.
2. Open the liquid side stop valve.
3. Electrify crank case heater for 6 hours.
4. Set to cooling operation with the remote controller and start operation by pushing ON/OFF button.
5. Press Inspection/Test Operation button 4 times (2 times for wireless remote controller) and operate at Test Operation mode for 3 minutes.
6. Push air flow direction adjust button to make sure the unit is in operation.
7. Press Inspection/Test Operation button and operate normally.
8. Confirm function of unit according to the operation manual.





### TEST OPERATION BEFORE INSTALLING DECORATION PANEL (NOTE 3)

1. Open the gas side stop valve.
2. Open the liquid side stop valve.
3. Electrify crank case heater for 6 hours.
4. Set to cooling operation with the wired remote controller and start operation by pushing ON/OFF button. "A7" appears on the display.
5. Press Inspection/Test Operation button on the remote controller and operate at Test Operation mode for 3 minutes.
6. Press Inspection/Test Operation button and operate normally.
7. Confirm function of unit according to the operation manual.
8. Turn off the main power supply after operation.

### PRECAUTIONS

1. In case something is wrong with the unit and it does not operate, refer to the malfunction diagnosis label attached to the unit.
2. Refer to the installation manual attached to the outdoor unit in case of Individual Operation System type.
3. Conduct test operation after installing decoration panel if the wireless remote controller is used.

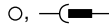
# WIRING DIAGRAM

-  : FIELD WIRING
-  : TERMINAL
-  : CONNECTOR
-  : WIRE CLAMP
-  : PROTECTIVE EARTH (SCREW)

- BLK : BLACK
- RED : RED
- WHT : WHITE
- YLW : YELLOW

- 33H ..... FLOAT SWITCH
- A1P ..... PRINTED CIRCUIT BOARD
- C1R ..... CAPACITOR (FAN MOTOR)
- CD ..... CURRENT DETECT CIRCUIT
- F1U ..... FUSE (250V/5A)
- HAP,HBP ..... LIGHT EMITTING DIODE (SERVICE MONITOR - GREEN)
- M1A ..... MOTOR (SWING FLAP)
- M2F ..... MOTOR (INDOOR FAN)
- M3P ..... MOTOR (DRAIN PUMP)
- PC ..... PHASE CONTROL CIRCUIT
- Q1F ..... THERMO SWITCH (M2F EMBEDDED)
- R1T ..... THERMISTOR (AIR)
- R2T ..... THERMISTOR (COIL)
- RC ..... SIGNAL RECEIVER CIRCUIT
- RyC ..... MAGNETIC RELAY (OUTDOOR UNIT COMPRESSOR)
- RyP ..... MAGNETIC RELAY (DRAIN PUMP)
- SS1 ..... SELECTOR SWITCH (EMERGENCY)
- T1R ..... TRANSFORMER (230V, 22V)
- TC ..... SIGNAL TRANSMISSION CIRCUIT
- X1M,X2M ..... TERMINAL STRIP

**WIRED REMOTE CONTROLLER**

- SS1 ..... SELECTOR SWITCH (MAIN/SUB)

**RECEIVER/DISPLAY UNIT (ATTACHED TO WIRELESS REMOTE CONTROLLER)**

- A2P,A3P ..... PRINTED CIRCUIT BOARD
- BS ..... ON/OFF BUTTON
- H1P ..... LIGHT EMITTING DIODE (SERVICE MONITOR - RED)
- H2P ..... LIGHT EMITTING DIODE (SERVICE MONITOR - GREEN)
- H3P ..... LIGHT EMITTING DIODE (SERVICE MONITOR - RED)
- H4P ..... LIGHT EMITTING DIODE (SERVICE MONITOR - ORANGE)
- SS1 ..... SELECTOR SWITCH (MAIN/SUB)
- SS2 ..... SELECTOR SWITCH (WIRELESS ADDRESS SET)

**ADAPTER FOR WIRING**

- RyC,RyF ..... MAGNETIC RELAY

**CONNECTOR FOR OPTIONAL PARTS**

- X30A ..... CONNECTOR (INTERFACE ADAPTOR FOR SKY AIR SERIES)
- X33A ..... CONNECTOR (ADAPTOR FOR WIRING)
- X35A ..... CONNECTOR (GROUP CONTROL ADAPTOR)

- RECEIVER/DISPLAY UNIT :
- IN CASE OF SIMULTANEOUS OPERATION SYSTEM :
- MASTER :
- SLAVE :
- REMOTE CONTROLLER :
- WIRED REMOTE CONTROLLER :
- ADAPTOR FOR WIRING :
- TERMINALS FOR OPERATION INDICATOR :
- FAN OPERATION :
- COMPRESSOR OPERATION :
- SWITCH BOX :

**NOTES**

1. WHEN USING THE CENTRAL REMOTE CONTROLLER, SEE MANUAL FOR CONNECTION TO UNIT.
2. X24A IS CONNECTED WHEN THE WIRELESS REMOTE CONTROLLER KIT IS USED.
3. THE REMOTE CONTROLLER MODEL VARIES ACCORDING TO THE COMBINATION SYSTEM. SEE TECHNICAL MATERIALS AND CATALOGS, ETC. BEFORE CONNECTING.

**DAIKIN EUROPE NV**

Zandvoordestraat 300, B-8400 Oostende, Belgium

4PW10740-1