

DAIKIN

INVERTER

DAIKIN ROOM AIR CONDITIONER

Operation Manual

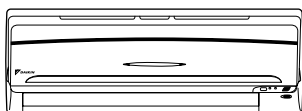

MODELS FTXS20CVMB FTKS20CVMB
FTXS25CVMB FTKS25CVMB
FTXS35CVMB FTKS35CVMB
FTXS20CAVMB FTKS20CAVMB
FTXS25CAVMB FTKS25CAVMB
FTXS35CAVMB FTKS35CAVMB



English

Deutsch

Français

Nederlands

Español

Italiano

Ελληνικά

Portugues

Русский

CONTENTS

READ BEFORE OPERATION

Safety precautions	2
Names of parts	4
Preparation Before Operation	7

OPERATION

AUTO · DRY · COOL · HEAT · FAN Operation	10
Adjusting the Air Flow Direction	12
POWERFUL Operation	14
OUTDOOR UNIT QUIET Operation.....	15
HOME LEAVE Operation	16
INTELLIGENT EYE Operation	18
TIMER Operation	20
Note for Multi System	22

CARE

Care and Cleaning	24
-------------------------	----

TROUBLE SHOOTING

Trouble Shooting	27
------------------------	----

Safety precautions

- Keep this manual where the operator can easily find them.
- Read this manual attentively before starting up the unit.
- For safety reason the operator must read the following cautions carefully.
- This manual classifies precautions into WARNINGS and CAUTIONS. Be sure to follow all precautions below: they are all important for ensuring safety.

WARNING

If you do not follow these instructions exactly, the unit may cause property damage, personal injury or loss of life.

CAUTION

If you do not follow these instructions exactly, the unit may cause minor or moderate property damage or personal injury.



Never do.



Be sure to earth the air conditioner.



Never touch the air conditioner (including the remote controller) with a wet hand.





Be sure to follow the instructions.



Never cause the air conditioner (including the remote controller) to get wet.

WARNING

- In order to avoid fire, explosion or injury, do not operate the unit when harmful, among which flammable or corrosive gases, are detected near the unit. 
- It is not good for health to expose your body to the air flow for a long time.
- Do not put a finger, a rod or other objects into the air outlet or inlet. As the fan is rotating at a high speed, it will cause injury.
- Do not attempt to repair, relocate, modify or reinstall the air conditioner by yourself. Incorrect work will cause electric shocks, fire etc.
For repairs and reinstallation, consult your Daikin dealer for advice and information.

- The refrigerant used in the air conditioner is safe. Although leaks should not occur, if for some reason any refrigerant happens to leak into the room, make sure it does not come in contact with any flame as of gas heaters, kerosene heaters or gas range. 
- If the air conditioner is not cooling (heating) properly, the refrigerant may be leaking, so call your dealer. When carrying out repairs accompanying adding refrigerant, check the content of the repairs with our service staff.
- Do not attempt to install the air conditioner by your self. Incorrect work will result in water leakage, electric shocks or fire. For installation, consult the dealer or a qualified technician.
- In order to avoid electric shock, fire or injury, if you detect any abnormally such as smell of fire, stop the operation and turn off the breaker. And call your dealer for instructions.
- Depending on the environment, an earth leakage breaker must be installed. Lack of an earth leakage breaker may result in electric shocks or fire.

- The air conditioner must be earthed. Incomplete earthing may result in electric shocks. Do not connect the earth line to a gas pipe, water pipe, lightning rod, or a telephone earth line. 

CAUTION

- In order to avoid any quality deterioration, do not use the unit for cooling precision instruments, food, plants, animals or works of art. 
- Never expose little children, plants or animals directly to the air flow.

- Do not place appliances which produce open fire in places exposed to the air flow from the unit or under the indoor unit. It may cause incomplete combustion or deformation of the unit due to the heat.
- Do not block air inlets nor outlets. Impaired air flow may result in insufficient performance or trouble.
- Do not stand or sit on the outdoor unit. Do not place any object on the unit to avoid injury, do not remove the fan guard.
- Do not place anything under the indoor or outdoor unit that must be kept away from moisture. In certain conditions, moisture in the air may condense and drip.
- After a long use, check the unit stand and fittings for damage.
- Do not touch the air inlet and aluminum fins of outdoor unit. It may cause injury.
- The appliance is not intended for use by young children or infirm persons without supervision.
- Young children should be supervised to ensure that they do not play with the appliance.

- To avoid oxygen deficiency, ventilate the room sufficiently if equipment with burner is used together with the air conditioner. 
- Before cleaning, be sure to stop the operation, turn the breaker off or pull out the supply cord.
- Do not connect the air conditioner to a power supply different from the one as specified. It may cause trouble or fire.
- Arrange the drain hose to ensure smooth drainage. Incomplete draining may cause wetting of the building, furniture etc.
- Do not place objects in direct proximity of the outdoor unit and do not let leaves and other debris accumulate around the unit.
Leaves are a hotbed for small animals which can enter the unit. Once in the unit, such animals can cause malfunctions, smoke or fire when making contact with electrical parts.

- Do not operate the air conditioner with wet hands. 

- Do not wash the indoor unit with excessive water, only use a slightly wet cloth.
- Do not place things such as vessels containing water or anything else on top of the unit. Water may penetrate into the unit and degrade electrical insulations, resulting in an electric shock. 

Installation site.

- To install the air conditioner in the following types of environments, consult the dealer.
 - Places with an oily ambient or where steam or soot occurs.
 - Salty environment such as coastal areas.
 - Places where sulfide gas occurs such as hot springs.
 - Places where snow may block the outdoor unit.

The drain from the outdoor unit must be discharged to a place of good drainage.

Consider nuisance to your neighbours from noises.

- For installation, choose a place as described below.
 - A place solid enough to bear the weight of the unit which does not amplify the operation noise or vibration.
 - A place from where the air discharged from the outdoor unit or the operation noise will not annoy your neighbours.

Electrical work.

- For power supply, be sure to use a separate power circuit dedicated to the air conditioner.

System relocation.

- Relocating the air conditioner requires specialized knowledge and skills. Please consult the dealer if relocation is necessary for moving or remodeling.

Names of parts

■ Indoor Unit

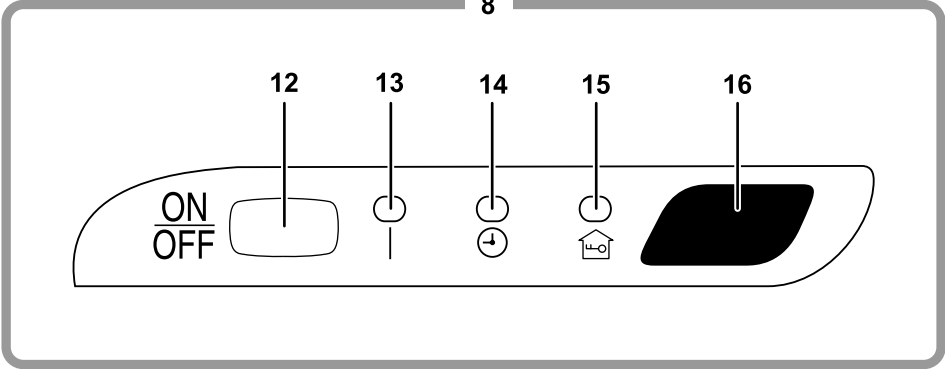
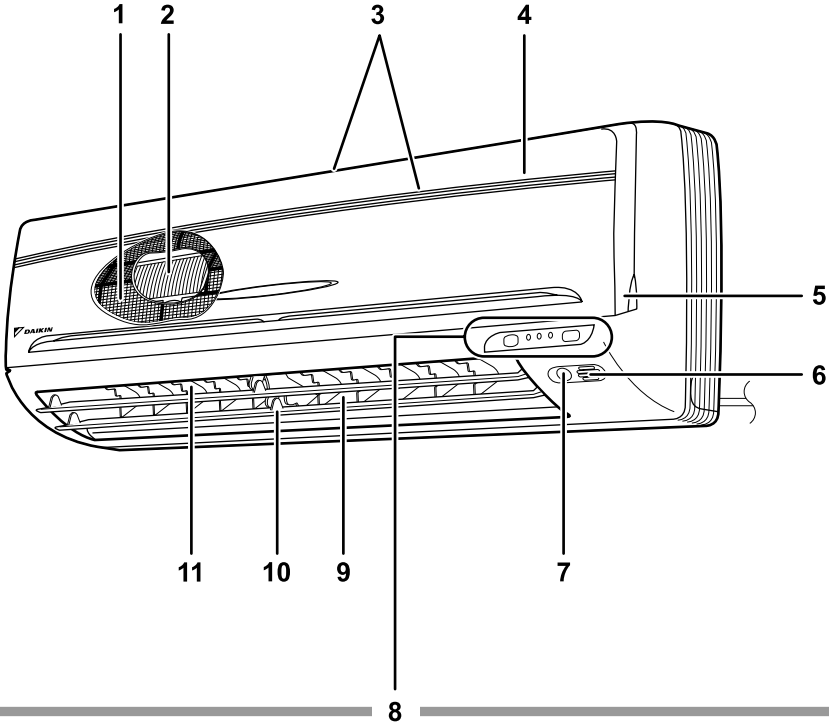

■ Outdoor Unit

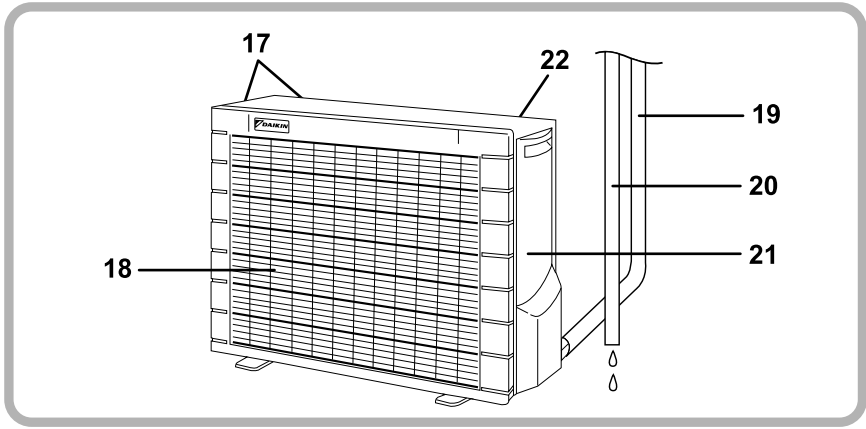

■ Indoor Unit

1. Air filter
2. Air purifying filter with photocatalytic deodorizing function:
 - These filters are attached to the inside of the air filters.
3. Air inlet
4. Front panel
5. Panel tab
6. Room temperature sensor:
 - It senses the air temperature around the unit.
7. INTELLIGENT EYE sensor:
 - It detects the movements of people and automatically switches between normal operation and energy saving operation. (page 18.)
8. Display
9. Air outlet
10. Flaps (horizontal blades): (page 12.)
11. Louvers (vertical blades):
 - The louvers are inside of the air outlet. (page 13.)

12. Indoor Unit ON/OFF switch: (page 10.)

- Push this switch once to start operation. Push once again to stop it.
- The operation mode refers to the following table.

	Mode	Temperature setting	Air flow rate
FTKS	COOL	22°C	AUTO
FTXS	AUTO	25°C	AUTO

- This switch is useful when the remote controller is missing.

13. Operation lamp (green)
14. TIMER lamp (yellow): (page 20.)
15. HOME LEAVE lamp (red): (page 16.)
16. Signal receiver:

- It receives signals from the remote controller.
- When the unit receives a signal, you will hear a short beep.
 - Operation startbeep-beep
 - Settings changedbeep
 - Operation stopbeeeeee

■ Outdoor Unit

17. Air inlet: (Back and side)
18. Air outlet
19. Refrigerant piping and inter-unit cable
20. Drain hose
21. Earth terminal:
 - It is inside of this cover.
22. Outside air temperature sensor: (Back side)
 - It senses the ambient temperature around the unit.

Appearance of the outdoor unit may differ from some models.

■ Remote Controller

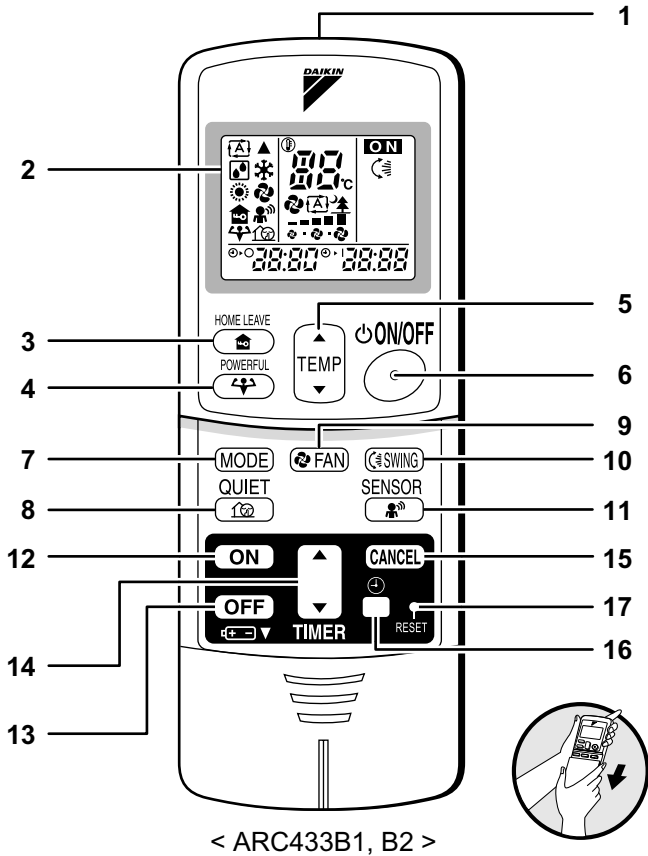

1. Signal transmitter:

- It sends signals to the indoor unit.

2. Display:

- It displays the current settings.
(In this illustration, each section is shown with all its displays ON for the purpose of explanation.)

3. HOME LEAVE button:

- HOME LEAVE operation (page 16.)

4. POWERFUL button:

- POWERFUL operation (page 14.)

5. TEMPERATURE adjustment buttons:

- It changes the temperature setting.

6. ON/OFF button:

- Press this button once to start operation.
Press once again to stop it.

7. MODE selector button:

- It selects the operation mode.

(AUTO/DRY/COOL/HEAT/FAN) (page 10.)

8. QUIET button: OUTDOOR UNIT QUIET operation (page 15.)

9. FAN setting button:

- It selects the air flow rate setting.

10. SWING button: (page 12.)

11. SENSOR button: INTELLIGENT EYE operation (page 18.)

12. ON TIMER button: (page 21.)

13. OFF TIMER button: (page 20.)

14. TIMER Setting button:

- It changes the time setting.

15. TIMER CANCEL button:

- It cancels the timer setting.

16. CLOCK button: (page 9.)

17. RESET button:

- Restart the unit if it freezes.
• Use a thin object to push.



Preparation Before Operation

■ To set the batteries

1. Slide the front cover to take it off.
2. Set two dry batteries (AAA).
3. Set the front cover as before.

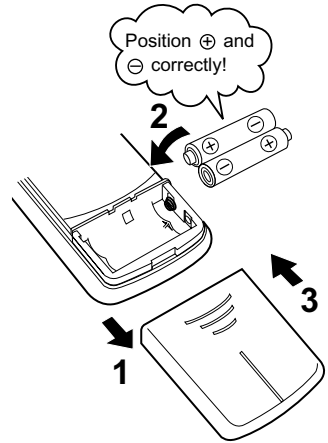

ATTENTION

■ About batteries

- When replacing the batteries, use batteries of the same type, and replace the two old batteries together.
- When the system is not used for a long time, take the batteries out.
- We recommend replacing once a year, although if the remote controller display begins to fade or if reception deteriorates, please replace with new alkali batteries. Using manganese batteries reduces the lifespan.
- The attached batteries are provided for the initial use of the system.
The usable period of the batteries may be short depending on the manufactured date of the air conditioner.

Preparation Before Operation

■ To operate the remote controller

- To use the remote controller, aim the transmitter at the indoor unit. If there is anything to block signals between the unit and the remote controller, such as a curtain, the unit will not operate.
- Do not drop the remote controller. Do not get it wet.
- The maximum distance for communication is about 7 m.

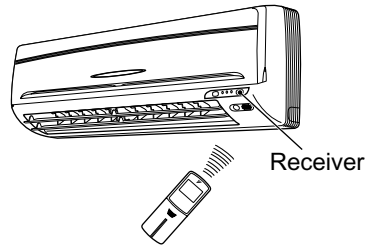

■ To fix the remote controller holder on the wall

1. Choose a place from where the signals reach the unit.
2. Fix the holder to a wall, a pillar, or similar location with the screws procured locally.
3. Place the remote controller in the remote controller holder.

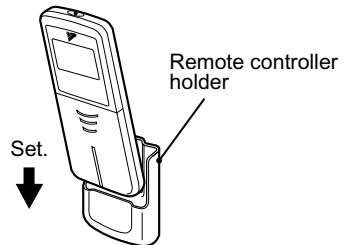

- To remove, pull it upwards.

ATTENTION

■ About remote controller

- Never expose the remote controller to direct sunlight.
- Dust on the signal transmitter or receiver will reduce the sensitivity. Wipe off dust with soft cloth.
- Signal communication may be disabled if an electronic-starter-type fluorescent lamp (such as inverter-type lamps) is in the room. Consult the shop if that is the case.
- If the remote controller signals happen to operate another appliance, move that appliance to somewhere else, or consult the shop.

■ To set the clock

1. Press “CLOCK button”.

0:00 is displayed.

⌚ blinks.

2. Press “TIMER setting button” to set the clock to the present time.

Holding down “▲” or “▼” button rapidly increases or decreases the time display.

3. Press “CLOCK button”.

⌚ blinks.

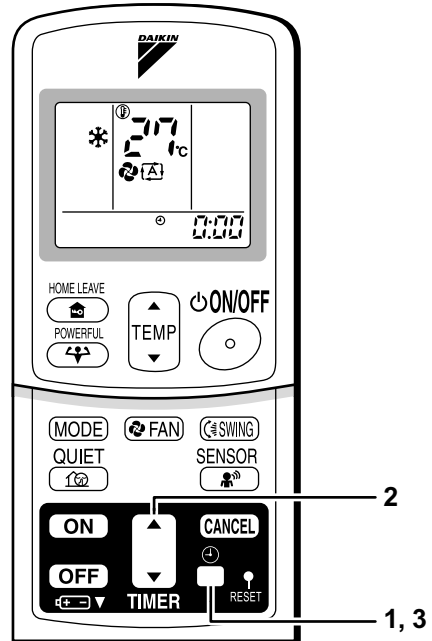

■ Turn the breaker ON

- Turning ON the breaker opens the flap, then closes it again. (This is a normal procedure.)

NOTE

■ Tips for saving energy

- Be careful not to cool (heat) the room too much.
- Keeping the temperature setting at a moderate level helps save energy.
- Cover windows with a blind or a curtain.
- Blocking sunlight and air from outdoors increases the cooling (heating) effect.
- Clogged air filters cause inefficient operation and waste energy. Clean them once in about every two weeks.

Recommended temperature setting

For cooling: 26°C – 28°C
For heating: 20°C – 24°C

■ Please note

- The air conditioner always consumes 15-35 watts of electricity even while it is not operating.
- If you are not going to use the air conditioner for a long period, for example in spring or autumn, turn the breaker OFF.
- Use the air conditioner in the following conditions.

Mode	Operating conditions	If operation is continued out of this range
COOL	Outdoor temperature: (2MK(X)S40) 10 to 46°C (2MXS52) –10 to 46°C (3/4/5MK(X)S) –10 to 46°C (RK(X)S) –10 to 46°C (RK(X)H) 10 to 46°C Indoor temperature: 18 to 32 °C Indoor humidity: 80% max.	<ul style="list-style-type: none"> • A safety device may work to stop the operation. (In multi system, it may work to stop the operation of the outdoor unit only.) • Condensation may occur on the indoor unit and drip.
HEAT	Outdoor temperature: (2MXS40) –10 to 15.5°C (2MXS52) –15 to 15.5°C (3/4/5MXS) –15 to 15.5°C (RXS) –15 to 20°C (RXH) –10 to 20°C Indoor temperature: 10 to 30 °C	<ul style="list-style-type: none"> • A safety device may work to stop the operation.
DRY	Outdoor temperature: (2MK(X)S40) 10 to 46°C (2MXS52) –10 to 46°C (3/4/5MK(X)S) –10 to 46°C (RK(X)S) –10 to 46°C (RK(X)H) 10 to 46°C Indoor temperature: 18 to 32 °C Indoor humidity: 80% max.	<ul style="list-style-type: none"> • A safety device may work to stop the operation. • Condensation may occur on the indoor unit and drip.

- Operation outside this humidity or temperature range may cause a safety device to disable the system.

AUTO · DRY · COOL · HEAT · FAN Operation

The air conditioner operates with the operation mode of your choice.

From the next time on, the air conditioner will operate with the same operation mode.

■ To start operation

1. Press “MODE selector button” and select a operation mode.

- Each pressing of the button advances the mode setting in sequence.

: AUTO

: DRY

: COOL

: HEAT

: FAN

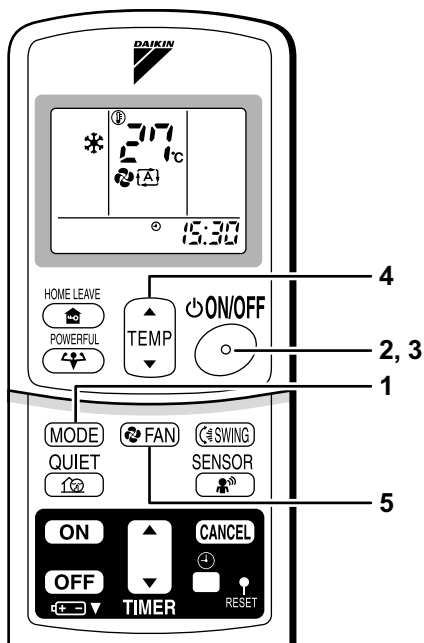
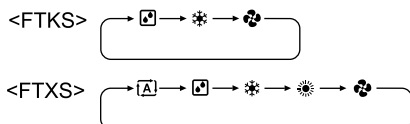

2. Press “ON/OFF button”.

- The OPERATION lamp lights up.

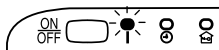

■ To stop operation

3. Press “ON/OFF button” again.

- Then OPERATION lamp goes off.





■ To change the temperature setting

4. Press “TEMPERATURE adjustment button”.

DRY or FAN mode	AUTO or COOL or HEAT mode
The temperature setting is not variable.	Press “▲” to raise the temperature and press “▼” to lower the temperature.
	Set to the temperature you like.

■ To change the air flow rate setting

5. Press “FAN setting button”.

DRY mode	AUTO or COOL or HEAT or FAN mode
The air flow rate setting is not variable.	Five levels of air flow rate setting from “  ” to “  ” plus “  ” “  ” are available. 

- Indoor unit quiet operation

When the air flow is set to “”, the noise from the indoor unit will become quieter. Use this when making the noise quieter.

The unit might lose capacity when the air flow rate is set to a weak level.

NOTE

■ Note on HEAT operation

- Since this air conditioner heats the room by taking heat from outdoor air to indoors, the heating capacity becomes smaller in lower outdoor temperatures. If the heating effect is insufficient, it is recommended to use another heating appliance in combination with the air conditioner.
- The heat pump system heats the room by circulating hot air around all parts of the room. After the start of heating operation, it takes some time before the room gets warmer.
- In heating operation, frost may occur on the outdoor unit and lower the heating capacity. In that case, the system switches into defrosting operation to take away the frost.
- During defrosting operation, hot air does not flow out of indoor unit.

■ Note on COOL operation

- This air conditioner cools the room by blowing the hot air in the room outside, so if the outside temperature is high, performance drops.

■ Note on DRY operation

- The computer chip works to rid the room of humidity while maintaining the temperature as much as possible. It automatically controls temperature and fan strength, so manual adjustment of these functions is unavailable.

■ Note on AUTO operation

- In AUTO operation, the system selects an appropriate operation mode (COOL or HEAT) based on the room temperature at the start of the operation.
- The system automatically reselects setting at a regular interval to bring the room temperature to user-setting level.
- If you do not like AUTO operation, you can manually select the operation mode and setting you like.

■ Note on air flow rate setting

- At smaller air flow rates, the cooling (heating) effect is also smaller.

Adjusting the Air Flow Direction

You can adjust the air flow direction to increase your comfort.

■ To adjust the horizontal blades (flaps)

1. Press “SWING button”.

- “” is displayed on the LCD and the flaps will begin to swing.

2. When the flaps have reached the desired position, press “SWING button” once more.

- The flap will stop moving.
- “” disappears from the LCD.

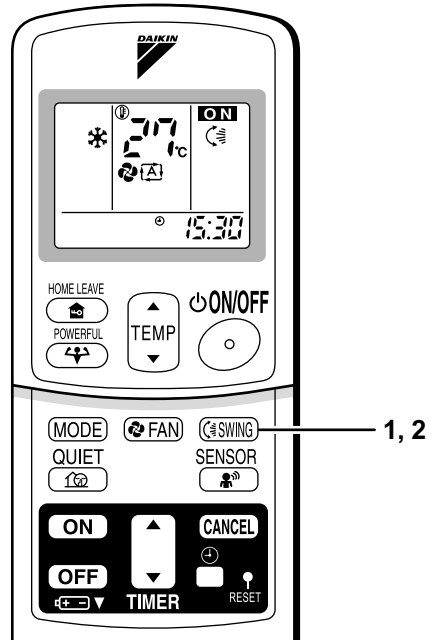

■ To adjust the vertical blades (louvers)

Hold the knob and move the louvers.

(You will find a knob on the left-side and the right-side blades.)

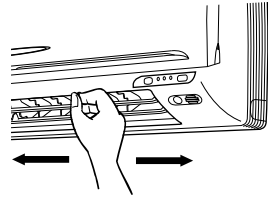

Notes on flaps and louvers angles.

- When “ **SWING button** ” is selected, the flaps swinging range depends on the operation mode. (See the figure.)

■ ATTENTION

- Always use a remote controller to adjust the flaps angle. If you attempt to move it forcibly with hand when it is swinging, the mechanism may be broken.
- Be careful when adjusting the louvers. Inside the air outlet, a fan is rotating at a high speed.

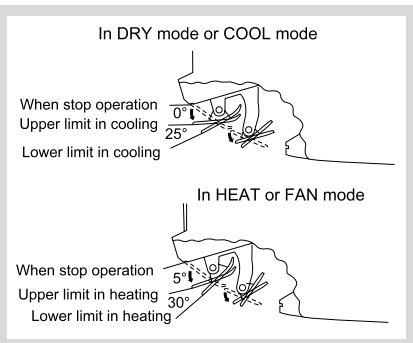

POWERFUL Operation

POWERFUL operation quickly maximizes the cooling (heating) effect in any operation mode. You can get the maximum capacity.

■ To start POWERFUL operation

1. Press “POWERFUL button”.

- POWERFUL operation ends in 20 minutes. Then the system automatically operates again with the settings which were used before POWERFUL operation.
- When using POWERFUL operation, there are some functions which are not available.
- “❄️” is displayed on the LCD.

■ To cancel POWERFUL operation

2. Press “POWERFUL button” again.

- “❄️” disappears from the LCD.

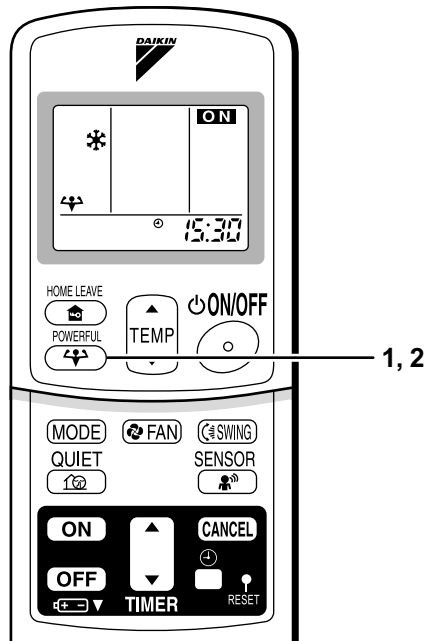

NOTE

■ Notes on POWERFUL operation

• In COOL and HEAT mode

To maximize the cooling (heating) effect, the capacity of outdoor unit must be increased and the air flow rate be fixed to the maximum setting. The temperature and air flow settings are not variable.

• In DRY mode

The temperature setting is lowered by 2.5°C and the air flow rate is slightly increased.

• In FAN mode

The air flow rate is fixed to the maximum setting.

• When using priority-room setting

See “Note for multi system” (page 22.)

OUTDOOR UNIT QUIET Operation

OUTDOOR UNIT QUIET operation lowers the noise level of the outdoor unit by changing the frequency and fan speed on the outdoor unit. This function is convenient during night.

■ To start OUTDOOR UNIT QUIET operation

1. Press “QUIET button”.

- “” is displayed on the LCD.

■ To cancel OUTDOOR UNIT QUIET operation

2. Press “QUIET button” again.

- “” disappears from the LCD.

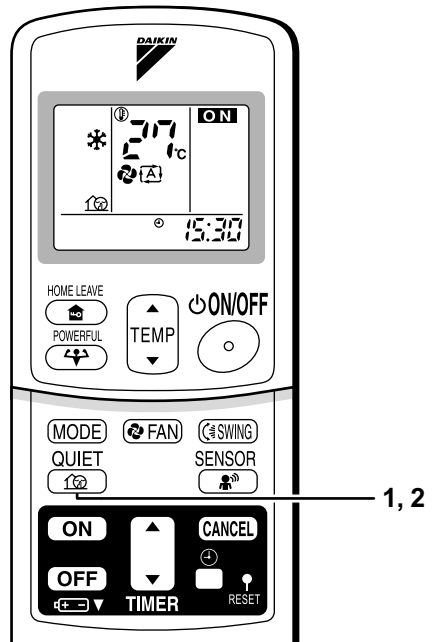

NOTE

■ Note on OUTDOOR UNIT QUIET operation

- If using a multi system, this function will work only when the OUTDOOR UNIT QUIET operation is set on all operated indoor units. However, if using priority-room setting, see “Note for multi system” (page 22.)
- This function is available in COOL, HEAT, and AUTO modes. (This is not available in FAN and DRY mode.)
- POWERFUL operation and OUTDOOR UNIT QUIET operation cannot be used at the same time. Priority is given to the function of whichever button is pressed last.
- If operation is stopped using the remote controller or the main unit ON/OFF switch when using OUTDOOR UNIT QUIET operation, “” will remain on the remote controller display.
- **This function does not work when connected to the RX(K)H20, 25, or 35CVMB.**

HOME LEAVE Operation

HOME LEAVE operation is a function which allows you to record your preferred temperature and air flow rate settings.

■ To start HOME LEAVE operation

1. Press “HOME LEAVE button” .

- “” is displayed on the LCD.
- The HOME LEAVE lamp lights up.

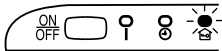

■ To cancel HOME LEAVE operation

2. Press “HOME LEAVE button” again.



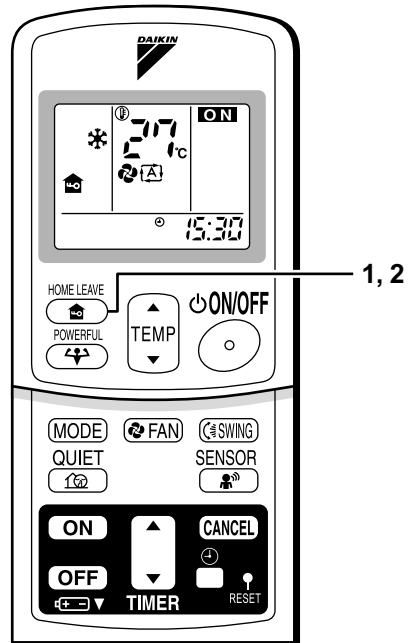



- “” disappears from the LCD.
- The HOME LEAVE lamp goes off.



Before using HOME LEAVE operation.

■ To set the temperature and air flow rate for HOME LEAVE operation

When using HOME LEAVE operation for the first time, please set the temperature and air flow rate for HOME LEAVE operation. Record your preferred temperature and air flow rate.

	Initial setting		Selectable range	
	temperature	Air flow rate	temperature	Air flow rate
Cooling	25°C	“  ”	18-32°C	5 step, “  ” and “  ”
Heating	25°C	“  ”	10-30°C	5 step, “  ” and “  ”

1. Press “HOME LEAVE button”. Make sure “” is displayed in the remote controller display.

2. Adjust the set temperature with “▲” or “▼” as you like.

3. Adjust the air flow rate with “FAN” setting button as you like.

Home leave operation will run with these settings the next time you use the unit. To change the recorded information, repeat steps 1 – 3.

■ What's the HOME LEAVE operation?

Is there a set temperature and air flow rate which is most comfortable, a set temperature and air flow rate which you use the most? HOME LEAVE operation is a function that allows you to record your favorite set temperature and air flow rate. You can start your favorite operation mode simply by pressing the HOME LEAVE button on the remote controller. This function is convenient in the following situations.

■ Useful in these cases

1. Use as an energy-saving mode.

Set the temperature 2-3°C higher (cooling) or lower (heating) than normal. Setting the fan strength to the lowest setting allows the unit to be used in energy-saving mode. Also convenient for use while you are out or sleeping.

• Every day before you leave the house...



When you go out, push the "HOME LEAVE Operation" button, and the air conditioner will adjust capacity to reach the preset temperature for HOME LEAVE Operation.



When you return, you will be welcomed by a comfortably air conditioned room.



Push the "HOME LEAVE Operation" button again, and the air conditioner will adjust capacity to the set temperature for normal operation.

• Before bed...



Set the unit to HOME LEAVE Operation before leaving the living room when going to bed.



The unit will maintain the temperature in the room at a comfortable level while you sleep.

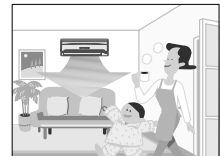

When you enter the living room in the morning, the temperature will be just right. Disengaging HOME LEAVE Operation will return the temperature to that set for normal operation. Even the coldest winters will pose no problem!

2. Use as a favorite mode.

Once you record the temperature and air flow rate settings you most often use, you can retrieve them by pressing HOME LEAVE button. You do not have to go through troublesome remote control operations.

NOTE

- Once the temperature and air flow rate for HOME LEAVE operation are set, those settings will be used whenever HOME LEAVE operation is used in the future. To change these settings, please refer to the "Before using HOME LEAVE operation" section above.
- HOME LEAVE operation is only available in COOL and HEAT mode. Cannot be used in AUTO, DRY, and FAN mode.
- HOME LEAVE operation runs in accordance with the previous operation mode (COOL or HEAT) before using HOME LEAVE operation.
- HOME LEAVE operation and POWERFUL operation cannot be used at the same time. Last button that was pressed has priority.
- The operation mode cannot be changed while HOME LEAVE operation is being used.
- When operation is shut off during HOME LEAVE operation, using the remote controller or the indoor unit ON/OFF switch, "🏠" will remain on the remote controller display.

INTELLIGENT EYE Operation

“INTELLIGENT EYE” is the infrared sensor which detects the human movement.

■ To start INTELLIGENT EYE operation

1. Press “SENSOR button”.
 - “” is displayed on the LCD.

■ To cancel the INTELLIGENT EYE operation

2. Press “SENSOR button” again.
 - “” disappears from the LCD.

[EX.]

When somebody in the room

- Normal operation



When nobody in the room

- 20 min. after, start energy saving operation.



Somebody back in the room

- Back to normal operation.

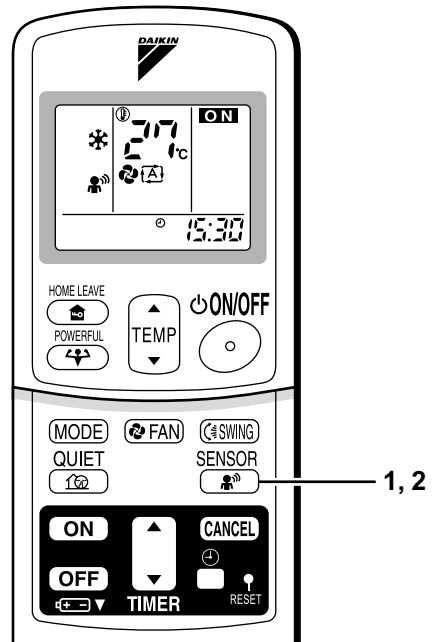

■ To adjust the angle of the INTELLIGENT EYE sensor

- You can adjust the angle of the INTELLIGENT EYE sensor to increase the detection area.
(Adjustable angle: 15° to right and left of centre)

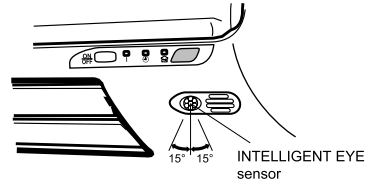

- Gently push and slide the sensor to adjust the angle.
- After adjusting the angle, wipe the sensor gently with a clean cloth, being careful not to scratch the sensor.

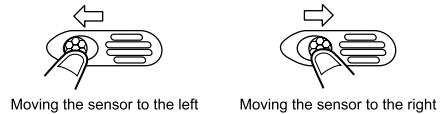

“INTELLIGENT EYE” is useful for Energy Saving.

■ Energy saving operation

- Change the temperature -2°C in heating / $+2^{\circ}\text{C}$ in cooling / $+1^{\circ}\text{C}$ in dry mode from set temperature.
- Decrease the air flow rate slightly in fan operation. (In FAN mode only)

Notes on “INTELLIGENT EYE”.

- Application range is as follows.

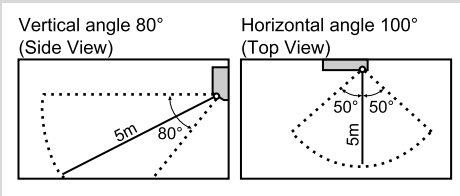

- Sensor may not detect moving objects further than 5m away. (Check the application range)
- Sensor detection sensitivity changes according to indoor unit location, the speed of passersby, temperature range, etc.
- The sensor also mistakenly detects pets, sunlight, fluttering curtains and light reflected off of mirrors as passersby.
- INTELLIGENT EYE operation will not go on during powerful operation.
- Night set mode (page 20.) will not go on during you use INTELLIGENT EYE operation.

⚠ CAUTION

- Do not place large objects near the sensor.
Also keep heating units or humidifiers outside the sensor's detection area. This sensor can detect objects it shouldn't as well as not detect objects it should.
- Do not hit or violently push the INTELLIGENT EYE sensor. This can lead to damage and malfunction.

TIMER Operation

Timer functions are useful for automatically switching the air conditioner on or off at night or in the morning. You can also use OFF TIMER and ON TIMER in combination.

■ To use OFF TIMER operation

- Check that the clock is correct.
If not, set the clock to the present time.
(page 9.)

1. Press “OFF TIMER button”.

0:00 is displayed.

⊕-⊖ blinks.

2. Press “TIMER Setting button” until the time setting reaches the point you like.

- Every pressing of either button increases or decreases the time setting by 10 minutes. Holding down either button changes the setting rapidly.

3. Press “OFF TIMER button” again.

- The TIMER lamp lights up.

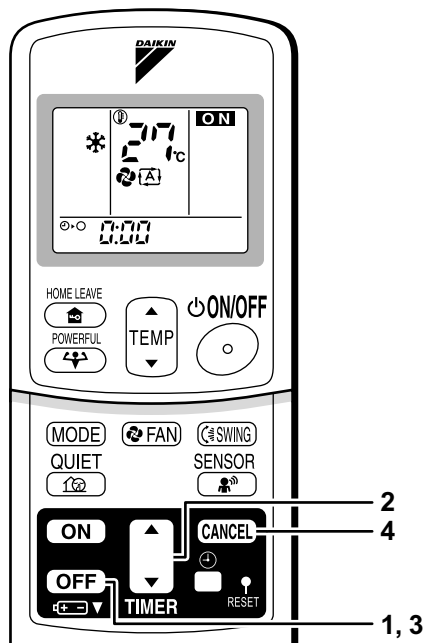
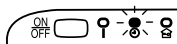

■ To cancel the OFF TIMER operation

4. Press “CANCEL button”.

- The TIMER lamp goes off.

NOTE

- When TIMER is set, the present time is not displayed.
- Once you set ON, OFF TIMER, the time setting is kept in the memory. (The memory is canceled when remote controller batteries are replaced.)
- When operating the unit via the ON/OFF Timer, the actual length of operation may vary from the time entered by the user.

■ NIGHT SET MODE

When the OFF TIMER is set, the air conditioner automatically adjusts the temperature setting (0.5°C up in COOL, 2.0°C down in HEAT) to prevent excessive cooling (heating) for your pleasant sleep.

■ To use ON TIMER operation

- Check that the clock is correct. If not, set the clock to the present time (page 9.).

1. Press “ON TIMER button”.

5:00 is displayed.

⊕-| blinks.

2. Press “TIMER Setting button” until the time setting reaches the point you like.

- Every pressing of either button increases or decreases the time setting by 10 minutes. Holding down either button changes the setting rapidly.

3. Press “ON TIMER button” again.

- The TIMER lamp lights up.

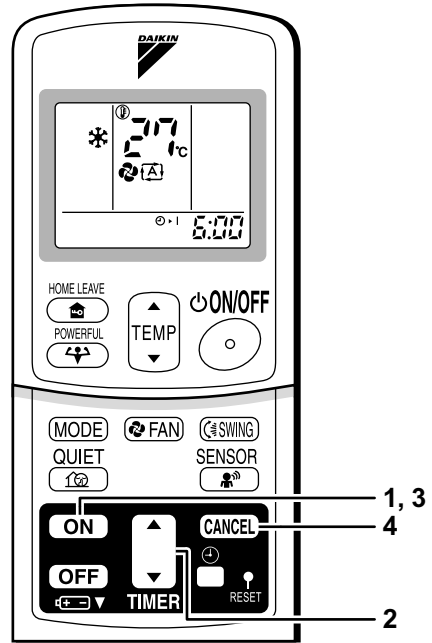
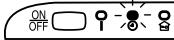

■ To cancel ON TIMER operation

4. Press “CANCEL button”.

- The TIMER lamp goes off.

■ To combine ON TIMER and OFF TIMER

- A sample setting for combining the two timers is shown below.

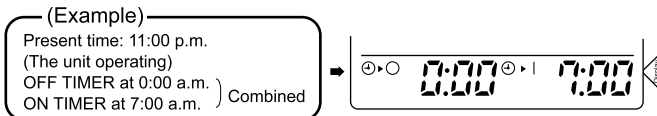

ATTENTION

■ In the following cases, set the timer again.

- After a breaker has turned OFF.
- After a power failure.
- After replacing batteries in the remote controller.

Note for Multi System

<< What is a “Multi System”? >>

This system has one outdoor unit connected to multiple indoor units.

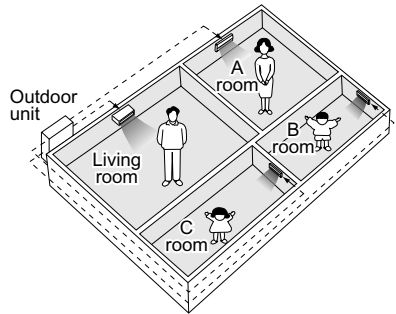

■ Selecting the Operation Mode

1. With the Priority Room Setting present but inactive or not present.

When more than one indoor unit is operating, priority is given to the first unit that was turned on.

In this case, set the units that are turned on later to the same operation mode (*1) as the first unit.

Otherwise, they will enter the Standby Mode, and the operation lamp will flash; this does not indicate malfunction.

(*1)

- COOL, DRY and FAN mode may be used at the same time.
- AUTO mode automatically selects COOL mode or HEAT mode based on the room temperature.
Therefore, AUTO mode is available when selecting the same operation mode as that of the room with the first unit to be turned on.

<CAUTION>

Normally, the operation mode in the room where the unit is first run is given priority, but the following situations are exceptions, so please keep this in mind.

If the operation mode of the first room is **FAN Mode**, then using **Heating Mode** in any room after this will give priority to **heating**. In this situation, the air conditioner running in FAN Mode will go on standby, and the operation lamp will flash.

2. With the Priority Room Setting active.

See “Priority Room Setting” on the next page.

■ NIGHT QUIET Mode (Available only for cooling operation)

NIGHT QUIET Mode requires initial programming during installation. Please consult your retailer or dealer for assistance. NIGHT QUIET Mode reduces the operation noise of the outdoor unit during the night time hours to prevent annoyance to neighbors.

- The NIGHT QUIET Mode is activated when the temperature drops 5°C or more below the highest temperature recorded that day. Therefore, when the temperature difference is less than 5°C, this function will not be activated.
- NIGHT QUIET Mode reduces slightly the cooling efficiency of the unit.

■ OUTDOOR UNIT QUIET Operation (page 15.)

1. With the Priority Room Setting present but inactive or not present.

When using the OUTDOOR UNIT QUIET operation feature with the Multi system, set all indoor units to OUTDOOR UNIT QUIET operation using their remote controllers.

When clearing OUTDOOR UNIT QUIET operation, clear one of the operating indoor units using their remote controller. However OUTDOOR UNIT QUIET operation display remains on the remote controller for other rooms. We recommend you release all rooms using their remote controllers.

2. With the Priority Room Setting active.

See “Priority Room Setting” on the next page.

■ Cooling / Heating Mode Lock (Available only for heat pump models)

The Cooling / Heating Mode Lock requires initial programming during installation. Please consult your retailer or dealer for assistance. The Cooling / Heating Mode Lock sets the unit forcibly to either Cooling or Heating Mode. This function is convenient when you wish to set all indoor units connected to the Multi system to the same operation mode.

■ Priority Room Setting

The Priority Room Setting requires initial programming during installation. Please consult your retailer or dealer for assistance.

The room designated as the Priority Room takes priority in the following situations;

1. Operation Mode Priority.

As the operation mode of the Priority Room takes precedence, the user can select a different operation mode from other rooms.

(Example)

* Room A is the Priority Room in the examples.

When COOL mode is selected in Room A while operating the following modes in Room B,C and D :

Operation mode in Room B, C and D	Status of Room B, C and D when the unit in Room A is in COOL mode
COOL or DRY or FAN	Current operation mode maintained
HEAT	The unit enters Standby Mode. Operation resumes when the Room A unit stops operating.
AUTO	If the unit is set to COOL mode, operation continues. If set to HEAT mode, it enters Standby Mode. Operation resumes when the Room A unit stops operating.

2. Priority when POWERFUL operation is used.

(Example)

* Room A is the Priority Room in the examples.

The indoor units in Rooms A,B,C and D are all operating. If the unit in Room A enters POWERFUL operation, operation capacity will be concentrated in Room A. In such a case, the cooling (heating) efficiency of the units in Rooms B,C and D may be slightly reduced.

3. Priority when using OUTDOOR UNIT QUIET operation.

(Example)

* Room A is the Priority Room in the examples.

Just by setting the unit in Room A to QUIET operation, the air conditioner starts OUTDOOR UNIT QUIET operation.

You don't have to set all the operated indoor units to QUIET operation.

Care and Cleaning



CAUTION Before cleaning, be sure to stop the operation and turn the breaker OFF.

Units

■ Indoor unit, Outdoor unit and Remote controller

1. Wipe them with dry soft cloth.

■ Front panel

1. Open the front panel.

- Hold the panel by the tabs on the two sides and lift it until it stops with a click.

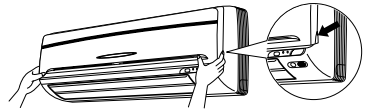

2. Remove the front panel.

- Supporting the front panel with one hand, release the lock by sliding down the knob with the other hand.
- To remove the front panel, pull it toward yourself with both hands.

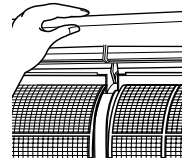

3. Clean the front panel.

- Wipe it with a soft cloth soaked in water.
- Only neutral detergent may be used.
- In case of washing the panel with water, dry it with cloth, dry it up in the shade after washing.

4. Attach the front panel.

- Set the 3 keys of the front panel into the slots and push them in all the way.
- Close the front panel slowly and push the panel at the 3 points.
(1 on each side and 1 in the middle.)
- Check to see if the rotating axis in the upper center section is moving.

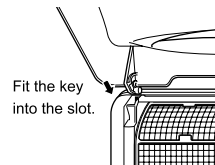

CAUTION

- Don't touch the metal parts of the indoor unit. If you touch those parts, this may cause an injury.
- When removing or attaching the front panel, use a robust and stable stool and watch your steps carefully.
- When removing or attaching the front panel, support the panel securely with hand to prevent it from falling.
- For cleaning, do not use hot water above 40°C, benzine, gasoline, thinner, nor other volatile oils, polishing compound, scrubbing brushes, nor other hand stuff.
- After cleaning, make sure that the front panel is securely fixed.

Filters

1. Open the front panel. (page 24.)

2. Pull out the air filters.

- Push a little upwards the tab at the center of each air filter, then pull it down.

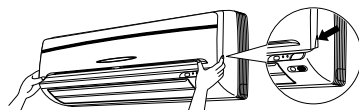

3. Take off the air purifying filter with photocatalytic deodorizing function.

- Hold the recessed parts of the frame and unhook the four claws.

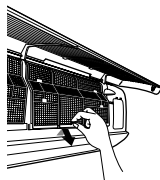

Air purifying filter with photocatalytic deodorizing function



4. Clean or replace each filter.

See figure.

5. Set the air filter and the air purifying filter with photocatalytic deodorizing function as they were and close the front panel.

- Insert claws of the filters into slots of the front panel. Close the front panel slowly and push the panel at the 3 points. (1 on each side and 1 in the middle.)

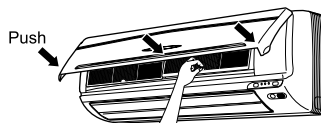

■ Air Filter

1. Wash the air filters with water or clean them with vacuum cleaner.

- If the dust does not come off easily, wash them with neutral detergent thinned with lukewarm water, then dry them up in the shade.
- It is recommended to clean the air filters every two weeks.

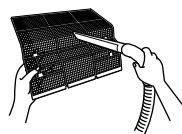

■ Air purifying filter with photocatalytic deodorizing function. (gray)

The Air purifying filter with photocatalytic deodorizing function can be renewed by washing it with water once every 6 months. We recommend replacing it once every 3 years.

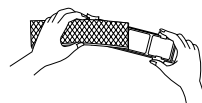

[Maintenance]

1. Remove dust with a vacuum cleaner and wash lightly with water.
2. If it is very dirty, soak it for 10 to 15 minutes in water mixed with a neutral cleaning agent.
3. Do not remove filter from frame when washing with water.
4. After washing, shake off remaining water and dry in the shade.
5. Since the material is made out of paper, do not wring out the filter when removing water from it.

[Replacement]

1. Remove the tabs on the filter frame and replace with a new filter.
 - Dispose of the old filter as flammable waste.

Check

Check that the base, stand and other fittings of the outdoor unit are not decayed or corroded.
Check that nothing blocks the air inlets and the outlets of the indoor unit and the outdoor unit.
Check that the drain comes smoothly out of the drain hose during COOL or DRY operation. <ul style="list-style-type: none">• If no drain water is seen, water may be leaking from the indoor unit. Stop operation and consult the service shop if this is the case.

■ Before a long idle period

- 1. Operate the “FAN only” for several hours on a fine day to dry out the inside.**
 - Press “MODE” button and select “FAN” operation.
 - Press “ON/OFF” button and start operation.
- 2. After operation stops, turn off the breaker for the room air conditioner.**
- 3. Clean the air filters and set them again.**
- 4. Take out batteries from the remote controller.**
 - When a multi outdoor unit is connected, make sure the heating operation is not used at the other room before you use the fan operation. (page 22.)

NOTE

- Operation with dirty filters:
 - (1) cannot deodorize the air.
 - (2) cannot clean the air.
 - (3) results in poor heating or cooling.
 - (4) may cause odour.
- To order air purifying filter with photocatalytic deodorizing function contact to the service shop there you bought the air conditioner.
- Dispose of old filters as burnable waste.

Item	Part No.
Air purifying filter with photocatalytic deodorizing function. (with frame) 1 set	KAF918A43
Air purifying filter with photocatalytic deodorizing function. (without frame) 1 set	KAF918A44

Trouble Shooting

These cases are not troubles.

The following cases are not air conditioner troubles but have some reasons. You may just continue using it.

Case	Explanation
Operation does not start soon. <ul style="list-style-type: none"> When ON/OFF button was pressed soon after operation was stopped. When the mode was reselected. 	<ul style="list-style-type: none"> This is to protect the air conditioner. You should wait for about 3 minutes.
Hot air does not flow out soon after the start of heating operation.	<ul style="list-style-type: none"> The air conditioner is warming up. You should wait for 1 to 4 minutes. (The system is designed to start discharging air only after it has reached a certain temperature.)
The heating operation stops suddenly and a flowing sound is heard.	<ul style="list-style-type: none"> The system is taking away the frost on the outdoor unit. You should wait for about 3 to 8 minutes.
The outdoor unit emits water or steam.	<ul style="list-style-type: none"> In HEAT mode <ul style="list-style-type: none"> The frost on the outdoor unit melts into water or steam when the air conditioner is in defrost operation. In COOL or DRY mode <ul style="list-style-type: none"> Moisture in the air condenses into water on the cool surface of outdoor unit piping and drips.
Mist comes out of the indoor unit.	<ul style="list-style-type: none"> This happens when the air in the room is cooled into mist by the cold air flow during cooling operation.
The indoor unit gives out odour.	<ul style="list-style-type: none"> This happens when smells of the room, furniture, or cigarettes are absorbed into the unit and discharged with the air flow. (If this happens, we recommend you to have the indoor unit washed by a technician. Consult the service shop where you bought the air conditioner.)
The outdoor fan rotates while the air conditioner is not in operation.	<ul style="list-style-type: none"> After operation is stopped: <ul style="list-style-type: none"> The outdoor fan continues rotating for another 60 seconds for system protection. While the air conditioner is not in operation: <ul style="list-style-type: none"> When the outdoor temperature is very high, the outdoor fan starts rotating for system protection.
The operation stopped suddenly. (OPERATION lamp is on.)	<ul style="list-style-type: none"> For system protection, the air conditioner may stop operating on a sudden large voltage fluctuation. It automatically resumes operation in about 3 minutes.

Check again.

Please check again before calling a repair person.

Case	Check
<p>The air conditioner does not operate. (OPERATION lamp is off.)</p>	<ul style="list-style-type: none"> • Hasn't a breaker turned OFF or a fuse blown? • Isn't it a power failure? • Are batteries set in the remote controller? • Is the timer setting correct?
<p>Cooling (Heating) effect is poor.</p>	<ul style="list-style-type: none"> • Are the air filters clean? • Is there anything to block the air inlet or the outlet of the indoor and the outdoor units? • Is the temperature setting appropriate? • Are the windows and doors closed? • Are the air flow rate and the air direction set appropriately? • Is the unit set to the INTELLIGENT EYE mode? (page 18.)
<p>Operation stops suddenly. (OPERATION lamp flashes.)</p>	<ul style="list-style-type: none"> • Are the air filters clean? • Is there anything to block the air inlet or the outlet of the indoor and the outdoor units? Clean the air filters or take all obstacles away and turn the breaker OFF. Then turn it ON again and try operating the air conditioner with the remote controller. If the lamp still flashes, call the service shop where you bought the air conditioner. • Are operation modes all the same for indoor units connected to outdoor units in the multi system? If not, set all indoor units to the same operation mode and confirm that the lamps flash. Moreover, when the operation mode is in "AUTO", set all indoor unit operation modes to "COOL" or "HEAT" for a moment and check again that the lamps are normal. If the lamps stop flashing after the above steps, there is no malfunction. (page 22.)
<p>An abnormal functioning happens during operation.</p>	<ul style="list-style-type: none"> • The air conditioner may malfunction with lightning or radio waves. Turn the breaker OFF, turn it ON again and try operating the air conditioner with the remote controller.

Call the service shop immediately.

WARNING

- When an abnormality (such as a burning smell) occurs, stop operation and turn the breaker OFF.
Continued operation in an abnormal condition may result in troubles, electric shocks or fire.
Consult the service shop where you bought the air conditioner.
- Do not attempt to repair or modify the air conditioner by yourself.
Incorrect work may result in electric shocks or fire.
Consult the service shop where you bought the air conditioner.

If one of the following symptoms takes place, call the service shop immediately.

- The power cord is abnormally hot or damaged.
- An abnormal sound is heard during operation.
- The safety breaker, a fuse, or the earth leakage breaker cuts off the operation frequently.
- A switch or a button often fails to work properly.
- There is a burning smell.
- Water leaks from the indoor unit.

Turn the breaker OFF and call the service shop.

■ After a power failure

The air conditioner automatically resumes operation in about 3 minutes. You should just wait for a while.

■ Lightning

If lightning may strike the neighbouring area, stop operation and turn the breaker OFF for system protection.

Disposal requirements

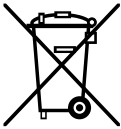

Your air conditioning product is marked with this symbol. This means that electrical and electronic products shall not be mixed with unsorted household waste.

Do not try to dismantle the system yourself: the dismantling of the air conditioning system, treatment of the refrigerant, of oil and of other parts must be done by a qualified installer in accordance with relevant local and national legislation.

Air conditioners must be treated at a specialized treatment facility for re-use, recycling and recovery. By ensuring this product is disposed of correctly, you will help to prevent potential negative consequences for the environment and human health. Please contact the installer or local authority for more information.

Batteries must be removed from the remote controller and disposed of separately in accordance with relevant local and national legislation.

We recommend periodical maintenance.

In certain operating conditions, the inside of the air conditioner may get foul after several seasons of use, resulting in poor performance. It is recommended to have periodical maintenance by a specialist aside from regular cleaning by the user. For specialist maintenance, contact the service shop where you bought the air conditioner. The maintenance cost must be born by the user.

Important information regarding the refrigerant used.

This product contains fluorinated greenhouse gases covered by the Kyoto Protocol.

Refrigerant type: **R410A**

GWP⁽¹⁾ value: **1975**

⁽¹⁾ GWP = global warming potential

Periodical inspections for refrigerant leaks may be required depending on European or local legislation. Please contact your local dealer for more information.

Fault diagnosis.

FAULT DIAGNOSIS BY REMOTE CONTROLLER

In the ARC433 series, the temperature display sections on the main unit indicate corresponding codes.

1. When the **TIMER CANCEL** button is held down for 5 seconds, a “00” indication flashes on the temperature display section.

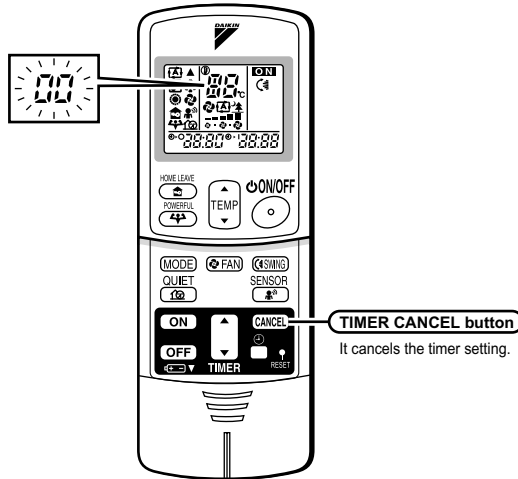

2. Press the **TIMER CANCEL** button repeatedly until a continuous beep is produced.

- The code indication changes as shown below, and notifies with a long beep.

	CODE	MEANING
SYSTEM	00	NORMAL
	U0	REFRIGERANT SHORTAGE
	U2	DROP VOLTAGE OR MAIN CIRCUIT OVERVOLTAGE
	U4	FAILURE OF TRANSMISSION (BETWEEN INDOOR UNIT AND OUTDOOR UNIT)
INDOOR UNIT	A1	INDOOR PCB DEFECTIVENESS
	A5	HIGH PRESSURE CONTROL OR FREEZE-UP PROTECTOR
	A6	FAN MOTOR FAULT
	C4	FAULTY HEAT EXCHANGER TEMPERATURE SENSOR
	C9	FAULTY SUCTION AIR TEMPERATURE SENSOR
OUTDOOR UNIT	EA	COOLING-HEATING SWITCHING ERROR
	E5	OL STARTED
	E6	FAULTY COMPRESSOR START UP
	E7	DC FAN MOTOR FAULT
	E8	OPERATION HALT DUE TO DETECTION OF INPUT OVER CURRENT
	F3	HIGH TEMPERATURE DISCHARGE PIPE CONTROL
	F6	HIGH PRESSURE CONTROL (IN COOLING)
	H6	OPERATION HALT DUE TO FAULTY POSITION DETECTION SENSOR
	H8	CT ABNORMALITY
	H9	FAULTY SUCTION AIR TEMPERATURE SENSOR
	J3	FAULTY DISCHARGE PIPE TEMPERATURE SENSOR
	J6	FAULTY HEAT EXCHANGER TEMPERATURE SENSOR
	L4	HIGH TEMPERATURE AT INVERTER CIRCUIT HEATSINK
	L5	OUTPUT OVERCURRENT
P4	FAULTY INVERTER CIRCUIT HEATSINK TEMPERATURE SENSOR	

NOTE

1. A short beep and two consecutive beeps indicate non-corresponding codes.
2. To cancel the code display, hold the **TIMER CANCEL** button down for 5 seconds. The code display also cancel itself if the button is not pressed for 1 minute.

LED ON OUTDOOR UNIT PCB 2MXS, 3MXS, 3MKS, 4MXS, 4MKS, 5MXS, 5MKS series

GREEN	RED					DIAGNOSIS
MICROCOMPUTER NORMAL	MALFUNCTION DETECTION					
LED-A	LED1	LED2	LED3	LED4	LED5	
●	●	●	●	●	●	NORMAL → CHECK INDOOR UNIT
⚡	⚡	●	⚡	⚡	●	HIGH PRESSURE PROTECTOR WORKED OR FREEZE-UP IN OPERATING UNIT OR STAND-BY UNIT
⚡	⚡	●	⚡	●	●	* OVERLOAD RELAY WORKED OR HIGH DISCHARGE PIPE TEMPERATURE
⚡	●	⚡	⚡	●	●	FAULTY COMPRESSOR START
⚡	●	⚡	●	⚡	●	INPUT OVERCURRENT
⚡	⚡	⚡	●	●	●	* THERMISTOR OR CT ABNORMALITY
⚡	⚡	⚡	●	⚡	●	HIGH TEMPERATURE SWITCHBOX
⚡	●	●	●	⚡	●	HIGH TEMPERATURE AT INVERTER CIRCUIT HEATSINK
⚡	●	●	⚡	●	●	* OUTPUT OVERCURRENT
⚡	●	●	⚡	⚡	●	* REFRIGERANT SHORTAGE
⚡	⚡	●	●	⚡	●	LOW VOLTAGE TO MAIN CIRCUIT OR MOMENTARY VOLTAGE LOSS
⚡	⚡	●	●	●	●	REVERSING SOLENOID VALVE SWITCHING FAILURE
⚡	⚡	⚡	⚡	●	●	FAN MOTOR FAULT
⚡	–	–	–	–	●	[NOTE 1]
●	–	–	–	–	●	POWER SUPPLY FAULT OR [NOTE 2]

NOTE: The LED5 is only available in the 5M Series.

GREEN	NORMALLY FLASHING
RED	NORMALLY OFF
⚡	ON
⚡	FLASHING
●	OFF
–	IRRELEVANT

LED ON OUTDOOR UNIT PCB 2MXS, 2MKS series

GREEN	DIAGNOSIS
MICROCOMPUTER NORMAL	
LED-A	
⚡	NORMAL → CHECK INDOOR UNIT
⚡	[NOTE 1]
●	POWER SUPPLY FAULT OR [NOTE 2]

GREEN	NORMALLY FLASHING
⚡	ON
⚡	FLASHING
●	OFF

NOTE

1. Turn the power off and then on again. If the LED display recurs, the outdoor unit PCB is faulty.
2. Diagnosis marked
 - * Do not apply to some cases. For details, refer to the service guide.

MEMO



DAIKIN INDUSTRIES, LTD.

Head office:
Umeda Center Bldg., 2-4-12, Nakazaki-Nishi,
Kita-ku, Osaka, 530-8323 Japan

Tokyo office:
JR Shinagawa East Bldg., 2-18-1, Konan,
Minato-ku, Tokyo, 108-0075 Japan
<http://www.daikin.com/global/>

DAIKIN EUROPE NV

Zandvoordestraat 300, B-8400 Oostende, Belgium



Two-dimensional bar code is a code
for manufacturing.

3P194444-1B M06B200B (0704) HT