

DAIKIN

INSTALLATION MANUAL

R410A Split Series

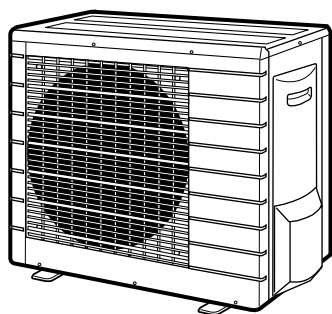

Models

RXS50K2V1B

RXS60F4V1B

RXG50K3V1B

RX50G3V1B

RX60G3V1B

ARXS50G3V1B

Installation manual
R410A Split series

English

Installationsanleitung
Split-Baureihe R410A

Deutsch

Manuel d'installation
Série split R410A

Français

Montagehandleiding
R410A Split-systeem

Nederlands

Manual de instalación
Serie Split R410A

Español

Manuale d'installazione
Serie Multiambienti R410A

Italiano

Εγχειρίδιο εγκατάστασης
διαιρούμενης σειράς R410A

Ελληνικά

Manual de Instalação
Série split R410A

Portugues

Руководство по монтажу
Серия R410A с отдельной установкой

Русский

Montaj kılavuzları
R410A Split serisi

Türkçe

CE - DECLARATION-OF-COMFORMITY
CE - KONFORMITÄTSERKLÄRUNG
CE - DECLARATION-DE-CONFORMITE
CE - CONFORMITEITSVERKLARING

Daikin Industries Czech Republic s.r.o.

- 01 (EN) declares under its sole responsibility that the air conditioning models to which this declaration relates;
- 02 (E) erklart på sinne aleneleg Verantwortung daß de Modelle der Klimageräte für die diese Erklärung bestimmt ist;
- 03 (E) déclare sous sa seule responsabilité que les appareils d'air conditionné visés par la présente déclaration;
- 04 (NL) verklaart hierbij op eigen exclusieve verantwoordelijkheid dat de airconditioning units waarop deze verklaring betrekking heeft;
- 05 (E) declara bajo su única responsabilidad que los modelos de aire acondicionado a los cuales hace referencia la declaración;
- 06 (C) dichiara sotto sua responsabilità che i condizionatori modello a cui è riferita questa dichiarazione;
- 07 (EN) δηλώνει με αποκλειστική της ευθύνη ότι τα μοντέλα των κλιματιστικών συσκευών στα οποία αναφέρεται η παρούσα δήλωση;
- 08 (E) declara sob sua exclusiva responsabilidade que os modelos de ar condicionado a que esta declaração se refere.

RXG50K3V1B, RXS50K2V1B, RXS60F4V1B, RXS60G3V1B, RXG60G3V1B, RXS60G3V1B, ARXS50G3V1B

- 01 are in conformity with the following standard(s) or other normative document(s), provided that these are used in accordance with our instructions;
- 02 (den) folgenden Norm(en) oder einem anderen Normdokument oder -dokumenten entspricht/sprechen, unter der Voraussetzung, daß sie gemäß unseren Anweisungen eingesetzt werden;
- 03 sont conformes à la(s) norm(e)(s) ou autre(s) document(s) normatif(s), pour autant qu'ils soient utilisés conformément à nos instructions;
- 04 conform de volgend(e) norm(en) of één of meer andere bindende documenten zijn, op voorwaarde dat ze worden gebruikt overeenkomstig onze instructies;
- 05 están en conformidad con la(s) siguiente(s) norma(s) u otro(s) documento(s) normativo(s), siempre que sean utilizados de acuerdo con nuestras instrucciones;
- 06 sono conformi all(i) seguente(s) standard(i) o altro(i) documento(i) a carattere normativo, a patto che vengano usati in conformità alle nostre istruzioni;
- 07 (E) (E) δηλώνει ότι το(ι) ακόλουθ(ο) (ή) το(ί) άλλο(ί) πρότυπο(ί) (ή) κανονισμοί, υπό την προϋπόθεση ότι χρησιμοποιούνται σύμφωνα με τις οδηγίες μας;
- 08 underlagt följande standard(er) eller andra tekniska dokument(er), förutsatt att dessa användes i henom till våra instruktioner;
- 09 соответствует следующим стандартам или другим нормативным документам, при условии их использования согласно нашим инструкциям;
- 10 underlagt følgende standard(er) eller andre tekniske dokument(er), forudsat at disse anvendes i henhold til vore instruktioner;
- 11 respektive utrustning är utförd i överensstämmelse med och följer följande standard(er) eller andra normgivande dokument, under förutsättning att anvisning sieri i överensstämmelse med våra instruktioner;
- 12 respektive uskyeri i overensstemmelse med følgende standard(er) eller andre normgivende dokument(er), under forudsætning af at disse bruges i henhold til vore instruktioner;
- 13 vastavaat seuraavien standardien ja muiden ohjeellisten dokumenttien vaatimuksia edellyttäen, että niitä käytetään ohjeidemme mukaisesti;
- 14 za preporočaku, že jsou využívány v souladu s našimi pokyny, odpovídají následujícím normám nebo normativním dokumentům;
- 15 v skladu sa sledječi standardom(i) ali drugim normativnim dokumentom(i)ma, ul vzjet da se so konreste u skladu s našim uputama;
- 16 ob uporabljanju dobrič;
- 17 enligt vilkoren i;
- 18 ob upotrebljavanju dobrič;
- 19 ob upotrebljavanju dobrič;
- 20 vastavati näidele;
- 21 seuraavaksi kraavarena ha;
- 22 teknisten vaatimusten mukaisesti;
- 23 teknisten vaatimusten mukaisesti;
- 24 odzhanajuci ustanovien;
- 25 bunun kulluamaa vuyun otarak;
- 16 (K) (E) δηλώνει ότι το(ι) ακόλουθ(ο) (ή) το(ί) άλλο(ί) πρότυπο(ί) (ή) κανονισμοί, υπό την προϋπόθεση ότι χρησιμοποιούνται σύμφωνα με τις οδηγίες μας;
- 17 zgodnie z postanowieniami Dyrektyw;
- 18 in urma prevederilor;
- 06 Nota * as set in <A> and judged positively by
- 07 (E) (E) δηλώνει ότι το(ι) ακόλουθ(ο) (ή) το(ί) άλλο(ί) πρότυπο(ί) (ή) κανονισμοί, υπό την προϋπόθεση ότι χρησιμοποιούνται σύμφωνα με τις οδηγίες μας;
- 08 Nota * as set in <A> and judged positively by
- 09 (E) (E) δηλώνει ότι το(ι) ακόλουθ(ο) (ή) το(ί) άλλο(ί) πρότυπο(ί) (ή) κανονισμοί, υπό την προϋπόθεση ότι χρησιμοποιούνται σύμφωνα με τις οδηγίες μας;
- 10 Bemærk * as set in <A> and judged positively by

CE - DECLARACION-DE-CONFORMIDAD
CE - ЗАЯВЛЕНИЕ-О-СОТВЕТСТВИИ
CE - OVERENSTEMMELSESERKLÆRING
CE - FÖRSÄKRAN-OM-ÖVERENSSTÄMMELSE

CE - IZJAVA-O-USKLABENOSTI
CE - MEGFELELŐSÉG-NYILATKOZAT
CE - DEKLARACJA-ZGODNOSCI
CE - DECLARAȚIE-DE-CONFORMITATE

- 09 (EN) заявляет, исключительно под свою ответственность, что модели кондиционеров воздуха, к которым относится настоящее заявление;
- 10 (E) erklærer under ens ansvar, at klimaanlægsmødelerne, som denne deklaration inderbær att;
- 11 (S) deklarerar i egen ansvar, att luftkonditioneringsmodellerna som betörs av denna deklaration inderbär att;
- 12 (N) erklærer et fuldstændigt ansvar for at de luftkonditioneringsmodeller som berøres af denne deklaration, inderbærer at;
- 13 (NL) imoliekt vastanoorn omalla vastuullaan, että tämän ilmastuksen laitteiden mallit vastuullaan on ollut valmistajalla;
- 14 (CZ) prohlašuje ve své plné odpovědnosti, že modely klimatizace k nimž se toto prohlášení vztahuje;
- 15 (HR) izjavljuje pod isključivo vlastitom odgovornošću da su modeli klima uređaja na koje se ova izjava odnosi;
- 16 (H) teljes felelősség tudatában kijelenti, hogy a klimatizációs modellek, melyekre a nyilatkozati vonatkozik;
- 17 (NL) deklarie na värsna, lyvärsäzua oöppövelänsö, že modelé klimatezatorov, ktoýmí odovzucä nimejsza deklaraaja;
- 18 (E) deklari på sinne aleneleg ansvar, at de modeller af klimaanlæg, som denne erklæring inderbærer;
- 19 (E) deklariar sob sua exclusiva responsabilidade, que os modelos de climatizadores de ar condicionado, a que esta declaração se refere;
- 20 (E) deklariar sob sua exclusiva responsabilidade, que os modelos de climatizadores de ar condicionado, a que esta declaração se refere;
- 21 (E) deklariar sob sua exclusiva responsabilidade, que os modelos de climatizadores de ar condicionado, a que esta declaração se refere;
- 22 (E) deklariar sob sua exclusiva responsabilidade, que os modelos de climatizadores de ar condicionado, a que esta declaração se refere;
- 23 (E) deklariar sob sua exclusiva responsabilidade, que os modelos de climatizadores de ar condicionado, a que esta declaração se refere;
- 24 (E) deklariar sob sua exclusiva responsabilidade, que os modelos de climatizadores de ar condicionado, a que esta declaração se refere;
- 25 (E) deklariar sob sua exclusiva responsabilidade, que os modelos de climatizadores de ar condicionado, a que esta declaração se refere;

- 08 estão em conformidade com a(s) seguinte(s) norma(s) ou outro(s) documento(s) normativo(s), desde que estes sejam utilizados de acordo com as nossas instruções;
- 09 соответствует следующим стандартам или другим нормативным документам, при условии их использования согласно нашим инструкциям;
- 10 overholder følgende standard(er) eller andre tekniske dokument(er), forudsat at disse anvendes i henhold til vore instruktioner;
- 11 respektive utrustning är utförd i överensstämmelse med och följer följande standard(er) eller andra normgivande dokument, under förutsättning att anvisning sieri i överensstämmelse med våra instruktioner;
- 12 respektive uskyeri i overensstemmelse med følgende standard(er) eller andre normgivende dokument(er), under forudsætning af at disse bruges i henhold til vore instruktioner;
- 13 vastavaat seuraavien standardien ja muiden ohjeellisten dokumenttien vaatimuksia edellyttäen, että niitä käytetään ohjeidemme mukaisesti;
- 14 za preporočaku, že jsou využívány v souladu s našimi pokyny, odpovídají následujícím normám nebo normativním dokumentům;
- 15 v skladu sa sledječi standardom(i) ali drugim normativnim dokumentom(i)ma, ul vzjet da se so konreste u skladu s našim uputama;
- 16 Megjuzytés * a(z) <A> alapján, a(z) igazolja a megjelölt, <C> tanúsítvány szerint;
- 17 Uwaga * zgodnie z dokumentacją <A> pozytywny opinię świadectwem <C>;
- 18 Nota * asa cum este stabilit în <A> și arecaut pozitiv în în conformitate cu Certificatul <C>;
- 19 Opomba * kol je določeno v <A> v pozitivni zjeto v skladu s certifikatom <C>;
- 20 Mærkus * ragu on národní dokumentis <A> je heals kildet jatu vestanatt sertifikaadit <C>;
- 21 Information * enigt <A> och godkänns av enligt Certificat <C>;
- 22 Merk * som det fremkommer i <A> og gennem positiv beendelse av ifølge Certificat <C>;
- 23 Huom * jotta on esitetty asiakkasra <A> ja jotta on hyväksynyt Sertifikaatin <C> mukaisesti;
- 24 Poznámka * jak bylo uvedeno v <A> v pozitivně zjeto v souladu s certifikátem <C>;
- 25 Napomena * kako je izloženo u <A> pozitivno ocijeneno od strane prema Certificatu <C>;
- 16 Megjuzytés * a(z) <A> alapján, a(z) igazolja a megjelölt, <C> tanúsítvány szerint;
- 17 Uwaga * zgodnie z dokumentacją <A> pozytywny opinię świadectwem <C>;
- 18 Nota * asa cum este stabilit în <A> și arecaut pozitiv în în conformitate cu Certificatul <C>;
- 19 Opomba * kol je določeno v <A> v pozitivni zjeto v skladu s certifikatom <C>;
- 20 Mærkus * ragu on národní dokumentis <A> je heals kildet jatu vestanatt sertifikaadit <C>;
- 21 Zabeleška * kako je kazano v <A> i ooreno pozitivno ooreno o ooreno o Certificatu <C>;
- 22 Pasaba * kap nasledja <A> i kap bigana mispreja paga Sertifikaat <C>;
- 23 Pozimas * kap naradits <A> an abisits pozitivam veřejam sasajia ar sertifikatu <C>;
- 24 Poznámka * ako bolo uvedené v <A> v pozitive zistené v súlade s overšedním <C>;
- 25 Not * ragu on národní dokumentis <A> je heals kildet jatu vestanatt sertifikaadit <C>;

Low Voltage 2006/95/EC Machinery 2006/42/EC Electromagnetic Compatibility 2004/108/EC

- 01 Directives, as amended;
- 02 Direktiven, gemäß Änderung;
- 03 Directives, telles que modifiées;
- 04 Richtlijnen, zoals gearmderd;
- 05 Directivas, según lo emendado;
- 06 Directive, come da modifica;
- 07 Obyňuv, omusřovův pomotořebí;
- 08 Direktivel, conforme aleoraãri em;
- 09 Dyrskiva, ot vsemi popravamni;
- 10 Direktive, med senere ændringer;
- 11 Direktiv, med foretagne ændringer;
- 12 Direktiver, med foretagne ændringer;
- 13 Direktiveja, selajna kun ne ovat mueltuina;
- 14 v platném znění;
- 15 Snjmenica, kako je izmjenjeno;
- 16 řáňuv, omusřovův pomotořebí;
- 17 z poznejšimi popravkami;
- 18 Direktivel, ot vsemi popravamni;
- 19 Direktive, med senere ændringer;
- 20 Direktiv, med foretagne ændringer;
- 21 Директиви, с ревіре змєненєня;
- 22 Direktiveja, selajna kun ne ovat mueltuina;
- 23 Direktivas, según lo emendado;
- 24 Snjmenica, kako je izmjenjeno;
- 25 Degřšřimš řahelnye řoremeliker;

CE - ATTIKTES-DEKLARACIA
CE - ATBILSTĀBAS-DEKLARACIA
CE - VĀSTĀVUSDEKLARACIJA
CE - DEKLARACIJA-ZA-CЪОТВѢТСТВІЕ
CE - UYUMULULUK-BİLDİRİSİ

CE - IZJAVA O SKLADNOSTI
CE - VĀSTĀVUSDEKLARACIJA
CE - VĀSTĀVUSDEKLARACIJA
CE - DEKLARACIJA-ZA-CЪОТВѢТСТВІЕ
CE - UYUMULULUK-BİLDİRİSİ

- 17 (NL) deklarie na värsna, lyvärsäzua oöppövelänsö, že modelé klimatezatorov, ktoýmí odovzucä nimejsza deklaraaja;
- 18 (E) deklari på sinne aleneleg ansvar, at de modeller af klimaanlæg, som denne erklæring inderbærer;
- 19 (E) deklariar sob sua exclusiva responsabilidade, que os modelos de climatizadores de ar condicionado, a que esta declaração se refere;
- 20 (E) deklariar sob sua exclusiva responsabilidade, que os modelos de climatizadores de ar condicionado, a que esta declaração se refere;
- 21 (E) deklariar sob sua exclusiva responsabilidade, que os modelos de climatizadores de ar condicionado, a que esta declaração se refere;
- 22 (E) deklariar sob sua exclusiva responsabilidade, que os modelos de climatizadores de ar condicionado, a que esta declaração se refere;
- 23 (E) deklariar sob sua exclusiva responsabilidade, que os modelos de climatizadores de ar condicionado, a que esta declaração se refere;
- 24 (E) deklariar sob sua exclusiva responsabilidade, que os modelos de climatizadores de ar condicionado, a que esta declaração se refere;
- 25 (E) deklariar sob sua exclusiva responsabilidade, que os modelos de climatizadores de ar condicionado, a que esta declaração se refere;

- 16 megjelöltek az alábbi szabvány(ok)nak vagy egyéb irányadó dokumentum(ok)nak, ha azokat előírás szerint használják;
- 17 megfelelnek a vonatkozó szabvány(ok)nak vagy egyéb irányadó dokumentum(ok)nak, ha azokat előírás szerint használják;
- 18 sunt în conformitate cu următorul (urmatoarele) standard(e) sau alte (documente) normative), cu condiția ca acestea să fie utilizate în conformitate cu instrucțiunile noastre;
- 19 skladni z naslednjimi standardi in drugim normativnim dokumentom(i), ki ne kasirabes v skladu z našimi navodili;
- 20 on vastavus järgmistele standard(ide)le või teiste normatiivse dokumentidega, kui need kasutatakse vastavalt meie juhenditele;
- 21 соответствует на следующие стандарты или другие нормативные документы, при условии, что они используются в соответствии с нашими инструкциями;
- 22 allinka žemai numořyus standartus (arba) kitus norminius dokumentus su sąlyga, kad yra naudojami pagal mūsų nurodymus;
- 23 tad, je tebtu atbistis ražajajia noradjumien, atbisi sekjostien standartin en citien normatiivn dokumentimien;
- 24 su v žibde z nastebovny(m) normojam(i) alebo řym(i) normativnym(i) dokumentom(i)am(i), za predpokladu, že sa používajú v súlade s našimi návodmi;
- 25 řinun, taimatarmizra gure kulanimas kospuljaja asğojajia standartar te norm beifiten beğerele uyumludur;

- 19 Direktive, med senere ændringer;
- 20 Direktiv, med foretagne ændringer;
- 21 Директиви, с ревіре змєненєня;
- 22 Direktiveja, selajna kun ne ovat mueltuina;
- 23 Direktivas, según lo emendado;
- 24 Snjmenica, kako je izmjenjeno;
- 25 Degřšřimš řahelnye řoremeliker;
- 19 Direktive, med senere ændringer;
- 20 Direktiv, med foretagne ændringer;
- 21 Директиви, с ревіре змєненєня;
- 22 Direktiveja, selajna kun ne ovat mueltuina;
- 23 Direktivas, según lo emendado;
- 24 Snjmenica, kako je izmjenjeno;
- 25 Degřšřimš řahelnye řoremeliker;

<A> *****DAIKINZTCF2015P+0+2012
 DEKRA (NB0344)
<C> 74736-KRQ/EMC97-4957

- 19 ** DIZC *** je poolačen za sestavo datobek s teimoro mapo;
- 20 ** DIZC *** on volliatu koostama tehnilist dokumentaastoon;
- 21 ** DIZC *** je oovpaakana ja osraavi Akta za tehnicza konstruicua;
- 22 ** DIZC *** vva jalotta sudatjy šj tehnicis konstruicjos řala;
- 23 ** DIZC *** i autorizis sasajia tehnicso dokumentaajju;
- 24 ** Spoolhoost DIZC *** je opraviena vyvoiti subor tehnicke konřtukcije;
- 25 ** DIZC *** Teknik řapi Dosyasini derlemeye yaktiror;
- 19 ** DIZC *** je poolačen za sestavo datobek s teimoro mapo;
- 20 ** DIZC *** on volliatu koostama tehnilist dokumentaastoon;
- 21 ** DIZC *** je oovpaakana ja osraavi Akta za tehnicza konstruicua;
- 22 ** DIZC *** vva jalotta sudatjy šj tehnicis konstruicjos řala;
- 23 ** DIZC *** i autorizis sasajia tehnicso dokumentaajju;
- 24 ** Spoolhoost DIZC *** je opraviena vyvoiti subor tehnicke konřtukcije;
- 25 ** DIZC *** Teknik řapi Dosyasini derlemeye yaktiror;



Takayuki Fujii
Managing Director
1st of Nov. 2012

DAIKIN INDUSTRIES CZECH REPUBLIC s.r.o.
U Nové Hospody 1/1155, 301 00 Píseň Skvrňany,
Czech Republic

3P327445-8B



Safety Precautions

- The precautions described herein are classified as WARNING and CAUTION. They both contain important information regarding safety. Be sure to observe all precautions without fail.
- Meaning of WARNING and CAUTION notices





 **WARNING** Failure to follow these instructions properly may result in personal injury or loss of life.



 **CAUTION** Failure to observe these instructions properly may result in property damage or personal injury, which may be serious depending on the circumstances.

- The safety marks shown in this manual have the following meanings:

 Be sure to follow the instructions.	 Be sure to establish an earth connection.	 Never attempt.
---	---	--

- After completing installation, conduct a trial operation to check for faults and explain to the customer how to operate the air conditioner and take care of it with the aid of the operation manual.
- The English text is the original instruction. Other languages are translations of the original instructions.



 WARNING	
<ul style="list-style-type: none"> • Ask your dealer or qualified personnel to carry out installation work. Do not attempt to install the air conditioner yourself. Improper installation may result in water leakage, electric shocks or fire. 	
<ul style="list-style-type: none"> • Install the air conditioner in accordance with the instructions in this installation manual. Improper installation may result in water leakage, electric shocks or fire. 	
<ul style="list-style-type: none"> • Be sure to use only the specified accessories and parts for installation work. Failure to use the specified parts may result in the unit falling, water leakage, electric shocks or fire. 	
<ul style="list-style-type: none"> • Install the air conditioner on a foundation strong enough to withstand the weight of the unit. A foundation of insufficient strength may result in the equipment falling and causing injury. 	
<ul style="list-style-type: none"> • Electrical work must be performed in accordance with relevant local and national regulations and with instructions in this installation manual. Be sure to use a dedicated power supply circuit only. Insufficiency of power circuit capacity and improper workmanship may result in electric shocks or fire. 	
<ul style="list-style-type: none"> • Use a cable of suitable length. Do not use tapped wires or an extension lead, as this may cause overheating, electric shocks or fire. 	
<ul style="list-style-type: none"> • Make sure that all wiring is secured, the specified wires are used, and that there is no strain on the terminal connections or wires. Improper connections or securing of wires may result in abnormal heat build-up or fire. 	
<ul style="list-style-type: none"> • When wiring the power supply and connecting the wiring between the indoor and outdoor units, position the wires so that the control box lid can be securely fastened. Improper positioning of the control box lid may result in electric shocks, fire or over heating terminals. 	
<ul style="list-style-type: none"> • If refrigerant gas leaks during installation, ventilate the area immediately. Toxic gas may be produced if the refrigerant comes into contact with fire. 	
<ul style="list-style-type: none"> • After completing installation, check for refrigerant gas leakage. Toxic gas may be produced if the refrigerant gas leaks into the room and comes into contact with a source of fire, such as a fan heater, stove or cooker. 	
<ul style="list-style-type: none"> • When installing or relocating the air conditioner, be sure to bleed the refrigerant circuit to ensure it is free of air, and use only the specified refrigerant (R410A). The presence of air or other foreign matter in the refrigerant circuit causes abnormal pressure rise, which may result in equipment damage and even injury. 	
<ul style="list-style-type: none"> • During installation, attach the refrigerant piping securely before running the compressor. If the refrigerant pipes are not attached and the stop valve is open when the compressor is run, air will be sucked in, causing abnormal pressure in the refrigeration cycle, which may result in equipment damage and even injury. 	
<ul style="list-style-type: none"> • During pump-down, stop the compressor before removing the refrigerant piping. If the compressor is still running and the stop valve is open during pump-down, air will be sucked in when the refrigerant piping is removed, causing abnormal pressure in the refrigeration cycle, which may result in equipment damage and even injury. 	
<ul style="list-style-type: none"> • Be sure to earth the air conditioner. Do not earth the unit to a utility pipe, lightning conductor or telephone earth lead. Imperfect earthing may result in electric shocks. 	
<ul style="list-style-type: none"> • Be sure to install an earth leakage breaker. Failure to install an earth leakage breaker may result in electric shocks or fire. 	

 CAUTION	
<ul style="list-style-type: none"> • Do not install the air conditioner at any place where there is a danger of flammable gas leakage. In the event of a gas leakage, build-up of gas near the air conditioner may cause a fire to break out. 	
<ul style="list-style-type: none"> • While following the instructions in this installation manual, install drain piping to ensure proper drainage and insulate piping to prevent condensation. Improper drain piping may result in indoor water leakage and property damage. 	
<ul style="list-style-type: none"> • Tighten the flare nut according to the specified method such as with a torque wrench. If the flare nut is too tight, it may crack after prolonged use, causing refrigerant leakage. 	
<ul style="list-style-type: none"> • Make sure to provide for adequate measures in order to prevent that the outdoor unit be used as a shelter by small animals. Small animals making contact with electrical parts can cause malfunctions, smoke or fire. Please instruct the customer to keep the area around the unit clean. 	

- The temperature of refrigerant circuit will be high, please keep the inter-unit wire away from copper pipes that are not thermally insulated.
- This appliance is intended to be used by expert or trained users in shops, in light industry and on farms, or for commercial and household use by lay persons.
- Sound pressure level is less than 70 dB (A).

Accessories

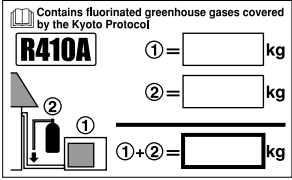
Accessories supplied with the outdoor unit:

<p>Ⓐ Installation manual</p>	1		
<p>Ⓒ Refrigerant charge label</p> 	1	<p>Ⓑ Drain plug (only heat pump models)</p>  <p>There is on the bottom packing case.</p>	1
<p>Ⓓ Multilingual fluorinated greenhouse gases label</p> 	1		

Precautions for Selecting the Location

- 1) Choose a place solid enough to bear the weight and vibration of the unit, where the operation noise will not be amplified.
- 2) Choose a location where the hot air discharged from the unit or the operation noise will not cause a nuisance to the neighbours of the user.
- 3) Avoid places near a bedroom and the like, so that the operation noise will cause no trouble.
- 4) There must be sufficient spaces for carrying the unit into and out of the site.
- 5) There must be sufficient space for air passage and no obstructions around the air inlet and the air outlet.
- 6) The site must be free from the possibility of flammable gas leakage in a nearby place.
- 7) Install units, power cords and inter-unit wire at least 3m away from television and radio sets. This is to prevent interference to images and sounds. (Noises may be heard even if they are more than 3m away depending on radio wave conditions.)
- 8) In coastal areas or other places with salty atmosphere of sulfate gas, corrosion may shorten the life of the air conditioner.
- 9) Since drain flows out of the outdoor unit, do not place under the unit anything which must be kept away from moisture.

NOTE

Cannot be installed hanging from ceiling or stacked.

⚠ CAUTION

When operating the air conditioner in a low outdoor ambient temperature, be sure to follow the instructions described below.

- To prevent exposure to wind, install the outdoor unit with its suction side facing the wall.
- Never install the outdoor unit at a site where the suction side may be exposed directly to wind.
- To prevent exposure to wind, it is recommended to install a baffle plate on the air discharge side of the outdoor unit.
- In heavy snowfall areas, select an installation site where the snow will not affect the unit.

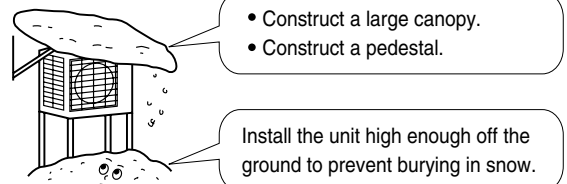

Outdoor Unit Installation Drawings

Max. allowable piping length	30m
** Min. allowable piping length	1.5m
Max. allowable piping height	20m
* Additional refrigerant required for refrigerant pipe exceeding 10m in length.	20g/m
Gas pipe	O.D. 12.7mm
Liquid pipe	O.D. 6.4mm

* Be sure to add the proper amount of additional refrigerant. Failure to do so may result in reduced performance.

** The suggested shortest pipe length is 1.5m, in order to avoid noise from the outdoor unit and vibration. (Mechanical noise and vibration may occur depending on how the unit is installed and the environment in which it is used.) When connecting the FVXS indoor unit, the shortest piping length should be no less than around 2.5m.

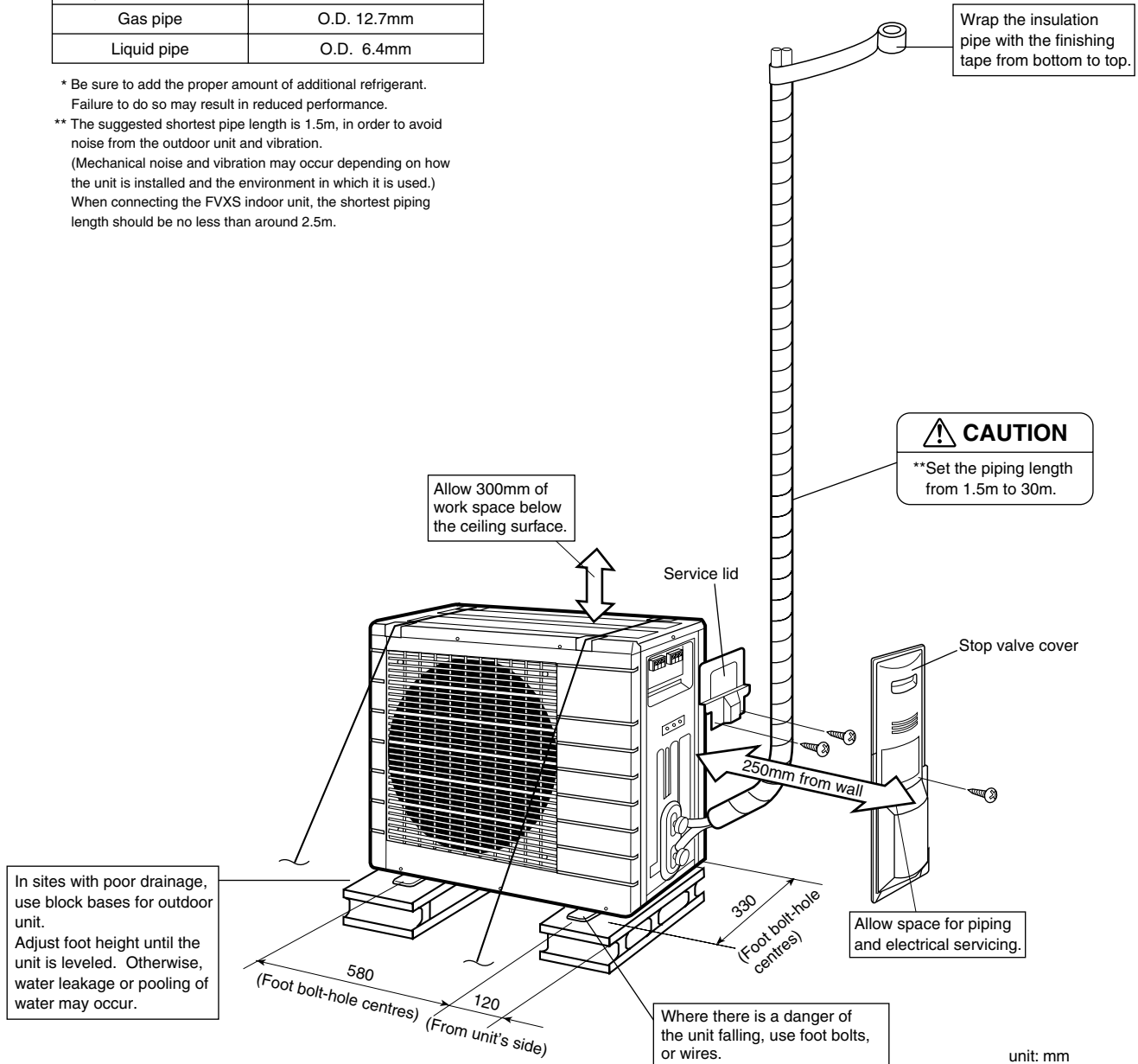

unit: mm

Installation Guidelines

- Where a wall or other obstacle is in the path of outdoor unit's inlet or outlet airflow, follow the installation guidelines below.
- For any of the below installation patterns, the wall height on the outlet side should be 1200mm or less.

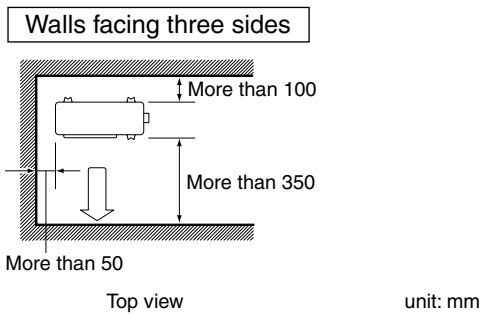
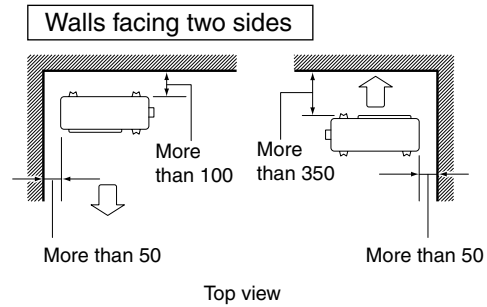
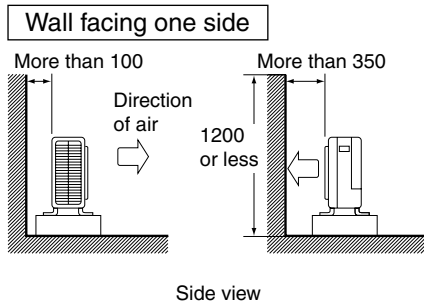

Precautions on Installation

- Check the strength and level of the installation ground so that the unit will not cause any operating vibration or noise after installed.
- In accordance with the foundation drawing, fix the unit securely by means of the foundation bolts. (Prepare 4 sets of M8 or M10 foundation bolts, nuts and washers each which are available on the market.)
- It is best to screw in the foundation bolts until their ends are 20mm from the foundation surface.

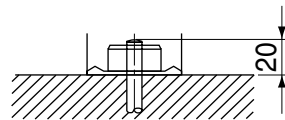

Outdoor Unit Installation

1. Installing outdoor unit

- 1) When installing the outdoor unit, refer to "Precautions for Selecting the Location" and the "Outdoor Unit Installation Drawings".
- 2) If drain work is necessary, follow the procedures below.

2. Drain work

- 1) Use drain plug for drainage.
- 2) If the drain port is covered by a mounting base or floor surface, place additional foot bases of at least 30mm in height under the outdoor unit's feet.
- 3) In cold areas, do not use a drain hose with the outdoor unit. (Otherwise, drain water may freeze, impairing heating performance.)

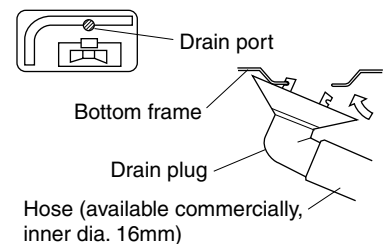

Outdoor Unit Installation

3. Flaring the pipe end

- 1) Cut the pipe end with a pipe cutter.
- 2) Remove burrs with the cut surface facing downward so that the chips do not enter the pipe.
- 3) Put the flare nut on the pipe.
- 4) Flare the pipe.
- 5) Check that the flaring is properly made.

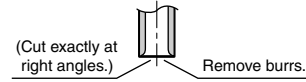

Set exactly at the position shown below.

Flaring		Conventional flare tool	
Flare tool for R410A		Clutch-type (Rigid-type)	Wing-nut type (Imperial-type)
A	0-0.5mm	1.0-1.5mm	1.5-2.0mm

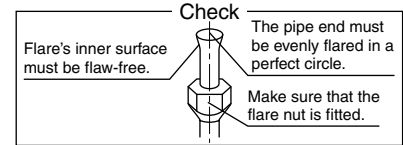

⚠ WARNING

- Do not use mineral oil on flared part.
- Prevent mineral oil from getting into the system as this would reduce the lifetime of the units.
- Never use piping which has been used for previous installations. Only use parts which are delivered with the unit.
- Do never install a drier to this R410A unit in order to guarantee its lifetime.
- The drying material may dissolve and damage the system.
- Incomplete flaring may cause refrigerant gas leakage.

4. Refrigerant piping

⚠ CAUTION

- Use the flare nut fixed to the main unit. (To prevent cracking of the flare nut by aged deterioration.)
- To prevent gas leakage, apply refrigeration oil only to the inner surface of the flare. (Use refrigeration oil for R410A.)
- Use torque wrenches when tightening the flare nuts to prevent damage to the flare nuts and gas leakage.

Align the centres of both flares and tighten the flare nuts 3 or 4 turns by hand. Then tighten them fully with the torque wrenches.

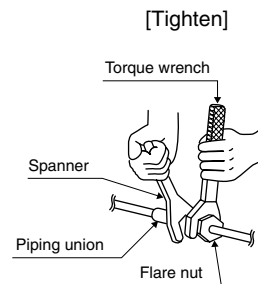
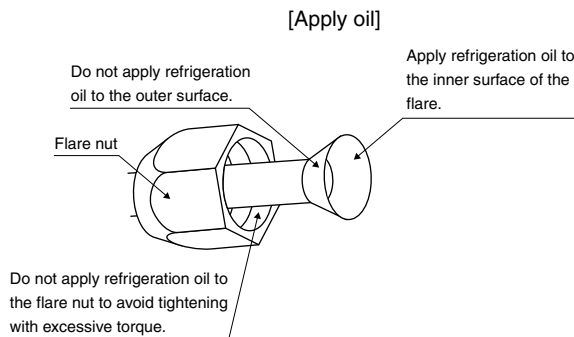

Flare nut tightening torque	
Gas side	Liquid side
1/2 inch	1/4 inch
49.5-60.3N • m (505-615kgf • cm)	14.2-17.2N • m (144-175kgf • cm)

Valve cap tightening torque	
Gas side	Liquid side
1/2 inch	1/4 inch
48.1-59.7N • m (490-610kgf • cm)	21.6-27.4N • m (220-280kgf • cm)

Service port cap tightening torque
10.8-14.7N • m (110-150kgf • cm)

5. Purging air and checking gas leakage

- When piping work is completed, it is necessary to purge the air and check for gas leakage.

WARNING

- Do not mix any substance other than the specified refrigerant (R410A) into the refrigeration cycle.
- When refrigerant gas leaks occur, ventilate the room as soon and as much as possible.
- R410A, as well as other refrigerants, should always be recovered and never be released directly into the environment.
- Use a vacuum pump for R410A exclusively. Using the same vacuum pump for different refrigerants may damage the vacuum pump or the unit.

- If using additional refrigerant, perform air purging from the refrigerant pipes and indoor unit using a vacuum pump, then charge additional refrigerant.
- Use a hexagonal wrench (4mm) to operate the stop valve rod.
- All refrigerant pipe joints should be tightened with a torque wrench at the specified tightening torque.

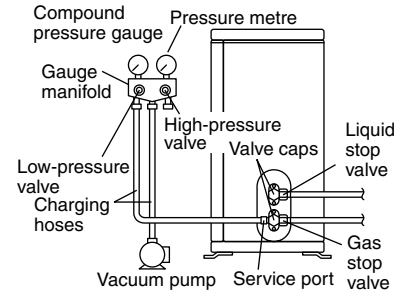

- Connect projection side of charging hose (which comes from gauge manifold) to gas stop valve's service port.
- Fully open gauge manifold's low-pressure valve (Lo) and completely close its high-pressure valve (Hi). (High-pressure valve subsequently requires no operation.)
- Do vacuum pumping and make sure that the compound pressure gauge reads -0.1MPa (-76cmHg).*1
- Close gauge manifold's low-pressure valve (Lo) and stop vacuum pump. (Keep this state for a few minutes to make sure that the compound pressure gauge pointer does not swing back.)*2
- Remove caps from liquid stop valve and gas stop valve.
- Turn the liquid stop valve's rod 90 degrees counterclockwise with a hexagonal wrench to open valve. Close it after 5 seconds, and check for gas leakage. Using soapy water, check for gas leakage from indoor unit's flare and outdoor unit's flare and valve rods. After the check is complete, wipe all soapy water off.
- Disconnect charging hose from gas stop valve's service port, then fully open liquid and gas stop valves. (Do not attempt to turn valve rod beyond its stop.)
- Tighten valve caps and service port caps for the liquid and gas stop valves with a torque wrench at the specified torques.

*1. Pipe length vs. vacuum pump run time

Pipe length	Up to 15m	More than 15m
Run time	Not less than 10 min.	Not less than 15 min.

*2. If the compound pressure gauge pointer swings back, refrigerant may have water content or a loose pipe joint may exist. Check all pipe joints and retighten nuts as needed, then repeat steps 2) through 4).

Outdoor Unit Installation

6. Refilling the refrigerant

Check the type of refrigerant to be used on the machine nameplate.

Precautions when adding R410A

Fill from the gas pipe in liquid form.

It is a mixed refrigerant, so adding it in gas form may cause the refrigerant composition to change, preventing normal operation.

- 1) Before filling, check whether the cylinder has a siphon attached or not. (It should have something like “liquid filling siphon attached” displayed on it.)

Filling a cylinder with an attached siphon

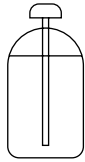

Stand the cylinder upright when filling.

(There is a siphon pipe inside, so the cylinder need not be upside-down to fill with liquid.)

Filling other cylinders



Turn the cylinder upside-down when filling.

- Be sure to use the R410A tools to ensure pressure and to prevent foreign objects entering.

Important information regarding the refrigerant used

This product contains fluorinated greenhouse gases covered by the Kyoto Protocol. Do not vent gases into the atmosphere.

Refrigerant type: **R410A**

GWP⁽¹⁾ value: **1975** ⁽¹⁾ GWP = global warming potential

Please fill in with indelible ink,

- ① the factory refrigerant charge of the product,
 - ② the additional refrigerant amount charged in the field and
 - ①+② the total refrigerant charge
- on the refrigerant charge label supplied with the product.

The filled out label must be adhered in the proximity of the product charging port (e.g. onto the inside of the stop valve cover).

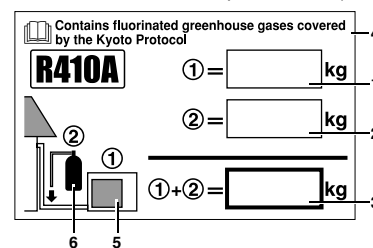

- 1 factory refrigerant charge of the product: see unit name plate
- 2 additional refrigerant amount charged in the field
- 3 total refrigerant charge
- 4 Contains fluorinated greenhouse gases covered by the Kyoto Protocol
- 5 outdoor unit
- 6 refrigerant cylinder and manifold for charging

NOTE

National implementation of EU regulation on certain fluorinated greenhouse gases may require to provide the appropriate official national language on the unit. Therefore an additional multilingual fluorinated greenhouse gases label is supplied with the unit. Sticking instructions are illustrated on the backside of that label.

7. Refrigerant piping work

7-1 Caution on pipe handling

- 1) Protect the open end of the pipe against dust and moisture.
- 2) All pipe bends should be as gentle as possible. Use a pipe bender for bending.

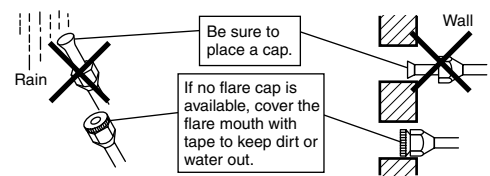

7-2 Selection of copper and heat insulation materials

When using commercial copper pipes and fittings, observe the following:

- 1) Insulation material: Polyethylene foam
Heat transfer rate: 0.041 to 0.052W/mK (0.035 to 0.045kcal/mh°C)
Refrigerant gas pipe's surface temperature reaches 110°C max.
Choose heat insulation materials that will withstand this temperature.
- 2) Be sure to insulate both the gas and liquid piping and to provide insulation dimensions as below.

Gas side	Liquid side	Gas pipe thermal insulation	Liquid pipe thermal insulation
O.D. 12.7mm	O.D. 6.4mm	I.D. 14-16mm	I.D. 8-10mm
Minimum bend radius		Thickness 10mm Min.	
40mm or more	30mm or more		
Thickness 0.8mm (C1220T-O)			

- Use separate thermal insulation pipes for gas and liquid refrigerant pipes.

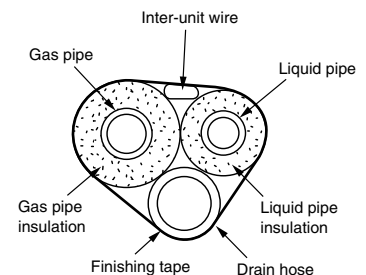

Pump Down Operation

In order to protect the environment, be sure to pump down when relocating or disposing of the unit.

- 1) Remove the valve cap from liquid stop valve and gas stop valve.
- 2) Carry out forced cooling operation.
- 3) After 5 to 10 minutes, close the liquid stop valve with a hexagonal wrench.
- 4) After 2 to 3 minutes, close the gas stop valve and stop forced cooling operation.

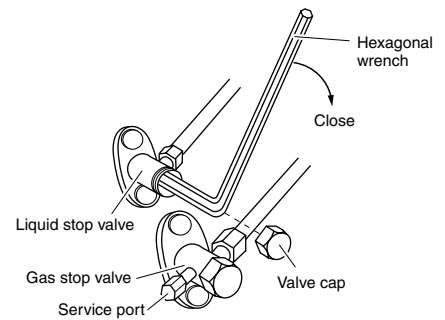

Forced cooling operation

■ Using the indoor unit ON/OFF switch

Press the indoor unit ON/OFF switch for at least 5 seconds. (The operation will start.)

- Forced cooling operation will stop automatically after around 15 minutes.
To stop the operation, press the indoor unit ON/OFF switch.

■ Using the indoor unit's remote controller

- 1) Press "MODE" button and select the cooling mode.
 - 2) Press "ON/OFF" button to turn on the system.
 - 3) Press both of "TEMP" button and "MODE" button at the same time.
 - 4) Press "MODE" button twice. ($\bar{7}$ will be displayed and the unit will enter forced cooling operation.)
- Forced cooling operation will stop automatically after around 30 minutes.
To stop the operation, press "ON/OFF" button.

■ Using the outdoor unit forced cooling operation switch

Forced cooling operation can be performed when the outdoor unit forced cooling operation switch is pressed within around 3 minutes after power is supplied.

- Push on "SW1" (SW1) with a screwdriver. (The operation will start.)
- Forced cooling operation will stop automatically after around 15 minutes.
To stop the operation, press the switch (SW1).

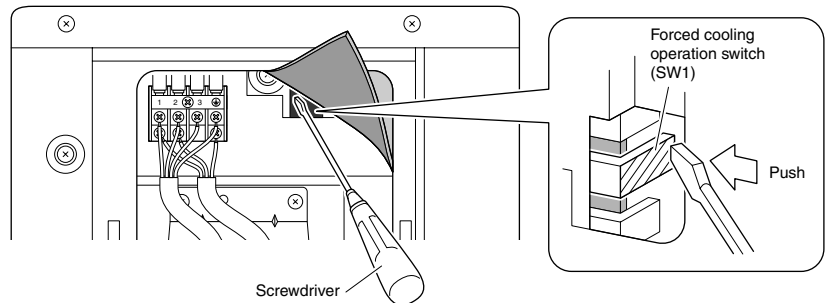

Standby Electricity Saving

The standby electricity saving function turns off power supply to the outdoor unit and sets the indoor unit into standby electricity saving mode, thus reducing the power consumption of the air conditioner.

The standby electricity saving function works on the following indoor unit.

FTXS50K2V1B

⚠ CAUTION

- The standby electricity saving function cannot be used for models other than the specified one.

■ Procedure for turning on standby electricity saving function

- 1) Check that the main power supply is turned off. Turn it off if has not been turned off.
- 2) Remove the stop valve cover.
- 3) Disconnect the selective connector for standby electricity saving.
- 4) Turn on the main power supply.

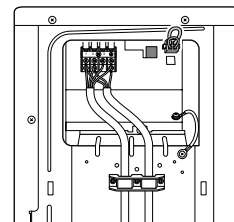

Standby electricity saving function off.

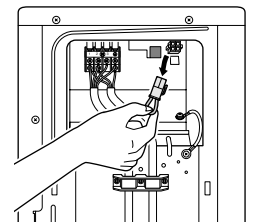

Standby electricity saving function on.

The standby electricity saving function is turned off before shipping.

⚠ CAUTION

- Before connecting or disconnecting the selective connector for standby electricity saving, make sure that the main power supply is turned off.
- The selective connector for standby electricity saving is required if an indoor unit other than the above applicable one is connected.

Facility Setting (cooling at low outdoor temperature)

This function is designed for facilities such as equipment or computer rooms. It is never to be used in a residence or office where people occupy the space.

- Cutting jumper 6 (J6) on the circuit board will expand the operation range down to -10°C . However it will stop if the outdoor temperature drops below -18°C and start back up once the temperature rises again.

- 1) Remove the 3 screws on the side and remove the top plate of the outdoor unit.
- 2) Remove the drip proof cover.
- 3) Cut the jumper (J6) of the PCB inside.

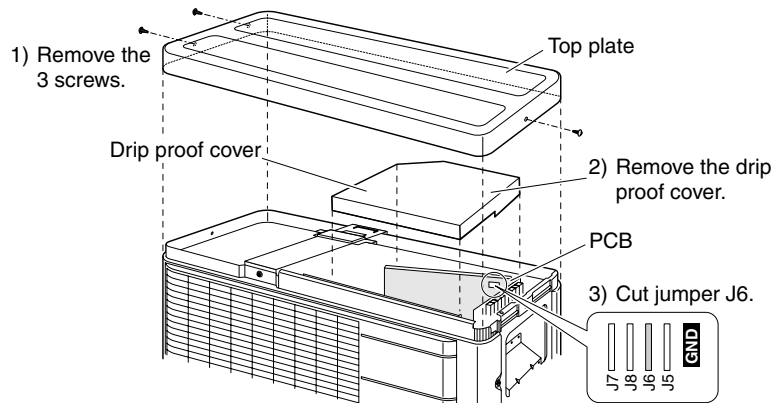

⚠ CAUTION

- If the outdoor unit is installed where the heat exchanger of the unit is exposed to direct wind, provide a windbreak wall.
- Intermittent noises may be produced by the indoor unit due to the outdoor fan turning on and off when using facility settings.
- Do not place humidifiers or other items which might raise the humidity in rooms where facility settings are being used. A humidifier might cause dew condensation from the indoor unit outlet vent.
- Cutting jumper 6 (J6) sets the indoor fan tap to the highest position. Notify the user about this.

Wiring

⚠ WARNING

- Do not use tapped wires, stranded wires, extension cords, or starburst connections, as they may cause overheating, electrical shock, or fire.
- Do not use locally purchased electrical parts inside the product. (Do not branch the power for the drain pump, etc., from the terminal block.) Doing so may cause electric shock or fire.
- Be sure to install an earth leak detector. (One that can handle higher harmonics.)
(This unit uses an inverter, which means that it must be used an earth leak detector capable handling harmonics in order to prevent malfunctioning of the earth leak detector itself.)
- Use an all-pole disconnection type breaker with at least 3mm between the contact point gaps.
- Do not connect the power wire to the indoor unit. Doing so may cause electric shock or fire.

- Do not turn on the safety breaker until all work is completed.

- 1) Strip the insulation from the wire (20mm).
- 2) Connect the inter-unit wire between the indoor and outdoor units **so that the terminal numbers match**. Tighten the terminal screws securely. We recommend a flathead screwdriver be used to tighten the screws.

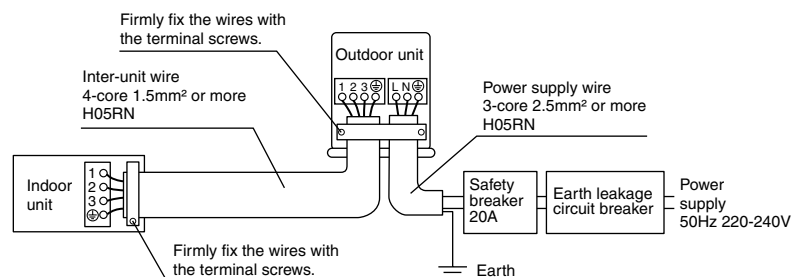

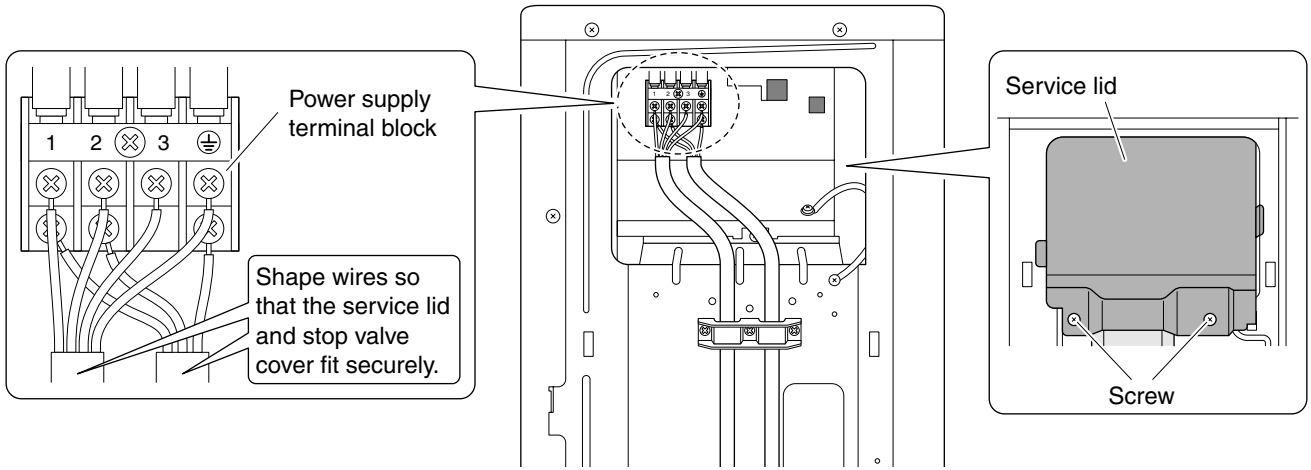

Observe the notes mentioned below when wiring to the power supply terminal block.
 Precautions to be taken for power supply wiring.

CAUTION

- When connecting the wires to the terminal block using a single core wire, be sure to perform curling. Problems with the work may cause heat and fires.

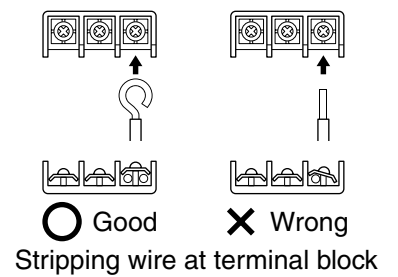
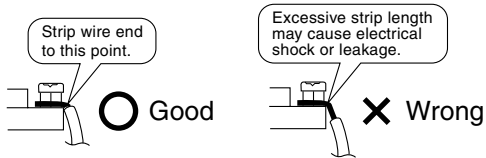

- If the stranded wires must be used, make sure to use the round crimp-style terminal for connection to the power supply terminal block. Place the round crimp-style terminals on the wires up to the covered part and secure in place.

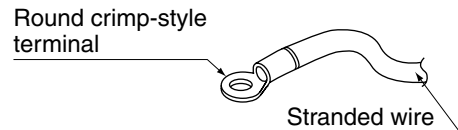

3) Pull the wire and make sure that it does not disconnect. Then fix the wire in place with a wire stop.

Wiring diagram

	: Terminal strip		: Field wiring
	: Connector		: Relay connector
	: Connection		: Terminal
BLK	: Black	ORG	: Orange
BLU	: Blue	RED	: Red
BRN	: Brown	WHT	: White
GRN	: Green	YLW	: Yellow

Wiring

Notes	:	Refer to the nameplate of the unit for power requirements.	
	:	TO INDOOR UNIT	To indoor unit
	:	POWER SUPPLY	Power supply
	:	IN CASE OF COOLING ONLY TYPE	In case of cooling only type
	:	OUTDOOR	Outdoor
	:	CONDENSER	Condenser
	:	DISCHARGE	Discharge

Wiring diagram parts table

C7,C8.....	Capacitor	PCB1,PCB2	Printed circuit board
DB1,DB3.....	Diode bridge	S10,S11,S12,S20, S40,S70,S80,S90	
FU1,FU2,FU3	Fuse	HL3,HN3,X11A.....	Connector
FU4.....	Field fuse	R1T,R2T,R3T	Thermistor
IPM.....	Intelligent power module	SA1	Surge absorber
L.....	Live	V1,V2,V3.....	Varistor
L803,L804.....	Reactor	X1M.....	Terminal strip
M1C	Compressor motor	Y1E	Electronic expansion valve coil
M1F.....	Fan motor	Y1S	Reversing solenoid valve
MRCW,MRM10, MRM20,MR30.....	Magnetic relay	Z1C~Z4C.....	Noise filter (ferrite core)
N.....	Neutral	⊕	Protective earth
Q1L.....	Overload protector	⊥	Earth
Q1DI.....	Earth leak detector		

Trial Operation and Testing

1. Trial operation and testing

1-1 Measure the supply voltage and make sure that it falls in the specified range.

1-2 Trial operation should be carried out in either cooling or heating mode.

■ For heat pump

- In cooling mode, select the lowest programmable temperature; in heating mode, select the highest programmable temperature.
 - Trial operation may be disabled in either mode depending on the room temperature.
 - After trial operation is complete, set the temperature to a normal level (26°C to 28°C in cooling mode, 20°C to 24°C in heating mode).
 - For protection, the system disables restart operation for 3 minutes after it is turned off.

■ For cooling only

- Select the lowest programmable temperature.
 - Trial operation in cooling mode may be disabled depending on the room temperature.
 - After trial operation is complete, set the temperature to a normal level (26°C to 28°C).
 - For protection, the system disables restart operation for 3 minutes after it is turned off.

1-3 Carry out the test operation in accordance with the operation manual to ensure that all functions and parts, such as louver movement, are working properly.

- The air conditioner requires a small amount of power in its standby mode. If the system is not to be used for some time after installation, shut off the circuit breaker to eliminate unnecessary power consumption.
- If the circuit breaker trips to shut off the power to the air conditioner, the system will restore the original operation mode when the circuit breaker is opened again.

2. Test items

Test items	Symptom	Check
Indoor and outdoor units are installed properly on solid bases.	Fall, vibration, noise	
No refrigerant gas leaks.	Incomplete cooling/heating function	
Refrigerant gas and liquid pipes and indoor drain hose extension are thermally insulated.	Water leakage	
Draining line is properly installed.	Water leakage	
System is properly earthed.	Electrical leakage	
The specified wires are used for inter-unit wiring.	Inoperative or burn damage	
Indoor or outdoor unit's air inlet or air outlet has clear path of air. Stop valves are opened.	Incomplete cooling/heating function	
Indoor unit properly receives remote control commands.	Inoperative	

DAIKIN INDUSTRIES CZECH REPUBLIC s.r.o.

U Nové Hospody 1/1155, 301 00 Plzeň Skvrňany, Czech Republic

DAIKIN EUROPE N.V.

Zandvoordestraat 300, B-8400 Oostende, Belgium



Two-dimensional bar code is a code for manufacturing.

3P254362-9K M12B166 (1210) 