

**DAIKIN**

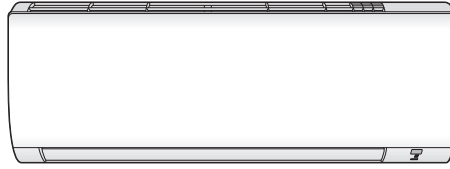

DAIKIN ROOM AIR CONDITIONER

# INSTALLATION MANUAL

R410A Split Series



Installation manual  
Installationsanleitung  
Manuel d'installation  
Installatiehandleiding  
Manual de instalación  
Manuale d'installazione  
Εγχειρίδιο εγκατάστασης  
Manual de instalação  
Руководство по монтажу  
Montaj kılavuzu

## MODELS

FTX50KMV1B

FTX60KMV1B

FTX71KMV1B

English

Deutsch

Français

Nederlands

Español

Italiano

Ελληνικά

Portugues

Русский

Türkçe





# Table of Contents

Safety Precautions .....	1
Accessories .....	2
Choosing an Installation Site .....	2
Preparation before Installation .....	3
Indoor Unit Installation Drawings .....	5
Indoor Unit Installation .....	6
Refrigerant Piping Work .....	11
Trial Operation and Testing .....	13

## Safety Precautions



• The precautions described herein are classified as WARNING and CAUTION. They both contain important information regarding safety. Be sure to observe all precautions without fail.

• Meaning of WARNING and CAUTION notices

 **WARNING .... Failure to follow these instructions properly may result in personal injury or loss of life.**



 **CAUTION ..... Failure to observe these instructions properly may result in property damage or personal injury, which may be serious depending on the circumstances.**

• The safety marks shown in this manual have the following meanings:



 Be sure to follow the instructions.	 Be sure to establish an earth connection.	 Never attempt.
---	---	--

• After completing installation, conduct a trial operation to check for faults and explain to the customer how to operate the air conditioner and take care of it with the aid of the operation manual.

• The English text is the original instruction. Other languages are translations of the original instructions.

 <b>WARNING</b>	
• Ask your dealer or qualified personnel to carry out installation work. Do not attempt to install the air conditioner yourself. Improper installation may result in water leakage, electric shocks or fire.	
• Install the air conditioner in accordance with the instructions in this installation manual. Improper installation may result in water leakage, electric shocks or fire.	
• Be sure to use only the specified accessories and parts for installation work. Failure to use the specified parts may result in the unit falling, water leakage, electric shocks or fire.	
• Install the air conditioner on a foundation strong enough to withstand the weight of the unit. A foundation of insufficient strength may result in the equipment falling and causing injury.	
• Electrical work must be performed in accordance with relevant local and national regulations and with instructions in this installation manual. Be sure to use a dedicated power supply circuit only. Insufficiency of power circuit capacity and improper workmanship may result in electric shocks or fire.	
• Use a cable of suitable length. Do not use tapped wires or an extension lead, as this may cause overheating, electric shocks or fire.	
• Make sure that all wiring is secured, the specified wires are used, and that there is no strain on the terminal connections or wires. Improper connections or securing of wires may result in abnormal heat build-up or fire.	
• When wiring the power supply and connecting the wiring between the indoor and outdoor units, position the wires so that the control box lid can be securely fastened. Improper positioning of the control box lid may result in electric shocks, fire or over heating terminals.	
• If refrigerant gas leaks during installation, ventilate the area immediately. Toxic gas may be produced if the refrigerant comes into contact with fire.	
• After completing installation, check for refrigerant gas leakage. Toxic gas may be produced if the refrigerant gas leaks into the room and comes into contact with a source of fire, such as a fan heater, stove or cooker.	
• When installing or relocating the air conditioner, be sure to bleed the refrigerant circuit to ensure it is free of air, and use only the specified refrigerant (R410A). The presence of air or other foreign matter in the refrigerant circuit causes abnormal pressure rise, which may result in equipment damage and even injury.	

<ul style="list-style-type: none"> <li>• During installation, attach the refrigerant piping securely before running the compressor. If the refrigerant pipes are not attached and the stop valve is open when the compressor is run, air will be sucked in, causing abnormal pressure in the refrigeration cycle, which may result in equipment damage and even injury.</li> </ul>
<ul style="list-style-type: none"> <li>• During pump-down, stop the compressor before removing the refrigerant piping. If the compressor is still running and the stop valve is open during pump-down, air will be sucked in when the refrigerant piping is removed, causing abnormal pressure in the refrigeration cycle, which may result in equipment damage and even injury.</li> </ul>
<ul style="list-style-type: none"> <li>• Be sure to earth the air conditioner. Do not earth the unit to a utility pipe, lightning conductor or telephone earth lead. Imperfect earthing may result in electric shocks.</li> </ul>
<ul style="list-style-type: none"> <li>• Be sure to install an earth leakage breaker. Failure to install an earth leakage breaker may result in electric shocks or fire.</li> </ul>

 <b>CAUTION</b>	
<ul style="list-style-type: none"> <li>• Do not install the air conditioner at any place where there is a danger of flammable gas leakage. In the event of a gas leakage, build-up of gas near the air conditioner may cause a fire to break out.</li> </ul>	
<ul style="list-style-type: none"> <li>• While following the instructions in this installation manual, install drain piping to ensure proper drainage and insulate piping to prevent condensation. Improper drain piping may result in indoor water leakage and property damage.</li> </ul>	
<ul style="list-style-type: none"> <li>• Tighten the flare nut according to the specified method such as with a torque wrench. If the flare nut is too tight, it may crack after prolonged use, causing refrigerant leakage.</li> </ul>	
<ul style="list-style-type: none"> <li>• Sound pressure level is less than 70 dB(A).</li> </ul>	
<ul style="list-style-type: none"> <li>• Make sure to provide for adequate measures in order to prevent that the outdoor unit be used as a shelter by small animals. Small animals making contact with electrical parts can cause malfunctions, smoke or fire.</li> </ul>	

# Accessories

**Indoor unit**    (A)–(H)

(A) Mounting plate	1	(D) Remote controller holder	1	(G) Operation manual	1
(B) Titanium apatite photocatalytic air-purifying filter	2	(E) Dry battery AAA. LR03 (alkaline)	2	(H) Installation manual	1
(C) Wireless remote controller	1	(F) Indoor unit fixing screw (M4 × 12L)	2		

# Choosing an Installation Site

Before choosing the installation site, obtain user approval.

## 1. Indoor unit

- The indoor unit should be sited in a place where:

- 1) the restrictions on installation specified in the indoor unit installation drawings are met,
- 2) both air inlet and air outlet have clear paths met,
- 3) the unit is not in the path of direct sunlight,
- 4) the unit is away from the source of heat or steam,
- 5) there is no source of machine oil vapour (this may shorten indoor unit life),
- 6) cool (warm) air is circulated throughout the room,
- 7) the unit is away from electronic ignition type fluorescent lamps (inverter or rapid start type) as they may shorten the remote controller range,
- 8) the unit is at least 1m away from any television or radio set (unit may cause interference with the picture or sound),
- 9) no laundry equipment is located.

## 2. Wireless remote controller

- Turn on all the fluorescent lamps in the room, if any, and find the site where remote controller signals are properly received by the indoor unit (within 7m).

# Preparation before Installation

## 1. Removing and installing the front panel

### • Removal method

- 1) Place your fingers in the indentations on the main unit (one each on the left and right sides), and open the front panel until it stops.
- 2) Continue to open the front panel further while sliding the panel to the right and pulling it toward you in order to disengage the front panel shaft on the left side. To disengage the front panel shaft on the right side, slide the panel to the left while pulling it toward you.

### • Installation method

Align the tabs of the front panel with the grooves, and push all the way in. Then close slowly. Push the centre of the lower surface panel firmly to engage the tabs.

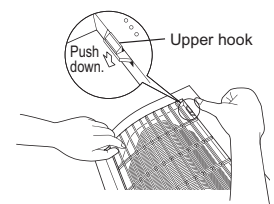
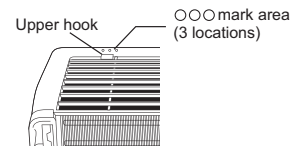
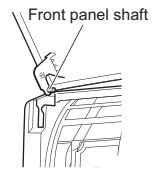
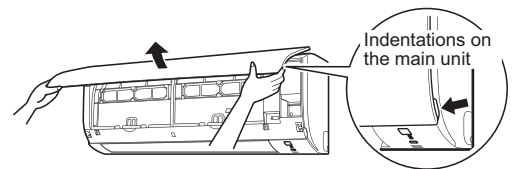

## 2. Removing and installing the front grille

### • Removal method

- 1) Remove the front panel to remove the air filter.
- 2) Remove the 3 screws from the front grille.
- 3) In front of the OOO mark of the front grille, there are 3 upper hooks. Lightly pull the front grille toward you with one hand, and push down on the hooks with the fingers of your other hand.

## When there is no work space because the unit is close to ceiling

### ⚠ CAUTION

- Be sure to wear protection gloves.

Place both hands under the centre of the front grille, and while pushing up, pull it toward you.

### • Installation method

- 1) Install the front grille and firmly engage the upper hooks (3 locations).
- 2) Install 3 screws of the front grille.
- 3) Install the air filter and then mount the front panel.

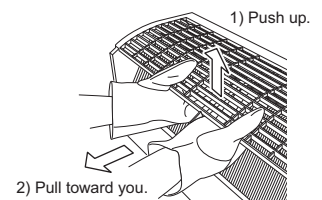

## 3. How to set the different addresses

When 2 indoor units are installed in one room, the 2 wireless remote controllers can be set for different addresses. Change the address setting of one of the two units.

When cutting the jumper be careful not to damage any of the surrounding parts.

- 1) Remove the battery cover on the remote controller and cut the address jumper.
- 2) Press **TEMP↑**, **TEMP↓** and **OFF** at the same time.

- 3) Press **TEMP↑**, select **R**, press **FAN**.

(The indoor unit OPERATION lamp will blink for about 1 minute.)

- 4) Press the indoor unit ON/OFF switch while the OPERATION lamp is blinking.

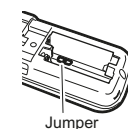

Jumper	ADDRESS
EXIST	1
CUT	2

- If setting could not be carried out completely while the OPERATION lamp was blinking, carry out the setting process once again from the beginning.
- After setting is complete, pressing **FAN** for about 5 seconds will cause the remote controller to return to the previous display.

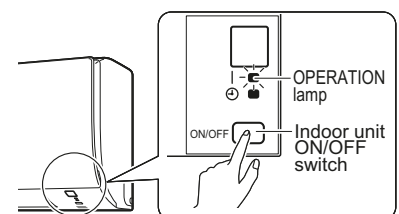



# Preparation before Installation

## 4. When connecting to an HA system (Wired remote controller, central remote controller etc.)

- 1) Remove the metal plate electrical wiring cover.  
(Refer to the **Removal/attachment methods of metal plate electrical wiring covers.**)
- 2) Attach the connection cord to the S21 connector and pull the harness as shown in the figure.
- 3) Replace the electrical wiring cover as it was, and pull the harness around, as shown in the figure.

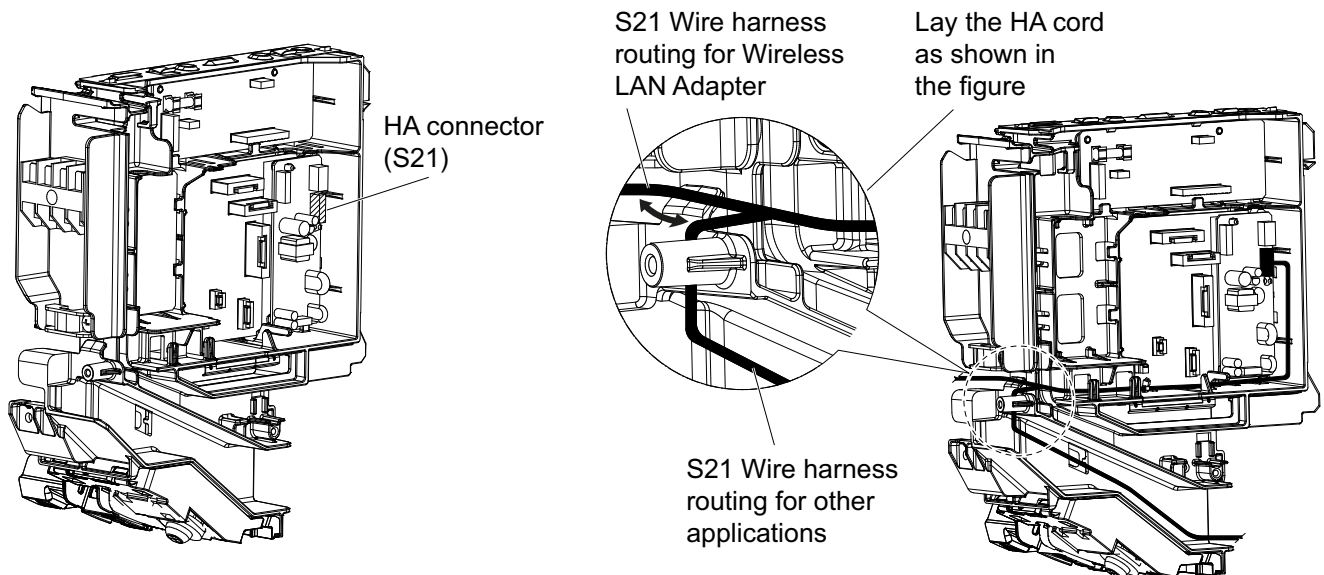

### Removal method of metal plate electrical wiring covers

- 1) Remove the front grille.
- 2) Remove the electrical wiring box (1 screw).
- 3) Raise the upper part of the metal plate electrical wiring cover, pull the part forward, and remove the 3 tabs.

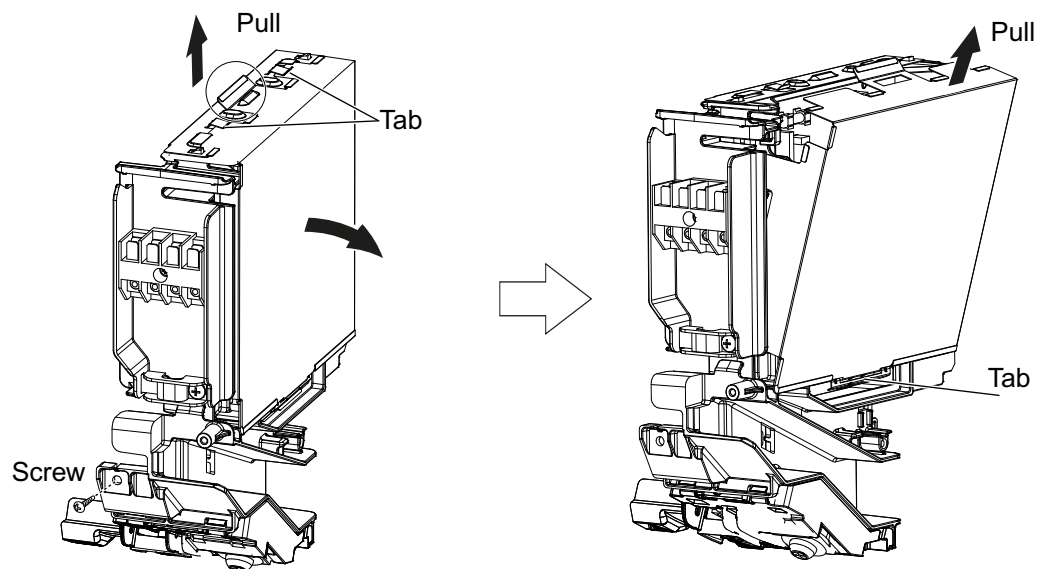

# Indoor Unit Installation Drawings

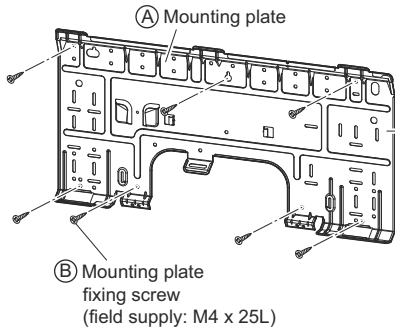

The (A) mounting plate should be installed on a wall which can support the weight of the indoor unit.

## How to attach the indoor unit

Hook the hooks of the bottom frame to the (A) mounting plate. If the hooks are difficult to hook, remove the front grille.

## How to remove the indoor unit

Push up the marked area (at the lower part of the front grille) to release the hooks. If it is difficult to release, remove the front grille.

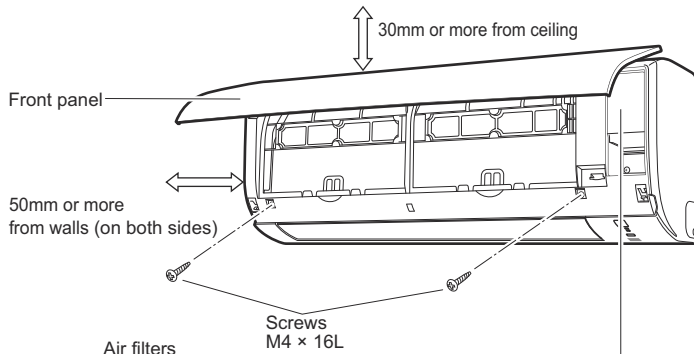
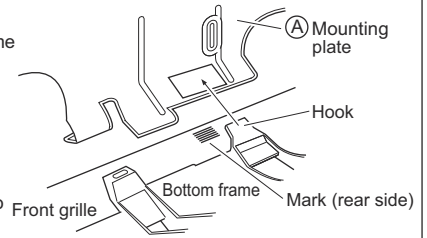

Caulk pipe hole gap with putty.

Cut thermal insulation pipe to an appropriate length and wrap it with tape, making sure that no gap is left in the insulation pipe's cut line.

Wrap the insulation pipe with the finishing tape from bottom to top.

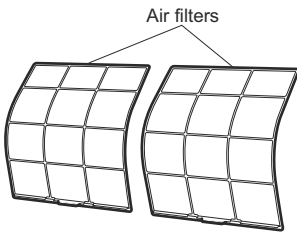

## Service lid

The service lid is removable.

### Opening method

- 1) Remove the service lid screw.
- 2) Pull out the service lid horizontally in the direction of the arrow.
- 3) Pull down.

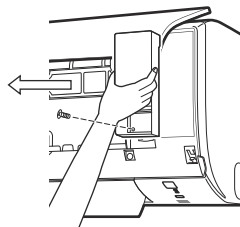

## (C) Titanium apatite photocatalytic air-purifying filter (2)

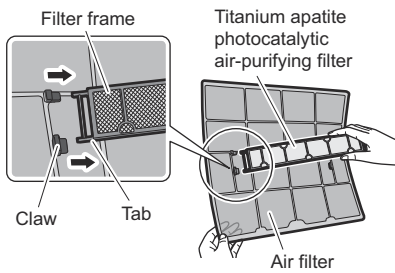

Before screwing the (E) remote controller holder to the wall, make sure that control signals are properly received by indoor unit.

(D) Wireless remote controller

(E) Fixing screw for remote controller holder (field supply: M3 x 20L)

(E) Remote controller holder



# Indoor Unit Installation

## 1. Installing the mounting plate

- The mounting plate should be installed on a wall which can support the weight of the indoor unit.

- Temporarily secure the mounting plate to the wall, make sure that the panel is completely level, and mark the boring points on the wall.
- Secure the mounting plate to the wall with screws.

### Recommended mounting plate retention spots and dimensions

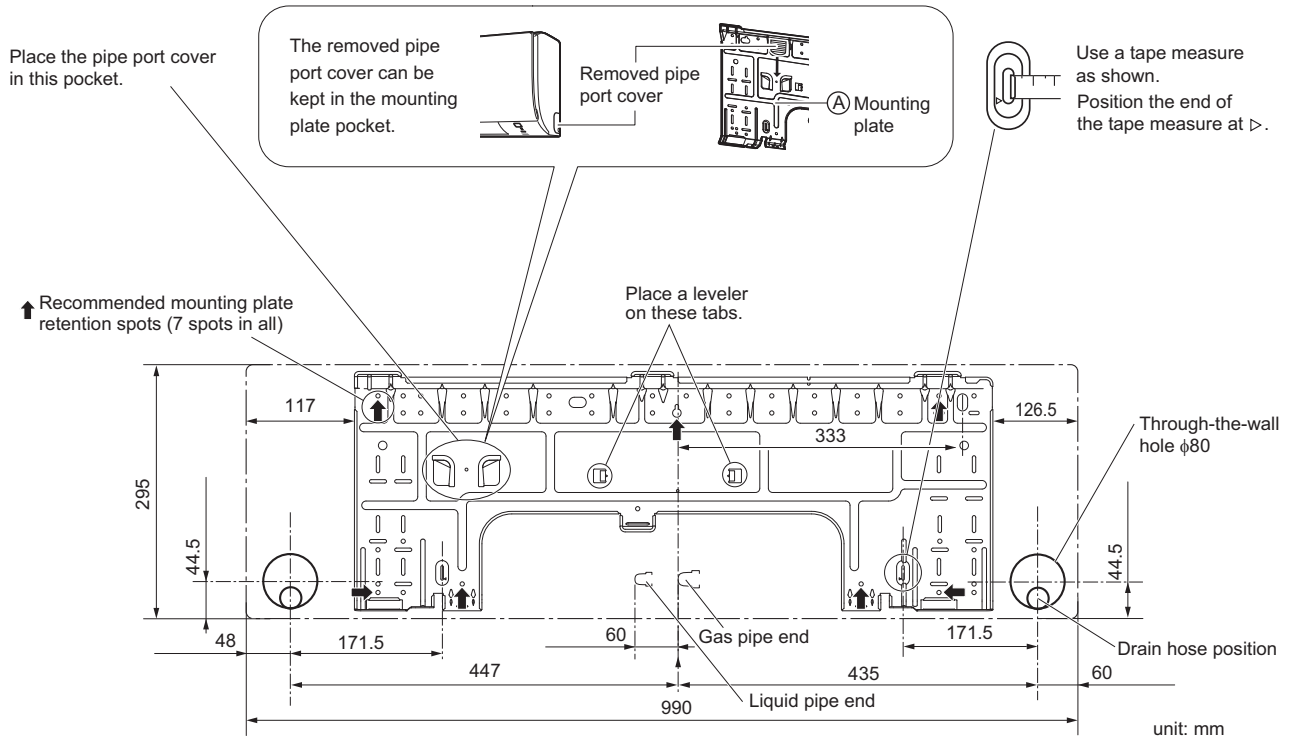

## 2. Boring a wall hole and installing wall embedded pipe

- For walls containing metal frame or metal board, be sure to use a wall embedded pipe and wall cover in the feed-through hole to prevent possible heat, electrical shock, or fire.
- Be sure to caulk the gaps around the pipes with caulking material to prevent water leakage.

- Bore a feed-through hole of 65mm in the wall so it has a down slope toward the outside.
- Insert a wall pipe into the hole.
- Insert a wall cover into wall pipe.
- After completing refrigerant piping, wiring, and drain piping, caulk pipe hole gap with putty.

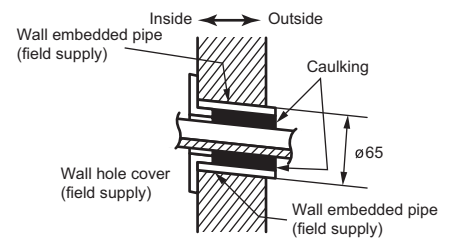

## 3. Installing the indoor unit

- In the case of bending or curing refrigerant pipes, keep the following precautions in mind.

Abnormal sound may be generated if improper work is conducted.

- Do not strongly press the refrigerant pipes onto the bottom frame.
- Do not strongly press the refrigerant pipes on the front grille, either.

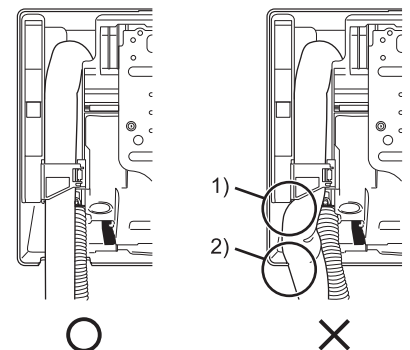

- Remove the pipe port cover as shown below.

# Indoor Unit Installation

- 1) Cut off the pipe port cover from inside the front grille using a coping saw. Apply the blade of the coping saw to the notch, and cut off the pipe port cover along the uneven inner surface.
- 2) After cutting off the pipe port cover, perform filing. Remove the burrs along the cut section using a half round needle file.

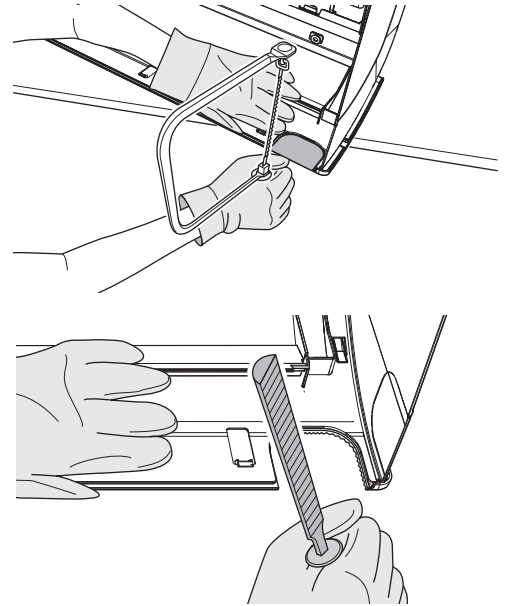

## ⚠ CAUTION

- If the pipe port cover is cut off using nippers, the front grille will be damaged. Please do not use nippers.
- Wear gloves during the pipe port cover removal.

### 3-1. Right-side, right-back, or right-bottom piping

- 1) Attach the drain hose to the underside of the refrigerant pipes with adhesive vinyl tape.
- 2) Wrap the refrigerant pipes and drain hose together with insulation tape.

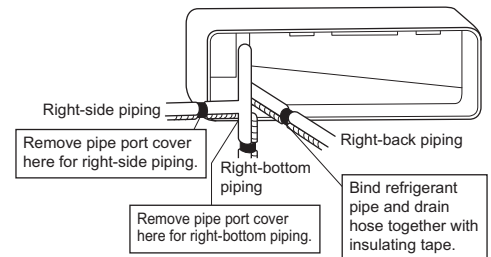

- 3) Pass the drain hose and refrigerant pipes through the wall hole, then set the indoor unit on the mounting plate hooks by using the △ markings at the top of the indoor unit as a guide.

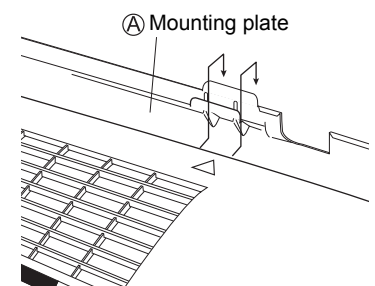

- 4) Open the front panel, then open the service lid. (Refer to preparation before installation.)
- 5) Pass the inter-unit wire from the outdoor unit through the feed-through wall hole and then through the back of the indoor unit. Pull them through the front side. Bend the ends of tie wires upward for easier work in advance. (If the inter-unit wire ends are to be stripped first, bundle wire ends with adhesive tape.)
- 6) Press the bottom frame of the indoor unit with both hands to set it on the mounting plate hooks. Make sure the wires do not catch on the edge of the indoor unit.

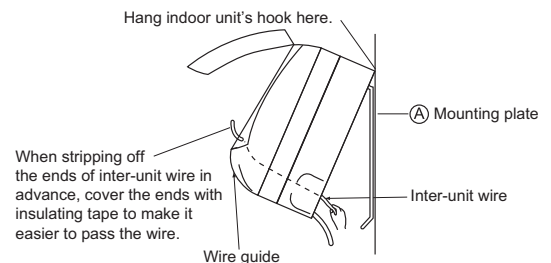

# Indoor Unit Installation

## 3-2. Left-side, left-back, or left-bottom piping

### How to replace the drain plug and drain hose

#### • Replacing onto the left side

- 1) Remove the insulation fixing screw on the right and remove the drain hose.
- 2) Remove the drain plug on the left side and attach it to the right side.
- 3) Insert the drain hose and tighten with included insulation fixing screw.  
\* (Forgetting to tighten this may cause water leakages.)

#### Drain hose attachment position

\* The drain hose is on the back of the unit.

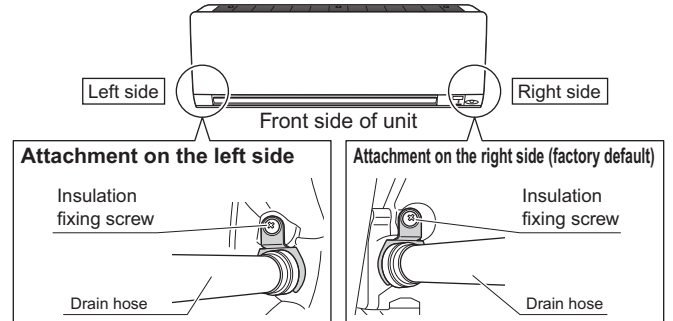

- 1) Attach the drain hose to the underside of the refrigerant pipes with adhesive vinyl tape.

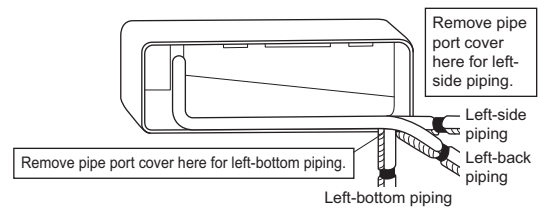

- 2) Be sure to connect the drain hose to the drain port in place of a drain plug.

#### How to set drain plug

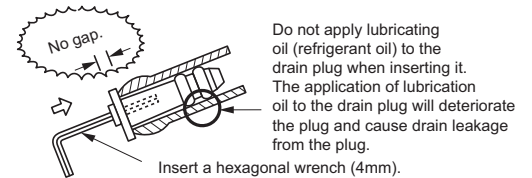

Do not apply lubricating oil (refrigerant oil) to the drain plug when inserting it. The application of lubrication oil to the drain plug will deteriorate the plug and cause drain leakage from the plug.

- 3) Shape the refrigerant pipes along the pipe path marking on the mounting plate.
- 4) Pass the drain hose and refrigerant pipes through the wall hole, then set the indoor unit on mounting plate hooks, using the  $\Delta$  markings at the top of the indoor unit as a guide.
- 5) Pull in the inter-unit wire.
- 6) Connect the inter-unit pipes.

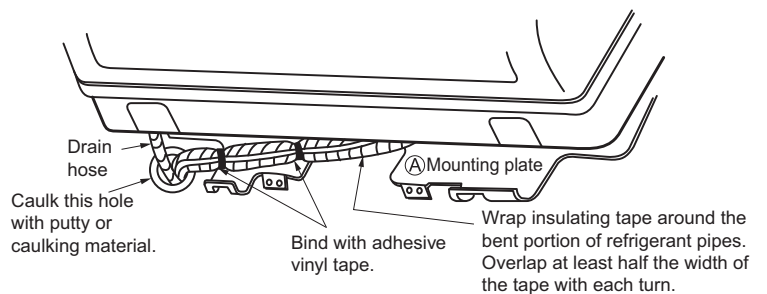

- 7) Wrap the refrigerant pipes and drain hose together with insulation tape as shown in the figure on the right (in case of setting the drain hose through the back of the indoor unit).
- 8) While exercising care so that the inter-unit wire does not catch indoor unit, press the bottom edge of indoor unit with both hands until it is firmly caught by the mounting plate hooks. Secure indoor unit to the mounting plate with indoor unit fixing screws (M4 × 12L).

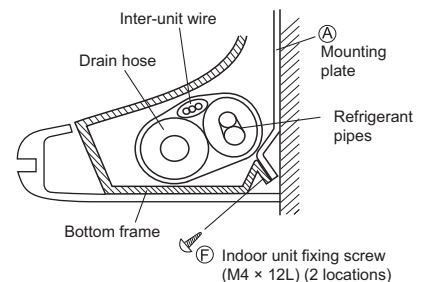

## 3-3. Wall embedded piping

Follow the instructions given under left-side, left-back, or left-bottom piping.



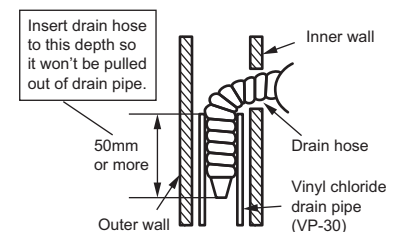









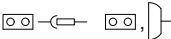

- 1) Insert the drain hose to this depth so it won't be pulled out of the drain pipe.



# Indoor Unit Installation

## Wiring diagram

For applied parts and numbering refer to the wiring diagram sticker supplied on the unit. Part numbering is realized by Arabic numbers in ascending order for each part and is represented in the overview below by symbol “\*” in the part code.

	: CONNECTION		: PROTECTIVE EARTH (SCREW)
	: CONNECTOR		: RECTIFIER
	: EARTH		: RELAY CONNECTOR
	: FIELD WIRING		: SHORT CIRCUIT CONNECTOR
	: INDOOR UNIT		: TERMINAL
	: OUTDOOR UNIT		: TERMINAL STRIP
	: PROTECTIVE EARTH		: WIRE CLAMP
BLK : BLACK	GRN : GREEN	PNK : PINK	WHT : WHITE
BLU : BLUE	GRY : GREY	PRP, PPL : PURPLE	YLW : YELLOW
BRN : BROWN	ORG : ORANGE	RED : RED	
A*P	: PRINTED CIRCUIT BOARD	PTC*	: THERMISTOR PTC
BS*	: PUSH BUTTON ON / OFF, OPERATION SWITCH	Q*	: INSULATED GATE BIPOLAR TRANSISTOR (IGBT)
BZ, H*O	: BUZZER	Q*DI	: EARTH LEAK CIRCUIT BREAKER
C*	: CAPACITOR	Q*L	: OVERLOAD PROTECTOR
CN*, E*AC*, HA*, HE, HL*, HN*, HR*, MR*_A, MR*_B, S*, X*A	: CONNECTION, CONNECTOR	Q*M	: THERMO SWITCH
D*, V*D	: DIODE	R*	: RESISTOR
DB*	: DIODE BRIDGE	R*T	: THERMISTOR
DS*	: DIP SWITCH	RC	: RECEIVER
E*H	: HEATER	S*C	: LIMIT SWITCH
F*U, FU* (FOR CHARACTERISTICS REFER TO PCB INSIDE YOUR UNIT)	: FUSE	S*L	: FLOAT SWITCH
FG*	: CONNECTOR (FRAME GROUND)	S*NPH	: PRESSURE SENSOR (HIGH)
H*	: HARNESS	S*NPL	: PRESSURE SENSOR (LOW)
H*P, LED*, V*L	: PILOT LAMP, LIGHT EMITTING DIODE	S*PH, HPS*	: PRESSURE SWITCH (HIGH)
HAP	: LIGHT EMITTING DIODE (SERVICE MONITOR GREEN)	S*PL	: PRESSURE SWITCH (LOW)
IES	: INTELLIGENT EYE SENSOR	S*T	: THERMOSTAT
IPM*	: INTELLIGENT POWER MODULE	S*W, SW*	: OPERATION SWITCH
K*R, KCR, KFR, KHuR	: MAGNETIC RELAY	SA*	: SURGE ARRESTOR
L	: LIVE	SR*, WLU	: SIGNAL RECEIVER
L*	: COIL	SS*	: SELECTOR SWITCH
L*R	: REACTOR	SHEET METAL	: TERMINAL STRIP FIXED PLATE
M*	: STEPPER MOTOR	T*R	: TRANSFORMER
M*C	: COMPRESSOR MOTOR	TC, TRC	: TRANSMITTER
M*F	: FAN MOTOR	V*, R*V	: VARISTOR
M*P	: DRAIN PUMP MOTOR	V*R	: DIODE BRIDGE
M*S	: SWING MOTOR	WRC	: WIRELESS REMOTE CONTROLLER
MR*, MRCW*, MRM*, MRN*	: MAGNETIC RELAY	X*	: TERMINAL
N	: NEUTRAL	X*M	: TERMINAL STRIP (BLOCK)
PAM	: PULSE-AMPLITUDE MODULATION	Y*E	: ELECTRONIC EXPANSION VALVE COIL
PCB*	: PRINTED CIRCUIT BOARD	Y*R, Y*S	: REVERSING SOLENOID VALVE COIL
PM*	: POWER MODULE	Z*C	: FERRITE CORE
PS	: SWITCHING POWER SUPPLY	ZF, Z'F	: NOISE FILTER

# Indoor Unit Installation

## 4. Wiring

- 1) Strip wire ends (15mm).
- 2) Match wire colours with terminal numbers on indoor and outdoor unit's terminal blocks and firmly screw wires to the corresponding terminals.
- 3) Connect the earth wires to the corresponding terminals.
- 4) Pull wires to make sure that they are securely latched up, then retain wires with wire retainer.
- 5) Shape the wires so that the service lid fits securely, then close service lid.

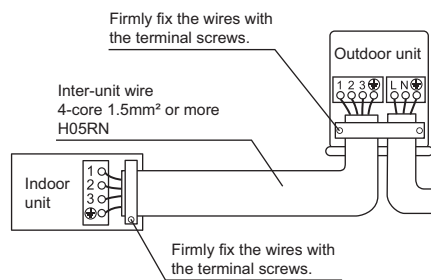
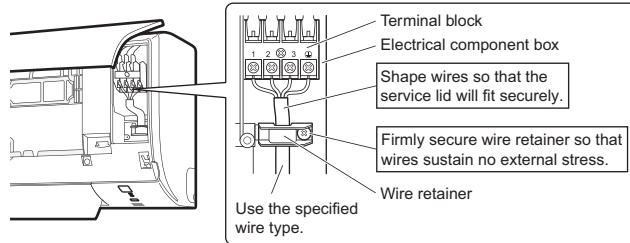

### WARNING

- Do not use tapped wires, stranded wires, extension cords, or starburst connections, as they may cause overheating, electrical shock, or fire.
- Do not use locally purchased electrical parts inside the product. (Do not branch the power for the drain pump, etc., from the terminal block.) Doing so may cause electric shock or fire.
- Do not connect the power wire to the indoor unit. Doing so may cause electric shock or fire.

# Indoor Unit Installation

## 5. Drain piping

1) Connect the drain hose, as described right.

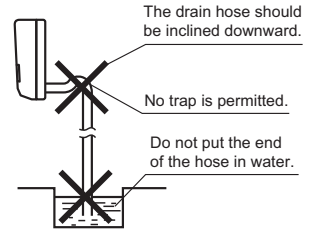

2) Remove the air filters and pour some water into the drain pan to check the water flows smoothly.

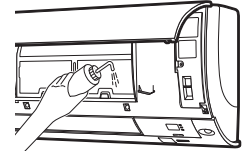

3) If drain hose extension or embedded drain piping is required, use appropriate parts that match the hose front end.  
[Figure of hose front end]

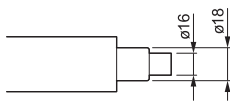

4) When extending the drain hose, use a commercially available extension hose with an inner diameter of 16mm. Be sure to thermally insulate the indoor section of the extension hose.

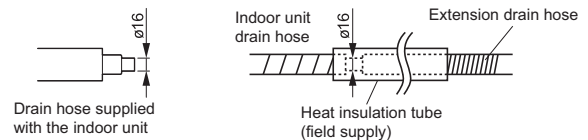

5) When connecting a rigid polyvinyl chloride pipe (nominal diameter 13mm) directly to the drain hose attached to the indoor unit as with embedded piping work, use any commercially available drain socket (nominal diameter 13mm) as a joint.

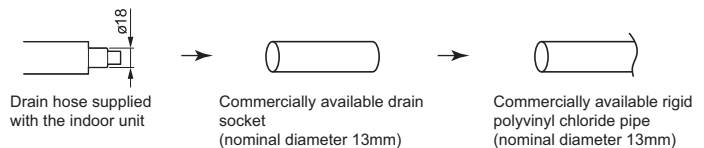

# Refrigerant Piping Work

## 1. Flaring the pipe end

- 1) Cut the pipe end with a pipe cutter.
- 2) Remove burrs with the cut surface facing downward so that the chips do not enter the pipe.
- 3) Put the flare nut on the pipe.
- 4) Flare the pipe.
- 5) Check that the flaring is properly made.



Set exactly at the position shown below.

		Flaring	
		Flare tool for R410A	Conventional flare tool
		Clutch-type	Clutch-type (Rigid-type) Wing-nut type (Imperial-type)
A	Die	0-0.5mm	1.0-1.5mm 1.5-2.0mm

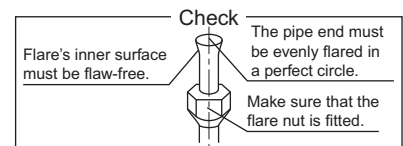

### ⚠ WARNING

- Do not use mineral oil on flared part.
- Prevent mineral oil from getting into the system as this would reduce the lifetime of the units.
- Never use piping which has been used for previous installations. Only use parts which are delivered with the unit.
- Never install a dryer to this R410A unit in order to guarantee its lifetime.
- The drying material may dissolve and damage the system.
- Incomplete flaring may cause refrigerant gas leakage.



# Refrigerant Piping Work

## 2. Refrigerant piping

### ⚠ CAUTION

- Use the flare nut fixed to the main unit. (To prevent cracking of the flare nut by aged deterioration.)
- To prevent gas leakage, apply refrigeration oil only to the inner surface of the flare. (Use refrigeration oil for R410A.)
- Use torque wrenches when tightening the flare nuts to prevent damage to the flare nuts and gas leakage.

Align the centres of both flares and tighten the flare nuts 3 or 4 turns by hand. Then tighten them fully with the torque wrenches.

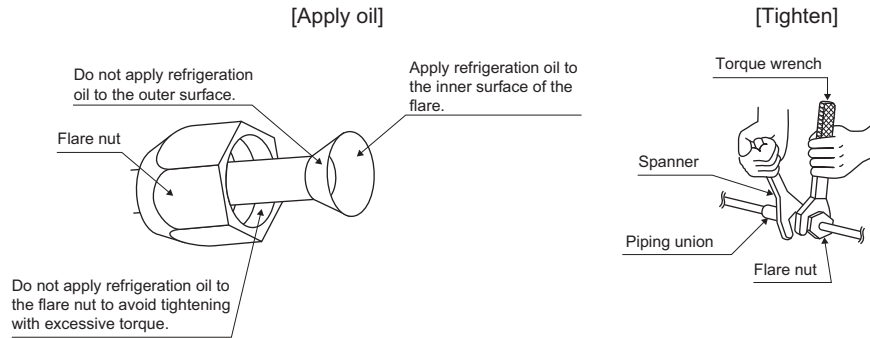

Flare nut tightening torque	
Gas side	Liquid side
1/2 inch	1/4 inch
49.5-60.3N · m (505-615kgf · cm)	14.2-17.2N · m (144-175kgf · cm)

### 2-1. Caution on piping handling

- 1) Protect the open end of the pipe against dust and moisture.
- 2) All pipe bends should be as gentle as possible. Use a pipe bender for bending.

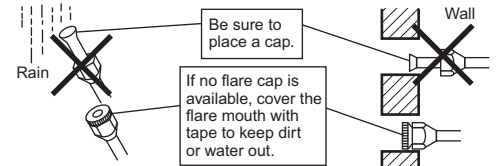

### 2-2. Selection of copper and heat insulation materials

- When using commercial copper pipes and fittings, observe the following:
  - 1) Insulation material: Polyethylene foam  
Heat transfer rate: 0.041 to 0.052W/mK (0.035 to 0.045kcal/mh°C)  
Refrigerant gas pipe's surface temperature reaches 110°C max.  
Choose heat insulation materials that will withstand this temperature.

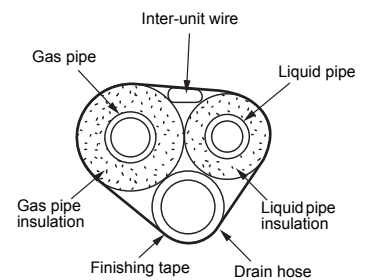

- 2) Be sure to insulate both the gas and liquid piping and to provide insulation dimensions as below.

Gas side	Liquid side	Gas pipe thermal insulation	Liquid pipe thermal insulation
O.D. 12.7mm	O.D. 6.4mm	I.D. 12-15mm	I.D. 8-10mm
Minimum bend radius		Thickness 10mm min.	
30mm or more			
Thickness 0.8mm (C1220T-O)			



- 3) Use separate thermal insulation for gas and liquid refrigerant pipes.



# Trial Operation and Testing

## 1. Trial operation and testing

- Trial operation should be carried out in either COOL or HEAT operation.
- 1-1. Measure the supply voltage and make sure that it is within the specified range.**
- 1-2. In COOL operation, select the lowest programmable temperature; in HEAT operation, select the highest programmable temperature.**
- 1-3. Carry out the trial operation in accordance with the operation manual to ensure that all functions and parts, such as flap movement, are working properly.**
  - For protection, the system disables restart operation for 3 minutes after it is turned off.
- 1-4. After trial operation is complete, set the temperature to a normal level (26°C to 28°C in COOL operation, 20°C to 24°C in HEAT operation).**

- When operating the air conditioner in COOL operation in winter, set it to the trial operation mode using the following method.

1) Press ,  and  at the same time.

2) Press , select , press .

3) Press  or  to turn on the system.

- Trial operation will stop automatically after about 30 minutes.

To stop the operation, press .

- Some of the functions cannot be used in the trial operation mode.

- The air conditioner draws a small amount of power in its standby mode. If the system is not to be used for some time after installation, shut off the circuit breaker to eliminate unnecessary power consumption.
- If the circuit breaker trips to shut off the power to the air conditioner, the system will restore the original operation mode when the circuit breaker is opened again.

## 2. Test items

Test items	Symptom	Check
Indoor and outdoor units are installed properly on solid bases.	Fall, vibration, noise	
No refrigerant gas leaks.	Incomplete cooling/heating function	
Refrigerant gas and liquid pipes and indoor drain hose extension are thermally insulated.	Water leakage	
Draining line is properly installed.	Water leakage	
System is properly earthed.	Electrical leakage	
The specified wires are used for inter-unit wiring.	Inoperative or burn damage	
Indoor or outdoor unit's air inlet or air outlet are unobstructed	Incomplete cooling/heating function	
Stop valves are opened.	Incomplete cooling/heating function	
Indoor unit properly receives remote control commands.	No operation	



**DAIKIN INDUSTRIES CZECH REPUBLIC s.r.o.**

U Nové Hospody 1/1155, 301 00 Plzeň Skvrňany, Czech Republic

**DAIKIN EUROPE N.V.**

Zandvoordestraat 300, B-8400 Oostende, Belgium

Copyright 2015 Daikin



3P393185-5J 2015.10