



User reference guide

Daikin room air conditioner



CTXM15N2V1B

FTXM20N2V1B

FTXM25N2V1B

FTXM35N2V1B

FTXM42N2V1B

FTXM50N2V1B





FTXM60N2V1B





FTXM71N2V1B



User reference guide
Daikin room air conditioner

English

Table of contents

| | | | |
|--------------|---|--|-----------|
| | 5.13.2 | Night quiet mode | 14 |
| | 5.13.3 | Cooling/heating mode lock | 14 |
| 6 | | Energy saving and optimum operation | 14 |
| 7 | | Maintenance and service | 15 |
| 7.1 | | Overview: Maintenance and service | 15 |
| 7.2 | | To clean the indoor unit and user interface | 15 |
| 7.3 | | To clean the front panel | 15 |
| 7.4 | | To remove the front panel | 15 |
| 7.5 | | About the air filters | 16 |
| 7.6 | | To clean the air filters | 16 |
| 7.7 | | To clean the titanium apatite deodorizing filter | 16 |
| 7.8 | | To replace the titanium apatite deodorizing filter | 17 |
| 7.9 | | To re-install the front panel | 17 |
| 7.10 | | To take following items into account before a long idle period ... | 17 |
| 8 | | Troubleshooting | 17 |
| 8.1 | | Symptoms that are NOT system malfunctions | 18 |
| 8.1.1 | | Symptom: A sound like water flowing is heard | 18 |
| 8.1.2 | | Symptom: A blowing sound is heard | 18 |
| 8.1.3 | | Symptom: A ticking sound is heard | 18 |
| 8.1.4 | | Symptom: A whistling sound is heard | 18 |
| 8.1.5 | | Symptom: A clicking sound during operation or idle time is heard | 18 |
| 8.1.6 | | Symptom: A clapping sound is heard | 18 |
| 8.1.7 | | Symptom: White mist comes out of a unit (Indoor unit, outdoor unit) | 18 |
| 8.1.8 | | Symptom: The units can give off odours | 18 |
| 8.1.9 | | Symptom: The outdoor fan rotates while the air conditioner is not in operation | 18 |
| 8.2 | | Solving problems based on error codes | 19 |
| 8.3 | | Troubleshooting for wireless connection adapter | 19 |
| 8.4 | | Solving problems based on the LED on the outdoor unit | 20 |
| 9 | | Disposal | 21 |
| 10 | | Glossary | 21 |
| 1 | | General safety precautions | |
| 1.1 | | About the documentation | |
| | | <ul style="list-style-type: none"> The original documentation is written in English. All other languages are translations. The precautions described in this document cover very important topics, follow them carefully. The installation of the system, and all activities described in the installation manual and the installer reference guide MUST be performed by an authorised installer. | |
| 1.1.1 | | Meaning of warnings and symbols | |
| |  | DANGER Indicates a situation that results in death or serious injury. | |
| |  | DANGER: RISK OF ELECTROCUTION Indicates a situation that could result in electrocution. | |
| |  | DANGER: RISK OF BURNING Indicates a situation that could result in burning because of extreme hot or cold temperatures. | |
| |  | DANGER: RISK OF EXPLOSION Indicates a situation that could result in explosion. | |
| 1 | | About the documentation | 2 |
| 1.1 | | About the documentation | 2 |
| 1.1.1 | | Meaning of warnings and symbols | 2 |
| 1.2 | | For the user | 3 |
| 2 | | About the documentation | 3 |
| 2.1 | | About this document | 3 |
| 2.2 | | User reference guide at a glance | 3 |
| 3 | | About the system | 4 |
| 3.1 | | Indoor unit | 4 |
| 3.1.1 | | Indoor unit display | 4 |
| 3.2 | | About the user interface | 4 |
| 3.2.1 | | Components: User interface | 5 |
| 3.2.2 | | Status: User interface LCD | 5 |
| 3.2.3 | | To operate the user interface | 5 |
| 4 | | Before operation | 6 |
| 4.1 | | Overview: Before operation | 6 |
| 4.2 | | To insert the batteries | 6 |
| 4.3 | | To fix the user interface to the wall | 6 |
| 4.4 | | Clock | 6 |
| 4.4.1 | | To set the clock | 6 |
| 4.5 | | Brightness of the indoor unit display | 6 |
| 4.5.1 | | To set the brightness of the indoor unit display | 6 |
| 4.6 | | To turn on the power supply | 6 |
| 5 | | Operation | 7 |
| 5.1 | | Operation range | 7 |
| 5.2 | | When to use which feature | 7 |
| 5.3 | | Operation mode and temperature setpoint | 7 |
| 5.3.1 | | To start/stop operation and to set the temperature | 8 |
| 5.4 | | Airflow rate | 8 |
| 5.4.1 | | To adjust the airflow rate | 8 |
| 5.5 | | Airflow direction | 8 |
| 5.5.1 | | To adjust vertical airflow direction | 8 |
| 5.5.2 | | To adjust horizontal airflow direction | 8 |
| 5.5.3 | | To use 3-D airflow direction | 9 |
| 5.6 | | Comfort airflow and Intelligent eye operation | 9 |
| 5.6.1 | | Comfort airflow operation | 9 |
| 5.6.2 | | Intelligent eye operation | 9 |
| 5.6.3 | | To start/stop Comfort and Intelligent eye operation | 9 |
| 5.7 | | Powerful operation | 9 |
| 5.7.1 | | To start/stop Powerful operation | 9 |
| 5.8 | | Econo and Outdoor unit quiet operation | 10 |
| 5.8.1 | | Econo operation | 10 |
| 5.8.2 | | Outdoor unit quiet operation | 10 |
| 5.8.3 | | To start/stop Econo and Outdoor unit quiet operation | 10 |
| 5.9 | | Flash streamer air cleaning operation | 10 |
| 5.9.1 | | To start/stop Flash Streamer operation | 10 |
| 5.10 | | OFF/ON timer operation | 10 |
| 5.10.1 | | To start/stop OFF timer operation | 10 |
| 5.10.2 | | To start/stop ON timer operation | 11 |
| 5.10.3 | | To combine OFF timer and ON timer | 11 |
| 5.11 | | Weekly timer operation | 11 |
| 5.11.1 | | To set Weekly timer operation | 11 |
| 5.11.2 | | To copy reservations | 12 |
| 5.11.3 | | To confirm reservations | 12 |
| 5.11.4 | | To deactivate and reactivate Weekly timer operation | 12 |
| 5.11.5 | | To delete reservations | 12 |
| 5.12 | | Wireless LAN connection | 13 |
| 5.12.1 | | Precautions when using the wireless adapter | 13 |
| 5.12.2 | | To install the Daikin Online Controller application | 13 |
| 5.12.3 | | Wireless adapter components | 13 |
| 5.13 | | About Multi system | 13 |
| 5.13.1 | | Priority room setting | 13 |

| | |
|---|---|
|  | WARNING Indicates a situation that could result in death or serious injury. |
|  | WARNING: FLAMMABLE MATERIAL |
|  | CAUTION Indicates a situation that could result in minor or moderate injury. |
|  | NOTICE Indicates a situation that could result in equipment or property damage. |
|  | INFORMATION Indicates useful tips or additional information. |

| Symbol | Explanation |
|---|--|
|  | Before installation, read the installation and operation manual, and the wiring instruction sheet. |
|  | Before performing maintenance and service tasks, read the service manual. |
|  | For more information, see the installer and user reference guide. |

1.2 For the user

- If you are NOT sure how to operate the unit, contact your installer.
- This appliance can be used by children aged from 8 years and above and persons with reduced physical, sensory or mental capabilities or lack of experience and knowledge if they have been given supervision or instruction concerning use of the appliance in a safe way and understand the hazards involved. Children shall NOT play with the appliance. Cleaning and user maintenance shall NOT be made by children without supervision.

| | |
|---|---|
|  | WARNING To prevent electric shocks or fire: <ul style="list-style-type: none"> ▪ Do NOT rinse the unit. ▪ Do NOT operate the unit with wet hands. ▪ Do NOT place any objects containing water on the unit. |
|---|---|

| | |
|---|--|
|  | NOTICE <ul style="list-style-type: none"> ▪ Do NOT place any objects or equipment on top of the unit. ▪ Do NOT sit, climb or stand on the unit. |
|---|--|

- Units are marked with the following symbol:



This means that electrical and electronic products may NOT be mixed with unsorted household waste. Do NOT try to dismantle the system yourself: the dismantling of the system, treatment of the refrigerant, of oil and of other parts must be done by an authorized installer and must comply with applicable legislation. Units must be treated at a specialized treatment facility for reuse, recycling and recovery. By ensuring this product is disposed of correctly, you will help to prevent potential negative consequences for the environment and human health. For more information, contact your installer or local authority.

- Batteries are marked with the following symbol:



This means that the batteries may NOT be mixed with unsorted household waste. If a chemical symbol is printed beneath the symbol, this chemical symbol means that the battery contains a heavy metal above a certain concentration. Possible chemical symbols are: Pb: lead (>0.004%). Waste batteries must be treated at a specialized treatment facility for reuse. By ensuring waste batteries are disposed of correctly, you will help to prevent potential negative consequences for the environment and human health.

2 About the documentation

2.1 About this document

Thank you for purchasing this product. Please:

- Keep the documentation for future reference.

Target audience

End users



INFORMATION

This appliance is intended to be used by expert or trained users in shops, in light industry, and on farms, or for commercial and household use by lay persons.

Documentation set

This document is part of a documentation set. The complete set consists of:

- **General safety precautions:**
 - Safety instructions that you must read before operating your system
 - Format: Paper (in the box of the indoor unit)
- **Operation manual:**
 - Quick guide for basic usage
 - Format: Paper (in the box of the indoor unit)
- **User reference guide:**
 - Detailed step-by-step instructions and background information for basic and advanced usage
 - Format: Digital files on <http://www.daikineurope.com/support-and-manuals/product-information/>

Latest revisions of the supplied documentation may be available on the regional Daikin website or via your installer.

The original documentation is written in English. All other languages are translations.

2.2 User reference guide at a glance

| Chapter | Description |
|----------------------------|--|
| General safety precautions | Safety instructions that you MUST read before operation |
| About the documentation | What documentation exists for the user |
| About the system | <ul style="list-style-type: none"> ▪ Operation range ▪ Description of indoor unit and user interface |
| Before operation | What to do before starting operation |
| Operation | How and when to use certain features |

3 About the system

| Chapter | Description |
|-------------------------------------|--------------------------------------|
| Energy saving and optimum operation | How to save energy |
| Maintenance and service | How to maintain and service the unit |
| Troubleshooting | What to do in case of problems |
| Disposal | How to dispose of the system |
| Glossary | Definition of terms |

- c Front panel
- d Service cover
- e Place for wireless adapter
- f Indoor unit display
- g Intelligent eye sensor
- h Room temperature sensor
- i Only for class 15~42: Titanium apatite deodorizing filter (without frame)
- j Only for class 50~71: Titanium apatite deodorizing filter (with frame)
- k Air filter
- l Flaps (horizontal blades)
- m Louvers (vertical blades)

3 About the system



WARNING: FLAMMABLE MATERIAL

The refrigerant inside this unit is mildly flammable.

3.1 Indoor unit



CAUTION

Do NOT insert fingers, rods or other objects into the air inlet or outlet. When the fan is rotating at high speed, it will cause injury.



INFORMATION

The sound pressure level is less than 70 dBA.



WARNING

- Do not modify, disassemble, remove, reinstall or repair the unit yourself as incorrect dismantling or installation may cause an electric shock or fire. Contact your dealer.
- In case of accidental refrigerant leaks, make sure there are no naked flames. The refrigerant itself is entirely safe, non-toxic and mildly flammable, but it will generate toxic gas when it accidentally leaks into a room where combustible air from fan heaters, gas cookers, etc. is present. Always have qualified service personnel confirm that the point of leakage has been repaired or corrected before resuming operation.



INFORMATION

The following figures are just examples and may NOT completely match your system layout.

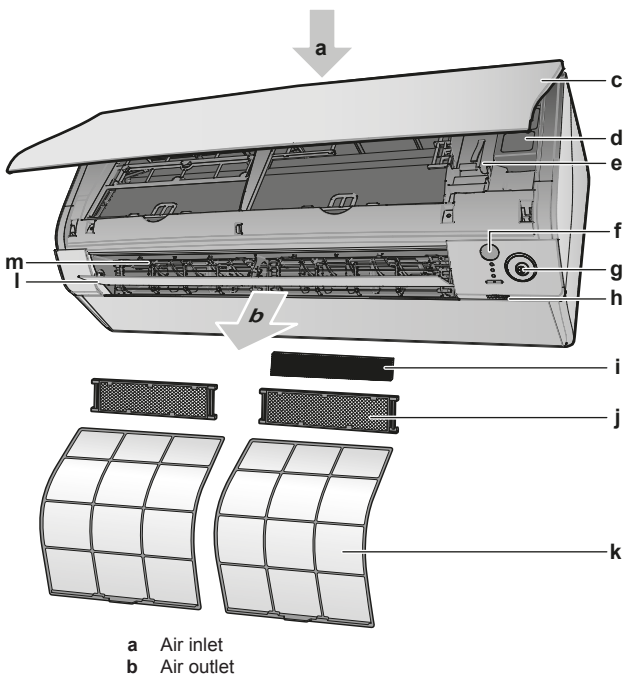

- a Air inlet
- b Air outlet

3.1.1 Indoor unit display

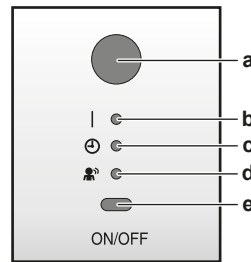

- a Signal receiver for user interface
- b Operation lamp
- c Timer lamp
- d Intelligent eye lamp
- e ON/OFF button

ON/OFF button

If the user interface is missing, you can use the ON/OFF button on the indoor unit to start/stop operation. When operation is started using this button, the following settings are used:

- Operation mode = Automatic
- Temperature setting = 25°C
- Airflow rate = Automatic

3.2 About the user interface

- **Direct sunlight.** Do NOT expose the user interface to direct sunlight.
- **Dust.** Dust on the signal transmitter or receiver will reduce sensitivity. Wipe off dust with a soft cloth.
- **Fluorescent lights.** Signal communication might be disabled if fluorescent lamps are in the room. In that case, contact your installer.
- **Other appliances.** If the user interface signals operate other appliances, move the other appliances, or contact your installer.
- **Curtains.** Make sure that the signal between the unit and the user interface is NOT blocked by curtains or other objects.



NOTICE

- Do NOT drop the user interface.
- Do NOT let the user interface get wet.

3.2.1 Components: User interface

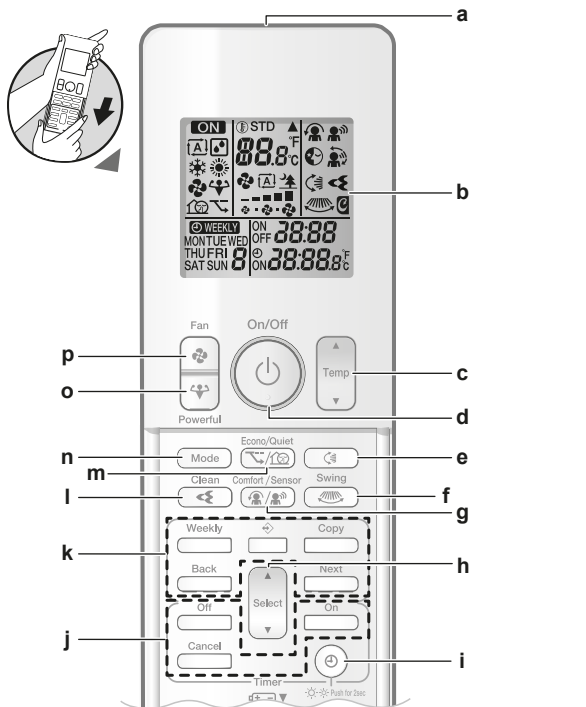

- a Signal transmitter
- b LCD display
- c Temperature adjustment button
- d ON/OFF button
- e Vertical swing button
- f Horizontal swing button
- g Comfort airflow and Intelligent eye operation button
- h Select button
- i Clock button and indoor unit display brightness
- j Buttons for ON/OFF timer operation
- k Buttons for Weekly timer operation
- l Streamer
- m Econo and Outdoor unit quiet operation button
- n Mode button
- o Powerful button
- p Fan button

3.2.2 Status: User interface LCD

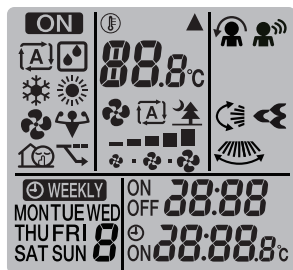

| Icon | Description |
|-----------|--|
| ON | Operation is active |
| A | Operation mode = Automatic |
| | Operation mode = Drying |
| | Operation mode = Heating |
| | Operation mode = Cooling |
| | Operation mode = Fan only |
| | Powerful operation is active |
| | Econo operation is active |
| | Outdoor unit quiet operation is active |

| Icon | Description |
|--------------------------------|---|
| | The indoor unit receives a signal from the user interface |
| | Current temperature setting |
| | Airflow rate = Automatic |
| | Airflow rate = Indoor unit quiet |
| | Airflow rate = High |
| | Airflow rate = Medium high |
| | Airflow rate = Medium |
| | Airflow rate = Medium low |
| | Airflow rate = Low |
| | Comfort operation is active |
| | Intelligent eye is active |
| | Automatic vertical swing is active |
| | Automatic horizontal swing is active |
| | Streamer is active |
| ON 20:08 | ON timer is active |
| OFF 20:08 | OFF timer is active |
| WEEKLY | Weekly timer is active |
| MONTUEWED THUFRI SATSUN | Day of the week |
| 20:28 | Current time |

3.2.3 To operate the user interface

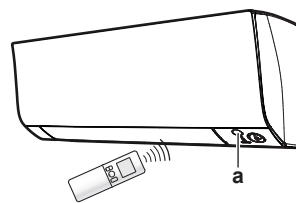

a Signal receiver

- 1 Aim the signal transmitter at the signal receiver on the indoor unit (maximum distance for communication is 7 m).

Result: When the indoor unit receives a signal from the user interface, you will hear a sound:

| Sound | Description |
|-----------|-------------------|
| Beep-beep | Operation starts. |
| Beep | Setting changes. |
| Long beep | Operation stops. |

4 Before operation

4 Before operation

4.1 Overview: Before operation

This chapter describes what you have to do before operating the unit.

Typical workflow

Before operation usually consist of the following stages:

- Inserting the batteries in the user interface.
- Fixing the user interface to the wall.
- Setting the brightness of the indoor unit display.
- Setting the clock.
- Turning on the power supply.

4.2 To insert the batteries

The batteries will last for about 1 year.

- 1 Remove the front cover.
- 2 Insert both batteries at once.
- 3 Put back the front cover.

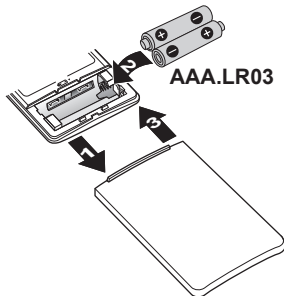

i INFORMATION

- Low energy of battery is indicated by flashing of LCD display.
- ALWAYS replace both batteries at once.

4.3 To fix the user interface to the wall

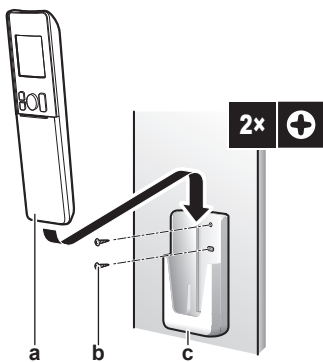

- a User interface
- b Screws (field supply)
- c User interface holder

- 1 Choose a place where the signals reach the unit.
- 2 Attach the holder with screws to the wall or a similar location.
- 3 Hang the user interface on the user interface holder.

4.4 Clock

If the indoor unit's internal clock is NOT set to the correct time, the ON timer, OFF timer and weekly timer will NOT operate correctly. The clock must be set again:

- After a circuit breaker has turned the unit OFF.
- After a power failure.
- After replacing batteries in the user interface.



4.4.1 To set the clock

Note: If the time is NOT set, MON, ☉, and 0:00 blink.

- 1 Press ☉.

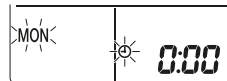
Result: MON and ☉ blink



- 2 Press  or  to set the current day of the week.

Note: Holding down  or  increases or decreases the time setting rapidly.

| Display | Day of the week |
|---------|-----------------|
| MON | Monday |
| TUE | Tuesday |
| WED | Wednesday |
| THU | Thursday |
| FRI | Friday |
| SAT | Saturday |
| SUN | Sunday |

- 3 Press ☉.

Result: ☉ blinks.

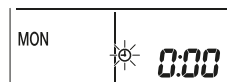

- 4 Press  or  to set the correct time.

- 5 Press ☉.

Result: Setting is complete. ☉ blinks.

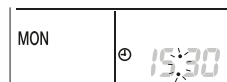

4.5 Brightness of the indoor unit display

Adjust the brightness of the indoor unit display as desired, or turn OFF the display.

4.5.1 To set the brightness of the indoor unit display

- 1 Keep pressed ☉ for at least 2 seconds every time you need to change the setting.

Result: Brightness will be changed in order: high, low, off.

4.6 To turn on the power supply

- 1 Turn the circuit breaker on.

Result: The flap of the indoor unit will open and close to set the reference position.

5 Operation

5.1 Operation range

Use the system in the following temperature and humidity ranges for safe and effective operation.

| In combination with outdoor unit RZAG | | |
|---------------------------------------|-----------------------------------|----------------------------|
| | Cooling and drying ^(a) | Heating ^(a) |
| Outdoor temperature | -20~52°C DB | -20~24°C DB -21~18°C WB |
| Indoor temperature | 17~38°C DB 12~28°C WB | 10~27°C DB |
| Indoor humidity | ≤80% ^(b) | — |

| In combination with outdoor units: RXM71N, 2MXM, 3MXM, 4MXM, 5MXM | | |
|---|-----------------------------------|----------------------------|
| | Cooling and drying ^(a) | Heating ^(a) |
| Outdoor temperature | -10~46°C DB | -15~24°C DB -15~18°C WB |
| Indoor temperature | 18~37°C DB 14~28°C WB | 10~30°C DB |
| Indoor humidity | ≤80% ^(b) | — |

| In combination with other outdoor units | | |
|---|-----------------------------------|----------------------------|
| | Cooling and drying ^(a) | Heating ^(a) |
| Outdoor temperature | -10~50°C DB | -20~24°C DB -21~18°C WB |
| Indoor temperature | 18~37°C DB 14~28°C WB | 10~30°C DB |
| Indoor humidity | ≤80% ^(b) | — |

If operated outside the operation range:

- (a) A safety device might stop the operation of the system.
- (b) Condensation might occur on the indoor unit and drip.

5.2 When to use which feature

You can use the following table to determine which features to use:



INFORMATION

Operation modes: **cooling**, **drying** and **automatic** are NOT available for the **heating only** version of the product.

| Feature | Tasks |
|---------------------------------|---|
| Basic features | |
| Operation modes and temperature | To start/stop the system and to set the temperature: <ul style="list-style-type: none"> ▪ In Heating and Cooling mode, heat up or cool down a room. ▪ In Fan only mode, blow air in a room without heating or cooling. ▪ In Drying mode, decrease the humidity in a room. ▪ In Automatic mode, an appropriate temperature and operation mode is automatically selected. |

| Feature | Tasks |
|----------------------------|---|
| + Airflow direction | To adjust the airflow direction (swing or fixed position). |
| Airflow rate | To adjust the amount of air blown into the room. To run more quietly. |
| Advanced features | |
| Streamer | To remove airborne allergens such as mold, pollen, adjuvant substances, viruses, bacteria... |
| Econo | To use the system when you are also using other power-consuming appliances. To save energy. |
| Outdoor unit quiet | To decrease the noise level of the outdoor unit. Example: At night. |
| Comfort | To automatically adjust the airflow direction to cool down or heat up the room more effectively. |
| Intelligent eye | To prevent the air from coming in direct contact with people. To save energy when nobody is in the room. |
| Powerful | To cool down or heat up the room quickly. |
| ON timer + OFF timer | To automatically turn ON or OFF the system. |
| Weekly timer | To automatically turn ON or OFF the system on a weekly basis. |
| Additional features | |
| Wireless LAN connection | To operate the unit using smart appliances. |

5.3 Operation mode and temperature setpoint

When. Adjust the system operation mode and set the temperature when you want to:

- Heat up or cool down a room
- Blow air in a room without heating or cooling
- Decrease the humidity in a room

What. The system operates differently, depending on the user selection.



INFORMATION

Operation modes: **cooling**, **drying** and **automatic** are NOT available for the **heating only** version of the product.

| Setting | Description |
|-----------|---|
| Automatic | The system cools down or heats up a room to the temperature setpoint. It automatically switches between cooling and heating if necessary. |
| Drying | The system decreases the humidity in a room without changing the temperature. |
| Heating | The system heats up a room to the temperature setpoint. |
| Cooling | The system cools down a room to the temperature setpoint. |

5 Operation

| Setting | Description |
|---------|--|
| Fan | The system only controls the airflow (airflow rate and airflow direction). The system does NOT control the temperature. |

Additional info:

- **Outside temperature.** The system's cooling or heating effect decreases when the outside temperature is too high or too low.
- **Defrost operation.** During heating operation, frost might occur on the outdoor unit and decrease the heating capacity. In that case, the system automatically switches to defrosting operation to remove the frost. During defrosting operation, hot air is NOT blown from the indoor unit.
- **Humidity sensor.** Control the humidity by decreasing the humidity during cooling process.

5.3.1 To start/stop operation and to set the temperature



ON: Unit is operating.

A: Operation mode = Automatic

: Operation mode = Drying

: Operation mode = Cooling

: Operation mode = Heating

: Operation mode = Fan only

88.8°C: Shows the set temperature.

- 1 Press **Mode** one or more times to select the operation mode.

Result: The mode will be set as follows:



- 2 Press **Power** to **start** operation.

Result: **ON** and the selected mode are displayed on the LCD.

- 3 Press **Temp** or **Temp** one or more times to lower or raise the temperature.

| Cooling operation | Heating operation | Automatic operation | Drying or Fan only operation |
|-------------------|-------------------|---------------------|------------------------------|
| 18~32°C | 10~30°C | 18~30°C | — |

Note: When using **drying** or **fan only** mode, you cannot adjust the temperature.

- 4 Press **Power** to **stop** operation.

Result: **ON** disappears from the LCD. The operation lamp goes off.

5.4 Airflow rate

- 1 Press **Mode** to choose:

| | |
|----------|---|
| | 5 airflow rate levels, from "==" to "■" |
| A | Automatic operation |
| | Indoor unit quiet operation. When the airflow is set to "■", the noise from the unit will be reduced. |

i INFORMATION

- If the unit reach the temperature setpoint in cooling, heating or automatic mode. Fan will stop operating.
- When using drying operation mode, you CANNOT adjust the airflow rate setting.

5.4.1 To adjust the airflow rate

- 1 Press **Mode** to change the airflow setting as follows:



5.5 Airflow direction

When. Adjust the airflow direction as desired.

What. The system directs the airflow differently, depending on the user selection (swinging or fixed position). It does so by moving horizontal blades (flaps) or vertical blades (louvers).

| Setting | Airflow direction |
|----------------------------|--|
| Vertical automatic swing | Moves up and down. |
| Horizontal automatic swing | Moves from side to side. |
| 3-D airflow direction | Moves simultaneously up and down and from side to side |
| [-] | Stays in a fixed position. |

! CAUTION

- ALWAYS use a user interface to adjust the position of the flaps and louvers. When the flaps and louvers are swinging and you move them forcibly by hand, the mechanism will break.

The movable range of the flap varies according to the operation mode. The flap will stop at the upper position when the airflow rate is changed to low during the up and down swing setting.

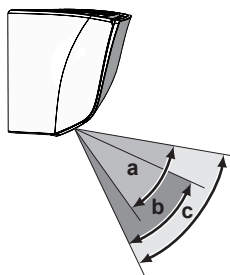

- a Flap range in cooling or drying operation
- b Flap range in heating operation
- c Flap range in fan only operation

5.5.1 To adjust vertical airflow direction

- 1 Press **Mode**.

Result: appears on the LCD. The flaps (horizontal blades) will begin to swing.

- 2 To use fixed position, press **Mode** when the flaps reach the desired position.

Result: disappears from the LCD. The flaps will stop moving.

5.5.2 To adjust horizontal airflow direction

- 1 Press **Mode**.

Result:  appears on the LCD. The louvers (vertical blades) will begin to swing.

- To use fixed position, press  when the louvers reach the desired position.



Result:  disappears from the LCD. The louvers will stop moving.

i INFORMATION



When the unit is installed in a corner of a room, the direction of the louvers should be facing away from the wall. Efficiency will drop if a wall blocks the air.

5.5.3 To use 3-D airflow direction

- Press  and .

Result:  and  appear on the LCD. The flaps (horizontal blades) and louvers (vertical blades) will begin to swing.

- To use fixed position, press  and  when the flaps and louvers reach the desired position.

Result:  and  disappear from the LCD. The flaps and the louvers will stop moving.

5.6 Comfort airflow and Intelligent eye operation

You can use Comfort and Intelligent eye operation separately, or combine them.

5.6.1 Comfort airflow operation

This operation can be used in **heating** or **cooling** operation mode. It will provide a comfortable wind that will NOT come in direct contact with people. The system automatically sets the fixed airflow position upward in Cooling and downward in Heating operation mode.

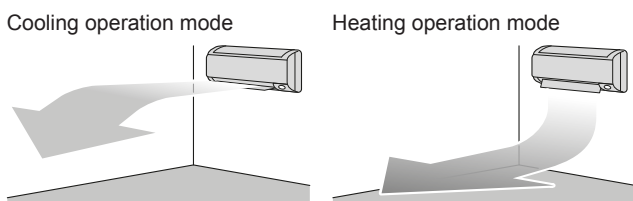

i INFORMATION

Powerful and Comfort airflow operation CANNOT be used at the same time. The last selected function takes priority. If the vertical automatic swing is selected, Comfort airflow operation will be cancelled.

5.6.2 Intelligent eye operation

The system detects movement in the room and automatically adjusts the airflow direction and temperature in order to avoid direct contact with people. If no movement is detected for 20 minutes, the system switches to energy saving operation:

| Operation | Energy saving operation |
|--------------------|--|
| Heating | Temperature is lowered by 2°C. |
| Cooling and drying | If the temperature in the room is: <ul style="list-style-type: none"> <30°C, the temperature is raised by 2°C ≥30°C, the temperature is raised by 1°C |
| Fan only | Decreases airflow rate. |

! NOTICE

- Do NOT hit or push the Intelligent eye sensor. Doing so may lead to malfunction.
- Do NOT place large objects near the Intelligent eye sensor.

i INFORMATION

Powerful or Night set operation CANNOT be used at the same time with Intelligent eye operation. The last selected function takes priority.

- Detection range.** Up to 7 m.

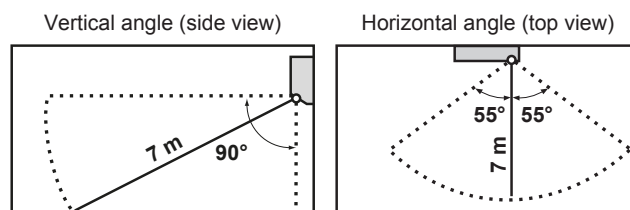



- Detection sensitivity.** Changes according to location, the number of persons in the room, temperature range, etc.
- Detection mistakes.** The sensor may mistakenly detect pets, sunlight, moving curtains, etc.

5.6.3 To start/stop Comfort and Intelligent eye operation

- Press  one or more times.

Result: The setting will change as follows:



| Display | Operation |
|---|-------------------------------------|
|  | Comfort airflow |
|  | Intelligent eye |
|  | Comfort airflow and Intelligent eye |
| — | Both deactivated |

Note: If there are people close to the front of the indoor unit or there are too many people, use both operations at the same time.

- To stop operation, press  until both symbols disappear from the LCD.

5.7 Powerful operation

This operation quickly maximizes the cooling/heating effect in any operation mode. You can get the maximum capacity.

i INFORMATION

Powerful operation CANNOT be used together with Econo, Comfort airflow, Intelligent eye and Outdoor unit quiet operation. The last selected function takes priority.

Powerful operation will NOT increase the capacity of the unit if it already operates at maximum capacity.

5.7.1 To start/stop Powerful operation

- Press  to start.



Result:  is displayed on the LCD. Powerful operation runs for 20 minutes; after that, operation returns to the previously set mode.

5 Operation

| Mode | Airflow rate |
|---------------------------|---|
| Cooling/Heating/Automatic | <ul style="list-style-type: none"> To maximize the cooling/heating effect, the capacity of outdoor unit is increased. The airflow rate is fixed to the maximum setting and CANNOT be changed. The temperature can be set only in Automatic mode. |
| Drying | <ul style="list-style-type: none"> The temperature setting is lowered by 2.5°C. The airflow rate is slightly increased. |
| Fan only | The airflow rate is fixed to the maximum setting. |

2 Press  to stop.

Result:  disappears from the LCD.

Note: Powerful operation can be set only when the unit is running. If you press , operation will be cancelled;  disappears from the LCD.

5.8 Econo and Outdoor unit quiet operation

5.8.1 Econo operation

This is a function which enables efficient operation by limiting the maximum power consumption value. This function is useful for cases in which attention should be paid to ensure a circuit breaker will not trip when the product runs alongside other appliances.

INFORMATION

- Powerful and Econo operation CANNOT be used at the same time. The last selected function takes priority.
- Econo operation reduces power consumption of the outdoor unit by limiting the rotation speed of the compressor. If power consumption is already low, Econo operation will NOT further reduce power consumption.

5.8.2 Outdoor unit quiet operation

Use Outdoor unit quiet operation when you want to decrease the noise level of the outdoor unit. **Example:** At night.

INFORMATION



- Powerful and Outdoor unit quiet operation CANNOT be used at the same time. The last selected function takes priority.
- This function is only available in Automatic, Cooling, and Heating operation.
- Outdoor unit quiet operation limits the rotation speed of the compressor. If the rotation speed of compressor is already low, Outdoor unit quiet operation will NOT further reduce the compressor rotation speed.

5.8.3 To start/stop Econo and Outdoor unit quiet operation



1 Press  one or more times.

Result: The setting will change as follows.



| Display | Operation |
|---|------------------------------|
|  | Econo |
|  | Outdoor unit quiet |
|  | Econo and Outdoor unit quiet |
| — | Both deactivated |

2 To stop operation, press  until both symbols disappear from the LCD.

Note: Econo operation can be only set when the unit is running. Pressing  cancels the setting and  disappears from the LCD.

Note:  remains on the LCD, even if you turn off the unit using the user interface or indoor unit ON/OFF switch.

5.9 Flash streamer air cleaning operation

Streamer generates a high-speed electron stream with a high oxidizing power, reducing bad odours and viruses. Together with the titanium apatite deodorizing filter and the air filters, this function cleans the air in the room.

INFORMATION

- The high-speed electrons are generated and go away inside the unit to ensure safe operation.
- The Streamer discharge may generate a fizzing sound.
- If the airflow becomes weak, the Streamer discharge may stop temporarily to prevent ozone smell.

5.9.1 To start/stop Flash Streamer operation

1 Press .

Result:  is displayed on the LCD and the air in the room is cleaned.

2 To stop operation, press .

Result:  disappears from the LCD and operation stops.

5.10 OFF/ON timer operation

Timer functions are useful for automatically switching the air conditioner on/off at night or in the morning. You can also use OFF timer and ON timer in combination.

INFORMATION

Program the timer again in case of:



- A breaker has turned the unit off.
- A power failure.
- After replacing batteries in the user interface.

INFORMATION

The clock MUST be set correctly before using any timer functions. Refer to "4.4.1 To set the clock" on page 6.

5.10.1 To start/stop OFF timer operation

1 Press  to start.

Result:  is displayed on the LCD, the timer lamp lights up, and OFF blinks.  and the day of the week disappear from the LCD.



2 Press or to change the time setting.

3 Press again.

Result: OFF and the set time are displayed on the LCD.

Result: The timer lamp lights up.

INFORMATION

Each time or is pressed, the time setting advances by 10 minutes. Holding the button down will change the setting rapidly.

4 To stop operation, press .

Result: and OFF disappear from the LCD and the timer lamp goes off. and the day of the week are displayed on the LCD.

INFORMATION

When you set the ON/OFF timer, the time setting is stored in the memory. The memory will be reset when the user interface batteries are replaced.

Use of night set mode in combination with OFF timer

The air conditioner automatically adjusts the temperature setting (0.5°C up in cooling, 2.0°C down in heating) to prevent excessive cooling/heating and ensure a comfortable sleeping temperature.

5.10.2 To start/stop ON timer operation

1 Press to start.

Result: is displayed on the LCD, the timer lamp lights up, and ON blinks. and the day of the week disappear from the LCD.

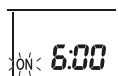

2 Press or to change the time setting.

3 Press again.

Result: ON and the set time are displayed on the LCD. The timer lamp lights up.

INFORMATION

Each time or is pressed, the time setting advances by 10 minutes. Holding the button down will change the setting rapidly.

4 To stop operation, press .

Result: and ON disappear from the LCD and the timer lamp goes off. and the day of the week are displayed on the LCD.

5.10.3 To combine OFF timer and ON timer

1 To set the timers, refer to "5.10.1 To start/stop OFF timer operation" on page 10 and "5.10.2 To start/stop ON timer operation" on page 11.

Result: OFF and ON are displayed on the LCD.

Example:

| Display | Current time | Set while... | Operation |
|---------|--------------|----------------------------|------------------------------------|
| | 6:00 | the unit is operating. | Stops at 7:00 and starts at 14:00. |
| | | the unit is NOT operating. | Starts at 14:00. |

Note: If the timer setting is active, the current time is NOT displayed on the LCD.

5.11 Weekly timer operation

With this operation, you can save up to 4 timer settings for each day of the week.

Example: Create a different setting from Monday to Friday and a different setting for weekends.

| Day of the week | Setting example |
|-----------------------|---|
| Monday | <ul style="list-style-type: none"> Make up to 4 settings. |
| Tuesday~Friday | <ul style="list-style-type: none"> Use the copy mode if the settings are the same as for Monday. |
| Saturday | <ul style="list-style-type: none"> No timer setting |
| Sunday | <ul style="list-style-type: none"> Make up to 4 settings. |

- ON-ON-ON-ON setting.** Enables scheduling the operation mode and set temperature.
- OFF-OFF-OFF-OFF setting.** Only the turn off time can be set for each day.

Note: Be sure to aim the user interface at the indoor unit and check for a receiving tone when setting the Weekly timer operation.

INFORMATION

The clock MUST be set correctly before using any timer functions. Refer to "4.4.1 To set the clock" on page 6.

INFORMATION

- Weekly timer and ON/OFF timer operation CANNOT be used at the same time. The ON/OFF timer operation takes priority. Weekly timer will be in standby, disappears from the LCD. When the ON/OFF timer is completed, the Weekly timer becomes active.
- The day of the week, ON/OFF timer mode, time and temperature (only for ON timer) can be set with the Weekly timer. Other settings are based on previous ON timer setting.

5.11.1 To set Weekly timer operation

1 Press .

Result: The day of the week and the reservation number of the current day are displayed.



2 Press or to select the day of the week and the reservation number.

3 Press .

Result: The day of the week is set. and ON blink.

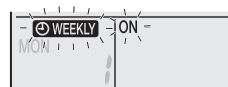

4 Press or to select the mode.

5 Operation

Result: The setting will change as follows:



| Display | Feature |
|---------|---------------------|
| ON | ON timer |
| OFF | OFF timer |
| Blank | Deletes reservation |

- 5 Press **Next**.

Result: The ON/OFF timer mode is set. **WEEKLY** and the time blink.

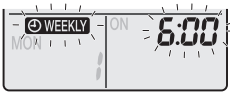

Note: Press **Back** to return to the previous screen. If blank is selected, continue to step 9.

- 6 Press **Select** or **Select** to select the time. The time can be set between 0:00~23:50 in 10-minute intervals.

- 7 Press **Next**.

Result: The time is set and **WEEKLY** and the temperature blink.



Note: Press **Back** to return to the previous screen. If OFF timer is selected, continue to step 9.

- 8 Press **Select** or **Select** to select the desired temperature.

Note: The set temperature for the weekly timer is displayed only when setting the weekly timer mode.

i INFORMATION

The temperature can be set between 10~32°C on the user interface. In cooling and automatic operation mode, the unit will operate at minimum 18°C even if is set at 10~17°C. In heating operation mode, the unit will operate at maximum 30°C even if is set at 31~32°C.

- 9 Press **Next**.

Result: The temperature and time are set for the ON timer. The time is set for the OFF timer. The timer lamp lights orange.

Result: A new reservation screen will appear.

- 10 Repeat the previous procedure to set another reservation or press **Next** to complete the setting.

Result: **WEEKLY** is displayed on the LCD.

Note: A reservation can be copied with the same settings to another day. Refer to "5.11.2 To copy reservations" on page 12.

5.11.2 To copy reservations

A reservation can be copied to another day. The complete reservation of the selected day of the week will be copied.

- 1 Press **Next**.
- 2 Press **Select** or **Select** to select the day of the week to be copied.
- 3 Press **Copy**.

Result: The reservation of the selected day of the week will be copied.

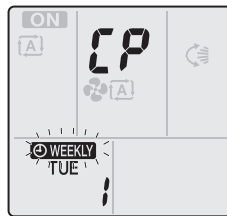

- 4 Press **Select** or **Select** to select the destination day.

- 5 Press **Copy**.

Result: The whole reservation is copied to the selected day and the timer lamp lights orange.

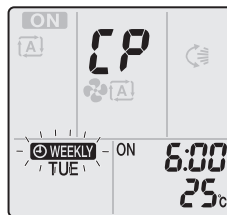

Note: To copy to another day, repeat the procedure.

- 6 Press **Next** to complete the setting.

Result: **WEEKLY** is displayed on the LCD.

Note: To change the reservation setting after copying, refer to "5.11.1 To set Weekly timer operation" on page 11.

5.11.3 To confirm reservations

You can confirm if all reservations are set to your needs.

- 1 Press **Next**.

Result: The day of the week and the reservation number of the current day are displayed.



- 2 Press **Select** or **Select** to select the day of the week and reservation number to be confirmed and check the reservation details.

Note: To change the reservation setting, refer to "5.11.1 To set Weekly timer operation" on page 11.

- 3 Press **Next** to exit the confirmation mode.

5.11.4 To deactivate and reactivate Weekly timer operation

- 1 To deactivate the Weekly timer, press **Weekly** while **WEEKLY** is displayed on the LCD.

Result: **WEEKLY** disappears from the LCD and the timer lamp goes off.

- 2 To reactivate the Weekly timer, press **Weekly** again.

Result: The last set reservation mode will be used.

5.11.5 To delete reservations

To delete individual reservations

Use this function if you want to delete a single reservation setting.

- 1 Press **Next**.

Result: The day of the week and the reservation number are displayed.

- 2 Press **Select** or **Select** to select the day of the week to be deleted.

- 3 Press **Next**.

Result: WEEKLY, ON, and OFF blink.

- 4 Press or and select "blank".

Result: The setting will change as follows:



- 5 Press .

Result: The selected reservation is deleted.

- 6 Press to exit.

Result: Remaining reservations will be active.

To delete a reservation for each day of the week

Use this function if you want to delete all reservation settings for one day of the week. This can be used in confirmation or setting mode.

- 1 Press or to select the day of the week to be deleted.
- 2 Hold for about 5 seconds.

Result: All reservations for the selected day will be deleted.

To delete all reservations

Use this function if you want to delete all reservations for all days of the week in one go. This procedure CANNOT be used in the setting mode.

- 1 Hold for about 5 seconds while in the default display.

Result: All reservations will be deleted.

5.12 Wireless LAN connection

The customer is responsible for providing:

- Smartphone, tablet or another smart device with one of the following operating systems:
 - Android 4.0.3 or later
 - iOS 7.1.2 or later
- Internet line and communication device, such as a modem, router, etc.
- Wireless LAN access point
- Installed free **Daikin Online Controller** application

5.12.1 Precautions when using the wireless adapter

Do NOT use near:

- **Medical equipment.** E.g. persons using cardiac pacemakers or defibrillators. This product may cause electromagnetic interference.
- **Auto-control equipment.** E.g. automatic doors or fire alarm equipment. This product may cause faulty behaviour of the equipment.
- **Microwave oven.** It may affect wireless LAN communications.

5.12.2 To install the Daikin Online Controller application

- 1 Open:
 - Google Play for appliances using Android.
 - App Store for appliances using iOS.
- 2 Search for **Daikin Online Controller**.
- 3 Follow the directions on the screen to install.

5.12.3 Wireless adapter components

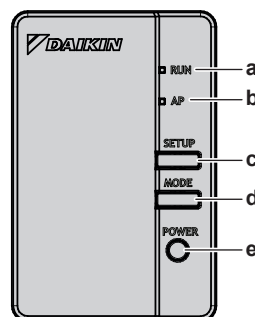

- a RUN lamp (orange)
- b AP lamp (yellow)
- c SETUP button
- d MODE button
- e POWER button

| | Purpose |
|-------|---|
| RUN | Lights when connecting to a router (Wireless LAN access point). |
| AP | Lights when connected directly to a smartphone. |
| SETUP | Use when connecting to a router (Wireless LAN access point). |
| MODE | Switches modes (RUN/AP) when held down. |
| POWER | Turns the WLAN adapter ON or OFF when pressed. |

5.13 About Multi system

In Multi system, 1 outdoor unit is connected to multiple indoor units.

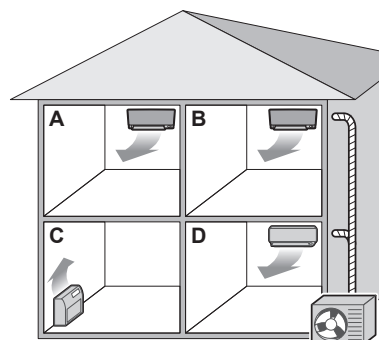

5.13.1 Priority room setting

Priority room setting requires initial programming during installation. Please consult your authorized dealer for assistance.

When priority room setting is inactive or not present

When more than 1 indoor unit is operating, priority is given to the first unit that was turned on. Set other units to the same operation mode. Otherwise, they will enter the standby mode, and the operation lamp will flash (does NOT indicate malfunction).

Exceptions: If the first unit that was turned on is set to **fan only**, and then in the other room **heating** mode is set, priority will be given to the unit set to the heating mode. The first unit will go in standby and the operation lamp will flash.

6 Energy saving and optimum operation

INFORMATION

- The cooling, drying, and fan only operation modes may be used at the same time.
- The automatic operation mode automatically selects cooling or heating, depending on the room temperature. If the automatic operation mode is selected for all units, all units will operate in the mode of the first unit that was turned on.

Priority when using Outdoor unit quiet operation

Refer to "5.8.2 Outdoor unit quiet operation" on page 10.

- 1 Set Outdoor unit quiet operation in all rooms using the user interfaces of the units.
- 2 To cancel Outdoor unit quiet operation, you may stop operation in 1 room using a user interface.

Result: Operation will stop in all rooms.  will remain on the display of the other user interfaces.

- 3 To remove the symbol from the other user interfaces, stop Outdoor unit quiet operation in all rooms separately.

Result: The  symbol will disappear.

When priority room setting is active

You can select a different operation mode for each room.

Example: Room A has priority, cooling operation mode is selected.

| Operation mode in room B, C, D | Status of room B, C and D |
|--------------------------------|---|
| Cooling, drying or fan only | Current operation mode maintained |
| Heating | Standby mode. Operation resumes when room A stops operating. |
| Automatic | If cooling operation continues. If heating units enter standby mode. Operation resumes when room A stops operating. |

Priority when using Powerful operation

Example: Room A has priority. Rooms B, C and D are operating.

- 1 Set Powerful operation in room A.

Result: Capacity in room A is increased. Cooling or heating efficiency in rooms B, C and D may be slightly reduced.

Priority when using Outdoor unit quiet operation

Example: Room A has priority.

- 2 Set Outdoor unit quiet operation on one unit.

Result: All units enter the Outdoor unit quiet operation mode at once.

5.13.2 Night quiet mode

The Night quiet mode requires initial programming during installation. Please consult your dealer for assistance. This mode reduces the operation noise of the outdoor unit during the night by reducing the cooling efficiency.

The Night quiet mode is activated automatically when the temperature drops $\geq 5^{\circ}\text{C}$ below the highest temperature recorded that day.

5.13.3 Cooling/heating mode lock

The Cooling/heating mode lock requires initial programming during installation. Please consult your authorized dealer for assistance. The Cooling/heating mode lock sets the unit forcibly to either cooling or heating operation. Activate this function if you wish to set all indoor units connected in a multi-system to 1 operation mode.

INFORMATION

The Cooling/heating mode lock CANNOT be activated together with the priority room setting.

6 Energy saving and optimum operation

INFORMATION

- Even if the unit is turned OFF, it consumes electricity.
- When the power turns back on after a power break, the previously selected mode will be resumed.

CAUTION

NEVER expose little children, plants or animals directly to the airflow.

WARNING

Do NOT place objects below the indoor and/or outdoor unit that may get wet. Otherwise condensation on the unit or refrigerant pipes, air filter dirt or drain blockage may cause dripping, and objects under the unit may get dirty or damaged.

NOTICE

Do NOT use the system for other purposes. In order to avoid any quality deterioration, do NOT use the unit for cooling precision instruments, food, plants, animals, or works of art.

CAUTION

Do NOT operate the system when using a room fumigation-type insecticide. Chemicals could collect in the unit, and endanger the health of people who are hypersensitive to chemicals.

WARNING

Do NOT place a flammable spray bottle near the air conditioner and do NOT use sprays. Doing so may result in a fire.

Observe the following precautions to ensure the system operates properly.

- Prevent direct sunlight from entering a room during cooling operation by using curtains or blinds.
- Ventilate often. Extended use requires special attention to ventilation.
- Keep doors and windows closed. If the doors and windows remain open, air will flow out of your room causing a decrease in the cooling or heating effect.
- Be careful NOT to cool or heat too much. To save energy, keep the temperature setting at a moderate level.
- NEVER place objects near the air inlet or the air outlet of the unit. Doing so may cause a reduced heating/cooling effect or stop operation.
- Turn off the main power supply switch to the unit when the unit is NOT used for longer periods of time. If the main power supply switch is on, the unit consumes electricity. Before restarting the unit, turn on the main power supply switch 6 hours before operation to ensure smooth running.
- Condensation may form if the humidity is above 80% or if the drain outlet gets blocked.

- Adjust the room temperature properly for a comfortable environment. Avoid excessive heating or cooling. Notice that it may take some time for the room temperature to reach the set temperature. Consider using the timer setting options.
- Adjust the air flow direction to avoid cool air from gathering on the floor or warm air against the ceiling. (Up during cooling or dry operation to the ceiling and down during heating operation.)
- Avoid direct air flow to room inhabitants.
- Operate the system within the recommended temperature range (26~28°C for cooling and 20~24°C for heating) to save energy.

7 Maintenance and service

7.1 Overview: Maintenance and service

The installer has to perform a yearly maintenance.

About the refrigerant

This product contains fluorinated greenhouse gases. Do NOT vent gases into the atmosphere.

Refrigerant type: R32

Global warming potential (GWP) value: 675



NOTICE

In Europe, the **greenhouse gas emissions** of the total refrigerant charge in the system (expressed as tonnes CO₂ equivalent) is used to determine the maintenance intervals. Follow the applicable legislation.

Formula to calculate the greenhouse gas emissions:
GWP value of the refrigerant × Total refrigerant charge [in kg] / 1000

Please contact your installer for more information.



WARNING

The refrigerant inside the unit is mildly flammable, but normally does NOT leak. If the refrigerant leaks in the room and comes in contact with fire from a burner, a heater, or a cooker, this may result in fire, or the formation of a harmful gas.

Turn off any combustible heating devices, ventilate the room, and contact the dealer where you purchased the unit.

Do NOT use the unit until a service person confirms that the part from which the refrigerant leaked has been repaired.



WARNING

- Do NOT pierce or burn refrigerant cycle parts.
- Do NOT use cleaning materials or means to accelerate the defrosting process other than those recommended by the manufacturer.
- Be aware that the refrigerant inside the system is odourless.



WARNING

The appliance shall be stored in a room without continuously operating ignition sources (example: open flames, an operating gas appliance or an operating electric heater).



NOTICE

Maintenance MUST be done by an authorized installer or service agent.

We recommend performing maintenance at least once a year. However, applicable legislation might require shorter maintenance intervals.



DANGER: RISK OF ELECTROCUTION

To clean the air conditioner or air filter, be sure to stop operation and turn all power supplies off. Otherwise, an electric shock and injury may result.



WARNING

To prevent electric shocks or fire:

- Do NOT rinse the unit.
- Do NOT operate the unit with wet hands.
- Do NOT place any objects containing water on the unit.



CAUTION

After a long use, check the unit stand and fitting for damage. If damaged, the unit may fall and result in injury.



CAUTION

Do NOT touch the heat exchanger fins. These fins are sharp and could result in cutting injuries.



WARNING

Be careful with ladders when working in high places.

7.2 To clean the indoor unit and user interface



NOTICE

- Do NOT use gasoline, benzene, thinner polishing powder or liquid insecticide. **Possible consequence:** Discoloration and deformation.
- Do NOT use water or air of 40°C or higher. **Possible consequence:** Discoloration and deformation.
- Do NOT use polishing compounds.
- Do NOT use a scrubbing brush. **Possible consequence:** The surface finishing peels off.



DANGER: RISK OF ELECTROCUTION

Before cleaning, be sure to stop the operation, turn the breaker off or pull out the supply cord. Otherwise, an electric shock and injury may result.

- Clean with a soft cloth. If it is difficult to remove stains, use water or a neutral detergent.

7.3 To clean the front panel

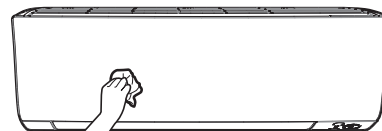

- Clean the front panel with a soft cloth. If it is difficult to remove stains, use water or a neutral detergent.

7.4 To remove the front panel

- Hold the front panel by the panel tabs on both sides and open it.

7 Maintenance and service

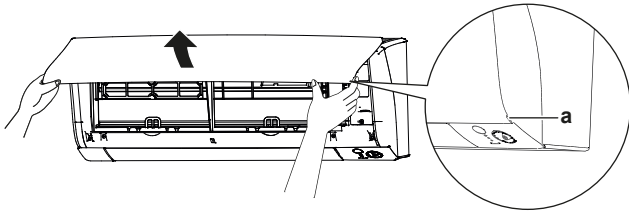

a Panel tabs

- 2 Remove the front panel by sliding it to the left or the right and pulling it toward you.

Result: The front panel shaft on 1 side will be disconnected.

- 3 Disconnect the front panel shaft on the other side in the same manner.

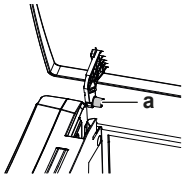

a Front panel shaft

7.5 About the air filters

Operating the unit with dirty filters means that the filter:

- CANNOT deodorize the air,
- CANNOT clean the air,
- poor heating/cooling,
- causes odour.

7.6 To clean the air filters

- 1 Push the tab at the centre of each air filter, then pull it down.
- 2 Pull out the air filters.

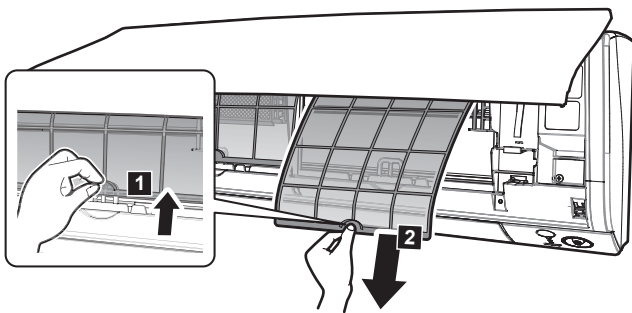

Note: (class 50~71) The titanium apatite deodorizing filter **MUST** be removed before cleaning the air filter.

- 3 Remove the titanium apatite deodorizing filter from all 4 claws.

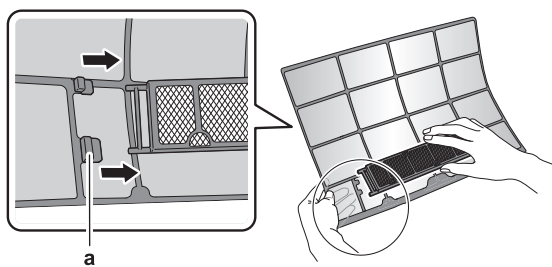

a Claw

- 4 Wash the air filters with water or clean them with a vacuum cleaner.

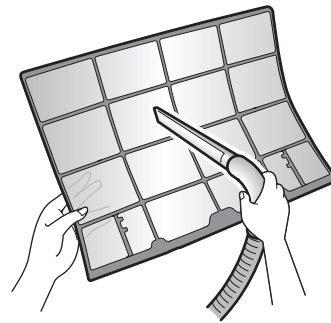

- 5 Soak in lukewarm water for about 10 to 15 minutes.

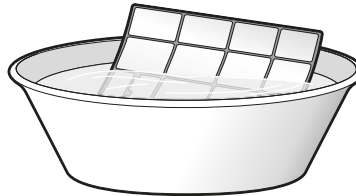

i INFORMATION

- If the dust does NOT come off easily, wash them with a neutral detergent diluted in lukewarm water. Dry the air filters in the shade.
- It is recommended to clean the air filters every 2 weeks.

7.7 To clean the titanium apatite deodorizing filter

i INFORMATION

Clean the filter with water every 6 months.

- 1 Remove the titanium apatite deodorizing filter from the tabs (class 15~42) or all 4 claws (class 50~71).

Class 15~42

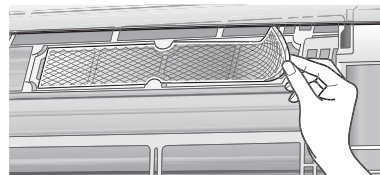

Class 50~71

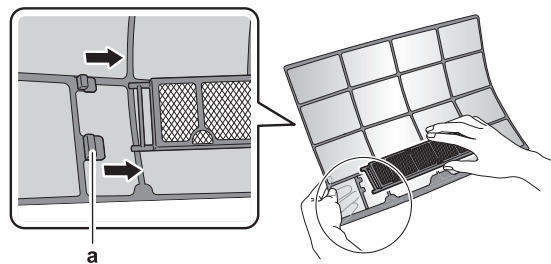

a Claw

- 2 Remove the dust from the filter with a vacuum cleaner.

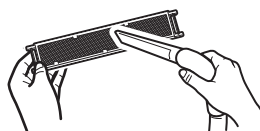

3 Soak the filter for 10 to 15 minutes in warm water.

Note: (class 50~71) Do NOT remove the filter from the frame.

Class 15~42

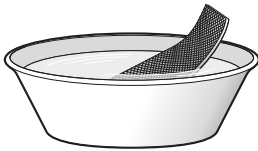

Class 50~71



4 After washing, shake off remaining water and dry the filter in the shade. Do NOT wring out the filter when removing water.

7.8 To replace the titanium apatite deodorizing filter



INFORMATION

Replace the filter every 3 years.

1 Remove the filter from the tabs (class 15~42) or frame (class 50~71) and replace the filter with a new one.

Class 15~42

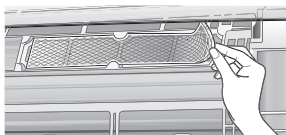

Class 50~71

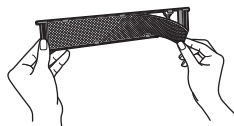

INFORMATION

- Do NOT throw away the filter frame, but use it again.
- Dispose of the old filter as non-flammable waste.

To order titanium apatite deodorizing filters, contact your dealer.

| Item | Part number |
|-----------------------------------|-------------|
| Titanium deodorizing filter 1 set | KAF970A46 |

7.9 To re-install the front panel

- Attach the front panel. Align the shafts with the slots and push them all the way in.
- Close the front panel slowly; press at both sides and at the centre.

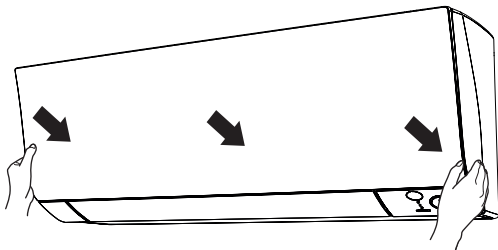

7.10 To take following items into account before a long idle period

Operate the unit several hours in **fan only** mode to dry the inside of the unit.

- Press **Mode** and select operation.
- Press and start operation.
- After operation stops, turn the breaker off.
- Clean the air filters and replace them in their original position.

5 Remove the batteries from the user interface.



INFORMATION

It is recommended to have periodical maintenance performed by a specialist. For specialist maintenance, contact your dealer. Maintenance costs shall be borne by the customer.

In certain operating conditions the inside of the unit may get dirty after several seasons of use. This results in poor performance.

8 Troubleshooting

If one of the following malfunctions occur, take the measures shown below and contact your dealer.



WARNING

Stop operation and shut off the power if anything unusual occurs (burning smells etc.).

Leaving the unit running under such circumstances may cause breakage, electric shock or fire. Contact your dealer.

The system **MUST** be repaired by a qualified service person.

| Malfunction | Measure |
|---|--|
| If a safety device such as a fuse, a breaker or an earth leakage breaker frequently actuates or the ON/OFF switch does NOT properly work. | Turn OFF the main power switch. |
| If water leaks from the unit. | Stop the operation. |
| The operation switch does NOT work well. | Turn OFF the power supply. |
| If the user interface display indicates the unit number, the operation lamp flashes and the malfunction code appears. | Notify your installer and report the malfunction code. |

If the system does NOT properly operate except for the above mentioned cases and none of the above mentioned malfunctions is evident, investigate the system according to the following procedures.

| Malfunction | Measure |
|--|--|
| If the system does NOT operate at all. | <ul style="list-style-type: none"> Check if there is no power failure. Wait until power is restored. If a power failure occurs during operation, the system automatically restarts immediately after power is restored. Check if no fuse has blown or breaker is activated. Change the fuse or reset the breaker if necessary. Check the batteries of the user interface. Check the timer setting. |
| The system suddenly stops operating. | <ul style="list-style-type: none"> Check if the air inlet or outlet of the outdoor or indoor unit is NOT blocked by obstacles. Remove any obstacles and make sure the air can flow freely. The air conditioner may stop operating after sudden large voltage fluctuations to protect the system. It automatically resumes operation after about 3 minutes. |
| The fan will stop during airflow operation. | If the set temperature is reached, the airflow rate is reduced and operation stops. Operation will resume automatically when the indoor temperature rises or falls. |
| The flaps do NOT start to swing immediately. | The indoor unit is adjusting the position of the flaps. The flaps will start moving soon. |

8 Troubleshooting

| Malfunction | Measure |
|--|--|
| Operation does NOT start soon. | In case the ON/OFF button was pressed right after operation was stopped or if the mode was changed. Operation will start after 3 minutes to protect the system. |
| The system operates, but cooling or heating is insufficient. | <ul style="list-style-type: none"> ▪ Check the airflow rate setting. Refer to "5.4 Airflow rate" on page 8. ▪ Check the temperature setting. Refer to "5.3.1 To start/stop operation and to set the temperature" on page 8. ▪ Check if the airflow direction setting is appropriate. Refer to "5.5 Airflow direction" on page 8. ▪ Check if the air inlet or outlet of the outdoor or indoor unit is NOT blocked by obstacles. Remove any obstacles and make sure the air can flow freely. ▪ Check if the air filters are clogged. Clean the air filters. See "7 Maintenance and service" on page 15. ▪ Check for open doors or windows. Close doors and windows to prevent wind from coming in. ▪ Check if the unit operates in Econo or Outdoor unit quiet operation. Refer to "5.8 Econo and Outdoor unit quiet operation" on page 10. ▪ Check if there is any furniture directly under or next to the indoor unit. Move the furniture. |
| The system operates, but heating is insufficient (air is NOT blown from the unit). | <ul style="list-style-type: none"> ▪ The air conditioner may be warming up for heating operation. Wait for 1 to 4 minutes. ▪ If a flowing sound is heard, the outdoor unit may be in defrost operation. Wait for 4 to 12 minutes. |
| The ON/OFF timer does NOT operate according to the settings. | <ul style="list-style-type: none"> ▪ Check if the Weekly timer and ON/OFF timer are set to the same time. Change or deactivate the setting. Refer to "5.10 OFF/ON timer operation" on page 10 and "5.11 Weekly timer operation" on page 11. ▪ Check if the clock and the day of the week are set correctly. Refer to "4.4 Clock" on page 6. |
| Cooling operation CANNOT be selected. | Check if your system is NOT heating only version. |
| An abnormal function happens during operation. | The air conditioner may malfunction because of lightning or radio waves. Turn the breaker OFF and back ON. |
| The unit does NOT receive signals from the user interface. | <ul style="list-style-type: none"> ▪ Check the batteries of the user interface. Refer to "4.2 To insert the batteries" on page 6. ▪ Make sure that the transmitter is NOT exposed to direct sunlight. ▪ Check if there are any electronic starter type fluorescent lamps in the room. Contact your dealer. |
| The user interface display is blank. | Replace the batteries of the user interface. |
| An error code is displayed on the user interface. | Consult your local dealer. Refer to "8.2 Solving problems based on error codes" on page 19 for a detailed list of error codes. |

| Malfunction | Measure |
|---|---|
| Other electric appliances start to operate. | If the user interface signals operate other electric appliances, move the other appliances away, and contact your dealer. |

If after checking all above items, it is impossible to fix the problem yourself, contact your installer and state the symptoms, the complete model name of the unit (with manufacturing number if possible) and the installation date (possibly listed on the warranty card).

8.1 Symptoms that are NOT system malfunctions

The following symptoms are NOT system malfunctions:

8.1.1 Symptom: A sound like water flowing is heard

- This sound is caused by the refrigerant flowing in the unit.
- This sound may be generated when water is flowing away from the unit during cooling or drying operation.
- The refrigerant flows in the air conditioner even if the indoor unit is turned off and an indoor unit in another room is operating.

8.1.2 Symptom: A blowing sound is heard

This sound is generated when the direction of the refrigerant flow is changed (e.g. when switching from cooling to heating).

8.1.3 Symptom: A ticking sound is heard

This sound is generated when the unit slightly expands or contracts with changes in temperature.

8.1.4 Symptom: A whistling sound is heard

This sound is generated by the refrigerant flowing during defrost operation.

8.1.5 Symptom: A clicking sound during operation or idle time is heard

This sound is generated when the refrigerant control valves or electrical parts operate.

8.1.6 Symptom: A clapping sound is heard

This sound is generated when an external device sucks air out of the room (e.g. exhaust fan, extractor hood) while the doors and windows in the room are closed. Open the doors or windows, or turn off the device.

8.1.7 Symptom: White mist comes out of a unit (Indoor unit, outdoor unit)

When the system is changed over to heating operation after defrost operation. Moisture generated by defrost becomes steam and is exhausted.

8.1.8 Symptom: The units can give off odours

The unit can absorb the smell of rooms, furniture, cigarettes, etc., and then emit it again.

8.1.9 Symptom: The outdoor fan rotates while the air conditioner is not in operation

- **After operation has stopped.** The outdoor fan continues to rotate for another 30 seconds for system protection.

- **While the air conditioner is not in operation.** When the outdoor temperature is very high, the outdoor fan starts to rotate for system protection.

8.2 Solving problems based on error codes

When a problem happens, an error code appears on the user interface. It is important to understand the problem and to take measures before resetting an error code. This should be done by a licensed installer or by your local dealer.



This chapter gives you an overview of all error codes and the content of the error code as it appears on the user interface.

For a more detailed troubleshooting guideline for each error, please see the service manual.

Fault diagnosis by user interface

The user interface can receive an error code from the indoor unit referring to the fault. It is important to understand the problem and take measures before resetting the error code. This should be done by a licensed installer or your local dealer.

To see the error code on the user interface:





- 1 Hold  for about 5 seconds.
Result:  blinks in the temperature display section.
- 2 Press  repeatedly until a continuous beep is heard.
Result: The code is now displayed on the display.







INFORMATION

- A short beep and 2 consecutive beeps indicate non-corresponding codes.
- To cancel the code display, hold the  cancel button for 5 seconds. The code will also disappear from the display if the button is NOT pressed within 1 minute.







System











| Error code | Description |
|---|---|
|  | Normal |
|  | Refrigerant shortage |
|  | Overvoltage detection |
|  | Signal transmission error (between indoor and outdoor unit) |
|  | Indoor/outdoor unit combination fault |

Indoor unit

| Error code | Description |
|---|---|
|  | Indoor unit PCB abnormality |
|  | Freeze-up protection or high-pressure control |
|  | Fan motor (DC motor) abnormality |
|  | Indoor heat exchanger thermistor abnormality |
|  | Room temperature thermistor abnormality |

Outdoor unit

| Error code | Description |
|---|---|
|  | 4-way valve abnormality |
|  | Outdoor unit PCB abnormality |
|  | Overload activation (compressor overload) |
|  | Compressor lock |
|  | DC fan lock |
|  | Discharge pipe temperature control |
|  | High-pressure control (in cooling mode) |

| Error code | Description |
|---|---|
|  | Compressor system sensor abnormality |
|  | Position sensor abnormality |
|  | DC voltage / current sensor abnormality |
|  | Outdoor temperature thermistor abnormality |
|  | Discharge pipe thermistor abnormality |
|  | Outdoor heat exchanger thermistor abnormality |
|  | Electrical parts heat error |
|  | Radiation fin temperature rise |
|  | Inverter instantaneous overcurrent (DC) |
|  | Radiation fin thermistor abnormality |

8.3 Troubleshooting for wireless connection adapter

The following table provides a brief description of how to deal with some problems. If none of the following solutions fix the problem, go to <http://www.onlinecontroller.daikineurope.com/> for more information and FAQ.



| Problem | Measure |
|---|--|
| None of the LEDs light | <ul style="list-style-type: none"> • Try operating the unit with the user interface. • Turn the unit off and then back on. • Make sure the LEDs are not disabled in the application. • Check if the adapter is installed correctly. |
| The Wireless LAN adapter is not visible on the unit overview screen ("Home" screen) after the Wireless LAN adapter has been configured. | <ul style="list-style-type: none"> • Check that the power is on. • Check that the RUN LED is lit. • If the AP LED is lit, press the MODE button for 2 seconds to switch to RUN mode. • If the RUN LED is blinking, try connecting the WLAN adapter to the wireless network again. Make sure the Wireless LAN adapter is close enough to the router (Wireless LAN access point). • If the RUN LED is lit, make sure that the smartphone or tablet is connected to the same wireless LAN network as the Wireless LAN adapter. |



8 Troubleshooting

| Problem | Measure |
|---|--|
| When trying to make a direct connection to the adapter (AP mode), the Wireless LAN adapter is not visible in the available Wi-Fi networks list of the phone/tablet. | <ul style="list-style-type: none"> ▪ If the AP LED is not lit, press the MODE button for 2 seconds to switch to AP mode. ▪ If the AP LED is blinking, please wait until the AP LED is lit (approximately 1 minute). The Wireless LAN adapter is still starting up. ▪ If the AP LED is lit, switch to RUN mode by pressing the MODE button for 2 seconds. Now switch back to AP mode by pressing the MODE button again for 2 seconds. This procedure will change the wireless channel on which the Wireless LAN adapter is operating. Repeat if necessary. |























































8.4 Solving problems based on the LED on the outdoor unit

| LED color | Normal status |
|-----------|---------------|
| Green | Flashing |
| Red | Off |

| | |
|--|------------|
|  | On |
|  | Flashing |
|  | Off |
| — | Any status |

| LED on outdoor unit printed circuit board for 2MXM series | |
|--|---|
| Green | Diagnosis |
| Micro-computer normal / LED-A | |
|  | Normal, check indoor unit |
|  | Turn the power off and on again. If the LED display recurs, the outdoor unit PCB is faulty. |
|  | Power supply fault ^(a) |

(a) May NOT apply in some cases. Refer to the service manual.

| LED on outdoor unit printed circuit board for 3MXM, 4MXM, 5MXM series | | | | | | |
|--|---|---|---|---|---|---|
| Green | Red | | | | | Diagnosis |
| Micro-computer normal | Malfunction detection | | | | | |
| LED-A | LED1 | LED2 | LED3 | LED4 | LED5 ^(a) | |
|  |  |  |  |  |  | Normal, check indoor unit |
|  |  |  |  |  |  | High-pressure protector (on condenser) or low-pressure protector (on evaporator) activated or indoor unit heat exchanger is frozen up while the unit was operating or was in standby mode |
|  |  |  |  |  |  | Overload relay activated or high discharge pipe temperature ^(b) |
|  |  |  |  |  |  | Faulty start of the compressor |
|  |  |  |  |  |  | Input overcurrent |
|  |  |  |  |  |  | Thermistor or current transformer abnormality ^(b) |
|  |  |  |  |  |  | High temperature of the switchbox |
|  |  |  |  |  |  | High temperature at Inverter circuit heatsink |
|  |  |  |  |  |  | Output overcurrent ^(b) |

| LED on outdoor unit printed circuit board for 3MXM, 4MXM, 5MXM series | | | | | | Diagnosis |
|---|-----------------------|------|------|------|---------------------|---|
| Green | Red | | | | | |
| Micro-computer normal | Malfunction detection | | | | | |
| LED-A | LED1 | LED2 | LED3 | LED4 | LED5 ^(a) | |
| | | | | | | Refrigerant shortage ^(b) |
| | | | | | | Low voltage to main circuit or momentary voltage loss |
| | | | | | | Reversing solenoid valve switching failure |
| | | | | | | Fan motor fault |
| | — | — | — | — | | Turn the power off and on again. If the LED display recurs, the outdoor unit PCB is faulty. |
| | — | — | — | — | | Power supply fault ^(b) |

(a) LED5 is available only for 5MXM series.

(b) May NOT apply in some cases. Refer to the service manual.

9 Disposal



NOTICE

Do NOT try to dismantle the system yourself: dismantling of the system, treatment of the refrigerant, oil and other parts MUST comply with applicable legislation. Units MUST be treated at a specialised treatment facility for reuse, recycling and recovery.

Field supply

Equipment NOT made by Daikin that can be combined with the product according to the instructions in the accompanying documentation.

10 Glossary

Dealer

Sales distributor for the product.

Authorized installer

Technical skilled person who is qualified to install the product.

User

Person who is owner of the product and/or operates the product.

Applicable legislation

All international, European, national and local directives, laws, regulations and/or codes that are relevant and applicable for a certain product or domain.

Service company

Qualified company which can perform or coordinate the required service to the product.

Installation manual

Instruction manual specified for a certain product or application, explaining how to install, configure and maintain it.

Operation manual

Instruction manual specified for a certain product or application, explaining how to operate it.

Accessories

Labels, manuals, information sheets and equipment that are delivered with the product and that need to be installed according to the instructions in the accompanying documentation.

Optional equipment

Equipment made or approved by Daikin that can be combined with the product according to the instructions in the accompanying documentation.

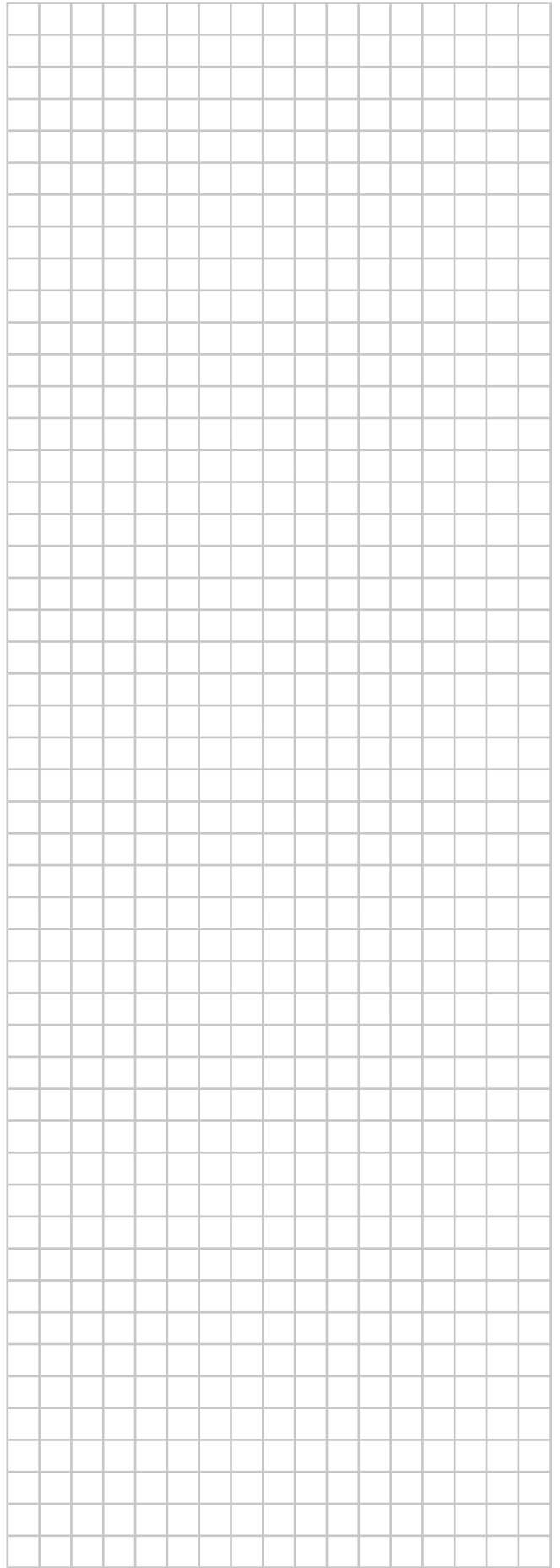



ERC

DAIKIN INDUSTRIES CZECH REPUBLIC s.r.o.

U Nové Hospody 1/1155, 301 00 Plzeň Skvrňany, Czech Republic

DAIKIN EUROPE N.V.

Zandvoordestraat 300, B-8400 Oostende, Belgium

Copyright 2018 Daikin

4P518786-3C 2018.09