

Air Conditioning
Technical Data

FVXM-F



- > FVXM25FV1B
- > FVXM35FV1B
- > FVXM50FV1B

TABLE OF CONTENTS

FVXM-F

1	Features	2
2	Specifications	3
	Technical Specifications	3
	Electrical Specifications	4
3	Options	5
4	Dimensional drawings	6
5	Centre of gravity	7
6	Piping diagrams	8
7	Wiring diagrams	10
	Wiring Diagrams - Single Phase	10
8	Sound data	11
	Sound Pressure Spectrum	11

1 Features

Floor standing unit for optimal heating comfort thanks to dual airflow

- Seasonal efficiency values up to A++ in cooling
- Its low height (620 mm) enables the unit to fit perfectly beneath a window
- Online controller (optional): control your indoor from any location with an app, via your local network or internet and keep an overview on your energy consumption
- Quiet operation: down to 23dBA sound pressure level
- Choosing for an R-32 product, reduces the environmental impact with 68% compared to R-410A and leads directly to lower energy consumption thanks to its high energy efficiency



Econo mode



Night set mode



Fan only



Powerful mode



Auto cooling-heating changeover



Indoor unit silent operation



Outdoor unit silent operation



Vertical auto swing



Auto fan speed



Fan speed steps



Dry programme



Titanium apatite deodorising filter



Weekly timer



24 hour timer



Infrared remote control



Centralised control



Online controller via app



Auto-restart



Self diagnosis



Multi model application

2 Specifications

2-1 Technical Specifications				FVXM25F	FVXM35F	FVXM50F	
Power input	Cooling	Nom.	kW	0.015 (1)		0.027 (1)	
	Heating	Nom.	kW	0.017 (1)		0.034 (1)	
Casing	Colour			White			
Dimensions	Unit	Height/Width/Depth	mm	600/700/210			
	Packed unit	Height/Width/Depth	mm	696/786/280			
Weight	Unit		kg	14			
	Packed unit		kg	18			
Heat exchanger	Length		mm	510			
	Rows	Quantity		2			
	Fin pitch		mm	1.2			
	Stages	Quantity		22			
	Passes	Quantity		2	3		
	Tube type		ø6.35 Hi-XU				
	Fin	Type		Multi slit fin			
Air filter	Type			Removable / washable			
Fan	Type			Turbo fan			
	Quantity			1			
	Air flow rate	Cooling	High	m ³ /min	8.2	8.5	10.1
				cfm	290	300	357
			Medium	m ³ /min	6.5 (2)	6.7 (2)	8.9 (2)
				cfm	230	237	314
			Low	m ³ /min	4.8	4.9	7.8
				cfm	169	173	275
		Silent operation	m ³ /min	4.1	4.5	6.6	
			cfm	145	159	233	
		Heating	High	m ³ /min	8.8	9.4	11.8
				cfm	311	332	417
			Medium	m ³ /min	6.9 (2)	7.3 (2)	10.1 (2)
				cfm	244	258	357
Low	m ³ /min		5.0	5.2	8.5		
	cfm		177	184	300		
Silent operation	m ³ /min	4.4	4.7	7.1			
	cfm	155	166	251			
Fan motor	Quantity			1			
	Model			D48D-28			
	Speed	Steps		5 + silent, + auto			
		Cooling	High/Medium/Low/Silent operation	rpm	640/520/400/360	650/530/410/380	760/680/600/510
				rpm	680/550/420/380	700/560/420/390	850/740/630/540
Heating		High/Medium/Low/Silent operation	rpm	680/550/420/380	700/560/420/390	850/740/630/540	
	rpm		680/550/420/380	700/560/420/390	850/740/630/540		
Sound power level	Cooling		dBA	52		57	
	Heating		dBA	52		58	
Sound pressure level	Cooling	High/Medium/Low/Silent operation	dBA	38/32 (2)/26/23	39/33 (2)/27/24	44/40 (2)/36/32	
	Heating	High/Medium/Low/Silent operation	dBA	38/32/26/23	39/33/27/24	45/40/36/32	
Control systems	Infrared remote control			ARC452A1			
Refrigerant	Type			R-32			

2 Specifications

2-1 Technical Specifications			FVXM25F	FVXM35F	FVXM50F
Piping connections	Liquid	OD	6,4		
	Gas	OD	9.5		12.7
	Drain		VP20 (I.D. 20/O.D. 26)		
	Heat insulation		Both liquid and gas pipes		
Temperature control			Microcomputer control		
Air direction control			Right, Left, Horizontal, Downward		

Standard Accessories : Installation manual; Quantity : 1;

Standard Accessories : Operation manual; Quantity : 1;

Standard Accessories : Wireless remote control; Quantity : 1;

Standard Accessories : AAA dry-cell batteries; Quantity : 2;

Standard Accessories : Remote control holder; Quantity : 1;

Standard Accessories : Drain hose; Quantity : 1;

Standard Accessories : Insulation sheet; Quantity : 2;

Standard Accessories : Titanium apatite deodorizing filter; Quantity : 2;

Standard Accessories : Installation plate; Quantity : 1;

2-2 Electrical Specifications				FVXM25F	FVXM35F	FVXM50F
Power supply	Phase			1~		
	Frequency		Hz	50		
	Voltage			220-230-240		
Current	Nominal running current (RLA) - 50Hz	Cooling	A	0.14 (3) / 0.13 (4) / 0.12 (2)		0.18 (3) / 0.17 (4) / 0.16 (2)
		Heating	A	0.15 (3) / 0.14 (4) / 0.13 (2)		0.17 (3) / 0.17 (4) / 0.16 (2)
Wiring connections - 50Hz	For power supply	Remark		4 for interunit wiring (earth wire included)		

Notes

(1) 50Hz, 220-230-240V

(2) 240V

(3) 220V

(4) 230V

3 Options

3 - 1 Options

FVXM-F

wrong indoor units

Option kit	Product name	Remark	Applicable models	Class	Casing	Factory		
						D/Cz	D/Cz	D/Cz
Wired remote control	BRC073A1		FTXJ20LV1BW	20	EMURA2	✓	✓	✓
Wired remote control	BRC944B2		FTXJ20LV1BS	20	EMURA2	✗	✗	✗
Extension cord for wired remote control (3m)	BRCW901A03		FTXJ25LV1BW	25	EMURA2	✓	✓	✓
Extension cord for wired remote control (5m)	BRCW901A08		FTXJ20LV1BS	20	EMURA2	✓	✓	✓
Interface adaptor for wired remote control	KRP980B1		FTXJ20LV1BW	20	EMURA2	✗	✗	✗
Interface adaptor for wired remote control	EKRP067A41		FTXJ20LV1BS	20	EMURA2	✗	✗	✗
Interface adaptor for wired remote control	EKRP980B2		FTXJ25LV1BW	25	EMURA2	✗	✗	✗
Centralised control board (up to 5 rooms)	KRC72A		FTXJ20LV1BW	20	EMURA2	✓	✓	✓
Wiring adaptor (normal open contact - normal open pulse contact)	KRP413AB1S		FTXJ20LV1BS	20	EMURA2	✓	✓	✓
Wi-Fi adaptor for smartphones	BRP069A41	④	FTXJ20LV1BW	20	EMURA2	✓	✓	✓
Wi-Fi adaptor for smartphones	BRP069A42		FTXJ20LV1BS	20	EMURA2	✓	✓	✓
Wi-Fi adaptor for smartphones	BRP069A43		FTXJ25LV1BW	25	EMURA2	✗	✗	✗
Wi-Fi adaptor for smartphones	BRP069A44		FTXJ20LV1BS	20	EMURA2	✗	✗	✗
Wi-Fi adaptor for smartphones	BRP069A45		FTXJ25LV1BS	25	EMURA2	✗	✗	✗
Interface adaptor for DIII-NET	KRP928BB2S		FTXJ20LV1BW	20	EMURA2	✓	✓	✓
Central remote control	DCS302CA51		FTXJ20LV1BS	20	EMURA2	✓	✓	✓
Unified ON/OFF controller	DCS301BA51		FTXJ25LV1BW	25	EMURA2	✓	✓	✓
Schedule timer	DST301BA51		FTXJ20LV1BS	20	EMURA2	✓	✓	✓
Titanium apatite deodorising filter without frame	KAF971A42	①	FTXJ20LV1BW	20	EMURA2	✗	✗	✗
Titanium apatite deodorising filter without frame	KAF952B42	③	FTXJ20LV1BS	20	EMURA2	✗	✗	✗
Titanium apatite deodorising filter without frame	KAF970A46	②	FTXJ25LV1BW	25	EMURA2	✓	✓	✓
Honeycomb deodorising and air-purifying filter without frame	KAF968A42		FTXJ20LV1BS	20	EMURA2	✗	✗	✗
Honeycomb deodorising filter with frame	KAZ917B41		FTXJ25LV1BS	25	EMURA2	✗	✗	✗
Honeycomb deodorising filter without frame	KAZ917B42		FTXJ20LV1BW	20	EMURA2	✗	✗	✗
Air-purifying filter with frame	KAF925B41		FTXJ20LV1BS	20	EMURA2	✗	✗	✗
Honeycomb deodorising and air-purifying filter with frame	KAF046A41		FTXJ25LV1BS	25	EMURA2	✗	✗	✗
Anti-theft protection for remote control	KKF910AA4		FTXJ20LV1BW	20	EMURA2	✓	✓	✓
Anti-theft protection for remote control	KKF917AA4		FTXJ20LV1BS	20	EMURA2	✗	✗	✗
Anti-theft protection for remote control	KKF936A4		FTXJ25LV1BS	25	EMURA2	✗	✗	✗
Installation frame for floor-standing units	BKS028A4		FTXJ20LV1BW	20	EMURA2	✗	✗	✗

Notes

- R32 models

Legend

- Three-dimensional knitted fabric (42x275mm) + activated charcoal net
- Three-dimensional knitted fabric (42x255mm) + activated charcoal net
- Corrugated fiberboard (42x275mm)
- Without connection cable

3D095173H

4 Dimensional drawings

4 - 1 Dimensional Drawings

4

FVXM25-35F

Adjusting the air flow direction

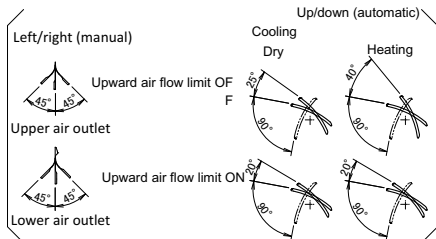

Notes

1. The → mark shows the piping direction.

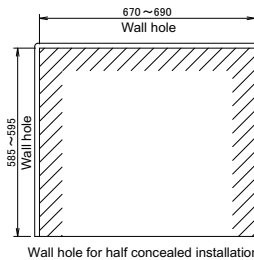
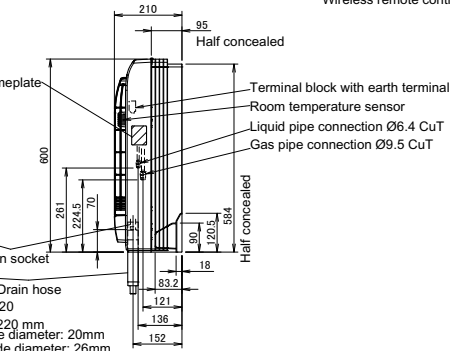
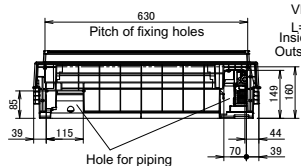
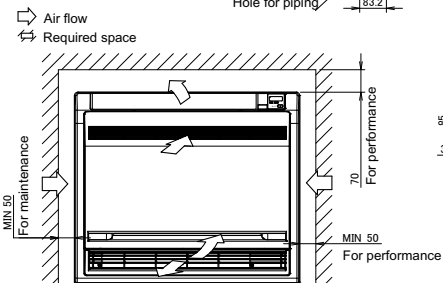
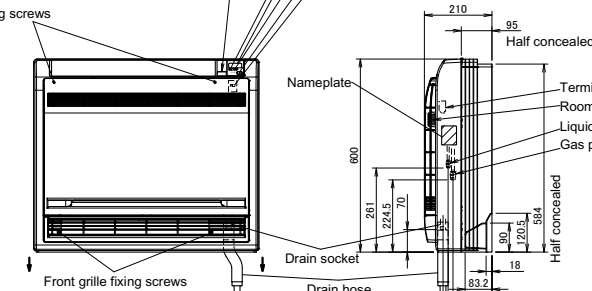
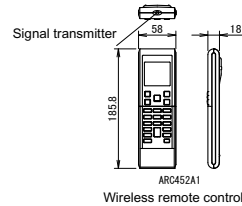
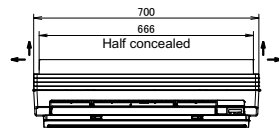
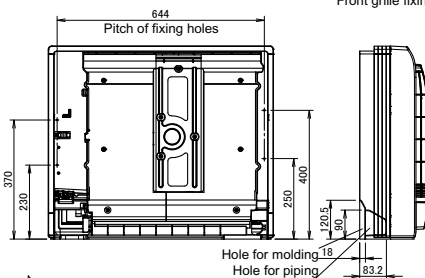

Wall hole for half concealed installation

3D108700

FVXM50F

Adjusting the air flow direction

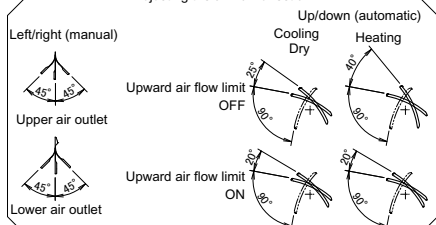

Notes

1. The → mark shows the piping direction.

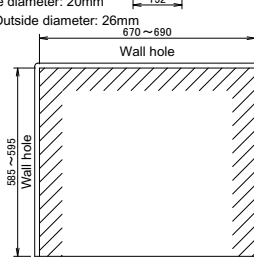
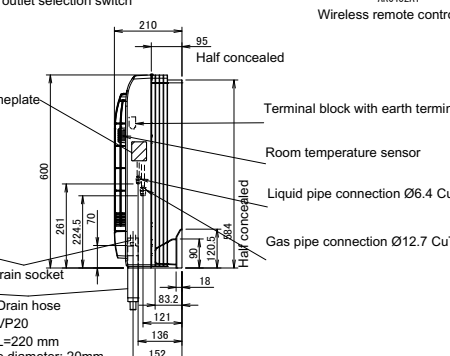
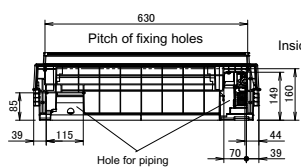
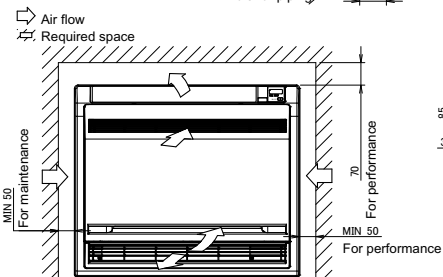
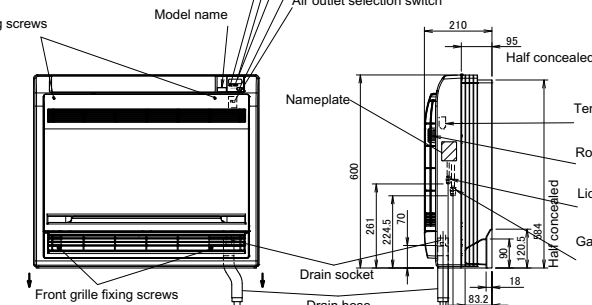
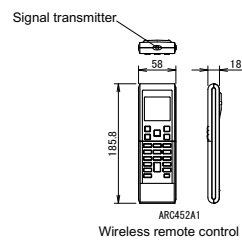
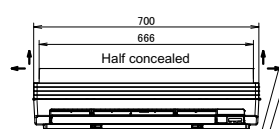
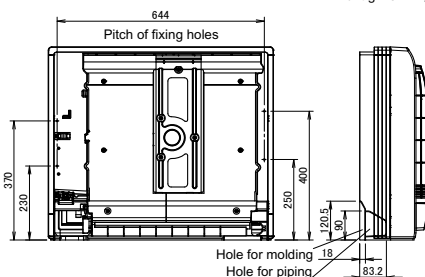

Wall hole for half concealed installation

3D108701

6

5 Centre of gravity

5 - 1 Centre of Gravity

FVXM-F

5

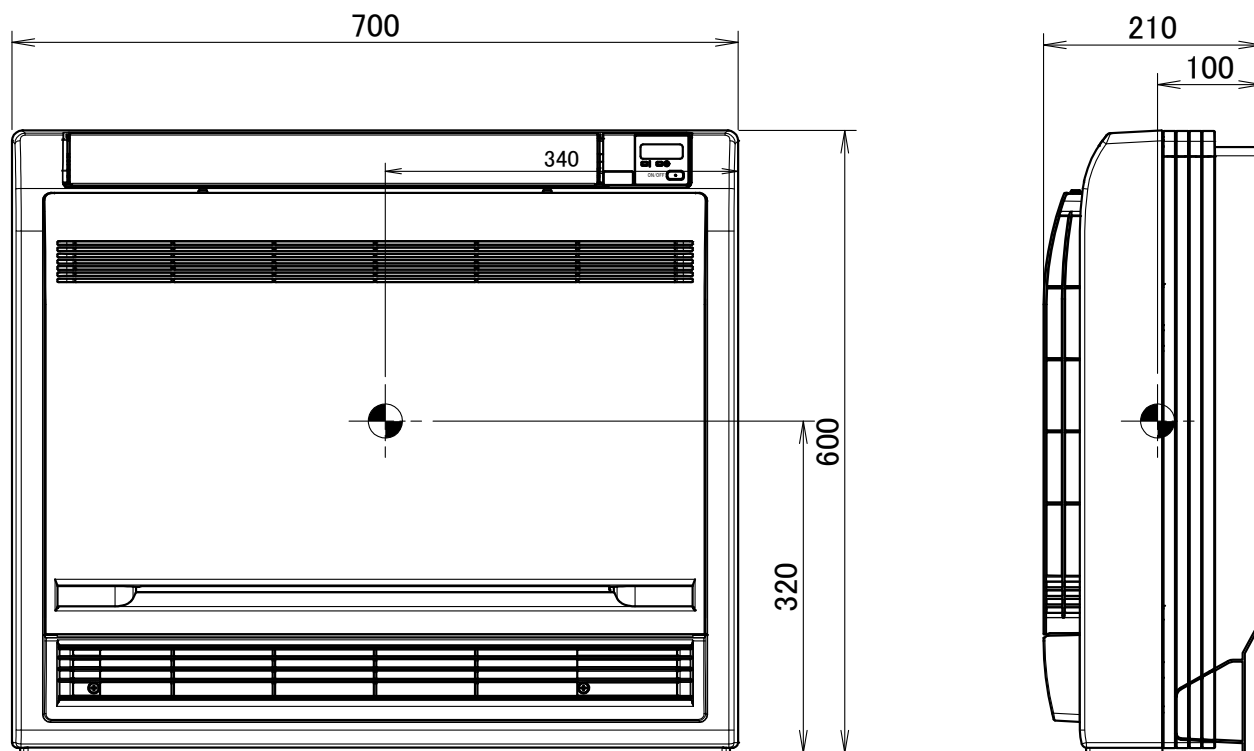

4D108705

6 Piping diagrams

6 - 1 Piping Diagrams

6

FVXM25-35F

Indoor unit

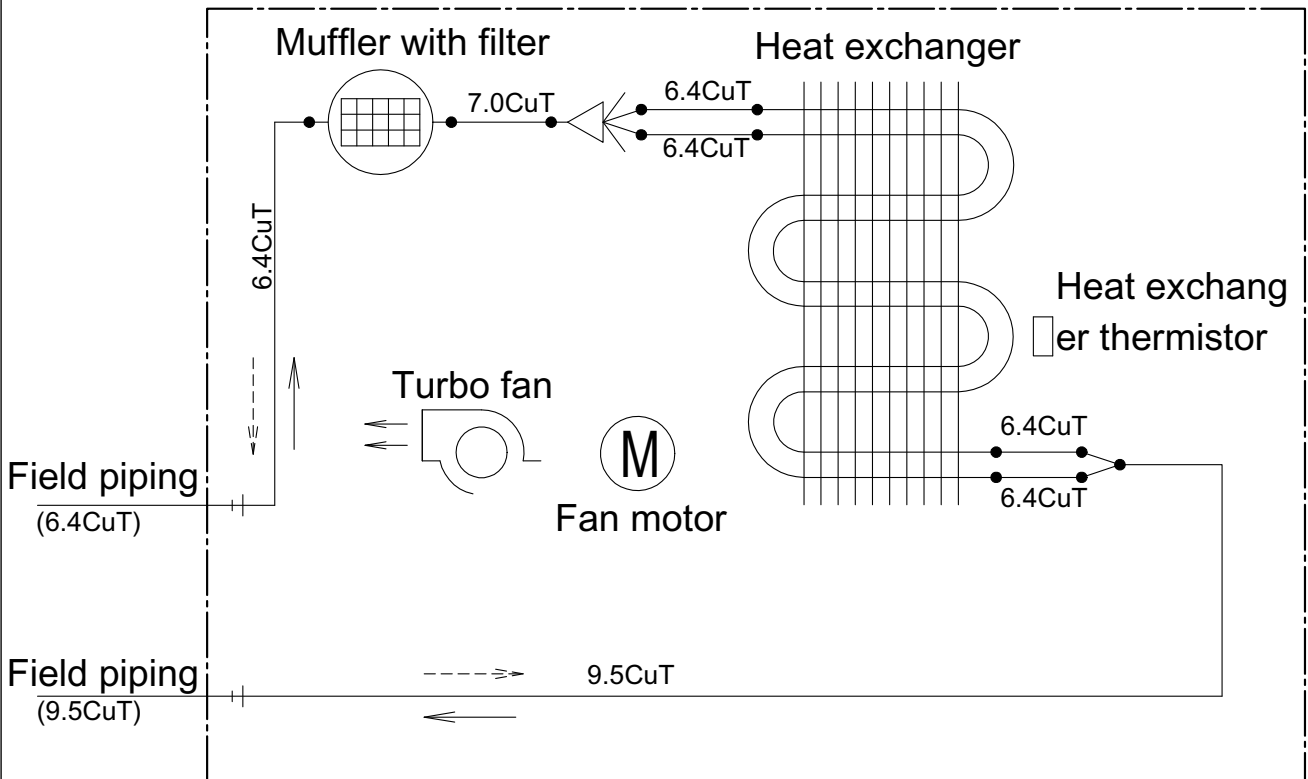

Refrigerant flow
 ———> Cooling
 - - - -> Heating

4D108703

6 Piping diagrams

6 - 1 Piping Diagrams

FVXM50F

Indoor unit

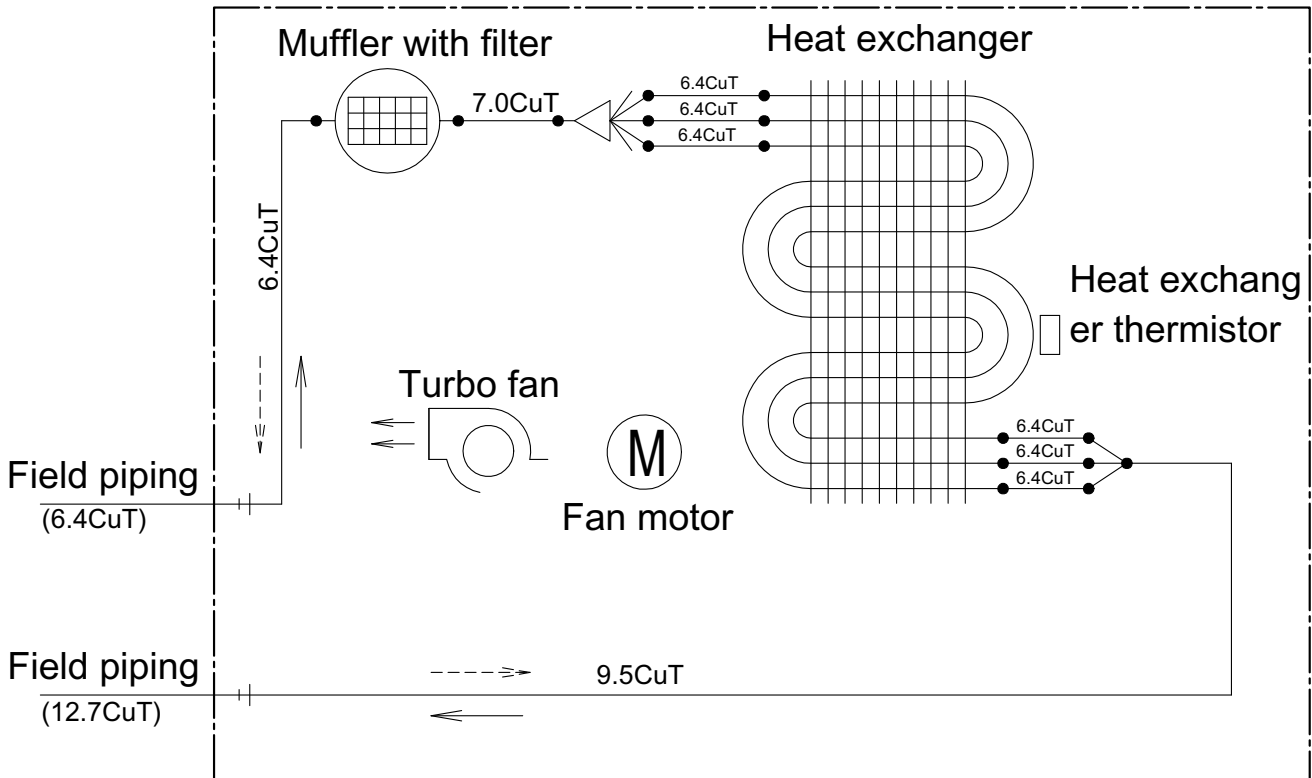

Refrigerant flow
 ———> Cooling
 - - - -> Heating

4D108704

7 Wiring diagrams

7 - 1 Wiring Diagrams - Single Phase

7

FVXM-F

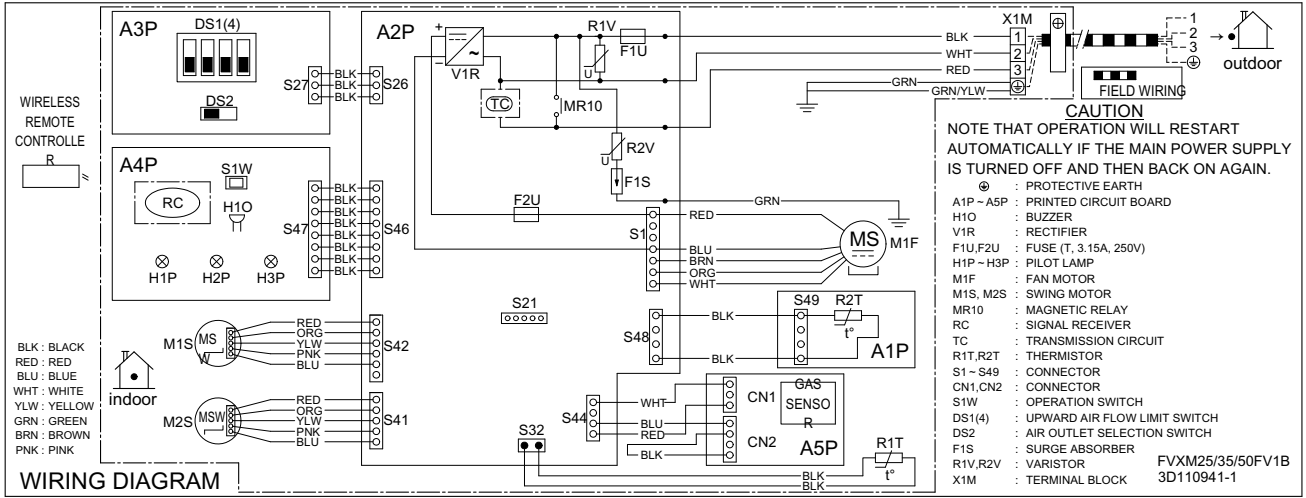

3D110941-1

8 Sound data

8 - 1 Sound Pressure Spectrum

FVXM25F

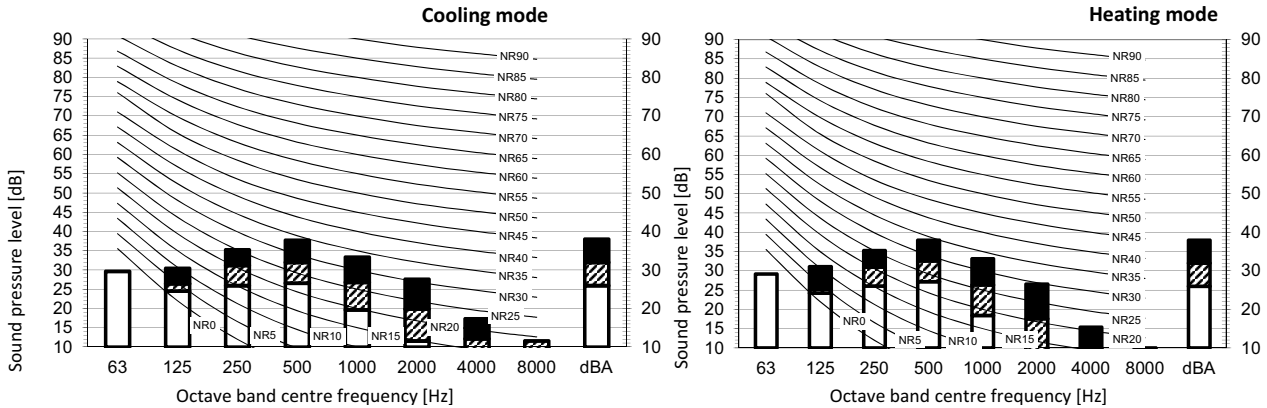

Legend

dBA = A-weighted sound pressure level (A scale according to IEC).

A Scale Fan speed

- B High
- C Medium
- D Low

Cooling		Total dB	
A	B	C	D
dBA	38	32	26

Heating		Total dB	
A	B	C	D
dBA	38	32	26

Location of microphone

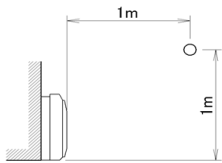

Notes

- Operating conditions: power source 220-240 V/220 V 50/60 Hz; JIS standard
- Background noise already taken into account.
- Operating noise varies depending on operation and ambient conditions.
- The operation noise measuring method is in accordance with JISC9612.
- Measuring location: anechoic chamber

3D109933A

FVXM35F

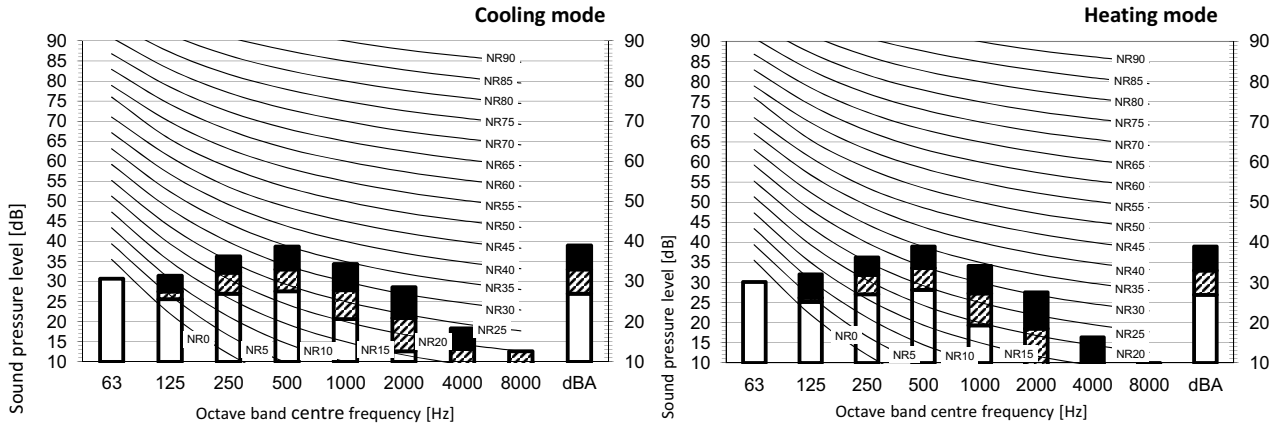

Legend

dBA = A-weighted sound pressure level (A scale according to IEC).

A Scale Fan speed

- B High
- C Medium
- D Low

Cooling		Total dB	
A	B	C	D
dBA	39	33	27

Heating		Total dB	
A	B	C	D
dBA	39	33	27

Location of microphone

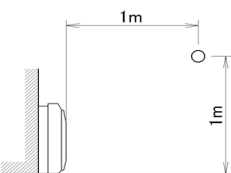

Notes

- Operating conditions: power source 220-240 V/220 V 50/60 Hz; JIS standard.
- Background noise already taken into account.
- Operating noise varies depending on operation and ambient conditions.
- The operation noise measuring method is in accordance with JISC9612.
- Measuring location: anechoic chamber.

3D109934A

8 Sound data

8 - 1 Sound Pressure Spectrum

8

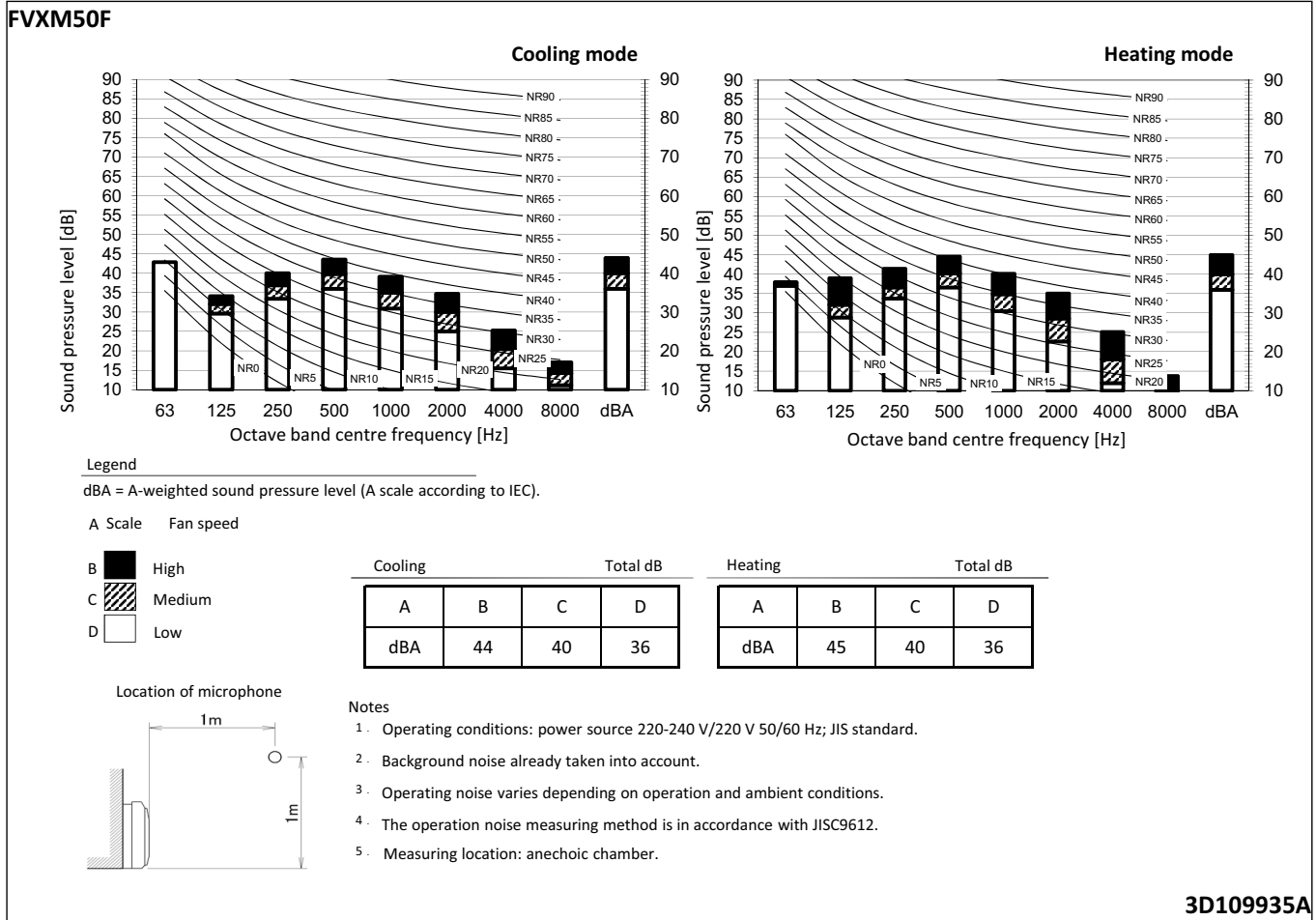



Daikin Europe N.V. Naamloze Vennootschap - Zandvoordestraat 300, B-8400 Oostende - Belgium - www.daikin.eu - BE 0412 120 336 - RPR Oostende

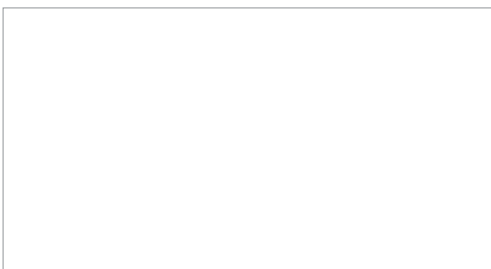

EEDEN17 10/17



Daikin Europe N.V. participates in the Eurovent Certified Performance programme for Liquid Chilling Packages and Hydronic Heat Pumps, Fan Coil Units and Variable Refrigerant Flow systems. Check ongoing validity of certificate: www.eurovent-certification.com



The present leaflet is drawn up by way of information only and does not constitute an offer binding upon Daikin Europe N.V.. Daikin Europe N.V. has compiled the content of this leaflet to the best of its knowledge. No express or implied warranty is given for the completeness, accuracy, reliability or fitness for particular purpose of its content and the products and services presented therein. Specifications are subject to change without prior notice. Daikin Europe N.V. explicitly rejects any liability for any direct or indirect damage, in the broadest sense, arising from or related to the use and/or interpretation of this leaflet. All content is copyrighted by Daikin Europe N.V.