

DAIKIN

INVERTER

DAIKIN ROOM AIR CONDITIONER

Operation Manual

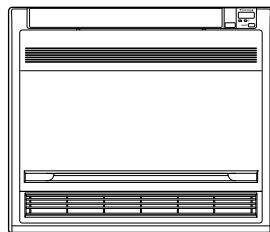

R410A

R32

FVXS25FV1B

FVXM25FV1B

FVXS35FV1B

FVXM35FV1B

FVXS50FV1B

FVXM50FV1B



CONTENTS

READ BEFORE OPERATION

Safety precautions	2
Names of parts	6
Preparation Before Operation	9
Operation range	11

OPERATION

AUTO · DRY · COOL · HEAT · FAN Operation	12
Adjusting the Airflow Direction	14
POWERFUL Operation	16
OUTDOOR UNIT QUIET Operation.....	17
ECONO Operation	18
TIMER Operation	19
WEEKLY TIMER Operation	21
Note for Multi System.....	26

CARE

Care and Cleaning	28
-------------------------	----

TROUBLE SHOOTING

Trouble Shooting.....	31
-----------------------	----

NOTE

The original instructions are written in English.
Other languages are translations of the original instructions.

Safety precautions

- Keep this manual where the operator can easily find it.
- Read the precautions in this manual carefully before operating the unit.
- This appliance is intended to be used by expert or trained users in shops, in light industry and on farms, or for commercial and household use by lay persons.
- Sound pressure level is less than 70 dB (A).
- The precautions described herein are classified as WARNING and CAUTION. They both contain important information regarding safety. Be sure to observe all precautions without fail.

WARNING

If you do not follow these instructions exactly, the unit may cause property damage, personal injury or loss of life.

CAUTION

If you do not follow these instructions exactly, the unit may cause minor or moderate property damage or personal injury.



Never do.



Be sure to establish an air connection.



Never touch the air conditioner (including the remote controller) with a wet hand.



Be sure to follow the instructions.





Never cause the air conditioner (including the remote controller) to get wet.



FVXM models are filled with R32 refrigerant.

WARNING

- The appliance must be stored in a room without continuously operating ignition sources (for example: open flames, an operating gas appliance or an operating electric heater). 
 - In order to avoid fire, explosion or injury, do not operate the unit when harmful gases (e.g. flammable or corrosive) are detected near the unit.
 - Be aware that prolonged, direct exposure to cool or warm air from the air conditioner, or to air that is too cool or too warm can be harmful to your physical condition and health.
 - Do not place objects, including rods, your fingers, etc., in the air inlet or outlet. Product damage or personal injury may result due to contact with the air conditioner's high-speed fan blades.
 - Do not attempt to repair, dismantle, reinstall or modify the air conditioner yourself as this may result in water leakage, electric shocks or fire hazards.
 - Do not use flammable gasses (hairsprays, insecticides etc.) near the unit. Do not use benzine or thinner to wipe the unit.
It could cause cracking, electric shocks or fire. (only for R32 refrigerant)
 - Do not use refrigerant other than the one indicated on the outdoor unit (R410A/R32) when installing, moving or repairing. Using other refrigerants may cause trouble or damage to the unit, and personal injury.
 - To avoid electric shocks, do not operate with wet hands.
 - Do not wash the air conditioner with water, as this may result in electric shocks or fire hazards.
 - Do not place water containers (vases etc.) above the unit, as this may result in electric shocks or fire hazards.
-
- Beware of fire in case of refrigerant leakage. If the air conditioner is not operating correctly, i.e. not generating cool or warm air, refrigerant leakage could be the cause. Consult your dealer for assistance. The refrigerant within the air conditioner is safe and normally does not leak. However, in the event of a leakage, contact with a naked burner, heater or cooker may result in generation of noxious gas. Do not longer use the air conditioner until a qualified service person confirms that the leakage has been repaired. 

Safety precautions

WARNING

- Do not attempt to install or repair the air conditioner yourself. Improper workmanship may result in water leakage, electric shocks or fire hazards. Please contact your local dealer or qualified personnel for installation and maintenance work.
 - When the air conditioner is malfunctioning (giving off a burning odour, etc.) turn off power to the unit and contact your local dealer. Continued operation under such circumstances may result in a failure, electric shocks or fire hazards.
 - Be sure to install an earth leakage breaker. Failure to install the earth leakage breaker may result in electric shocks or fire.
-
- The air conditioner must be earthed. Incomplete earthing may result in electric shocks. Do not connect the earth line to a gas pipe, water pipe, lightning rod, or a telephone earth line. 

CAUTION

- Do not use the air conditioner for purposes other than those for which it is intended. Do not use the air conditioner for cooling precision instruments, food, plants, animals or works of art as this may adversely affect the performance, quality and/or longevity of the object concerned. 
- Do not expose plants or animals directly to airflow from the unit as this may cause adverse effects.
- Do not place appliances that produce naked flames in places exposed to the airflow from the unit as this may impair combustion of the burner.
- Do not block air inlets nor outlets. Impaired airflow may result in insufficient performance or trouble.
- Do not sit on the outdoor unit, put things on the unit, or pull the unit. Doing so may cause accidents, such as falling or toppling down, thus resulting in injury, product malfunctioning, or product damage.
- Do not place objects that are susceptible to moisture directly beneath the indoor or outdoor units. Under certain conditions, condensation on the main unit or refrigerant pipes, air filter dirt or drain blockage may cause dripping, resulting in fouling or failure of the object concerned.
- After prolonged use, check the unit stand and its mounts for damage. If they are left in a damaged condition, the unit may fall and cause injury.
- To avoid injury, do not touch the air inlet or aluminium fins of the indoor or outdoor units.
- The appliance is not intended for use by unattended young children or infirm persons. Impairment of bodily functions and harm to health may result.
- This appliance can be used by children aged from 8 years and above and persons with reduced physical, sensory or mental capabilities or lack of experience and knowledge if they have been given supervision or instruction concerning use of the appliance in a safe way and understand the hazards involved.
- Children shall not play with the appliance.
- Cleaning and user maintenance shall not be made by children without supervision.
- Avoid impacts to the indoor and outdoor units, or otherwise product damage may result.
- Do not place flammable items, such as spray cans, within 1m of the air outlet.
- The spray cans may explode as a result of hot air from the indoor or outdoor units.
- Be careful not to let pets urinate on the air conditioner. Urination on the air conditioner may result in electric shocks or fire.
- Do not wash the air conditioner with water, as this may result in electric shocks or fire.
- Do not place water containers (vases etc.) above the unit, as this may result in electric shocks or fire hazards.

Safety precautions



CAUTION

- Do not turn off the breaker unless you smell something burning, or when doing repairs, inspection or cleaning of the unit (only for R32 refrigerant).
Refrigerant leakage cannot be detected otherwise (only for R32 refrigerant).
- Do not use flammable substances (such as hairsprays or insecticides etc.) near the unit. It could cause electric shock, fire, or a misdetection of the refrigerant sensor (only for R32 refrigerant).
- Do not install in sealed, highly airtight spaces such as soundproof chambers and room which was sealed up the door (only for R32 refrigerant).
- Do not install in places filled with smoke, gas, chemicals etc.
There is a possibility that the sensors inside the indoor unit could detect these, and display a refrigerant leak abnormality (only for R32 refrigerant).
- This unit is equipped with a refrigerant leak detector for safety. To be effective, the unit must be electrically powered at all times after installation, other than short service intervals (only for R32 refrigerant).
- This unit is equipped with electrically powered safety measures. To be effective, the unit must be electrically powered at all times after installation, other than short service intervals (only for R32 refrigerant).

-
- To avoid oxygen depletion, ensure that the room is adequately ventilated if equipment such as a burner is used together with the air conditioner.
 - Before cleaning, be sure to stop unit operation, turn off the circuit breaker or remove the power cord. Otherwise, an electric shock and injury may result.
After cleaning, quickly turn the power supply breaker back on.
 - Only connect the air conditioner to the specified power supply circuit. Power supplies other than the one specified may result in electric shocks, overheating and fires.
 - Arrange the drain hose to ensure smooth drainage. Imperfect drainage may cause wetting of the building, furniture etc.
 - Do not place objects in direct proximity of the outdoor unit and do not let leaves and other debris accumulate around the unit. Leaves are a hotbed for small animals which can enter the unit. Once in the unit, such animals can cause malfunctions, smoke or fire when making contact with electrical parts.
 - Do not place objects around the indoor unit.
 - Doing so may have an adverse influence on the performance, product quality, and life of the air conditioner.
 - Keep out of children's reach to ensure that they do not play with the appliance.



-
- Do not operate the air conditioner with wet hands.



-
- Do not wash the indoor unit with excessive water, only use a slightly wet cloth.
 - Do not place things such as vessels containing water or anything else on top of the unit. Water may penetrate into the unit and degrade electrical insulations, resulting in an electric shock.



Safety precautions

Installation site.

- To install the air conditioner in the following types of environments, consult the dealer.
 - Places with an oily ambient or where steam or soot occurs.
 - Salty environment such as coastal areas.
 - Places where sulfide gas occurs such as hot springs.
 - Places where snow may block the outdoor unit.
 - The indoor unit is at least 1 meter away from any television or radio set (unit may cause interference with the picture or sound).
 - The indoor unit maintain at least 1.5m distance between fire detectors and the air outlet of the indoor unit (only for R32 refrigerant).

The drain from the outdoor unit must be discharged to a place of good drainage.

Consider nuisance to your neighbours from noises.

- For installation, choose a place as described below.
 - A place solid enough to bear the weight of the unit which does not amplify the operation noise or vibration.
 - A place from where the air discharged from the outdoor unit or the operation noise will not annoy your neighbours.

Electrical work.

- For power supply, be sure to use a separate power circuit dedicated to the air conditioner.

System relocation.

- Relocating the air conditioner requires specialized knowledge and skills. Please consult the dealer if relocation is necessary for moving or remodeling.

Names of parts

■ Indoor Unit

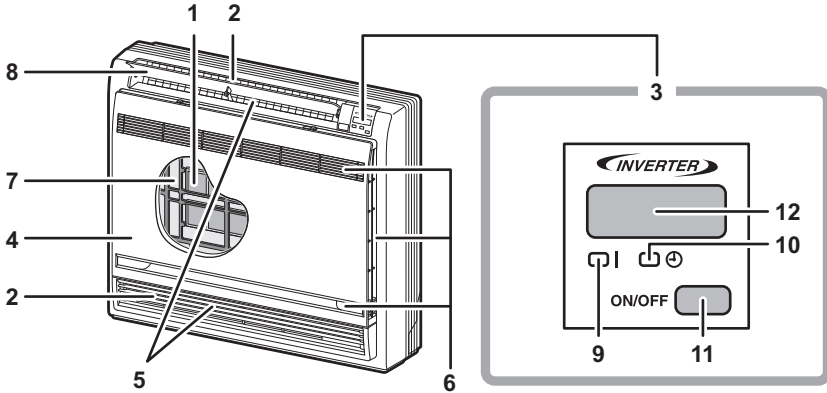



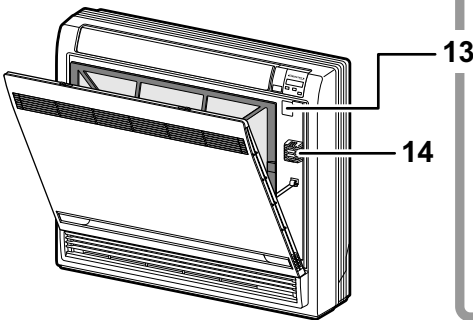

■ Opening the Front Panel

How to open the front panel: (page 28.)



Air outlet selection switch

-  This setting blows air from upper outlet only.
-  This setting automatically decides a blow pattern depending on mode and conditions.
- This setting is recommended. 
-  The unit is shipped from the factory with this setting.

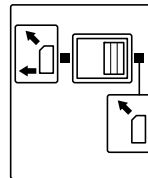

⚠ CAUTION

Before opening the front panel, be sure to stop the operation and turn the breaker OFF.
Do not touch the metal parts on the inside of the indoor unit, as it may result in injury.

■ Indoor Unit

1. Titanium Apatite Deodorizing Filter:

- These filters are attached to the inside of the air filters.

2. Air outlet

3. Display

4. Front panel

5. Vertical blades (louvers): (page 14.)

- The louvers are inside of the air outlet.

6. Air inlet

7. Air filter

8. Horizontal blade (flap): (page 14.)

9. Operation lamp (green)

10. TIMER lamp (yellow): (page 19.)

11. Indoor Unit ON/OFF switch:

- Push this switch once to start operation.
Push once again to stop it.

- The operation mode refers to the following table.

Model	Mode	Temperature setting	Airflow rate
COOLING ONLY	COOL	22°C	AUTO
HEAT PUMP	AUTO	25°C	AUTO

- This switch is useful when the remote controller is missing.

12. Signal receiver:

- It receives signals from the remote controller.
- When the unit receives a signal, you will hear a short beep.
 - Operation start beep-beep
 - Settings changed beep
 - Operation stop beeeep

13. Air outlet selection switch: (page 15.)

14. Room temperature sensor:

- It senses the air temperature around the unit.

■ Outdoor Unit

25/35 class

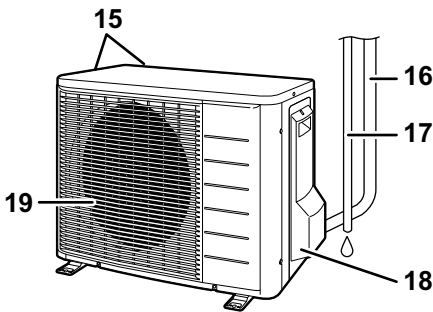

50 class

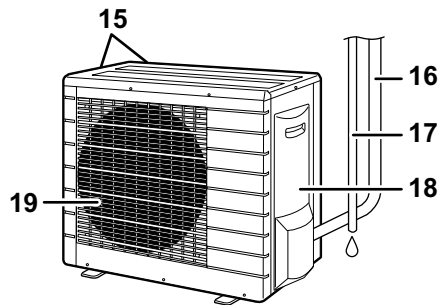

■ Outdoor Unit

15. Air inlet: (Back and side)

16. Refrigerant piping and inter-unit cable

17. Drain hose

18. Earth terminal:

- It is inside of this cover.

19. Air outlet

Appearance of the outdoor unit may differ from some models.

■ Remote Controller

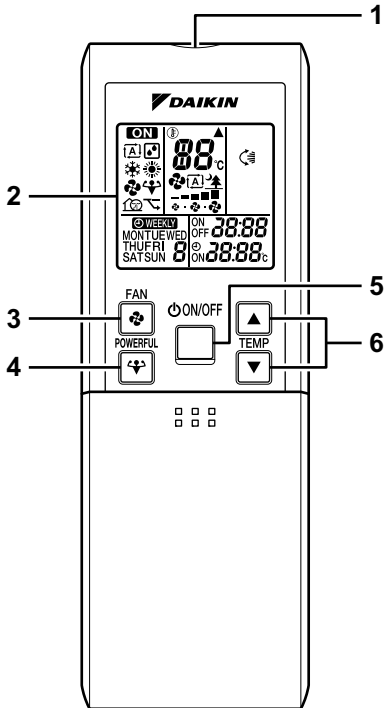

<ARC452A1>

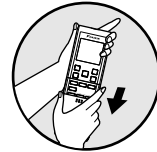

<Open the lid>

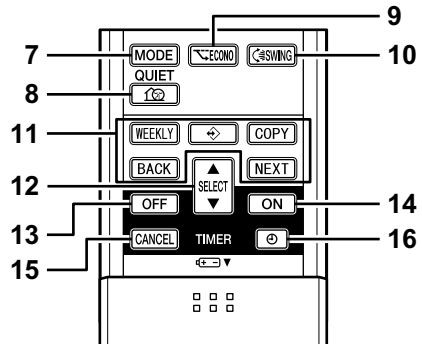

1. Signal transmitter:

- It sends signals to the indoor unit.

2. Display:

- It displays the current settings.
(In this illustration, each section is shown with all its displays ON for the purpose of explanation.)

3. FAN setting button:

- It selects the airflow rate setting.

4. POWERFUL button:

- POWERFUL operation (page 16.)

5. ON/OFF button:

- Press this button once to start operation.
Press once again to stop it.

6. TEMPERATURE adjustment buttons:

- It changes the temperature setting.

7. MODE selector button:

- It selects the operation mode.
(AUTO/DRY/COOL/HEAT/FAN) (page 12.)

8. QUIET button:

- OUTDOOR UNIT QUIET operation (page 17.)

9. ECONO button:

- ECONO operation (page 18.)

10. SWING button:

- Adjusting the Airflow Direction (page 14.)

11. WEEKLY/PROGRAM/COPY/BACK/NEXT button:

- WEEKLY TIMER operation (page 21.)

12. SELECT button:

- It changes the ON/OFF TIMER and
WEEKLY TIMER settings. (page 19, 21.)

13. OFF TIMER button:

- (page 19.)

14. ON TIMER button:

- (page 20.)

15. TIMER CANCEL button:

- It cancels the timer setting. (page 19, 20.)
- It cannot be used for the WEEKLY TIMER operation.

16. CLOCK button:

- (page 10.)

Preparation Before Operation

■ To set the batteries

1. Slide the front cover to take it off.
2. Set two dry batteries AAA.LR03 (alkaline).
3. Set the front cover as before.

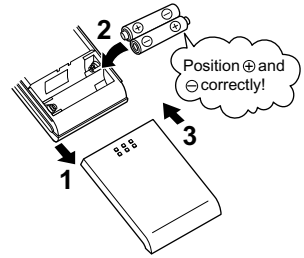

■ To operate the remote controller

- To use the remote controller, aim the transmitter at the indoor unit. If there is anything to block signals between the unit and the remote controller, such as a curtain, the unit will not operate.
- Do not drop the remote controller. Do not get it wet.
- The maximum distance for communication is about 7m.

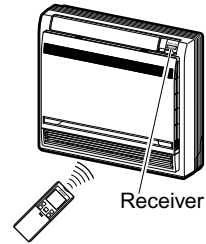

■ To fix the remote controller holder on the wall

1. Choose a place from where the signals reach the unit.
2. Fix the holder to a wall, a pillar, or similar location with the screws procured locally.
3. Place the remote controller in the remote controller holder.

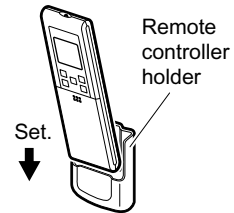

- To remove, pull it upwards.

ATTENTION

■ About batteries

- When replacing the batteries, use batteries of the same type, and replace the two old batteries together.
- When the system is not used for a long time, take the batteries out.
- The batteries will last for approximately one year. If the remote controller display begins to fade and the degradation of reception performance occurs within a year, however, replace both two batteries with new size AAA.LR03(alkaline).
- The attached batteries are provided for the initial use of the system.
The usable period of the batteries may be short depending on the manufactured date of the air conditioner.

■ About remote controller

- Never expose the remote controller to direct sunlight.
- Dust on the signal transmitter or receiver will reduce the sensitivity. Wipe off dust with soft cloth.
- Signal communication may be disabled if an electronic-starter-type fluorescent lamp (such as inverter-type lamps) is in the room. Consult the shop if that is the case.
- If the remote controller signals happen to operate another appliance, move that appliance to somewhere else, or consult the shop.

Preparation Before Operation

■ To set the clock

1. Press “**CLOCK button**”.

0:00 is displayed.

MON and  blinks.

2. Press “**SELECT button**” to set the current day of the week.

3. Press “**CLOCK button**”.

 blinks.

4. Press “**SELECT button**” to set the clock to the present time.

Holding down “▲” or “▼” button rapidly increases or decreases the time display.

5. Press “**CLOCK button**”.

Always point the remote controller at the indoor unit when pushing the buttons when setting the indoor unit’s internal clock.

 blinks.

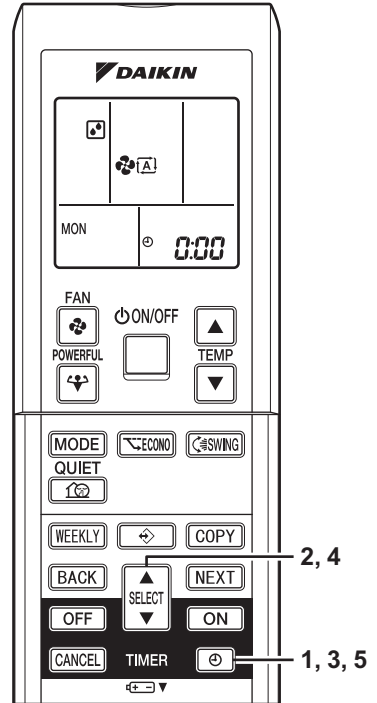

NOTE

- If the indoor unit’s internal clock is not set to the correct time, the WEEKLY TIMER will not operate punctually.

■ Turn the breaker ON

- Turning ON the breaker closes the flap. (This is a normal procedure.)

■ Checks on Remote Controller Settings

- This remote controller is common to the heat pump model and cooling only model. Use the dipswitches on the remote controller to set the heat pump model or cooling only model.
- Refer to the following explanation and make the setting as shown in the illustration.
 - For customers of Heat pump model: Set to H/P
 - For customers of Cooling-only model: Set to C/O

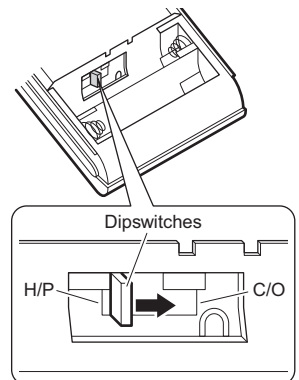

Operation range

■ Tips for saving energy

- Be careful not to cool (heat) the room too much.
Keeping the temperature setting at a moderate level helps save energy.

- Cover windows with a blind or a curtain.
Blocking sunlight and air from outdoors increases the cooling (heating) effect.

- Clogged air filters cause inefficient operation and waste energy. Clean them once in about every two weeks.

Recommended temperature setting
For cooling: 26°C – 28°C
For heating: 20°C – 24°C

■ Please note

- The air conditioner always consumes 15-35 watts of electricity even while it is not operating.
- If you are not going to use the air conditioner for a long period, for example in spring or autumn, turn the breaker OFF.
- Use the air conditioner in the following conditions.

For combination with R410A outdoor unit refer to the following table:

Outdoor units		Cool	Heat	Dry
2MK(X)S40	Outdoor temperature	10~46°C DB	-10~24°C DB	10~46°C DB
	Indoor temperature	18~32°C DB	10~30°C DB	18~32°C DB
2MK(X)S50	Outdoor temperature	10~46°C DB	-15~24°C DB	10~46°C DB
	Indoor temperature	18~32°C DB	10~30°C DB	18~32°C DB
2MK(X)S52	Outdoor temperature	-10~46°C DB	-15~24°C DB	-10~46°C DB
	Indoor temperature	18~32°C DB	10~30°C DB	18~32°C DB
3~5MK(X)S	Outdoor temperature	-10~46°C DB	-15~24°C DB	-10~46°C DB
	Indoor temperature	18~32°C DB	10~30°C DB	18~32°C DB
RK(X)S	Outdoor temperature	-10~46°C DB	-15~24°C DB	-10~46°C DB
	Indoor temperature	18~32°C DB	10~30°C DB	18~32°C DB
Indoor humidity ≤80% ^(a)				

For combination with R32 outdoor unit refer to the following table:

Outdoor units		Cool	Heat	
RXM25~50	Outdoor temperature	-10~46°C DB	-15~24°C DB	-16~18°C WB
	Indoor temperature	18~32°C DB	10~30°C DB	
2MXM40~50	Outdoor temperature	-10~46°C DB	-15~24°C DB	-16~18°C WB
	Indoor temperature	18~32°C DB	10~30°C DB	
3~5MXM40~90	Outdoor temperature	-10~46°C DB	-15~24°C DB	-16~18°C WB
	Indoor temperature	18~32°C DB	10~30°C DB	
Indoor humidity ≤80% ^(a)				

DB: Dry bulb temperature

WB: Wet bulb temperature

^(a) To avoid condensation and water dripping out of the unit. If the temperature or the humidity is beyond these conditions, safety devices may be put in action and the air conditioner may not operate.

If operation is continued out of this range:

- Operation outside this humidity or temperature range may cause a safety device to disable the system.
- A safety device may work to stop the operation. (In multi system, it may work to stop the operation of the outdoor unit only.)
- Condensation may occur on the indoor unit and drip

AUTO · DRY · COOL · HEAT · FAN Operation

The air conditioner operates with the operation mode of your choice.

From the next time on, the air conditioner will operate with the same operation mode.

■ To start operation

1. Press “MODE selector button” and select a operation mode.

- Each pressing of the button advances the mode setting in sequence.

: AUTO

: DRY

: COOL

: HEAT

: FAN

Cooling only model

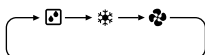

Heat pump model

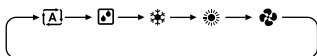

2. Press “ON/OFF button”.

- The OPERATION lamp lights up.

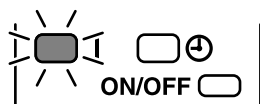

■ To stop operation

3. Press “ON/OFF button” again.

- Then OPERATION lamp goes off.

■ To change the temperature setting

4. Press “TEMPERATURE adjustment button”.

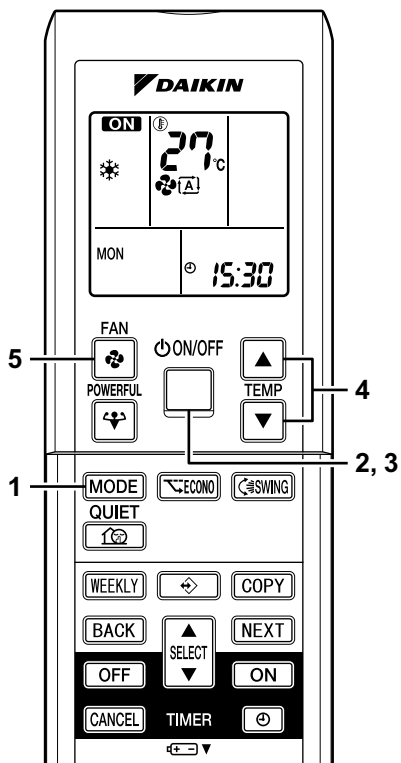





DRY or FAN mode	AUTO or COOL or HEAT mode
The temperature setting is not variable.	Press “▲” to raise the temperature and press “▼” to lower the temperature.
	Set to the temperature you like. 

AUTO · DRY · COOL · HEAT · FAN Operation

■ To change the airflow rate setting

5. Press “FAN setting button”.

DRY mode	AUTO or COOL or HEAT or FAN mode
The airflow rate setting is not variable.	Five levels of airflow rate setting from “  ” to “  ” plus “  ” “  ” are available. 

- Indoor unit quiet operation

When the airflow is set to “”, the noise from the indoor unit will become quieter. Use this when making the noise quieter.

NOTE

■ Note on HEAT operation

- Since this air conditioner heats the room by taking heat from outdoor air to indoors, the heating capacity becomes smaller in lower outdoor temperatures. If the heating effect is insufficient, it is recommended to use another heating appliance in combination with the air conditioner.
- The heat pump system heats the room by circulating hot air around all parts of the room. After the start of heating operation, it takes some time before the room gets warmer.
- In heating operation, frost may occur on the outdoor unit and lower the heating capacity. In that case, the system switches into defrosting operation to take away the frost.
- During defrosting operation, hot air does not flow out of indoor unit.

■ Note on COOL operation

- This air conditioner cools the room by blowing the hot air in the room outside, so if the outside temperature is high, the performance of the air conditioner drops.

■ Note on DRY operation

- The computer chip works to rid the room of humidity while maintaining the temperature as much as possible. It automatically controls temperature and airflow rate, so manual adjustment of these functions is unavailable.

■ Note on AUTO operation

- In AUTO operation, the system selects a temperature setting and an appropriate operation mode (COOL or HEAT) based on the room temperature at the start of the operation.
- The system automatically reselects setting at a regular interval to bring the room temperature to user-setting level.
- If you do not like AUTO operation, manually change the set temperature.





■ Note on airflow rate setting

- At smaller airflow rates, the cooling (heating) effect is also smaller.

Adjusting the Airflow Direction

You can adjust the airflow direction to increase your comfort.

■ To adjust the horizontal blade (flap)

1. Press “SWING button ”.
 - “” is displayed on the LCD and the flaps will begin to swing.
2. When the flap has reached the desired position, press “SWING button ” once more.
 - The flap will stop moving.
 - “” disappears from the LCD.

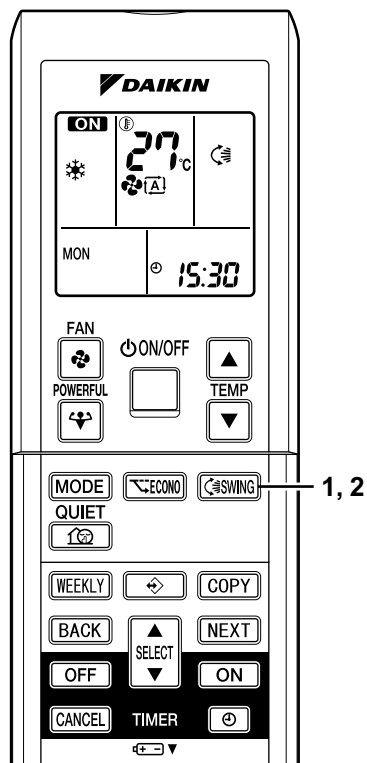

■ To adjust the vertical blades (louvers)

Hold the knob and move the louver.
(You will find a knob on the left-side and the right-side blades.)

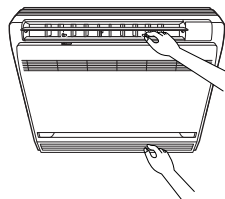

Notes on flap and louvers angle

- Unless “SWING” is selected, you should set the flap at a near-horizontal angle in HEAT mode and at a upward position in COOL or DRY mode to obtain the best performance.

■ ATTENTION

- When adjusting the flap by hand, turn off the unit, and use the remote controller to restart the unit.
- Be careful when adjusting the louvers. Inside the air outlet, a fan is rotating at a high speed.

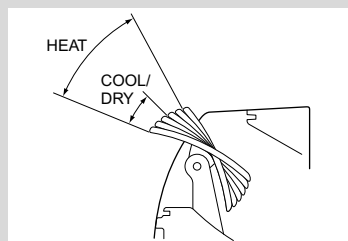

Adjusting the Airflow Direction

■ Airflow selection

- Make airflow selection according to what suits you.

When setting the airflow selection switch to .

- Air conditioner automatically decides the appropriate blowing pattern depending on the operating mode/situation.

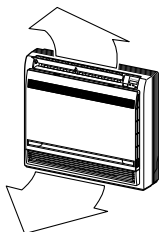
Operating mode	Situation	Blowing pattern
COOL mode	<ul style="list-style-type: none"> • When the room has become fully cool, or when one hour has passed since turning on the air conditioner. 	<ul style="list-style-type: none"> • So that air does not come into direct contact with people, air is blown upper air outlet, room temperature is equalized.
	<ul style="list-style-type: none"> • At start of operation or other times when the room is not fully cooled. 	<div style="text-align: center;">  </div> <ul style="list-style-type: none"> • In case of R410A refrigerant. Air is blown from the upper and lower air outlets for high speed cooling during COOL mode, and for filling the room with warm air during HEAT mode. • In case of R32 refrigerant. Air is blown from the upper and lower air outlets during HEAT mode and for high speed cooling during COOL mode.
HEAT mode	<ul style="list-style-type: none"> • Normal time. 	
	<ul style="list-style-type: none"> • At start or when air temperature is low (only for R410A refrigerant). 	<ul style="list-style-type: none"> • So that air does not come into direct contact with people. Air is blown upper air outlet (only for R410A refrigerant).

- During Dry mode, so that cold air does not come into direct contact with people, air is blown upper air outlet.

When setting the air outlet selection switch to .

- Regardless of the operating mode or situation, air blows from the upper air outlet.
- Use this switch when you do not want air coming out of the lower air outlet. (While sleeping and feeling cold airflow during HEAT mode etc.)

CAUTION

- Do not try to adjust the flap by hand.
- When adjusting by hand, the mechanism may not operate properly or condensation may drip from air outlets.

POWERFUL Operation

POWERFUL operation quickly maximizes the cooling (heating) effect in any operation mode. You can get the maximum capacity.

■ To start POWERFUL operation

1. Press “POWERFUL button”.

- POWERFUL operation ends in 20minutes. Then the system automatically operates again with the previous settings which were used before POWERFUL operation.
- “” is displayed on the LCD.
- When using POWERFUL operation, there are some functions which are not available.

■ To cancel POWERFUL operation

2. Press “POWERFUL button” again.

- “” disappears from the LCD.

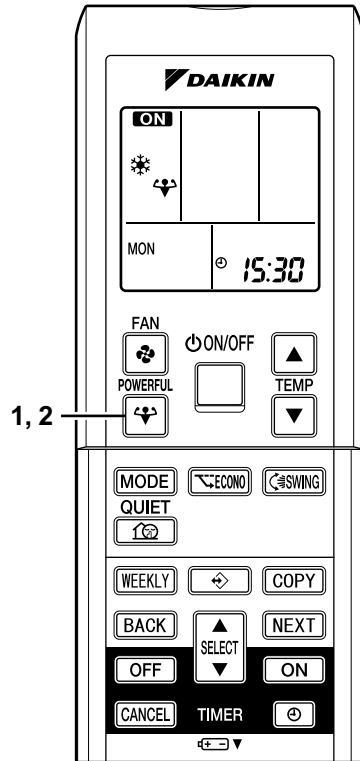

NOTE

■ Notes on POWERFUL operation

- POWERFUL Operation cannot be used together with ECONO or QUIET Operation. Priority is given to the function of whichever button is pressed last.
- POWERFUL Operation can only be set when the unit is running. Pressing the operation stop button causes the settings to be canceled, and the “” disappears from the LCD.
- POWERFUL Operation will not increase the capacity of the air conditioner if the air conditioner is already in operation with its maximum capacity demonstrated.
- **In COOL and HEAT mode**
To maximize the cooling (heating) effect, the capacity of outdoor unit must be increased and the airflow rate be fixed to the maximum setting.
The temperature and airflow settings are not variable.
- **In DRY mode**
The temperature setting is lowered by 2.5°C and the airflow rate is slightly increased.
- **In FAN mode**
The airflow rate is fixed to the maximum setting.
- **When using priority-room setting**
See “Note for Multi System”. (page 26.)

OUTDOOR UNIT QUIET Operation

OUTDOOR UNIT QUIET operation lowers the noise level of the outdoor unit by changing the frequency and fan speed on the outdoor unit. This function is convenient during night.

■ To start OUTDOOR UNIT QUIET operation

1. Press “QUIET button”.
 - “” is displayed on the LCD.

■ To cancel OUTDOOR UNIT QUIET operation

2. Press “QUIET button” again.
 - “” disappears from the LCD.

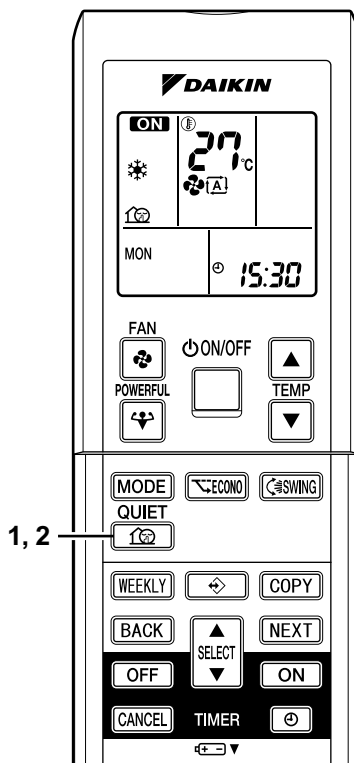

NOTE

■ Note on OUTDOOR UNIT QUIET operation

- If using a multi system, this function will work only when the OUTDOOR UNIT QUIET operation is set on all operated indoor units. However, if using priority-room setting, see “Note for Multi System”. (page 26.)
- This function is available in COOL, HEAT, and AUTO modes. (This is not available in FAN and DRY mode.)
- POWERFUL operation and OUTDOOR UNIT QUIET operation cannot be used at the same time. Priority is given to the function of whichever button is pressed last.
- If operation is stopped using the remote controller or the main unit ON/OFF switch when using OUTDOOR UNIT QUIET operation, “” will remain on the remote controller display.
- OUTDOOR UNIT QUIET operation will drop neither the frequency nor fan speed if the frequency and fan speed have been already dropped low enough.

ECONO Operation

ECONO operation is a function which enables efficient operation by limiting the maximum power consumption value.

This function is useful for cases in which attention should be paid to ensure a circuit breaker will not trip when the product runs alongside other appliances.

■ To start ECONO operation

1. Press “ECONO button”.

- “” is displayed on the LCD.

■ To cancel ECONO operation

2. Press “ECONO button” again.

- “” disappears from the LCD.

Running current and power consumption

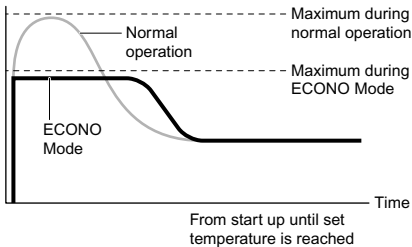

- This diagram is a representation for illustrative purposes only.

* The maximum running current and power consumption of the air conditioner in ECONO mode vary with the connecting outdoor unit.

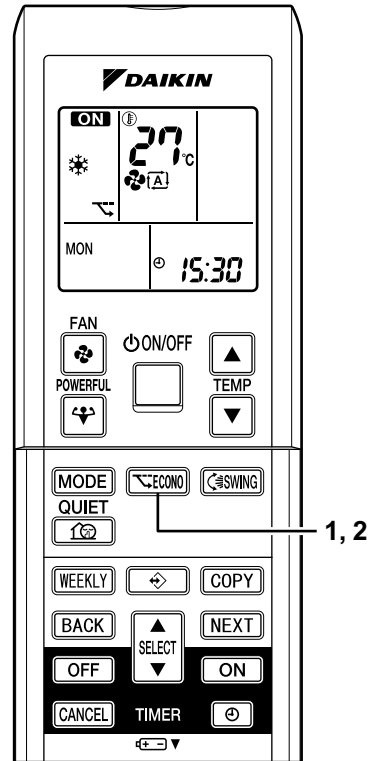

NOTE

- ECONO Operation can only be set when the unit is running. Pressing the operation stop button causes the settings to be canceled, and the “” disappears from the LCD.
- ECONO operation is a function which enables efficient operation by limiting the power consumption of the outdoor unit (operating frequency).
- ECONO operation functions in AUTO, COOL, DRY, and HEAT modes.
- POWERFUL and ECONO operation cannot be used at the same time. Priority is given to the function of whichever button is pressed last.
- Power consumption may not drop even if ECONO operation is used if the level of power consumption is already low.

TIMER Operation

Timer functions are useful for automatically switching the air conditioner on or off at night or in the morning. You can also use OFF TIMER and ON TIMER in combination.

■ To use OFF TIMER operation

- Check that the clock is correct.
If not, set the clock to the present time.
(page 10.)

1. Press “OFF TIMER button”.

0:00 is displayed.

OFF blinks.

2. Press “SELECT button” until the time setting reaches the point you like.

- Every pressing of either button increases or decreases the time setting by 10 minutes. Holding down either button changes the setting rapidly.

3. Press “OFF TIMER button” again.

- The TIMER lamp lights up.

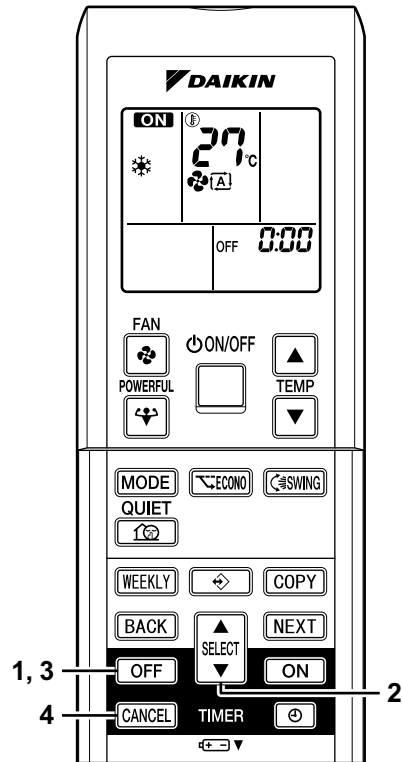
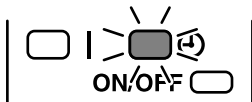

■ To cancel the OFF TIMER Operation

4. Press “CANCEL button”.

- The TIMER lamp goes off.

NOTE

- When TIMER is set, the present time is not displayed.
- Once you set ON, OFF TIMER, the time setting is kept in the memory. (The memory is canceled when remote controller batteries are replaced.)
- When operating the unit via the ON/OFF Timer, the actual length of operation may vary from the time entered by the user. (Maximum approx. 10 minutes)

■ NIGHT SET MODE

When the OFF TIMER is set, the air conditioner automatically adjusts the temperature setting (0.5°C up in COOL, 2.0°C down in HEAT) to prevent excessive cooling (heating) for your pleasant sleep.

TIMER Operation

■ To use ON TIMER operation

- Check that the clock is correct. If not, set the clock to the present time. (page 10.)

1. Press “ON TIMER button”.

6:00 is displayed.

ON blinks.

2. Press “SELECT button” until the time setting reaches the point you like.

- Every pressing of either button increases or decreases the time setting by 10 minutes. Holding down either button changes the setting rapidly.

3. Press “ON TIMER button” again.

- The TIMER lamp lights up.

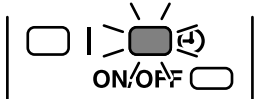

■ To cancel ON TIMER operation

4. Press “CANCEL button”.

- The TIMER lamp goes off.

■ To combine ON TIMER and OFF TIMER

- A sample setting for combining the two timers is shown below.

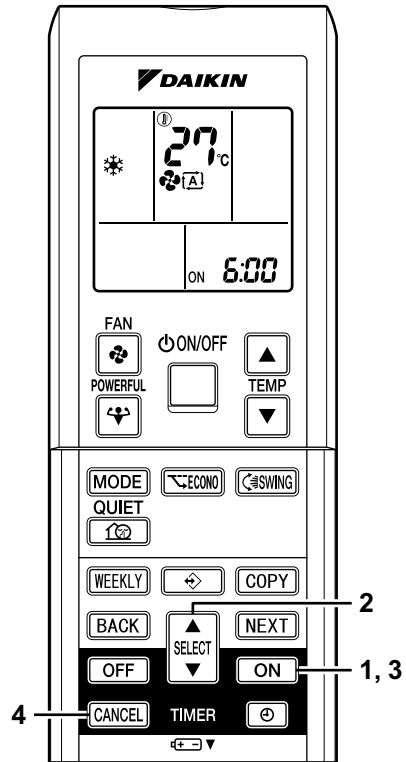
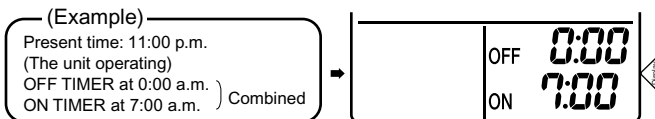

ATTENTION

■ In the following cases, set the timer again.

- After a breaker has turned OFF.
- After a power failure.
- After replacing batteries in the remote controller.

WEEKLY TIMER Operation

Up to 4 timer settings can be saved for each day of the week. It is convenient if the WEEKLY TIMER is set according to the family's life style.

■ Using in these cases of WEEKLY TIMER

An example of WEEKLY TIMER settings is shown below.

Example: The same timer settings are made for the week from Monday through Friday while different timer settings are made for the weekend.

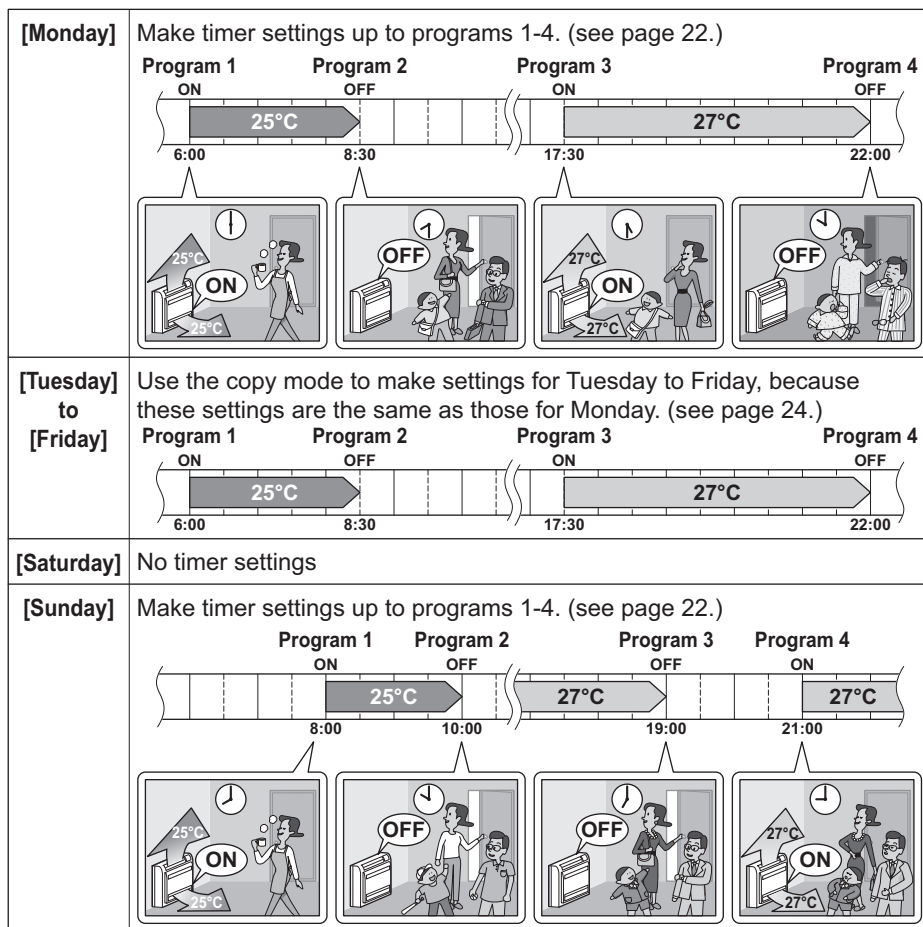

- Up to 4 reservations per day and 28 reservations per week can be set in the WEEKLY TIMER. The effective use of the copy mode ensures ease of making reservations.
- The use of ON-ON-ON-ON settings, for example, makes it possible to schedule operating mode and set temperature changes. Furthermore, by using OFF-OFF-OFF-OFF settings, only the turn-OFF time of each day can be set. This will turn OFF the air conditioner automatically if the user forgets to turn it OFF.

WEEKLY TIMER Operation

■ To use WEEKLY TIMER operation

Setting mode

- Make sure the day of the week and time are set. If not, set the day of the week and time. (page 10.)

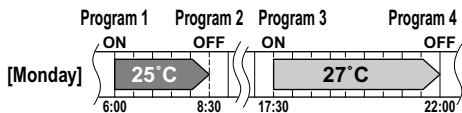

1. Press “” button”.

- The day of the week and the reservation number of the current day will be displayed.
- 1 to 4 settings can be made per day.

2. Press the “SELECT button” to select the desired day of the week and reservation number.

- Pressing the “SELECT button” changes the reservation number and the day of the week.

3. Press “NEXT button”.

- The day of the week and reservation number will be set.
- “” and “ON” blink.

4. Press “SELECT button” to select the desired mode.

- Pressing the “SELECT button” changes “ON” or “OFF” setting in sequence.

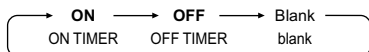

- In case the reservation has already been set, selecting “blank” deletes the reservation.
- Go to STEP 9 if “blank” is selected.

5. Press “NEXT button”.

- The ON/OFF TIMER mode will be set.
- “” and the time blink.

6. Press “SELECT button” to select the desired time.

- The time can be set between 0:00 and 23:50 in 10 minute intervals.
- To return to the ON/OFF TIMER mode setting, press “BACK button”.
- Go to STEP 9 when setting the OFF TIMER.

7. Press “NEXT button”.

- The time will be set.
- “” and the temperature blink.

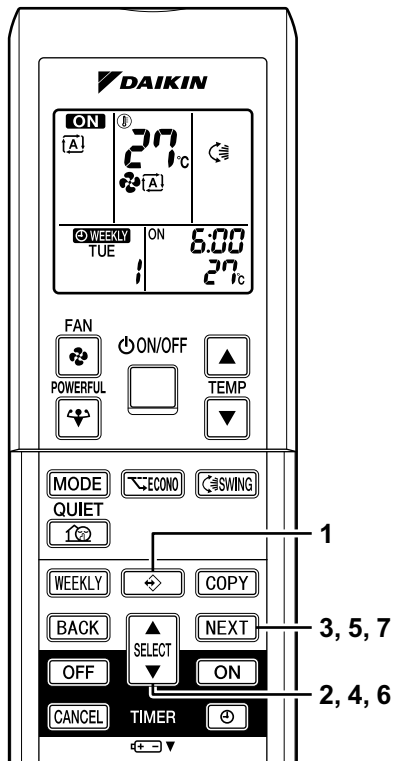

Setting Displays



Day and number settings



ON/OFF settings

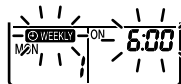

Time settings

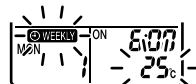

Temperature settings

WEEKLY TIMER Operation

8. Press “SELECT button” to select the desired temperature.

- The temperature can be set between 10°C and 32°C.
Cooling: The unit operates at 18°C even if it is set at 10 to 17°C.
Heating: The unit operates at 30°C even if it is set at 31 to 32°C.
- To return to the time setting, press “BACK button”.
- The set temperature is only displayed when the mode setting is on.

9. Press “NEXT button”.

- The temperature will be set and go to the next reservation setting.
- To continue further settings, repeat the procedure from STEP 4.

10. Press “↔ button” to complete the setting.

- Be sure to direct the remote controller toward the indoor unit and check for a receiving tone and flashing the operation lamp.
- “**WEEKLY**” is displayed on the LCD and WEEKLY TIMER operation is activated.
- The TIMER lamp lights up.
- A reservation made once can be easily copied and the same settings used for another day of the week.

Refer to **Copy mode** . (page 24.)

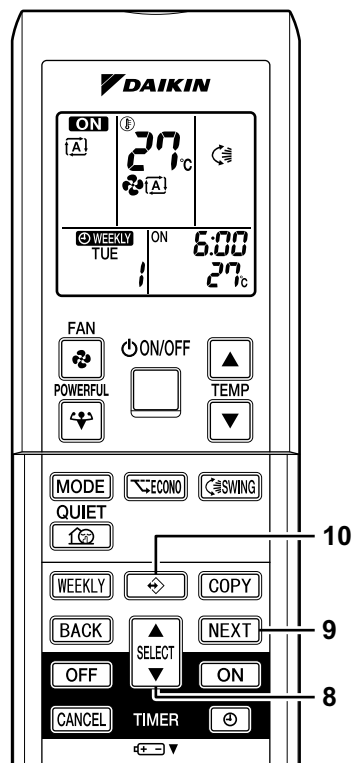

NOTE

■ Notes on WEEKLY TIMER operation

- Do not forget to set the clock on the remote control first.
- The day of the week, ON/OFF TIMER mode, time and set temperature (only for ON TIMER mode) can be set with WEEKLY TIMER. Other settings for ON TIMER are based on the settings just before the operation.
- Both WEEKLY TIMER and ON/OFF TIMER operation cannot be used at the same time. The ON/OFF TIMER operation has priority if it is set while WEEKLY TIMER is still active. The WEEKLY TIMER will go into standby state, and “**WEEKLY**” will disappear from the LCD. When ON/OFF TIMER is up, the WEEKLY TIMER will automatically become active.
- Only the time and set temperature set with the weekly timer are sent with the “↔ button”. Set the weekly timer only after setting the operation mode, the fan strength, and the fan direction ahead of time.
- Shutting the breaker off, power failure, and other similar events will render operation of the indoor unit’s internal clock inaccurate. Reset the clock. (page 10.)
- The “BACK button” can be used only for the time and temperature settings. It cannot be used to go back to the reservation number.

WEEKLY TIMER Operation

Copy mode

- A reservation made once can be copied another day of the week. The whole reservation of the selected day of the week will be copied.

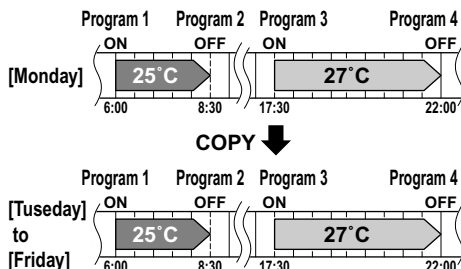

- Press “” button.
- Press “SELECT button” to confirm the day of the week to be copied.
- Press “COPY button” to activate copy mode.

- The whole reservation of the selected day of the week will be copied.

- Press “SELECT button” to select the destination day of the week.

- Press “COPY button”.

- The reservation will be copied to the selected day of the week. The whole reservation of the selected day of the week will be copied.
- To continue copying the settings to other days of the week, repeat STEP 4 and STEP 5.

- Press “” button to complete the setting.

- “ WEEKLY” is displayed on the LCD and WEEKLY TIMER operation is activated.

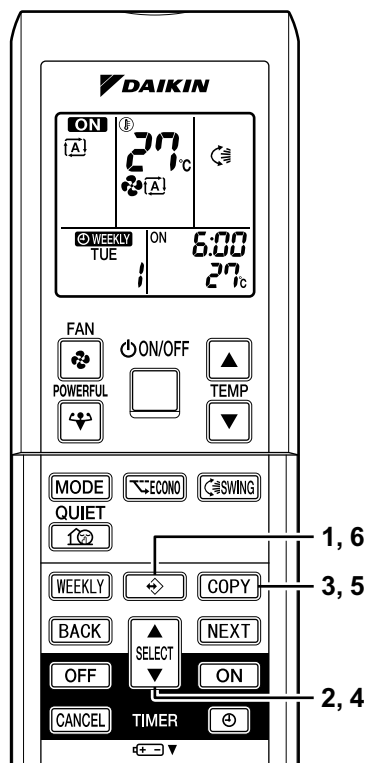

Setting Displays

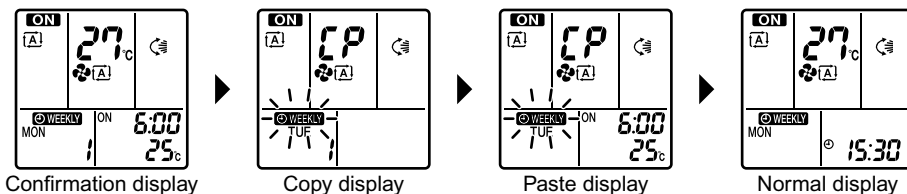

Confirmation display

Copy display

Paste display

Normal display

NOTE

■ COPY MODE

- The entire reservation of the source day of the week is copied in the copy mode. In the case of making a reservation change for any day of the week individually after copying the content of weekly reservations, press “” button and change the settings in the steps of **Setting mode**. (page 22.)

WEEKLY TIMER Operation

■ Confirming a reservation

- The reservation can be confirmed.

1. Press “” button”.

- The day of the week and the reservation number of the current day will be displayed.

2. Press “SELECT button” to select the day of the week and the reservation number to be confirmed.

- Pressing the “SELECT button” displays the reservation details.
- To change the confirmed reserved SETTINGS, select the reservation number and press “NEXT button”.
- The mode is switched to setting mode. Go to **Setting mode** STEP 4. (page 22.)

3. Press “” button to exit confirming mode.

- “ WEEKLY” is displayed on the LCD and WEEKLY TIMER operation is activated.
- The TIMER lamp lights up.

Setting Displays

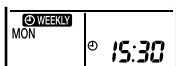

Normal display



Confirmation display

■ To deactivate WEEKLY TIMER operation

4. Press “WEEKLY button” while

“ WEEKLY” is displayed on the LCD.

- The “ WEEKLY” will disappear from the LCD.
- The TIMER lamp goes off.
- To reactivate the WEEKLY TIMER operation, press the “WEEKLY button” again.
- If a reservation deactivated with “WEEKLY button” is activated once again, the last reservation mode will be used.

■ To delete reservations

The individual reservation

- Refer to **Setting mode** (page 22.)
- When selecting desired mode at STEP 4 in setting mode, select “blank”. The reservation will be deleted.

The reservations for each day of the week

- This function can be used for deleting reservations for each day of the week.

5. Press “” button”.

6. Select the day of the week to be canceled with the “SELECT button”.

7. Hold the “WEEKLY button” for 5 seconds.

- The reservation of the selected day of the week will be deleted.

All reservations

8. Hold “WEEKLY button” for 5 seconds while normal display.

- Be sure to direct the remote control toward the main unit and check for a receiving tone.
- This operation is not effective while WEEKLY TIMER is being set.
- All reservations will be deleted.

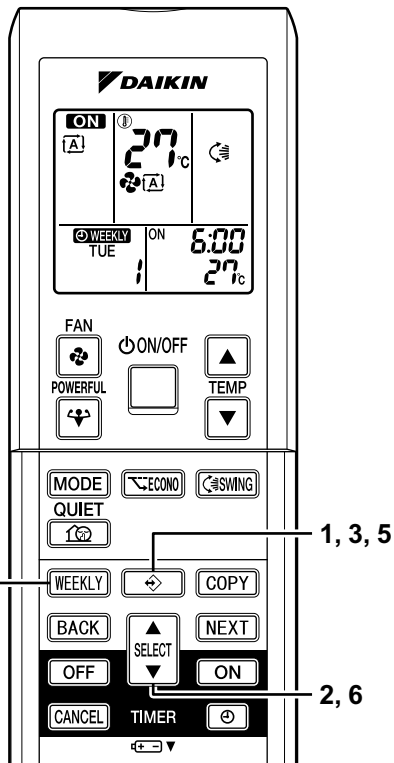

Note for Multi System

<< What is a “Multi System”? >>

This system has one outdoor unit connected to multiple indoor units.

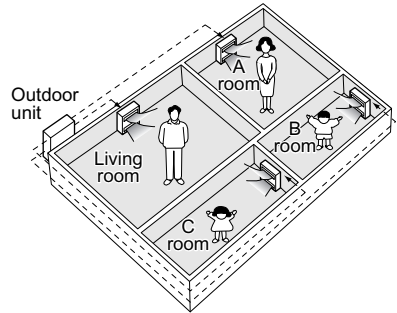

■ Selecting the operation mode

1. With the Priority Room Setting present but inactive or not present.

When more than one indoor unit is operating, priority is given to the first unit that was turned on. In this case, set the units that are turned on later to the same operation mode (*1) as the first unit.

Otherwise, they will enter the Standby Mode, and the operation lamp will flash; this does not indicate malfunction. (*1)

- COOL, DRY and FAN mode may be used at the same time.
- AUTO mode automatically selects COOL mode or HEAT mode based on the room temperature. Therefore, AUTO mode is available when selecting the same operation mode as that of the room with the first unit to be turned on.

<CAUTION>

Normally, the operation mode in the room where the unit is first run is given priority, but the following situations are exceptions, so please keep this in mind.

If the operation mode of the first room is **FAN Mode**, then using **Heating Mode** in any room after this will give priority to **heating**. In this situation, the air conditioner running in FAN Mode will go on standby, and the operation lamp will flash.

2. With the Priority Room Setting active.

See “Priority Room Setting” on the next page.

■ NIGHT QUIET Mode (Available only for cooling operation)

NIGHT QUIET Mode requires initial programming during installation. Please consult your retailer or dealer for assistance. NIGHT QUIET Mode reduces the operation noise of the outdoor unit during the night time hours to prevent annoyance to neighbors.

- The NIGHT QUIET Mode is activated when the temperature drops 5°C or more below the highest temperature recorded that day. Therefore, when the temperature difference is less than 5°C, this function will not be activated.
- NIGHT QUIET Mode reduces slightly the cooling (heating) efficiency of the unit.

■ OUTDOOR UNIT QUIET operation (page 17.)

1. With the Priority Room Setting present but inactive or not present.

When using the OUTDOOR UNIT QUIET operation feature with the Multi system, set all indoor units to OUTDOOR UNIT QUIET operation using their remote controllers.

When clearing OUTDOOR UNIT QUIET operation, clear one of the operating indoor units using their remote controller. However OUTDOOR UNIT QUIET operation display remains on the remote controller for other rooms. We recommend you release all rooms using their remote controllers.

2. With the Priority Room Setting active.

See “Priority Room Setting” on the next page.

■ Cooling / Heating mode lock (Available only for heat pump models)

The Cooling / Heating Mode Lock requires initial programming during installation. Please consult your retailer or dealer for assistance. The Cooling / Heating Mode Lock sets the unit forcibly to either Cooling or Heating Mode. This function is convenient when you wish to set all indoor units connected to the Multi system to the same operation mode.

Note for Multi System

■ Priority Room Setting

The Priority Room Setting requires initial programming during installation. Please consult your retailer or dealer for assistance.

The room designated as the Priority Room takes priority in the following situations;

1. Operation mode Priority.

As the operation mode of the Priority Room takes precedence, the user can select a different operation mode from other rooms.

(Example)

* Room A is the Priority Room in the examples.

When COOL mode is selected in Room A while operating the following modes in Room B,C and D:

Operation mode in Room B, C and D	Status of Room B, C and D when the unit in Room A is in COOL mode
COOL or DRY or FAN	Current operation mode maintained
HEAT	The unit enters Standby Mode. Operation resumes when the Room A unit stops operating.
AUTO	If the unit is set to COOL mode, operation continues. If set to HEAT mode, it enters Standby Mode. Operation resumes when the Room A unit stops operating.

2. Priority when POWERFUL operation is used.

(Example)

* Room A is the Priority Room in the examples.

The indoor units in Rooms A,B,C and D are all operating. If the unit in Room A enters POWERFUL operation, operation capacity will be concentrated in Room A. In such a case, the cooling (heating) efficiency of the units in Rooms B,C and D may be slightly reduced.

3. Priority when using OUTDOOR UNIT QUIET operation.

(Example)

* Room A is the Priority Room in the examples.

Just by setting the unit in Room A to QUIET operation, the air conditioner starts OUTDOOR UNIT QUIET operation.

You don't have to set all the operated indoor units to QUIET operation.

Care and Cleaning



CAUTION Before cleaning, be sure to stop the operation and turn the breaker OFF.

Units

■ Indoor unit, Outdoor unit and Remote controller

1. Wipe them with dry soft cloth.

■ Front panel

1. Open the front panel.

- Slide the two stoppers on the left and right sides inward until they click.

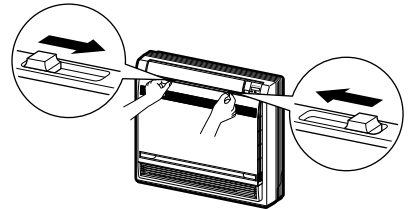

2. Remove the front panel.

- Remove the string.
- Allowing the front panel to fall forward will enable you to remove it.

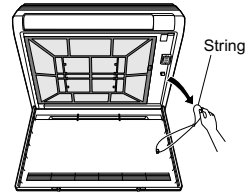

3. Clean the front panel.

- Wipe it with a soft cloth soaked in water.
- Only neutral detergent may be used.
- In case of washing the front panel with water, dry it with cloth, dry it up in the shade after washing.

4. Attach the front panel.

- Insert the front panel into the grooves of the unit (3 places).
- Attach the string to the right, inner-side of the front grille.
- Close the panel slowly.

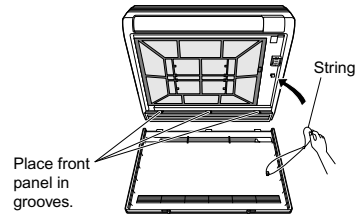

CAUTION

- Don't touch the metal parts of the indoor unit. If you touch those parts, this may cause an injury.
- When removing or attaching the front panel, use a robust and stable stool and watch your steps carefully.
- When removing or attaching the front panel, support the panel securely with hand to prevent it from falling.
- For cleaning, do not use hot water above 40°C, benzene, gasoline, thinner, nor other volatile oils, polishing compound, scrubbing brushes, nor other hand stuff.
- After cleaning, make sure that the front panel is securely fixed.
- After cleaning, quickly turn the power supply breaker back on (only for R32 refrigerant).

Filters

1. Open the front panel. (page 28.)

2. Remove the air filter.

- Press the claws on the right and left of the air filter down slightly, then pull upward.

3. Take off the Titanium Apatite Deodorizing Filter.

- Hold the tabs of the frame, and remove the claws in 4 places.

4. Clean or replace each filter.

See figure.

5. Set the air filter and Titanium Apatite Deodorizing Filter as they were and close the front panel.

- Operation without air filters may result in troubles as dust will accumulate inside the indoor unit.

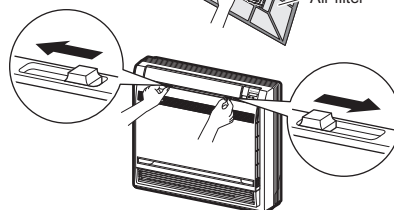
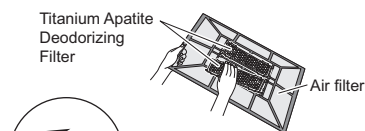
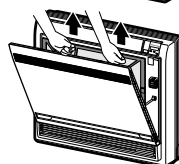
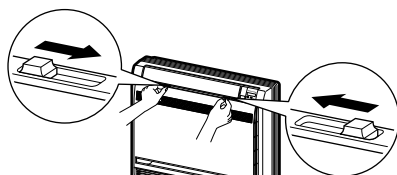

■ Air Filter

1. Wash the air filters with water or clean them with vacuum cleaner.

- If the dust does not come off easily, wash them with neutral detergent thinned with lukewarm water, then dry them up in the shade.
- It is recommended to clean the air filters every 2 weeks.

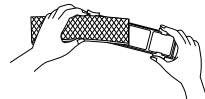
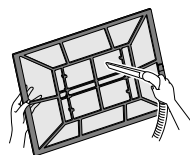

■ Titanium Apatite Deodorizing Filter

The Titanium Apatite Deodorizing Filter can be renewed by washing it with water once every 6 months. We recommend replacing it once every 3 years.

[Maintenance]

1. Vacuum dusts, and soak in warm water or water for about 10 to 15 minutes if dirt is heavy.
2. Do not remove filter from frame when washing with water.
3. After washing, shake off remaining water and dry in the shade.
4. Since the material is made out of paper, do not wring out the filter when removing water from it.

[Replacement]

1. Remove the tabs on the filter frame and replace with a new filter.
 - Dispose of the old filter as flammable waste.

NOTE

- Operation with dirty filters:
(1) cannot deodorize the air. (2) cannot clean the air.
(3) results in poor heating or cooling. (4) may cause odour.
- To order Titanium Apatite Deodorizing Filter contact to the service shop there you bought the air conditioner.
- Dispose of the old filter as flammable waste.

Item	Part No.
Titanium Apatite Deodorizing Filter (without frame) 1 set	KAF968A42

Check

Check that the base, stand and other fittings of the outdoor unit are not decayed or corroded.
Check that nothing blocks the air inlets and the outlets of the indoor unit and the outdoor unit.
Check that the drain comes smoothly out of the drain hose during COOL or DRY operation. <ul style="list-style-type: none">• If no drain water is seen, water may be leaking from the indoor unit. Stop operation and consult the service shop if this is the case.

■ Before a long idle period

- 1. Operate the “FAN only” for several hours on a fine day to dry out the inside.**
 - Press “MODE” button and select “FAN” operation.
 - Press “ON/OFF” button and start operation.
- 2. After operation stops, turn off the breaker for the room air conditioner.**
- 3. Clean the air filters and set them again.**
- 4. After cleaning, quickly turn the power supply breaker back on (only for R32 refrigerant).**
- 5. Take out batteries from the remote controller.**

NOTE

- When a multi outdoor unit is connected, make sure the heating operation is not used at the other room before you use the fan operation. (page 26.)

Trouble Shooting

Check again.

Please check again before calling a service man.

Case	Check
The air conditioner does not operate. (OPERATION lamp is off.)	<ul style="list-style-type: none"> • Hasn't a breaker turned OFF or a fuse blown? • Isn't it a power failure? • Are batteries set in the remote controller? • Is the timer setting correct?
Cooling (Heating) effect is poor.	<ul style="list-style-type: none"> • Are the air filters clean? • Is there anything to block the air inlet or the outlet of the indoor and the outdoor units? • Is the temperature setting appropriate? • Are the windows and doors closed? • Are the airflow rate and the air direction set appropriately?
Operation stops suddenly. (OPERATION lamp flashes.)	<ul style="list-style-type: none"> • Are the air filters clean? • Is there anything to block the air inlet or the outlet of the indoor and the outdoor units? Clean the air filters or take all obstacles away and turn the breaker OFF. Then turn it ON again and try operating the air conditioner with the remote controller. If the lamp still flashes, call the service shop where you bought the air conditioner. • Are operation modes all the same for indoor units connected to outdoor units in the multi system? If not, set all indoor units to the same operation mode and confirm that the lamps flash. Moreover, when the operation mode is in "AUTO", set all indoor unit operation modes to "COOL" or "HEAT" for a moment and check again that the lamps are normal. If the lamps stop flashing after the above steps, there is no malfunction. (page 26.)
An abnormal functioning happens during operation.	<ul style="list-style-type: none"> • The air conditioner may malfunction with lightning or radio waves. Turn the breaker OFF, turn it ON again and try operating the air conditioner with the remote controller.
Noise interferes with television pictures or radio sound while the air conditioner is in operation.	<ul style="list-style-type: none"> • Make sure that no television or radio sets are located close to the indoor unit. • Keep the television or radio sets at least 1 m away from the indoor unit.
Attempted heating, but the unit would not accept the instruction.	<ul style="list-style-type: none"> • When selecting heating, warning beeps are heard, the main unit operating lamp (green) blinks for 5 seconds, and the current operating status is maintained.
The remote controller allows selection of "heating" even though the unit is cooling only model.	<ul style="list-style-type: none"> Check the specifications of the outdoor unit. If the outdoor unit is cooling only model, set the remote controller for a cooling only model using the cooling only/heat pump switch on the remote controller. (page 12.) If you do not know how to switch the setting, contact the service shop where you purchased the air conditioner.
Heating cannot be selected, even though the unit is heat pump model.	<ul style="list-style-type: none"> • Set the remote controller so that it is for a heat pump model by using the cooling only/heat pump switch on the remote controller. (page 12.) If you do not know how to switch the setting, contact the service shop where you purchased the air conditioner.

In case of refrigerant leakage sensor

Please pay attention if unit has some abnormal operation. See cases and explanations below.

Case	Explanation
<p>The unit is operating by itself.</p> <p>The fan is spinning by itself, when the unit is turned off. (The operation light is flashing.)</p>	<ul style="list-style-type: none"> ■ It is because the refrigerant leakage sensor started working: <ul style="list-style-type: none"> • In case it makes a beeping sound, there is a risk of refrigerant leakage. Please ventilate the room and contact your dealer. • When there is no beeping sound, then there is no refrigerant leak, or it is still doing detection. <p>If there is no leak, the fan will turn itself off automatically in a few minutes.</p> <p>Sometimes, the refrigerant leakage sensor detects by mistake substances other than refrigerant, such as insecticides or hairsprays (only for R32 refrigerant).</p>
<p>It makes a sound.</p> <p>Continuous beeping, and the operation light is flashing.</p>	<ul style="list-style-type: none"> ■ It is because the refrigerant leakage sensor started working. There is a risk of refrigerant leakage, so please ventilate the room, and contact your dealer (only for R32 refrigerant).
<p>It does not cool / warm up.</p> <p>When in cooling or heating mode, it switches to "Strong air flow" ventilation setting. (The operation light is flashing.)</p>	<ul style="list-style-type: none"> ■ It is because the refrigerant leakage sensor started working: <ul style="list-style-type: none"> • In case it is making a beeping sound, there is a risk of refrigerant leakage. Please ventilate the room and contact your dealer. • When there is no beeping sound, then there is no refrigerant leak, or it is still doing detection. <p>If there is no leak, it will return to the previous mode of operation automatically after a few minutes.</p> <p>Sometimes, the refrigerant leakage sensor detects by mistake substances other than refrigerant, such as insecticides or hairsprays (only for R32 refrigerant).</p>
<p>Other.</p> <p>The fan of indoor / outdoor unit is spinning when the unit is turned off.</p>	<ul style="list-style-type: none"> ■ When the fan of indoor unit is spinning and the operation light is flashing, it is because the refrigerant leakage sensor started working: <ul style="list-style-type: none"> • In case it makes a beeping sound, there is a risk of refrigerant leakage. Please ventilate the room and contact your dealer. • When there is no beeping sound, then there is no refrigerant leak, or it is still doing detection. <p>If there is no leak, the fan will stop automatically in a few minutes.</p> <p>Sometimes, the refrigerant sensor detects by mistake substances other than refrigerant, such as insecticides or hairsprays (only for R32 refrigerant).</p>
<p>Other.</p> <p>Fault diagnosis by remote controller show the code A0 on the display of remote controller.</p>	<ul style="list-style-type: none"> ■ Is it making beeping sound? <ul style="list-style-type: none"> • If it is making sound <p>There is a risk of refrigerant leakage. Please ventilate the room and contact your dealer.</p> • If it is not making sound <p>There is no refrigerant leakage, or it is still doing detection. Please wait a few minutes.</p> <p>Sometimes, the refrigerant sensor detects by mistake substances other than refrigerant, such as insecticides or hairsprays (only for R32 refrigerant).</p>

These cases are not troubles.

The following cases are not air conditioner troubles but have some reasons. You may just continue using it.

Case	Explanation
Operation does not start soon. <ul style="list-style-type: none"> • When ON/OFF button was pressed soon after operation was stopped. • When the mode was reselected. 	<ul style="list-style-type: none"> • This is to protect the air conditioner. You should wait for about 3 minutes.
Hot air does not flow out soon after the start of heating operation.	<ul style="list-style-type: none"> • The air conditioner is warming up. You should wait for 1 to 4 minutes. (The system is designed to start discharging air only after it has reached a certain temperature.)
The heating operation stops suddenly and a flowing sound is heard.	<ul style="list-style-type: none"> • The system is taking away the frost on the outdoor unit. You should wait for about 4 to 12 minutes.
The outdoor unit emits water or steam.	<ul style="list-style-type: none"> ■ In HEAT mode <ul style="list-style-type: none"> • The frost on the outdoor unit melts into water or steam when the air conditioner is in defrost operation. ■ In COOL or DRY mode <ul style="list-style-type: none"> • Moisture in the air condenses into water on the cool surface of outdoor unit piping and drips.
Mist comes out of the indoor unit.	<ul style="list-style-type: none"> ■ This happens when the air in the room is cooled into mist by the cold airflow during cooling operation. ■ This is because the air in the room is cooled by the heat exchanger and becomes mist during defrost operation.
The indoor unit gives out odour.	<ul style="list-style-type: none"> ■ This happens when smells of the room, furniture, or cigarettes are absorbed into the unit and discharged with the airflow. (If this happens, we recommend you to have the indoor unit washed by a technician. Consult the service shop where you bought the air conditioner.)
The outdoor fan rotates while the air conditioner is not in operation.	<ul style="list-style-type: none"> ■ After operation is stopped: <ul style="list-style-type: none"> • The outdoor fan continues rotating for another 60 seconds for system protection. ■ While the air conditioner is not in operation: <ul style="list-style-type: none"> • When the outdoor temperature is very high, the outdoor fan starts rotating for system protection.
The operation stopped suddenly. (OPERATION lamp is on.)	<ul style="list-style-type: none"> ■ For system protection, the air conditioner may stop operating on a sudden large voltage fluctuation. It automatically resumes operation in about 3 minutes.
No remote controller signals are displayed. The remote controller sensitivity is low. The display is low in contrast or blacked out. The display runs out of control.	<ul style="list-style-type: none"> • The batteries are dying and the remote controller is malfunctioning. Replace all the batteries with new size AAA alkaline batteries. For details, refer to "To set the batteries" of this manual. (page 9.) * If the reset button is provided, press the reset button after the batteries are replaced.
The ON/OFF TIMER does not operate according to the settings.	<ul style="list-style-type: none"> • Check if the ON/OFF TIMER and the WEEKLY TIMER are set to the same time. Change or disable the settings in the WEEKLY TIMER. (page 22.)

These cases are not troubles.

The following cases are not air conditioner troubles but have some reasons. You may just continue using it.

The air conditioner stops generating airflow during operation.

- Once the set temperature is reached, the airflow rate is reduced or operation stopped in order to avoid generating cool airflow (during heating) and in order to keep the humidity from rising (during cooling).
Operation will resume automatically when the indoor temperature rises or falls.

Call the service shop immediately.

 **WARNING**

- When an abnormality (such as a burning smell) occurs, stop operation and turn the breaker OFF. Continued operation in an abnormal condition may result in troubles, electric shocks or fire. Consult the service shop where you bought the air conditioner.
- Do not attempt to repair or modify the air conditioner by yourself. Incorrect work may result in electric shocks or fire. Consult the service shop where you bought the air conditioner.

If one of the following symptoms takes place, call the service shop immediately.

- The power cord is abnormally hot or damaged.
- An abnormal sound is heard during operation.
- The safety breaker, a fuse, or the earth leakage breaker cuts off the operation frequently.
- A switch or a button often fails to work properly.
- There is a burning smell.
- Water leaks from the indoor unit.



Turn the breaker OFF and call the service shop.

- After a power failure
The air conditioner automatically resumes operation in about 3 minutes. You should just wait for a while.
- Lightning
If lightning may strike the neighbouring area, stop operation and turn the breaker OFF for system protection.

Disposal requirements



Your product and the batteries supplied with the controller are marked with this symbol. This symbol means that electrical and electronic products and batteries shall not be mixed with unsorted household waste. For batteries, a chemical symbol can be printed beneath the symbol. This chemical symbol means that the battery contains a heavy metal above a certain concentration. Possible chemical symbols are:

■ Pb: lead (>0.004%)

Do not try to dismantle the system yourself: the dismantling of the product, treatment of the refrigerant, of oil and of other parts must be done by a qualified installer in accordance with relevant local and national legislation. Units and waste batteries must be treated at a specialized treatment facility for re-use, recycling and recovery. By ensuring correct disposal, you will help to prevent potential negative consequences for the environment and human health. Please contact the installer or local authority for more information.

We recommend periodical maintenance.

In certain operating conditions, the inside of the air conditioner may get foul after several seasons of use, resulting in poor performance. It is recommended to have periodical maintenance by a specialist aside from regular cleaning by the user. For specialist maintenance, contact the service shop where you bought the air conditioner. The maintenance cost must be born by the user.

Important information regarding the refrigerant used

This product contains fluorinated greenhouse gases. Do not vent gases into the atmosphere.

FVXM25/35/50FV1B	FVXS25/35/50FV1B
Refrigerant type: R32	Refrigerant type: R410A
GWP ⁽¹⁾ value: 675	GWP ⁽¹⁾ value: 2087.5

⁽¹⁾ GWP = global warming potential

Periodical inspections for refrigerant leaks may be required depending on European or local legislation. Please contact your local dealer for more information.



NOTICE regarding tCO₂eq

In Europe, the **greenhouse gas emissions** of the total refrigerant charge in the system (expressed as tonnes CO₂-equivalent) is used to determine the maintenance intervals. Follow the applicable legislation.

Formula to calculate the greenhouse gas emissions:

GWP value of the refrigerant × Total refrigerant charge [in kg] / 1000

Fault diagnosis.

FAULT DIAGNOSIS BY REMOTE CONTROLLER

In the ARC452A series, the temperature display sections on the main unit indicate corresponding codes.

1. When the **TIMER CANCEL** button is held down for 5 seconds, a “00” indication flashes on the temperature display section.

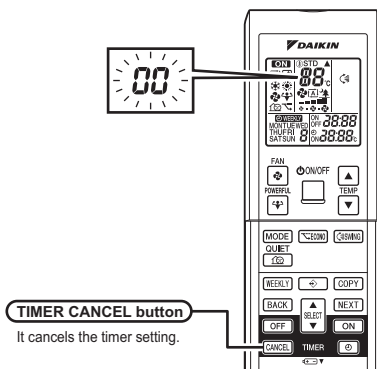

2. Press the **TIMER CANCEL** button repeatedly until a continuous beep is produced.

- The code indication changes as shown below, and notifies with a long beep.

	CODE	MEANING
SYSTEM	00	NORMAL
	UA	INDOOR-OUTDOOR UNIT COMBINATION FAULT
	U0	REFRIGERANT SHORTAGE
	U2	DROP VOLTAGE OR MAIN CIRCUIT OVERVOLTAGE
	U4	FAILURE OF TRANSMISSION (BETWEEN INDOOR UNIT AND OUTDOOR UNIT)
INDOOR UNIT	A0	DETECTION OF REFRIGERANT LEAK
	A1	INDOOR PCB DEFECTIVENESS
	A5	HIGH PRESSURE CONTROL OR FREEZE-UP PROTECTOR
	A6	FAN MOTOR FAULT
	C4	FAULTY HEAT EXCHANGER TEMPERATURE SENSOR
	C9	FAULTY SUCTION AIR TEMPERATURE SENSOR
	CH	ABNORMALITY OF REFRIGERANT LEAKAGE SENSOR
OUTDOOR UNIT	EA	COOLING-HEATING SWITCHING ERROR
	E1	CIRCUIT BOARD FAULT
	E5	OL STARTED
	E6	FAULTY COMPRESSOR START UP
	E7	DC FAN MOTOR FAULT
	E8	OVERCURRENT INPUT
	F3	HIGH TEMPERATURE DISCHARGE PIPE CONTROL
	F6	HIGH PRESSURE CONTROL (IN COOLING)
	H0	SENSOR FAULT
	H6	OPERATION HALT DUE TO FAULTY POSITION DETECTION SENSOR
	H8	DC CURRENT SENSOR FAULT
	H9	FAULTY SUCTION AIR TEMPERATURE SENSOR
	J3	FAULTY DISCHARGE PIPE TEMPERATURE SENSOR
	J6	FAULTY HEAT EXCHANGER TEMPERATURE SENSOR
	L3	ELECTRICAL PARTS HEAT FAULT
	L4	HIGH TEMPERATURE AT INVERTER CIRCUIT HEATSINK
L5	OUTPUT OVERCURRENT	
P4	FAULTY INVERTER CIRCUIT HEATSINK TEMPERATURE SENSOR	

NOTE

1. A short beep and two consecutive beeps indicate non-corresponding codes.
2. To cancel the code display, hold the **TIMER CANCEL** button down for 5 seconds. The code display also cancel itself if the button is not pressed for 1 minute.

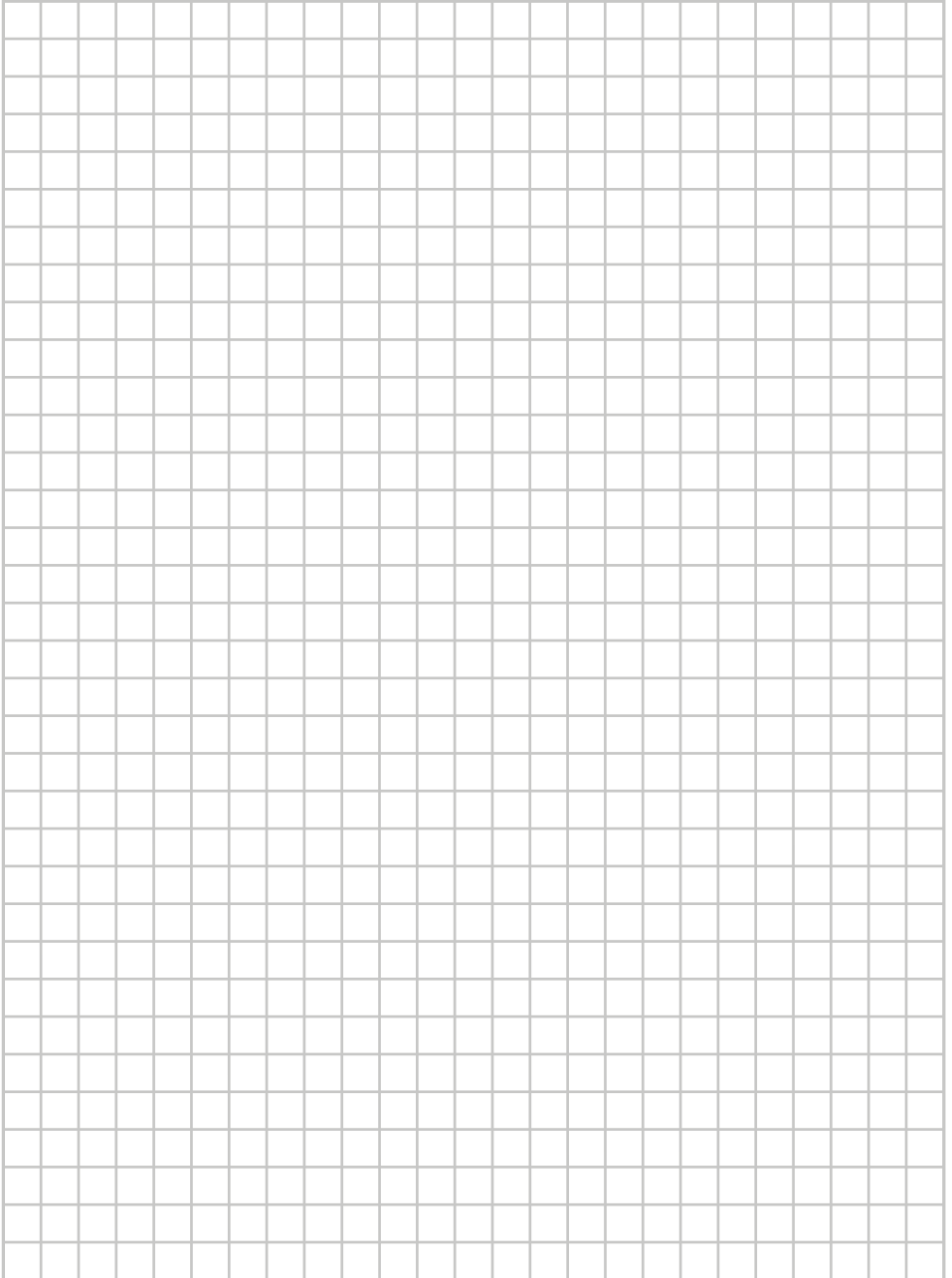

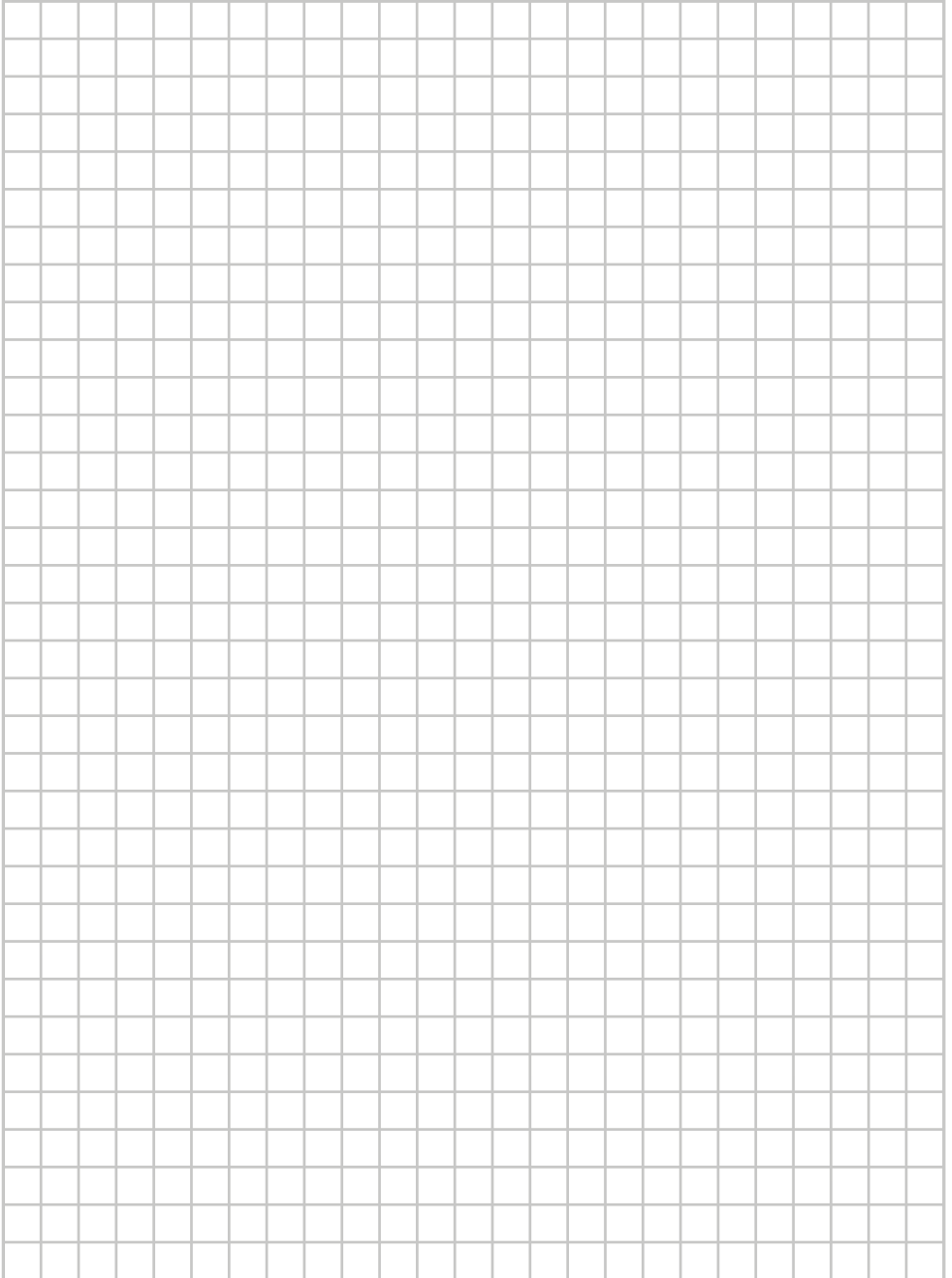

DAIKIN INDUSTRIES, LTD.

Head office:

Umeda Center Bldg., 2-4-12, Nakazaki-Nishi,
Kita-ku, Osaka, 530-8323 Japan

Tokyo office:

JR Shinagawa East Bldg., 2-18-1, Konan,
Minato-ku, Tokyo, 108-0075 Japan
<http://www.daikin.com>

DAIKIN EUROPE N.V.

Zandvoordestraat 300, B-8400 Oostende, Belgium



The two-dimensional bar code is
a manufacturing code.

3P477071-1A (1703)