

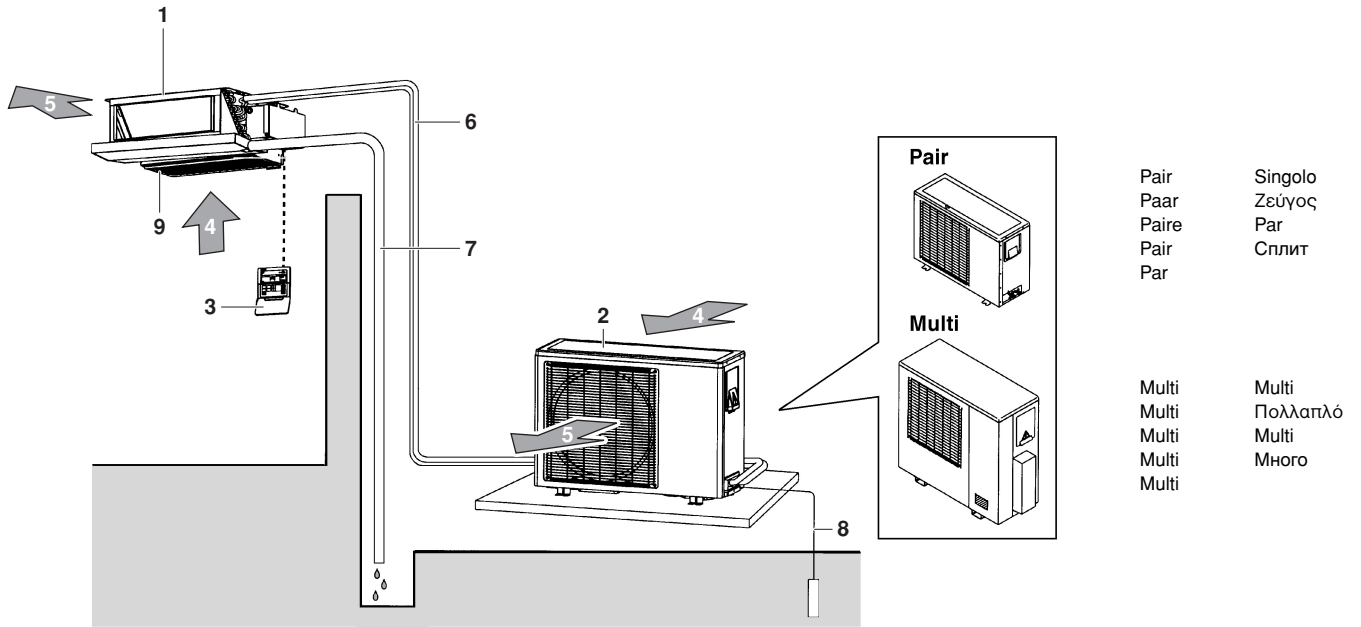

OPERATION MANUAL

Split series room air conditioners
Multi system room air conditioners



1

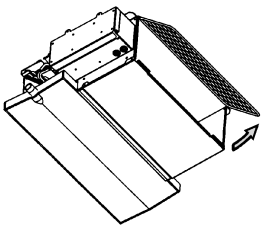

2a

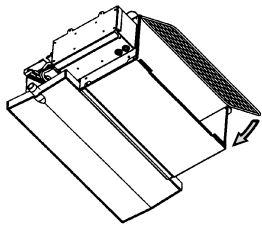

2b

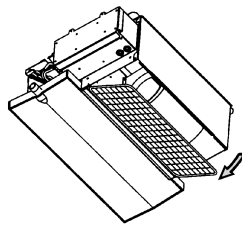

3a

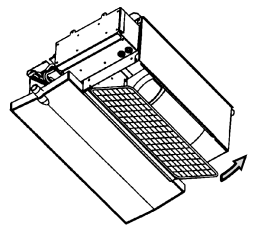

3b

NOTES



CONTENTS

	Page
What to do before operation	1
Operation range	1
Installation site	1
Operation procedure	2
Optimum operation	2
Following symptoms are not air conditioner troubles	2
Troubleshooting	3
Maintenance	3



Thank you for purchasing this Daikin air conditioner. Carefully read this operation manual before using the air conditioner. It will tell you how to use the unit properly and help you if any trouble occurs. After reading the manual, file it away for future reference.

WHAT TO DO BEFORE OPERATION

- This operation manual is for the following systems with standard control. Before initiating operation, contact your dealer for the operation that corresponds to your system.

NOTE



These units can be controlled by a remote controller. Refer to the manual of the remote controller for more information.

- If your installation has a customized control system, ask your Daikin dealer for the operation that corresponds to your system.

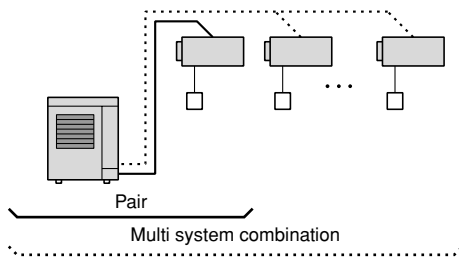

This heat pump system provides cooling, heating and automatic operation mode.

Names and functions of parts (See figure 1)

- 1 Indoor unit
- 2 Outdoor unit
- 3 Remote controller (optional)
- 4 Inlet air
- 5 Discharged air
- 6 Refrigerant piping, connection electric wire
- 7 Drain pipe
- 8 Ground wire
- 9 Suction air filter (optional)



- Never let the indoor unit and the remote controller get wet. It may cause an electric shock or a fire.
- Never use flammable spray such as hair spray, lacquer or paint near the unit. It may cause a fire.
- Never replace a fuse with that of a wrong ampere rating or other wires when the fuse blows out. Use of wire or copper wire may cause the unit to break down or cause a fire.
- Never touch the air outlet or the horizontal blades while the swing flap is in operation. Fingers may become caught or the unit may break down.
- Never insert objects such as sticks into the air inlet or outlet. It is dangerous for an object to touch the fan when it is turning at high speed.
- Never remove the fan guard of the outdoor unit. The rotating fan at high speed without the guard is very dangerous.
- Never inspect or service the unit by yourself. Ask a qualified service person to perform this work.

OPERATION RANGE

If temperature or humidity is beyond the following conditions, safety devices may work and the air conditioner may not operate, or sometimes, water may drop from the indoor unit.

	COOLING	HEATING
outdoor temperature	-10~46°CDB	-15~20°CWB
indoor temperature	14~28°CWB	10~30°CDB
indoor humidity	≤80% ^(*)	

^(*) to avoid condensation and water dripping out the unit

NOTE



Contact your dealer to know the correct operation range. It can change depending on the outdoor unit connected.

INSTALLATION SITE



- Never place anything under the indoor unit that you do not want to get wet. The unit may sweat when the humidity is over 80% or when the drain outlet is clogged.
- Never place other heating equipment directly beneath the indoor unit. Subject to deformation caused by heat.
- Do not place TV, radio, stereo, etc. within 1 meter from the indoor unit and remote controller. Doing so may cause interference in the picture or sound.

OPERATION PROCEDURE



- If a function that is not available is selected, the message NOT AVAILABLE will appear.
- To protect the unit, turn on the main power switch 6 hours before operation.
- If the main power supply is turned off during operation, operation will restart automatically after the power turns back on again.

Explanation of heating operation

Master-slave unit system (mode batting)

- System operation mode cool or heat is determined by the mode the master unit is in. When the master unit is in cool mode, respectively heat mode, the system can only operate in cooling, respectively heating, regardless of the thermostat setting.
- When the master unit is OFF, the system mode is determined by the unit which is switched on first.

NOTE The master-slave setting is decided upon and set during installation.



OPTIMUM OPERATION



Observe the following precautions to ensure the system operates properly.

- Adjust the air outlet properly and avoid direct air flow to room inhabitants.
- Adjust the room temperature properly for a comfortable environment. Avoid excessive heating or cooling.
- Prevent direct sunlight from entering a room during cooling operation by using curtains or blinds.
- Keep doors and windows closed. If the doors and windows remain open, air will flow out of your room causing a decrease in the cooling or heating effect.
- Never place objects near the air inlet or the air outlet of the unit. It may cause deterioration in the effect or stop in the operation.
- Turn off the main power supply switch to the unit when the unit is not used for longer periods of time. If the switch is on, it uses electricity. Before restarting the unit, turn on the main power supply switch 6 hours before operation for smooth running. (Refer to "Maintenance" on page 3)
- When the display shows "" (time to clean the air filter), ask a qualified service person to clean the filters. (Refer to "Maintenance" on page 3)

FOLLOWING SYMPTOMS ARE NOT AIR CONDITIONER TROUBLES

The system does not operate

- The system does not restart immediately after the ON/OFF button is pressed. If the OPERATION lamp lights, the system is in its normal operating condition. It does not restart immediately because one of its safety devices actuates to prevent the system from being overloaded. The system will turn on again automatically after three minutes.
- The system does not restart immediately when the TEMPERATURE SETTING button is returned to the former position after pushing. It does not restart immediately because one of its safety devices actuates to prevent the system from being overloaded. The system will turn on again automatically after three minutes.

- The system does not start when the display shows "" (EXTERNAL CONTROL ICON) and it flashes for a few seconds after pressing an operation button. This is because the system is controlled or disabled by another controller with a higher priority. When the display flashes, it indicates that the system cannot be controlled by this indoor unit.
- The system does not start when the display shows "". This indicates that the change-over of the installation is under centralized control assigned to another unit or to an optional cool/heat selector connected to the outdoor unit (= master remote controller). The indoor unit has to be restarted with the controller.
- The system does not start immediately after the power supply is turned on. Wait one minute until the micro computer is prepared for operation.

White mist comes out of a unit

- When humidity is high during cooling operation (in oily or dusty places) If the inside of an indoor unit is extremely contaminated, the temperature distribution inside a room becomes uneven. It is necessary to clean the inside of the indoor unit. Ask your Daikin dealer for details on cleaning the unit. This operation requires a qualified service person.
- When the system is changed over to HEATING OPERATION after DEFROST OPERATION. Moisture generated by DEFROST becomes steam and exits.

Noise of air conditioners

- A continuous low "hissing" sound is heard when the system is in COOLING or DEFROST OPERATION. This is the sound of refrigerant gas flowing through both indoor and outdoor units.
- A "hissing" sound which is heard at the start or immediately after the stop of operation or which is heard at the start or immediately after the stop of DEFROST OPERATION. This is the noise of refrigerant caused by flow stop and flow change.
- A continuous low "swishing" sound is heard when the system is in COOLING OPERATION or at a stop. The noise is heard when the drain pump is in operation.
- A "squeaking" sound is heard when the system is in operation or after the stop of operation. Expansion and contraction of plastic parts caused by temperature change makes this noise.

Dust from the units

- Dust may blow out from the unit after starting operation from long resting time. Dust absorbed by the unit blows out.

The units give off odors

- The unit absorbs the smell of rooms, furniture, cigarettes, etc., and then emits them.

The liquid crystal of the remote controller shows "BB"

- Happens immediately after the main power supply switch is turned on. Shows that the remote controller is in normal condition. Continues temporary.

TROUBLESHOOTING

If one of the following malfunctions occurs, take the measures shown below and contact your Daikin dealer.

The system must be repaired by a qualified service person.

- If a safety device such as a fuse, a breaker or an earth leakage breaker frequently actuates, or the ON/OFF switch does not properly work;
Measure: Turn off the main power switch
- If water leaks from unit;
Measure: Stop the operation.
- If the display "👁" (INSPECTION), "UNIT No.", and the OPERATION lamp flashes and the "MALFUNCTION CODE" appears.
Measure: Notify your Daikin dealer and inform him/her of the display.

If the system does not properly operate except for the above mentioned case, and none of the above mentioned malfunctions is evident, investigate the system according to the following procedures.

- If the system does not operate at all.
 - Check if there is a power failure.
Wait until power is restored. If power failure occurs during operation, the system automatically restarts immediately after the power supply recovers.
 - Check if the fuse has blown or breaker has been stripped.
Change the fuse or set the breaker.
- If the system stops operating after operation is complete.
 - Check if the air inlet or outlet of outdoor or indoor unit is blocked by obstacles.
Remove the obstacle and make it well-ventilated.
 - Check if the air filter is clogged.
Ask a qualified service person to clean the air filter.
- The system operates but it does not sufficiently cool or heat.
 - If the air inlet or outlet of the indoor or the outdoor unit is blocked with obstacles.
Remove the obstacle and make it well-ventilated.
 - If the air filter is clogged.
Ask a qualified service person to clean the air filter.
 - If the set temperature is not proper. (Refer to the manual of the remote controller)
 - If the FAN SPEED CONTROL button is set to LOW SPEED. (Refer to the manual of the remote controller)
 - If the air flow angle is not proper. (Refer to the manual of the remote controller)
 - If the doors or the windows are open. Shut doors or windows to prevent wind from coming in.
 - If direct sunlight enters the room (when cooling).
Use curtains or blinds.
 - When there are too many inhabitants in the room. Cooling effect decreases if heat gain of the room is too large.
 - If the heat source of the room is excessive (when cooling).
Cooling effect decreases if heat gain of the room is too large.

MAINTENANCE



- Only a qualified service person is allowed to perform maintenance.
- Before obtaining access to terminal devices, all power supply circuits must be interrupted.
- Do not use water or air of 50°C or higher for cleaning air filters and outside panels.
- When cleaning the heat exchanger, be sure to remove the switchbox, fan motor and drain pump. Water or detergent may deteriorate the insulation of electronic components and result in burn-out of these components.

How to clean the air filter

Clean the air filter when the display shows "👁" (TIME TO CLEAN AIR FILTER).

Increase the frequency of cleaning if the unit is installed in a room where the air is extremely contaminated.

(As a yardstick for yourself, consider cleaning the filter once a half year.)

If the dirt becomes impossible to clean, change the air filter. (Air filter for exchange is optional.)

NOTE



Do not operate the air conditioner without filters, this to avoid dust accumulation inside the unit.

1 Removing the air filter

- Rear suction (See figure 2a):

Pull the bottom side of the air filter backwards, over the 2 bends.

- Bottom suction (See figure 3a):

Pull the filter over the two bends situated at the backside of the unit.

2 Cleaning the air filter

Remove dust from the air filter using a vacuum cleaner and gently rinse them in cool water. Do not use detergent or hot water to avoid filter shrinking or deformation. After cleaning dry them in the shade.

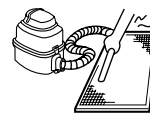

3 Replacing the air filter

- Rear suction (See figure 2b):

Hook the filter behind the flap situated at the top of the unit and push the other side gently over the 2 bends.

- Bottom suction (See figure 3b):

Hook the filter behind the flap situated at the middle of the unit and push the other side gently over the 2 bends.

Before a long stop period

- Operate the fan only for several hours to dry the inside of the indoor unit.
Set the remote controller in fan only operation mode.
Set the remote controller in cool operation mode and the temperature setting at 31°C.
- Disconnect the power supply by turning off the safety breaker (fuse or earth leak detector).
- Clean the air filters and set them back in place.

NOTES

