



DAIKIN ROOM AIR CONDITIONER

INSTALLATION MANUAL

R410A Split Series



MODELS

FTXS20K2V1B

FTXS25K2V1B

CTXS15K2V1B

CTXS35K2V1B

ATXS20K2V1B

ATXS25K2V1B

FTXS20K3V1B

FTXS25K3V1B

CTXS15K3V1B

CTXS35K3V1B

ATXS20K3V1B

ATXS25K3V1B

CE - DECLARATION-OF-COMFORMITY
 CE - KONFORMITÄTSPRÄKLARUNG
 CE - DECLARATION-DE-CONFORMITE
 CE - CONFORMITEITSVERKLARING

CE - DECLARACION-DE-CONFORMIDAD
 CE - DICHIARAZIONE-DI-CONFORMITA
 CE - ΔΗΛΩΣΗ ΣΥΜΜΟΡΦΩΣΗΣ
 CE - FÖRSÄKRAN-OM ÖVERENSÄMMELSE

CE - DECLARACÃO-DE-CONFORMIDADE
 CE - ЗАЯВЛЕНИЕ-О-СОТВЕТСТВИИ
 CE - OVERENSTEMMELSESKLARING
 CE - PROHLÁŠENÍ-O-SHOĐE

CE - IZJAVA-O-USKLABENOSTI
 CE - MEGFELELŐSÉG-NYILATKOZAT
 CE - DEKLARACJA-ZGODNOŚCI
 CE - DECLARAȚIE-DE-CONFORMITATE

CE - IZJAVA O SKLADNOSTI
 CE - VASTAVUSDEKLARACIJA
 CE - ДЕКЛАРАЦІЯ-ЗА-СЪОТВѢТСТВІЕ
 CE - UYGUNLUK-BEYANI

CE - ATTIKTIKES-DEKLARACIA
 CE - ATBILSĪBAS-DEKLARACIJA
 CE - VYHLÁŠENIE-ZHODY
 CE - UYGUNLUK-BEYANI

Daikin Industries Czech Republic s.r.o.

- 01 (en) declares under its sole responsibility that the air conditioning models to which this declaration relates;
- 02 (d) erklærer under eneansvar, at klimaanlægsmødelerne, som denne deklaration inderbær att;
- 11 (s) deklarerar i egeinansvar, att luftkonditioneringsmodellerna som betors av denna deklaration inderbär att;
- 12 (n) deklarerar i fullständig ansvar för att de luftkonditioneringsmodellerna som beröms av denna deklaration inderbär att;
- 13 (en) imolaiva yksimäärin omalla vastuullaan, että tämän ilmoituksen laittokattamat imasimittelitien mallit;
- 14 (cz) prohlašuje ve své plné odpovědnosti, že modely klimatizace k nimž se toto prohlášení vztahuje;
- 15 (hr) izjavljuje pod isključivo vlastitom odgovornošću da su modeli klima uređaja na koje se ova izjava odnosi;
- 16 (tr) teklifler felelşesliğe lütfetdiklerimdir, bu model iklim cihazlarının her birinin için bu beyanla ilişkilendirilmiştir.

- 09 (en) заявляет, исключительно под своею ответственностью, что модели кондиционеров воздуха, к которым относится настоящее заявление;
- 10 (en) erklærer under eneansvar, at klimaanlægsmødelerne, som denne deklaration inderbær att;
- 11 (s) deklarerar i egeinansvar, att luftkonditioneringsmodellerna som betors av denna deklaration inderbär att;
- 12 (n) deklarerar i fullständig ansvar för att de luftkonditioneringsmodellerna som beröms av denna deklaration inderbär att;
- 13 (en) imolaiva yksimäärin omalla vastuullaan, että tämän ilmoituksen laittokattamat imasimittelitien mallit;
- 14 (cz) prohlašuje ve své plné odpovědnosti, že modely klimatizace k nimž se toto prohlášení vztahuje;
- 15 (hr) izjavljuje pod isključivo vlastitom odgovornošću da su modeli klima uređaja na koje se ova izjava odnosi;
- 16 (tr) teklifler felelşesliğe lütfetdiklerimdir, bu model iklim cihazlarının her birinin için bu beyanla ilişkilendirilmiştir.

- 17 (en) declares under its sole responsibility that the air conditioning models to which this declaration relates;
- 18 (en) deklarerar i egeinansvar, att klimaanlægsmødelerne, som denne deklaration inderbær att;
- 19 (en) deklarerar i egeinansvar, att klimaanlægsmødelerna som betors av denna deklaration inderbär att;
- 20 (en) deklarerar i fullständig ansvar för att de luftkonditioneringsmodellerna som beröms av denna deklaration inderbär att;
- 21 (en) imolaiva yksimäärin omalla vastuullaan, että tämän ilmoituksen laittokattamat imasimittelitien mallit;
- 22 (cz) prohlašuje ve své plné odpovědnosti, že modely klimatizace k nimž se toto prohlášení vztahuje;
- 23 (hr) izjavljuje pod isključivo vlastitom odgovornošću da su modeli klima uređaja na koje se ova izjava odnosi;
- 24 (tr) teklifler felelşesliğe lütfetdiklerimdir, bu model iklim cihazlarının her birinin için bu beyanla ilişkilendirilmiştir.
- 25 (tr) lanamem kendii sorumluluğunda olnak üzere bu bildirişim için iklim modelinin aşağıdaki gibi olduğunu beyan eder.

FTXS20K3V1B, FTXS25K3V1B, FTXS35K3V1B, FTXS42K3V1B, FTXS50K3V1B, ATXS20K3V1B, ATXS25K3V1B, ATXS35K3V1B, ATXS50K3V1B, CTXS15K3V1B, CTXS35K3V1B,

- 01 are in conformity with the following standard(s) or other normative document(s), provided that these are used in accordance with our instructions:
- 02 (den) liggende Normen(Normen) oder einem anderen Normdokument oder -dokumenten entspricht/entsprechen, unter der Voraussetzung, dass sie gemäß unseren Anweisungen eingesetzt werden;
- 03 sont conformes à la(s) norme(s) ou autre(s) document(s) normatif(s), pour autant qu'ils soient utilisés conformément à nos instructions;
- 04 conform de volgend(e) norm(en) of één of meer andere bindende documenten zijn, op voorwaarde dat ze worden gebruikt overeenkomstig onze instructies;
- 05 están en conformidad con la(s) siguiente(s) norma(s) u otro(s) documento(s) normativo(s), siempre que sean utilizados de acuerdo con nuestras instrucciones;
- 06 sono conformi all(i) seguente(i) standard(i) o altro(i) documento(i) a carattere normativo, a patto che vengano usati in conformità alle nostre istruzioni;
- 07 éva egyezményes mérték előírás(ok) vagy egyéb irányadó dokumentum(ok)nak, ha azokat előírás szerinti használatukkal használják;
- 08 megfelelnek az alábbi szabvány(ok)nak vagy egyéb irányadó dokumentum(ok)nak, ha azokat előírás szerinti használatukkal használják;
- 09 соответствует вым(ым) следующим норм(ам) и иным документам нормативным, под warunkiem że używane są zgodnie z naszymi instrukcjami;
- 10 overholder følgende standard(er) eller andre relevante retningsværdende dokument(er), forudsat at disse anvendes i henhold til vores instrukser;
- 11 respektive utövning är utförd i överensstämmelse med och följer följande standard(er) eller andra normgivande dokument, under förutsättning att anvisning sies i överensstämmelse med våra instruktioner;
- 12 respektive utövr är i överensstämmelse med följande standard(er) eller andre normgivande dokument(er), under forutsætning av at disse brukes i henhold til våre instruksjoner;
- 13 nastavaur saureavaen standarden ja muuden ohjeellisten dokumenttien vaatimuksissa esiteltyiden, että niitä käytetään ohjeellamme mukaisesti;
- 14 za predpoklada, že jsou využívány v souladu s našimi pokyny, odpovídající následujícími normám nebo normativním dokumentům;
- 15 u sklađu sa slijedećim standardom(ima) ili drugim normativnim dokumentom(ima), uz uvjet da se on koriste u sklađu s našim uputama;
- 16 Megjyzés az alábbi szabvány(ok) vagy egyéb irányadó dokumentum(ok)nak, ha azokat előírás szerinti használatukkal használják;
- 17 spehľadaj vynmgi nasledujúcich norm i iných dokumentov normalizačných, pod warunkiem że używane są zgodnie z naszymi instrukcjami;
- 18 in urms prevedetilor;
- 19 ob upobljeneju dobij;
- 20 vsavarat növeked;
- 21 engeavakir orgazarena ha;
- 22 engeavakir orgazarena ha;
- 23 izanakis nuostai, patikimam;
- 24 dorzavajic ustanovien;
- 25 bunun kugulama uygun olarak;
- 06 Nota * as set out in <A> and judged positively by
- 07 Zpuzovium * wie in <A> aufgeföhrt und von positiv beurteilt
- 08 Nota * tel que défini dans <A> et évalué positivement par
- 09 Привешавие * как указано в <A> и оценено положительно
- 10 Bemerk * como se establece en <A> y es valorado positivamente por
- 06 Nota * as set out in <A> and judged positively by
- 07 Zpuzovium * wie in <A> aufgeföhrt und von positiv beurteilt
- 08 Nota * tel que défini dans <A> et évalué positivement par
- 09 Привешавие * как указано в <A> и оценено положительно
- 10 Bemerk * como se establece en <A> y es valorado positivamente por

- 08 esto en conformidad con el(s) siguiente(s) norma(s) u otro(s) documento(s) normativo(s), desde que estes sejan utilizados de acuerdo con las nossas instruções;
- 09 соответствует следующим стандартам или другим нормативным документам, при условии их использования согласно нашим инструкциям;
- 10 overholder følgende standard(er) eller andre relevante retningsværdende dokument(er), forudsat at disse anvendes i henhold til vores instrukser;
- 11 respektive utövning är utförd i överensstämmelse med och följer följande standard(er) eller andra normgivande dokument, under förutsättning att anvisning sies i överensstämmelse med våra instruktioner;
- 12 respektive utövr är i överensstämmelse med följande standard(er) eller andre normgivande dokument(er), under forutsætning av at disse brukes i henhold til våre instruksjoner;
- 13 nastavaur saureavaen standarden ja muuden ohjeellisten dokumenttien vaatimuksissa esiteltyiden, että niitä käytetään ohjeellamme mukaisesti;
- 14 za predpoklada, že jsou využívány v souladu s našimi pokyny, odpovídající následujícími normám nebo normativním dokumentům;
- 15 u sklađu sa slijedećim standardom(ima) ili drugim normativnim dokumentom(ima), uz uvjet da se on koriste u sklađu s našim uputama;
- 16 Megjyzés az alábbi szabvány(ok) vagy egyéb irányadó dokumentum(ok)nak, ha azokat előírás szerinti használatukkal használják;
- 17 spehľadaj vynmgi nasledujúcich norm i iných dokumentov normalizačných, pod warunkiem że używane są zgodnie z naszymi instrukcjami;
- 18 in urms prevedetilor;
- 19 ob upobljeneju dobij;
- 20 vsavarat növeked;
- 21 engeavakir orgazarena ha;
- 22 engeavakir orgazarena ha;
- 23 izanakis nuostai, patikimam;
- 24 dorzavajic ustanovien;
- 25 bunun kugulama uygun olarak;
- 06 Nota * as set out in <A> and judged positively by
- 07 Zpuzovium * wie in <A> aufgeföhrt und von positiv beurteilt
- 08 Nota * tel que défini dans <A> et évalué positivement par
- 09 Привешавие * как указано в <A> и оценено положительно
- 10 Bemerk * como se establece en <A> y es valorado positivamente por

- 19 (en) declares under its sole responsibility that the air conditioning models to which this declaration relates;
- 20 (en) deklarerar i egeinansvar, att klimaanlægsmødelerne, som denne deklaration inderbær att;
- 21 (en) deklarerar i egeinansvar, att klimaanlægsmødelerna som betors av denna deklaration inderbär att;
- 22 (en) deklarerar i fullständig ansvar för att de luftkonditioneringsmodellerna som beröms av denna deklaration inderbär att;
- 23 (en) imolaiva yksimäärin omalla vastuullaan, että tämän ilmoituksen laittokattamat imasimittelitien mallit;
- 24 (cz) prohlašuje ve své plné odpovědnosti, že modely klimatizace k nimž se toto prohlášení vztahuje;
- 25 (hr) izjavljuje pod isključivo vlastitom odgovornošću da su modeli klima uređaja na koje se ova izjava odnosi;
- 26 (tr) teklifler felelşesliğe lütfetdiklerimdir, bu model iklim cihazlarının her birinin için bu beyanla ilişkilendirilmiştir.
- 19 Dretkhev, med senere ændringer;
- 20 Direktivd koos muudatustega;
- 21 Директив, с резкие изменения;
- 22 Direktive koje su popravljene;
- 23 Direktivās un to papildinājums;
- 24 Snemnice, sa kojim se izmjenjeno;
- 25 Degšifimšis hatarielye Yoneimeliker;
- 10 Dretkhev, med senere ændringer;
- 11 Direktiv, med foretagne ændringer;
- 12 Direktiv, med foretagne ändringar;
- 13 Direktiveja, saledajsa kun ne ovat muuttuneita;
- 14 v plannim znenim;
- 15 Snjemnice, ka ko je izmijenjeno;
- 16 řányely(e)k is nuostaisak renkelveseset;
- 17 z pobznejšymi popravkami;
- 18 Dretkhev, cu amendamentele respective;
- 19 Dretkhev, med senere ændringer;
- 20 Direktivd koos muudatustega;
- 21 Директив, с резкие изменения;
- 22 Direktive koje su popravljene;
- 23 Direktivās un to papildinājums;
- 24 Snemnice, sa kojim se izmjenjeno;
- 25 Degšifimšis hatarielye Yoneimeliker;
- 10 Dretkhev, med senere ændringer;
- 11 Direktiv, med foretagne ændringer;
- 12 Direktiv, med foretagne ändringar;
- 13 Direktiveja, saledajsa kun ne ovat muuttuneita;
- 14 v plannim znenim;
- 15 Snjemnice, ka ko je izmijenjeno;
- 16 řányely(e)k is nuostaisak renkelveseset;
- 17 z pobznejšymi popravkami;
- 18 Dretkhev, cu amendamentele respective;
- 19 Dretkhev, med senere ændringer;
- 20 Direktivd koos muudatustega;
- 21 Директив, с резкие изменения;
- 22 Direktive koje su popravljene;
- 23 Direktivās un to papildinājums;
- 24 Snemnice, sa kojim se izmjenjeno;
- 25 Degšifimšis hatarielye Yoneimeliker;

<A>	DAIKIN.TCF.015Q2/10-2014
	DEKRA (NB0344)
<C>	74736-KRQ/EMC97-4957

- 21 Zabeleška * kako je iskorenjeno <A> u ovojeno normativno ot ozauno Cepmšikera <C>
- 22 Pasaba * kap nusajaja <A> it kap legiamia nuspreja paja Serifikat <C>
- 23 Pozimš * ka noršis <A> u abišis pozimšam vešimam sašaja ar serifikatu <C>
- 24 Pozimš * ako boba usajaja <A> u pozitivne zisete u silaje s ovedimšim <C>
- 25 Not * <A> da bešidij giba ve <C> Serifikama gibe arafinam duntu olarak degendindij gipi;
- 21 Zabeleška * kako je iskorenjeno <A> u ovojeno normativno ot ozauno Cepmšikera <C>
- 22 Pasaba * kap nusajaja <A> it kap legiamia nuspreja paja Serifikat <C>
- 23 Pozimš * ka noršis <A> u abišis pozimšam vešimam sašaja ar serifikatu <C>
- 24 Pozimš * ako boba usajaja <A> u pozitivne zisete u silaje s ovedimšim <C>
- 25 Not * <A> da bešidij giba ve <C> Serifikama gibe arafinam duntu olarak degendindij gipi;

- 13** DICz** on valetu laimam Teknisen asakij;
- 14** Spolekna DICz** ne opršeni le kompleksi souboru technicke konstrukce;
- 15** DICz** je ovšaven za zradu Databeke o tehnickij konstrukcij;
- 16** A DICz** jopsulit a miszaki konstrukciokis dokumentaci osszajalšasa;
- 17** DICz** na upovazenie do zberania i opracovavania dokumentacij konstrukcij;
- 18** DICz** este autorizati sa completeze Dosarul tehnic de constructie;
- 13** DICz** on valetu laimam Teknisen asakij;
- 14** Spolekna DICz** ne opršeni le kompleksi souboru technicke konstrukce;
- 15** DICz** je ovšaven za zradu Databeke o tehnickij konstrukcij;
- 16** A DICz** jopsulit a miszaki konstrukciokis dokumentaci osszajalšasa;
- 17** DICz** na upovazenie do zberania i opracovavania dokumentacij konstrukcij;
- 18** DICz** este autorizati sa completeze Dosarul tehnic de constructie;

- 07** H DICz** éva ésooosomjéjn va ovvúvra rov Texvúo fóoklo kotaxojú;
- 08** A DICz** este autorizata a compilar a documentație tehnica de fabrica;
- 09** Kompania DICz** ymoovokera osavvati Komitet tehnickoj dokumentacij;
- 10** DICz** er autoriseret til at udarbejde de tekniske konstruktionstata;
- 11** DICz** ar benytzigede att sammanställa den tekniska konstruktionsskissen;
- 12** DICz** har tillatelse til å kompilere den Tekniske konstruksjonsfilten;
- 07** H DICz** éva ésooosomjéjn va ovvúvra rov Texvúo fóoklo kotaxojú;
- 08** A DICz** este autorizata a compilar a documentație tehnica de fabrica;
- 09** Kompania DICz** ymoovokera osavvati Komitet tehnickoj dokumentacij;
- 10** DICz** er autoriseret til at udarbejde de tekniske konstruktionstata;
- 11** DICz** ar benytzigede att sammanställa den tekniska konstruktionsskissen;
- 12** DICz** har tillatelse til å kompilere den Tekniske konstruksjonsfilten;

- 13** DICz** on valetu laimam Teknisen asakij;
- 14** Spolekna DICz** ne opršeni le kompleksi souboru technicke konstrukce;
- 15** DICz** je ovšaven za zradu Databeke o tehnickij konstrukcij;
- 16** A DICz** jopsulit a miszaki konstrukciokis dokumentaci osszajalšasa;
- 17** DICz** na upovazenie do zberania i opracovavania dokumentacij konstrukcij;
- 18** DICz** este autorizati sa completeze Dosarul tehnic de constructie;
- 13** DICz** on valetu laimam Teknisen asakij;
- 14** Spolekna DICz** ne opršeni le kompleksi souboru technicke konstrukce;
- 15** DICz** je ovšaven za zradu Databeke o tehnickij konstrukcij;
- 16** A DICz** jopsulit a miszaki konstrukciokis dokumentaci osszajalšasa;
- 17** DICz** na upovazenie do zberania i opracovavania dokumentacij konstrukcij;
- 18** DICz** este autorizati sa completeze Dosarul tehnic de constructie;

- 19** DICz** je pooblaščen za sestavo datoteke s tehnično nazo.
- 20** DICz** on valetu laimam Teknisen asakij;
- 21** DICz** je ovšaven za zradu Databeke o tehnickij konstrukcij;
- 22** DICz** er autoriseret til at udarbejde de tekniske konstruktionstata;
- 23** DICz** ar benytzigede att sammanställa den tekniska konstruktionsskissen;
- 24** DICz** har tillatelse til å kompilere den Tekniske konstruksjonsfilten;
- 19** DICz** je pooblaščen za sestavo datoteke s tehnično nazo.
- 20** DICz** on valetu laimam Teknisen asakij;
- 21** DICz** je ovšaven za zradu Databeke o tehnickij konstrukcij;
- 22** DICz** er autoriseret til at udarbejde de tekniske konstruktionstata;
- 23** DICz** ar benytzigede att sammanställa den tekniska konstruktionsskissen;
- 24** DICz** har tillatelse til å kompilere den Tekniske konstruksjonsfilten;



Takayuki Fujii
 Managing Director
 Pilsen, 1st of Dec. 2014

DAIKIN INDUSTRIES CZECH REPUBLIC s.r.o.
 U Nové Hospody 1/1155, 301 00 Píseň Skvrňany,
 Czech Republic

CE - DECLARATION-OF-COMFORMITY
 CE - KONFORMITÄTSPRÄKLÄRUNG
 CE - DECLARATION-DE-CONFORMITE
 CE - KONFORMITEITSVERKLARING

Daikin Industries Czech Republic s.r.o.

- 01 (en) declares under its sole responsibility that the air conditioning models to which this declaration relates;
- 02 (d) erklärt auf seine alleinige Verantwortung daß die Modelle der Klimageräte für die diese Erklärung bestimmt ist;
- 03 (e) déclare sous sa seule responsabilité que les appareils d'air conditionné visés par la présente déclaration;
- 04 (nl) verklaart hierbij op eigen exclusieve verantwoordelijkheid dat de airconditioning units waarop deze verklaring betrekking heeft;
- 05 (e) declara bajo su única responsabilidad que los modelos de aire acondicionado a los cuales hace referencia la declaración;
- 06 (it) dichiara sotto sua responsabilità che i condizionatori modello a cui è riferita questa dichiarazione;
- 07 (tr) δηλώνει με αποκλειστική της ευθύνη ότι τα μοντέλα των κλιματιστικών συσκευών στα οποία αναφέρεται η παρούσα δήλωση;
- 08 (c) declara sob sua exclusiva responsabilidade que os modelos de ar condicionado a que esta declaração se refere.

ATXS20K2V1B, ATXS25K2V1B,

- 01 are in conformity with the following standard(s) or other normative document(s), provided that these are used in accordance with our instructions;
- 02 (den) følgende Normen (Normen) oder einen anderen Normdokument oder -dokumenten entsprechen, unter der Voraussetzung, daß sie gemäß unseren Anweisungen eingesetzt werden;
- 03 sont conformes à la(s) norme(s) ou autre(s) document(s) normatif(s), pour autant qu'ils soient utilisés conformément à nos instructions;
- 04 conform de volgende (normen) of één of meer andere bindende documenten zijn, op voorwaarde dat ze worden gebruikt overeenkomstig onze instructies;
- 05 están en conformidad con la(s) siguiente(s) norma(s) u otro(s) documento(s) normativo(s), siempre que sean utilizados de acuerdo con nuestras instrucciones;
- 06 sono conformi all(i) seguente(i) standard(i) o altro(i) documento(i) a carattere normativo, a patto che vengano usati in conformità alle nostre istruzioni;
- 07 είναι σύμφωνα με το(ί) ακόλουθό(ί) πρότυπο(ί) ή/και έγγραφο(ί) κανονιστικό, υπό την προϋπόθεση ότι χρησιμοποιούνται σύμφωνα με τις οδηγίες μας;

EN60335-2-40,

- 01 following the provisions of:
- 02 conformément aux stipulations des:
- 03 overeenkomstig de bepalingen van:
- 04 siguiendo las disposiciones de:
- 05 secondo le prescrizioni per:
- 07 με την προϋπόθεση των διατάξεων των:
- 08 в соответствии с положениями:
- 09 Note as set out in <A> and judged positively by
- 10 Hinweis wie in <A> aufgeführt und von positiv beurteilt
- 11 Remark as set out in <A> and judged positively by
- 12 Bemerk wie in <A> aufgeführt und von positiv beurteilt
- 13 Remark as set out in <A> and judged positively by
- 14 Bemerk as set out in <A> and judged positively by
- 15 Remark as set out in <A> and judged positively by
- 16 Remark as set out in <A> and judged positively by
- 17 Remark as set out in <A> and judged positively by
- 18 Remark as set out in <A> and judged positively by

- 19 ob upotrebljavaju dobili;
- 20 vstavljati navedle;
- 21 označevati uporabne na;
- 22 laikantis nuostai, patikimai;
- 23 teverojati pravilno, kas noteiktas;
- 24 oržabaivaju ustanovljeni;
- 25 bunun kullalanna uytun orakr;
- 16 Megjuzve * a) <A> alapján, a) igazolta a megjelölt
- 17 Uwaga * zgodnie z dokumentacją <A> pozytywnie opinił i Swiadectwem <C>
- 18 Noia * asa cum este stabilit in <A> si arecizat pozitiv in in conformitate cu Certificatul <C>
- 19 Opomba * kol je določeno v <A> v pozitivni zbirni v skladu s certifikatom <C>
- 20 Mirkus * naku je zloženo v <A> pozitivno ocijeno od strane prema Certificatu <C>
- 21 Zabeleška * kato je iskoreneno <A> v oceneno porokozhno ot oznakovo Serifikata <C>
- 22 Pastaba * kap nusaytija <A> ir kap legiamai nuspreta pagal Serifikat <C>
- 23 Pastabas * ká norádis <A> ir atibisoti pozityvam vėjiamam suskaičiavimui serifikatu <C>
- 24 Pastabai * ako boba ustatyti v <A> v pozityvine ziberte v silaube s ovredzinim <C>
- 25 Not * <A> da behtidigi gubi ve <C> Serifikama gube arafinad duntū orakr degerindigi gubi.

- 07** HDICZ*** είναι εξουσιοδοτημένη να συντάξει τον Έγγραφο Ολοκλήρωσης;
- 08** ADICZ*** está autorizada a compilar a documentación técnica de fábrica.
- 09** Компания DIZC*** уполномочена составлять Техническую документацию.
- 10** DIZC*** er autoriseret til at udarbejde de tekniske konstruktionsdata.
- 11** DIZC*** är bemyndigade att sammanställa den tekniska konstruktionsfilen.
- 12** DIZC*** har tillatelse til å kompilere den Tekniske konstruktionsfilen.

***DIZC = Daikin Industries Czech Republic s.r.o.

CE - ERKLÄRUNG OM-SAMSVAR
 CE - ILMOITUS-YHDENMUKAISUDESTA
 CE - DEKLARACJA-ZGODNOŚCI
 CE - DECLARATIE-DE-CONFORMITATE

- 09 (en) заявляет, исключительно под свою ответственность, что модели кондиционера воздуха, к которым относится настоящее заявление;
- 10 (d) erklærer under ensansvar, at klimaanlægsmodellerne, som denne deklaration vedrører;
- 11 (s) deklarerar i egenansvar, att luftkonditioneringsmodellerna som betörs av denna deklaration innebär att;
- 12 (n) erklærer et fuldstændigt ansvar for at de luftkonditioneringsmodeller som berøres af denne deklaration, inneharer at;
- 13 (nl) imrolijk verklaart onder eigen aansprakelijkheid, dat de modellen van airconditioningapparaten waarnaar deze verklaring betrekking heeft;
- 14 (e) prohlašuje ve své plné odpovědnosti, že modely klimatizace, k nimž se toto prohlášení vztahuje;
- 15 (tr) ifade eder ki bu ifadeyi yalnızca sorumluluğunda ve bu modelin klima üretilme ve dağıtımına ilişkin olarak yapılmıştır;
- 16 (c) teijās atbildes par šīs deklarācijas saturu, ņemot vērā, ka šīs deklarācijas saturā minētie modeļi ir paredzēti izstrādāt saskaņā ar šīs deklarācijas saturā minētajiem standartiem un citiem normatīvajiem dokumentiem.

- 08 estão em conformidade com a(s) seguinte(s) norma(s) ou outro(s) documento(s) normativo(s), desde que estes sejam utilizados de acordo com as nossas instruções;
- 09 соответствуют следующим стандартам или другим нормативным документам, при условии их использования согласно нашим инструкциям;
- 10 overholder følgende standard(er) eller andre relevante dokument(er), forudsat at disse anvendes i henhold til vores instrukser;
- 11 respektive utövning är utförd i överensstämmelse med och följer följande standard(er) eller andra normgivande dokument, under förutsättning att användning sker i överensstämmelse med våra instruktioner;
- 12 respektive użyty w/i overensstemmelse med følgende standard(er) eller andre normgivende dokument(er), under forudsætning af at disse bruges i henhold til våre instruksjoner;
- 13 nastava, searavaen standardien ja muiden ohjeellisten dokumenttien vaatimukissa edellytäten, että niitä käytetään ohjeiden mukaisesti;
- 14 za preopkladu, že jsou využívány v souladu s našimi pokyny, odpovídají následujícím normám nebo normativním dokumentům;
- 15 v skladu sa sledjícím standardom(i) ali drugim normativnim dokumentom(i), za uvjet da se on koriste u skladu s našim uputama;

**Machinery 2006/42/EC **
 Low Voltage 2006/95/EC**

- 01 Directives, as amended;
- 02 Direktiven, gemäß Änderung;
- 03 Directives, telles que modifiées;
- 04 Richtlijnen, zoals gewijzigd;
- 05 Directivas, según lo enmendado;
- 06 Direktive, come da modifica;
- 07 Одръжлив, омику ёвову "потомнофџи";
- 08 Directivas, conforme alteraçães em;
- 09 Директивне, со всеми поправками;
- 10 Direktivet, med senere ændringer;
- 11 Direktiv, med forretning ændring;
- 12 Direktiv, med forsatte ændringer;
- 13 Direktiveja, selaisina kuin ne ovat muuttuneita;
- 14 v platnini zneni;
- 15 Snijemica, kako je izmijenjeno;
- 16 řaznyje (ek) is nosidiljak revnikelzešes;
- 17 z pobznejšiny popravkami;
- 18 Direktivelor, cu amendamentele respective;
- 19 Direktivet, med senere ændringer;
- 20 Direktiv, med forretning ændring;
- 21 Директивне, с ревије измененија;
- 22 Direktiveja, selaisina kuin ne ovat muuttuneita;
- 23 Direktivas, según lo enmendado;
- 24 Snijemica, kako je izmijenjeno;
- 25 Degštinimš haterenje Yoneimeliker;

- 21 Zabeleška * kato je iskoreneno <A> v oceneno porokozhno ot oznakovo Serifikata <C>
- 22 Pastaba * kap nusaytija <A> ir kap legiamai nuspreta pagal Serifikat <C>
- 23 Pastabas * ká norádis <A> ir atibisoti pozityvam vėjiamam suskaičiavimui serifikatu <C>
- 24 Pastabai * ako boba ustatyti v <A> v pozityvine ziberte v silaube s ovredzinim <C>
- 25 Not * <A> da behtidigi gubi ve <C> Serifikama gube arafinad duntū orakr degerindigi gubi.

- 13** DIZC*** on valtuutettu laatimaan Teknisen asiakirjan.
- 14** Společnost DIZC*** má oprávnění ke kompletní souboru technické konstrukce.
- 15** DIZC*** je ovlašten za izradu Databake o tehničkoj konstrukciji.
- 16** A DIZC*** jogsullat a mizsakl konstrukciós dokumentáció összeállítására.
- 17** DIZC*** má upovaznenie do zberania i opracovavania dokumentáci konštrukcijnej.
- 18** DIZC*** este autorizat să completeze Dosarul Tehnic de construcție.

CE - IZJAVA O SKLADNOSTI
 CE - VASTAVUŠDEKLARACIJA
 CE - ДЕКЛАРАЦІЯ-ЗА-ЗОТВЕТСТВІЕ
 CE - DECLARATIE-DE-CONFORMITATE

- 17 (nl) deklarie na värsna, lyvärsna odgovornostjo, že modelje klimatyzatorov, kloých dolozuju nimejsza deklaracija;
- 18 (en) declares under its sole responsibility that the air conditioning models to which this declaration relates;
- 19 (d) erklärt auf seine alleinige Verantwortung daß die Modelle der Klimageräte für die diese Erklärung bestimmt ist;
- 20 (e) déclare sous sa seule responsabilité que les appareils d'air conditionné visés par la présente déclaration;
- 21 (nl) verklaart hierbij op eigen exclusieve verantwoordelijkheid dat de airconditioning units waarop deze verklaring betrekking heeft;
- 22 (e) declara bajo su única responsabilidad que los modelos de aire acondicionado a los cuales hace referencia la declaración;
- 23 (it) dichiara sotto sua responsabilità che i condizionatori modello a cui è riferita questa dichiarazione;
- 24 (tr) δηλώνει με αποκλειστική της ευθύνη ότι τα μοντέλα των κλιματιστικών συσκευών στα οποία αναφέρεται η παρούσα δήλωση;
- 25 (c) declara sob sua exclusiva responsabilidade que os modelos de ar condicionado a que esta declaração se refere.

- 16 megjelölnek az alábbi szabvány (ok)ra vagy egyéb irányadó dokumentum(ok)ra, ha azokat előírás szerint használják;
- 17 spełniają wymogi następujących norm i innych dokumentów normalizacyjnych, pod warunkiem że używane są zgodnie z naszymi instrukcjami;
- 18 sunt în conformitate cu următorii (următoare) standard(e) sau alte (documente) normative, cu condiția ca acestea să fie utilizate în conformitate cu instrucțiunile noastre;
- 19 skladni z naslednjih standardov in drugih normativnih dokumentov, ki ne bi kasrajale v skladu z našimi navodili;
- 20 conform de volgende (normen) of één of meer andere bindende documenten zijn, op voorwaarde dat ze worden gebruikt overeenkomstig onze instructies;
- 21 соответствуют на следующие стандарты или другие нормативные документы, при условии, что с использованием нашего инструкций;
- 22 atlinka žemai nuotobius standartus (ra) kitus norminius dokumentus su sąlyga, kad yra naudojami pagal mūsų nurodymus;
- 23 tak je iedni atibisoti razdižja norđajunjen, atbiš sekojšem standardien citien normativnim dokumentiem;
- 24 su v zlože z naslednjimi (normami) ali drugim normativnim dokumentom(i), za predpkladu, že sa používajú v skladu s našimi navodmi;
- 25 bunun, ta matarizma gore kulanimas kosulija asgđajki standardar ve norm beifen bejelere uyumludur;

- 21 Zabeleška * kato je iskoreneno <A> v oceneno porokozhno ot oznakovo Serifikata <C>
- 22 Pastaba * kap nusaytija <A> ir kap legiamai nuspreta pagal Serifikat <C>
- 23 Pastabas * ká norádis <A> ir atibisoti pozityvam vėjiamam suskaičiavimui serifikatu <C>
- 24 Pastabai * ako boba ustatyti v <A> v pozityvine ziberte v silaube s ovredzinim <C>
- 25 Not * <A> da behtidigi gubi ve <C> Serifikama gube arafinad duntū orakr degerindigi gubi.

<A>	DAIKIN.TCF.01FP20/12-2013
	DEKRA (NB0344)
<C>	74736-KRQ/EMC97-4957



DAIKIN INDUSTRIES CZECH REPUBLIC s.r.o.

U Nové Hospody 1/1155, 301 00 Píseň Skvrňany,
 Czech Republic

Takayuki Fujii
 Managing Director
 Píseň, 2nd of Dec. 2013

(Handwritten signature)

CE - DECLARATION-OF-COMFORMITY
CE - KONFORMITÄTSEKHLÄRUNG
CE - DECLARATION-DE-CONFORMITE
CE - CONFORMITEITS/VERKLARING

CE - DECLARACION-DE-CONFORMIDAD
CE - DICHIARAZIONE-DI-CONFORMITA
CE - ΔΗΛΩΣΗ ΣΥΜΜΟΦΩΣΗΣ

CE - DECLARACÃO-DE-CONFORMIDADE
CE - ЗАРЯБЛЕННЕ-О-СОТВЕТСТВИИ
CE - ÖPFEYDELSESEKHLÄRUNG
CE - FÖRSÄKRAN-OM-ÖVERENSSTÄMMELSE

CE - ERKLÄRUNG OM-SÄMVISAR
CE - ILMUOTUS-YHDENMUKAISUDESTA
CE - DEKLARACJA-ZGODNOSCI
CE - DECLARAȚIE-DE-CONFORMITATE

CE - IZJAVA O USKLADNOSTI
CE - VASTAVUUSDEKLARAATIO
CE - DEKLARACIJA-3A-COBTBETCTBME
CE - УУУМУЛУЛУК-БИЛДИРИ

CE - IZJAVA O SKLADNOSTI
CE - VASTAVUUSDEKLARAATIO
CE - DEKLARACIJA-3A-COBTBETCTBME
CE - УУУМУЛУЛУК-БИЛДИРИ

CE - ATTIKTIES-DEKLARACIJA
CE - ATBILSTIBAS-DEKLARACIJA
CE - VYHLASENIE-ZHODY
CE - UYUMLULUK-BILDIRI

DAIKIN INDUSTRIES, LTD.

- 01 declares under its sole responsibility that the air conditioning models to which this declaration relates;
- 02 erklärt auf seine alleinige Verantwortung daß die Modelle der Klimaanlage für die diese Erklärung bestimmt ist;
- 03 déclare sous sa seule responsabilité que les appareils d'air conditionné visés par la présente déclaration ont été conçus et fabriqués conformément aux dispositions des règlements en vigueur et qu'ils sont conformes à la réglementation en vigueur;
- 04 verklaart hierbij op eigen exclusieve verantwoordelijkheid dat de airconditioning units waarop deze verklaring betrekking heeft;
- 05 declara bajo su única responsabilidad que los modelos de aire acondicionado a los cuales hace referencia la declaración;
- 06 dichiara sotto sua responsabilità che i condizionatori modello a cui è riferita questa dichiarazione;
- 07 δηλώνει με αποκλειστική της ευθύνη ότι τα μοντέλα των κλιματιστικών συσκευών στα οποία αναφέρεται η παρούσα δήλωση;
- 08 declara sob sua exclusiva responsabilidade que os modelos de ar condicionado a que esta declaração se refere;
- 09 заявляет, исключительной под своей ответственностью, что модели кондиционеров воздуха, к которым относится настоящая декларация;

FTXS20K2V1B, FTXS25K2V1B, CTXS15K2V1B, CTXS35K2V1B

- 01 are in conformity with the following standard(s) or other normative document(s), provided that these are used in accordance with our instructions;
- 02 eriden følgende Norm(en) eller anden anden Normdokument eller dokumenter tilsvarende, under der Voraussetzung, daß sie gemäß unseren Anweisungen eingesetzt werden;
- 03 sont conformes à la(s) norme(s) ou autre(s) document(s) normatif(s), pour autant qu'ils soient utilisés conformément à nos instructions;
- 04 conform de volgende norm(en) of één of meer andere bindende documenten zijn, op voorwaarde dat ze worden gebruikt overeenkomstig onze instructies;
- 05 están en conformidad con la(s) siguiente(s) norma(s) u otro(s) documento(s) normativo(s), siempre que sean utilizados de acuerdo con nuestras instrucciones;
- 06 sono conformi all(i) seguente(i) standard(i) o altro(i) documento(i) a carattere normativo, a patto che vengano usati in conformità alle nostre istruzioni;
- 07 είναι σύμφωνα με το(α) ακόλουθο(α) πρότυπο(α) ή άλλο(α) έγγραφο(α) κανονιστικό, υπό την προϋπόθεση ότι χρησιμοποιούνται σύμφωνα με τις οδηγίες μας;

- 01 Note * as set out in and judged positively by according to the Certificate .
- 02 Hinweis * wie in der aufgeführt und von positiv beurteilt gemäß Zertifikat .
- 03 Remarque * tel que défini dans et jugé positivement par conformément au Certificat .
- 04 Bemerk * zoals vermeld in en positief beoordeeld door overeenkomstig Certificat .
- 05 Nota * como se establece en y es valorado positivamente por de acuerdo con el Certificado .

- 10 erklärt er/klarar under enansvar, at klimaanlægsmodelerne, som denne erklæring vedrører;
- 11 deklarerar i egenskap av huvudsansvarig, att luftkonditioneringsmodellerna som berörs av denna deklARATION innehåller att:
- 12 erklærer tilføirendig ansvar for at de luftkonditioneringsmodeller som berøres av denne deklarasjon inneholder at:
- 13 erklærer yksinoanonta omalla vastuullaan, että tämän ilmoituksen tarkoituksena on ilmoittaa ilmasiöimälaitteiden mallit:
- 14 prohlásuje ve své plné odpovědnosti, že modely klimatizace, k nimž se tato prohlášení vztahuje;
- 15 izjavlja pod isključivo vlastitom odgovornosću da su modeli klima uređaja na koje se ova izjava odnosi;
- 16 lejes felelősségei tudatában kijelenti, hogy a klímaberendezés modellek, melyekre e nyilatkozás vonatkozik;
- 17 deklaruje na własną odpowiedzialność, że modele klimatyzatorów, których dotyczy niniejsza deklaracja;
- 18 deklará pe proprie răspundere că aparatele de aer condiționat la care se referă această declarație;

- 08 estão em conformidade com a(s) seguinte(s) norma(s) ou outro(s) documento(s) normativo(s), desde que estes sejam utilizados de acordo com as nossas instruções;
- 09 соответствую стандарту или другим нормативным документам, при условии их использования согласно нашим инструкциям;
- 10 overholder følgende standard(er) eller andrelandre retningsreguleringe dokument(er), boudsat at disse anvendes i henhold til vore instrukser;
- 11 respektive utningning är utförd i överensstämmelse med och följer följande standard(er) eller andra normgivande dokument, under förutsättning att användning sker i överensstämmelse med våra instruktioner;
- 12 respektive uslyer er i overensstemmelse med følgende standard(er) eller andre normgivende dokument(er), under forudsætning af at disse bruges i henhold til våre instruksjer;
- 13 vastaaat seuraavien standardien ja muiden ohjeellisten dokumenttien vaatimukset edellyttäen, että niitä käytetään ohjeidemme mukaisesti;
- 14 za předpokladu, že jsou využívány v souladu s našimi pokyny, odpovídají následujícím normám nebo normativním dokumentům;
- 15 v skladu sa sledjućem standardom(i)na) ili drugim normativnim dokumentom(i)na), uz uvjet da se oni koriste u skladu s našim uputama;

EN60335-2-40,

- 01 following the provisions of:
- 02 gemäß den Vorschriften der:
- 03 conformément aux stipulations des:
- 04 overeenkomstig de bepalingen van:
- 05 siguiendo las disposiciones de:
- 06 secondo le prescrizioni per:
- 07 με τηρών τη(α) διατάξεων των:
- 08 de acordo com o previsto em:
- 09 в соответствии с положениями:

- 19 ob upoštevanju določb:
- 20 vastavalt nõudele:
- 21 omadavalt kätäytöre he:
- 22 takanis nustelet, pakelaime;
- 23 envejoji prasloise, kas notakise;
- 24 orizavajuo islanovnia;
- 25 bunum kosullanna uygun olarak:

- 19 z vso odgovornostjo izjavlja, da so modeli klimatiskih naprav, na katere se izjava nanaša;
- 20 kinnitab oma täieliku vastutuse, et käsitletava deklaratsioon on alla kuuluvad klimaseadmete mudelid;
- 21 deklarerar på eget otvorenност, et modellene klimatiske instrastama, za korige se omnas i denne deklarasjon, er konstruert og produsert i samsvar med de tekniske kravene som er fastslått i de relevante standardene, og at disse er i samsvar med de relevante standarder og andre bindende dokumenter, under forutsætning at de brukes i samsvar med våre instruksjoner;
- 22 viskija savo atsakomybe slekiba, kad oro kondicionavimo prietaisų modeliai, kuriems yra taikoma ši deklaracija;
- 23 ar plinu atbildību apliecinā, ka tāk uzskaitito modeļu gaisa kondicionēji, uz kuriem attiecas šī deklarācija;
- 24 vyhlásije na vlastní zodpovednost', že tieto klimatizačné modely, na ktoré sa vzťahuje táto vyhlásenie;
- 25 lamamen kendi sorumluluğunda olmak üzere bu bildirimini ilgili ölçüde, klima modellerinin aşağıdaki gibi olduğunu beyan eder;

- 16 megfelelően az alábbi szabvány(ok)nak vagy egyéb, irányadó dokumentum(ok)nak, ha azokat előírás szerint használják;
- 17 спелнеја, вымоги насапојујојч норм i мнуч документов нормализујујојч, под ваукаием же узвучене сај згодне з нашоју инструкцијом;
- 18 sunt in conformitate cu urmatorul (urmatoarele) standard(e) sau alte (documente) normative), cu condiția ca acestea să fie utilizate in conformitate cu instructiunile noastre;
- 19 skladu z nasledujimi standardi in drugim normativi, pod pogojem, da se uporabijo v skladu z našimi navodili;
- 20 v samsvaru s jämsstille standard(i)ega vil teiste normaliseate dokumentidega, kui need kasutatakse vastavalt meie juhenditele;
- 21 conformitatea cu standarde sau cu alte documente normative, при условии, что они используются в соответствии с нашими инструкциями;
- 22 atinja zemiau nurodytus standartus ir (arba) kitus norminius dokumentus su sąlyga, kad yra naudojami pagal mūsų nurodymus;
- 23 tad, je lotici atbilstis izabja norādījumiem, atbilst sekojošiem standartiem un citiem normatīviem dokumentiem;
- 24 su v zboru s nasledovnjm(i) normom(i) alebo jnym(i) normatívnym(i) dokumentom(i)ami), za predpokladu, že sa používajú v súlade s našimi návodmi;
- 25 üruin, talimatlarımza göre kullanılması koşuluyla aşağıdaki standartlar ve norm belgileri beğenilebilir uyumludur;

- 01 Direktiver, as amended;
- 02 Direktiven, gemäß Änderung;
- 03 Direktiven, telles que modifiées;
- 04 Richtlijnen, zoals gewijzigd;
- 05 Directivas, según lo emendado;
- 06 Direttive, come da emendata;
- 07 Önyönlük, övük övün pirononibeli;
- 08 Direktivas, conforme alterațiile em;
- 09 Директиве со весими поправакани;

- 21 Zbornicka * kartu e koroveno s i celeno porokovano ot crnacno
- 22 Pestaba * zgonnie z dokumentacij pozitivna optija i Svedactvom .
- 23 Piznemes * ka noradits un atbilstoš pozitīvajam vērtīmajam sistēmai ar sertifikātu .
- 24 Poznamka * ako bilo ovedeno v a pozitivno zistenie v skladu s ovedenim .
- 25 Not * ta beintilgiti gubi ve Sertifikasna gōre izracinam omlu otak degerlendirilgigi gubi.



Shinri Sada

Manager Quality Control Department

2011.10.26

DAIKIN INDUSTRIES, LTD.
Umeda Center Bldg., 2-4-12, Nakazaki-Nishi,
Kita-ku, Osaka, 530-8323 Japan

CE - DECLARATION-OF-COMFORMITY
CE - KONFORMITÄTSEKHLARUNG
CE - DICHIARAZIONE-DI-CONFORMITA
CE - ΔΗΛΩΣΗ ΣΥΜΜΟΡΦΩΣΗΣ
CE - CONFORMITEITSVERKLARING

CE - DECLARACION-DE-CONFORMIDAD
CE - ЗАЯВЛЕНИЕ-О-СОТВЕТСТВИИ
CE - ÖPFFYRDELSEERKLÄRING
CE - FÖRSÄKRAN-OM-ÖVERENSTÄMMELSE

CE - DECLARACÃO-DE-CONFORMIDADE
CE - ЗАЯВЛЕНИЕ-О-СОТВЕТСТВИИ
CE - ÖPFFYRDELSEERKLÄRING
CE - FÖRSÄKRAN-OM-ÖVERENSTÄMMELSE

CE - IZJAVA-O-USKLABENOSTI
CE - MEGFELELŐSÉG-NYILATKOZAT
CE - DEKLARACJA-ZGODNOSCI
CE - DECLARATIE-DE-CONFORMITATE

CE - IZJAVA O SKLADNOSTI
CE - VASTAVUSDEKLARACIJA
CE - VYHLÁŠENIE-ZHODY
CE - UYUMULULUK-BILDIRISI

CE - ATTIKTIKIES-DEKLARACIA
CE - ATTBILSTÍBAS-DEKLARACIJA
CE - VYHLÁŠENIE-ZHODY
CE - UYUMULULUK-BILDIRISI

Daikin Industries, Ltd.

01 (6B) declares under its sole responsibility that the equipment to which this declaration relates:

02 (D) erklärt auf seine alleinige Verantwortung, dass diese Ausrüstung, für die diese Erklärung bestimmt ist:

03 (E) déclare sous sa seule responsabilité que l'équipement visé par la présente déclaration:

04 (NL) verklaart hierbij op eigen excusieve verantwoordelijkheid dat de apparatuur waarop deze verklaring betrekking heeft:

05 (E) declara bajo su única responsabilidad que el equipo al que hace referencia la declaración:

06 (I) dichiara sotto la propria responsabilità che gli apparecchi a cui è riferita questa dichiarazione:

07 (GR) δηλώνει με αποκλειστική της ευθύνη ότι ο εξοπλισμός, στον οποίο αναφέρεται η παρούσα δήλωση:

08 (F) déclare sous sa seule responsabilité que ce équipement, à qui cette déclaration se réfère:

09 (RU) заявляет, исключительно под своею ответственностью, что оборудование, к которому относится настоящее заявление:

FTXS20K2V1B, FTXS25K2V1B, CTXS15K2V1B, CTXS35K2V1B

10 (GR) erklærer som eneansvarlig, at udstyret, som er omfattet af denne erklæring:

11 (S) deklarerar i egenansvar, att utrustningen som berörs av denna deklARATION innehåller åt:

12 (N) erklærer et fuldstændigt ansvar for det udstyr, som berøres af denne deklARATION. Indehæverer at:

13 (NB) imolitat yksnomaan omalla vastuullaan, että tämän ilmoituksen tarkoituksena on:

14 (CZ) prohlásuje ve své plné odpovědnosti, že zařízení, k němuž se tato prohlášení vztahuje:

15 (HR) izjavljuje pod isključivo vlastitom odgovornošću da oprema na koju se ova izjava odnosi:

16 (H) teljes felelősséggel tudatában kijelenti, hogy a bejelentésnek, melyre ez a nyilatkozat vonatkozik:

17 (PL) deklaruje na własną wyłączną odpowiedzialność, że urządzenie, których ta deklaracja dotyczy:

18 (RO) declară în proprie răspundere că echipamentele la care se referă această declarație:

19 (6D) z vsjo odgovornostjo izjavlja, da je oprema naprav, na katero se zjava nanaša:

20 (6E) knnitab oma täieliku vastutuse, et käesoleva deklaratsiooni alla kuuluv varustus:

21 (6S) deklariiraja ha ocoa orrooophoot, za oöooyapaiero, za koopro ce orhoer taaz devrapaurot:

22 (LT) visiška savo atsakomybę skelbia, kad įranga, kuriai taikoma ši deklaracija:

23 (LV) ar pīmu atbildību apliecinu, ka tālāk aprakstītais iekārtas, uz kurām attiecas šī deklarācija:

24 (SK) vyhlasuje na vlastnú zodpovednosť, že zariadenie, na ktoré sa vzťahuje toto vyhlásenie:

25 (TR) taamenen kendi sorumluluğunda olmak üzere bu bildirimni ilgili öğedüj donanımın aşşğıdaki gibi olduğunu beyan eder:

01 is in conformity with the provisions of:

02 est conforme aux prescriptions de:

03 conform is met de bepalingen van:

04 cumple las disposiciones según:

05 e conforme alle disposizioni di:

06 provided that the equipment is used in accordance with our instructions.

07 vorausgesetzt, dass die Ausrüstung gemäß der von uns gegebenen Instruktionen verwendet wird.

08 pour autant que l'équipement soit utilisé conformément à nos instructions.

09 op voorwaarde dat de apparatuur overeenkomstig onze instructies wordt gebruikt.

10 siempre que el equipo se utilice de conformidad con nuestras instrucciones.

11 a patto che l'apparecchio venga usato in conformità alle nostre istruzioni.

01 Daikin Europe N.V. is authorised to compile the Technical Construction File.

02 Daikin Europe N.V. hat die Berechtigung die Technische Konstruktionsakte zusammenzustellen.

03 Daikin Europe N.V. est autorisé à compiler le Dossier de Construction Technique.

04 Daikin Europe N.V. is bevoegd om het Technisch Constructiebestel samen te stellen.

05 Daikin Europe N.V. está autorizado a compilar el Archivo de Construcción Técnica.

06 Daikin Europe N.V. è autorizzata a redigere il File Tecnico di Costruzione.

13 vastaalet seuravaia vaatimuksia:

14 est conforme aux prescriptions de:

15 ispuhava slijedele:

16 megéle a követési írásmű dokumentum(oka)t:

17 pozostaje w zgodności z postanowieniami:

18 este în conformitate cu prevederile:

19 je usklašen z dobčiami:

20 on vastavuses järgmistele nõudele:

21 соответствует следующим требованиям:

22 atitinka nustatytus reikalavimus.

23 atitisi prasibam, kas noteikats:

24 je v zhode s ustanovieniami:

25 hókümeti le uyumludur:

01 Directive (valid from 29/12/2009).

02 Richtlijn (geldig vanaf 29/12/2009).

03 Directiva (válida a partir del 29/12/2009).

04 Ríchlín (geldig vanaf 29/12/2009).

05 Directiva (válida desde 29/12/2009).

06 Directiva (valabla din 29/12/2009).

07 Öbnyie (vojsie ot 29/12/2009).

08 Direktiva (em vigor desde 29/12/2009).

09 Direktiva (vrijed od 29/12/2009).

10 Direktiv (gældende fra 29/12/2009).

11 Direktiv (giltigt från 29/12/2009).

12 Direktiv (gyldigt fra 29/12/2009).

13 Direktivi (võimassa 29.12.2009 alkaeni).

14 Sméncia (vrijed od 29/12/2009).

15 Direktiva (vrijed od 29/12/2009).

16 írányelv (hatályba lépés: 2009.12.29.).

17 Direktiva (vazna od dnja 29/12/2009).

18 Direktiva (valabla din 29/12/2009).

19 Direktiva (v veljav od 29.12.2009).

20 Direktiv (kenhv atales 29/12/2009).

21 Direktiva (apriuvana ot 29/12/2009).

22 Direktiva (patloja nuo 2009.12.29).

23 Direktiva (spéka no 29/12/2009).

24 Sméncia (patlana od 29.12.2009).

25 Direktiv (geperifik besjéngici 29/12/2009).

19 pod pogojem, da se oprema uporablja v skladu z našimi navodili.

20 ku varustusi kasutatakse vastavelt meie juhendile.

21 при использоании, ce oöopyaiero ce varustaka a cоответствие с нашими инструкциями.

22 su satgja, kad įranga naudojama pagal pateiktas instrukcijas.

23 ar nosacījumi, ka eiekārtas tiek lietoats saskaņā ar mūsu instrukcijām.

24 za preopokleđu, že se zariadenie používa v súlade s našimi pokynmi.

25 ekpmanini taimitarmiz doğrullusunda kulanimats kosuluya.

13 edelyítélen, että láteístoa käytetään ohjeiden mukaisesti.

14 za preopokleđu, že zařizení je používáno v souladu s našimi pokyny.

15 da se oprema koristi u skladu s našim uputama.

16 ha a berendezést az előíráskínak megfelelően használják.

17 pod warunkiem eksploatacji urządzenia zgodnie z treścią instrukcji.

18 cu condiția ca echipamentul să fie utilizat în conformitate cu instrucțiunile noastre.

13 Daikin Europe N.V. on valuttetu laimaan Teknisen Asiakirjan.

14 Sooleinosi Daikin Europe N.V. má oprávnění ke kompilaci souboru technické konstrukce.

15 Daikin Europe N.V. je ohrášen za izradu Datoteke o tehničkoj konstrukciji.

16 A Daikin Europe N.V. jogosult a muszak konstrukciós dokumentáció összeállítására.

17 Daikin Europe N.V. má upovaznenie do zberania i opracovovania dokumentácie konštruktojnjej.

18 Daikin Europe N.V. este autorizat să compileze Dosarul Tehnic de construcție.

Daikin Europe N.V., Zandvoordestraat 300, B-8400 Oostende Belgium



Shinri Sada
Manager Quality Control Department

2011.10.26

DAIKIN INDUSTRIES, LTD.
Umeda Center Bldg., 2-4-12, Nakazaki-Nishi,
Kita-ku, Osaka, 530-8323 Japan

3SB65451-2

01 Addendum to instructions delivered with the equipment:

The English text is the original instruction. Other languages are translations of the original instructions.

02 Ergänzung zu den mit der Ausrüstung gelieferten Instruktionen:

Bei der englischen Textfassung geht es sich um das Original. Bei den Anleitungen in anderen Sprachen handelt es sich um Übersetzungen des Originals.

03 Addendum aux instructions fournies avec l'équipement:

Le texte anglais correspond aux instructions d'origine. Les autres langues sont les traductions des instructions d'origine.

04 Bijvoegsel voor bij de apparatuur geleverde instructies:

De Engelse tekst is de oorspronkelijke versie. Andere talen zijn vertalingen van de oorspronkelijke instructies.

05 Anexo a las instrucciones suministradas con el equipo:

El texto en inglés constituye las instrucciones originales. El resto de los idiomas son traducciones de las instrucciones originales.

06 Aggiunta alle istruzioni in dotazione con l'apparecchio:

Il testo in inglese corrisponde alle istruzioni originali. Le altre lingue sono traduzioni delle istruzioni originali.

07 Поповнення до інструкцій надані разом з обладнанням:

Тільки англійська мова є оригінальним текстом. Решта мов – це переклади оригінального тексту.

08 Adenda às instruções fornecidas com o equipamento:

As instruções foram redigidas originalmente em inglês. As versões noutras línguas são traduções da redacção original.

09 Дополнение к инструкциям, прилагаемым к оборудованию:

Оригиналом инструкции является текст на английском языке. Текст на других языках является переводом с оригинала.

10 Tillegg til veiledningen leveret sammen med dette utstyr:

Veiledningens originalspråk er engelsk. Andre språk er oversettelser av den originale veiledning.

11 Tillägg till instruktionserna som medföljer utrustningen:

Den engelska texten är originalinstruktionerna. Övriga språk är översättningar av originalinstruktionerna.

12 Tillegg til instruksjoner som følger med utstyret:

Den engelske teksten inneholder originalinstruksjonene. Andre språk er oversettelser av originalinstruksjonene.

13 Lisäys laitteiston mukana toimitettuihin ohjeisiin:

Englanninkielinen teksti on alkuperäinen ohje. Muut kielet ovat alkuperäisten ohjeiden käännöksiä.

14 Dodatki k poljnimu dodávaným k zařízením:

Originální návod je v angličtině. Ostatní jazyky jsou překladem originálního návodu.

15 Dodatki uputama isporučanim s opremom:

Engleski tekst je originalna uputa. Ostali jezici su prijevodi originalne upute.

16 Kiegészítés a berendezéshez mellékelt útmutatóhoz:

Az útmutató eredeti szövege az angol nyelvű szöveg. A többi nyelvű változat az útmutató eredeti szövegének a fordítása.

17 Uzpehnenie informacij odnošno instrukcij dostarczanih z urzadjenjem:

Originalna instrukcija opracovana v jeziku angleščini. Instrukcije v pozostajih jezikih so, tumačeniami instrukcij originalnej.

18 Anexa la instrucțiunile livrate cu echipamentul:

Textul în limba engleză este instrucțiunea originală. Celelalte limbi sunt traduceri ale instrucțiunilor originale.

19 Dodatek k navodilom, priložen opremi:

Izvorni jezik teh navodil je angleščina. Navodila v drugih jezikih so prevodi navodil v izvornem jeziku.

20 Lisa varustusega koos lamitud juhendite:

Inglisekeelne tekst on originaaljuhend. Teised keeled on originaaljuhendite tõlked.

21 Дополнение към инструкциите, предоставени с оборудването:

Текстът на английски език е оригиналната инструкция. Текстовете на останалите езици са преводи на оригиналните инструкции.

22 Přidáček pře instrukci, přistavtu su jřanãa:

Anglický textas yra originali instrukcija. Tekstai kitomis kalbomis yra šios instrukcijos originalo vertimas.

23 Papildinājums kopā ar iekārtām piegādātajām instrukcijām:

Originalā instrukcija ir teksts angļu valodā. Teksti pārējos valodās ir oriģinālo instrukciju tulkojumi.

24 Doplnok k poljnom dodávaným spolu so zařízením:

Originální návod je v angličtině. Ostatní jazyky su překlady originálního návodu.

25 Ekipman ile birlikte verilen talimatlara ek:

İngilizce metin asıl talimattır. Diğer diller asıl talimatlann çevirileridir.



Safety Precautions

- The precautions described herein are classified as WARNING and CAUTION. They both contain important information regarding safety. Be sure to observe all precautions without fail.
- Meaning of WARNING and CAUTION notices





 **WARNING.....Failure to follow these instructions properly may result in personal injury or loss of life.**



 **CAUTION.....Failure to observe these instructions properly may result in property damage or personal injury, which may be serious depending on the circumstances.**

- The safety marks shown in this manual have the following meanings:

 Be sure to follow the instructions.	 Be sure to establish an earth connection.	 Never attempt.
---	---	--

- After completing installation, conduct a trial operation to check for faults and explain to the customer how to operate the air conditioner and take care of it with the aid of the operation manual.
- The English text is the original instruction. Other languages are translations of the original instructions.

 WARNING	
<ul style="list-style-type: none"> • Ask your dealer or qualified personnel to carry out installation work. Do not attempt to install the air conditioner yourself. Improper installation may result in water leakage, electric shocks or fire. 	
<ul style="list-style-type: none"> • Install the air conditioner in accordance with the instructions in this installation manual. Improper installation may result in water leakage, electric shocks or fire. 	
<ul style="list-style-type: none"> • Be sure to use only the specified accessories and parts for installation work. Failure to use the specified parts may result in the unit falling, water leakage, electric shocks or fire. 	
<ul style="list-style-type: none"> • Install the air conditioner on a foundation strong enough to withstand the weight of the unit. A foundation of insufficient strength may result in the equipment falling and causing injury. 	
<ul style="list-style-type: none"> • Electrical work must be performed in accordance with relevant local and national regulations and with instructions in this installation manual. Be sure to use a dedicated power supply circuit only. Insufficiency of power circuit capacity and improper workmanship may result in electric shocks or fire. 	
<ul style="list-style-type: none"> • Use a cable of suitable length. Do not use tapped wires or an extension lead, as this may cause overheating, electric shocks or fire. 	
<ul style="list-style-type: none"> • Make sure that all wiring is secured, the specified wires are used, and that there is no strain on the terminal connections or wires. Improper connections or securing of wires may result in abnormal heat build-up or fire. 	
<ul style="list-style-type: none"> • When wiring the power supply and connecting the wiring between the indoor and outdoor units, position the wires so that the control box lid can be securely fastened. Improper positioning of the control box lid may result in electric shocks, fire or over heating terminals. 	
<ul style="list-style-type: none"> • If refrigerant gas leaks during installation, ventilate the area immediately. Toxic gas may be produced if the refrigerant comes into contact with fire. 	
<ul style="list-style-type: none"> • After completing installation, check for refrigerant gas leakage. Toxic gas may be produced if the refrigerant gas leaks into the room and comes into contact with a source of fire, such as a fan heater, stove or cooker. 	
<ul style="list-style-type: none"> • When installing or relocating the air conditioner, be sure to bleed the refrigerant circuit to ensure it is free of air, and use only the specified refrigerant (R410A). The presence of air or other foreign matter in the refrigerant circuit causes abnormal pressure rise, which may result in equipment damage and even injury. 	
<ul style="list-style-type: none"> • During installation, attach the refrigerant piping securely before running the compressor. If the refrigerant pipes are not attached and the stop valve is open when the compressor is run, air will be sucked in, causing abnormal pressure in the refrigeration cycle, which may result in equipment damage and even injury. 	
<ul style="list-style-type: none"> • During pump-down, stop the compressor before removing the refrigerant piping. If the compressor is still running and the stop valve is open during pump-down, air will be sucked in when the refrigerant piping is removed, causing abnormal pressure in the refrigeration cycle, which may result in equipment damage and even injury. 	
<ul style="list-style-type: none"> • Be sure to earth the air conditioner. Do not earth the unit to a utility pipe, lightning conductor or telephone earth lead. Imperfect earthing may result in electric shocks. 	
<ul style="list-style-type: none"> • Be sure to install an earth leakage breaker. Failure to install an earth leakage breaker may result in electric shocks or fire. 	

 CAUTION	
<ul style="list-style-type: none"> • Do not install the air conditioner at any place where there is a danger of flammable gas leakage. In the event of a gas leakage, build-up of gas near the air conditioner may cause a fire to break out. 	
<ul style="list-style-type: none"> • While following the instructions in this installation manual, install drain piping to ensure proper drainage and insulate piping to prevent condensation. Improper drain piping may result in indoor water leakage and property damage. 	
<ul style="list-style-type: none"> • Tighten the flare nut according to the specified method such as with a torque wrench. If the flare nut is too tight, it may crack after prolonged use, causing refrigerant leakage. 	

- This appliance is intended to be used by expert or trained users in shops, in light industry and on farms, or for commercial and household use by lay persons.
- Sound pressure level is less than 70 dB(A).

Accessories

Indoor unit (A)–(H)

(A) Mounting plate	1	(D) Remote controller holder	1	(G) Operation manual	1
(B) Titanium apatite photocatalytic air-purifying filter	2	(E) Dry battery AAA. LR03 (alkaline)	2	(H) Installation manual	1
(C) Wireless remote controller	1	(F) Indoor unit fixing screw (M4 × 12L)	2		

Choosing an Installation Site

Before choosing the installation site, obtain user approval.

1. Indoor unit

- The indoor unit should be sited in a place where:
 - 1) the restrictions on installation specified in the indoor unit installation drawings are met,
 - 2) both air inlet and air outlet have clear paths met,
 - 3) the unit is not in the path of direct sunlight,
 - 4) the unit is away from the source of heat or steam,
 - 5) there is no source of machine oil vapour (this may shorten indoor unit life),
 - 6) cool (warm) air is circulated throughout the room,
 - 7) the unit is away from electronic ignition type fluorescent lamps (inverter or rapid start type) as they may shorten the remote controller range,
 - 8) the unit is at least 1m away from any television or radio set (unit may cause interference with the picture or sound),
 - 9) install at the recommended height (1.8m),
 - 10) no laundry equipment is located.

2. Wireless remote controller

- Turn on all the fluorescent lamps in the room, if any, and find the site where remote controller signals are properly received by the indoor unit (within 7m).

Preparation before Installation

1. Removing and installing front panel

• Removal method

- 1) Place your fingers in the indentations on the main unit (one each on the left and right sides), and open the front panel until it stops.
- 2) Continue to open the front panel further while sliding the panel to the right and pulling it toward you in order to disengage the front panel shaft on the left side. To disengage the front panel shaft on the right side, slide the panel to the left while pulling it toward you.

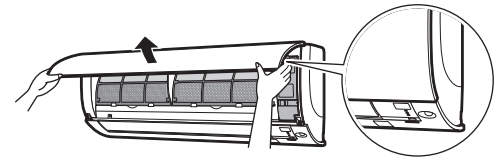

• Installation method

Align the tabs of the front panel with the grooves, and push all the way in. Then close slowly. Push the centre of the lower surface panel firmly to engage the tabs.

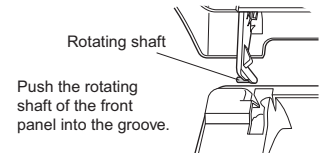

2. Removing and installing the front grille

• Removal method

- 1) Remove the front panel to remove the air filter.
- 2) Remove the 2 screws from the front grille.
- 3) In front of the ○○○ mark of the front grille, there are 3 upper hooks. Lightly pull the front grille toward you with one hand, and push down on the hooks with the fingers of your other hand.

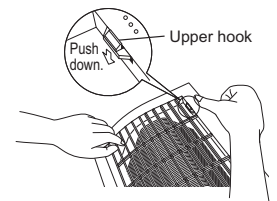
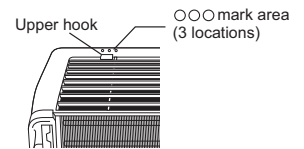

When there is no work space because the unit is close to ceiling

⚠ CAUTION

- Be sure to wear protection gloves.

Place both hands under the centre of the front grille, and while pushing up, pull it toward you.

• Installation method

- 1) Install the front grille and firmly engage the upper hooks (3 locations).
- 2) Install 2 screws of the front grille.
- 3) Install the air filter and then mount the front panel.

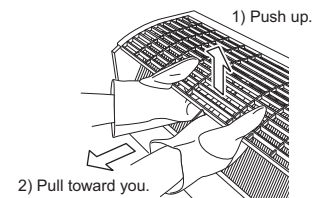

3. How to set the different addresses

When two indoor units are installed in one room, the two wireless remote controllers can be set for different addresses.

- 1) In the same way as when connecting to an HA system, remove the metal plate electrical wiring cover.
- 2) Cut the address jumper (JA) on the printed circuit board.
- 3) Cut the address jumper (J4) in the remote controller.

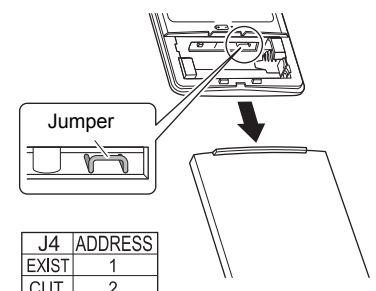
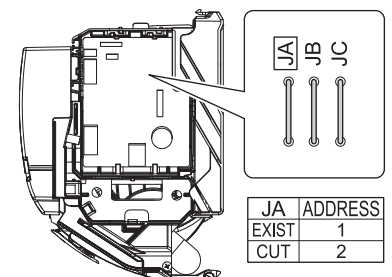

Indoor Unit Installation Drawings

■ **How to attach the indoor unit**
Hook the claws of the bottom frame to the mounting plate.
If the claws are difficult to hook, remove the front grille.

■ **How to remove the indoor unit**
Push up the marked area (at the lower part of the front grille) to release the claws. If it is difficult to release, remove the front grille.

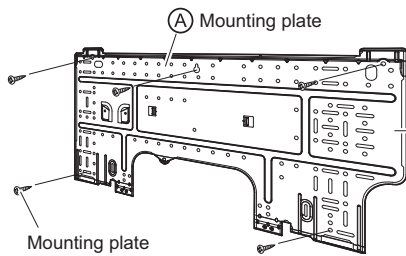
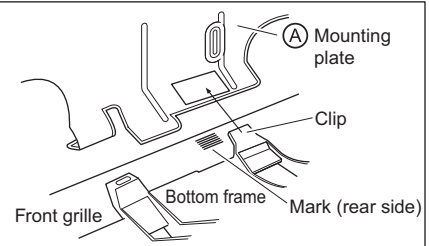

Mounting plate fixing screw
(field supply: M4 × 25L)

The mounting plate should be installed on a wall which can support the weight of the indoor unit.

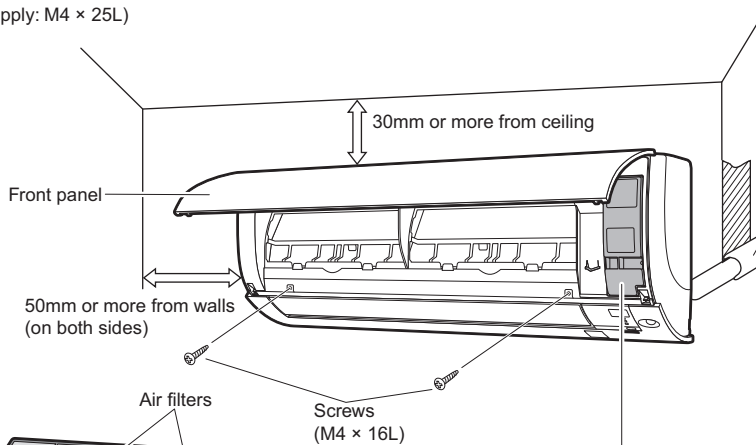

Caulk pipe hole gap with putty.

Cut thermal insulation pipe to an appropriate length and wrap it with tape, making sure that no gap is left in the insulation pipe's cut line.

Wrap the insulation pipe with the finishing tape from bottom to top.

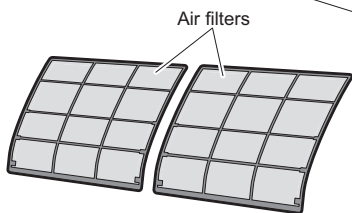

Service lid

■ **Opening service lid**
Service lid is removable.

■ **Opening method**

- 1) Remove the service lid screw.
- 2) Pull out the service lid diagonally down in the direction of the arrow.
- 3) Pull down.

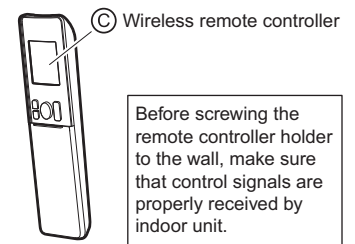
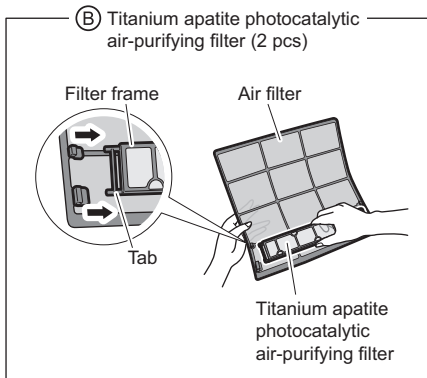

Before screwing the remote controller holder to the wall, make sure that control signals are properly received by indoor unit.

Fixing screw for remote controller holder
(field supply: M3 × 20L)

Remote controller holder

Indoor Unit Installation

1. Installing the mounting plate

- The mounting plate should be installed on a wall which can support the weight of the indoor unit.
- Temporarily secure the mounting plate to the wall, make sure that the panel is completely level, and mark the boring points on the wall.
 - Secure the mounting plate to the wall with screws.

Recommended mounting plate retention spots and dimensions

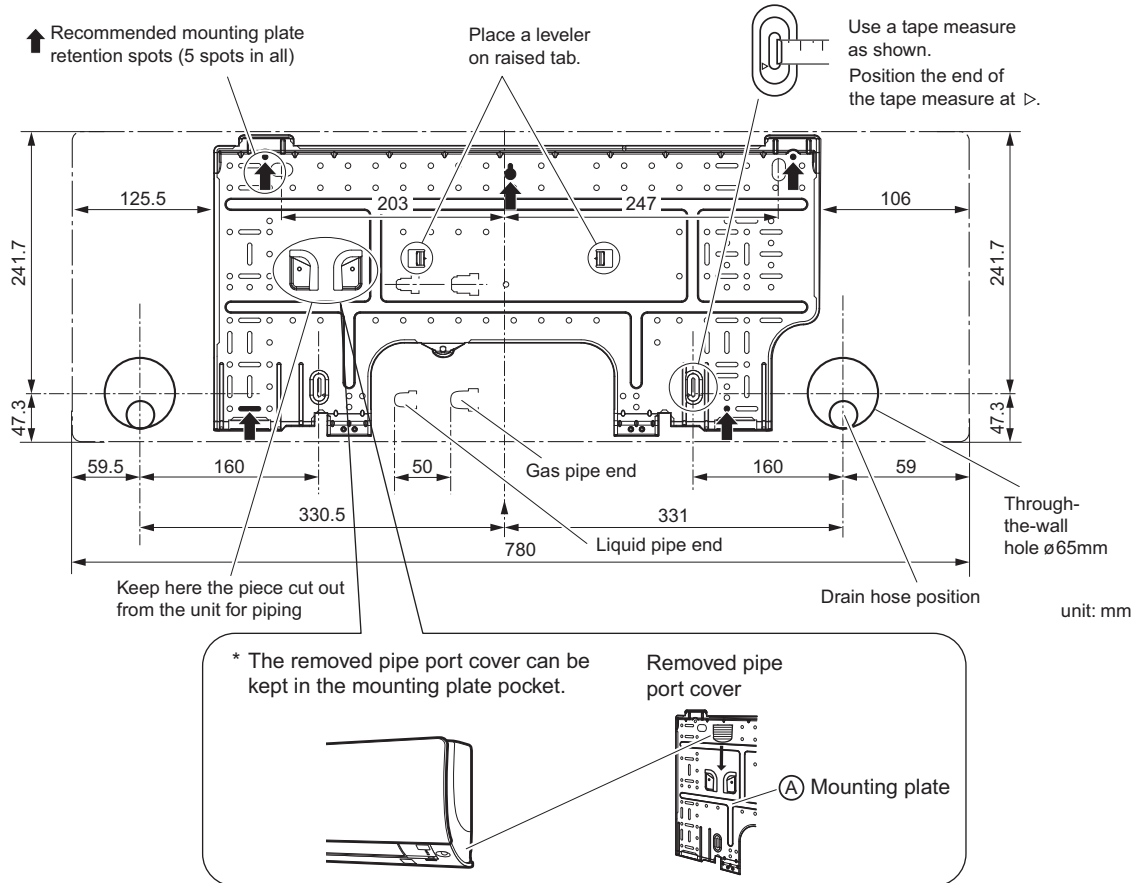

2. Boring a wall hole and installing wall embedded pipe

- For walls containing metal frame or metal board, be sure to use a wall embedded pipe and wall cover in the feed-through hole to prevent possible heat, electrical shock, or fire.
 - Be sure to caulk the gaps around the pipes with caulking material to prevent water leakage.
- Bore a feed-through hole of 65mm in the wall so it has a down slope toward the outside.
 - Insert a wall pipe into the hole.
 - Insert a wall cover into wall pipe.
 - After completing refrigerant piping, wiring, and drain piping, caulk pipe hole gap with putty.

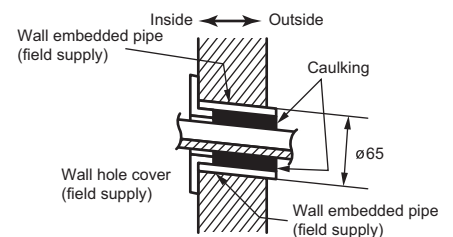

3. Installing the indoor unit

- In the case of bending or curing refrigerant pipes, keep the following precautions in mind. Abnormal sound may be generated if improper work is conducted.
- Do not strongly press the refrigerant pipes onto the bottom frame.
 - Do not strongly press the refrigerant pipes on the front grille, either.

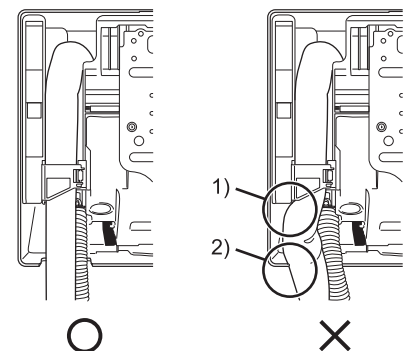

Indoor Unit Installation

- Remove the pipe port cover as shown below.
- 1) Cut off the pipe port cover from inside the front grille using a coping saw.
Apply the blade of the coping saw to the notch, and cut off the pipe port cover along the slit.
 - 2) After cutting off the pipe port cover, perform filing. Remove the burrs along the cut section using a half round needle file.

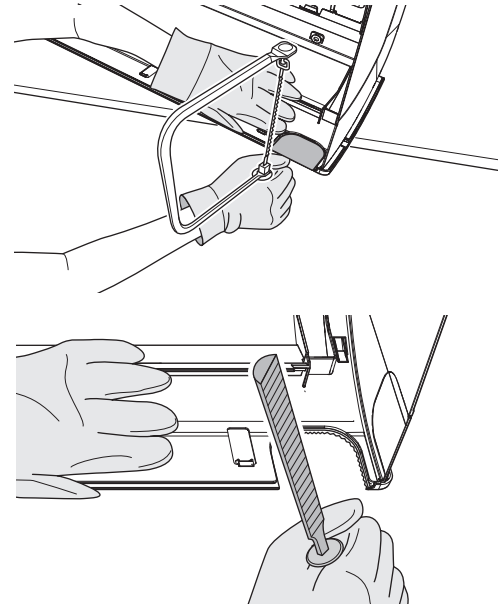

⚠ CAUTION

- If the pipe port cover is cut off using nippers, the front grille will be damaged. Please do not use nippers.
- Wear gloves during the pipe port cover removal.

3-1. Right-side, right-back, or right-bottom piping

- 1) Attach the drain hose to the underside of the refrigerant pipes with adhesive vinyl tape.
- 2) Wrap the refrigerant pipes and drain hose together with insulation tape.

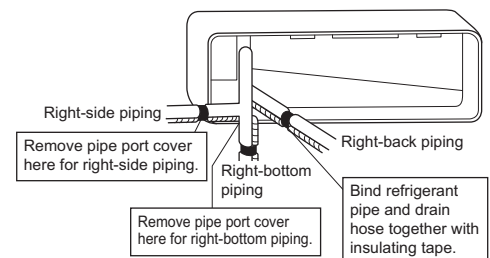

- 3) Pass the drain hose and refrigerant pipes through the wall hole, then set the indoor unit on the mounting plate hooks by using the △ markings at the top of the indoor unit as a guide.

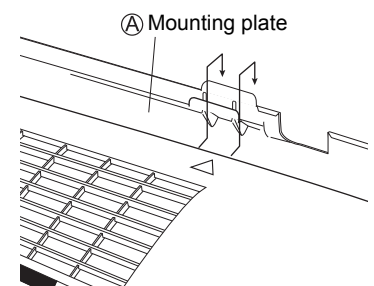

- 4) Open the front panel, then open the service lid.
(Refer to preparation before installation.)
- 5) Pass the inter-unit wire from the outdoor unit through the feed-through wall hole and then through the back of the indoor unit. Pull them through the front side. Bend the ends of tie wires upward for easier work in advance. (If the inter-unit wire ends are to be stripped first, bundle wire ends with adhesive tape.)
- 6) Press the bottom frame of the indoor unit with both hands to set it on the mounting plate hooks. Make sure the wires do not catch on the edge of the indoor unit.

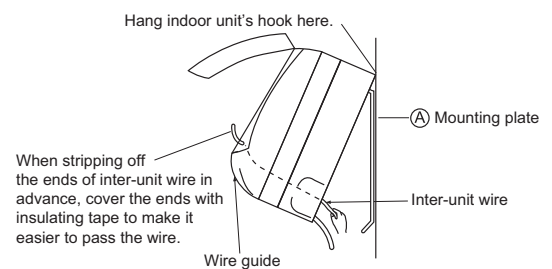

Indoor Unit Installation

3-2. Left-side, left-back, or left-bottom piping

How to replace the drain plug and drain hose

- **Replacing onto the left side**
 - 1) Remove the insulation fixing screw on the right and remove the drain hose.
 - 2) Remove the drain plug on the left side and attach it to the right side.
 - 3) Insert the drain hose and tighten with included insulation fixing screw.
 - * (Forgetting to tighten this may cause water leakages.)

Drain hose attachment position

* The drain hose is on the back of the unit.

- 1) Attach the drain hose to the underside of the refrigerant pipes with adhesive vinyl tape.

- 2) Be sure to connect the drain hose to the drain port in place of a drain plug.

- 3) Shape the refrigerant pipes along the pipe path marking on the mounting plate.
- 4) Pass the drain hose and refrigerant pipes through the wall hole, then set the indoor unit on mounting plate hooks, using the Δ markings at the top of the indoor unit as a guide.
- 5) Pull in the inter-unit wire.
- 6) Connect the inter-unit pipes.

- 7) Wrap the refrigerant pipes and drain hose together with insulation tape as shown in the figure on the right (in case of setting the drain hose through the back of the indoor unit).
- 8) While exercising care so that the inter-unit wire does not catch indoor unit, press the bottom edge of indoor unit with both hands until it is firmly caught by the mounting plate hooks. Secure indoor unit to the mounting plate with indoor unit fixing screws (M4 \times 12L).

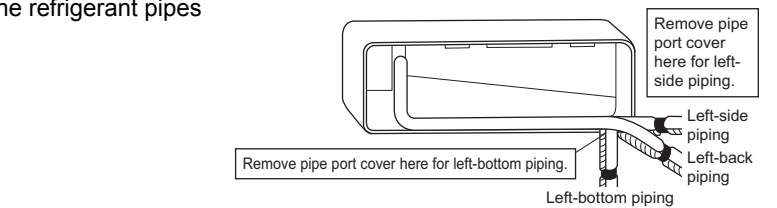

How to set drain plug

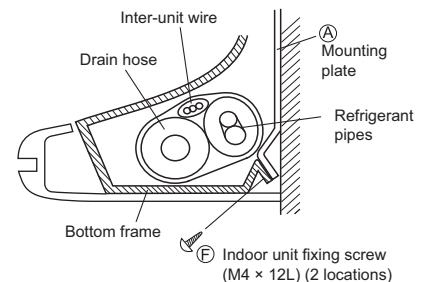
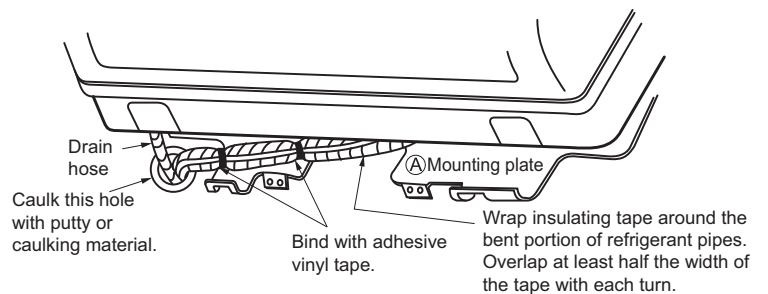
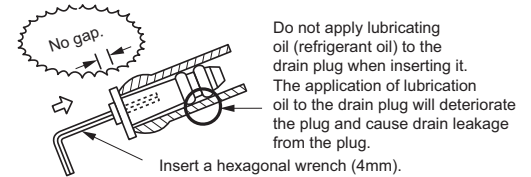

3-3. Wall embedded piping

Follow the instructions given under left-side, left-back, or left-bottom piping.

- 1) Insert the drain hose to this depth so it won't be pulled out of the drain pipe.

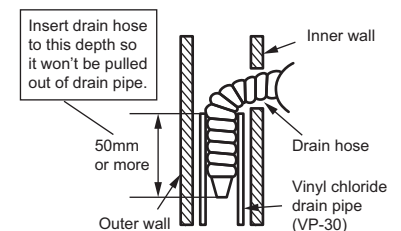

Indoor Unit Installation

Wiring diagram

	: Terminal strip		: Connection
	: Connector		: Field wiring

BLK	: Black	ORG	: Orange
BLU	: Blue	RED	: Red
BRN	: Brown	WHT	: White
GRN	: Green	YLW	: Yellow

Notes	: Refer to the nameplate for power requirements.		
	: INDOOR	Indoor	
	: OUTDOOR	Outdoor	
	: TRANSMISSION CIRCUIT	Transmission circuit	
	: INTELLIGENT EYE SENSOR	Intelligent eye sensor	
	: WIRELESS REMOTE CONTROLLER	Wireless remote controller	
	: SIGNAL RECEIVER	Signal receiver	

Wiring diagram parts table

BZ	Buzzer
C101,C102.....	Capacitor
FG.....	Frame ground
F1U	Fuse (3,15A)
H1P~H3P.....	Pilot lamp
MR10	Magnetic relay
M1F.....	Fan motor
M1S~M3S.....	Swing motor
PCB1~PCB4.....	Printed circuit board
R1T,R2T.....	Thermistor
S1~S49.....	Connector
SW1	Operation switch
V1	Varistor
X1M	Terminal strip
	Protective earth

CAUTION

Note that operation will restart automatically if the main power supply is turned off and then back on again.

HIGH VOLTAGE – be sure to discharge the capacitor completely before repair work.

Risk of failure or water leakage! Do not wash the inside of the air conditioner by yourself.

Indoor Unit Installation

4. Wiring

- 1) Strip wire ends (15mm).
- 2) Match wire colours with terminal numbers on indoor and outdoor unit's terminal blocks and firmly screw wires to the corresponding terminals.
- 3) Connect the earth wires to the corresponding terminals.
- 4) Pull wires to make sure that they are securely latched up, then retain wires with wire retainer.
- 5) Shape the wires so that the service lid fits securely, then close service lid.

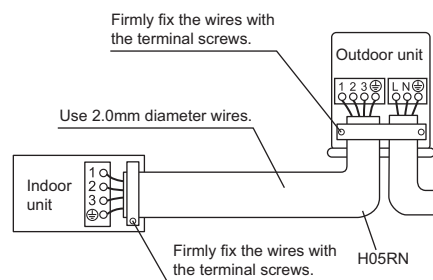
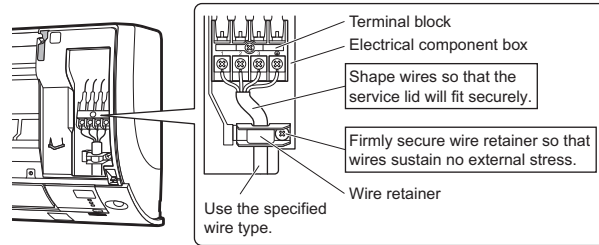

WARNING

- Do not use tapped wires, stranded wires, extension cords, or starburst connections, as they may cause overheating, electrical shock, or fire.
- Do not use locally purchased electrical parts inside the product. (Do not branch the power for the drain pump, etc., from the terminal block.) Doing so may cause electric shock or fire.
- Do not connect the power wire to the indoor unit. Doing so may cause electric shock or fire.

5. When connecting to a wired remote controller

- * If work space is available on the right side of the indoor unit, the work can be performed with the electrical component box attached. Omit the steps involved with removing and installing the electrical component box in order to perform the work more efficiently.

5-1. Remove the front grille (2 screws).

5-2. Remove the service lid (1 screw).

5-3. Remove the cover from the electrical component box [Figure 1].

- * **5-4. Remove the electrical component box.**

- 1) Remove the flap.
- 2) Disconnect the inter-unit wire
- 3) Disconnect the connector (S200).
- 4) Remove the thermistor from the heat exchanger.
- 5) Remove the earth wire.
- 6) Remove the electrical component box installation screw (1 screw).

Figure 1: Removing the cover from the electrical component box

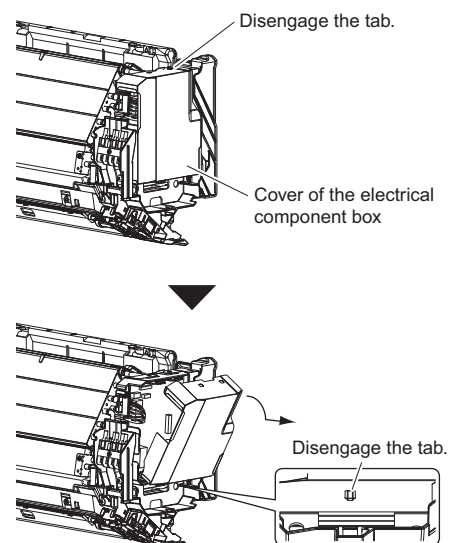

Indoor Unit Installation

5-5. Prepare the accessory (optional parts) [Figure 2].

- 1) Remove the cover from the accessory (optional parts).
- 2) Insert the connection cord into connector "S21" (white) in the accessory (optional parts).
- 3) Route each of the connection cords through the cut-outs in the accessory, then reinstall the accessory cover in its original position.
- 4) Insert the accessory (optional parts) connector into connector "S403" in the electrical component box. Then route the connection cord through the cut-out in the electrical component box.

5-6. Install the cover of the electrical component box in its original position [Figure 3].

5-7. Install the accessory (optional parts) [Figure 3].

- 1) Install the accessory (optional parts) into the electrical component box.
- 2) Route the connection cord as shown in [Figure 3].

5-8. Install the electrical component box in its original position.

- 1) Install the electrical component box (1 screw).
- 2) Install the thermistor in its original position on the heat exchanger.
- 3) Connect the earth wire.
- 4) Install the connector (S200) in its original position.
- 5) Connect the inter-unit wire in its original position.
- 6) Install the flap.

5-9. Install the front grille in its original position (2 screws).

5-10. Install the service lid (1 screw).

Figure 2: Preparing the accessory

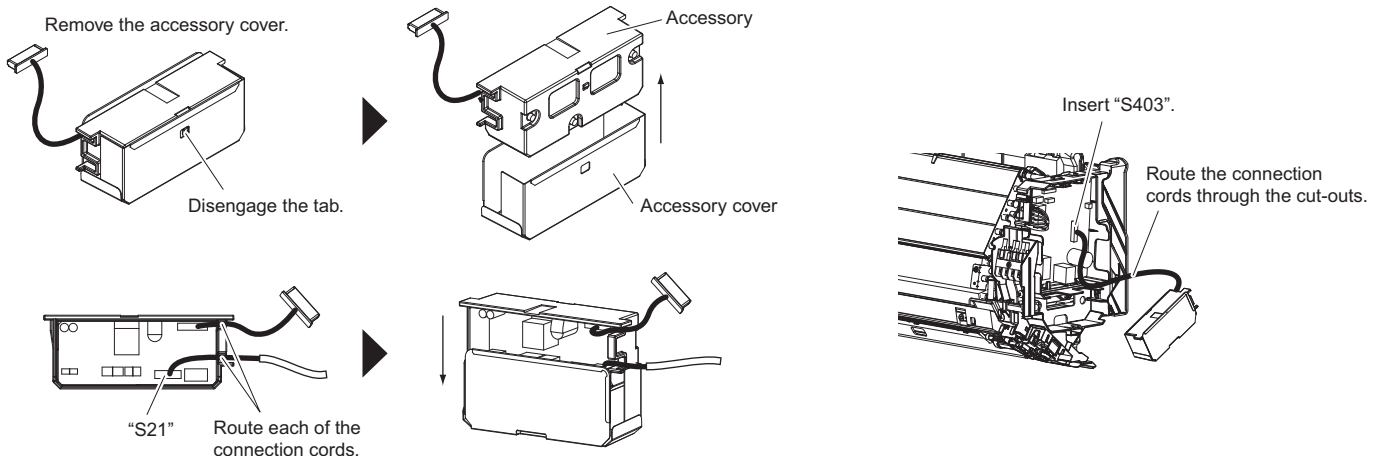
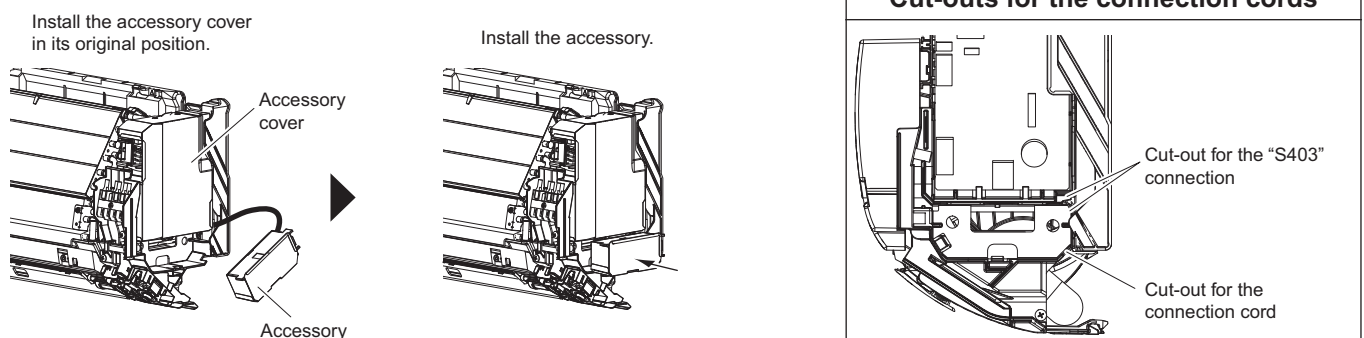

Figure 3: Installing the accessory



Indoor Unit Installation

6. Drain piping

1) Connect the drain hose, as described right.

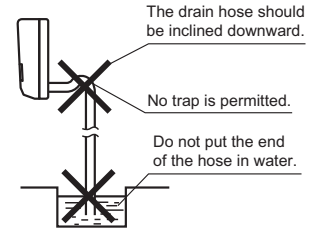

2) Remove the air filters and pour some water into the drain pan to check the water flows smoothly.

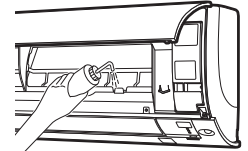

3) If drain hose extension or embedded drain piping is required, use appropriate parts that match the hose front end.
[Figure of hose front end]

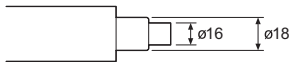

4) When extending the drain hose, use a commercially available extension hose with an inner diameter of 16mm. Be sure to thermally insulate the indoor section of the extension hose.

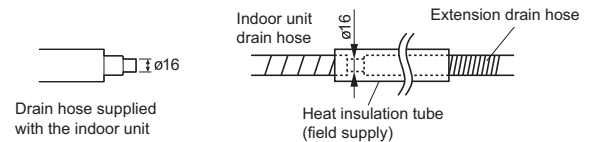

5) When connecting a rigid polyvinyl chloride pipe (nominal diameter 13mm) directly to the drain hose attached to the indoor unit as with embedded piping work, use any commercially available drain socket (nominal diameter 13mm) as a joint.

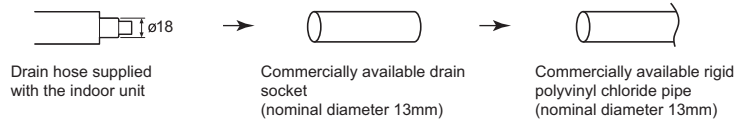

Refrigerant Piping Work

1. Flaring the pipe end

- 1) Cut the pipe end with a pipe cutter.
- 2) Remove burrs with the cut surface facing downward so that the chips do not enter the pipe.
- 3) Put the flare nut on the pipe.
- 4) Flare the pipe.
- 5) Check that the flaring is properly made.



Set exactly at the position shown below.

Flare tool for R410A	Conventional flare tool		
	Clutch-type	Clutch-type (Rigid-type)	Wing-nut type (Imperial-type)
A	0-0.5mm	1.0-1.5mm	1.5-2.0mm

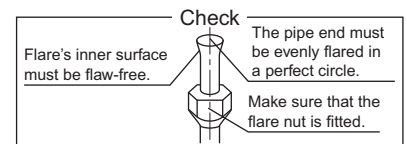

WARNING

- Do not use mineral oil on flared part.
- Prevent mineral oil from getting into the system as this would reduce the lifetime of the units.
- Never use piping which has been used for previous installations. Only use parts which are delivered with the unit.
- Never install a dryer to this R410A unit in order to guarantee its lifetime.
- The drying material may dissolve and damage the system.
- Incomplete flaring may cause refrigerant gas leakage.

Refrigerant Piping Work

2. Refrigerant piping

⚠ CAUTION

- Use the flare nut fixed to the main unit. (To prevent cracking of the flare nut by aged deterioration.)
- To prevent gas leakage, apply refrigeration oil only to the inner surface of the flare. (Use refrigeration oil for R410A.)
- Use torque wrenches when tightening the flare nuts to prevent damage to the flare nuts and gas leakage.

Align the centres of both flares and tighten the flare nuts 3 or 4 turns by hand. Then tighten them fully with the torque wrenches.

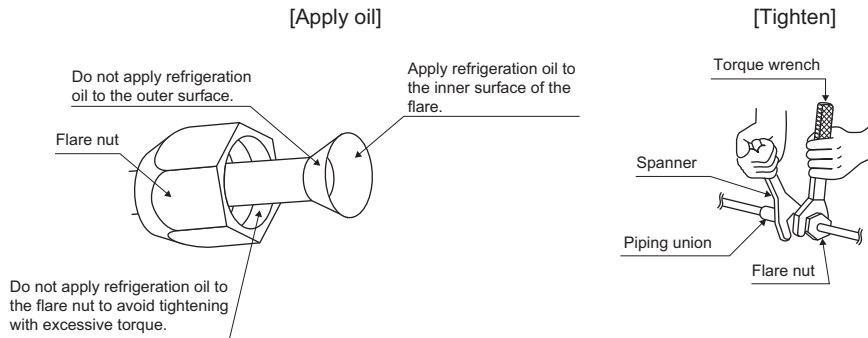

Flare nut tightening torque	
Gas side	Liquid side
3/8 inch	1/4 inch
32.7-39.9N • m (330-407kgf • cm)	14.2-17.2N • m (144-175kgf • cm)

2-1. Caution on piping handling

- 1) Protect the open end of the pipe against dust and moisture.
- 2) All pipe bends should be as gentle as possible. Use a pipe bender for bending.

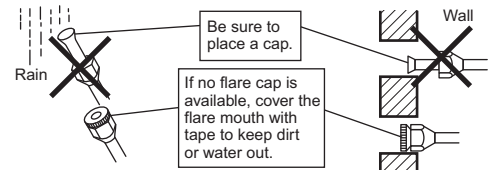

2-2. Selection of copper and heat insulation materials

- When using commercial copper pipes and fittings, observe the following:
 - 1) Insulation material: Polyethylene foam
Heat transfer rate: 0.041 to 0.052W/mK (0.035 to 0.045kcal/mh°C)
Refrigerant gas pipe's surface temperature reaches 110°C max.
Choose heat insulation materials that will withstand this temperature.

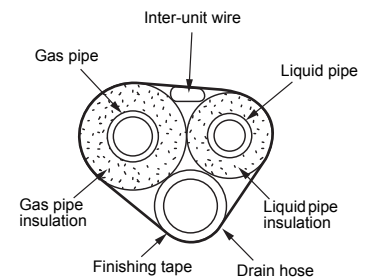

- 2) Be sure to insulate both the gas and liquid piping and to provide insulation dimensions as below.

Gas side	Liquid side	Gas pipe thermal insulation	Liquid pipe thermal insulation
O.D. 9.5mm	O.D. 6.4mm	I.D. 12-15mm	I.D. 8-10mm
Minimum bend radius		Thickness 10mm Min.	
30mm or more			
Thickness 0.8mm (C1220T-O)			

- 3) Use separate thermal insulation for gas and liquid refrigerant pipes.

Trial Operation and Testing

1. Trial operation and testing

1-1 Measure the supply voltage and make sure that it falls in the specified range.

1-2 Trial operation should be carried out in either cooling or heating mode.

- In cooling mode, select the lowest programmable temperature; in heating mode, select the highest programmable temperature.
 - 1) Trial operation may be disabled in either mode depending on the room temperature. Use the remote controller for trial operation as described below.
 - 2) After trial operation is complete, set the temperature to a normal level (26°C to 28°C in cooling mode, 20°C to 24°C in heating mode).
 - 3) For protection, the system disables restart operation for 3 minutes after it is turned off.

1-3 Carry out the test operation in accordance with the operation manual to ensure that all functions and parts, such as louver movement, are working properly.

- The air conditioner requires a small amount of power in its standby mode. If the system is not to be used for some time after installation, shut off the circuit breaker to eliminate unnecessary power consumption.
- If the circuit breaker trips to shut off the power to the air conditioner, the system will restore the original operation mode when the circuit breaker is opened again.

Trial operation from remote controller

- 1) Press "ON/OFF" button to turn on the system.
- 2) Press "TEMP" button (2 locations) and "MODE" button at the same time.
- 3) Press "TEMP" button and select "7".
- 4) Press "MODE" button.
- 5) Trial operation terminates in approx. 30 minutes and switches into normal mode. To quit a trial operation, press "ON/OFF" button.

2. Test items

Test items	Symptom (diagnostic display on RC)	Check
Indoor and outdoor units are installed properly on solid bases.	Fall, vibration, noise	
No refrigerant gas leaks.	Incomplete cooling/heating function	
Refrigerant gas and liquid pipes and indoor drain hose extension are thermally insulated.	Water leakage	
Draining line is properly installed.	Water leakage	
System is properly earthed.	Electrical leakage	
The specified wires are used for inter-unit wiring.	Inoperative or burn damage	
Indoor or outdoor unit's air inlet or air outlet has clear path of air.	Incomplete cooling/heating function	
Stop valves are opened.	Incomplete cooling/heating function	
Indoor unit properly receives remote control commands.	Inoperative	
☀ will appear when the MODE button is pressed.*	No heating	

* If the ☀ is not displayed, change the dipswitch setting for the remote controller.

Slide the dipswitch to the left-hand side.

Press the MODE button again and check that ☀ appears on the LCD of the remote controller.

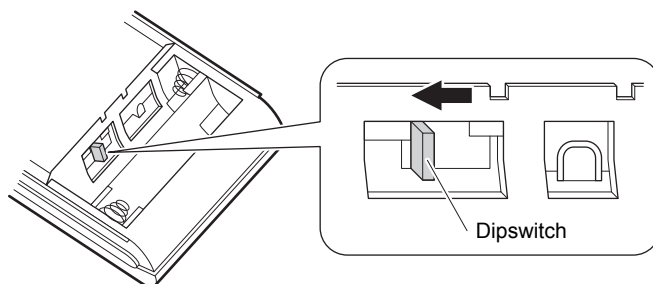

DAIKIN INDUSTRIES, LTD.

Head office:
Umeda Center Bldg., 2-4-12, Nakazaki-Nishi,
Kita-ku, Osaka, 530-8323 Japan

Tokyo office:
JR Shinagawa East Bldg., 2-18-1, Konan,
Minato-ku, Tokyo, 108-0075 Japan
http://www.daikin.com/global_ac/

DAIKIN EUROPE N.V.

Zandvoordestraat 300, B-8400 Oostende, Belgium

DAIKIN INDUSTRIES CZECH REPUBLIC s.r.o.

U Nové Hospody 1/1155, 301 00 Plzeň Skvrňany, Czech Republic

Copyright 2013 Daikin

