

DAIKIN

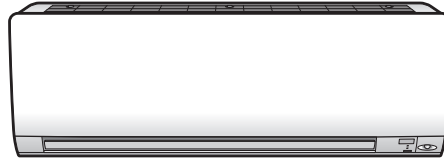

DAIKIN ROOM AIR CONDITIONER

INSTALLATION MANUAL

R410A Split Series



MODELS

FTXS20K2V1B

FTXS25K2V1B

CTXS15K2V1B

CTXS35K2V1B

ATXS20K2V1B

ATXS25K2V1B

FTXS20K3V1B

FTXS25K3V1B

CTXS15K3V1B

CTXS35K3V1B

ATXS20K3V1B

ATXS25K3V1B

CE - DECLARATION-OF-CONFORMITY
 CE - KONFORMITÄTSEKHLÄRUNG
 CE - DECLARATION-DE-CONFORMITE
 CE - CONFORMITEITSVERKLARING

Daikin Industries, Ltd.

- 01 (GB) declares under its sole responsibility that the equipment to which this declaration relates:
- 02 (D) erklärt auf seine alleinige Verantwortung, dass diese Ausrüstung, für die diese Erklärung bestimmt ist:
- 03 (F) déclare sous sa seule responsabilité que l'équipement visé par la présente déclaration:
- 04 (NL) verklaart hierbij op eigen exclusieve verantwoordelijkheid dat de apparatuur waarop deze verklaring betrekking heeft:
- 05 (E) declara bajo su única responsabilidad que el equipo al que hace referencia la declaración:
- 06 (I) dichiara sotto la propria responsabilità che gli apparecchi a cui è riferita questa dichiarazione:
- 07 (GR) δηλώνει με αποκλειστική της ευθύνη ότι ο εξοπλισμός στον οποίο αναφέρεται η παρούσα δήλωση:
- 08 (P) declara sob sua exclusiva responsabilidade que os equipamentos a que esta declaração se refere:
- 09 (RU) заявляет, исключительно под свою ответственность, что оборудование, к которому относится настоящее заявление:

CE - DECLARAÇÃO-DE-CONFORMIDAD
 CE - ДИХЛАРАЦИОН-ДИ-CONFORMITA
 CE - ΟΡΥΓΙΔΕΙ ΣΕΣΚΛΗΡΙΝΓ
 CE - FÖRSÄKRAN-OM-ÖVERENSTÄMMELSE

- 10 (GB) declares under its sole responsibility that the equipment to which this declaration relates:
- 11 (S) deklarerar i egenansvarlig, at udstyret, som er omfattet af denne erklæring:
- 12 (N) erklærer i egenansvarlig, at utrustningen som berøres av denne deklarasjon innefattet att:
- 13 (NL) erklærer et fullstendig ansvar for dat het udstyr som berøres av denne deklarasjon, innebeholder at:
- 14 (NL) imolizuje, yksnomoznan omalla vastuullaan, että tämän ilmoituksen tarkoituksena on:
- 15 (HR) prohišuje u sve pine odgovornosti, Ze zarizeni, k nemiuz se toto prohlášení vztahuje:
- 16 (HR) izjavljuje pod isključivo vlastitom odgovornošću da oprema na koju se ova izjava odnosi:
- 17 (PL) deklaruje na własną wyłączną odpowiedzialność, że urządzenie, których ta deklaracja dotyczy:
- 18 (RO) declară pe proprie răspundere că echipamentele la care se referă această declarație:

CE - ERKLERING OM-SAMSVAR
 CE - ILMOITUS-YHDENMUKAISUDESTA
 CE - DEKLARACJA-ZGODNOŚCI
 CE - DECLARAȚIE-DE-CONFORMITATE

- 19 (GB) z vsjo odgovornostjo zjavlja, da je oprema naprave, na katero se izjava nanaša:
- 20 (GR) kimitab ona itelikku vastuutuksi, et käsioleva deklaratsioon alla kuuluv varustus:
- 21 (BG) декларира на свое отговорност, че оборудването, за което се отнася тази декларация:
- 22 (LV) vislūsta savu atsaucamības atbildību, ka šī deklarācija attiecas uz aprīkojumu, kas minēts šīs deklarācijas tekstā:
- 23 (LV) ar pirmu atbildību atbildina, ka tālāk aprakstītais iekārtas, uz kurām attiecas šī deklarācija:
- 24 (SK) vyhlasuje na vlastnú zodpovednosť, že zariadenie, na ktoré sa vzťahuje toto vyhlásenie:
- 25 (TR) taanamen kendi sorumluluğunda olnak üzere bu bildirimini ilgili oluştugu donanımın eşyağıdaki gibi olduğunu beyan eder:

CE - IZJAVA O SKLADNOSTI
 CE - VASTAVUSDEKLARACIJA
 CE - ДЕКЛАРАЦІЯ-ЗА-СЬОТБЕТСТВІМЕ
 CE - UYUMLULUK-BİLDİRİSİ

- 19 (GB) z vsjo odgovornostjo zjavlja, da je oprema naprave, na katero se izjava nanaša:
- 20 (GR) kimitab ona itelikku vastuutuksi, et käsioleva deklaratsioon alla kuuluv varustus:
- 21 (BG) декларира на свое отговорност, че оборудването, за което се отнася тази декларация:
- 22 (LV) vislūsta savu atsaucamības atbildību, ka šī deklarācija attiecas uz aprīkojumu, kas minēts šīs deklarācijas tekstā:
- 23 (LV) ar pirmu atbildību atbildina, ka tālāk aprakstītais iekārtas, uz kurām attiecas šī deklarācija:
- 24 (SK) vyhlasuje na vlastnú zodpovednosť, že zariadenie, na ktoré sa vzťahuje toto vyhlásenie:
- 25 (TR) taanamen kendi sorumluluğunda olnak üzere bu bildirimini ilgili oluştugu donanımın eşyağıdaki gibi olduğunu beyan eder:

CE - ATTIKTIES-DEKLARACIJA
 CE - ATBILSTĪBAS-DEKLARACĪJA
 CE - VYHLÁSENIE-ZHODY
 CE - UYUMLULUK-BİLDİRİSİ

FTXS20K2V1B, FTXS25K2V1B, CTXS15K2V1B, CTXS35K2V1B

- 01 is in conformity with the provisions of:
- 02 den følgende Bestimmungen entspringt:
- 03 est conforme aux prescriptions de:
- 04 conform is met de bepalingen van:
- 05 cumple las disposiciones según:
- 06 è conforme alle disposizioni di:
- 07 συμμορφώνεται με τις διατάξεις του:
- 08 está conforme ao articulado em:
- 09 соответствует положениям:
- 10 lever op til kravene i:
- 11 uppfyller bestämmelserna i:
- 12 er i samsvar med bestemmelserne i:
- 13 vastatait seuraavista vaatimuksista:
- 14 vihovuje podmínkam ustanovení:
- 15 ispunjava slijedeće:
- 16 međela i kóvalkezi írijavati dokumentum(oljvak):
- 17 pozostaje w zgodności z postanowieniami:
- 18 este în conformitate cu prevederile:
- 19 is usklejen z dobózbami:
- 20 on vastavuses järgmistele nõuetele:
- 21 съответства на разпоредбите на:
- 22 atilinka nustatytius reikalavimus:
- 23 atbilst prasībām, kas noteiktas:
- 24 je v znoze s ustanoveniami:
- 25 hukkimeni lie uymuludur:

- 07 υπό την προϋπόθεση ότι ο εξοπλισμός χρησιμοποιείται σύμφωνα με τις οδηγίες που δόσε.
- 08 desde que o equipamento seja utilizado em conformidade com as nossas instruções.
- 09 по условиям, что данное оборудование используется в соответствии с нашими инструкциями.
- 10 forudsat at udstyret anvendes i henhold til vores anvisninger.
- 11 under forudsætning at udstyringen anvendes i henhold med vore instruktioner.
- 12 forutsatt at utstyret brukes i henhold til våre instruksjoner.

- 07 H Daikin Europe N.V. eivai εξουσιοδοτημένη να συντάξει τον Τεχνικό Φακέλο κατασκευής.
- 08 Daikin Europe N.V. está autorizada a compilar el documentación técnica de fabrico.
- 09 Компания Daikin Europe N.V. уполномочена составлять Комплект технической документации.
- 10 Daikin Europe N.V. er autoriseret til at udarbejde de tekniske konstruktionsdata.
- 11 Daikin Europe N.V. är bemyndigade att sammanställa den tekniska konstruktionsfilen.
- 12 Daikin Europe N.V. har tillatelse til å kompilere den Tekniske konstruktionsfilen.

Daikin Europe N.V., Zandvoordestraat 300, B-8400 Oostende Belgium



Shinri Sada
 Manager Quality Control Department

 Shinri Sada

2011.10.26

3SB65451-2

- 01 Directive (valid from 29/12/2009).
- 02 Richtlijn (geldig ab 29/12/2009).
- 03 Directive (valable à partir du 29/12/2009).
- 04 Richtlijn (geldig vanaf 29/12/2009).
- 05 Directiva (válida desde 29/12/2009).
- 06 Directiva (válida ddt 29/12/2009).

Machinery 2006/42/EC

- 13 edelytään, että laitteista käytetään ohjeiden mukaisesti.
- 14 za předpokladu, že zařízení je používáno v souladu s našimi pokyny.
- 15 da se oprema koristi u skladu s našim uputama.
- 16 ha a berendezést az előírtaknak megfelelően használják.
- 17 pod warunkiem eksploatacji urządzenia zgodnie z treścią instrukcji.
- 18 cu condiția ca echipamentul să fie utilizat în conformitate cu instrucțiunile noastre.

- 13 Daikin Europe N.V. on valtuutettu laatimaan Teknisen Asakirjan.
- 14 Společnost Daikin Europe N.V. má oprávnění ke kompilaci souboru technické konstrukce.
- 15 Daikin Europe N.V. je ovlašten za izradu Datoteke o tehničkoj konstrukciji.
- 16 A Daikin Europe N.V. jogsútt a mizsak konstrukciós dokumentáció összeállítására.
- 17 Daikin Europe N.V. ma upovnežene do zberania i opracowywania dokumentacji konstrukcyjnej.
- 18 Daikin Europe N.V. este autorizat să compileze Dosarul tehnic de construcție.

- 07 Öbnyte (toyevy oty 29/12/2009).
- 08 Directiva (em vigor desde 29/12/2009).
- 09 Директива (важдей с 29/12/2009).
- 10 Direktiv (gældende fra 29/12/2009).
- 11 Direktiv (giltigt fra 29/12/2009).
- 12 Direktiv (giltigt fra 29/12/2009).
- 13 Direktivi (voimassa 29.12.2009 alkaen).
- 14 Smešnica (plāna od 29/12/2009).
- 15 Direktiva (vrijedi od 29/12/2009).
- 16 Irtayevy (hatāvina spēkā: 2009. 12. 29.).
- 17 Dyrektywa (ważna od dnia 29/12/2009).
- 18 Directiva (valdāna dn 29/12/2009).

- 19 pod pogledom, da se oprema uporablja v skladu z našimi navodili.
- 20 ku varusutust kasutatakse vastavalt meie juhenditele.
- 21 по условиям, че оборудването се използва в съответствие с нашите инструкции.
- 22 su sąlyga, kad įrankis naudojamas pagal pateiktas instrukcijas.
- 23 ar nosacījumu, ka iekārtas tiek lietotas saskaņā ar mūsu instrukcijām.
- 24 za předpokladu, že se zariadenie používa v súlade s našimi pokynmi.
- 25 ekipmanni laiimatarmiz doğullusunda kullanimasa koşulluyla.

- 19 Daikin Europe N.V. je pooblaščen za sestavo datoteke s tehnično mapo.
- 20 Daikin Europe N.V. on volitatud koostama tehnilisi dokumentatsiooni.
- 21 Daikin Europe N.V. je ovlašten da sastavi Akta za tehničku konstrukciju.
- 22 Daikin Europe N.V. yra įgaliojama sudaryti šį techninės konstrukcijos failą.
- 23 Daikin Europe N.V. ir autorizats sastādīt tehnisko dokumentāciju.
- 24 Spoločnosť Daikin Europe N.V. je oprávnená vytvoriť súbor technickej konštrukcie.
- 25 Daikin Europe N.V. Teknik Yapı Dosyasını derlemeye yetkilidir.

DAIKIN INDUSTRIES, LTD.
 Umeda Center Bldg., 2-4-12, Nakazaki-Nishi,
 Kita-ku, Osaka, 530-8323 Japan



Safety Precautions

- The precautions described herein are classified as WARNING and CAUTION. They both contain important information regarding safety. Be sure to observe all precautions without fail.
- Meaning of WARNING and CAUTION notices





 **WARNING.....Failure to follow these instructions properly may result in personal injury or loss of life.**

 **CAUTION.....Failure to observe these instructions properly may result in property damage or personal injury, which may be serious depending on the circumstances.**

- The safety marks shown in this manual have the following meanings:

 Be sure to follow the instructions.	 Be sure to establish an earth connection.	 Never attempt.
---	---	--

- After completing installation, conduct a trial operation to check for faults and explain to the customer how to operate the air conditioner and take care of it with the aid of the operation manual.
- The English text is the original instruction. Other languages are translations of the original instructions.

 WARNING	
<ul style="list-style-type: none"> • Ask your dealer or qualified personnel to carry out installation work. Do not attempt to install the air conditioner yourself. Improper installation may result in water leakage, electric shocks or fire. 	
<ul style="list-style-type: none"> • Install the air conditioner in accordance with the instructions in this installation manual. Improper installation may result in water leakage, electric shocks or fire. 	
<ul style="list-style-type: none"> • Be sure to use only the specified accessories and parts for installation work. Failure to use the specified parts may result in the unit falling, water leakage, electric shocks or fire. 	
<ul style="list-style-type: none"> • Install the air conditioner on a foundation strong enough to withstand the weight of the unit. A foundation of insufficient strength may result in the equipment falling and causing injury. 	
<ul style="list-style-type: none"> • Electrical work must be performed in accordance with relevant local and national regulations and with instructions in this installation manual. Be sure to use a dedicated power supply circuit only. Insufficiency of power circuit capacity and improper workmanship may result in electric shocks or fire. 	
<ul style="list-style-type: none"> • Use a cable of suitable length. Do not use tapped wires or an extension lead, as this may cause overheating, electric shocks or fire. 	
<ul style="list-style-type: none"> • Make sure that all wiring is secured, the specified wires are used, and that there is no strain on the terminal connections or wires. Improper connections or securing of wires may result in abnormal heat build-up or fire. 	
<ul style="list-style-type: none"> • When wiring the power supply and connecting the wiring between the indoor and outdoor units, position the wires so that the control box lid can be securely fastened. Improper positioning of the control box lid may result in electric shocks, fire or over heating terminals. 	
<ul style="list-style-type: none"> • If the supply cord is damaged, it must be replaced by the manufacturer, a service agent or similarly qualified persons in order to avoid a hazard. 	
<ul style="list-style-type: none"> • If refrigerant gas leaks during installation, ventilate the area immediately. Toxic gas may be produced if the refrigerant comes into contact with fire. 	
<ul style="list-style-type: none"> • After completing installation, check for refrigerant gas leakage. Toxic gas may be produced if the refrigerant gas leaks into the room and comes into contact with a source of fire, such as a fan heater, stove or cooker. 	
<ul style="list-style-type: none"> • When installing or relocating the air conditioner, be sure to bleed the refrigerant circuit to ensure it is free of air, and use only the specified refrigerant (R410A). The presence of air or other foreign matter in the refrigerant circuit causes abnormal pressure rise, which may result in equipment damage and even injury. 	
<ul style="list-style-type: none"> • During installation, attach the refrigerant piping securely before running the compressor. If the refrigerant pipes are not attached and the stop valve is open when the compressor is run, air will be sucked in, causing abnormal pressure in the refrigeration cycle, which may result in equipment damage and even injury. 	
<ul style="list-style-type: none"> • During pump-down, stop the compressor before removing the refrigerant piping. If the compressor is still running and the stop valve is open during pump-down, air will be sucked in when the refrigerant piping is removed, causing abnormal pressure in the refrigeration cycle, which may result in equipment damage and even injury. 	
<ul style="list-style-type: none"> • Be sure to earth the air conditioner. Do not earth the unit to a utility pipe, lightning conductor or telephone earth lead. Imperfect earthing may result in electric shocks. 	
<ul style="list-style-type: none"> • Be sure to install an earth leakage breaker. Failure to install an earth leakage breaker may result in electric shocks or fire. 	

Safety Precautions

⚠ CAUTION

<ul style="list-style-type: none"> Do not install the air conditioner at any place where there is a danger of flammable gas leakage. In the event of a gas leakage, build-up of gas near the air conditioner may cause a fire to break out. 	⊘
<ul style="list-style-type: none"> While following the instructions in this installation manual, install drain piping to ensure proper drainage and insulate piping to prevent condensation. Improper drain piping may result in indoor water leakage and property damage. 	
<ul style="list-style-type: none"> Tighten the flare nut according to the specified method such as with a torque wrench. If the flare nut is too tight, it may crack after prolonged use, causing refrigerant leakage. 	
<ul style="list-style-type: none"> This appliance is intended to be used by expert or trained users in shops, in light industry and on farms, or for commercial and household use by lay persons. 	
<ul style="list-style-type: none"> Sound pressure level is less than 70 dB(A). 	

Accessories

Indoor unit (A)–(H)

(A) Mounting plate	1	(D) Remote controller holder	1	(G) Operation manual	1
(B) Titanium apatite deodorizing filter	2	(E) Dry battery AAA. LR03 (alkaline)	2	(H) Installation manual	1
(C) Wireless remote controller	1	(F) Indoor unit fixing screw (M4 × 12L)	2		

Choosing an Installation Site

Before choosing the installation site, obtain user approval.

1. Indoor unit

- The indoor unit should be sited in a place where:
 - the restrictions on installation specified in the indoor unit installation drawings are met,
 - both air inlet and air outlet have clear paths met,
 - the unit is not in the path of direct sunlight,
 - the unit is away from the source of heat or steam,
 - there is no source of machine oil vapour (this may shorten indoor unit life),
 - cool (warm) air is circulated throughout the room,
 - the unit is away from electronic ignition type fluorescent lamps (inverter or rapid start type) as they may shorten the remote controller range,
 - the unit is at least 1m away from any television or radio set (unit may cause interference with the picture or sound),
 - install at the recommended height (1.8m),
 - no laundry equipment is located.

2. Wireless remote controller

- Turn on all the fluorescent lamps in the room, if any, and find the site where remote controller signals are properly received by the indoor unit (within 7m).

Preparation before Installation

1. Removing and installing front panel

• Removal method

- 1) Place your fingers in the indentations on the main unit (one each on the left and right sides), and open the front panel until it stops.
- 2) Continue to open the front panel further while sliding the panel to the right and pulling it toward you in order to disengage the front panel shaft on the left side. To disengage the front panel shaft on the right side, slide the panel to the left while pulling it toward you.

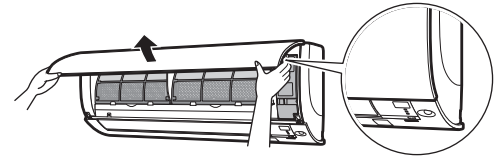

• Installation method

Align the tabs of the front panel with the grooves, and push all the way in. Then close slowly. Push the centre of the lower surface panel firmly to engage the tabs.

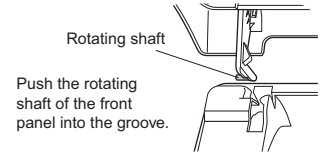

2. Removing and installing the front grille

• Removal method

- 1) Remove the front panel to remove the air filter.
- 2) Remove the 2 screws from the front grille.
- 3) In front of the ○○○ mark of the front grille, there are 3 upper hooks. Lightly pull the front grille toward you with one hand, and push down on the hooks with the fingers of your other hand.

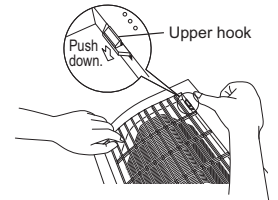
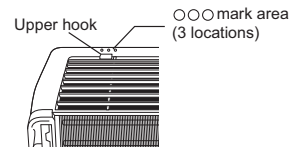

When there is no work space because the unit is close to ceiling

⚠ CAUTION

- Be sure to wear protection gloves.

Place both hands under the centre of the front grille, and while pushing up, pull it toward you.

• Installation method

- 1) Install the front grille and firmly engage the upper hooks (3 locations).
- 2) Install 2 screws of the front grille.
- 3) Install the air filter and then mount the front panel.

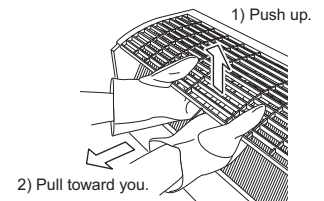

3. How to set the different addresses

When two indoor units are installed in one room, the two wireless remote controllers can be set for different addresses.

- 1) In the same way as when connecting to an HA system, remove the metal plate electrical wiring cover.
- 2) Cut the address jumper (JA) on the printed circuit board.
- 3) Cut the address jumper (J4) in the remote controller.

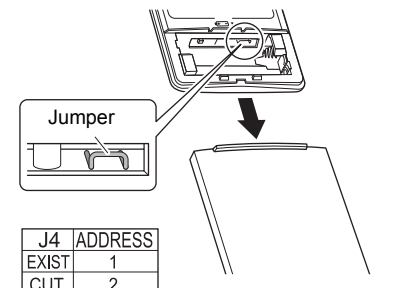
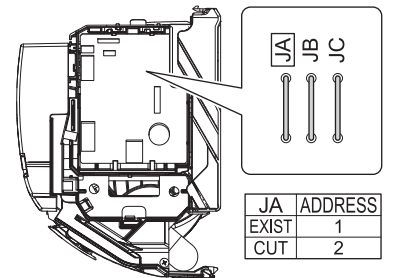

Indoor Unit Installation Drawings

■ **How to attach the indoor unit**
Hook the claws of the bottom frame to the mounting plate.
If the claws are difficult to hook, remove the front grille.

■ **How to remove the indoor unit**
Push up the marked area (at the lower part of the front grille) to release the claws. If it is difficult to release, remove the front grille.

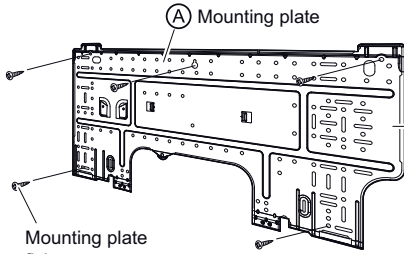
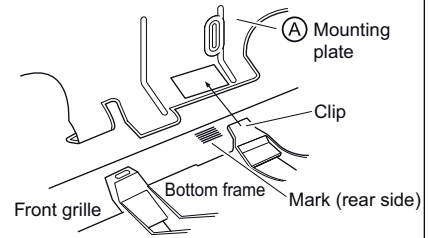

Mounting plate fixing screw
(field supply: M4 × 25L)

The mounting plate should be installed on a wall which can support the weight of the indoor unit.

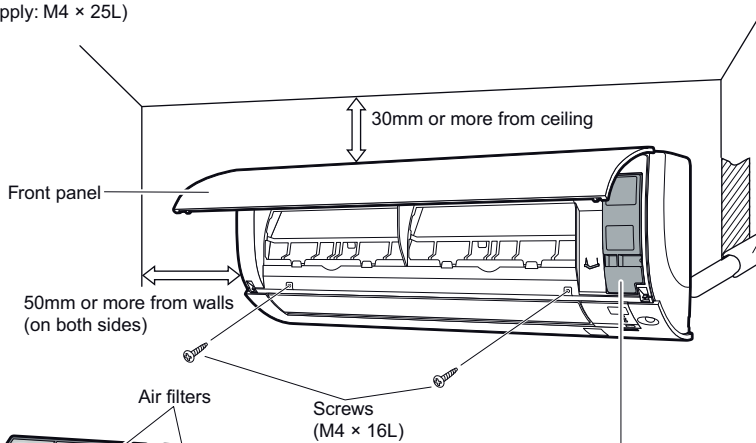

Caulk pipe hole gap with putty.

Cut thermal insulation pipe to an appropriate length and wrap it with tape, making sure that no gap is left in the insulation pipe's cut line.

Wrap the insulation pipe with the finishing tape from bottom to top.

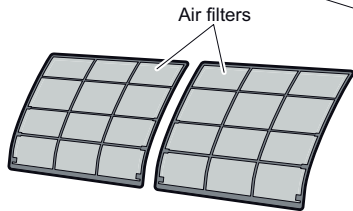

Screws
(M4 × 16L)

Service lid

- **Opening service lid**
Service lid is removable.
- **Opening method**
 - 1) Remove the service lid screw.
 - 2) Pull out the service lid diagonally down in the direction of the arrow.
 - 3) Pull down.

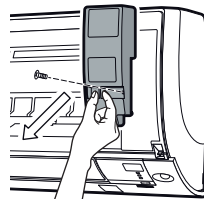

(B) Titanium apatite deodorizing filter (2 pcs)

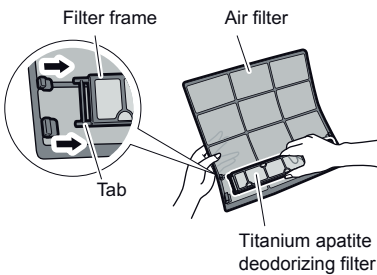

(C) Wireless remote controller

Before screwing the remote controller holder to the wall, make sure that control signals are properly received by indoor unit.

Fixing screw for remote controller holder
(field supply: M3 × 20L)

(D) Remote controller holder

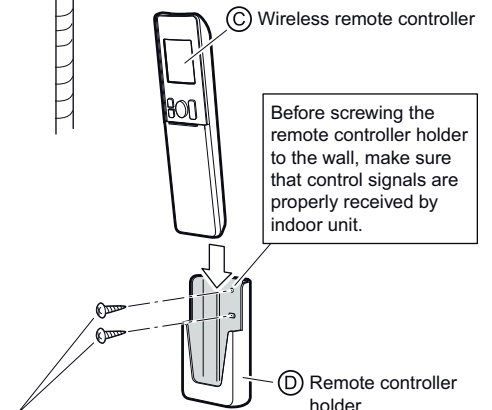

Indoor Unit Installation

1. Installing the mounting plate

- The mounting plate should be installed on a wall which can support the weight of the indoor unit.
- Temporarily secure the mounting plate to the wall, make sure that the panel is completely level, and mark the boring points on the wall.
 - Secure the mounting plate to the wall with screws.

Recommended mounting plate retention spots and dimensions

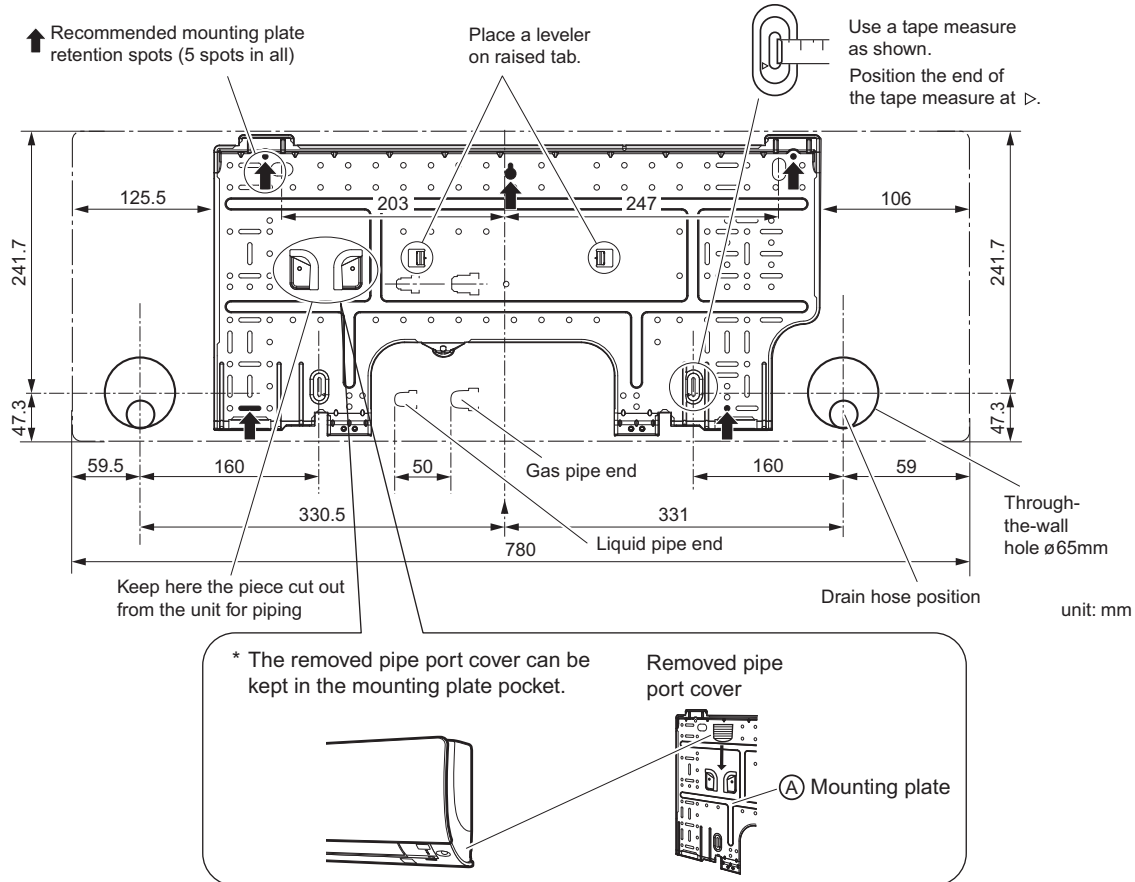

2. Boring a wall hole and installing wall embedded pipe

- For walls containing metal frame or metal board, be sure to use a wall embedded pipe and wall cover in the feed-through hole to prevent possible heat, electrical shock, or fire.
 - Be sure to caulk the gaps around the pipes with caulking material to prevent water leakage.
- Bore a feed-through hole of 65mm in the wall so it has a down slope toward the outside.
 - Insert a wall pipe into the hole.
 - Insert a wall cover into wall pipe.
 - After completing refrigerant piping, wiring, and drain piping, caulk pipe hole gap with putty.

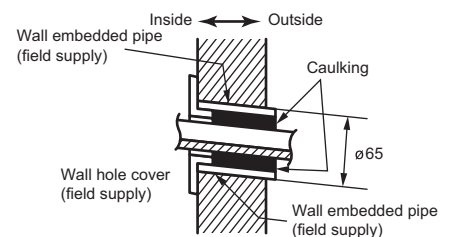

3. Installing the indoor unit

- In the case of bending or curing refrigerant pipes, keep the following precautions in mind.
- Abnormal sound may be generated if improper work is conducted.
- Do not strongly press the refrigerant pipes onto the bottom frame.
 - Do not strongly press the refrigerant pipes on the front grille, either.

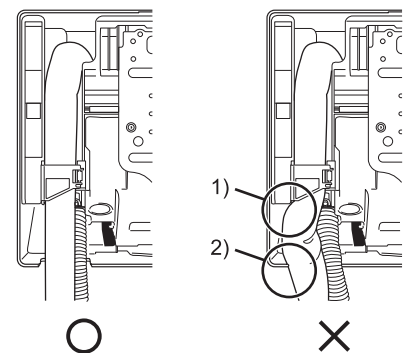

Indoor Unit Installation

- Remove the pipe port cover as shown below.
- 1) Cut off the pipe port cover from inside the front grille using a coping saw.
Apply the blade of the coping saw to the notch, and cut off the pipe port cover along the slit.
 - 2) After cutting off the pipe port cover, perform filing. Remove the burrs along the cut section using a half round needle file.

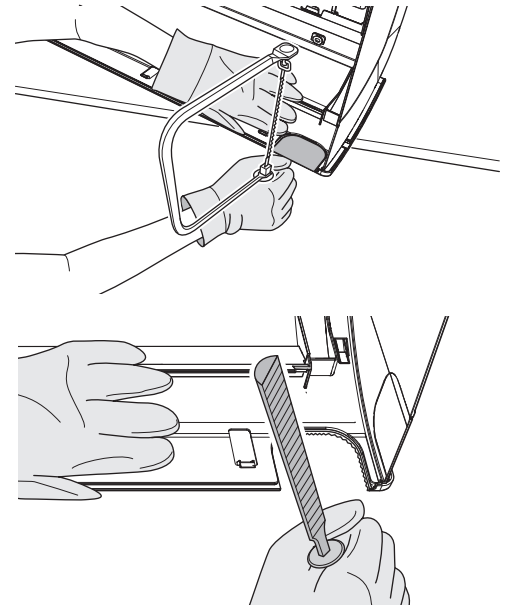

CAUTION

- If the pipe port cover is cut off using nippers, the front grille will be damaged. Please do not use nippers.
- Wear gloves during the pipe port cover removal.

3-1. Right-side, right-back, or right-bottom piping

- 1) Attach the drain hose to the underside of the refrigerant pipes with adhesive vinyl tape.
- 2) Wrap the refrigerant pipes and drain hose together with insulation tape.

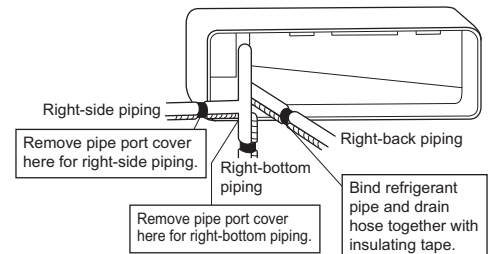

- 3) Pass the drain hose and refrigerant pipes through the wall hole, then set the indoor unit on the mounting plate hooks by using the Δ markings at the top of the indoor unit as a guide.

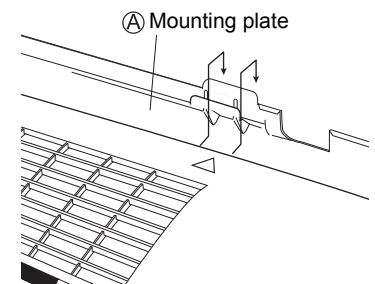

- 4) Open the front panel, then open the service lid.
(Refer to preparation before installation.)
- 5) Pass the inter-unit wire from the outdoor unit through the feed-through wall hole and then through the back of the indoor unit. Pull them through the front side. Bend the ends of tie wires upward for easier work in advance. (If the inter-unit wire ends are to be stripped first, bundle wire ends with adhesive tape.)
- 6) Press the bottom frame of the indoor unit with both hands to set it on the mounting plate hooks. Make sure the wires do not catch on the edge of the indoor unit.

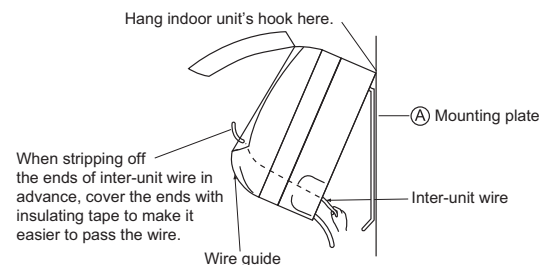

Indoor Unit Installation

3-2. Left-side, left-back, or left-bottom piping

How to replace the drain plug and drain hose

- **Replacing onto the left side**
 - 1) Remove the insulation fixing screw on the right and remove the drain hose.
 - 2) Remove the drain plug on the left side and attach it to the right side.
 - 3) Insert the drain hose and tighten with included insulation fixing screw.
 - * (Forgetting to tighten this may cause water leakages.)

Drain hose attachment position
* The drain hose is on the back of the unit.

- 1) Attach the drain hose to the underside of the refrigerant pipes with adhesive vinyl tape.

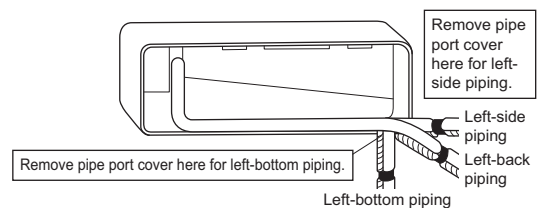

- 2) Be sure to connect the drain hose to the drain port in place of a drain plug.

How to set drain plug

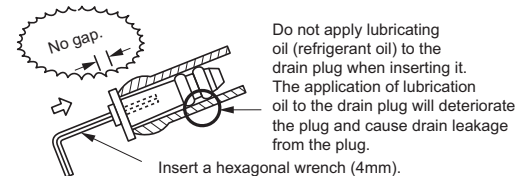

- 3) Shape the refrigerant pipes along the pipe path marking on the mounting plate.
- 4) Pass the drain hose and refrigerant pipes through the wall hole, then set the indoor unit on mounting plate hooks, using the Δ markings at the top of the indoor unit as a guide.
- 5) Pull in the inter-unit wire.
- 6) Connect the inter-unit pipes.

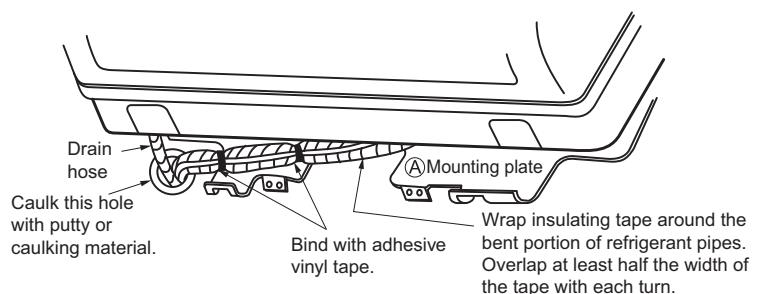

- 7) Wrap the refrigerant pipes and drain hose together with insulation tape as shown in the figure on the right (in case of setting the drain hose through the back of the indoor unit).
- 8) While exercising care so that the inter-unit wire does not catch indoor unit, press the bottom edge of indoor unit with both hands until it is firmly caught by the mounting plate hooks. Secure indoor unit to the mounting plate with indoor unit fixing screws (M4 × 12L).

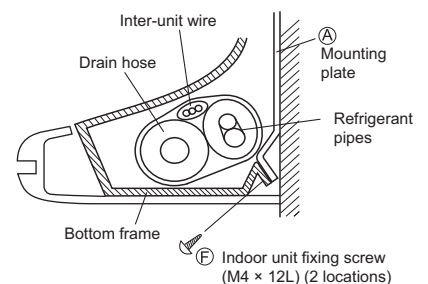







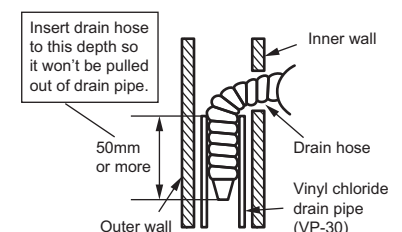







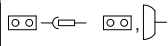

3-3. Wall embedded piping

Follow the instructions given under left-side, left-back, or left-bottom piping.

- 1) Insert the drain hose to this depth so it won't be pulled out of the drain pipe.



Wiring diagram

Unified Wiring Diagram Legend			
For applied parts and numbering refer to the wiring diagram sticker supplied on the unit. Part numbering is realized by Arabic numbers in ascending order for each part and is represented in the overview below by symbol ^{**} in the part code.			
	: CIRCUIT BREAKER		: PROTECTIVE EARTH
	: CONNECTION		: PROTECTIVE EARTH (SCREW)
	: CONNECTOR		: RECTIFIER
	: EARTH		: RELAY CONNECTOR
	: FIELD WIRING		: SHORT CIRCUIT CONNECTOR
	: FUSE		: TERMINAL
	: INDOOR UNIT		: TERMINAL STRIP
	: OUTDOOR UNIT		: WIRE CLAMP
BLK : BLACK	GRN : GREEN	PNK : PINK	WHT : WHITE
BLU : BLUE	GRY : GREY	PRP, PPL : PURPLE	YLW : YELLOW
BRN : BROWN	ORG : ORANGE	RED : RED	
A*P : PRINTED CIRCUIT BOARD	PS : SWITCHING POWER SUPPLY		
BS* : PUSH BUTTON ON / OFF, OPERATION SWITCH	PTC* : THERMISTOR PTC		
BZ, H*O : BUZZER	Q* : INSULATED GATE BIPOLAR TRANSISTOR (IGBT)		
C* : CAPACITOR	Q*DI : EARTH LEAK CIRCUIT BREAKER		
AC*, CN*, E*, HA*, HE, HL*, HN*, HR*, MR*_A, MR*_B, S*, U, V, W, X*A : CONNECTION, CONNECTOR	Q*L : OVERLOAD PROTECTOR		
D*, V*D : DIODE	Q*M : THERMO SWITCH		
DB* : DIODE BRIDGE	R* : RESISTOR		
DS* : DIP SWITCH	R*T : THERMISTOR		
E*H : HEATER	RC : RECEIVER		
F*U, FU* (FOR CHARACTERISTICS REFER TO PCB INSIDE YOUR UNIT)	S*C : LIMIT SWITCH		
FG* : CONNECTOR (FRAME GROUND)	S*L : FLOAT SWITCH		
H* : HARNESS	S*NPH : PRESSURE SENSOR (HIGH)		
H*P, LED*, V*L : PILOT LAMP, LIGHT EMITTING DIODE	S*NPL : PRESSURE SENSOR (LOW)		
HAP : LIGHT EMITTING DIODE (SERVICE MONITOR GREEN)	S*PH, HPS* : PRESSURE SWITCH (HIGH)		
HIGH VOLTAGE : HIGH VOLTAGE	S*PL : PRESSURE SWITCH (LOW)		
IES : INTELLIGENT EYE SENSOR	S*T : THERMOSTAT		
IPM* : INTELLIGENT POWER MODULE	S*W, SW* : OPERATION SWITCH		
K*R, KCR, KFR, KHuR : MAGNETIC RELAY	SA* : SURGE ARRESTOR		
L : LIVE	SR*, WLU : SIGNAL RECEIVER		
L* : COIL	SS* : SELECTOR SWITCH		
L*R : REACTOR	SHEET METAL : TERMINAL STRIP FIXED PLATE		
M* : STEPPER MOTOR	T*R : TRANSFORMER		
M*C : COMPRESSOR MOTOR	TC, TRC : TRANSMITTER		
M*F : FAN MOTOR	V*, R*V : VARISTOR		
M*P : DRAIN PUMP MOTOR	V*R : DIODE BRIDGE		
M*S : SWING MOTOR	WRC : WIRELESS REMOTE CONTROLLER		
MR*, MRCW*, MRM*, MRN* : MAGNETIC RELAY	X* : TERMINAL		
N : NEUTRAL	X*M : TERMINAL STRIP (BLOCK)		
n = * : NUMBER OF PASSES THROUGH FERRITE CORE	Y*E : ELECTRONIC EXPANSION VALVE COIL		
PAM : PULSE-AMPLITUDE MODULATION	Y*R, Y*S : REVERSING SOLENOID VALVE COIL		
PCB* : PRINTED CIRCUIT BOARD	Z*C : FERRITE CORE		
PM* : POWER MODULE	ZF, Z*F : NOISE FILTER		

CAUTION

Note that operation will restart automatically if the main power supply is turned off and then back on again.

HIGH VOLTAGE – be sure to discharge the capacitor completely before repair work.

Risk of failure or water leakage! Do not wash the inside of the air conditioner by yourself.

Indoor Unit Installation

4. Wiring

- 1) Strip wire ends (15mm).
- 2) Match wire colours with terminal numbers on indoor and outdoor unit's terminal blocks and firmly screw wires to the corresponding terminals.
- 3) Connect the earth wires to the corresponding terminals.
- 4) Pull wires to make sure that they are securely latched up, then retain wires with wire retainer.
- 5) Shape the wires so that the service lid fits securely, then close service lid.

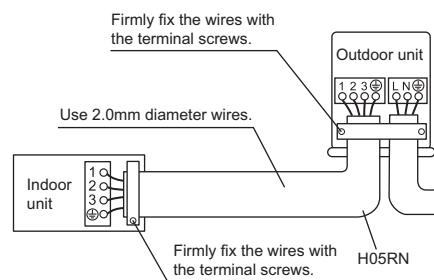
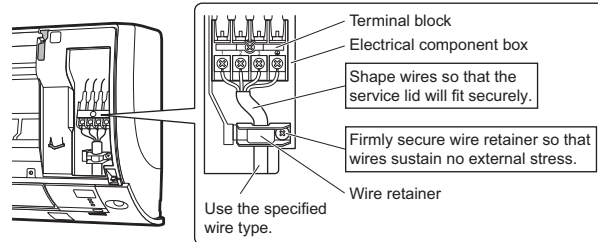

WARNING

- Do not use tapped wires, stranded wires, extension cords, or starburst connections, as they may cause overheating, electrical shock, or fire.
- Do not use locally purchased electrical parts inside the product. (Do not branch the power for the drain pump, etc., from the terminal block.) Doing so may cause electric shock or fire.
- Do not connect the power wire to the indoor unit. Doing so may cause electric shock or fire.

5. When connecting to a wired remote controller

* If work space is available on the right side of the indoor unit, the work can be performed with the electrical component box attached. Omit the steps involved with removing and installing the electrical component box in order to perform the work more efficiently.

5-1. Remove the front grille (2 screws).

5-2. Remove the service lid (1 screw).

5-3. Remove the cover from the electrical component box [Figure 1].

* **5-4. Remove the electrical component box.**

- 1) Remove the flap.
- 2) Disconnect the inter-unit wire
- 3) Disconnect the connector (S200).
- 4) Remove the thermistor from the heat exchanger.
- 5) Remove the earth wire.
- 6) Remove the electrical component box installation screw (1 screw).

Figure 1: Removing the cover from the electrical component box

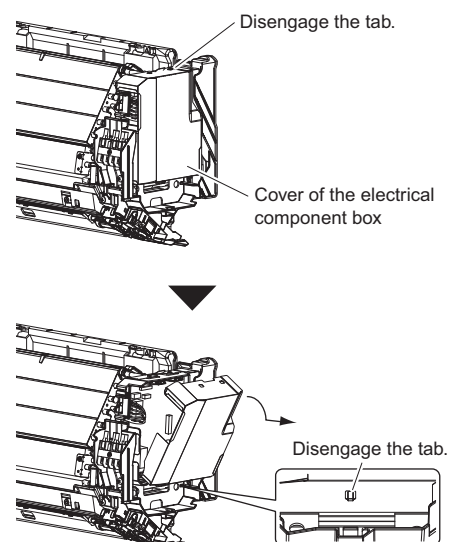

Indoor Unit Installation

5-5. Prepare the accessory (optional parts) [Figure 2].

- 1) Remove the cover from the accessory (optional parts).
- 2) Insert the connection cord into connector "S21" (white) in the accessory (optional parts).
- 3) Route each of the connection cords through the cut-outs in the accessory, then reinstall the accessory cover in its original position.
- 4) Insert the accessory (optional parts) connector into connector "S403" in the electrical component box. Then route the connection cord through the cut-out in the electrical component box.

5-6. Install the cover of the electrical component box in its original position [Figure 3].

5-7. Install the accessory (optional parts) [Figure 3].

- 1) Install the accessory (optional parts) into the electrical component box.
- 2) Route the connection cord as shown in [Figure 3].

5-8. Install the electrical component box in its original position.

- 1) Install the electrical component box (1 screw).
- 2) Install the thermistor in its original position on the heat exchanger.
- 3) Connect the earth wire.
- 4) Install the connector (S200) in its original position.
- 5) Connect the inter-unit wire in its original position.
- 6) Install the flap.

5-9. Install the front grille in its original position (2 screws).

5-10. Install the service lid (1 screw).

Figure 2: Preparing the accessory

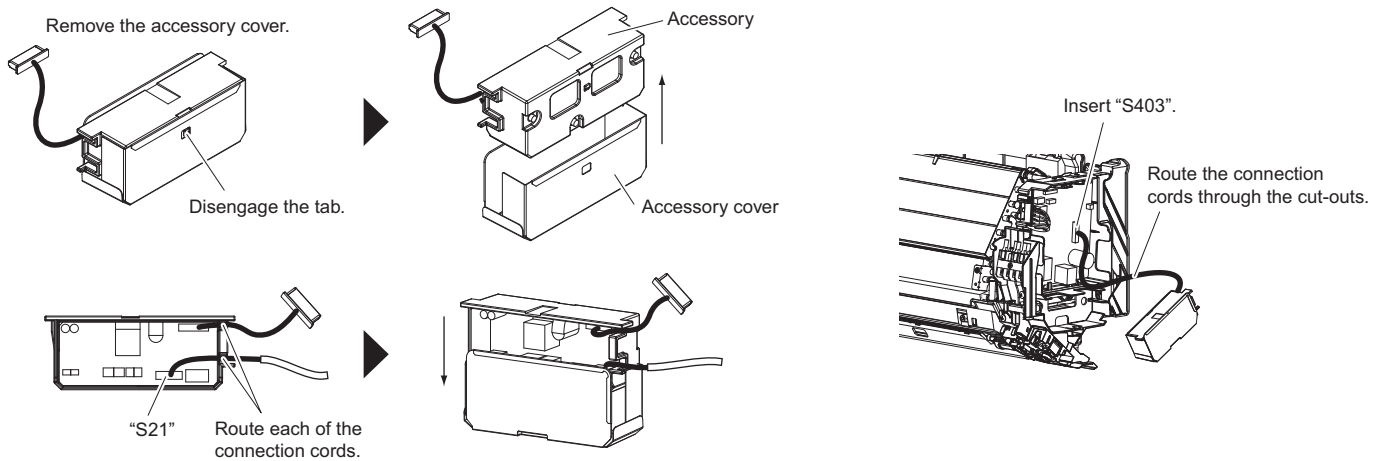
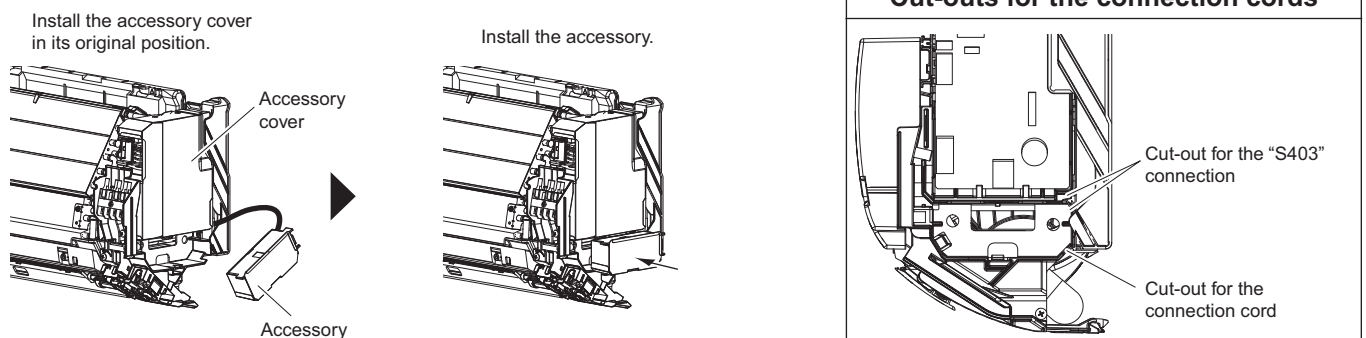

Figure 3: Installing the accessory



Indoor Unit Installation

6. Drain piping

1) Connect the drain hose, as described right.

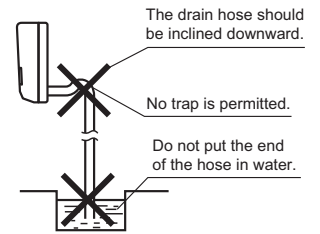

2) Remove the air filters and pour some water into the drain pan to check the water flows smoothly.

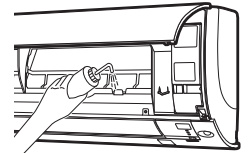

3) If drain hose extension or embedded drain piping is required, use appropriate parts that match the hose front end. [Figure of hose front end]

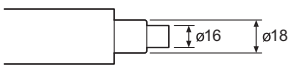

4) When extending the drain hose, use a commercially available extension hose with an inner diameter of 16mm. Be sure to thermally insulate the indoor section of the extension hose.

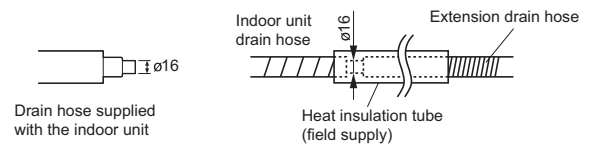

5) When connecting a rigid polyvinyl chloride pipe (nominal diameter 13mm) directly to the drain hose attached to the indoor unit as with embedded piping work, use any commercially available drain socket (nominal diameter 13mm) as a joint.

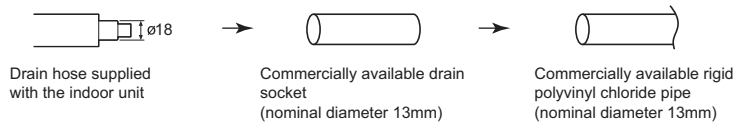

Refrigerant Piping Work

1. Flaring the pipe end

- 1) Cut the pipe end with a pipe cutter.
- 2) Remove burrs with the cut surface facing downward so that the chips do not enter the pipe.
- 3) Put the flare nut on the pipe.
- 4) Flare the pipe.
- 5) Check that the flaring is properly made.



Set exactly at the position shown below.

A	Flaring	
	Flare tool for R410A	Conventional flare tool
	Clutch-type	(Rigid-type) (Imperial-type)
	0-0.5mm	1.0-1.5mm 1.5-2.0mm

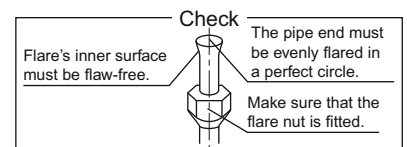

⚠ WARNING

- Do not use mineral oil on flared part.
- Prevent mineral oil from getting into the system as this would reduce the lifetime of the units.
- Never use piping which has been used for previous installations. Only use parts which are delivered with the unit.
- Never install a dryer to this R410A unit in order to guarantee its lifetime.
- The drying material may dissolve and damage the system.
- Incomplete flaring may cause refrigerant gas leakage.

Refrigerant Piping Work

2. Refrigerant piping

⚠ CAUTION

- Use the flare nut fixed to the main unit. (To prevent cracking of the flare nut by aged deterioration.)
- To prevent gas leakage, apply refrigeration oil only to the inner surface of the flare. (Use refrigeration oil for R410A.)
- Use torque wrenches when tightening the flare nuts to prevent damage to the flare nuts and gas leakage.

Align the centres of both flares and tighten the flare nuts 3 or 4 turns by hand. Then tighten them fully with the torque wrenches.

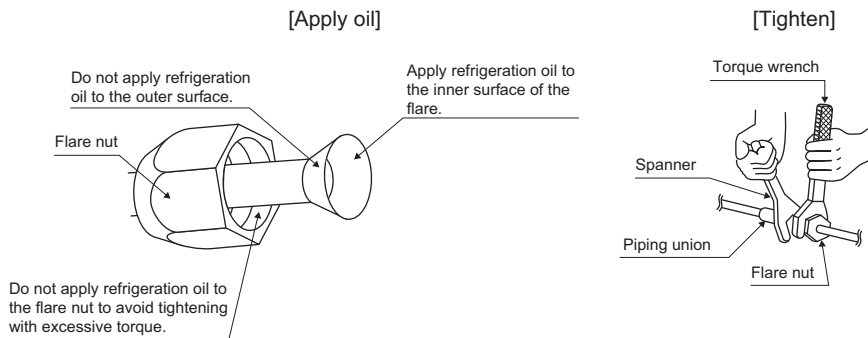

Flare nut tightening torque	
Gas side	Liquid side
3/8 inch	1/4 inch
32.7-39.9N • m (330-407kgf • cm)	14.2-17.2N • m (144-175kgf • cm)

2-1. Caution on piping handling

- 1) Protect the open end of the pipe against dust and moisture.
- 2) All pipe bends should be as gentle as possible. Use a pipe bender for bending.

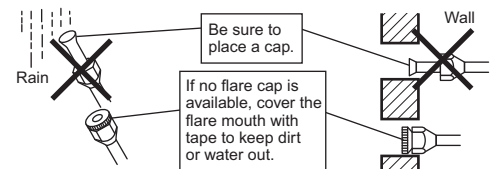

2-2. Selection of copper and heat insulation materials

- When using commercial copper pipes and fittings, observe the following:
 - 1) Insulation material: Polyethylene foam
Heat transfer rate: 0.041 to 0.052W/mK (0.035 to 0.045kcal/mh°C)
Refrigerant gas pipe's surface temperature reaches 110°C max.
Choose heat insulation materials that will withstand this temperature.

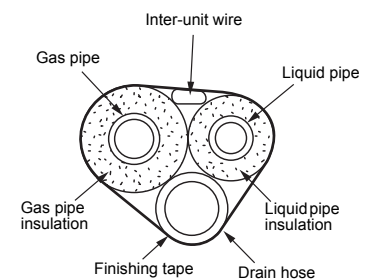

- 2) Be sure to insulate both the gas and liquid piping and to provide insulation dimensions as below.

Gas side	Liquid side	Gas pipe thermal insulation	Liquid pipe thermal insulation
O.D. 9.5mm	O.D. 6.4mm	I.D. 12-15mm	I.D. 8-10mm
Minimum bend radius		Thickness 10mm Min.	
30mm or more			
Thickness 0.8mm (C1220T-O)			

- 3) Use separate thermal insulation for gas and liquid refrigerant pipes.

Trial Operation and Testing

1. Trial operation and testing

1-1 Measure the supply voltage and make sure that it falls in the specified range.

1-2 Trial operation should be carried out in either cooling or heating mode.

- In cooling mode, select the lowest programmable temperature; in heating mode, select the highest programmable temperature.
 - 1) Trial operation may be disabled in either mode depending on the room temperature. Use the remote controller for trial operation as described below.
 - 2) After trial operation is complete, set the temperature to a normal level (26°C to 28°C in cooling mode, 20°C to 24°C in heating mode).
 - 3) For protection, the system disables restart operation for 3 minutes after it is turned off.

1-3 Carry out the test operation in accordance with the operation manual to ensure that all functions and parts, such as louver movement, are working properly.

- The air conditioner requires a small amount of power in its standby mode. If the system is not to be used for some time after installation, shut off the circuit breaker to eliminate unnecessary power consumption.
- If the circuit breaker trips to shut off the power to the air conditioner, the system will restore the original operation mode when the circuit breaker is opened again.

Trial operation from remote controller

- 1) Press "ON/OFF" button to turn on the system.
- 2) Press "TEMP" button (2 locations) and "MODE" button at the same time.
- 3) Press "TEMP" button and select "7".
- 4) Press "MODE" button.
- 5) Trial operation terminates in approx. 30 minutes and switches into normal mode. To quit a trial operation, press "ON/OFF" button.

2. Test items

Test items	Symptom (diagnostic display on RC)	Check
Indoor and outdoor units are installed properly on solid bases.	Fall, vibration, noise	
No refrigerant gas leaks.	Incomplete cooling/heating function	
Refrigerant gas and liquid pipes and indoor drain hose extension are thermally insulated.	Water leakage	
Draining line is properly installed.	Water leakage	
System is properly earthed.	Electrical leakage	
The specified wires are used for inter-unit wiring.	Inoperative or burn damage	
Indoor or outdoor unit's air inlet or air outlet has clear path of air.	Incomplete cooling/heating function	
Stop valves are opened.	Incomplete cooling/heating function	
Indoor unit properly receives remote control commands.	Inoperative	
☀ will appear when the MODE button is pressed.*	No heating	

* If the ☀ is not displayed, change the dipswitch setting for the remote controller.

Slide the dipswitch to the left-hand side.

Press the MODE button again and check that ☀ appears on the LCD of the remote controller.

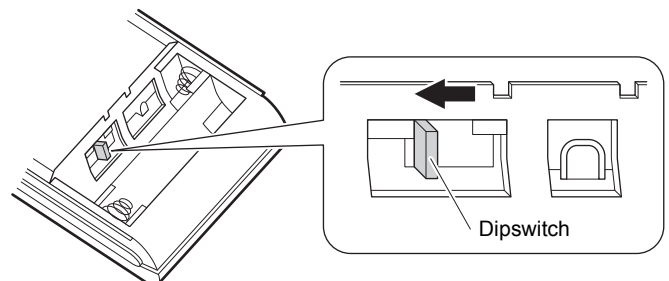

DAIKIN INDUSTRIES, LTD.

Head office:
Umeda Center Bldg., 2-4-12, Nakazaki-Nishi,
Kita-ku, Osaka, 530-8323 Japan

Tokyo office:
JR Shinagawa East Bldg., 2-18-1, Konan,
Minato-ku, Tokyo, 108-0075 Japan
http://www.daikin.com/global_ac/

DAIKIN EUROPE N.V.

Zandvoordestraat 300, B-8400 Oostende, Belgium

DAIKIN INDUSTRIES CZECH REPUBLIC s.r.o.

U Nové Hospody 1/1155, 301 00 Plzeň Skvrňany, Czech Republic

Copyright 2013 Daikin