

DAIKIN



INSTALLATION MANUAL

Split System air conditioners

REQ71B8V3B
REQ100B8V3B

REQ71B8W1B
REQ100B8W1B
REQ125B8W1B

	↖	↗	↘	↙		A	B1	B2	C	D1	D2	E	L1/L2	
	✓						≥50(100)							
	✓		✓	✓		≥100	≥100		≥100					
	✓				✓		≥100				≤500	≥1000		
	✓		✓	✓	✓	≥150	≥150		≥150		≤500	≥1000		
		✓									≥500			
		✓									≤500	≥500	≥1000	
	✓	✓				L1<L2	≥50(100)				≥500			
						L2<L1	≥50(100)				≥500			
						L1<L2	L1≤H	≥150(250)	≤500		≥750		≥1000	0<L1≤1/2H 0<L1≤1/2H
	✓	✓			✓	H<L1	L1≤H							
					L2<L1	L2≤H	≥50(100) ≥100(200)			≥500 (1000)	≥500	≥1000	0<L2≤1/2H 1/2H<L2≤H	
					H<L2	L2≤H								
	✓		✓	✓		≥200	≥200(300)		≥1000					
	✓		✓	✓	✓	≥200	≥200(300)		≥1000		≤500	≥1000		
		✓									≥1000			
		✓			✓				≤500		≥1000	≥1000		
	✓	✓				L1<L2	≥200(300)				≥1000			
						L2<L1	≥150(250) ≥200(300)				≥1000 (1500)			0<L2≤1/2H 1/2H<L2≤H
						L1<L2	L1≤H	≥200(300)	≤500		≥1000		≥1000	0<L1≤1/2H 1/2H<L1≤H
	✓	✓			✓	H<L1	L1≤H							
						L2<L1	L2≤H	≥150(250) ≥200(300)			≥1000 (1500)	≤500	≥1000	0<L2≤1/2H 1/2H<L2≤H
						H<L2	L2≤H							

1

1

1

2

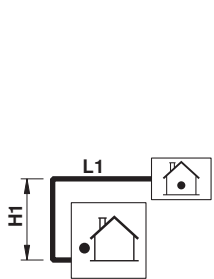

2

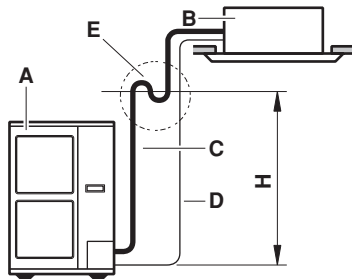

3

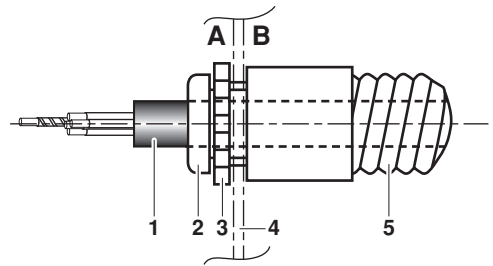

4

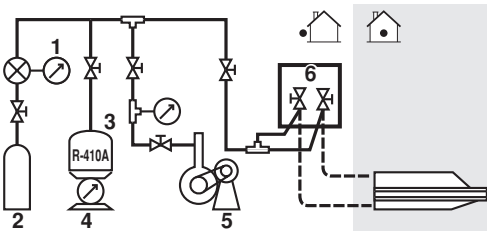

5

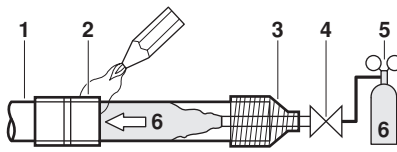

6

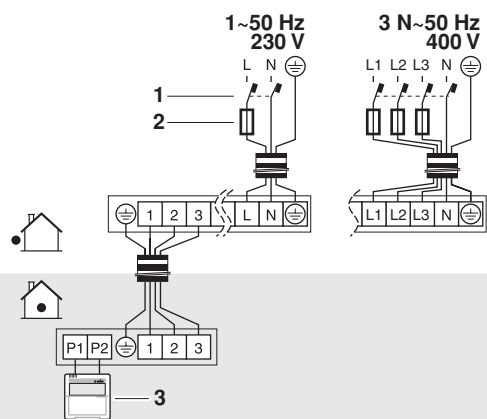

7

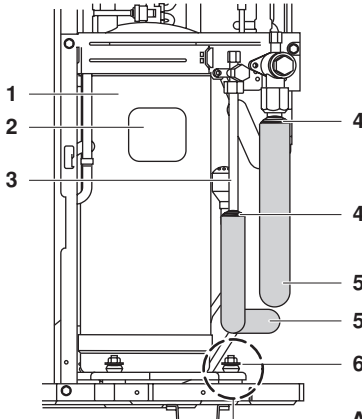

8

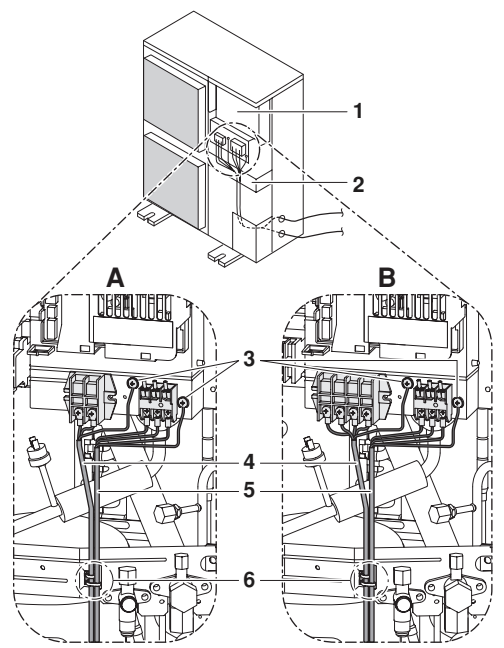

9

CE - DECLARATION-OF-COMFORMITY
CE - KONFORMITÄTSPERKLÄRUNG
CE - DECLARATION-DE-CONFORMITE
CE - CONFORMITEITS/VERKLARING

CE - DECLARACION-DE-CONFORMIDAD
CE - DICHIARAZIONE-DE-CONFORMITA
CE - ΔΗΛΩΣΗ ΣΥΜΜΟΡΦΩΣΗΣ

CE - DECLARAÇÃO-DE-CONFORMIDADE
CE - ЗАРЯВЛЕНИЕ-О-СОТВЕТСТВИИ
CE - OPEVĽIENIE/SERKLARING
CE - FÖRSÄKRAN-OM-ÖVERENSÄMMELSE

CE - IZJAVA-O-USKLABENOSTI
CE - ILMOITUS-YHDENMUUKAISLUDESTA
CE - DEKLARACJA-ZGODNOSCI
CE - DECLARAȚIE-DE-CONFORMITATE

CE - IZJAVA O SKLADNOSTI
CE - VASTAVUSDEKLARACIJA
CE - ATBILSTIBAS-DEKLARACIJA
CE - VYHLÁSENIE-ZHODY
CE - UYUMULUK-BİLDİRİSİ

CE - ZAVAVA O SKLADNOSTI
CE - VASTAVUSDEKLARACIJA
CE - ATBILSTIBAS-DEKLARACIJA
CE - VYHLÁSENIE-ZHODY
CE - UYUMULUK-BİLDİRİSİ

Daikin Europe N.V.

- 01 declares under its sole responsibility that the air conditioning models to which this declar ation relates;
- 02 erklärt auf seine alleinige Verantwortung daß die Modelle der Klimaanlage für die diese Erklärung bestimmt ist;
- 03 déclare sous sa seule responsabilité que les appareils (dar conditions visés par la présente déclaration;
- 04 verklaart hierbij op eigen verantwoordelijkheid dat de airconditioning units waarop deze verklaring betrekking heeft;
- 05 declara bajo su única responsabilidad que los modelos de aire acondicionado a los cuales hace referencia la declaración;
- 06 dichiara sotto sua responsabilità che i condizionatori modello a cui è riferita questa dichiarazione;
- 07 δηλώνει με αποκλειστική της ευθύνη ότι τα προϊόντα των κλιματιστικών αεραγωγών στο οποία αναφέρεται η παρούσα δήλωση;
- 08 declara sob sua exclusiva responsabilidade que os modelos de ar condicionado a que esta declaração se refere;
- 09 заявляет исключительно под свою ответственность, что модели кондиционеров воздуха, к которым относится настоящее заявление;

REQ17B8V3B, REQ100B8V3B,
REQ17B8W1B, REQ100B8W1B, REQ125B8W1B

- 01 are in conformity with the following standard(s) or other normative document(s), provided that these are used in accordance with our instructions:
- 02 gemäß den Vorschriften der folgenden Normen oder anderen Normdokument oder -dokumenten entsprechend eingesetzt werden;
- 03 sont conformes à la ou aux norme(s) ou autre(s) document(s) normatif(s), pour autant qu'ils soient utilisés conformément à nos instructions;
- 04 conform de volgende norm(en) of één of meer andere andere document(en) zijn, op voorwaarde dat ze worden gebruikt overeenkomstig onze instructies;
- 05 están en conformidad con la(s) siguiente(s) norma(s) u otro(s) documento(s) normativo(s), siempre que sean utilizados de acuerdo con nuestras instrucciones;
- 06 sono conformi all(i) seguente(i) standard(i) o altro(i) documento(i) a carattere normativo, a patto che vengano usati in conformità alle nostre istruzioni;
- 07 эти аппараты по той или иной модели кондиционирования воздуха, описанной в инструкции, соответствуют следующим нормативным документам, при условии их использования согласно нашим инструкциям;
- 08 conformen met de volgende norm(en) of één of meer andere andere document(en) zijn, op voorwaarde dat ze worden gebruikt overeenkomstig onze instructies;
- 09 are in conformity with the following standard(s) or other normative document(s), provided that these are used in accordance with our instructions:
- 10 onder (paginas) af bestemmelse(n) is;
- 11 enligt villkoren i;
- 12 gilt i henhold til bestemmelserne i;
- 13 noudatkinen määräyksii;
- 14 za dodrženi ustanovení předpisu;
- 15 prema odredbama;
- 16 káveleli ázi;
- 17 zgodnie z postanowieniami Dyrektywy;
- 18 in urma prevederilor;

- 01 Note * as set out in the Technical Construction File DAIKIN.TCF.021 and judged positively by KEIMA according to the Certificate 2024351-QUA.EMC02-4565.
- 02 Hinweis * wie in der Technischen Konstruktionsakte DAIKIN.TCF.021 aufgeführt und von KEIMA positiv ausgerechnet gemäß Zertifikat 2024351-QUA.EMC02-4565.
- 03 Remarque * tel que stipulé dans le Fichier de Construction Technique DAIKIN.TCF.021 et jugé positivement par KEIMA conformément au Certificat 2024351-QUA.EMC02-4565.
- 04 Bemerk * zoals vermeld in het Technisch Constructiebesluit DAIKIN.TCF.021 en in orde beoordeeld door KEIMA overeenkomstig Certificaat 2024351-QUA.EMC02-4565.
- 05 Nota * tal como se expone en el Archivo de Construcción Técnica DAIKIN.TCF.021 y juzgado positivamente por KEIMA según el Certificado 2024351-QUA.EMC02-4565.
- 06 Nota * delineato nel File Tecnico di Costruzione DAIKIN.TCF.021 e giudicato positivamente da KEIMA secondo il Certificato 2024351-QUA.EMC02-4565.
- 07 Způsobnost * dleš jako je popsáno v souboru technické konstrukce DAIKIN.TCF.021 a pozitivně zjišeno KEIMA v souladu s ověřením 2024351-QUA.EMC02-4565.
- 08 Nota * tal como estabelecido no Ficheiro Técnico de Construção DAIKIN.TCF.021 e como o parecer positivo de KEIMA de acordo com o Certificado 2024351-QUA.EMC02-4565.
- 09 Примечание * как указано в досье технического конструирования DAIKIN.TCF.021 и в соответствии с положительным решением KEIMA согласно Сертификату 2024351-QUA.EMC02-4565.

- 10 (8K) erklærer under eneansvar, at klimaanlægmodelerne, som denne deklaration vedrører;
- 11 (8) deklarerer i egenansvar, att luftkonditioneringsmodellerna som berörs av denna deklaration innebär att:
- 12 (K) erklærer et fuldstændigt ansvar for at de luftkonditioneringsmodeller som berøres af denne deklaration innebaerer at:
- 13 (8B) ilmoittaa yksinomaan omalla vastuullaan, että tämän ilmoituksen tarkoituksena on ilmoittaa ilmastointilaitteiden mallit:
- 14 (8Z) prohlásuje ve své plné odpovědnosti, že modely klimatizace, k nimž se tato prohlášení vztahuje;
- 15 (8B) izjavljuje pod sklopno vlastitom odgovornostjo da su modeli klima uređaja na koje se ova izjava odnosi;
- 16 (H) teljes felelősséggel kijelentem, hogy a klímaberendezés modellek, melyekre e nyilatkozat vonatkozik;
- 17 (A) deklarije na vésasj, vylučujúc odpovědnost' za, že modelle klimatizatorů, kterých dotyczy nížejsza deklaracja;
- 18 (8D) declara pe proprie răspundere că aparatele de aer condiționat la care se referă această declarație;

- 08 estão em conformidade com a(s) seguinte(s) norma(s) ou outro(s) documento(s) normativo(s), desde que estes sejam utilizados de acordo com as nossas instruções;
- 09 conformestvutj sledujících normách nebo jinými normativními dokumenty, při ustoviení ich používania súhlasno našimi instrukciami;
- 10 overholder følgende standard(er) eller andre andre retningsreguleringe dokument(er), forudsat at disse anvendes i henhold til vore instruksjoner;
- 11 respektive utningning är utförd i överensstämmelse med och följer följande standard(er) eller andra normgivande dokument, under förutsättning att användning sker i överensstämmelse med våra instruktioner;
- 12 respektive uslyer er i overensstemmelse med følgende standard(er) eller andre normgivende dokument(er), under forudsætning at disse bruges i henhold til våre instruksjoner;
- 13 saazavat sauravlen standarden ja muiden objektivisten dokumentten vaatimuksia edellyttäen, että niitä käytetään ohjeiden mukaisesti;
- 14 za prepočitaku, že jsou využívány v souladu s našimi pokyny, odpovídají následujícím normám nebo normativním dokumentům;
- 15 u skladu sa sledjícím standardom(i)ma) ili drugim normativnim dokumentom(i)ma), uz uvjet da se oni koriste u skladu s našim uputama;

Low Voltage 73/23/EEC
Machinery Safety 99/37/EEC
Electromagnetic Compatibility 89/336/EEC *

- 01 Directives, as amended;
- 02 Direktiven, genmög ändringar;
- 03 Directives, telles que modifiées;
- 04 Richtlijnen, zoals gewijzigd;
- 05 Directivas, según lo emmendado;
- 06 Directive, come da modifica;
- 07 Önyvűk, amek egyrövidítve;
- 08 Directivas, conforme alteração em;
- 09 Dyrektywy, co wszyscy poprawkami;

- 10 Bemerk * som antori den Tekniska Konstruktionsfilen DAIKIN.TCF.021 og positivt vurderet af KEIMA i henhold til Certifikat 2024351-QUA.EMC02-4565.
- 11 Information * utrustningen är utförd enligt den tekniska konstruktionsfilen DAIKIN.TCF.021 som positivt ingår av KEIMA i ett ockst framtåg af Certifikat 2024351-QUA.EMC02-4565.
- 12 Merk * som det fremkommer den Tekniske Konstruktionsfilen DAIKIN.TCF.021 og gennem positiv bedømmelse af KEIMA i følge Serifikatet 2024351-QUA.EMC02-4565.
- 13 Huom * jukka on esillä Teknissäs Asiakirjassa DAIKIN.TCF.021 ja joka KEIMA on hyväksynyt Serifikatissa 2024351-QUA.EMC02-4565.
- 14 Poznámka * jak bylo uvedeno v souboru technické konstrukce DAIKIN.TCF.021 a pozitivně zjišeno KEIMA v souladu s ověřením 2024351-QUA.EMC02-4565.
- 15 Napomena * kako je izloženo u Datojici o tehničkoj konstrukciji DAIKIN.TCF.021 pozitivno ocijenjeno od strane KEIMA prema Certifikatu 2024351-QUA.EMC02-4565.
- 16 Megjegyzés * a(z) DAIKIN.TCF.021 műszaki konstrukciós dokumentáció alapján, a(z) KEIMA igazolta a megjelölt zöponda z archiválva dokumentáció konstrukciójára DAIKIN.TCF.021, pozitívvala öptimá KEIMA i Svaidactem 2024351-QUA.EMC02-4565.
- 17 Uwaga * jako je izloženo u Datojici o tehničkoj konstrukciji DAIKIN.TCF.021 i pozitivno ocijenjeno od strane KEIMA prema Certifikatu 2024351-QUA.EMC02-4565.

3PW25005-8



- 19 (8Z) z vero odgovornostjo izjavlja, da so modeli klimatiskih naprav, na katere se izjava nanaša;
- 20 (8Z) kinnitab oma täieliku vastutuse, et käesoleva deklaratsiooni alla kuuluvad klimaseadmete mudelid;
- 21 (8B) deklaruje na svoj odgovornost, že modelerje klimatiskih instalacij, za korige se odnosi taša deklaracija;
- 22 (U) viskije savo atsakomybę šekiba, kad oro kondicionavimo prietaisų modeliai, kuriems yra taikoma šis deklaracija;
- 23 (U) ar plnu atbildību apliecinu, ka tāškuskaitlto modeļu gaisa kondicionēšaji, uz kuriem attiecas šis deklaracija;
- 24 (8X) vyhlásuje na vlastnú zodpovednosť, že tieto klimatizačné modely, na ktoré sa vzťahuje toto vyhlásenie;
- 25 (8B) lamamen kendi sorumluluğunda omak üzere bu bildirimni ilgili ölçüğü, klima modellerinin aşğıdaki gibi olduğuna beyan eder;

- 16 megjelölnek az alábbi szabvány(ok)nak vagy egyéb irányadó dokumentum(ok)nak, ha azokat előírás szerinti használatjuk;
- 17 spehjaaj vngumi nasledujících norm i jiných dokumentův normalizačných, pod varunkem že užívane są zgodnie z naszymi instrukciami;
- 18 sunt în conformitate cu următoarele (normative) standarde (sau altele) documente (normative), cu condiția ca acestea să fie utilizate în conformitate cu instrucțiunile noastre;
- 19 skladaj z nasledujim standardi in drugimi normativi, pod pogojem, da se uporabljajo v skladu z našimi navodili;
- 20 on vastavuss järgmisle standardileaga või teiste normatiivse dokumenteaga, kui need kasutatakse vastavalt meie juhendile;
- 21 съответстат на следните стандарти или други нормативни документи, при условие, че се използват съгласно нашите инструкции;
- 22 alinka zemau nurobylus standartus ir (arba) kitus norminius dokumentus su sąlyga, kad yra naudojami pagal mūsų nurooymus;
- 23 tad, ja laibai atbilstošj rašajda normatyvum, abiaa serijosešim standartien su citim normatiivem dokumentiem;
- 24 su v zöed s nasledovnyimi normatyvami) alebo jinými (normativnými) dokumentom(i)mi, za prepočitaku, že sa používajú v súlade s našimi navodami;
- 25 úrinim, lalimatlarm za gúre kulanimasa košuluba aşğıdaki standartiar ve nom beiflen beigelere uyumludur;

- 10 Direktive, med senere ændringer;
- 11 Direktiv, med förtagna ändringar;
- 12 Direktive, cö tvereine kävenenira;
- 13 Direktivej, sel lasina kuin ne ovat muutettuna;
- 14 v platném znení;
- 15 Smernice, kako je izmijeneno;
- 16 irányelvék) és módosítások rendelkezései;
- 17 z późniejszych poprawkami;
- 18 Directivelor, cu amendamentele respective;

- 18 Note * conform celor stabilite în Dosarul tehnic de construcție DAIKIN.TCF.021 și apreciate pozitiv de KEIMA în conformitate cu Certificatul 2024351-QUA.EMC02-4565.
- 19 Opomba * kot je dočleno v tehnično masi DAIKIN.TCF.021 in odobreno s strani KEIMA v skladu s certifikatom 2024351-QUA.EMC02-4565.
- 20 Märkus * nagu on määratud tehnilises dokumentatsioonis DAIKIN.TCF.021 ja heaks kiidnud KEIMA järgi vastavalt sertifikaadile 2024351-QUA.EMC02-4565.
- 21 Zabeleška * Sertifikatu 2024351-QUA.EMC02-4565.
- 22 Pasaba * kaip nurodyta techninėje konstrukcijos byloje DAIKIN.TCF.021 ir patvirtinta KEIMA pagal pažymėjimą 2024351-QUA.EMC02-4565.
- 23 Poznámka * ka nálezek technická dokumentácia DAIKIN.TCF.021, atbilstoš KEIMA pozitívvalim öptimam na öplecna serifikats 2024351-QUA.EMC02-4565.
- 24 Poznámka * ako je stanovene v Súbore technickej konstrukcie DAIKIN.TCF.021 a kladne posúdené KEIMA podľa Certifikatu 2024351-QUA.EMC02-4565.
- 25 Not * DAIKIN.TCF.021 tehnik Yapı Dosyasında belirtilmiş gibi ve 2024351-QUA.EMC02-4565 sertifikasına göre KEIMA tarafından olumlu olarak değerlendirilmiştir.

CONTENTS

	<u>Page</u>
Safety considerations	1
Before installation	2
Selecting installation site	3
Precautions on installation	3
Installation servicing space	4
Refrigerant pipe size and allowable pipe length	4
Precautions on refrigerant piping	5
Refrigerant piping	5
Evacuating.....	7
Charging refrigerant	7
Electrical wiring work.....	8
Test operation.....	10
Disposal requirements	10
Wiring diagram	11



READ THESE INSTRUCTIONS CAREFULLY BEFORE INSTALLATION. KEEP THIS MANUAL IN A HANDY PLACE FOR FUTURE REFERENCE.

IMPROPER INSTALLATION OR ATTACHMENT OF EQUIPMENT OR ACCESSORIES COULD RESULT IN ELECTRIC SHOCK, SHORT-CIRCUIT, LEAKS, FIRE OR OTHER DAMAGE TO THE EQUIPMENT. BE SURE ONLY TO USE ACCESSORIES MADE BY DAIKIN WHICH ARE SPECIFICALLY DESIGNED FOR USE WITH THE EQUIPMENT AND HAVE THEM INSTALLED BY A PROFESSIONAL.

IF UNSURE OF INSTALLATION PROCEDURES OR USE, ALWAYS CONTACT YOUR DAIKIN DEALER FOR ADVICE AND INFORMATION.

SAFETY CONSIDERATIONS

The precautions listed here are divided into the following two types. Both cover very important topics, so be sure to follow them carefully.



WARNING If the warning is not observed, it may cause serious casualties.



CAUTION If the caution is not observed, it may cause injury or damage to the equipment.



WARNING

- Ask your dealer or qualified personnel to carry out installation work. Do not install the machine by yourself. Improper installation may result in water leakage, electric shocks or fire.
- Perform installation work in accordance with this installation manual. Improper installation may lead to water leakage, electric shocks or fire.



WARNING

- When a unit is installed in a small room, it is necessary to take measures so that the leaked refrigerant amount does not exceed the limit even if it leaks. As for the measures to prevent the leak from not exceeding the limit, please consult with your distributor. If the leaked amount exceeds the limit, it may cause an oxygen deficiency accident.
- Be sure to use only the specified accessories and parts for installation work. Failure to use the specified parts may result in water leakage, electric shocks, fire, or the unit falling.
- Install the air conditioner on a foundation that can withstand its weight. Insufficient strength may result in the fall of equipment and causing injury.
- Carry out the specified installation work in consideration of strong winds, typhoons, or earthquakes. Improper installation work may result in accidents due to falling of equipment.
- Make certain that all electrical work is carried out by qualified personnel according to the local laws and regulations and this installation manual, using a separate circuit. Insufficient capacity of the power supply circuit or improper electrical construction may lead to electric shocks or fire.
- Make sure that all wiring is secure, using the specified wires and ensuring that external forces do not act on the terminal connections or wires. Incomplete connection or fixing may cause a fire.
- When wiring between the indoor and outdoor units, and wiring the power supply, form the wires so that the frontside panel can be securely fastened. If the frontside panel is not in place, overheat of the terminals, electric shocks or a fire may be caused.
- If refrigerant gas leaks during installation work, ventilate the area immediately. Toxic gas may be produced if refrigerant gas comes into contact with fire.
- After completing the installation work, check to make sure that there is no leakage of refrigerant gas. Toxic gas may be produced if refrigerant gas leaks into the room and comes into contact with a source of fire, such as a fan heater, stove or cooker.
- Before touching electric terminal parts, turn off the power switch.
- Live parts can be easily touched by accident. Do never leave the unit unattended during installation or servicing when the service panel is removed.
- When planning to relocate former installed units, you must first recover the refrigerant after the pumping-down operation. Refer to chapter "Precaution for pumping-down operation" on page 8.
- Do never directly touch any accidental leaking refrigerant. This could result in severe wounds caused by frostbite.



CAUTION

- Ground the air conditioner.
Grounding resistance should be according to national regulations
Do not connect the earth wire to gas or water pipes, lightning conductor or telephone earth wire. 
Incomplete grounding may cause electric shocks.
- Gas pipe.
Ignition or explosion may occur if the gas leaks.
- Water pipe.
Hard vinyl tubes are not effective grounds.
- Lightning conductor or telephone ground wire.
Electric potential may rise abnormally if struck by a lightning bolt.
- Be sure to install an earth leakage breaker.
Failure to install an earth leakage breaker may cause electric shocks and fire.
- Install drain piping according to this installation manual to ensure good drainage, and insulate the pipe to prevent condensation.
Improper drain piping may cause water leakage, and make the furnitures get wet.
- Install the indoor and outdoor units, power wire and connecting wire at least 1 meter away from televisions or radios to prevent image interference or noise.
(Depending on the radio waves, a distance of 1 meter may not be sufficient to eliminate the noise.)
- Do not install the air conditioner in places such as the following:
 - Where there is mist of mineral oil, oil spray or vapor for example a kitchen.
Plastic parts may deteriorate, and cause them to fall out or water to leak.
 - Where corrosive gas, such as sulfurous acid gas, is produced.
Corrosion of copper pipes or soldered parts may cause the refrigerant to leak.
 - Where there is machinery which emits electromagnetic waves.
Electromagnetic waves may disturb the control system, and cause malfunction of the equipment.
 - Where flammable gases may leak, where carbon fiber or ignitable dust is suspended in the air or where volatile flammables, such as thinner or gasoline, are handled.
Such gases may cause a fire.
 - Where the air contains high levels of salt such as that near the ocean.
 - Where voltage fluctuates a lot, such as that in factories.
 - In vehicles or vessels.
 - Where acidic or alkaline vapour is present.

BEFORE INSTALLATION



Since design pressure is 4.15 MPa or 41.5 bar, pipes of larger wall thickness may be required. Refer to "[Selection of piping material](#)" on page 4

Precautions for R410A

- The refrigerant requires strict cautions for keeping the system clean, dry and tight.
 - Clean and dry
Foreign materials (including mineral oils or moisture) should be prevented from getting mixed into the system.
 - Tight
Read "[Precautions on refrigerant piping](#)" on page 5 carefully and follow these procedures correctly.
- Since R410A is a mixed refrigerant, the required additional refrigerant must be charged in its liquid state. (If the refrigerant is in state of gas, its composition changes and the system will not work properly).
- The connected indoor units must be indoor units designed exclusively for R410A.

Installation

- For installation of the indoor unit, refer to the installation manual of the indoor unit.
- Illustrations show a class 125 outdoor unit type. Other types also follow this installation manual.
- Never operate the unit without the thermistor (R3T), burning of the compressor may result.
- Be sure to confirm the model name and the serial no. of the outer (front) plates when attaching/detaching the plates to avoid mistakes.
- When closing the service panels, take care that the tightening torque does not exceed 4.1 N·m.

Handling

As shown in the figure, bring the unit slowly by grabbing the left and right grips.

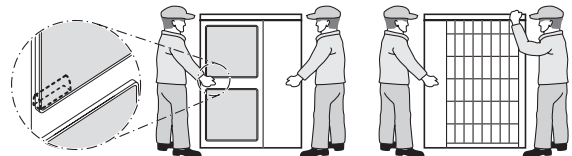

Place your hands on the corner instead of holding the suction inlet in the side of the casing, otherwise the casing could be deformed.

NOTE Take care not to let hands or objects come in contact with rear fins.



SELECTING INSTALLATION SITE



- Make sure to provide for adequate measures in order to prevent that the outdoor unit be used as a shelter by small animals.
- Small animals making contact with electrical parts can cause malfunctions, smoke or fire. Please instruct the customer to keep the area around the unit clean.

- 1 Select an installation site where the following conditions are satisfied and that meets with your customer's approval.
 - Places which are well-ventilated.
 - Places where the unit does not bother next-door neighbours.
 - Safe places which can withstand the unit's weight and vibration and where the unit can be installed level.
 - Places where there is no possibility of flammable gas or product leak.
 - Places where servicing space can be well ensured.
 - Places where the indoor and outdoor units' piping and wiring lengths come within the allowable ranges.
 - Places where water leaking from the unit cannot cause damage to the location (e.g. in case of a blocked drain pipe).
 - Places where rain can be avoided as much as possible.

- 2 When installing the unit in a place exposed to strong wind, pay special attention to the following.

Strong winds of 5 m/sec or more blowing against the outdoor unit's air outlet causes short circuit (suction of discharge air), and this may have the following consequences:

- Deterioration of the operational capacity.
- Frequent frost acceleration in heating operation.
- Disruption of operation due to rise of high pressure.
- When a strong wind blows continuously on the face of the unit, the fan can start rotating very fast until it breaks.

Refer to the figures for installation in a place where the wind direction can be foreseen.

- Turn the air outlet side toward the building's wall, fence or screen.

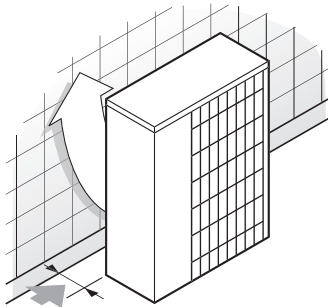

► Make sure there is enough room to do the installation

- Set the outlet side at a right angle to the direction of the wind.

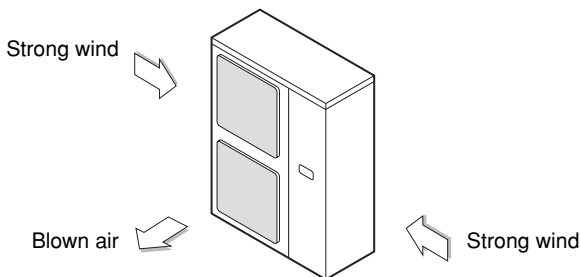

- 3 Prepare a water drainage channel around the foundation, to drain waste water from around the unit.
- 4 If the water drainage of the unit is not easy, please build up the unit on a foundation of concrete blocks, etc. (the height of the foundation should be maximum 150 mm).

- 5 If you install the unit on a frame, please install a waterproof plate within 150 mm of the underside of the unit in order to prevent the invasion of water from the lower direction.
- 6 When installing the unit in a place frequently exposed to snow, pay special attention to the following:
 - Elevate the foundation as high as possible.
 - Remove the rear suction grille to prevent snow from accumulating on the rear fins.
- 7 If you install the unit on a building frame, please install a waterproof plate (within 150 mm of the underside of the unit) or use a drain plug kit (option) in order to avoid the drainwater dripping.

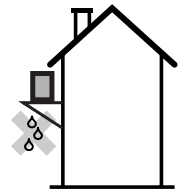

PRECAUTIONS ON INSTALLATION

- Check the strength and level of the installation ground so that the unit will not cause any operating vibration or noise after installation.
- In accordance with the foundation drawing in the figure, fix the unit securely by means of the foundation bolts. (Prepare four sets of M12 foundation bolts, nuts and washers each which are available on the market.)
- It is best to screw in the foundation bolts until their length is 20 mm from the foundation surface.

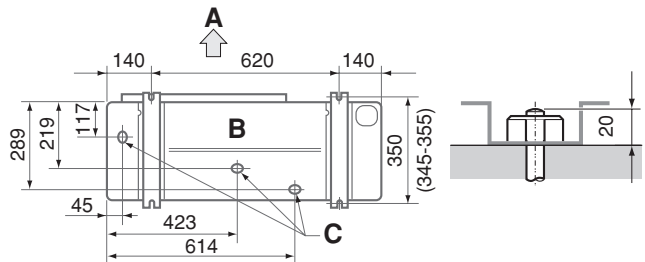

- A Discharge side
- B Bottom view (mm)
- C Drain hole

Installation method for prevention of falling over

If it is necessary to prevent the unit from falling over, install as shown in the figure.

- prepare all 4 wires as indicated in the drawing
- unscrew the top plate at the 4 locations indicated A and B
- put the screws through the nooses and screw them back tight

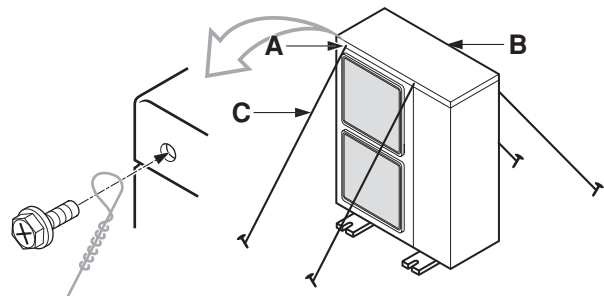

- A location of the 2 fixation holes on the front side of the unit
- B location of the 2 fixation holes on the rear side of the unit
- C wires: field supply

Drain pipe disposal

If drain pipe disposal from the outdoor unit causes trouble, provide the drain piping by using the drain socket (optional).







INSTALLATION SERVICING SPACE

The numerical figures used in here represent the dimensions for the 71-100-125 class models. Figures between () indicate the dimensions for the 100-125 class models. (Unit: mm)

(Refer to "Precautions on installation" on page 3)

Precaution

(A) In case of non-stacked installation (See figure 1)

	Suction side obstacle	✓	Obstacle is present
	Discharge side obstacle	1	In these cases, close the bottom of the installation frame to prevent the discharged air from being bypassed
	Left side obstacle		
	Right side obstacle	2	In these cases, only 2 units can be installed.
	Top side obstacle		This situation is not allowed

(B) In case of stacked installation

- In case obstacles exist in front of the outlet side.

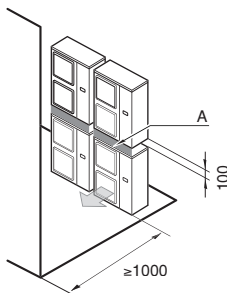

- In case obstacles exist in front of the air inlet.

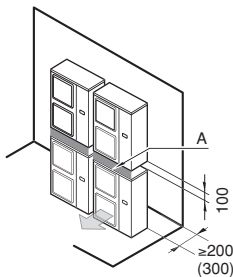

Do not stack more than one unit.

About 100 mm is required as the dimension for laying the upper outdoor unit's drain pipe. Get the portion A sealed so that air from the outlet does not bypass.

(C) In case of multiple-row installation (for roof top use, etc.)

- In case of installing one unit per row.

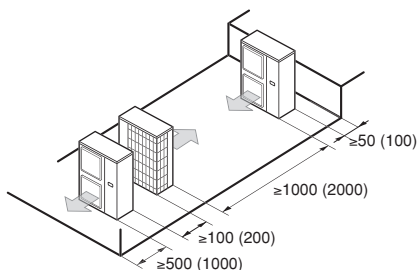

- In case of installing multiple units (2 units or more) in lateral connection per row.

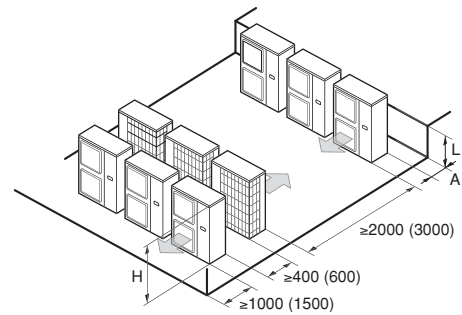

Relation of dimensions of H, A and L are shown in the table below.

	L	A
L ≤ H	0 < L ≤ 1/2H	150 (250)
	1/2H < L	200 (300)
H < L	Installation impossible	

REFRIGERANT PIPE SIZE AND ALLOWABLE PIPE LENGTH



All field piping must be installed by a licensed refrigeration technician and must comply with relevant local and national regulations.

NOTE



To persons in charge of piping work:

- Be sure to open the shut-off valve after installing piping and vacuuming is complete. (Running the system with the valve closed may break the compressor.)
- It is forbidden to discharge refrigerant into the atmosphere. Collect the refrigerant in accordance with relevant local and national regulations.
- Do not use flux when brazing the refrigerant piping. For brazing, use phosphor copper brazing filler metal (BCuP) which does not require a flux. (If a chlorine flux is used, the piping will corrode, and if the flux contains fluoride, it will cause the coolant oil to deteriorate, adversely affecting the coolant piping system.)

Selection of piping material

- Construction material: phosphoric acid deoxidized seamless copper for refrigerant.
- Temper grade: use piping with temper grade in function of the pipe diameter as listed in table below.
- The pipe thickness of the refrigerant piping should comply with relevant local and national regulations. The minimal pipe thickness for R410A piping must be in accordance with the table below.

Pipe Ø	Temper grade of piping material	Minimal thickness t (mm)
9.5	O	0.80
15.9	O	1.20
19.1	1/2H	1

O=Annealed
1/2H=Half hard

Refrigerant pipe size

Pair system (See figure 2)

Refrigerant pipe size			
Gas pipe			
Class	Standard size	Size-up	Liquid pipe
71, 100, 125	Ø15.9	Ø19.1	Ø9.5

Allowable pipe length and height difference

See the table below concerning lengths and heights. Refer to figure 2.

Allowable pipe length		
Maximum allowable piping length (Parenthesized figure represents equivalent length)	L1	50 m (70 m)
Maximum height between indoor and outdoor	H1	30 m
Chargeless length	L1	≤7.5 m

The minimal piping length should be 5 m. If installation is performed with less field piping, the system will be overcharged (abnormal HP, etc.). If the distance between indoor and outdoor unit is less than 5 m, please make sure that the piping length is ≥5 m by additional bending of the pipes.

PRECAUTIONS ON REFRIGERANT PIPING

- Do not allow anything other than the designated refrigerant to get mixed into the freezing cycle, such as air, etc. If any refrigerant gas leaks while working on the unit, ventilate the room thoroughly right away.
- Use R410A only when adding refrigerant
Installation tools:
Make sure to use installation tools (gauge manifold charge hose, etc.) that are exclusively used for R410A installations to withstand the pressure and to prevent foreign materials (e.g. mineral oils and moisture) from mixing into the system.
Vacuum pump:
Use a 2-stage vacuum pump with a non-return valve
Make sure the pump oil does not flow oppositely into the system while the pump is not working.
Use a vacuum pump which can evacuate to -100.7 kPa (5 Torr, -755 mm Hg).
- In order to prevent dirt, liquid or dust from entering the piping, cure the piping with a pinch or taping.

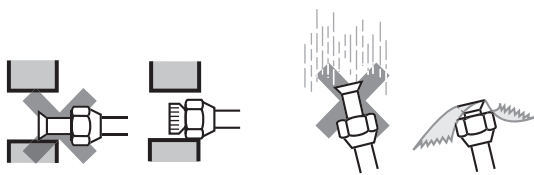

Place	Installation period	Protection method
Outdoor unit	More than a month	Pinch the pipe
	Less than a month	Pinch or tape the pipe
Indoor	Regardless of the period	

Great caution is needed when passing copper tubes through walls.

- When using existing refrigerant piping
Pay attention to the following points when using existing refrigerant piping.

- Perform a visual check on quality of residual oil in existing refrigerant piping.

This check is extremely important because using existing piping with deteriorated oil will cause compressor breakdown.

- Put some residual oil of the pipes you want to reuse on a piece of white paper or on the white surface of an oil checking reference card and compare that oil color with the circled color of the oil checking reference card.
- If oil color is identical to the circled color or darker, replace the piping, install new piping or clean the piping thoroughly.
- If oil color is lighter, the pipes can be reused without cleaning.

An oil checking reference card is indispensable for such evaluation and can be obtained at your dealer.

- In the following situations, the existing piping should not be re-used and new piping should be installed.
 - If the previously used model had problems with its compressor (this might cause oxidized coolant oil, scale residue and other adverse effects).
 - If the indoor or outdoor units were disconnected from the piping for a long period of time (water or dirt might have gotten into the piping).
 - If copper piping is corroded.
- Flares should not be re-used but rather new ones made in order to prevent leaks.
- Check welded connections for gas leaks, if the local piping has welded connections.
- Replace deteriorated insulation with new material.

REFRIGERANT PIPING

- Field pipes can be installed in four directions.

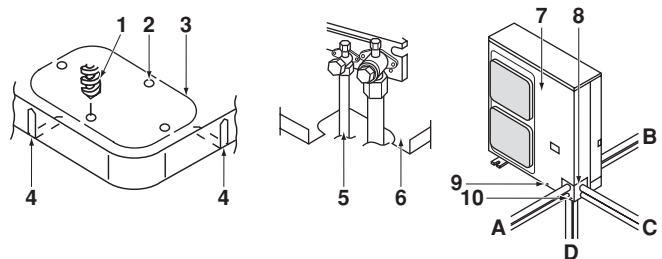

Figure - Field pipes in four directions

- Drill
- Center area around knockout hole
- Knockout hole
- Slit
- Connecting pipe
- Bottom frame
- Front plate
- Pipe outlet plate
- Screw front plate
- Pipe outlet plate screw
- Forward
- Backward
- Sideways
- Downward

- Cutting out the two slits makes it possible to install as shown in the figure "Field pipes in four directions". (Use a metal saw to cut out the slits.)
- To install the connecting pipe to the unit in a downward direction, make a knockout hole by penetrating the center area around the knockout hole using a Ø6 mm drill. (See figure "Field pipes in four directions".)
- After knocking out the knock-out, it is recommended to apply repair paint to the edge and the surrounding end surfaces to prevent rusting.

Preventing foreign objects from entering

Plug the pipe through-holes with putty or insulating material (procured locally) to close up all gaps, as shown in the figure.

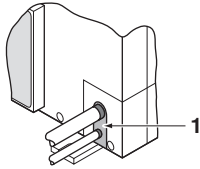

1 Putty or insulating material (produced locally)

Insects or small animals entering the outdoor unit may cause a short circuit in the electrical box.

Cautions for handling stop valve

- The stop valves for indoor-outdoor connecting piping are closed at shipment from the factory.

NOTE Make sure to keep the valve open during operation.



The names of parts of the stop valve are shown in the figure.

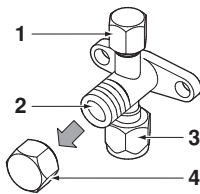

1 Service port
2 Shut-off valve
3 Field piping connection
4 Valve cover

- Since the side boards may be deformed if only a torque wrench is used when loosening or tightening flare nuts, always lock the shut-off valve with a wrench and then use a torque wrench. Do not place wrenches on the valve cover.

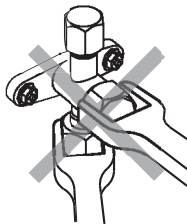

1 Spanner
2 Torque wrench

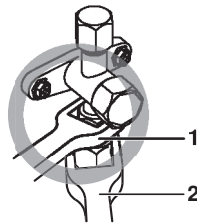

Do not apply force on the valve cover, this may result in a refrigerant leak.

- For cooling operation under low ambient temperature or any other operation under low pressure, apply silicon sealing pad, etc. to prevent the freezing of flare nut gas pipe portion of the stop valve. Refer to the figure.

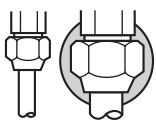

Silicon sealing pad
(Make sure there is no gap)

How to use the shut-off valve

Use hexagonal wrenches 4 mm and 6 mm.

- Opening the valve
 1. Place the hex wrench on the valve bar and turn counter-clockwise.
 2. Stop when the valve bar no longer turns. It is now open.
- Closing the valve
 1. Place the hex wrench on the valve bar and turn clockwise.
 2. Stop when the valve bar no longer turns. It is now closed.

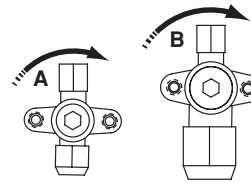

Closing direction

- A Liquid side
B Gas side

Cautions for handling the valve cover

- The valve cover is sealed where indicated by the arrow. Take care not to damage it.

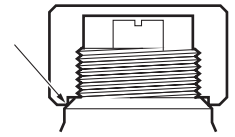

- After operating the valve, be sure to tighten the valve cover properly.

Tightening torque	
Liquid pipe	13.5~16.5 N·m
Gas pipe	22.5~27.5 N·m

- Check for refrigerant leakage after tightening the cap.

Cautions for handling service port

- After the work, tighten the valve cover in place. Tightening torque: 10.8~14.7 N·m

Precautions when connecting field piping and regarding insulation

- Be careful not to let the indoor and outdoor branch piping come into contact with the compressor terminal cover. If the liquid-side piping insulation might come into contact with the compressor terminal cover, adjust the height as shown in figure 8. Also, make sure the field piping does not touch the bolts or outer panels of the compressor.
- When the outdoor unit is installed above the indoor unit the following can occur:
The condensated water on the stop valve can move to the indoor unit. To avoid this, please cover the stop valve with sealing material.
- If the temperature is higher than 30°C and the humidity is higher than RH 80%, then the thickness of the sealing materials should be at least 20 mm in order to avoid condensation on the surface of the sealing.
- Be sure to insulate the liquid and gas-side field piping.

NOTE Any exposed piping may cause condensation or burns if touched.

(The highest temperature that the gas-side piping can reach is around 120°C, so be sure to use insulating material which is very resistant.) (See figure 8)

- 1 Compressor
2 Terminal cover
3 Indoor and outdoor field piping
4 Corking, etc.
5 Insulation material
6 Bolts
A Be careful with pipe, bolt and outer panel connections

Cautions for flare connection

- Please refer to the table for the dimensions for processing flares and for the tightening torques. (Too much tightening will end up in splitting of the flare.)

Piping size	Flare nut tightening torque	A dimensions for processing flares (mm)	Flare shape
Ø9.5	32.7~39.9 N·m (333~407 kgf·cm)	12.8~13.2	
Ø15.9	61.8~75.4 N·m (630~770 kgf·cm)	19.3~19.7	
Ø19.1	97.2~118.6 N·m (989.8~1208 kgf·cm)	23.6~24.0	

- When connecting the flare nut, apply refrigerating machine oil to the flare (inside and outside) and first screw the nut 3 or 4 turns by hand.
Coat here with ether or ester oil.

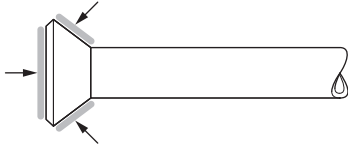

- After completing the installation, carry out a gas leak inspection of the piping connections with nitrogen and such.

Cautions for necessity of a trap

Since there is fear of the oil held inside the riser piping flowing back into the compressor when stopped and causing liquid compression phenomenon, or cases of deterioration of oil return, it will be necessary to provide a trap at an appropriate place in the riser gas piping.

- Trap installation spacing. (See figure 3)

- A Outdoor unit
- B Indoor unit
- C Gas piping
- D Liquid piping
- E Oiltrap
- H Install trap at each difference in height of 15 m.

- A trap is not necessary when the outdoor unit is installed in a higher position than the indoor unit.

Cautions for brazing

- Be sure to carry out a nitrogen blow when brazing.
Brazing without carrying out nitrogen replacement or releasing nitrogen into the piping will create large quantities of oxidized film on the inside of the pipes, adversely affecting valves and compressors in the refrigerating system and preventing normal operation.
- When brazing while inserting nitrogen into the piping, nitrogen must be set to 0.02 MPa with a pressure-reducing valve (=just enough so that it can be felt on the skin). (See figure 6)

- 1 Refrigerant piping
- 2 Part to be brazed
- 3 Taping
- 4 Hands valve
- 5 Pressure-reducing valve
- 6 Nitrogen

EVACUATING

- Do not purge the air with refrigerants. Use a vacuum pump to vacuum the installation. No additional refrigerant is provided for air purging.
- Pipes inside the units were checked for leaks by the manufacturer. The refrigerant pipes fit on site are to be checked for leaks by the installer.
- Confirm that the valves are firmly closed before leak test or vacuuming.

Set up for vacuuming and leak test: (See figure 5)

- 1 Pressure gauge
- 2 Nitrogen
- 3 Refrigerant
- 4 Weighing machine
- 5 Vacuum pump
- 6 Stop valve

Procedure for leak test

Leak test must satisfy EN378-2.

- 1 Evacuate the pipes and check vacuum⁽¹⁾. (No pressure increase for 1 minute.)
- 2 Break the vacuum with a minimum of 2 bar of nitrogen. (Never pressurize more than 4.15 MPa.)
- 3 Conduct leak test by applying soap water, etc. to the connecting part of the pipes.
- 4 Discharge nitrogen.
- 5 Evacuate and check vacuum again⁽¹⁾.
- 6 If vacuum gauge does no longer rise, the stop valves can be opened.

- (1) Use a 2-stage vacuum pump with a non return valve which can evacuate to -100.7 kPa (5 Torr, -755 mm Hg).
Evacuate the system from the liquid and gas pipes by using a vacuum pump for more than 2 hours and bring the system to -100.7 kPa. After keeping the system under that condition for more than one hour, check if the vacuum gauge rises or not. If it rises, the system may either contain moisture inside or have leaks.



Following should be executed if there is a possibility of moisture remaining in the pipe (if piping work is carried out during the raining season or over a long period of time, rainwater may enter the pipe during work).

After evacuating the system for 2 hours, pressurize the system to 0.05 MPa (vacuum break) with nitrogen gas and evacuate the system again using the vacuum pump for 1 hour to -100.7 kPa (vacuum drying). If the system cannot be evacuated to -100.7 kPa within 2 hours, repeat the operation of vacuum break and vacuum drying. Then after leaving the system in vacuum for 1 hour, confirm that the vacuum gauge does not rise.

After air purging with a vacuum pump it may happen that the refrigerant pressure does not rise, not even if the stop valve is opened. Reason for this phenomenon is the closed state of for instance the expansion valve in the outdoor unit circuit, but this is not a problem for running the unit.

CHARGING REFRIGERANT

Important information regarding the refrigerant used

This product contains fluorinated greenhouse gases covered by the Kyoto Protocol. Do not vent gases into the atmosphere.

Refrigerant type: R410A
GWP⁽¹⁾ value: 1975

(1) GWP = global warming potential

Please fill in with indelible ink,

- ① the factory refrigerant charge of the product,
- ② the additional refrigerant amount charged in the field and
- ①+② the total refrigerant charge

on the refrigerant charge label supplied with the product.

The filled out label must be adhered in the proximity of the product charging port (e.g. onto the inside of the service cover).

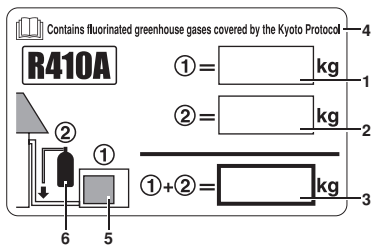

- 1 factory refrigerant charge of the product: see unit name plate
- 2 additional refrigerant amount charged in the field
- 3 total refrigerant charge
- 4 Contains fluorinated greenhouse gases covered by the Kyoto Protocol
- 5 outdoor unit
- 6 refrigerant cylinder and manifold for charging

Precaution for servicing



When performing service on the unit requiring the refrigerant system to be opened, refrigerant must be evacuated according to local regulations.

This unit requires additional charging of refrigerant according to the length of piping connected at the site. Charge the refrigerant to the liquid pipe in its liquid state. Since R410A is a mixed refrigerant, its composition changes if charged in a state of gas and normal system operation would no longer be assured.

On this model it is not necessary to charge additionally if the piping length ≤ 7.5 m.

NOTE Piping length is the 1 way length, gas or liquid.



Additional charging of refrigerant

- Over 7.5 m, please add refrigerant quantity according to the following table.

For future servicing, mark with a circle the selected amount on the table below.

Additional charging amount <unit: kg>

Class	Connected piping length is between		
	7.5~30 m	30~40 m	40~50 m
71	+0.20	+0.70	+1.20
100+125	+0.10	+0.60	+1.10

NOTE In case of complete recharge of the refrigerant, please first execute vacuuming. Execute this vacuuming from the service port. Do not use the port of the stop valve for vacuuming. Vacuuming can not be executed completely using such port.



Position of service port:

Heat pump units have 2 ports on the piping. One between the liquid receiver and the electronic expansion valve and another one between the heat exchanger and the 4-way valve.

Total charging weight of the refrigerant (after a leak, etc.)

When the entire refrigerant pipe length is within 7.5 meters, charge the refrigerant in accordance with the amount mentioned in the nameplate, and when the pipe length exceeds 7.5 meters, the charging amount mentioned in the nameplate and that required for additional charging are to be totalled as the net charging amount.

Precaution for pumping-down operation

The outdoor unit is equipped with a low-pressure switch to protect the compressor.



NOTE Never short-circuit the low pressure switch in this operation.

Take the following steps to perform the pumping-down operation.

Procedure	Precaution
1 Put a pressure gauge at the service port of the gas stop valve.	Use a pressure gauge reserved for R410A exclusively.
2 Start the fan operation with the remote controller.	Confirm that stop valves both on the liquid and gas side are open.
3 Push the pumping-down button on the PC board of the outdoor unit.	Compressor and outdoor fan will start operation automatically. If step 3 is performed before step 2, then the indoor fan may automatically start running. Please pay attention to this.
4 Continue operation for 2 minutes until operation condition stabilizes.	—
5 Close the stop valve on the liquid side securely. (See "How to use the shut-off valve" on page 6)	Insecure closing of the valve may result in burning of the compressor.
6 When the low-pressure switch is activated, the unit stops working. At this time, close the stop valve on the gas side.	—

This is the end of pumping-down operation. After pumping-down operation, the remote controller can show the following:

- "U4"
- blank screen
- indoor fan operates for about 30 seconds

Even when the ON button on the remote controller is pressed, it will not operate. Turn off the main power supply switch and turn it on again in need of operation.

ELECTRICAL WIRING WORK



- All wiring must be performed by an authorized electrician.
- All components procured on the site and all electric construction should comply with the applicable local and national codes.
- High voltage
To avoid electrical shock, make sure to disconnect the power supply 1 minute or more before servicing the electrical parts. Even after 1 minute, always measure the voltage at the terminals of main circuit capacitors or electrical parts and, before touching, make sure that those voltages are 50 V DC or less.



NOTE To persons in charge of electrical wiring work:

Do not operate the unit until the refrigerant piping is complete. (Running it before the piping is ready will break the compressor.)

Precautions on electrical wiring work

- Before obtaining access to terminal devices, all supply circuits must be interrupted.
- Use only copper wires.
- The wiring between the indoor unit and outdoor unit must be for 230 V.
- Do not turn on the main switch until all the wiring is completed. Make sure that the main switch has a contact separation of at least 3 mm in all poles.
- For W1
 - Make sure to connect power supply cables in normal phase. If connected in reverse phase, the remote controller of the indoor unit indicates "U1" and the equipment cannot operate. Change any two of the three power supply cables (L1, L2, L3) to correct phase.
 - If the contact in the magnetic switch should be forcibly turned on while the equipment is inoperative, the compressor will burn out. Never try to forcibly turn on the contact.
- Never squeeze bundled cables into a unit.
- Fix cables so that cables do not make contact with the pipes (especially on high pressure side).
- Secure the electrical wiring with clamping material as shown in [figure 9](#) so that it does not come in contact with the piping, particularly on the high-pressure side. Make sure no external pressure is applied to the terminal connectors.

Secure the wiring in the order shown below.

- 1 Secure the ground wire to the shut-off valve attachment plate so that it does not slide.
 - 2 Secure the ground wire to the shut-off valve attachment plate one more time along with the electric wiring and the inter-unit wiring.
- Lay the electrical wiring so that the front cover does not rise up when doing wiring work and attach the front cover securely. (See [figure 9](#)).
- A V3-type
 - B W1-type
 - 1 Switch box
 - 2 Stop valve mounting plate
 - 3 Ground
 - 4 Power supply and ground wiring
 - 5 Wiring between units
 - 6 Tie-wrap

- When cables are routed from the unit, a protection sleeve for the conduits (PG-insertions) can be inserted at the knock-out hole. (See [figure 4](#))

- A Inside
- B Outside
- 1 Wire
- 2 Bush
- 3 Nut
- 4 Frame
- 5 Hose

When you do not use a wire conduit, be sure to protect the wires with vinyl tubes to prevent the edge of the knock-out hole from cutting the wires.

- Follow the electric wiring diagram for electrical wiring works.
- Form the wires and fix the cover firmly so that the cover may be fit in properly.

Precautions on wiring of power supply and inter-unit wiring

- Use a round crimp-style terminal for connection to the power supply terminal board. In case it cannot be used due to unavoidable reasons, be sure to observe the following instruction.



- Do not connect wires of different gauge to the same power supply terminal. (Looseness in the connection may cause overheating.)
- When connecting wires of the same gauge, connect them according to the figure below.

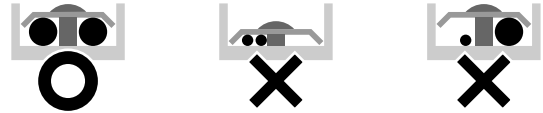

- Use the correct screwdriver to tighten the terminal screws. Small screwdrivers can damage the screw head and prevent appropriate tightening.
- Over-tightening the terminal screws can damage the screws.
- See the table below for tightening torques for the terminal screws.

Tightening torque (N·m)		
M4	(X1M)	1.2~1.8
M5	(X1M)	2.0~3.0
M5	(EARTH)	3.0~4.0

- Refer to the installation manual attached to the indoor unit for wiring of indoor units, etc.
- Attach an earth leakage breaker and fuse to the power supply line. (See [figure 7](#))
 - 1 Earth leakage breaker
 - 2 Fuse
 - 3 Remote controller
- In wiring, make certain that prescribed wires are used, carry out complete connections, and fix the wires so that outside forces are not applied to the terminals.

Specifications of standard wiring components

Power supply				Wire type of wiring between the units
Model	Field fuse	Wire type ⁽¹⁾	Size	
REQ71B8V3B	32 A	H05VV-U3G	Wiring size must comply with the applicable local and national code	H05VV-U4G2.5
REQ100B8V3B	40 A			
REQ71B8W1B	16 A	H05VV-U5G		
REQ100B8W1B				
REQ125B8W1B	20 A			

(1) Only in protected pipes, use H07RN-F when protected pipes are not used.

TEST OPERATION

- Be sure to fully open the liquid-side and gas-side stop valves.
- For details on test operation, refer to the indoor unit installation manual.

Pre-run checks

Items to check	
Electrical wiring Inter-unit wiring Ground wire	<ul style="list-style-type: none"> ■ Is the wiring as mentioned on the wiring diagram? Make sure no wiring has been forgotten and that there are no missing phases or reverse phases. ■ Is the unit properly grounded? ■ Are any of the wiring attachment screws loose?
Refrigerant piping	<ul style="list-style-type: none"> ■ Is the size of the piping appropriate? ■ Is the insulation material for the piping attached securely? Are both the liquid and gas pipes insulated? ■ Are the shut-off valves for both the liquid side and the gas side open?
Extra refrigerant	<ul style="list-style-type: none"> ■ Did you write down the extra refrigerant and the refrigerant piping length?

Test run

- 1 Make sure the liquid and gas shut-off valves are open.

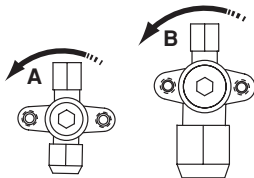

Opening direction

- A Liquid side
B Gas side

Remove the cap and turn counterclockwise with a hex wrench until it stops

Be sure to close the frontside panel before operation, as not doing so can cause electric shock.

- The refrigerant pressure may not rise, even if the shut-off valve is opened after an air purge is performed using a vacuum pump.
This is because the indoor unit refrigerant piping is closed off with electric valves inside. This will not create any problems during operation.
- 2 Be sure to set it to cooling and press the operation switch.
 - 3 Press the inspection/test-run switch on the remote control to put the machine into test-run mode.
 - 4 Make sure the compressor is not starting and stopping during the test-run by listening. If it is starting and stopping, immediately stop the machine using the remote controller, and check the refrigerant level, etc. There may be some sort of malfunction.
 - 5 At first test-run of the unit, the valves are checked if they are not closed. Therefore the unit starts in cooling mode (even if the remote controller is set to heating mode) for about 2-3 minutes and then switches automatically to heating mode. The remote controller will always display heating mode.

Precautions regarding test-runs

- If the remote control shows E0, E3 or E4 as an error code, there is a possibility that either the shut-off valve is closed, or the outlet vent is closed.
- For a reverse phase in case of W1 units, U1 will be displayed on the remote controller of the indoor unit.
For a missing phase in case of W1 units, E0 or E6 will be displayed on the remote controller of the indoor unit.
Operation will be impossible with either one of these phenomena. If this happens, turn off the power, re-check the wiring and switch the position of two of the three electrical wires. (If operation is not possible, do not under any circumstances force the electromagnetic contactor on.)
- If the error code E6 is displayed on the remote controller, check for voltage imbalance.
- If the error code U4 or UF is displayed on the remote controller, check the inter-unit branch wiring connection.

Diagnosis

- On the remote controller LCD
If the machine stops due to some malfunction, you can diagnose the problem using the error code displayed on the remote controller.

Error code	Description
E6	Compressor current overload
J2	Electric current sensor malfunction

- The malfunction code should be looked up in the installation manual for the indoor unit.
- Depending on the indoor unit or outdoor unit type, error codes may not be displayed.

DISPOSAL REQUIREMENTS

Dismantling of the unit, treatment of the refrigerant, of oil and of other parts must be done in accordance with relevant local and national legislation.

WIRING DIAGRAM

 : Field wiring

L : Live

N : Neutral

 : Terminal

 : Connector

 : Protective earth (screw)

 : Short circuit connector

BLK : Black

BLU : Blue

ORG : Orange

RED : Red

WHT : White

YLW : Yellow

A1P Printed circuit board
 BS1 Push button (forced defrost - pump down)
 C1,C2 Capacitor (M1F-M2F)
 C3..... * Capacitor (M1C)
 CT Current transformer (T1A)
 DS1 Selector switch
 E1HC..... Crankcase heater
 F1U,F2U..... Fuse (T6.3/250 V)
 HAP Light emitting diode (green)
 K1M..... Magnetic contactor (M1C)
 K1R Magnetic relay (K1M)
 K2R Magnetic relay (Y2S)
 K3R Magnetic relay (E1HC)
 K4R Magnetic relay (Y1S)
 K5R,K6R,K7R Magnetic relay (M1F)
 K8R,K9R,K10R..** ... Magnetic relay (M2F)
 M1C..... Motor (compressor)
 M1F,M2F Motor (fan)
 PC Power circuit
 Q1DI..... Earth leakage breaker (field supply)(≤30 mA)

Q1M,Q2M..... Thermo switch (M1F-M2F)
 Q1RP..... ##... Phase reverse circuit
 R1T..... Thermistor (air)
 R2T..... Thermistor (coil)
 R3T..... Thermistor (discharge)
 RC Signal receiver circuit
 S1PH..... Pressure switch (HIGH)
 S1PL..... Pressure switch (LOW)
 SD..... Safety devices input
 T1A..... Transformer
 TC..... Signal transmission circuit
 X1M,X2M..... Terminal strip
 Y1E..... Expansion valve (electrical type)
 Y1S..... 4-way valve
 Y2S..... Solenoid valve

* : V3 model only

** : class 125 only

: W1 model only

 **NOTE 1:** Do not operate the unit by short-circuiting S1PL. This would cause compressor failure.
NOTE 2: Confirm the method of setting selector switches in the service manual. Factory setting of all switches are set to be OFF.

SWITCH BOX (OUTDOOR) :
 POSITION OF COMPRESSOR TERMINAL :
 WIRE ENTRANCE :

NOTES

