

Air Conditioning
Technical Data

RZASG-MY1



TABLE OF CONTENTS

RZASG-MY1

1	Features	2
2	Specifications	3
	Capacity and Power input	3
	Capacity and Power input	3
	Capacity and Power input	3
	Capacity and Power input	4
	Capacity and Power input	4
	Capacity and Power input	4
	Technical Specifications	5
	Electrical Specifications	6
3	Electrical data	8
4	Options	10
5	Combination table	11
6	Capacity tables	12
	Cooling/Heating Capacity Tables	12
	Capacity Correction Factor	14
7	Dimensional drawings	15
8	Centre of gravity	16
9	Piping diagrams	17
	Piping Diagrams	17
	Piping Diagram Twin Application	18
	Piping Diagram Triple Application	19
	Piping Diagram Double Twin Application	20
10	Wiring diagrams	21
	Wiring Diagrams - Three Phase	21
11	Sound data	22
	Sound Power Spectrum	22
	Sound Pressure Spectrum - Cooling	24
	Sound Pressure Spectrum - Heating	26
	Sound Pressure Spectrum Quiet Mode	28
12	Installation	30
	Installation Method	30
13	Operation range	32

1 Features

Technology and comfort combined for commercial applications

- High efficiency: - Energy labels up to A++ (cooling) / A+ (heating) - compressor offers substantial efficiency improvements
- Choosing for an R-32 product, reduces the environmental impact with 68% compared to R-410A, leads directly to lower energy consumption thanks to its high energy efficiency and has a lower refrigerant charge
- Very compact and easy to install
- Replace existing systems with R-32 technology without needing to replace the piping
- Guarantees operation in both heating and cooling mode down to -15°C
- Refrigerant cooled PCB guarantees reliable cooling, as it is not influenced by ambient temperature.
- Maximum piping length up to 50m, minimum piping length has no limitation
- Outdoor units for pair, twin, triple, double twin application



Inverter



Auto cooling-
heating
changeover

2 Specifications

2-1 Capacity and Power input			FCAG100A/RZASG100MY1	FCAG125A/RZASG125MY1	FCAG140A/RZASG140MY1	
Indoor unit			FCAG100AVEB	FCAG125AVEB	FCAG140AVEB	
Outdoor unit			RZASG100M7Y1B	RZASG125M7Y1B	RZASG140M7Y1B	
Cooling capacity	Nom.	kW	9.50 (1)	12.1 (1)	13.4 (1)	
Heating capacity	Nom.	kW	10.8 (2)	13.5 (2)	15.5 (2)	
Seasonal efficiency (according to EN14825)	Cooling	Energy efficiency class	A++			
		Pdesign	kW	9.50	12.1	13.4
		SEER		6.55	5.76	6.53
		Annual energy consumption	kWh	507	1,261	1,231
	Heating (Average climate)	Energy efficiency class	A+			
		Pdesign	kW	6.00		7.80
		SCOP/A		4.17	4.05	4.31
		Annual energy consumption	kWh	2,016	2,074	2,534

Notes

(1) Nominal cooling capacities are based on: indoor temperature: 27°CDB, 19°CWB, outdoor temperature: 35°CDB, equivalent refrigerant piping: 5m, level difference: 0m.

(2) Nominal heating capacities are based on: indoor temperature: 20°CDB, outdoor temperature: 7°CDB, 6°CWB, equivalent refrigerant piping: 5m, level difference: 0m.

2-2 Capacity and Power input			FBA100A/RZASG100MY1	FBA125A/RZASG125MY1	FBA140A/RZASG140MY1	
Indoor unit			FBA100A2VEB	FBA125A2VEB	FBA140A2VEB	
Outdoor unit			RZASG100M7Y1B	RZASG125M7Y1B	RZASG140M7Y1B	
Cooling capacity	Nom.	kW	9.50 (1)	12.1 (1)	13.4 (1)	
Heating capacity	Nom.	kW	10.8 (2)	13.5 (2)	15.5 (2)	
Seasonal efficiency (according to EN14825)	Cooling	Energy efficiency class	A+			
		Pdesign	kW	9.50	12.1	13.4
		SEER		5.83	5.27	5.81
		Annual energy consumption	kWh	570	1,378	1,384
	Heating (Average climate)	Energy efficiency class	A			
		Pdesign	kW	6.00		7.80
		SCOP/A		3.85	3.63	3.85
		Annual energy consumption	kWh	2,182	2,314	2,836

Notes

(1) Nominal cooling capacities are based on: indoor temperature: 27°CDB, 19°CWB, outdoor temperature: 35°CDB, equivalent refrigerant piping: 5m, level difference: 0m.

(2) Nominal heating capacities are based on: indoor temperature: 20°CDB, outdoor temperature: 7°CDB, 6°CWB, equivalent refrigerant piping: 5m, level difference: 0m.

2-3 Capacity and Power input			FHA100A/RZASG100MY1	FHA125A/RZASG125MY1	FHA140A/RZASG140MY1	
Indoor unit			FHA100AVEB	FHA125AVEB	FHA140AVEB	
Outdoor unit			RZASG100M7Y1B	RZASG125M7Y1B	RZASG140M7Y1B	
Cooling capacity	Nom.	kW	9.50 (1)	12.1 (1)	13.4 (1)	
Heating capacity	Nom.	kW	10.8 (2)	13.5 (2)	15.5 (2)	
Seasonal efficiency (according to EN14825)	Cooling	Energy efficiency class	A+			
		Pdesign	kW	9.50	12.1	13.4
		SEER		5.83	5.60	5.88
		Annual energy consumption	kWh	570	1,297	1,368
	Heating (Average climate)	Energy efficiency class	A			
		Pdesign	kW	6.00		7.80
		SCOP/A		3.91	3.83	3.81
		Annual energy consumption	kWh	2,148	2,193	2,866

2 Specifications

Notes

(1) Nominal cooling capacities are based on: indoor temperature: 27°CDB, 19°CWB, outdoor temperature: 35°CDB, equivalent refrigerant piping: 5m, level difference: 0m.

(2) Nominal heating capacities are based on: indoor temperature: 20°CDB, outdoor temperature: 7°CDB, 6°CWB, equivalent refrigerant piping: 5m, level difference: 0m.

2

2-4 Capacity and Power input				FUA100A/RZASG100MY1	FUA125A/RZASG125MY1
Indoor unit				FUA100AVEB	FUA125AVEB
Outdoor unit				RZASG100M7Y1B	RZASG125M7Y1B
Cooling capacity	Nom.	kW		9.50 (1)	12.1 (1)
Heating capacity	Nom.	kW		10.8 (2)	13.5 (2)
Seasonal efficiency (according to EN14825)	Cooling	Energy efficiency class		A+	-
		Pdesign	kW	9.50	12.1
		SEER		5.83	5.27
		Annual energy consumption	kWh	570	1,378
	Heating (Average climate)	Energy efficiency class		A+	-
		Pdesign	kW	6.00	
		SCOP/A		4.01	3.84
		Annual energy consumption	kWh	2,095	2,188

Notes

(1) Nominal cooling capacities are based on: indoor temperature: 27°CDB, 19°CWB, outdoor temperature: 35°CDB, equivalent refrigerant piping: 5m, level difference: 0m.

(2) Nominal heating capacities are based on: indoor temperature: 20°CDB, outdoor temperature: 7°CDB, 6°CWB, equivalent refrigerant piping: 5m, level difference: 0m.

2-5 Capacity and Power input				FAA100A/RZASG100MY1	
Indoor unit				FAA100AUVEB	
Outdoor unit				RZASG100M7Y1B	
Cooling capacity	Nom.	kW		9.50 (1)	
Heating capacity	Nom.	kW		10.8 (2)	
Seasonal efficiency (according to EN14825)	Cooling	Energy efficiency class		A+	
		Pdesign	kW	9.50	
		SEER		5.83	
		Annual energy consumption	kWh	570	
	Heating (Average climate)	Energy efficiency class		A	
		Pdesign	kW	6.00	
		SCOP/A		3.85	
		Annual energy consumption	kWh	2,182	

Notes

(1) Nominal cooling capacities are based on: indoor temperature: 27°CDB, 19°CWB, outdoor temperature: 35°CDB, equivalent refrigerant piping: 5m, level difference: 0m.

(2) Nominal heating capacities are based on: indoor temperature: 20°CDB, outdoor temperature: 7°CDB, 6°CWB, equivalent refrigerant piping: 5m, level difference: 0m.

2-6 Capacity and Power input				FAV100A/RZASG100MY1	FVA125A/RZASG125MY1	FVA140A/RZASG140MY1
Indoor unit				FVA100AMVEB	FVA125AMVEB	FVA140AMVEB
Outdoor unit				RZASG100M7Y1B	RZASG125M7Y1B	RZASG140M7Y1B
Cooling capacity	Nom.	kW		9.50 (1)	12.1 (1)	13.4 (1)
Heating capacity	Nom.	kW		10.8 (2)	13.5 (2)	15.5 (2)

4

2 Specifications

2-6 Capacity and Power input				FVA100A/RZASG100MY1	FVA125A/RZASG125MY1	FVA140A/RZASG140MY1
Seasonal efficiency (according to EN14825)	Cooling	Energy efficiency class		A+		
		Pdesign	kW	9.50	12.1	13.4
		SEER		5.72	5.30	5.63
		Annual energy consumption	kWh	581	1,370	1,428
	Heating (Average climate)	Energy efficiency class		A		
		Pdesign	kW	6.00		7.80
		SCOP/A		3.83	3.64	3.81
		Annual energy consumption	kWh	2,193	2,308	2,866

Notes

(1) Nominal cooling capacities are based on: indoor temperature: 27°CDB, 19°CWB, outdoor temperature: 35°CDB, equivalent refrigerant piping: 5m, level difference: 0m.

(2) Nominal heating capacities are based on: indoor temperature: 20°CDB, outdoor temperature: 7°CDB, 6°CWB, equivalent refrigerant piping: 5m, level difference: 0m.

2-7 Technical Specifications					RZASG100MY1	RZASG125MY1	RZASG140MY1	
Capacity control	Method				Inverter controlled			
Casing	Colour				Ivory white			
	Material				Painted galvanized steel plate			
Dimensions	Unit	Height	mm		990			
		Width	mm		940			
		Depth	mm		320			
	Packed unit	Height	mm		1,170			
		Width	mm		1,015			
		Depth	mm		422			
Weight	Unit		kg		70		77	
	Packed unit		kg		78		85	
Packing	Weight		kg		9			
Heat exchanger	Fin	Type			WF fin			
		Treatment			Anti-corrosion treatment (PE)			
Compressor	Quantity				1			
	Type				Hermetically sealed swing compressor			
	Starting method				Inverter driven			
Fan	Type				Propeller			
	Discharge direction				Horizontal			
	Quantity				1			
	Air flow rate	Cooling	Nom.	m³/min		69	71	76
Heating		Nom.	m³/min		82			
Fan motor	Quantity				1			
	Model				Brushless DC motor			
	Output			W	200			
	Drive				Direct drive			
	Speed	Cooling	Super low	rpm		-		
			Heating	Super low	rpm		-	
Sound power level	Cooling		dBA		70	71	73	
	Heating		dBA		-			
Sound pressure level	Night quiet mode	Level 2		dBA		44		
	Cooling	Nom.		dBA		53	54	
	Heating	Nom.		dBA		57		
Operation range	Cooling	Ambient	Min.	°CDB	-15			
			Max.	°CDB	46			
	Heating	Ambient	Min.	°CWB	-15			
			Max.	°CWB	15.5			

2 Specifications

2

2-7 Technical Specifications				RZASG100MY1	RZASG125MY1	RZASG140MY1	
Refrigerant	Type			R-32			
	Charge	kg		2.60		2.90	
		TCO ₂ eq		1.76		1.96	
	Control			Expansion valve (electronic type)			
	GWP			675			
	Circuits	Quantity		1			
Piping connections	Liquid	Quantity		1			
		Type		Flare connection			
		OD	mm	9,52			
	Gas	Quantity		1			
		Type		Flare connection			
		OD	mm	15.9			
	Drain	Quantity		5			
		Type		Hole			
		ID	mm	-			
	Piping length	OU - IU	Min.	m	5		
			Max.	m	50		
		System	Equivalent	m	70		
			Chargel ess	m	30		
	Additional refrigerant charge			kg/m	See installation manual		
	Level difference	IU - OU	Max.	m	30.0		
IU - IU		Max.	m	0.5			
Heat insulation			Both liquid and gas pipes				
Refrigerant oil	Type			FW68DA			
	Charged volume		l	0.90		1.35	
Defrost method			Reversed cycle				
Defrost control			Sensor for outdoor heat exchanger temperature				
Safety devices	Item	01	High pressure switch				
		02	Low pressure switch				
		03	Fan driver overload protector				
		04	Fuse				
		05	Compressor motor thermal protector				

Standard Accessories : Tie-wraps; Quantity : 2;

Standard Accessories : Installation manual; Quantity : 1;

Standard Accessories : Refrigerant label for F-gas regulation; Quantity : 1;

Standard Accessories : General safety precautions; Quantity : 1;

Standard Accessories : LOT10 Energy Label; Quantity : 1;

2-8 Electrical Specifications				RZASG100MY1	RZASG125MY1	RZASG140MY1
Power supply	Name			Y1		
	Phase			3~		
	Frequency	Hz		50		
	Voltage	V		380-415		
Current - 50Hz	Maximum fuse amps (MFA)		A		16	
Current	Zmax	List		Complies to EN61000-3-11		
	Minimum Ssc value		kVa	Equipment complying with EN / IEC 61000-3-2 / (1) / See note 3		
Current - 60Hz	Maximum fuse amps (MFA)		A		-	
Wiring connections	For power supply		Remark	See installation manual outdoor unit		
	For connection with indoor		Remark	See installation manual outdoor unit		
Power supply intake			See installation manual outdoor unit			

2 Specifications

Notes

(1) Ssc: Short-circuit power

(2) Nominal cooling capacities are based on: indoor temperature: 27°CDB, 19°CWB, outdoor temperature: 35°CDB, equivalent refrigerant piping: 5m, level difference: 0m.

European/international technical standard setting the limits for harmonic currents produced by equipment connected to public low-voltage system with input current larger than 16A and $\leq 75A$ per phase.

3 Electrical data

3 - 1 Electrical Data

3

RZASG100MY1

Indoor	Outdoor	Power supply	Voltage range		MCA	TOCA	MFA	Compressor		OFM		IFM	
								MSC	RLA	kW	FLA	kW	FLA
FCAG35AVEB	x3 RZASG100M7Y1B	3N~ 50Hz 380-415V	Minimum: 342 V Maximum 456 V		13,0	--	16	--	10,6	0,200	1,0	0,044 x3	0,3 x3
FCAG50AVEB	x2 RZASG100M7Y1B				12,7	--	16	--	10,6	0,200	1,0	0,039 x2	0,3 x2
FCAG100AVEB	RZASG100M7Y1B				14,2	--	16	--	12,0	0,200	1,0	0,117	0,7
FFA35A2VEB	x3 RZASG100M7Y1B				13,3	--	16	--	10,6	0,200	1,0	0,050 x3	0,4 x3
FFA50A2VEB	x2 RZASG100M7Y1B				12,9	--	16	--	10,6	0,200	1,0	0,050 x2	0,4 x2
FBA100A2VEB	RZASG100M7Y1B				14,6	--	16	--	12,0	0,200	1,0	0,127	1,0
FNA35A2VEB	x3 RZASG100M7Y1B				13,0	--	16	--	10,6	0,200	1,0	0,034 x3	0,3 x3
FNA50A2VEB	x2 RZASG100M7Y1B				13,1	--	16	--	10,6	0,200	1,0	0,060 x2	0,5 x2
FUA100AVEB	RZASG100M7Y1B				14,9	--	16	--	12,0	0,200	1,0	0,106	1,3
FAA100AVEB	RZASG100M7Y1B				13,9	--	16	--	12,0	0,200	1,0	0,064	0,4
FVA100AMVEB	RZASG100M7Y1B				14,8	--	16	--	12,0	0,200	1,0	0,238	1,2
FDXM35F3V1B	x3 RZASG100M7Y1B				13,0	--	16	--	10,6	0,200	1,0	0,034 x3	0,3 x3
FDXM50F3V1B	x2 RZASG100M7Y1B				13,1	--	16	--	10,6	0,200	1,0	0,060 x2	0,5 x2
FHA35AVEB	x3 RZASG100M7Y1B				13,9	--	16	--	10,6	0,200	1,0	0,060 x3	0,6 x3
FHA50AVEB	x2 RZASG100M7Y1B				13,3	--	16	--	10,6	0,200	1,0	0,060 x2	0,6 x2
FHA100AVEB	RZASG100M7Y1B				14,9	--	16	--	12,0	0,200	1,0	0,150	1,3

3D110014A

RZASG125-140MY1

Indoor	Outdoor	Power supply	Voltage range		MCA	TOCA	MFA	Compressor		OFM		IFM	
								MSC	RLA	kW	FLA	kW	FLA
FCAG35AVEB	x4 RZASG125M7Y1B	3N~ 50Hz 380-415V	Minimum: 342 V Maximum 456 V		12,2	--	16	--	9,5	0,200	1,0	0,044 x4	0,3 x4
FCAG50AVEB	x3 RZASG125M7Y1B				13,0	--	16	--	10,6	0,200	1,0	0,039 x3	0,3 x3
FCAG60AVEB	x2 RZASG125M7Y1B				12,7	--	16	--	10,6	0,200	1,0	0,044 x2	0,3 x2
FCAG125AVEB	RZASG125M7Y1B				14,6	--	16	--	12,0	0,200	1,0	0,168	1,0
FFA35A2VEB	x4 RZASG125M7Y1B				12,6	--	16	--	9,5	0,200	1,0	0,050 x4	0,4 x4
FFA50A2VEB	x3 RZASG125M7Y1B				13,3	--	16	--	10,6	0,200	1,0	0,050 x3	0,4 x3
FFA60A2VEB	x2 RZASG125M7Y1B				13,3	--	16	--	10,6	0,200	1,0	0,050 x2	0,6 x2
FBA35A2VEB	x4 RZASG125M7Y1B				13,4	--	16	--	9,5	0,200	1,0	0,089 x4	0,6 x4
FBA50A2VEB	x3 RZASG125M7Y1B				13,9	--	16	--	10,6	0,200	1,0	0,089 x3	0,6 x3
FBA60A2VEB	x2 RZASG125M7Y1B				13,1	--	16	--	10,6	0,200	1,0	0,070 x2	0,5 x2
FBA125A2VEB	RZASG125M7Y1B				15,1	--	16	--	12,0	0,200	1,0	0,187	1,5
FNA35A2VEB	x4 RZASG125M7Y1B				12,2	--	16	--	9,5	0,200	1,0	0,034 x4	0,3 x4
FNA50A2VEB	x3 RZASG125M7Y1B				13,6	--	16	--	10,6	0,200	1,0	0,060 x3	0,5 x3
FNA60A2VEB	x2 RZASG125M7Y1B				13,1	--	16	--	10,6	0,200	1,0	0,060 x2	0,5 x2
FUA125AVEB	RZASG125M7Y1B				15,0	--	16	--	12,0	0,200	1,0	0,106	1,4
FDA125AVEB	RZASG125M7Y1B				15,7	--	16	--	12,0	0,200	1,0	0,350	2,1
FVA125AMVEB	RZASG125M7Y1B				14,8	--	16	--	12,0	0,200	1,0	0,238	1,2
FDXM35F3V1B	x4 RZASG125M7Y1B				12,2	--	16	--	9,5	0,200	1,0	0,034 x4	0,3 x4
FDXM50F3V1B	x3 RZASG125M7Y1B				13,6	--	16	--	10,6	0,200	1,0	0,060 x3	0,5 x3
FDXM60F3V1B	x2 RZASG125M7Y1B				13,1	--	16	--	10,6	0,200	1,0	0,060 x2	0,5 x2
FHA35AVEB	x4 RZASG125M7Y1B	13,4	--	16	--	9,5	0,200	1,0	0,060 x4	0,6 x4			
FHA50AVEB	x3 RZASG125M7Y1B	13,9	--	16	--	10,6	0,200	1,0	0,060 x3	0,6 x3			
FHA60AVEB	x2 RZASG125M7Y1B	13,3	--	16	--	10,6	0,200	1,0	0,091 x2	0,6 x2			
FHA125AVEB	RZASG125M7Y1B	15,1	--	16	--	12,0	0,200	1,0	0,150	1,5			
FCAG35AVEB	x4 RZASG140M7Y1B	3N~ 50Hz 380-415V	Minimum: 342 V Maximum 456 V		12,2	--	16	--	9,5	0,200	1,0	0,044 x4	0,3 x4
FCAG50AVEB	x3 RZASG140M7Y1B				12,9	--	16	--	10,5	0,200	1,0	0,039 x3	0,3 x3
FCAG71AVEB	x2 RZASG140M7Y1B				14,4	--	16	--	12,0	0,200	1,0	0,054 x2	0,4 x2
FCAG140AVEB	RZASG140M7Y1B				14,6	--	16	--	12,0	0,200	1,0	0,168	1,0
FFA35A2VEB	x4 RZASG140M7Y1B				12,6	--	16	--	9,5	0,200	1,0	0,050 x4	0,4 x4
FFA50A2VEB	x3 RZASG140M7Y1B				13,2	--	16	--	10,5	0,200	1,0	0,050 x3	0,4 x3
FBA35A2VEB	x4 RZASG140M7Y1B				13,4	--	16	--	9,5	0,200	1,0	0,089 x4	0,6 x4
FBA50A2VEB	x3 RZASG140M7Y1B				13,8	--	16	--	10,5	0,200	1,0	0,089 x3	0,6 x3
FBA71A2VEB	x2 RZASG140M7Y1B				14,6	--	16	--	12,0	0,200	1,0	0,070 x2	0,5 x2
FBA140A2VEB	RZASG140M7Y1B				15,1	--	16	--	12,0	0,200	1,0	0,187	1,5
FNA35A2VEB	x4 RZASG140M7Y1B				12,2	--	16	--	9,5	0,200	1,0	0,034 x4	0,3 x4
FNA50A2VEB	x3 RZASG140M7Y1B				13,5	--	16	--	10,5	0,200	1,0	0,060 x3	0,5 x3
FUA71AVEB	x2 RZASG140M7Y1B				15,4	--	16	--	12,0	0,200	1,0	0,046 x2	0,9 x2
FAA71AUVEB	x2 RZASG140M7Y1B				14,4	--	16	--	12,0	0,200	1,0	0,048 x2	0,4 x2
FVA71AMVEB	RZASG140M7Y1B				14,8	--	16	--	12,0	0,200	1,0	0,117 x2	0,6 x2
FVA140AMVEB	RZASG140M7Y1B				15,0	--	16	--	12,0	0,200	1,0	0,276	1,4
FDXM35F3V1B	x4 RZASG140M7Y1B				12,2	--	16	--	9,5	0,200	1,0	0,034 x4	0,3 x4
FDXM50F3V1B	x3 RZASG140M7Y1B				13,5	--	16	--	10,5	0,200	1,0	0,060 x3	0,5 x3
FHA35AVEB	x4 RZASG140M7Y1B				13,4	--	16	--	9,5	0,200	1,0	0,060 x4	0,6 x4
FHA50AVEB	x3 RZASG140M7Y1B				13,8	--	16	--	10,5	0,200	1,0	0,060 x3	0,6 x3
FHA71AVEB	x2 RZASG140M7Y1B	15,2	--	16	--	12,0	0,200	1,0	0,091 x2	0,8 x2			
FHA140AVEB	RZASG140M7Y1B	15,4	--	16	--	12,0	0,200	1,0	0,150	1,8			

3D110014A

8

3 Electrical data

3 - 1 Electrical Data

AZAS-MV1

AZAS-MY1

RZAG-MV1

RZAG-MY1

RZASG-MV1

RZASG-MY1

Symbols

- MCA: Minimum Circuit Ampere [A]
- TOCA: Total overcurrent amps [A]
- MFA: Maximum Fuse Ampere [A]
- MSC: Maximum current of the starting compressor [A]
- RLA: Rated load amps [A]
- OFM: Outdoor fan motor
- IFM: Indoor fan motor
- FLA: Full Load Ampere [A]
- KW: Fan motor rated output [kW]

Notes

1. The RLA is based on the following conditions.
 - Cooling
 - Indoor temperature 27.0°C DB / 19.0°C WB
 - Outdoor temperature 35.0°C DB
 - Heating
 - Indoor temperature 20.0°C DB
 - Outdoor temperature 7.0°C DB / 6.0°C WB
2. TOCA is the total value of each overcurrent set.
3. Voltage range
 - The units are suitable for use with electrical systems in which the voltage supplied to the unit terminals is not below or above the listed range limits.
4. The maximum allowable voltage that is unbalanced between phases is 2%.
5. MCA is the maximum input current.
 - The capacity of the MFA must be greater than that of the MCA.
 - Select the MFA according to the table.
6. Select the wire size according to the MCA.
7. MFA is used to select the circuit breaker and the ground fault circuit interruptor.
 - Earth leakage circuit breaker

3D110014A

4 Options

4 - 1 Options

4

AZAS-MV1
 AZAS-MY1
 RZAG-MV1
 RZAG-MY1
 RZASG-MV1
 RZASG-MY1

Available options for RZAG models

Option		Option kit			
		RZAG71M7V1B RZAG71M7Y1B	RZAG100M7V1B RZAG100M7Y1B	RZAG125M7V1B RZAG125M7Y1B	RZAG140M7V1B RZAG140M7Y1B
Bottom plate heater		EKBPH140L7			
Refrigerant branch piping	Twin	KHRQ22M20TA			
	Triple	-	KHRQ127H		
	Double twin	-	KHRQ22M20TA (3x)		
Demand adaptor kit		SB.KRP58M52			

Available options for RZASG models

Option		Option kit			
		RZASG71M2V1B	RZASG100M7V1B RZASG100M7Y1B	RZASG125M7V1B RZASG125M7Y1B	RZASG140M7V1B RZASG140M7Y1B
Bottom plate heater		-			
Refrigerant branch piping	Twin	KHRQ22M20TA			
	Triple	-	KHRQ127H		
	Double twin	-	KHRQ22M20TA (3x)		
Demand adaptor kit		SB.KRP58M52			

Available options for AZAS models

Option		Option kit			
		AZAS71M2V1B	AZAS100M7V1B AZAS100M7Y1B	AZAS125M7V1B AZAS125M7Y1B	AZAS140M7V1B AZAS140M7Y1B
Demand adaptor kit		SB.KRP58M52			

3D108867

5 Combination table

5 - 1 Combination Table

AZAS-MV1

AZAS-MY1

RZAG-MV1

RZAG-MY1

RZASG-MV1

RZASG-MY1

Possible combinations

P= Pair	71	100	125	140
2= Twin	35+35	50+50	60+60	71+71
3= Triple		35+35+35 (*)	50+50+50 (*)	50+50+50 (*)
4= Double twin			35+35+35+35 (*)	35+35+35+35

(*) : See note 1.

Sky Air		High Cassette				Thin cassette				2x2 cassette		Duct (medium ESP)				Concealed floor standing type			Ceiling-mounted - 4-way blow			Wall mounted type		Duct (high ESP)												
Model		FCAHG10GVEB	FCAHG100GVEB	FCAHG125GVEB	FCAHG140GVEB	FCA639AVEB	FCA650AVEB	FCA660AVEB	FCA671AVEB	FCA6100AVEB	FCA6125AVEB	FCA6140AVEB	FFA652VEB	FFA650VEB	FFA660VEB	FBA652VEB	FBA650VEB	FBA660VEB	FBA712VEB	FBA1002VEB	FBA1252VEB	FBA1402VEB	RNA652VEB	RNA650VEB	RNA660VEB	FUA71AVEB	FUA100AVEB	FUA125AVEB	FAA71AVEB	FAA100AVEB	FDA125AVEB					
RZAG71M7Y1B	RZAG71M7Y1B	P				2						2			2																					
RZAG100M7Y1B	RZAG100M7Y1B		P			3	2					3	2		3	2																				
RZAG125M7Y1B	RZAG125M7Y1B			P		4	3	2				P	4	3	2	4	3	2																		
RZAG140M7Y1B	RZAG140M7Y1B	2			P	4	3	3	2			P	4	3	3	4	3	2																		
RZASG71M2V1B						2						2			2																					
RZASG100M7V1B	RZASG100M7Y1B					3	2					3	2		3	2																				
RZASG125M7V1B	RZASG125M7Y1B					4	3	2				P	4	3	2	4	3	2																		
RZASG140M7V1B	RZASG140M7Y1B					4	3	2				P	4	3	2	4	3	2																		
AZAS71M2V1B																																				
AZAS100M7V1B	AZAS100M7Y1B																																			
AZAS125M7V1B	AZAS125M7Y1B																																			
AZAS140M7V1B	AZAS140M7Y1B																																			

Sky Air		Floor standing type			Slim duct			Ceiling-suspended							
Model		FVA11AMVEB	FVA1100AMVEB	FVA125AMVEB	FVA140AMVEB	FDX103F3V1B	FDX105F3V1B	FDX106F3V1B	FHA63AVEB	FHA65AVEB	FHA66AVEB	FHA71AVEB	FHA100AVEB	FHA125AVEB	FHA140AVEB
RZAG71M7Y1B	RZAG71M7Y1B	P				2			2						
RZAG100M7Y1B	RZAG100M7Y1B		P			3	2		3	2					
RZAG125M7Y1B	RZAG125M7Y1B			P		4	3	2	4	3	2				
RZAG140M7Y1B	RZAG140M7Y1B	2			P	4	3	3	4	3	2				
RZASG71M2V1B						2			2						
RZASG100M7V1B	RZASG100M7Y1B		P			3	2		3	2					
RZASG125M7V1B	RZASG125M7Y1B			P		4	3	2	4	3	2				
RZASG140M7V1B	RZASG140M7Y1B	2			P	4	3	3	4	3	2				
AZAS71M2V1B															
AZAS100M7V1B	AZAS100M7Y1B														
AZAS125M7V1B	AZAS125M7Y1B														
AZAS140M7V1B	AZAS140M7Y1B														

Notes

- Maximum capacity is limited based on outdoor unit capacity.
- When combining multiple indoor units, designate the unit whose remote controller is equipped with the most functions as the master unit.
- For the selection of the correct refnet kit, required to install a multi-combination, refer to the option list.

Twin : KHRQ/M58T
 Triple : KHRQ/M58H
 Double twin : KHRQ/M58T

3D108868A

6 Capacity tables

6 - 1 Cooling/Heating Capacity Tables

6

RZASG100MV1 RZASG100MY1

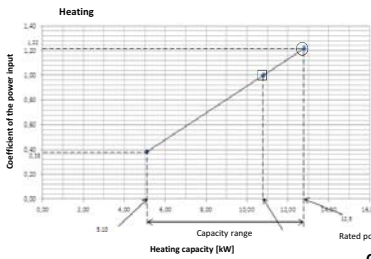
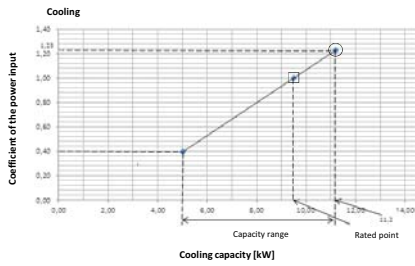

Symbols
 AFR: Air flow rate [m³/min]
 BF: Bypass factor
 EWB: Entering wet-bulb temperature (°C WB)
 EDB: Entering dry-bulb temperature (°C DB)
 TC: Maximum total cooling/heating capacity [kW]
 SHC: Sensible heat capacity [kW]
 CPI: Coefficient of the power input
 Pi: Power input [kW]
 compressor + indoor and outdoor fan motors

Notes

- The ratings shown are net capacities which include a deduction for indoor fan motor heat.
- Maximum at standard conditions
 □ Rated capacity and rated coefficient of the power input
 The maximum capacity is not guaranteed except at standard conditions.
- SHC is based on indoor units EWB & EDB.
 SHC for other dry-bulb temperatures = SHC + SHC*
 SHC+SHC correction for other dry-bulb temperatures
 = 0.02 x AFR (m³/min) x (1-BF) x (DB* - EDB)
- The capacities are based on the following conditions:
 Outdoor air: 85% RH
 However, the outdoor ambient condition of the rated capacity during heating operation is 7°C DB / 6°C WB.
 Corresponding refrigerant piping length: 5.0 m
 Level difference: 0m
- CPI is a percentage value compared to the rated value which is 1.00.
- The error rate for this value is less than 5% and depends on the indoor unit type.
- The heating performance takes into account the drop that occurs during defrost operation.
- The air flow rate and bypass factor are mentioned in the table.
- The rated power input for each model is mentioned in the table below.

Indoor	Outdoor temperature [°C DB]												
	25				30				40				
	TC	SHC	CPI	Power	TC	SHC	CPI	Power	TC	SHC	CPI	Power	
16.0	22	11.2	7.01	1.08	10.8	7.44	1.11	10.5	7.20	1.20	10.1	7.00	1.20
18.0	25	11.8	7.59	1.08	11.4	7.80	1.12	11.0	7.57	1.23	10.5	7.00	1.20
19.5	27	12.0	7.67	1.02	11.6	7.44	1.12	11.2	7.20	1.20	10.5	7.04	1.20
22.0	30	12.8	7.92	1.02	12.4	7.36	1.13	11.9	7.16	1.24	11.2	7.03	1.20
24.0	32	13.3	7.82	1.03	12.9	7.27	1.14	12.4	7.06	1.25	12.0	6.91	1.20

Indoor	Outdoor temperature [°C WB]														
	-15.0			-10.0			-5.0			0.0			10.0		
	TC	CPI	Power	TC	CPI	Power	TC	CPI	Power	TC	CPI	Power	TC	CPI	Power
16	858	0.93	9.45	0.99	10.1	1.02	10.4	1.05	12.8	1.12	13.8	1.18	13.8	1.18	
18	857	0.97	9.44	1.02	10.0	1.07	10.3	1.10	12.8	1.17	13.8	1.23	13.8	1.23	
20	856	1.01	9.43	1.07	10.0	1.11	10.3	1.14	12.8	1.22	13.8	1.28	13.8	1.28	
21	856	1.03	9.42	1.09	10.0	1.13	10.3	1.16	12.8	1.24	13.8	1.30	13.8	1.30	
22	855	1.04	9.42	1.10	10.0	1.14	10.3	1.18	12.8	1.26	13.8	1.33	13.8	1.33	
24	854	1.09	9.41	1.15	10.0	1.19	10.3	1.23	12.8	1.31	13.8	1.38	13.8	1.38	

Pair	FCAG100A	FAA100A	FVA100A	FHA100A	FUA100A	FBA100A
AFR	22.8	26.0	28.0	28.0	31.0	29.0
(BF)	(0.17)	(0.10)	(0.20)	(0.09)	(0.20)	(0.03)

Twin	FCAG50A x 2	FHA50A x 2	FFA50A x 2	FDXM50F3 x 2	FNA50A x 2
AFR	12.6 x 2	15.0 x 2	15.9 x 2	15.9 x 2	16.0 x 2
(BF)	(0.22 x 2)	(0.18 x 2)	(0.16 x 2)	(0.11 x 2)	(0.11 x 2)

Triple	FCAG35A x 3	FHA35A x 3	FFA35A x 3	FDXM35F3 x 3	FNA35A x 3
AFR	12.5 x 3	14.0 x 3	16.0 x 3	8.7 x 3	8.7 x 3
(BF)	(0.4 x 3)	(0.17 x 3)	(0.25 x 3)	(0.17 x 3)	(0.17 x 3)

Pair	FCAG100A	FAA100A	FVA100A	FHA100A	FUA100A	FBA100A
Cooling	2.92	3.52	2.97	2.97	2.97	2.97
Heating	3.45	3.98	3.47	3.43	3.20	3.32

Twin	FCAG50A x 2	FHA50A x 2	FFA50A x 2	FDXM50F3 x 2	FNA50A x 2
Cooling	2.97	2.97	2.98	2.94	2.94
Heating	3.33	3.26	3.89	2.96	2.96

Triple	FCAG35A x 3	FHA35A x 3	FFA35A x 3	FDXM35F3 x 3	FNA35A x 3
Cooling	2.32	2.16	2.71	2.57	2.57
Heating	2.73	2.66	3.87	3.13	3.13

3D112145

RZASG125MV1 RZASG125MY1

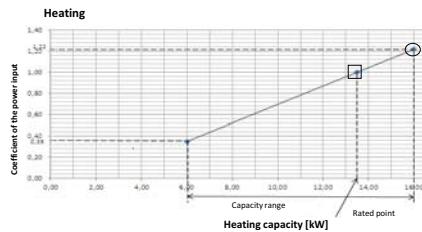
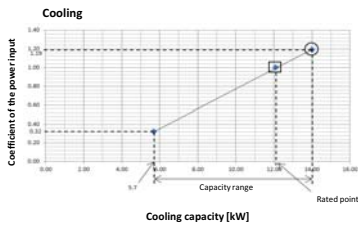

Symbols
 AFR: Air flow rate [m³/min]
 BF: Bypass factor
 EWB: Entering wet-bulb temperature (°C WB)
 EDB: Entering dry-bulb temperature (°C DB)
 TC: Maximum total cooling/heating capacity [kW]
 SHC: Sensible heat capacity [kW]
 CPI: Coefficient of the power input
 Pi: Power input [kW]
 compressor + indoor and outdoor fan motors

- The ratings shown are net capacities which include a deduction for indoor fan motor heat.
- Maximum at standard conditions
 □ Rated capacity and rated coefficient of the power input
 The maximum capacity is not guaranteed except at standard conditions.
- SHC is based on indoor units EWB & EDB.
 SHC for other dry-bulb temperatures = SHC + SHC*
 Not SHC+SHC correction for other dry-bulb temperatures
 = 0.02 x AFR (m³/min) x (1-BF) x (DB* - EDB)
- The capacities are based on the following conditions:
 Outdoor air: 85% RH
 However, the outdoor ambient condition of the rated capacity during heating operation is 7°C DB / 6°C WB.
 Corresponding refrigerant piping length: 5.0 m
 Level difference: 0m
- CPI is a percentage value compared to the rated value which is 1.00.
- The error rate for this value is less than 5% and depends on the indoor unit type.
- The heating performance takes into account the drop that occurs during defrost operation.
- The air flow rate and bypass factor are mentioned in the table.
- The rated power input for each model is mentioned in the table below.

Indoor	Outdoor temperature [°C DB]												
	25				35				40				
	TC	SHC	CPI	Power	TC	SHC	CPI	Power	TC	SHC	CPI	Power	
16.0	22	14.10	9.54	0.97	13.60	9.30	1.08	13.10	9.12	1.18	12.60	8.78	1.28
18.0	25	14.70	9.50	0.97	14.20	9.32	1.08	13.70	9.09	1.19	13.20	8.89	1.30
19.5	27	15.00	9.52	0.99	14.50	9.34	1.09	14.00	9.06	1.19	13.50	8.97	1.29
22.0	30	16.00	9.39	0.99	15.50	9.14	1.09	14.90	8.95	1.20	14.40	8.81	1.31
24.0	32	16.70	9.31	1.00	16.10	9.09	1.11	15.50	8.83	1.21	15.00	8.63	1.32

Indoor	Outdoor temperature [°C WB]														
	-15.0			-10.0			-5.0			0.0			10.0		
	TC	CPI	Power	TC	CPI	Power	TC	CPI	Power	TC	CPI	Power	TC	CPI	Power
16	10.7	0.953	11.8	0.999	12.6	1.02	13.0	1.05	16.0	1.12	17.3	1.18	17.3	1.18	
18	10.7	0.977	11.8	1.022	12.6	1.077	12.9	1.10	16.0	1.17	17.3	1.23	17.3	1.23	
20	10.7	1.01	11.8	1.07	12.6	1.11	12.9	1.14	16.0	1.22	17.3	1.28	17.3	1.28	
21	10.7	1.03	11.8	1.09	12.6	1.13	12.9	1.16	16.0	1.24	17.3	1.31	17.3	1.31	
22	10.7	1.04	11.8	1.10	12.6	1.14	12.9	1.18	16.0	1.27	17.3	1.33	17.3	1.33	
24	10.7	1.09	11.8	1.15	12.6	1.19	12.9	1.23	16.0	1.31	17.3	1.38	17.3	1.38	

Pair	FCAG125A	FDA125A	FVA125A	FHA125A	FUA125A	FBA125A
AFR	26.0	39.0	28.0	31.0	32.5	34.0
(BF)	(0.21)	(0.16)	(0.16)	(0.14)	(0.19)	(0.06)

Twin	FCAG60A x 2	FHA60A x 2	FFA60A x 2	FDXM60F3 x 2	FBA60A x 2	FNA60A x 2
AFR	13.6 x 2	19.5 x 2	14.5 x 2	16.0 x 2	18.0 x 2	16.0 x 2
(BF)	(0.2 x 2)	(0.20 x 2)	(0.11 x 2)	(0.12 x 2)	(0.18 x 2)	(0.12 x 2)

Triple	FCAG35A x 3	FHA35A x 3	FFA35A x 3	FDXM35F3 x 3	FBA35A x 3	FNA35A x 3
AFR	12.6 x 3	15.0 x 3	12.0 x 3	15.8 x 3	15.0 x 3	16.0 x 3
(BF)	(0.22 x 3)	(0.18 x 3)	(0.16 x 3)	(0.11 x 3)	(0.13 x 3)	(0.11 x 3)

Double twin	FCAG35A x 4	FHA35A x 4	FFA35A x 4	FDXM35F3 x 4	FBA35A x 4	FNA35A x 4
AFR	12.5 x 4	14.0 x 4	10.0 x 4	8.7 x 4	15.0 x 4	8.7 x 4
(BF)	(0.4 x 4)	(0.17 x 4)	(0.25 x 4)	(0.17 x 4)	(0.08 x 4)	(0.17 x 4)

Pair	FCAG125A	FDA125A	FVA125A	FHA125A	FUA125A	FBA125A
Cooling	4.95	4.73	5.11	4.79	5.37	4.84
Heating	3.44	3.18	3.60	3.35	3.24	3.23

Twin	FCAG60A x 2	FHA60A x 2	FFA60A x 2	FDXM60F3 x 2	FBA60A x 2	FNA60A x 2
Cooling	4.15	6.21	6.01	3.87	4.28	3.87
Heating	3.29	3.23	3.39	3.29	3.15	3.29

Triple	FCAG35A x 3	FHA35A x 3	FFA35A x 3	FDXM35F3 x 3	FBA35A x 3	FNA35A x 3
Cooling	3.74	4.42	4.65	3.37	4.08	3.37
Heating	2.94	2.94	3.18	2.92	3.08	2.92

Double twin	FCAG35A x 4	FHA35A x 4	FFA35A x 4	FDXM35F3 x 4	FBA35A x 4	FNA35A x 4
Cooling	3.34	2.89	4.00	3.80	3.83	3.80
Heating	2.63	2.75	3.33	3.20	2.80	3.20

3D112146

6 Capacity tables

6 - 1 Cooling/Heating Capacity Tables

RZASG140MV1 RZASG140MY1

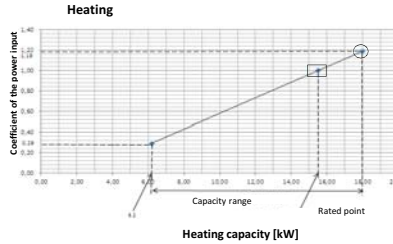
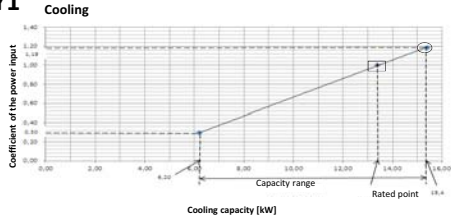

Symbols
 AFR: Air flow rate (m³/min)
 BF: Bypass factor
 EWB: Entering wet-bulb temperature (°C WB)
 EDB: Entering dry-bulb temperature (°C DB)
 TC: Maximum total cooling/heating capacity [kW]
 SHC: Sensible heat capacity [kW]
 CPI: Coefficient of the power input
 PI: Power input [kW]
 compressor + indoor and outdoor fan motors

- The ratings shown are net capacities which include a deduction for indoor fan motor heat.
- - Maximum at standard conditions
 □ - Rated capacity and rated coefficient of the power input
 The maximum capacity is not guaranteed except at standard conditions.
- SHC is based on indoor units EWB & EDB.
 Not SHC for other dry-bulb temperatures = SHC + SHC*
 SHC*SHC correction for other dry-bulb temperatures
 = 0.02 × AFR (m³/min) × (1-BF) × (DB* - EDB)
- The capacities are based on the following conditions:
 Outdoor air: 85% RH
 However, the outdoor ambient condition of the rated capacity during heating operation is 7°C DB / 6°C WB.
 Corresponding refrigerant piping length: 5.0 m
 Level difference: 0m
- CPI is a percentage value compared to the rated value which is 1.00.
- The error rate for this value is less than 5% and depends on the indoor unit type.
- The heating performance takes into account the drop that occurs during defrost operation.
- The air flow rate and bypass factor are mentioned in the table.
- The rated power input for each model is mentioned in the table below.

Cooling

Indoor	Outdoor temperature (°C DB)												
	25			30			35			40			
°CWB	°CDB	kW	SHC	CPI	TC	SHC	CPI	TC	SHC	CPI	TC	SHC	CPI
16.0	22	15.5	10.47	0.88	14.9	10.25	1.08	14.4	10.03	1.18	13.9	9.69	1.28
18.0	26	16.2	10.55	0.89	15.6	10.21	1.09	15.1	10.08	1.19	14.5	9.71	1.30
19.0	27	16.6	10.43	0.89	16.0	10.18	1.09	15.4	9.98	1.19	14.8	9.76	1.30
19.5	27	16.7	10.49	0.89	16.1	10.16	1.10	15.5	10.00	1.19	15.0	9.66	1.30
22.0	30	17.6	10.37	0.89	17.0	10.16	1.10	16.4	9.83	1.21	15.8	9.60	1.31
24.0	32	18.4	10.20	1.00	17.7	10.00	1.11	17.0	8.67	1.22	16.4	8.47	1.32

Heating

Indoor	Outdoor temperature (°C WB)											
	-15.0		-10.0		-5.0		0.0		6.0		10.0	
°CDB	TC	CPI	TC	CPI	TC	CPI	TC	CPI	TC	CPI	TC	CPI
1.6	11.6	0.91	12.7	0.97	13.6	1.00	13.9	1.03	14.0	1.09	14.4	1.16
1.8	11.6	0.85	12.7	1.00	13.6	1.04	13.9	1.07	14.0	1.14	14.4	1.21
2.0	11.6	0.99	12.7	1.05	13.6	1.09	13.9	1.11	14.0	1.19	14.4	1.25
2.1	11.6	1.00	12.7	1.06	13.6	1.11	13.9	1.13	14.0	1.21	14.4	1.28
2.2	11.6	1.02	12.7	1.08	13.6	1.12	13.9	1.16	14.0	1.24	14.4	1.30
2.4	11.6	1.07	12.6	1.12	13.6	1.17	13.9	1.20	14.0	1.29	14.4	1.35

Pair

Pair	FCAG140A	FVA140A	FHA140A	FBA140A
AFR	25.0	30.0	34.0	34.0
(BF)	(0.23)	(0.18)	(0.17)	(0.06)

Twin

Pair	FCAG71A X 2	FAA71A X 2	FHA71A X 2	FUA71A X 2	FBA71A X 2	FVA71A X 2
AFR	15.3 x 2	18.0 x 2	20.5 x 2	23.0 x 2	18.0 x 2	18.0 x 2
(BF)	(0.14 x 2)	(0.16 x 2)	(0.13 x 2)	(0.24 x 2)	(0.13 x 2)	(0.16 x 2)

Triple

Pair	FCAG50A X 3	FHA50A X 3	FFA50A X 3	FDXM50F3 X 3	FBA50A X 3	FNAS0A X 3
AFR	12.6 x 3	15.0 x 3	12.0 x 3	15.8 x 3	15.0 x 3	16.0 x 3
(BF)	(0.22 x 3)	(0.18 x 3)	(0.16 x 3)	(0.11 x 3)	(0.13 x 3)	(0.11 x 3)

Double twin

Pair	FCAG35A X 4	FHA35A X 4	FFA35A X 4	FDXM35F3 X 4	FBA35A X 4	FNAS3A X 4
AFR	12.5 x 4	14.0 x 4	10.0 x 4	8.7 x 4	15.0 x 4	8.7 x 4
(BF)	(0.4 x 4)	(0.20 x 4)	(0.25 x 4)	(0.17 x 4)	(0.08 x 4)	(0.17 x 4)

Pair

Pair	FCAG140A	FVA140A	FHA140A	FBA140A
Cooling	4.88	5.12	4.84	4.76
Heating	5.01	5.43	5.59	5.13

Twin

Pair	FCAG71A X 2	FAA71A X 2	FHA71A X 2	FUA71A X 2	FBA71A X 2	FVA71A X 2
Cooling	3.87	4.14	3.91	3.62	3.82	4.52
Heating	4.72	4.85	4.58	4.22	5.01	5.21

Triple

Pair	FCAG50A X 3	FHA50A X 3	FFA50A X 3	FDXM50F3 X 3	FBA50A X 3	FNAS0A X 3
Cooling	3.39	4.14	4.32	2.86	3.91	2.86
Heating	4.34	4.21	5.15	4.12	4.43	4.12

Double twin

Pair	FCAG35A X 4	FHA35A X 4	FFA35A X 4	FDXM35F3 X 4	FBA35A X 4	FNAS3A X 4
Cooling	3.05	3.06	3.66	3.65	3.51	3.65
Heating	3.97	3.58	5.62	4.93	4.03	4.93

3D112147

6 Capacity tables

6 - 2 Capacity Correction Factor

6

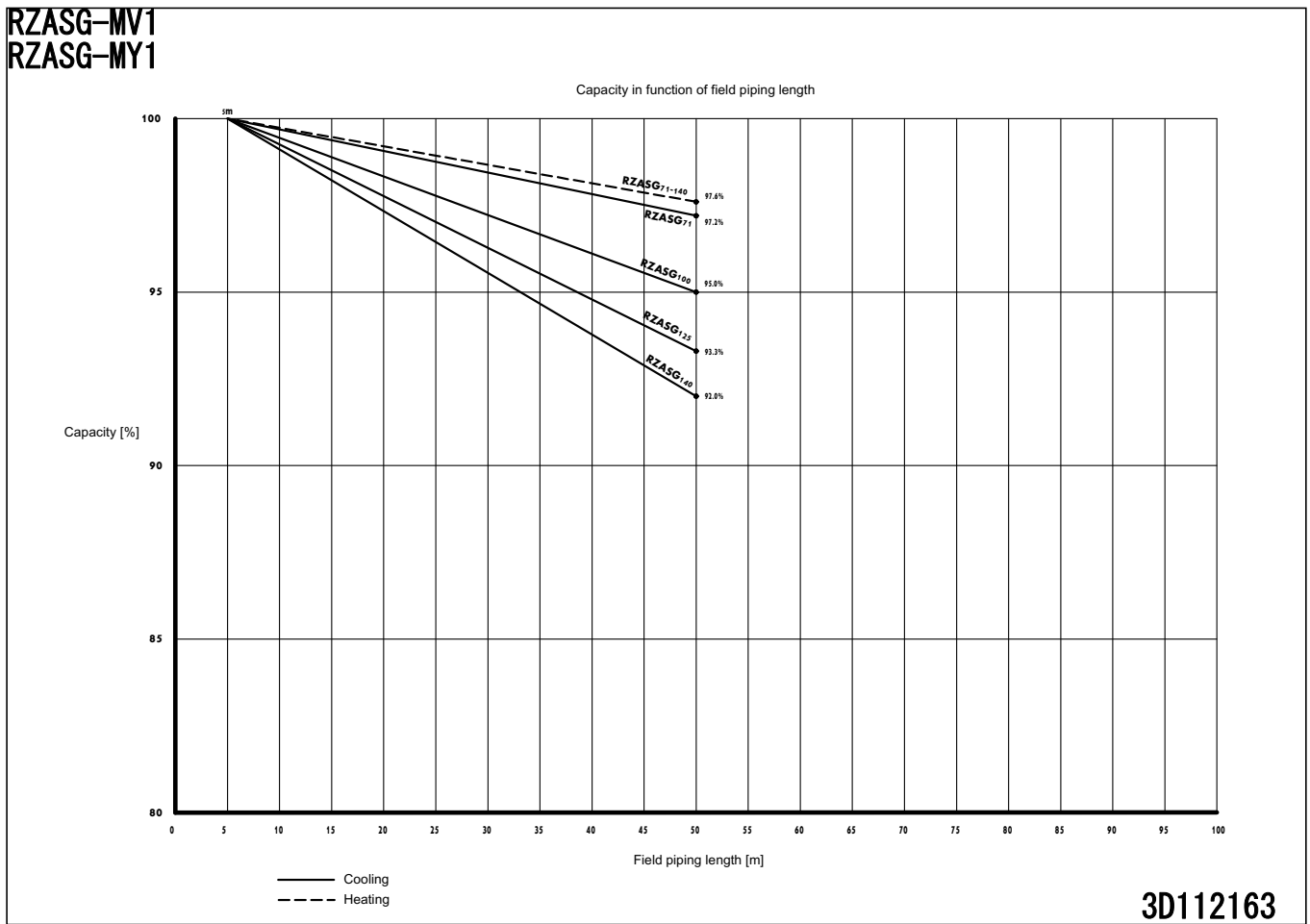

7 Dimensional drawings

7 - 1 Dimensional Drawings

AZAS100-140MV1
 AZAS-MY1
 RZAG71MV1
 RZAG71MY1
 RZASG100-140MV1
 RZASG-MY1

4 holes for anchor bolts
 M12

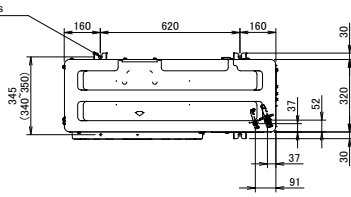

Model	AA	AB
RZAG71* / RZASG100-125* / AZAS100-125*	331	337
RZASG140* / AZAS140*	414	420

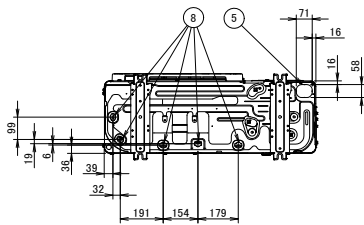
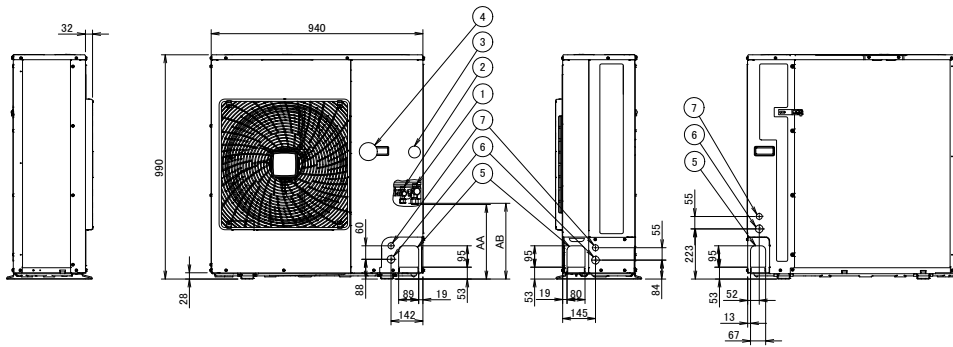

- ① Gas pipe connection Ø15.9 flare
- ② Liquid pipe connection Ø9.5 flare
- ③ Service port (in the unit)
- ④ Electronic connection and grounding terminal M5 (in the switch box)
- ⑤ Refrigerant piping intake
- ⑥ Power supply wiring intake (knockout hole Ø34)
- ⑦ Control wiring intake (knockout hole Ø27)
- ⑧ Drain outlet

3D110011

8 Centre of gravity

8 - 1 Centre of Gravity

8

AZAS100-140MV1

AZAS-MY1

RZAG71MV1

RZAG71MY1

RZASG100-140MV1

RZASG-MY1

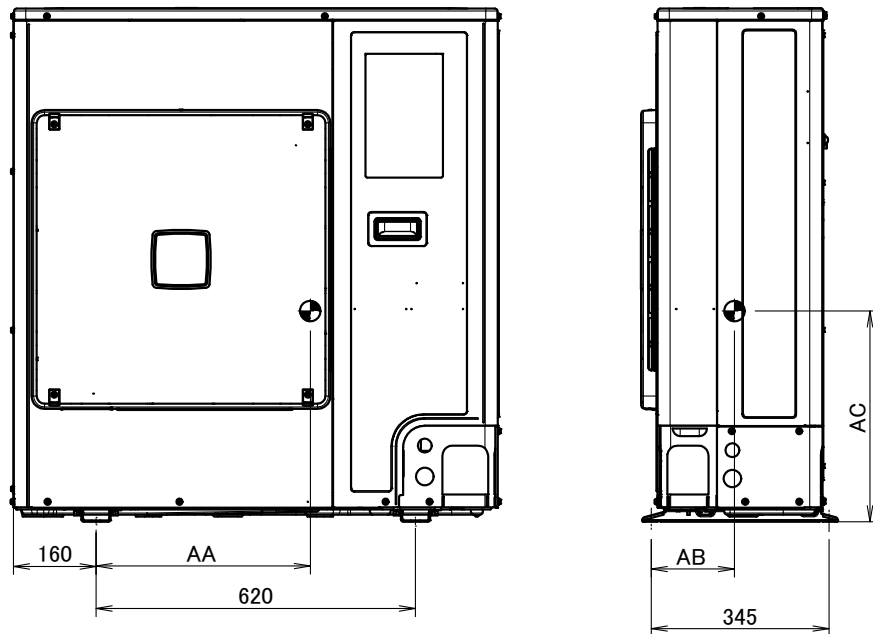

Model	AA	AB	AC
RZAG71M7V*	414	163	407
RZAG71M7Y*	432	137	407
RZASG100-125M7V* / AZAS100-125M7V*	425	181	422
RZASG100-125M7Y* / AZAS100-125M7Y*	414	156	417
RZASG140M7V* / AZAS140M7V*	414	161	423
RZASG140M7Y* / AZAS140M7Y*	416	151	418

4D110025

9 Piping diagrams

9 - 1 Piping Diagrams

AZAS-MV1
 AZAS-MY1
 RZAG-MV1
 RZAG-MY1
 RZASG-MV1
 RZASG-MY1

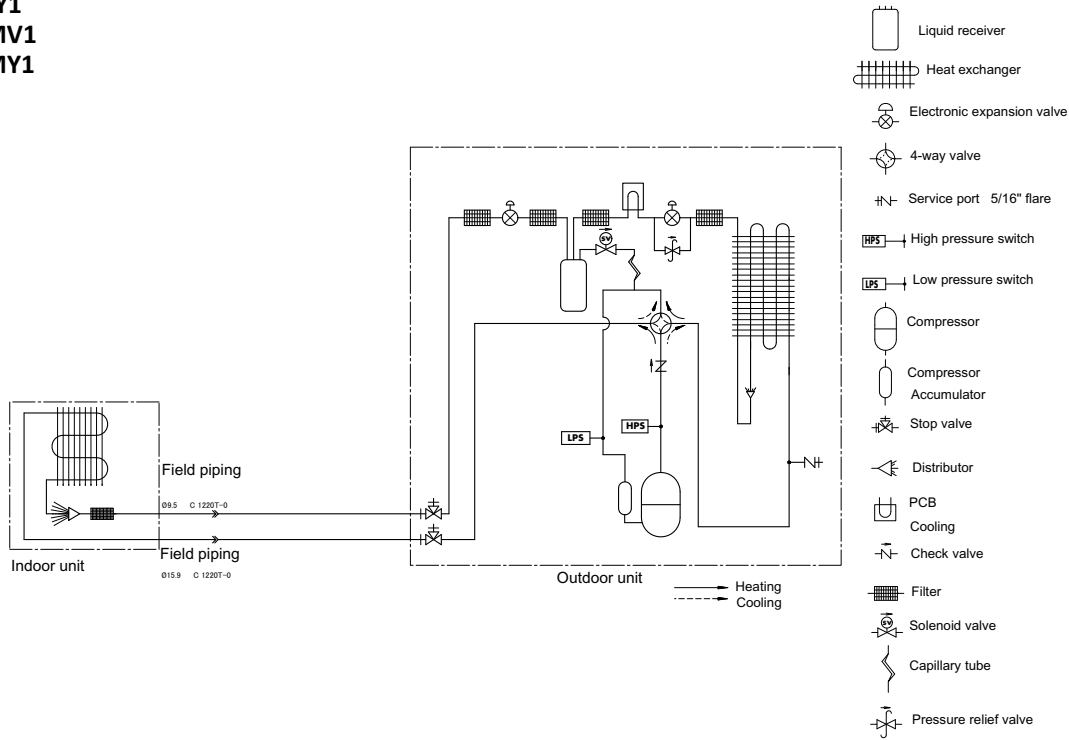

Notes

- The pipes between the branch and the indoor units should have the same size as the indoor connections.

3D108855A

9 Piping diagrams

9 - 2 Piping Diagram Twin Application

9

RZAG-MV1
RZAG-MY1
RZASG-MV1
RZASG-MY1

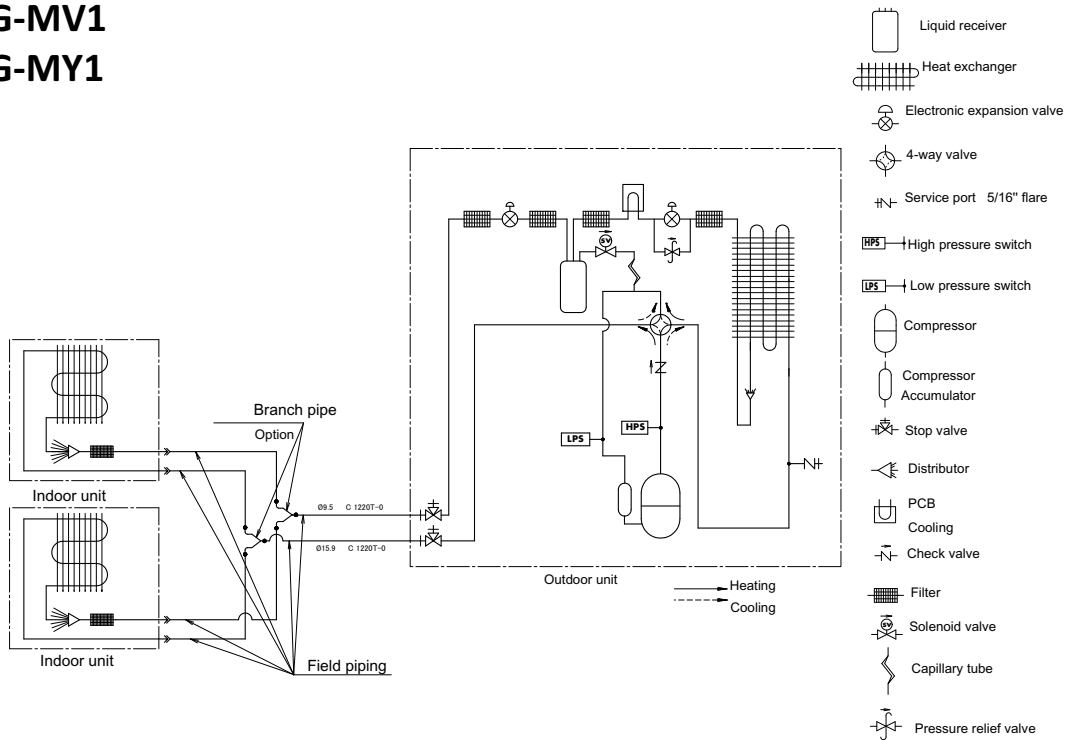

Notes

1. The pipes between the branch and the indoor units should have the same size as the indoor connections.

3D108856A

9 Piping diagrams

9 - 3 Piping Diagram Triple Application

RZAG100-140MV1
RZAG100-140MY1
RZASG100-140MV1
RZASG-MY1

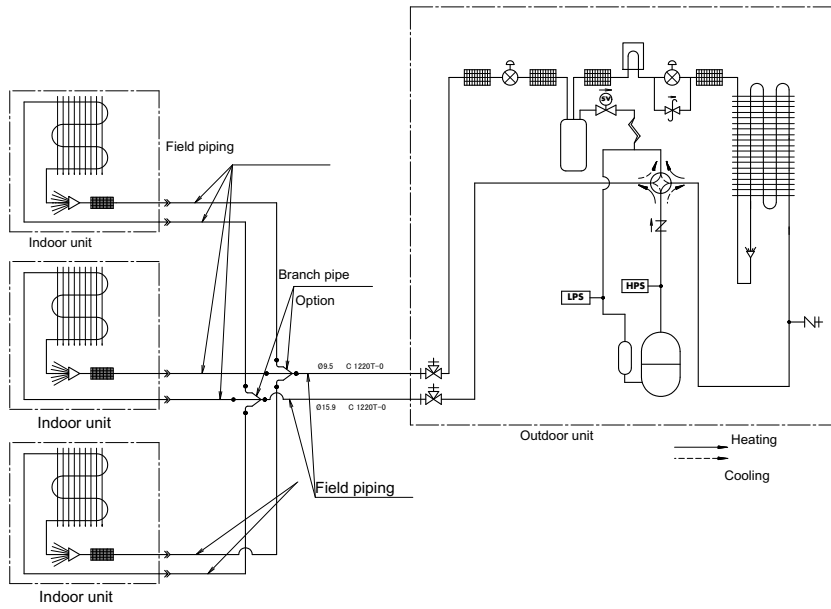

- Liquid receiver
- Heat exchanger
- Electronic expansion valve
- 4-way valve
- Service port 5/16" flare
- High pressure switch
- Low pressure switch
- Compressor
- Compressor Accumulator
- Stop valve
- Distributor
- PCB Cooling
- Check valve
- Filter
- Solenoid valve
- Capillary tube
- Pressure relief valve

Notes

1. The pipes between the branch and the indoor units should have the same size as the indoor connections.

3D108857A

9 Piping diagrams

9 - 4 Piping Diagram Double Twin Application

RZAG125-140MV1
 RZAG125-140MY1
 RZASG125-140MV1
 RZASG125-140MY1

9

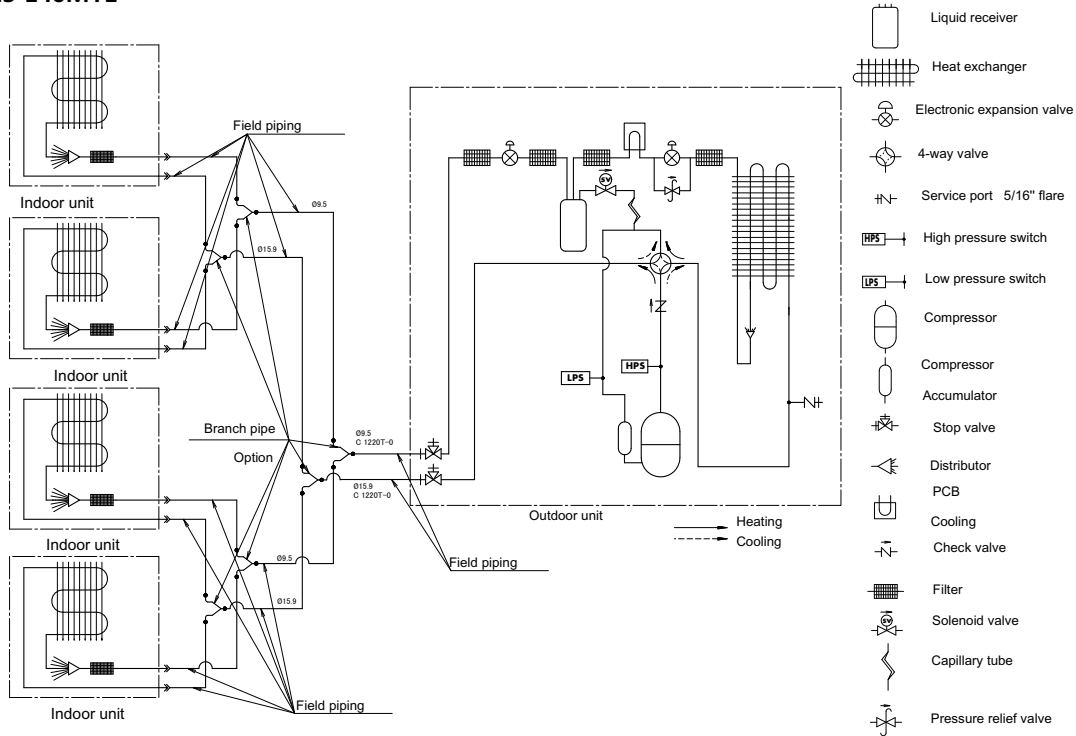

Notes

1. The pipes between the branch and the indoor units should have the same size as the indoor connections.

3D108858A

10 Wiring diagrams

10 - 1 Wiring Diagrams - Three Phase

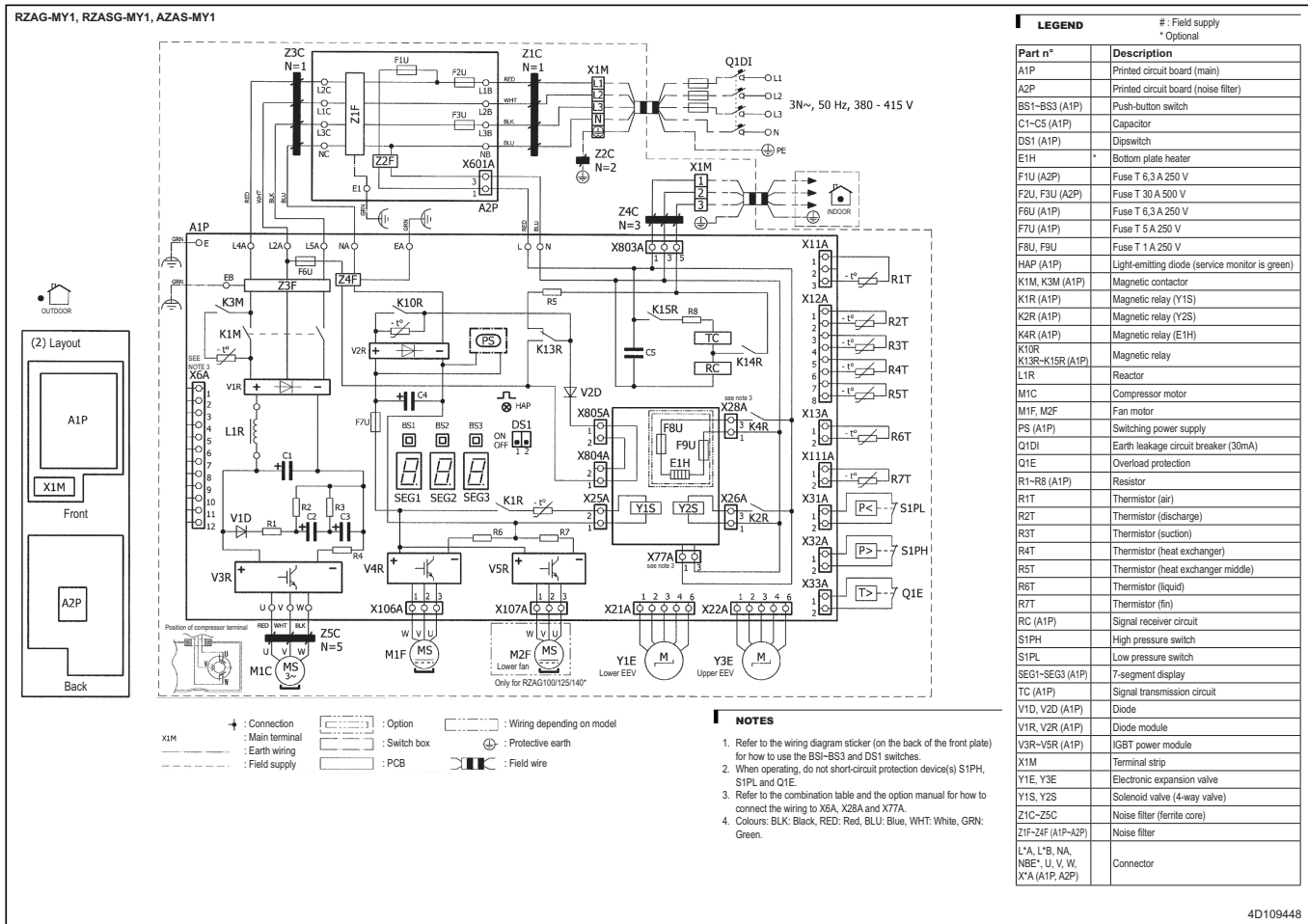

11 Sound data

11 - 1 Sound Power Spectrum

11

AZAS100MV1
 AZAS100MY1
 RZASG100MV1
 RZASG100MY1

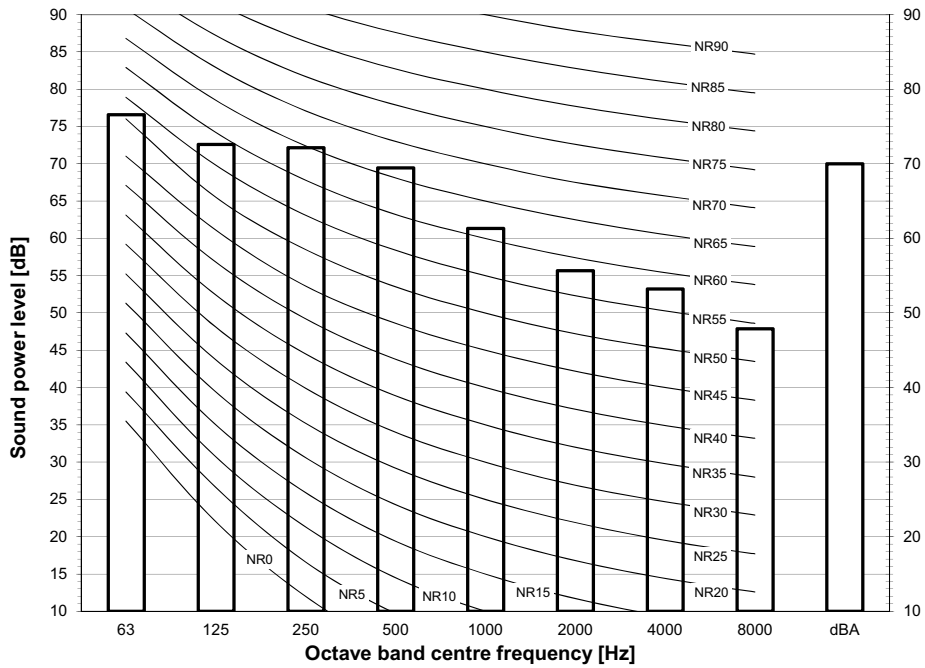

Notes
 - dBA = A-weighted sound power level (A scale according to IEC).
 - Reference acoustic intensity 0dB = 10E-6μW/m²
 - Measured according to ISO 3744

3D110038

AZAS125MV1
 AZAS125MY1
 RZASG125MV1
 RZASG125MY1

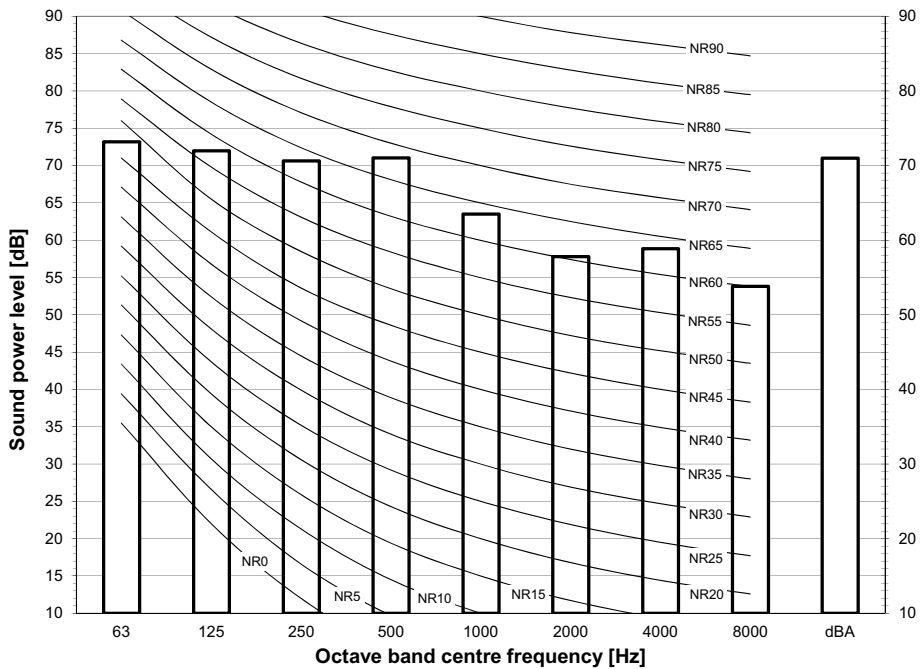

Notes
 - dBA = A-weighted sound power level (A scale according to IEC).
 - Reference acoustic intensity 0dB = 10E-6μW/m²
 - Measured according to ISO 3744

3D110039

11 Sound data

11 - 1 Sound Power Spectrum

AZAS140MV1
 AZAS140MY1
 RZASG140MV1
 RZASG140MY1

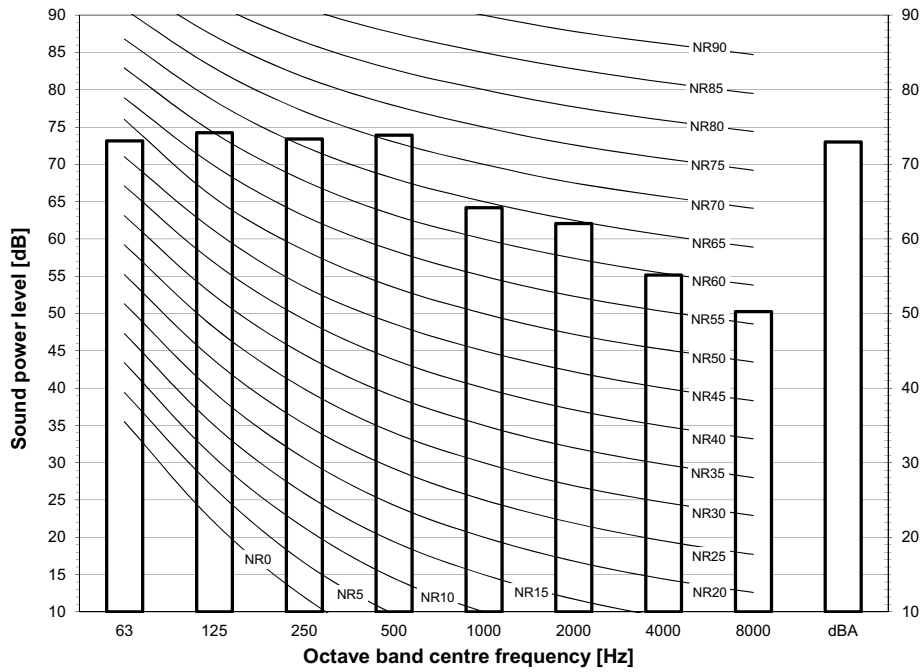

Notes

- dBA = A-weighted sound power level (A scale according to IEC).
- Reference acoustic intensity 0dB = 10E-6μW/m²
- Measured according to ISO 3744

3D110040

11 Sound data

11 - 2 Sound Pressure Spectrum - Cooling

11

AZAS100MV1
 AZAS100MY1
 RZASG100MV1
 RZASG100MY1

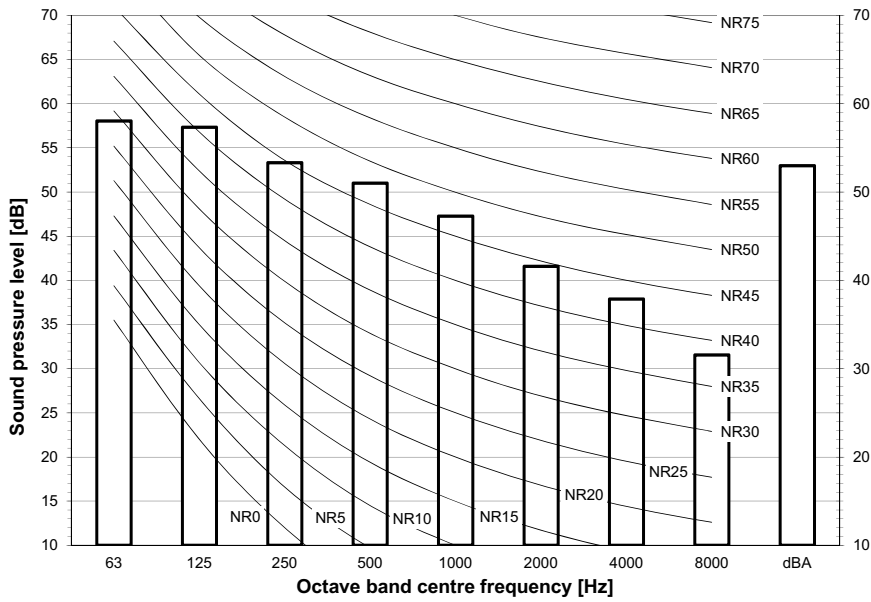

Notes

- Data is valid at free field condition.
- Data is valid at nominal operation condition.
- dBA = A-weighted sound pressure level (A scale according to IEC).
- Reference acoustic pressure 0 dB = 20 μ Pa

3D110050

AZAS125MV1
 AZAS125MY1
 RZASG125MV1
 RZASG125MY1

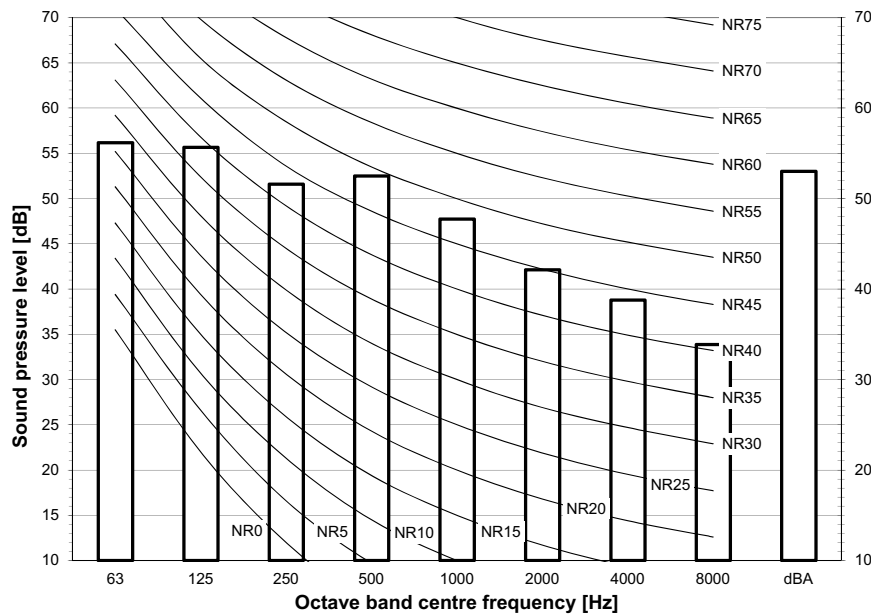

Notes

- Data is valid at free field condition.
- Data is valid at nominal operation condition.
- dBA = A-weighted sound pressure level (A scale according to IEC).
- Reference acoustic pressure 0 dB = 20 μ Pa

3D110051

11 Sound data

11 - 2 Sound Pressure Spectrum - Cooling

AZAS140MV1
 AZAS140MY1
 RZASG140MV1
 RZASG140MY1

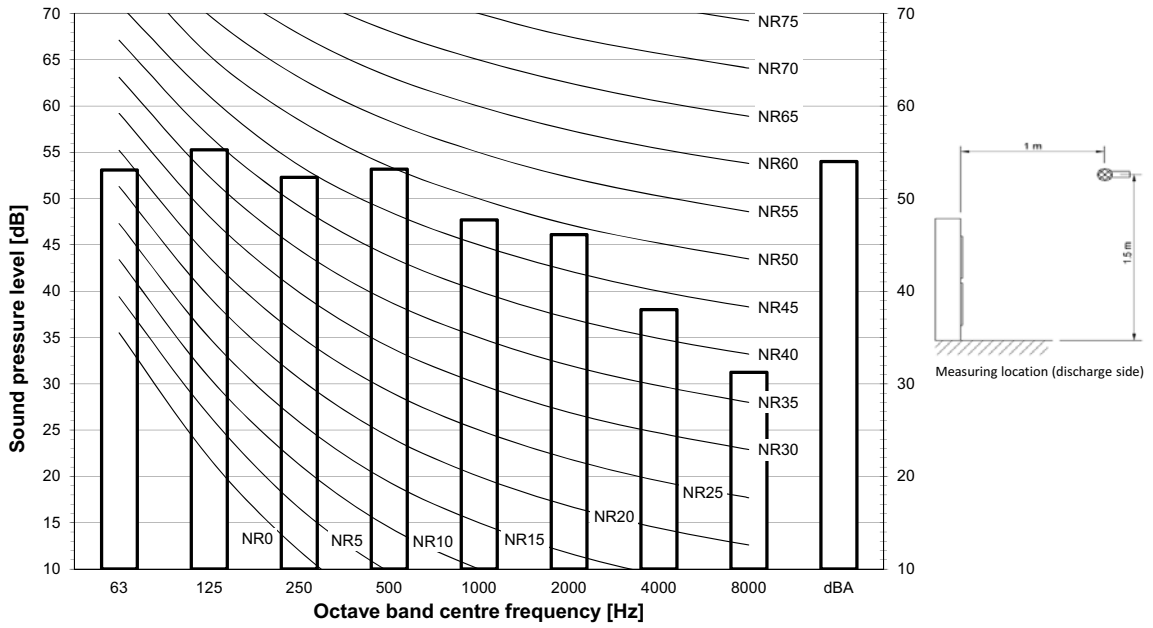

Notes

- Data is valid at free field condition.
- Data is valid at nominal operation condition.
- dBA = A-weighted sound pressure level (A scale according to IEC).
- Reference acoustic pressure 0 dB = 20 μPa

3D111310

11 Sound data

11 - 3 Sound Pressure Spectrum - Heating

11

AZAS100MV1
 AZAS100MY1
 RZASG100MV1
 RZASG100MY1

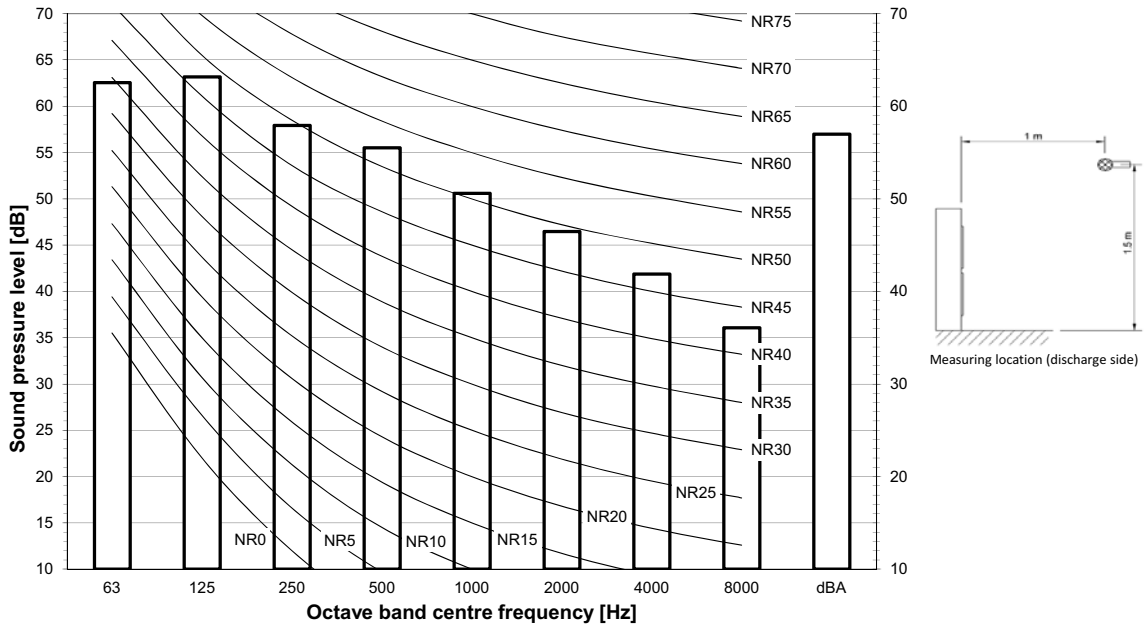

Notes

- Data is valid at free field condition.
- Data is valid at nominal operation condition.
- dBA = A-weighted sound pressure level (A scale according to IEC).
- Reference acoustic pressure 0 dB = 20 µPa

3D111294

AZAS125MV1
 AZAS125MY1
 RZASG125MV1
 RZASG125MY1

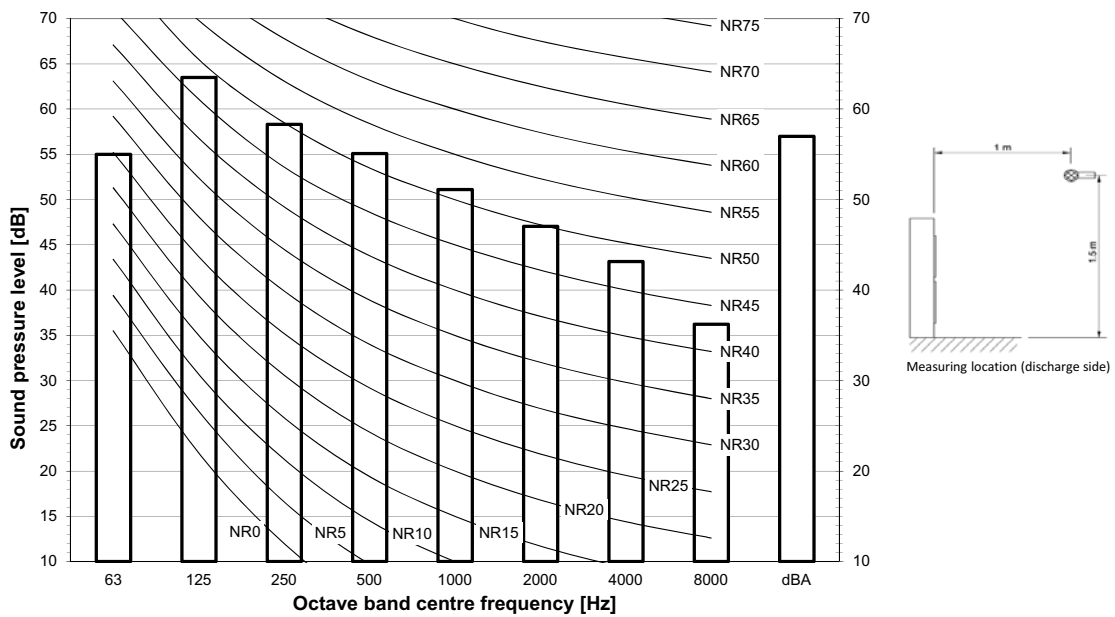

Notes

- Data is valid at free field condition.
- Data is valid at nominal operation condition.
- dBA = A-weighted sound pressure level (A scale according to IEC).
- Reference acoustic pressure 0 dB = 20 µPa

3D111295

11 Sound data

11 - 3 Sound Pressure Spectrum - Heating

AZAS140MV1
 AZAS140MY1
 RZASG140MV1
 RZASG140MY1

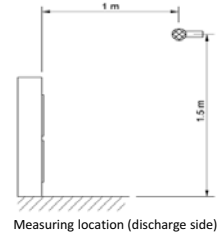
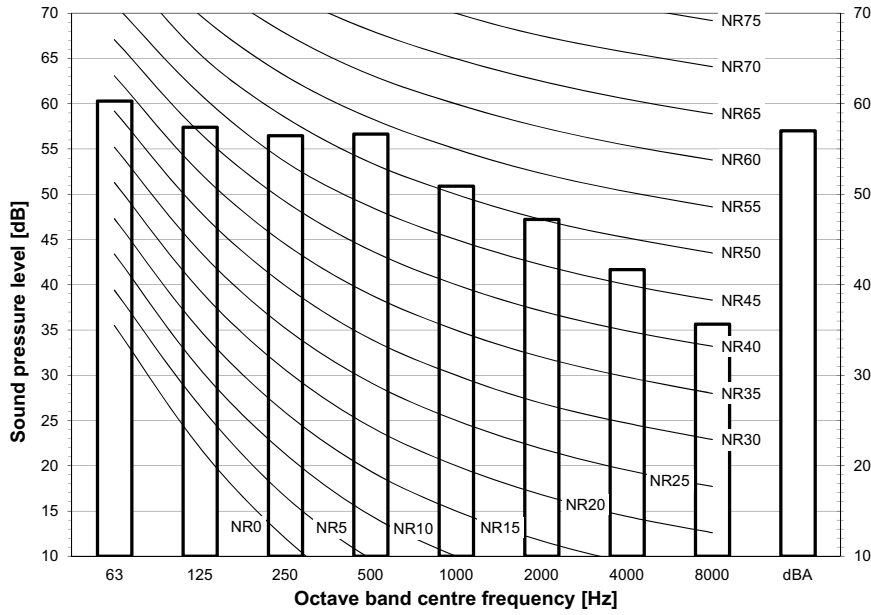

Notes

- Data is valid at free field condition.
- Data is valid at nominal operation condition.
- dBA = A-weighted sound pressure level (A scale according to IEC).
- Reference acoustic pressure 0 dB = 20 μPa

3D111296

11 Sound data

11 - 4 Sound Pressure Spectrum Quiet Mode

11

AZAS100MV1
 AZAS100MY1
 RZASG100MV1
 RZASG100MY1

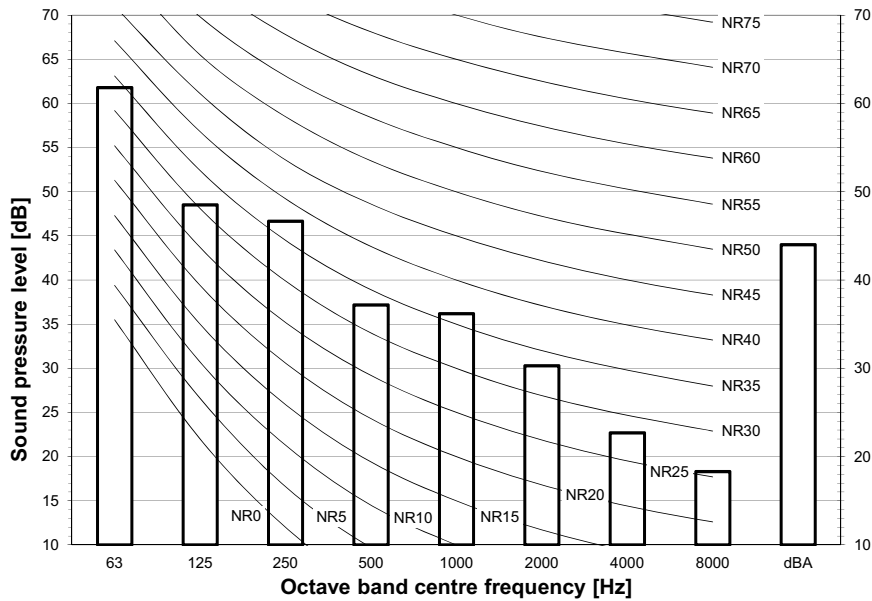

Notes
 - Data is valid at free field condition.
 - Data is valid at nominal operation condition.
 - dBA = A-weighted sound pressure level (A scale according to IEC).
 - Reference acoustic pressure 0 dB = 20 µPa

3D111316

AZAS125MV1
 AZAS125MY1
 RZASG125MV1
 RZASG125MY1

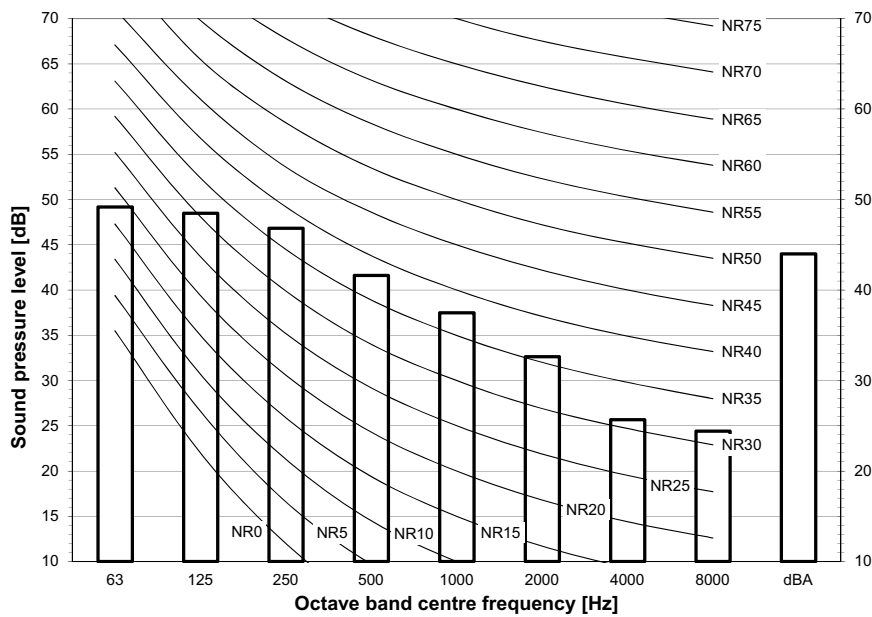

Notes
 - Data is valid at free field condition.
 - Data is valid at nominal operation condition.
 - dBA = A-weighted sound pressure level (A scale according to IEC).
 - Reference acoustic pressure 0 dB = 20 µPa

3D111317

11 Sound data

11 - 4 Sound Pressure Spectrum Quiet Mode

AZAS140MV1
 AZAS140MY1
 RZASG140MV1
 RZASG140MY1

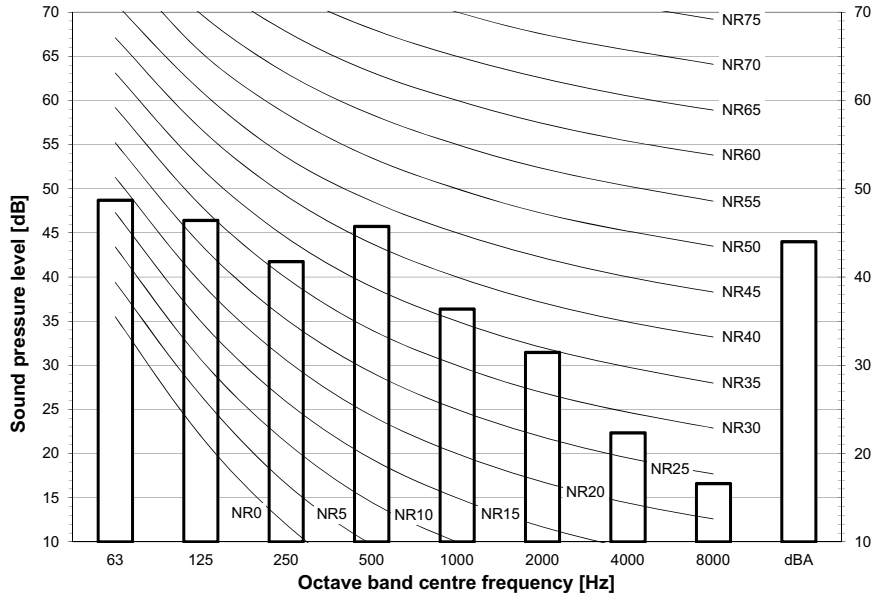

Notes

- Data is valid at free field condition.
- Data is valid at nominal operation condition.
- dBA = A-weighted sound pressure level (A scale according to IEC).
- Reference acoustic pressure 0 dB = 20 μPa

3D111318

12 Installation

12 - 1 Installation Method

RZAG-MV1
 RZAG-MY1
 RZASG-MV1
 RZASG-MY1
 AZAS-MV1
 AZAS-MY1

Installation service space

The measure of these values is "mm".

(A) When there are obstacles on suction sides.

• No obstacle above

- ① Stand-alone installation
 - Obstacle on the suction side only

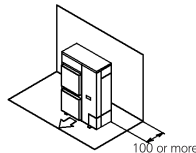

- Obstacle on both sides and suction side, too

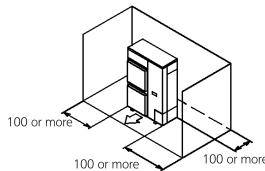

- ② Series installation (2 or more) (Note 1)
 - Obstacle on the suction side and both sides

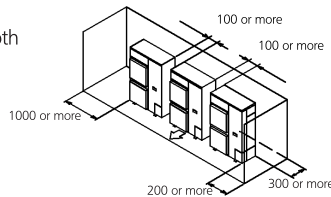

• Obstacle above, too.

- ① Stand-alone installation
 - Obstacle on the suction side, too

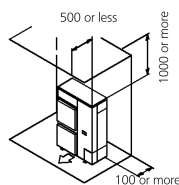

- Obstacle on both sides and suction side, too

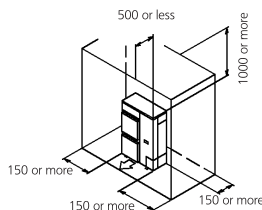

- ② Series installation (2 or more) (Note 1)
 - Obstacle on the suction side and both sides

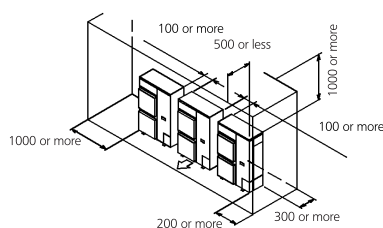

(B) When there are obstacles on discharge sides.

• No obstacle above

- ① Stand-alone installation
 - Obstacle on the discharge side only

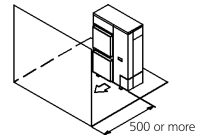

- ② Series installation (2 or more) (Note 1)
 - Obstacle on the discharge side only

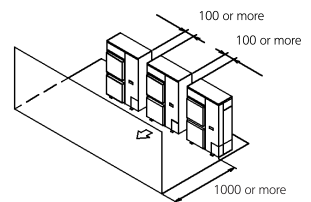

• Obstacle above, too

- ① Stand-alone installation
 - Obstacle on the discharge side only, too

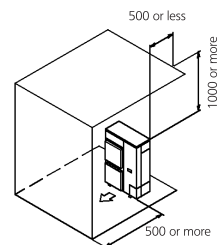

- ② Series installation (2 or more) (Note 1)
 - Obstacle on the discharge side

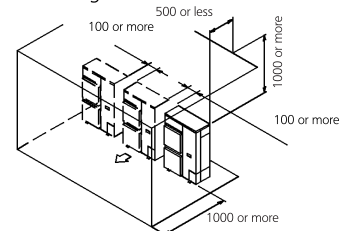

(C) When there are obstacles on both suction and discharge sides.

Pattern 1

When the obstacles on the discharge side is higher than the unit. (L>H)
 (There is no limit for the height of obstructions on the suction side.)

• No obstacle above

- ① Stand-alone installation
 - No obstacle above

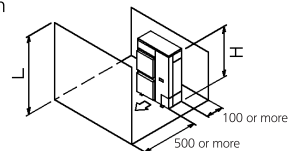

- ② Series installation (2 or more) (Note 1)
 - No obstacle above

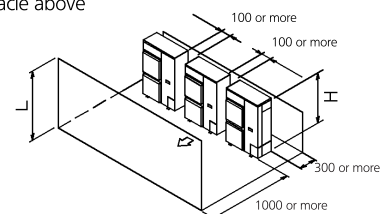

12 Installation

12 - 1 Installation Method

RZAG-MV1
 RZAG-MY1
 RZASG-MV1
 RZASG-MY1
 AZAS-MV1
 AZAS-MY1

• Obstacle above, too

- ① Stand-alone installation (Note 2)
 - When there are obstacles on suction, discharge and top sides.

The relations between H, A and L are as follows.

	L	A
$L \leq H$	$L \leq 1/2 H$ $1/2 H < L \leq H$	750 or more 1000 or more
$L > H$	Set the stand as : $L \leq H$ Refer to the column of $L \leq H$ for A	

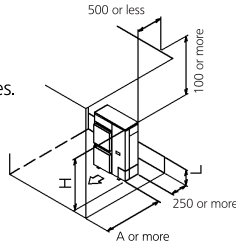

- ② Series installation (2 or more) (Note 1, 2)
 - When there are obstacles on suction, discharge and top sides.

The relations between H, A and L are as follows.

	L	A
$L \leq H$	$L \leq 1/2 H$ $1/2 H < L \leq H$	1000 or more 1250 or more
$L > H$	Set the stand as : $L \leq H$ Refer to the column of $L \leq H$ for A	

Limit of series installation is 2 units.

Pattern 2

When the obstacle on the discharge side is lower than the unit ($L \leq H$) (There is no limit for the height of obstructions on the suction side.)

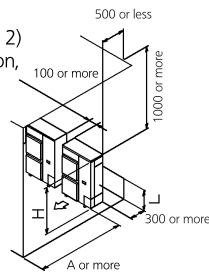

• No obstacle above

- ① Stand-alone installation
 - No obstacle above

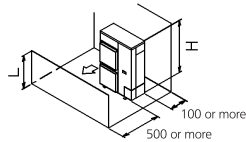

- ② Series installation (2 or more) (Note 1, 2)
 - When there are obstacles on both suction and discharge sides.

The relations between H, A and L are as follows.

	L	A
$L \leq H$	$L \leq 1/2 H$ $1/2 H < L \leq H$	250 or more 300 or more

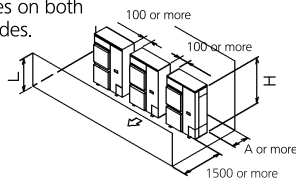

• obstacle above

- ① Stand-alone installation (Note 2)
 - When there are obstacles on suction, discharge and top sides.

The relations between H, A and L are as follows.

	L	A
$L \leq H$	$L \leq 1/2 H$ $1/2 H < L \leq H$	100 or more 200 or more
$L > H$	Set the stand as : $L \leq H$ Refer to the column of $L \leq H$ for A	

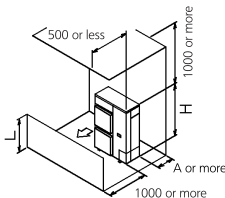

- ② Series installation (2 or more) (Note 1, 2)
 - When there are obstacles on suction, discharge and top sides.

The relations between H, A and L are as follows.

	L	A
$L \leq H$	$L \leq 1/2 H$ $1/2 H < L \leq H$	250 or more 300 or more
$L > H$	Set the stand as : $L \leq H$ Refer to the column of $L \leq H$ for A	

Limit of series installation is 2 units.

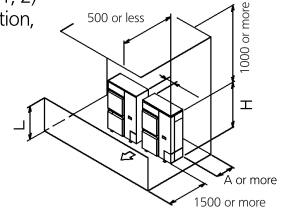

(D) Double-decker installation

- ① Obstacle on the discharge side. (1)
 - Do not exceed two levels for stacked installation.
 - Install a roof cover similar to A (field supply), as outdoor units with downward drainage are prone to dripping and freezing.
 - Install the upper-level outdoor unit so that its bottom plate is a sufficient height above the roof cover. This is to prevent the buildup of ice on the underside of the bottom plate.
- ② Obstacle on the suction side. (1)
 - Do not exceed two levels for stacked installation.
 - Install a roof cover similar to A (field supply), as outdoor units with downward drainage are prone to dripping and freezing.
 - Install the upper-level outdoor unit so that its bottom plate is a sufficient height above the roof cover. This is to prevent the buildup of ice on the underside of the bottom plate.

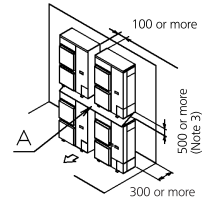
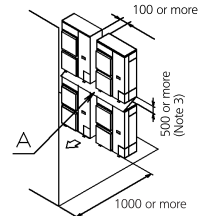

(E) Multiple rows of series installation (on the rooftop, etc.)

- ① One row of stand-alone installation

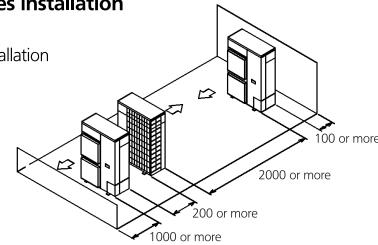

- ② Rows of series installation (2 or more)

The relations between H, A and L are as follows.

	L	A
$L \leq H$	$L \leq 1/2 H$ $1/2 H < L \leq H$	250 or more 300 or more
$L > H$	Can not be installed	

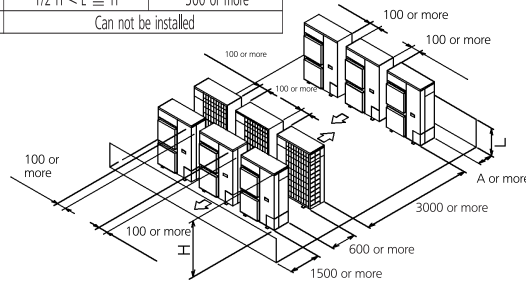

NOTES

- In case of the sideways piping, make a 100mm gap between the unit above.
- Close the bottom of the installation frame to prevent the discharged air from being bypassed.
- It is not necessary to install a roof cover if there is no danger of drainage dripping and freezing. In this case, the space between the upper and lower outdoor units should be at least 100mm. Close off the gap between the upper and lower units so there is no re-intake of discharged air.

13 Operation range

13 - 1 Operation Range

13

RZASG-MV1 RZASG-MY1

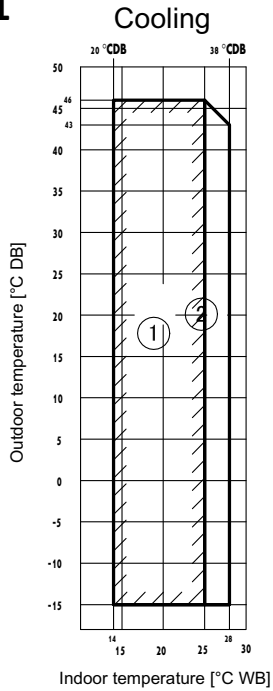

- ① Operation range
- ② Pull-down operation range
- ③ Warm-up operation range

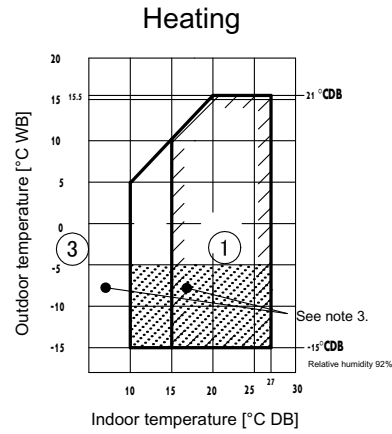

Notes

1. Depending on operation and installation conditions, the indoor unit can change over to freeze-up operation (indoor de-icing).
2. To reduce the freeze-up operation (indoor de-icing) frequency, it is recommended to install the outdoor unit in a location not exposed to wind.
3. In case of high humidity conditions (> 92%) at ambient temperatures of < -5°C, a RZAG model should be used instead to avoid freeze-up of the outdoor unit.

3D110021



Daikin Europe N.V. Naamloze Vennootschap - Zandvoordestraat 300, B-8400 Oostende - Belgium - www.daikin.eu - BE 0412 120 336 - RPR Oostende

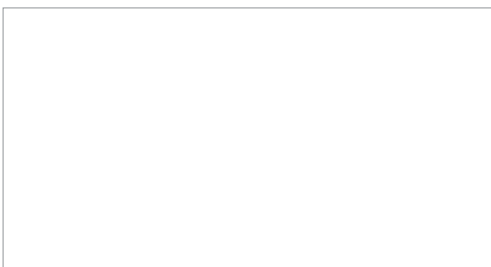

EEDEN17 08/17



Daikin Europe N.V. participates in the Eurovent Certified Performance programme for Liquid Chilling Packages and Hydronic Heat Pumps, Fan Coil Units and Variable Refrigerant Flow systems. Check ongoing validity of certificate: www.eurovent-certification.com



The present leaflet is drawn up by way of information only and does not constitute an offer binding upon Daikin Europe N.V.. Daikin Europe N.V. has compiled the content of this leaflet to the best of its knowledge. No express or implied warranty is given for the completeness, accuracy, reliability or fitness for particular purpose of its content and the products and services presented therein. Specifications are subject to change without prior notice. Daikin Europe N.V. explicitly rejects any liability for any direct or indirect damage, in the broadest sense, arising from or related to the use and/or interpretation of this leaflet. All content is copyrighted by Daikin Europe N.V.