

Air Conditioning
Technical Data

RZASG-MV1



TABLE OF CONTENTS

RZASG-MV1

1	Features	2
2	Specifications	3
	Capacity and Power input	3
	Capacity and Power input	4
	Capacity and Power input	6
	Capacity and Power input	7
	Capacity and Power input	9
	Capacity and Power input	11
	Capacity and Power input	13
	Technical Specifications	15
	Electrical Specifications	16
3	Electrical data	17
4	Options	19
5	Combination table	20
6	Capacity tables	21
	Cooling/Heating Capacity Tables	21
	Capacity Correction Factor	23
7	Dimensional drawings	24
8	Centre of gravity	25
9	Piping diagrams	27
	Piping Diagrams	27
	Piping Diagram Twin Application	28
	Piping Diagram Triple Application	29
	Piping Diagram Double Twin Application	30
10	Wiring diagrams	31
	Wiring Diagrams - Single Phase	31
11	Sound data	33
	Sound Power Spectrum	33
	Sound Pressure Spectrum - Cooling	35
	Sound Pressure Spectrum - Heating	37
	Sound Pressure Spectrum Quiet Mode	39
12	Installation	41
	Installation Method	41
13	Operation range	43
14	Appropriate Indoors	44

1 Features

Technology and comfort combined for commercial applications

- High efficiency: - Energy labels up to A++ (cooling) / A+ (heating) - compressor offers substantial efficiency improvements
- Choosing for an R-32 product, reduces the environmental impact with 68% compared to R-410A, leads directly to lower energy consumption thanks to its high energy efficiency and has a lower refrigerant charge
- Very compact and easy to install
- Replace existing systems with R-32 technology without needing to replace the piping
- Guarantees operation in both heating and cooling mode down to -15°C
- Refrigerant cooled PCB guarantees reliable cooling, as it is not influenced by ambient temperature.
- Maximum piping length up to 50m, minimum piping length has no limitation
- Outdoor units for pair, twin, triple, double twin application



Inverter



Auto cooling-
heating
changeover

2 Specifications

2-1 Capacity and Power input			FCAG71A/RZASG71MV1	FCAG100A/ RZASG100MV1	FCAG125A/ RZASG125MV1	FCAG140A/ RZASG140MV1	
Indoor unit			FCAG71AVEB	FCAG100AVEB	FCAG125AVEB	FCAG140AVEB	
Outdoor unit			RZASG71M2V1B	RZASG100M7V1B	RZASG125M7V1B	RZASG140M7V1B	
Cooling capacity	Nom.	kW	6.80 (1)	9.50 (1)	12.1 (1)	13.4 (1)	
Heating capacity	Nom.	kW	7.50 (2)	10.8 (2)	13.5 (2)	15.5 (2)	
Space cooling	Energy efficiency class		A++		-		
	Capacity	Pdesign	kW	6.80	9.50	12.1	13.4
	SEER			6.47	6.55	5.76	6.53
	ηs,c		%	-		227	258
	Annual energy consumption		kWh/a	368	507	1,261	1,231
	A Condition (35°C - 27/19)	Pdc	kW	6.80	9.50	12.10	13.40
		EERd		3.14	3.26	2.44	2.75
		Power input	kW	2.17	2.92	4.95	4.88
	B Condition (30°C - 27/19)	Pdc	kW	5.10	7.00	8.92	9.88
		EERd		4.91	5.49	4.30	4.88
		Power input	kW	1.04	1.28	2.07	2.03
	C Condition (25°C - 27/19)	Pdc	kW	3.40	4.50	5.74	6.35
		EERd		8.43	7.77	6.74	7.69
		Power input	kW	0.40	0.58	0.85	0.83
D Condition (20°C - 27/19)	Pdc	kW	2.89	3.11	3.18	3.74	
	EERd		12.54	11.16	10.49	12.01	
	Power input	kW	0.23	0.28	0.30	0.31	
Space heating (Average climate)	Energy efficiency class		A	A+	-		
	Capacity	Pdesign	kW	4.50	6.00	7.80	
	SCOP/A			4.00	4.17	4.05	4.31
	SCOPnet/A			4.00	4.17	4.05	4.31
	ηs,h		%	-		159	169
	Annual energy consumption		kWh/a	1,575	2,016	2,074	2,534
	Required back up heating cap at design conditions		kW	0.00			
	TOL	Tol (temperature operating limit)		°C -10			
		Pdh (declared heating cap)	kW	4.50	6.00	7.80	
		COPd (declared COP)		2.31	2.52	2.59	2.26
		Power input	kW	1.94	2.38	2.32	3.44
	TBivalent	Tbiv (bivalent temperature)		°C -10			
		Pdh (declared heating cap)	kW	4.50	6.00	7.80	
		COPd (declared COP)		2.31	2.52	2.59	2.26
		Power input	kW	1.94	2.38	2.32	3.44
	A Condition (-7°C)	Pdh (declared heating cap)	kW	3.98	5.31	5.30	6.90
		COPd (declared COP)		2.31	2.75	2.78	2.60
		Power input	kW	1.72	1.93	1.91	2.65
	B Condition (2°C)	Pdh (declared heating cap)	kW	2.42	3.23	4.20	
		COPd (declared COP)		4.10	3.97	3.88	4.32
		Power input	kW	0.59	0.81	0.83	0.97
	C Condition (7°C)	Pdh (declared heating cap)	kW	1.92	2.10	2.13	3.40
		COPd (declared COP)		5.32	5.58	5.20	5.92
		Power input	kW	0.36	0.38	0.41	0.57
	D Condition (12°C)	Pdh (declared heating cap)	kW	2.29	2.50	2.55	3.99
		COPd (declared COP)		6.74	6.95	6.66	7.26
		Power input	kW	0.34	0.36	0.38	0.55
Pto (Thermostat off)		W	12 / 0	0 / 12	-		
Cooling	Cdc (Degradation cooling)		0.25				

2 Specifications

2-1 Capacity and Power input				FCAG71A/RZASG71MV1	FCAG100A/RZASG100MV1	FCAG125A/RZASG125MV1	FCAG140A/RZASG140MV1
Heating	Cdh (Degradation heating)			0.25			
Cooling function included				Yes			
Heating function included				Yes			
Average climate included				Yes			
Cold season included				No			
Warm season included				No			
Ecolabel logo				No			
Power consumption in other than active mode	Off mode	POFF		W	12		
	Standby mode	Cooling	PSB	W	12		
		Heating	PSB	W	12		
	Thermostat-off mode	PTO	Heating	W	-	12	
			Cooling	W	-	0	
Crankcase heater mode	PCK		W	0			
Indication if the heater is equipped with a supplementary heater (pair application)				-	No		

Notes

(1) Cooling: T2: indoor temp. 26.6°CDB, 19.4°CWB, outdoor temp. 48°CDB [Btu/hr/W]

(2) Nominal heating capacities are based on: indoor temperature: 20°CDB, outdoor temperature: 7°CDB, 6°CWB, equivalent refrigerant piping: 5m, level difference: 0m.

Nominal cooling capacities are based on: indoor temperature: 27°CDB, 19°CWB, outdoor temperature: 35°CDB, equivalent refrigerant piping: 5m, level difference: 0m.

Cooling: indoor temp. 27°CDB, 19.0°CWB; outdoor temp. 35°CDB; equivalent piping length: 5m; level difference: 0m

2-2 Capacity and Power input				FBA71A/RZASG71MV1	FBA100A/RZASG100MV1	FBA125A/RZASG125MV1	FBA140A/RZASG140MV1
Indoor unit				FBA71A2VEB	FBA100A2VEB	FBA125A2VEB	FBA140A2VEB
Outdoor unit				RZASG71M2V1B	RZASG100M7V1B	RZASG125M7V1B	RZASG140M7V1B
Cooling capacity	Nom.	kW	6.80 (1)	9.50 (1)	12.1 (1)	13.4 (1)	
Heating capacity	Nom.	kW	7.50 (2)	10.8 (2)	13.5 (2)	15.5 (2)	
Space cooling	Energy efficiency class		A++	A+	-		
	Capacity	Pdesign	kW	6.80	9.50	12.1	13.4
	SEER			6.19	5.83	5.49	5.81
	ηs,c		%	-			
	Annual energy consumption		kWh/a	385	570	1,322	1,384
	A Condition (35°C - 27/19)	Pdc	kW	6.80	9.50	12.10	13.40
		EERd		3.60	3.20	2.61	2.81
		Power input	kW	1.89	2.97	4.64	4.76
	B Condition (30°C - 27/19)	Pdc	kW	5.02	7.00	8.92	9.88
		EERd		5.30	5.13	4.34	4.66
		Power input	kW	0.95	1.36	2.06	2.12
	C Condition (25°C - 27/19)	Pdc	kW	3.23	4.50	5.74	6.35
		EERd		7.84	7.01	6.36	6.84
		Power input	kW	0.41	0.64	0.90	0.93
	D Condition (20°C - 27/19)	Pdc	kW	2.92	3.10	3.17	3.97
EERd		9.87	8.59	8.72	8.83		
Power input		kW	0.30	0.36		0.45	

2 Specifications

2-2 Capacity and Power input				FBA71A/RZASG71MV1	FBA100A/RZASG100MV1	FBA125A/RZASG125MV1	FBA140A/RZASG140MV1	
Space heating (Average climate)	Energy efficiency class			A+		A		-
	Capacity	Pdesign	kW	4.50	6.00		7.80	
	SCOP/A			4.01	3.85	3.63	3.85	
	SCOPnet/A			4.01	3.85	3.63	3.85	
	ηs,h		%	-		142	151	
	Annual energy consumption		kWh/a	1,571	2,182	2,314	2,836	
	Required back up heating cap at design conditions		kW	0.00				
	TOL	Tol (temperature operating limit)		°C				
		Pdh (declared heating cap)		4.50	6.00		7.80	
		COPd (declared COP)		2.37	2.45	2.50	2.06	
		Power input		1.90	2.45	2.40	3.78	
	TBivalent	Tbiv (bivalent temperature)		°C				
		Pdh (declared heating cap)		4.50	6.00		7.80	
		COPd (declared COP)		2.37	2.45	2.50	2.06	
		Power input		1.90	2.45	2.40	3.78	
	A Condition (-7°C)	Pdh (declared heating cap)		3.98	5.31	5.30		6.90
		COPd (declared COP)		2.66	2.69	2.72	2.46	
		Power input		1.50	1.97	1.95	2.81	
	B Condition (2°C)	Pdh (declared heating cap)		2.42	3.23		4.20	
		COPd (declared COP)		4.12	3.77	3.53	3.94	
		Power input		0.59	0.86	0.91	1.07	
	C Condition (7°C)	Pdh (declared heating cap)		2.06	2.26	2.27		3.50
		COPd (declared COP)		5.04	4.83	4.37		4.98
		Power input		0.41	0.47	0.52	0.70	
	D Condition (12°C)	Pdh (declared heating cap)		2.43	2.57	2.66		4.10
		COPd (declared COP)		6.19	5.70	5.36		6.10
		Power input		0.39	0.45	0.50	0.67	
Pto (Thermostat off)			W	14 / 0		-		
Cooling	Cdc (Degradation cooling)			0.25				
Heating	Cdh (Degradation heating)			0.25				
Cooling function included				Yes				
Heating function included				Yes				
Average climate included				Yes				
Cold season included				No				
Warm season included				No				
Ecolabel logo				No				
Power consumption in other than active mode	Thermostat-off mode	PTO	Heating	W	-	14		
			Cooling	W	-	0		
	Standby mode	Cooling	PSB	W	14			
			Heating	PSB	W	14		
	Crankcase heater mode	PCK		W	0			
	Off mode	POFF		W	14			
Indication if the heater is equipped with a supplementary heater (pair application)				-		No		

2 Specifications

Notes

(1) Cooling: T2: indoor temp. 26,6°CDB, 19,4°CWB, outdoor temp. 48°CDB [Btu/hr/W]

(2) Nominal heating capacities are based on: indoor temperature: 20°CDB, outdoor temperature: 7°CDB, 6°CWB, equivalent refrigerant piping: 5m, level difference: 0m.

Nominal cooling capacities are based on: indoor temperature: 27°CDB, 19°CWB, outdoor temperature: 35°CDB, equivalent refrigerant piping: 5m, level difference: 0m.

Cooling: indoor temp. 27°CDB, 19,0°CWB; outdoor temp. 35°CDB; equivalent piping length: 5m; level difference: 0m

2-3 Capacity and Power input				FDA125A/RZASG125MV1	
Indoor unit				FDA125A5VEB	
Outdoor unit				RZASG125M7V1B	
Cooling capacity	Nom.		kW	12.1	
Heating capacity	Nom.		kW	13.5	
Space cooling	Capacity	Pdesign	kW	12.1	
	SEER			5.03	
	ηs,c			198	
	Annual energy consumption			kWh/a	1,444
	A Condition (35°C - 27/19)	Pdc	kW	12.10	
		EERd		2.56	
		Power input	kW	4.73	
	B Condition (30°C - 27/19)	Pdc	kW	8.92	
		EERd		4.03	
		Power input	kW	2.21	
	C Condition (25°C - 27/19)	Pdc	kW	5.74	
		EERd		5.89	
		Power input	kW	0.97	
D Condition (20°C - 27/19)	Pdc	kW	3.10		
	EERd		7.31		
	Power input	kW	0.42		

2 Specifications

2-3 Capacity and Power input				FDA125A/RZASG125MV1		
Space heating (Average climate)	Capacity	Pdesign	kW	6.00		
	SCOP/A			3.58		
	SCOPnet/A			3.58		
	ηs,h			140		
	Annual energy consumption			kWh/a		2,346
	Required back up heating cap at design conditions			kW		0.00
	TOL	Tol (temperature operating limit)	°C	-10		
			Pdh (declared heating cap)	kW	6.00	
			COPd (declared COP)		2.54	
			Power input	kW	2.36	
	TBivalent	Tbiv (bivalent temperature)	°C	-10		
			Pdh (declared heating cap)	kW	6.00	
			COPd (declared COP)		2.54	
			Power input	kW	2.36	
	A Condition (-7°C)	Pdh (declared heating cap)	kW	5.30		
			COPd (declared COP)		2.76	
			Power input	kW	1.92	
	B Condition (2°C)	Pdh (declared heating cap)	kW	3.23		
			COPd (declared COP)		3.54	
			Power input	kW	0.91	
	C Condition (7°C)	Pdh (declared heating cap)	kW	2.29		
			COPd (declared COP)		4.27	
			Power input	kW	0.54	
	D Condition (12°C)	Pdh (declared heating cap)	kW	2.65		
COPd (declared COP)			5.00			
Power input			kW	0.53		
Cooling	Cdc (Degradation cooling)			0.25		
Heating	Cdh (Degradation heating)			0.25		
Cooling function included				Yes		
Heating function included				Yes		
Average climate included				Yes		
Cold season included				No		
Warm season included				No		
Ecolabel logo				No		
Power consumption in other than active mode	Off mode	POFF		W		15
	Standby mode	Cooling	PSB	W		15
		Heating	PSB	W		15
	Thermostat-off mode	PTO	Heating	W		15
			Cooling	W		0
Crankcase heater mode	PCK		W		0	
Indication if the heater is equipped with a supplementary heater (pair application)				No		

2-4 Capacity and Power input				FAA71A/RZASG71MV1	FAA100A/RZASG100MV1
Indoor unit				FAA71AUVEB	FAA100AUVEB
Outdoor unit				RZASG71M2V1B	RZASG100M7V1B
Cooling capacity	Nom.	kW		6.80 (1)	9.50 (1)
Heating capacity	Nom.	kW		7.50 (2)	10.8 (2)

2 Specifications

2-4 Capacity and Power input			FAA71A/RZASG71MV1	FAA100A/RZASG100MV1	
Space cooling	Energy efficiency class		A++		
	Capacity	Pdesign kW	6.80	9.50	
	SEER		6.41	5.83	
	Annual energy consumption kWh/a		371	570	
	A Condition (35°C - 27/19)	Pdc kW	6.80	9.50	
		EERd		3.40	2.70
		Power input kW	2.00	3.52	
	B Condition (30°C - 27/19)	Pdc kW	5.02	7.00	
		EERd		5.30	4.87
		Power input kW	0.95	1.44	
	C Condition (25°C - 27/19)	Pdc kW	3.23	4.50	
		EERd		7.98	6.85
		Power input kW	0.40	0.66	
	D Condition (20°C - 27/19)	Pdc kW	2.84	3.00	
EERd		11.17	10.23		
Power input kW		0.25	0.29		
Space heating (Average climate)	Energy efficiency class		A		
	Capacity	Pdesign kW	4.50	6.00	
	SCOP/A		3.90	3.85	
	SCOPnet/A		3.90	3.85	
	Annual energy consumption kWh/a		1,615	2,182	
	Required back up heating cap at design conditions kW		0.00		
	TOL	Tol (temperature operating limit)	°C	-10	
		Pdh (declared heating cap)	kW	4.50	6.00
		COPd (declared COP)		2.16	2.31
		Power input	kW	2.08	2.60
	TBivalent	Tbiv (bivalent temperature)	°C	-10	
		Pdh (declared heating cap)	kW	4.50	6.00
		COPd (declared COP)		2.16	2.31
		Power input	kW	2.08	2.60
	A Condition (-7°C)	Pdh (declared heating cap)	kW	3.98	5.31
		COPd (declared COP)		2.44	2.55
		Power input	kW	1.63	2.08
	B Condition (2°C)	Pdh (declared heating cap)	kW	2.42	3.23
		COPd (declared COP)		3.90	3.68
		Power input	kW	0.62	0.88
	C Condition (7°C)	Pdh (declared heating cap)	kW	2.02	2.12
		COPd (declared COP)		5.26	5.09
		Power input	kW	0.38	0.42
	D Condition (12°C)	Pdh (declared heating cap)	kW	2.39	2.52
		COPd (declared COP)		6.62	6.53
		Power input	kW	0.36	0.39
	Pto (Thermostat off)		W	12 / 0	0 / 12
	Cooling	Cdc (Degradation cooling)		0.25	
	Heating	Cdh (Degradation heating)		0.25	
	Cooling function included			Yes	
Heating function included			Yes		
Average climate included			Yes		
Cold season included			No		
Warm season included			No		
Ecolabel logo			No		

2 Specifications

2-4 Capacity and Power input				FAA71A/RZASG71MV1	FAA100A/RZASG100MV1
Power consumption in other than active mode	Off mode	POFF		W	12
	Standby mode	Cooling	PSB	W	12
		Heating	PSB	W	12
	Crankcase heater mode	PCK		W	0

Notes

(1) Cooling: T2: indoor temp. 26,6°CDB, 19,4°CWB, outdoor temp. 48°CDB [Btu/hr/W]

(2) Nominal heating capacities are based on: indoor temperature: 20°CDB, outdoor temperature: 7°CDB, 6°CWB, equivalent refrigerant piping: 5m, level difference: 0m.

Nominal cooling capacities are based on: indoor temperature: 27°CDB, 19°CWB, outdoor temperature: 35°CDB, equivalent refrigerant piping: 5m, level difference: 0m.

2-5 Capacity and Power input				FHA71A/RZASG71MV1	FHA100A/RZASG100MV1	FHA125A/RZASG125MV1	FHA140A/RZASG140MV1	
Indoor unit				FHA71AVEB	FHA100AVEB	FHA125AVEB	FHA140AVEB	
Outdoor unit				RZASG71M2V1B	RZASG100M7V1B	RZASG125M7V1B	RZASG140M7V1B	
Cooling capacity	Nom.	kW		6.80 (1)	9.50 (1)	12.1 (1)	13.4 (1)	
Heating capacity	Nom.	kW		7.50 (2)	10.8 (2)	13.5 (2)	15.5 (2)	
Space cooling	Energy efficiency class			A+				
	Capacity	Pdesign	kW	6.80	9.50	12.1	13.4	
	SEER			5.95	5.83		5.88	
	ηs,c			-				
	Annual energy consumption			kWh/a	400	570	1,246	1,368
	A Condition (35°C - 27/19)	Pdc	kW	6.80	9.50	12.10	13.40	
		EERd			3.81	3.20	2.63	2.77
		Power input			kW	1.78	2.97	4.60
	B Condition (30°C - 27/19)	Pdc	kW	5.02	7.00	8.92	9.88	
		EERd			4.84	4.91	4.53	4.59
		Power input			kW	1.04	1.43	1.97
	C Condition (25°C - 27/19)	Pdc	kW	3.28	4.50	5.74	6.35	
		EERd			7.45	6.98	6.79	6.85
		Power input			kW	0.44	0.64	0.85
D Condition (20°C - 27/19)	Pdc	kW	3.39	3.10	3.17	3.86		
	EERd			9.41	8.87	9.62	9.50	
	Power input			kW	0.36	0.35	0.33	0.41

2 Specifications

2-5 Capacity and Power input				FHA71A/RZASG71MV1	FHA100A/RZASG100MV1	FHA125A/RZASG125MV1	FHA140A/RZASG140MV1	
Space heating (Average climate)	Energy efficiency class			A				-
	Capacity	Pdesign	kW	4.50	6.00		7.80	
	SCOP/A			3.90	3.91	3.83	3.81	
	SCOPnet/A			3.90	3.91	3.83	3.81	
	ηs,h		%	-			150	149
	Annual energy consumption			kWh/a	1,616	2,148	2,193	2,866
	Required back up heating cap at design conditions			kW	0.00			
	TOL	Tol (temperature operating limit)		°C	-10			
		Pdh (declared heating cap)		kW	4.50	6.00		7.80
		COPd (declared COP)			2.21	2.49		1.98
		Power input		kW	2.04	2.41		3.95
	TBivalent	Tbiv (bivalent temperature)		°C	-10			
		Pdh (declared heating cap)		kW	4.50	6.00		7.80
		COPd (declared COP)			2.21	2.49		1.98
		Power input		kW	2.04	2.41		3.95
	A Condition (-7°C)	Pdh (declared heating cap)		kW	3.98	5.31	5.30	6.90
		COPd (declared COP)			2.48	2.73	2.72	2.37
		Power input		kW	1.61	1.94	1.95	2.91
	B Condition (2°C)	Pdh (declared heating cap)		kW	2.42	3.23		4.20
		COPd (declared COP)			3.89	3.77	3.68	3.92
		Power input		kW	0.62	0.86	0.88	1.07
	C Condition (7°C)	Pdh (declared heating cap)		kW	2.04	2.18	2.19	3.45
		COPd (declared COP)			5.22	4.96	4.84	4.95
		Power input		kW	0.39	0.44	0.45	0.70
	D Condition (12°C)	Pdh (declared heating cap)		kW	2.41	2.57	2.58	4.05
		COPd (declared COP)			6.57	6.14	6.00	6.07
		Power input		kW	0.37	0.42	0.43	0.67
Pto (Thermostat off)			W	12 / 0	0 / 12	-		
Cooling	Cdc (Degradation cooling)			0.25				
Heating	Cdh (Degradation heating)			0.25				
Cooling function included				Yes				
Heating function included				Yes				
Average climate included				Yes				
Cold season included				No				
Warm season included				No				
Ecolabel logo				No				
Power consumption in other than active mode	Off mode		POFF	W	12			
	Standby mode	Cooling	PSB	W	12			
		Heating	PSB	W	12			
	Thermostat-off mode	PTO	Heating	W	-	12		
			Cooling	W	-	0		
Crankcase heater mode	PCK		W	0				
Indication if the heater is equipped with a supplementary heater (pair application)				-				

2 Specifications

Notes

(1) Cooling: T2: indoor temp. 26,6°CDB, 19,4°CWB, outdoor temp. 48°CDB [Btu/hr/W]

(2) Nominal heating capacities are based on: indoor temperature: 20°CDB, outdoor temperature: 7°CDB, 6°CWB, equivalent refrigerant piping: 5m, level difference: 0m.

Nominal cooling capacities are based on: indoor temperature: 27°CDB, 19°CWB, outdoor temperature: 35°CDB, equivalent refrigerant piping: 5m, level difference: 0m.

Cooling: indoor temp. 27°CDB, 19.0°CWB; outdoor temp. 35°CDB; equivalent piping length: 5m; level difference: 0m

2-6 Capacity and Power input				FUA71A/RZASG71MV1	FUA100A/RZASG100MV1	FUA125A/RZASG125MV1	
Indoor unit				FUA71AVEB	FUA100AVEB	FUA125AVEB	
Outdoor unit				RZASG71M2V1B	RZASG100M7V1B	RZASG125M7V1B	
Cooling capacity	Nom.	kW	6.80 (1)	9.50 (1)	12.1 (1)		
Heating capacity	Nom.	kW	7.50 (2)	10.8 (2)	13.5 (2)		
Space cooling	Energy efficiency class			A++	A+	-	
	Capacity	Pdesign	kW	6.80	9.50	12.1	
	SEER			6.16	5.83	5.49	
	ηs,c		%	-			
	Annual energy consumption			kWh/a	386	570	1,322
	A Condition (35°C - 27/19)	Pdc	kW	6.80	9.50	12.10	
		EERd			3.84	3.20	2.35
		Power input	kW	1.77	2.97	5.15	
	B Condition (30°C - 27/19)	Pdc	kW	5.02	7.00	8.92	
		EERd			4.98	4.81	4.24
		Power input	kW	1.01	1.45	2.10	
	C Condition (25°C - 27/19)	Pdc	kW	3.23	4.50	5.74	
		EERd			7.82	7.04	6.48
		Power input	kW	0.41	0.64	0.89	
D Condition (20°C - 27/19)	Pdc	kW	3.04	3.10	3.14		
	EERd			9.69	8.98	9.22	
	Power input	kW	0.31	0.35	0.34		

2 Specifications

2-6 Capacity and Power input				FUA71A/RZASG71MV1	FUA100A/RZASG100MV1	FUA125A/RZASG125MV1	
Space heating (Average climate)	Energy efficiency class			A	A+	-	
	Capacity	Pdesign	kW	4.50	6.00		
	SCOP/A			3.90	4.01	3.84	
	SCOPnet/A			3.90	4.01	3.84	
	ηs,h		%	-		151	
	Annual energy consumption			kWh/a	1,615	2,095	2,188
	Required back up heating cap at design conditions			kW	0.00		
	TOL	Tol (temperature operating limit)		°C	-10		
		Pdh (declared heating cap)		kW	4.50	6.00	
		COPd (declared COP)			2.23	2.56	2.52
		Power input		kW	2.01	2.35	2.38
	TBivalent	Tbiv (bivalent temperature)		°C	-10		
		Pdh (declared heating cap)		kW	4.50	6.00	
		COPd (declared COP)			2.23	2.56	2.52
		Power input		kW	2.01	2.35	2.38
	A Condition (-7°C)	Pdh (declared heating cap)		kW	3.98	5.31	5.30
		COPd (declared COP)			2.51	2.79	2.76
		Power input		kW	1.59	1.90	1.92
	B Condition (2°C)	Pdh (declared heating cap)		kW	2.42	3.23	
		COPd (declared COP)			3.90	3.87	3.70
		Power input		kW	0.62	0.83	0.87
	C Condition (7°C)	Pdh (declared heating cap)		kW	2.07	2.19	2.21
		COPd (declared COP)			5.17	5.10	4.81
		Power input		kW	0.40	0.43	0.46
D Condition (12°C)	Pdh (declared heating cap)		kW	2.44	2.57	2.59	
	COPd (declared COP)			6.56	6.26	5.89	
	Power input		kW	0.37	0.41	0.44	
Pto (Thermostat off)			W	12 / 0	0 / 12	-	
Cooling	Cdc (Degradation cooling)			0.25			
Heating	Cdh (Degradation heating)			0.25			
Cooling function included				Yes			
Heating function included				Yes			
Average climate included				Yes			
Cold season included				No			
Warm season included				No			
Ecolabel logo				No			
Power consumption in other than active mode	Off mode		POFF	W	12		
	Standby mode	Cooling	PSB	W	12		
		Heating	PSB	W	12		
	Thermostat-off mode	PTO	Heating	W	-	12	
			Cooling	W	-	0	
Crankcase heater mode	PCK		W	0			
Indication if the heater is equipped with a supplementary heater (pair application)				-		No	

2 Specifications

Notes

(1) Cooling: T2: indoor temp. 26,6°CDB, 19,4°CWB, outdoor temp. 48°CDB [Btu/hr/W]

(2) Nominal heating capacities are based on: indoor temperature: 20°CDB, outdoor temperature: 7°CDB, 6°CWB, equivalent refrigerant piping: 5m, level difference: 0m.

Nominal cooling capacities are based on: indoor temperature: 27°CDB, 19°CWB, outdoor temperature: 35°CDB, equivalent refrigerant piping: 5m, level difference: 0m.

Cooling: indoor temp. 27°CDB, 19°CWB; outdoor temp. 35°CDB; equivalent piping length: 5m (horizontal); level difference: 0m

2-7 Capacity and Power input				FVA71A/RZASG71MV1	FAV100A/RZASG100MV1	FVA125A/RZASG125MV1	FVA140A/RZASG140MV1	
Indoor unit				FVA71AMVEB	FVA100AMVEB	FVA125AMVEB	FVA140AMVEB	
Outdoor unit				RZASG71M2V1B	RZASG100M7V1B	RZASG125M7Y1B	RZASG140M7V1B	
Cooling capacity	Nom.	kW		6.80 (1)	9.50 (1)	12.1 (1)	13.4 (1)	
Heating capacity	Nom.	kW		7.50 (2)	10.8 (2)	13.5 (2)	15.5 (2)	
Space cooling	Energy efficiency class			A+				
	Capacity	Pdesign	kW	6.80	9.50	12.1	13.4	
	SEER			5.83	5.72	5.52	5.63	
	ηs,c		%	-				
	Annual energy consumption			kWh/a	408	581	1,314	1,428
	A Condition (35°C - 27/19)	Pdc	kW	6.80	9.50	12.10	13.40	
		EERd			3.38	3.20	2.47	2.62
		Power input	kW	2.01	2.97	4.90	5.12	
	B Condition (30°C - 27/19)	Pdc	kW	5.02	7.00	8.92	9.88	
		EERd			5.07	5.01	4.31	4.52
		Power input	kW	0.99	1.40	2.07	2.19	
	C Condition (25°C - 27/19)	Pdc	kW	3.23	4.50	5.74	6.35	
		EERd			7.08	6.78	6.26	6.51
		Power input	kW	0.46	0.66	0.92	0.98	
	D Condition (20°C - 27/19)	Pdc	kW	2.77	3.00	3.07	3.76	
EERd			9.12	8.25	9.54	8.88		
Power input		kW	0.30	0.36	0.32	0.42		

2 Specifications

2

2-7 Capacity and Power input				FVA71A/RZASG71MV1	FAV100A/RZASG100MV1	FVA125A/RZASG125MV1	FVA140A/RZASG140MV1	
Space heating (Average climate)	Energy efficiency class			A+		A		-
	Capacity	Pdesign	kW	4.50	6.00		7.80	
	SCOP/A			4.04	3.83	3.64	3.81	
	SCOPnet/A			4.04	3.83	3.64	3.81	
	ηs,h		%	-			143	149
	Annual energy consumption			kWh/a	1,559	2,193	2,308	2,866
	Required back up heating cap at design conditions			kW	0.00			
	TOL	Tol (temperature operating limit)		°C	-10			
		Pdh (declared heating cap)		kW	4.50	6.00		7.80
		COPd (declared COP)			2.26	2.46	2.37	1.99
		Power input		kW	1.99	2.44	2.53	3.93
	TBivalent	Tbiv (bivalent temperature)		°C	-10			
		Pdh (declared heating cap)		kW	4.50	6.00		7.80
		COPd (declared COP)			2.26	2.46	2.37	1.99
		Power input		kW	1.99	2.44	2.53	3.93
	A Condition (-7°C)	Pdh (declared heating cap)		kW	3.98	5.31	5.30	6.90
		COPd (declared COP)			2.55	2.70	2.60	2.38
		Power input		kW	1.56	1.97	2.04	2.90
	B Condition (2°C)	Pdh (declared heating cap)		kW	2.42	3.23		4.20
		COPd (declared COP)			4.05	3.72	3.51	3.90
		Power input		kW	0.60	0.87	0.92	1.08
	C Condition (7°C)	Pdh (declared heating cap)		kW	2.01	2.20	2.19	3.47
		COPd (declared COP)			5.41	4.81	4.57	4.99
Power input		kW	0.37	0.46	0.48	0.70		
D Condition (12°C)	Pdh (declared heating cap)		kW	2.37	2.58	2.57	4.07	
	COPd (declared COP)			6.72	5.82	5.60	6.10	
	Power input		kW	0.35	0.44	0.46	0.67	
Pto (Thermostat off)			W	12 / 0	0 / 12	-		
Cooling	Cdc (Degradation cooling)			0.25				
Heating	Cdh (Degradation heating)			0.25				
Cooling function included				Yes				
Heating function included				Yes				
Average climate included				Yes				
Cold season included				No				
Warm season included				No				
Ecolabel logo				No				
Power consumption in other than active mode	Off mode		POFF	W	12			
	Standby mode	Cooling	PSB	W	12			
		Heating	PSB	W	12			
	Thermostat-off mode	PTO	Heating	W	-	12		
			Cooling	W	-	0		
Crankcase heater mode	PCK		W	0				
Indication if the heater is equipped with a supplementary heater (pair application)				-		No		

2 Specifications

Notes

(1) Nominal cooling capacities are based on: indoor temperature: 27°CDB, 19°CWB, outdoor temperature: 35°CDB, equivalent refrigerant piping: 5m, level difference: 0m.

(2) Nominal heating capacities are based on: indoor temperature: 20°CDB, outdoor temperature: 7°CDB, 6°CWB, equivalent refrigerant piping: 5m, level difference: 0m.

Cooling: indoor temp. 27°CDB, 19°CWB; outdoor temp. 35°CDB; equivalent piping length: 5m (horizontal); level difference: 0m

Cooling: indoor temp. 27°CDB, 19°CWB; outdoor temp. 35°CDB; equivalent piping length: 5m; level difference: 0m

2-8 Technical Specifications					RZASG71MV1	RZASG100MV1	RZASG125MV1	RZASG140MV1
Capacity control	Method				Inverter controlled			
Casing	Colour				Ivory white			
	Material				Painted galvanized steel plate			
Dimensions	Unit	Height	mm		770	990		
		Width	mm		900	940		
		Depth	mm		320			
	Packed unit	Height	mm		900	1,170		
		Width	mm		980	1,015		
		Depth	mm		420	422		
Weight	Unit		kg	60	70		78	
	Packed unit		kg	64	78	79	87	
Packing	Weight		kg	4	9			
Heat exchanger	Fin	Type			WF fin			
		Treatment			Anti-corrosion treatment (PE)			
Compressor	Quantity			1				
	Type			Hermetically sealed swing compressor				
Fan	Type			Propeller				
	Discharge direction			Horizontal				
	Quantity			1				
	Air flow rate	Cooling	Nom.	m ³ /min	56	69	71	76
Heating		Nom.	m ³ /min	50	82			
Fan motor	Quantity			1				
	Model			Brushless DC motor				
	Output		W	94	200			
	Drive			Direct drive				
Sound power level	Cooling		dBA	65	70	71	73	
	Heating		dBA	-		71 (1)	73 (1)	
Sound pressure level	Cooling	Nom.	dBA	46	53		54	
	Heating	Nom.	dBA	47	57			
Operation range	Cooling	Ambient	Min.	°CDB	-15			
			Max.	°CDB	46			
	Heating	Ambient	Min.	°CWB	-15			
			Max.	°CWB	15.5			
Refrigerant	Type			R-32				
	Charge		kg	2.45	2.60		2.90	
			TCO ₂ eq	1.65	1.76		1.96	
	Control			Expansion valve (electronic type)				
	GWP			675				
	Circuits	Quantity			1			

2 Specifications

2

2-8 Technical Specifications				RZASG71MV1	RZASG100MV1	RZASG125MV1	RZASG140MV1
Piping connections	Liquid	Quantity		1			
		Type		Flare connection			
		OD	mm	9,52			
	Gas	Quantity		1			
		Type		Flare connection			
		OD	mm	15.9			
	Drain	Quantity		3	5		
		Type		Hole			
		OD	mm	26			
	Piping length	OU - IU	Min.	m	5		
			Max.	m	50		
		System	Equivalent	m	70 (2)		
Chargel ess			m	30			
Additional refrigerant charge			kg/m	See installation manual			
Level difference	IU - OU	Max.	m	30.0			
	IU - IU	Max.	m	0.5			
Heat insulation			Both liquid and gas pipes				
Refrigerant oil	Type		FW68DA				
	Charged volume		l	0.90		1.35	
Defrost method			Reversed cycle				
Defrost control			Sensor for outdoor heat exchanger temperature				
Safety devices	Item	01	High pressure switch				
		02	Low pressure switch				
		03	Fan driver overload protector				
		04	Fuse				
		05	Compressor motor thermal protector				

Standard Accessories : Tie-wraps; Quantity : 2;

Standard Accessories : Installation manual; Quantity : 1;

Standard Accessories : Refrigerant label for F-gas regulation; Quantity : 1;

Standard Accessories : General safety precautions; Quantity : 1;

Standard Accessories : LOT10 Energy Label; Quantity : 1;

Standard Accessories : Peel off F-gas label; Quantity : 1;

2-9 Electrical Specifications				RZASG71MV1	RZASG100MV1	RZASG125MV1	RZASG140MV1
Power supply	Name		V1				
	Phase		1~				
	Frequency	Hz	50				
	Voltage	V	220-240				
Current - 50Hz	Maximum fuse amps (MFA)	A	20	25	32		
Current	Zmax	List	Complies to EN61000-3-11				
	Minimum Ssc value	kVa	Equipment complying with EN / IEC 61000-3-12 / (3) / See note 3				
Wiring connections	For power supply	Remark	See installation manual outdoor unit				
	For connection with indoor	Remark	See installation manual outdoor unit				
Power supply intake			See installation manual outdoor unit				

Notes

(1) According to ENER Lot 21

(2) European/international technical standard setting the limits for harmonic currents produced by equipment connected to public low-voltage system with input current ≤ 16A per phase.

(3) European/international technical standard setting the limits for harmonic currents produced by equipment connected to public low-voltage system with input current larger than 16A and ≤ 75A per phase.

(4) Ssc: Short-circuit power

3 Electrical data

3 - 1 Electrical Data

AZAS-MV1

AZAS-MY1

RZAG-MV1

RZAG-MY1

RZASG-MV1

RZASG-MY1

Symbols

- MCA: Minimum Circuit Ampere [A]
- TOCA: Total overcurrent amps [A]
- MFA: Maximum Fuse Ampere [A]
- MSC: Maximum current of the starting compressor [A]
- RLA: Rated load amps [A]
- OFM: Outdoor fan motor
- IFM: Indoor fan motor
- FLA: Full Load Ampere [A]
- KW: Fan motor rated output [kW]

Notes

1. The RLA is based on the following conditions.
 - Cooling
 - Indoor temperature 27.0°C DB / 19.0°C WB
 - Outdoor temperature 35.0°C DB
 - Heating
 - Indoor temperature 20.0°C DB
 - Outdoor temperature 7.0°C DB / 6.0°C WB
2. TOCA is the total value of each overcurrent set.
3. Voltage range
 - The units are suitable for use with electrical systems in which the voltage supplied to the unit terminals is not below or above the listed range limits.
4. The maximum allowable voltage that is unbalanced between phases is 2%.
5. MCA is the maximum input current.
 - The capacity of the MFA must be greater than that of the MCA.
 - Select the MFA according to the table.
6. Select the wire size according to the MCA.
7. MFA is used to select the circuit breaker and the ground fault circuit interruptor.
 - Earth leakage circuit breaker

3D110014A

RZASG71-100MV1

Indoor	Outdoor	Power supply	Voltage range	MCA	TOCA	MFA	Compressor		OFM		IFM				
							MSC	RLA	kW	FLA	kW	FLA			
FCAG35AVEB	x2 RZASG71M2V1B	50Hz ~ 220-240V	Minimum: 198 V Maximum: 264 V	17.6	--	20	--	15.4	0.094	0.9	0.044 x2	0.3 x2			
FCAG71AVEB	RZASG71M2V1B			17.4	--	20	--	15.4	0.094	0.9	0.054	0.4			
FFA35A2VEB	x2 RZASG71M2V1B			17.8	--	20	--	15.4	0.094	0.9	0.050 x2	0.4 x2			
FBA35A2VEB	x2 RZASG71M2V1B			18.2	--	20	--	15.4	0.094	0.9	0.089 x2	0.6 x2			
FBA71A2VEB	RZASG71M2V1B			17.5	--	20	--	15.4	0.094	0.9	0.070	0.5			
FNA35A2VEB	x2 RZASG71M2V1B			17.3	--	20	--	15.4	0.094	0.9	0.034 x2	0.3			
FUA71AVEB	RZASG71M2V1B			17.9	--	20	--	15.4	0.094	0.9	0.046	0.9			
FAA71AUVEB	RZASG71M2V1B			17.4	--	20	--	15.4	0.094	0.9	0.048	0.4			
FVA71AMVEB	RZASG71M2V1B			17.6	--	20	--	15.4	0.094	0.9	0.117	0.6			
FDXM35F3V1B	x2 RZASG71M2V1B			17.6	--	20	--	15.4	0.094	0.9	0.034 x2	0.3 x2			
FHA35AVEB	x2 RZASG71M2V1B			18.2	--	20	--	15.4	0.094	0.9	0.060 x2	0.6 x2			
FHA71AVEB	RZASG71M2V1B			17.8	--	20	--	15.4	0.094	0.9	0.091	0.8			
FCAG35AVEB	x3 RZASG100M7V1B			50Hz ~ 220-240V	Minimum: 198 V Maximum: 264 V	21.7	--	25	--	19.0	0.200	1.0	0.044 x3	0.3 x3	
FCAG50AVEB	x2 RZASG100M7V1B					21.4	--	25	--	19.0	0.200	1.0	0.039 x2	0.3 x2	
FCAG100AVEB	RZASG100M7V1B					21.5	--	25	--	19.0	0.200	1.0	0.117	0.7	
FFA35A2VEB	x3 RZASG100M7V1B					22.0	--	25	--	19.0	0.200	1.0	0.050 x3	0.4 x3	
FFA50A2VEB	x2 RZASG100M7V1B	21.6	--			25	--	19.0	0.200	1.0	0.050 x2	0.4 x2			
FBA100A2VEB	RZASG100M7V1B	21.8	--			25	--	19.0	0.200	1.0	0.127	1.0			
FNA35A2VEB	x3 RZASG100M7V1B	21.7	--			25	--	19.0	0.200	1.0	0.034 x3	0.3 x3			
FNA50A2VEB	x2 RZASG100M7V1B	21.8	--			25	--	19.0	0.200	1.0	0.060 x2	0.5 x2			
FUA100AVEB	RZASG100M7V1B	22.2	--			25	--	19.0	0.200	1.0	0.106	1.3			
FAA100AUVEB	RZASG100M7V1B	21.2	--			25	--	19.0	0.200	1.0	0.064	0.4			
FVA100AMVEB	RZASG100M7V1B	22.0	--			25	--	19.0	0.200	1.0	0.238	1.2			
FDXM35F3V1B	x3 RZASG100M7V1B	21.7	--			25	--	19.0	0.200	1.0	0.034 x3	0.3 x3			
FDXM50F3V1B	x2 RZASG100M7V1B	21.8	--			25	--	19.0	0.200	1.0	0.060 x2	0.5 x2			
FHA35AVEB	x3 RZASG100M7V1B	22.7	--			25	--	19.0	0.200	1.0	0.060 x3	0.6 x3			
FHA50AVEB	x2 RZASG100M7V1B	22.0	--			25	--	19.0	0.200	1.0	0.060 x2	0.6 x2			
FHA100AVEB	RZASG100M7V1B	22.2	--			25	--	19.0	0.200	1.0	0.150	1.3			

3D110014A

3 Electrical data

3 - 1 Electrical Data

RZASG125-140MV1

Indoor	Outdoor	Power supply	Voltage range		MCA	TOCA	MFA	Compressor		OFM		IFM		
								MSC	RLA	kW	FLA	kW	FLA	
FCAG35AVEB	x4 RZASG125M7V1B	50Hz ~ 220-240V	Minimum: 198 V	Maximum: 264 V	28,0	—	32	—	24,7	0,200	1,0	0,044 x4	0,3 x4	
FCAG50AVEB	x3 RZASG125M7V1B				27,7	—	32	—	24,7	0,200	1,0	0,039 x3	0,3 x3	
FCAG60AVEB	x2 RZASG125M7V1B				27,4	—	32	—	24,7	0,200	1,0	0,044 x2	0,3 x2	
FCAG125AVEB	RZASG125M7V1B				27,8	—	32	—	24,7	0,200	1,0	0,168	1,0	
FFA35A2VEB	x4 RZASG125M7V1B				28,4	—	32	—	24,7	0,200	1,0	0,050 x4	0,4 x4	
FFA50A2VEB	x3 RZASG125M7V1B				28,0	—	32	—	24,7	0,200	1,0	0,050 x3	0,4 x3	
FFA60A2VEB	x2 RZASG125M7V1B				28,0	—	32	—	24,7	0,200	1,0	0,050 x2	0,6 x2	
FBA35A2VEB	x4 RZASG125M7V1B				29,2	—	32	—	24,7	0,200	1,0	0,089 x4	0,6 x4	
FBA50A2VEB	x3 RZASG125M7V1B				28,6	—	32	—	24,7	0,200	1,0	0,089 x3	0,6 x3	
FBA60A2VEB	x2 RZASG125M7V1B				27,8	—	32	—	24,7	0,200	1,0	0,070 x2	0,5 x2	
FBA125A2VEB	RZASG125M7V1B				28,3	—	32	—	24,7	0,200	1,0	0,187	1,5	
FNA35A2VEB	x4 RZASG125M7V1B				28,0	—	32	—	24,7	0,200	1,0	0,034 x4	0,3 x4	
FNA50A2VEB	x3 RZASG125M7V1B				28,3	—	32	—	24,7	0,200	1,0	0,060 x3	0,5 x3	
FNA60A2VEB	x2 RZASG125M7V1B				27,8	—	32	—	24,7	0,200	1,0	0,060 x2	0,5 x2	
FUA125AVEB	RZASG125M7V1B				28,2	—	32	—	24,7	0,200	1,0	0,106	1,4	
FDA125AVEB	RZASG125M7V1B				28,9	—	32	—	24,7	0,200	1,0	0,350	2,1	
FVA125AMVEB	RZASG125M7V1B		28,0	—	32	—	24,7	0,200	1,0	0,238	1,2			
FDXM35F3V1B	x4 RZASG125M7V1B		28,0	—	32	—	24,7	0,200	1,0	0,034 x4	0,3 x4			
FDXM50F3V1B	x3 RZASG125M7V1B		28,3	—	32	—	24,7	0,200	1,0	0,060 x3	0,5 x3			
FDXM60F3V1B	x2 RZASG125M7V1B		27,8	—	32	—	24,7	0,200	1,0	0,060 x2	0,5 x2			
FHA35AVEB	x4 RZASG125M7V1B		29,2	—	32	—	24,7	0,200	1,0	0,060 x4	0,6 x4			
FHA50AVEB	x3 RZASG125M7V1B		28,6	—	32	—	24,7	0,200	1,0	0,060 x3	0,6 x3			
FHA60AVEB	x2 RZASG125M7V1B		28,0	—	32	—	24,7	0,200	1,0	0,091 x2	0,6 x2			
FHA125AVEB	RZASG125M7V1B		28,3	—	32	—	24,7	0,200	1,0	0,150	1,5			
FCAG35AVEB	x4 RZASG140M7V1B		50Hz ~ 220-240V	Minimum: 198 V	Maximum: 264 V	27,2	—	32	—	24,0	0,200	1,0	0,044 x4	0,3 x4
FCAG50AVEB	x3 RZASG140M7V1B					26,9	—	32	—	24,0	0,200	1,0	0,039 x3	0,3 x3
FCAG71AVEB	x2 RZASG140M7V1B					26,8	—	32	—	24,0	0,200	1,0	0,054 x2	0,4 x2
FCAG140AVEB	RZASG140M7V1B					27,0	—	32	—	24,0	0,200	1,0	0,168	1,0
FFA35A2VEB	x4 RZASG140M7V1B					27,7	—	32	—	24,0	0,200	1,0	0,050 x4	0,4 x4
FFA50A2VEB	x3 RZASG140M7V1B					27,2	—	32	—	24,0	0,200	1,0	0,050 x3	0,4 x3
FBA35A2VEB	x4 RZASG140M7V1B					28,5	—	32	—	24,0	0,200	1,0	0,089 x4	0,6 x4
FBA50A2VEB	x3 RZASG140M7V1B					27,9	—	32	—	24,0	0,200	1,0	0,089 x3	0,6 x3
FBA71A2VEB	x2 RZASG140M7V1B	27,0				—	32	—	24,0	0,200	1,0	0,070 x2	0,5 x2	
FBA140A2VEB	RZASG140M7V1B	27,6				—	32	—	24,0	0,200	1,0	0,187	1,5	
FNA35A2VEB	x4 RZASG140M7V1B	27,2				—	32	—	24,0	0,200	1,0	0,034 x4	0,3 x4	
FNA50A2VEB	x3 RZASG140M7V1B	27,6				—	32	—	24,0	0,200	1,0	0,060 x3	0,5 x3	
FUA71AVEB	x2 RZASG140M7V1B	27,9				—	32	—	24,0	0,200	1,0	0,046 x2	0,9 x2	
FAA71AUVEB	x2 RZASG140M7V1B	26,8				—	32	—	24,0	0,200	1,0	0,048 x2	0,4 x2	
FVA71AMVEB	x2 RZASG140M7V1B	27,2				—	32	—	24,0	0,200	1,0	0,117 x2	0,6 x2	
FVA140AMVEB	RZASG140M7V1B	27,5				—	32	—	24,0	0,200	1,0	0,276	1,4	
FDXM35F3V1B	x4 RZASG140M7V1B	27,2		—	32	—	24,0	0,200	1,0	0,034 x4	0,3 x4			
FDXM50F3V1B	x3 RZASG140M7V1B	27,6		—	32	—	24,0	0,200	1,0	0,060 x3	0,5 x3			
FHA35AVEB	x4 RZASG140M7V1B	28,5		—	32	—	24,0	0,200	1,0	0,060 x4	0,6 x4			
FHA50AVEB	x3 RZASG140M7V1B	27,9		—	32	—	24,0	0,200	1,0	0,060 x3	0,6 x3			
FHA71AVEB	x2 RZASG140M7V1B	27,7		—	32	—	24,0	0,200	1,0	0,091 x2	0,8 x2			
FHA140AVEB	RZASG140M7V1B	27,9		—	32	—	24,0	0,200	1,0	0,150	1,8			

3D110014A

4 Options

4 - 1 Options

AZAS-MV1
 AZAS-MY1
 RZAG-MV1
 RZAG-MY1
 RZASG-MV1
 RZASG-MY1

Available options for RZAG models

Option		Option kit			
		RZAG71M7V1B RZAG71M7Y1B	RZAG100M7V1B RZAG100M7Y1B	RZAG125M7V1B RZAG125M7Y1B	RZAG140M7V1B RZAG140M7Y1B
Bottom plate heater		EKBPH140L7			
Refrigerant branch piping	Twin	KHRQ(M)58T			
	Triple	-	KHRQ(M)58H		
	Double twin	-	KHRQ(M)58T (3x)		
Demand adaptor kit		SB.KRP58M52			

Available options for RZASG models

Option		Option kit			
		RZASG71M2V1B	RZASG100M7V1B RZASG100M7Y1B	RZASG125M7V1B RZASG125M7Y1B	RZASG140M7V1B RZASG140M7Y1B
Bottom plate heater		-			
Refrigerant branch piping	Twin	KHRQ(M)58T			
	Triple	-	KHRQ(M)58H		
	Double twin	-	KHRQ(M)58T (3x)		
Demand adaptor kit		SB.KRP58M52			

3D108867

5 Combination table

5 - 1 Combination Table

5

AZAS-MV1
AZAS-MY1
RZAG-MV1
RZAG-MY1
RZASG-MV1
RZASG-MY1

Possible combinations

	71	100	125	140
2= Pair	35+35	50+50	60+60	71+71
2= Twin				
3= Triple		35+35+35 (*)	50+50+50 (*)	50+50+50 (*)
4= Double twin			35+35+35+35 (*)	35+35+35+35

(*) See note 1.

Sky Air		High Cassette			Thin cassette				2x2 cassette			Duct (medium ESP)			Concealed floor standing type			Ceiling-mounted - 4-way blow			Wall mounted type		Duct (high ESP)								
Model		FCAHG71GVEB	FCAHG100GVEB	FCAHG125GVEB	FCAHG140GVEB	FCAG35AVEB	FCAG60AVEB	FCAG90AVEB	FCAG120AVEB	FCAG140AVEB	FCAG125AVEB	FCAG140AVEB	FFA60A2VEB	FFA60A2VEB	FFA60A2VEB	FBA71A2VEB	FBA100A2VEB	FBA125A2VEB	FBA140A2VEB	FNA35A2VEB	FNA60A2VEB	FNA60A2VEB	FUA71AVEB	FUA100AVEB	FUA125AVEB	FAA71AUVB	FAA100AUVB	FDA125A5VEB			
RZAG71M7V1B	RZAG71M7Y1B	P				2						2								2											
RZAG100M7V1B	RZAG100M7Y1B		P			3	2					3	2							3	2										
RZAG125M7V1B	RZAG125M7Y1B			P		4	3	2				4	3	2						4	3	2									
RZAG140M7V1B	RZAG140M7Y1B	2			P	4	3	2				4	3	2						4	3	2					2				
RZASG71M2V1B						2						2								2											
RZASG100M7V1B	RZASG100M7Y1B					3	2					3	2							3	2										
RZASG125M7V1B	RZASG125M7Y1B					4	3	2				4	3	2						4	3	2									
RZASG140M7V1B	RZASG140M7Y1B					4	3	2				4	3	2						4	3	2					2				
AZAS71M2V1B																															
AZAS100M7V1B	AZAS100M7Y1B																														
AZAS125M7V1B	AZAS125M7Y1B																														
AZAS140M7V1B	AZAS140M7Y1B																														

Sky Air		Floor standing type				Slim duct		Ceiling-suspended				
Model		FVA71AMVEB	FVA100AMVEB	FVA125AMVEB	FVA140AMVEB	FDX103F3Y1B	FDX160F3Y1B	FHA35AVEB	FHA60AVEB	FHA90AVEB	FHA120AVEB	FHA140AVEB
RZAG71M7V1B	RZAG71M7Y1B	P				2						
RZAG100M7V1B	RZAG100M7Y1B		P			3	2					
RZAG125M7V1B	RZAG125M7Y1B			P		4	3	2				
RZAG140M7V1B	RZAG140M7Y1B	2			P	4	3	2				
RZASG71M2V1B						2						
RZASG100M7V1B	RZASG100M7Y1B		P			3	2					
RZASG125M7V1B	RZASG125M7Y1B			P		4	3	2				
RZASG140M7V1B	RZASG140M7Y1B	2			P	4	3	2				
AZAS71M2V1B												
AZAS100M7V1B	AZAS100M7Y1B											
AZAS125M7V1B	AZAS125M7Y1B											
AZAS140M7V1B	AZAS140M7Y1B											

Notes

- Maximum capacity is limited based on outdoor unit capacity.
- When combining multiple indoor units, designate the unit whose remote controller is equipped with the most functions as the master unit.
- For the selection of the correct refnet kit, required to install a multi-combination, refer to the option list.

Twin : KHRQ(M)S8T
 Triple : KHRQ(M)S8H
 Double twin : KHRQ(M)S8T

3D108868A

6 Capacity tables

6 - 1 Cooling/Heating Capacity Tables

RZASG71MV1

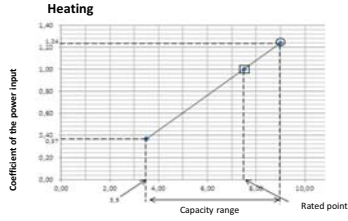
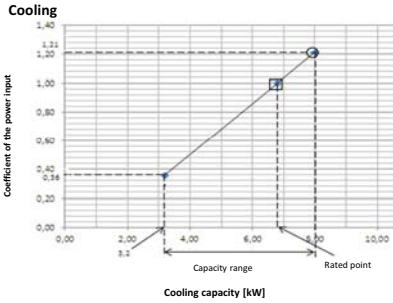

Symbols
 AFR: Air flow rate [m³/min]
 BF: Bypass factor
 EWB: Entering wet-bulb temperature (°C WB)
 EDB: Entering dry-bulb temperature (°C DB)
 TC: Maximum total cooling/heating capacity [kW]
 SHC: Sensible heat capacity [kW]
 CPI: Coefficient of the power input
 PI: Power input [kW]
 compressor + indoor and outdoor fan motors

Indoor		Outdoor temperature [°C DB]											
		25			30			35			40		
°CWB	°CDB	T _C	SHC	CPI	T _C	SHC	CPI	T _C	SHC	CPI	T _C	SHC	CPI
16.0	22	7.29	4.95	0.92	7.28	4.99	1.08	7.50	5.21	1.20	7.20	5.06	1.32
18.0	25	8.37	5.43	1.00	8.11	5.32	1.11	8.83	5.19	1.21	7.52	5.04	1.34
19.0	27	8.54	5.41	1.01	8.28	5.31	1.11	8.00	5.18	1.21	7.68	5.03	1.34
19.5	27	8.63	5.40	1.01	8.37	5.30	1.11	8.08	5.17	1.21	7.76	5.03	1.34
22.0	30	9.07	5.33	1.03	8.80	5.23	1.12	8.51	5.12	1.22	8.18	4.97	1.35
24.0	32	9.43	5.25	1.03	9.15	5.16	1.13	8.85	5.05	1.23	8.51	4.90	1.36

Indoor		Outdoor temperature [°C WB]											
		-15		-10		-5		0		5		10	
°CDB	°CWB	T _C	CPI	T _C	CPI	T _C	CPI	T _C	CPI	T _C	CPI	T _C	CPI
16	5.14	0.89	5.68	0.94	6.22	0.98	6.75	1.03	9.02	1.08	9.72	1.13	1.13
18	5.14	0.92	5.67	0.97	6.21	1.02	6.74	1.07	9.01	1.12	9.70	1.18	1.18
20	5.13	0.96	5.67	1.01	6.20	1.06	6.73	1.11	9.00	1.17	9.69	1.23	1.23
21	5.13	0.98	5.66	1.03	6.20	1.08	6.73	1.13	9.00	1.19	9.69	1.25	1.25
22	5.12	0.99	5.66	1.04	6.19	1.10	6.73	1.15	8.99	1.22	9.68	1.28	1.28
24	5.12	1.03	5.65	1.09	6.19	1.14	6.72	1.20	8.98	1.26	9.66	1.32	1.32

- Notes**
- The ratings shown are net capacities which include a deduction for indoor fan motor heat.
 - = Maximum at standard conditions
 □ = Rated capacity and rated coefficient of the power input
 The maximum capacity is not guaranteed except at standard conditions.
 - SHC is based on indoor units EWB & EDB.
 SHC for other dry-bulb temperatures = SHC + SHC*
 SHC+SHC correction for other dry-bulb temperatures = 0.02 x AFR (m³/min) x (1-BF) x (DB* - EDB)
 - The capacities are based on the following conditions:
 Outdoor air: 85% RH
 However, the outdoor ambient condition of the rated capacity during heating operation is 7°C DB / 6°C WB.
 Corresponding refrigerant piping length: 5.0 m
 Level difference: 0m
 - CPI is a percentage value compared to the rated value which is 1.00.
 - The error rate for this value is less than 5% and depends on the indoor unit type.
 - The heating performance takes into account the drop that occurs during defrost operation.
 - The air flow rate and bypass factor are mentioned in the table.
 - The rated power input for each model is mentioned in the table below.

Pair	FCAG71A	FAA71A	FVA71A	FHA71A	FUA71A	FBA71A
AFR	15.3	18.0	18.0	20.5	23.0	18.0
(BF)	(0.14)	(0.16)	(0.16)	(0.13)	(0.24)	(0.13)

Twin	FCAG35A X 2	FHA35A X 2	FFA35A X 2	FDXM35F3 X 2	FBA35A X 2	FNA35A X 2
AFR	12.5 x 2	14.0 x 2	10.0 x 2	8.7 x 2	15.0 x 2	8.7 x 2
(BF)	(0.4 x 2)	(0.17 x 2)	(0.25 x 2)	(0.17 x 2)	(0.08 x 2)	(0.17 x 2)

Pair	FCAG71A	FAA71A	FVA71A	FHA71A	FUA71A	FBA71A
Cooling	2,17	2,00	2,01	1,78	1,77	1,89
Heating	2,38	2,09	2,25	2,00	1,85	2,09

Twin	FCAG35A X 2	FHA35A X 2	FFA35A X 2	FDXM35F3 X 2	FBA35A X 2	FNA35A X 2
Cooling	1,81	1,47	2,08	1,77	1,78	1,77
Heating	1,89	1,55	2,80	2,02	1,62	2,02

3D112144

RZASG100MV1 RZASG100MY1

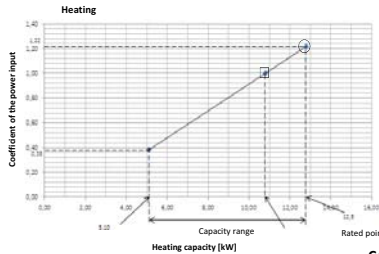
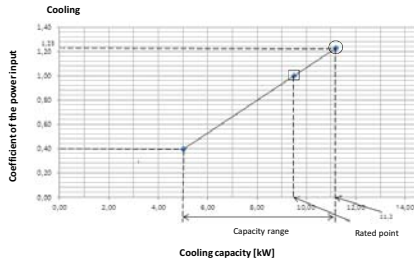

Symbols
 AFR: Air flow rate [m³/min]
 BF: Bypass factor
 EWB: Entering wet-bulb temperature (°C WB)
 EDB: Entering dry-bulb temperature (°C DB)
 TC: Maximum total cooling/heating capacity [kW]
 SHC: Sensible heat capacity [kW]
 CPI: Coefficient of the power input
 PI: Power input [kW]
 compressor + indoor and outdoor fan motors

Indoor		Outdoor temperature [°C DB]											
		25			30			35			40		
°CWB	°CDB	T _C	SHC	CPI	T _C	SHC	CPI	T _C	SHC	CPI	T _C	SHC	CPI
16.0	22	11.2	7.61	1.08	10.8	7.44	1.11	10.5	7.59	1.22	10.1	7.69	1.32
18.0	25	11.8	7.59	1.08	11.4	7.49	1.12	11.0	7.57	1.23	10.5	7.69	1.33
19.0	27	12.0	7.57	1.07	11.6	7.44	1.12	11.2	7.50	1.23	10.8	7.64	1.33
19.5	27	12.1	7.59	1.07	11.7	7.37	1.13	11.4	7.34	1.23	10.9	7.64	1.34
22.0	30	12.8	7.52	1.05	12.4	7.29	1.13	11.9	7.16	1.24	11.5	7.60	1.35
24.0	32	13.2	7.42	1.03	12.9	7.27	1.14	12.4	7.06	1.25	12.0	6.91	1.36

Indoor		Outdoor temperature [°C WB]											
		-15.0		-10.0		-5.0		0.0		6.0		10.0	
°CDB	°CWB	T _C	CPI	T _C	CPI	T _C	CPI	T _C	CPI	T _C	CPI	T _C	CPI
16	8.58	0.93	9.45	0.99	10.1	1.02	10.4	1.05	12.8	1.12	13.8	1.18	1.18
18	8.57	0.97	9.44	1.02	10.0	1.07	10.3	1.10	12.8	1.17	13.8	1.23	1.23
20	8.56	1.01	9.43	1.07	10.0	1.11	10.3	1.14	12.8	1.22	13.8	1.28	1.28
21	8.56	1.03	9.42	1.09	10.0	1.13	10.3	1.16	12.8	1.24	13.8	1.30	1.30
22	8.55	1.04	9.42	1.10	10.0	1.14	10.3	1.18	12.8	1.26	13.8	1.33	1.33
24	8.54	1.09	9.41	1.15	10.0	1.19	10.3	1.23	12.8	1.31	13.8	1.38	1.38

- Notes**
- The ratings shown are net capacities which include a deduction for indoor fan motor heat.
 - = Maximum at standard conditions
 □ = Rated capacity and rated coefficient of the power input
 The maximum capacity is not guaranteed except at standard conditions.
 - SHC is based on indoor units EWB & EDB.
 SHC for other dry-bulb temperatures = SHC + SHC*
 SHC+SHC correction for other dry-bulb temperatures = 0.02 x AFR (m³/min) x (1-BF) x (DB* - EDB)
 - The capacities are based on the following conditions:
 Outdoor air: 85% RH
 However, the outdoor ambient condition of the rated capacity during heating operation is 7°C DB / 6°C WB.
 Corresponding refrigerant piping length: 5.0 m
 Level difference: 0m
 - CPI is a percentage value compared to the rated value which is 1.00.
 - The error rate for this value is less than 5% and depends on the indoor unit type.
 - The heating performance takes into account the drop that occurs during defrost operation.
 - The air flow rate and bypass factor are mentioned in the table.
 - The rated power input for each model is mentioned in the table below.

Pair	FCAG100A	FAA100A	FVA100A	FHA100A	FUA100A	FBA100A
AFR	22.8	26.0	28.0	28.0	31.0	29.0
(BF)	(0.17)	(0.10)	(0.20)	(0.09)	(0.20)	(0.03)

Twin	FCAG50A X 2	FHA50A X 2	FFA50A X 2	FDXM50F3 X 2	FNA50A X 2
AFR	12.6 x 2	15.0 x 2	12.0 x 2	15.8 x 2	16.0 x 2
(BF)	(0.22 x 2)	(0.18 x 2)	(0.16 x 2)	(0.11 x 2)	(0.11 x 2)

Triple	FCAG35A X 3	FHA35A X 3	FFA35A X 3	FDXM35F3 X 3	FNA35A X 3
AFR	12.5 x 3	14.0 x 3	10.0 x 3	8.7 x 3	8.7 x 3
(BF)	(0.4 x 3)	(0.17 x 3)	(0.25 x 3)	(0.17 x 3)	(0.17 x 3)

Pair	FCAG100A	FAA100A	FVA100A	FHA100A	FUA100A	FBA100A
Cooling	2,92	3,52	2,97	2,97	2,97	2,97
Heating	3,45	3,98	3,47	3,43	3,20	3,32

Twin	FCAG50A X 2	FHA50A X 2	FFA50A X 2	FDXM50F3 X 2	FNA50A X 2
Cooling	2,57	2,97	3,39	2,44	2,44
Heating	3,33	3,26	3,89	2,96	2,96

Triple	FCAG35A X 3	FHA35A X 3	FFA35A X 3	FDXM35F3 X 3	FNA35A X 3
Cooling	2,32	2,16	2,71	2,57	2,57
Heating	2,73	2,66	3,87	3,13	3,13

3D112145

6 Capacity tables

6 - 1 Cooling/Heating Capacity Tables

6

RZASG125MV1 RZASG125MY1

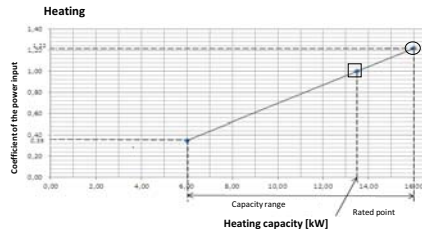
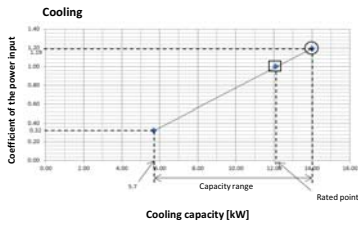

Symbols
 AFR: Air flow rate [m³/min]
 BF: Bypass factor
 EWB: Entering wet-bulb temperature (°C WB)
 EDB: Entering dry-bulb temperature (°C DB)
 TC: Maximum total cooling/heating capacity [kW]
 SHC: Sensible heat capacity [kW]
 CPI: Coefficient of the power input
 P: Power input [kW]
 compressor + indoor and outdoor fan motors

- The ratings shown are net capacities which include a deduction for indoor fan motor heat.
- = Maximum at standard conditions
 □ = Rated capacity and rated coefficient of the power input
 The maximum capacity is not guaranteed except at standard conditions.
- SHC is based on indoor units EWB & EDB.
 SHC for other dry-bulb temperatures = SHC + SHC*
 Not SHC - SHC correction for other dry-bulb temperatures
 = 0.02 x AFR (m³/min) x (1-BF) x (DB* - EDB)
- The capacities are based on the following conditions:
 Outdoor air: 85% RH
 However, the outdoor ambient condition of the rated capacity during heating operation is 7°C DB / 6°C WB.
 Corresponding refrigerant piping length: 5.0 m
 Level difference: 0m
- CPI is a percentage value compared to the rated value which is 1.00.
- The error rate for this value is less than 5% and depends on the indoor unit type.
- The heating performance takes into account the drop that occurs during defrost operation.
- The air flow rate and bypass factor are mentioned in the table.
- The rated power input for each model is mentioned in the table below.

Indoor	Outdoor temperature (°C DB)												
	25			30			35			40			
	TC	SHC	CPI	TC	SHC	CPI	TC	SHC	CPI	TC	SHC	CPI	
°C WB	°C DB	kW	kW	—	kW	kW	—	kW	kW	—	kW	kW	—
18.0	22	14.10	9.54	0.97	13.60	9.30	1.08	13.10	9.12	1.18	12.60	8.78	1.28
18.0	25	14.70	9.50	0.97	14.20	9.32	1.08	13.70	9.09	1.19	13.20	8.83	1.30
19.0	27	15.00	9.52	0.99	14.50	9.34	1.09	14.00	9.06	1.19	13.50	8.87	1.29
19.5	27	15.20	9.52	0.99	14.70	9.26	1.09	14.20	9.08	1.19	13.60	8.81	1.30
22.0	30	16.00	9.39	0.99	15.50	9.14	1.09	14.90	8.95	1.20	14.40	8.74	1.31
24.0	32	16.70	9.31	1.00	16.10	9.09	1.11	15.50	8.83	1.21	15.00	8.63	1.32

Indoor	Outdoor temperature (°C WB)											
	-15.0		-10.0		-5.0		0.0		6.0		10.0	
	TC	CPI	TC	CPI	TC	CPI	TC	CPI	TC	CPI	TC	CPI
°C DB	kW	—	kW	—	kW	—	kW	—	kW	—	kW	—
18	10.7	0.95	11.8	0.99	12.6	1.02	13.0	1.05	16.0	1.12	17.3	1.18
18	10.7	0.97	11.8	1.02	12.6	1.07	12.9	1.10	16.0	1.17	17.3	1.23
20	10.7	1.01	11.8	1.07	12.6	1.11	12.9	1.14	16.0	1.22	17.3	1.28
21	10.7	1.03	11.8	1.09	12.6	1.13	12.9	1.16	16.0	1.24	17.3	1.31
22	10.7	1.04	11.8	1.10	12.6	1.14	12.9	1.18	16.0	1.27	17.3	1.33
24	10.7	1.09	11.8	1.15	12.6	1.19	12.9	1.23	16.0	1.31	17.3	1.38

Pair	FCAG125A	FDA125A	FVA125A	FHA125A	FUA125A	FBA125A
AFR	26.0	39.0	28.0	31.0	32.5	34.0
(BF)	(0.23)	(0.16)	(0.16)	(0.14)	(0.19)	(0.06)

Twin	FCAG60A X 2	FHA60A X 2	FFA60A X 2	FDXM60F3 X 2	FBA60A X 2	FNA60A X 2
AFR	13.6 x 2	19.5 x 2	14.5 x 2	16.0 x 2	18.0 x 2	16.0 x 2
(BF)	(0.2 x 2)	(0.20 x 2)	(0.11 x 2)	(0.12 x 2)	(0.18 x 2)	(0.12 x 2)

Triple	FCAG50A X 3	FHA50A X 3	FFA50A X 3	FDXM50F3 X 3	FBA50A X 3	FNA50A X 3
AFR	12.6 x 3	15.0 x 3	12.0 x 3	15.0 x 3	16.0 x 3	16.0 x 3
(BF)	(0.22 x 3)	(0.18 x 3)	(0.16 x 3)	(0.11 x 3)	(0.13 x 3)	(0.11 x 3)

Double twin	FCAG35A X 4	FHA35A X 4	FFA35A X 4	FDXM35F3 X 4	FBA35A X 4	FNA35A X 4
AFR	12.5 x 4	14.0 x 4	10.0 x 4	15.0 x 4	15.0 x 4	15.0 x 4
(BF)	(0.4 x 4)	(0.17 x 4)	(0.25 x 4)	(0.17 x 4)	(0.08 x 4)	(0.17 x 4)

3D112146

RZASG140MV1 RZASG140MY1

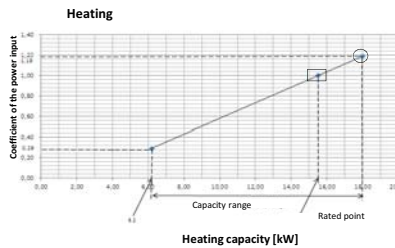
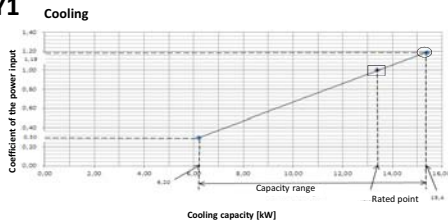

Symbols
 AFR: Air flow rate [m³/min]
 BF: Bypass factor
 EWB: Entering wet-bulb temperature (°C WB)
 EDB: Entering dry-bulb temperature (°C DB)
 TC: Maximum total cooling/heating capacity [kW]
 SHC: Sensible heat capacity [kW]
 CPI: Coefficient of the power input
 P: Power input [kW]
 compressor + indoor and outdoor fan motors

- The ratings shown are net capacities which include a deduction for indoor fan motor heat.
- = Maximum at standard conditions
 □ = Rated capacity and rated coefficient of the power input
 The maximum capacity is not guaranteed except at standard conditions.
- SHC is based on indoor units EWB & EDB.
 Not SHC for other dry-bulb temperatures = SHC + SHC*
 SHC - SHC correction for other dry-bulb temperatures
 = 0.02 x AFR (m³/min) x (1-BF) x (DB* - EDB)
- The capacities are based on the following conditions:
 Outdoor air: 85% RH
 However, the outdoor ambient condition of the rated capacity during heating operation is 7°C DB / 6°C WB.
 Corresponding refrigerant piping length: 5.0 m
 Level difference: 0m
- CPI is a percentage value compared to the rated value which is 1.00.
- The error rate for this value is less than 5% and depends on the indoor unit type.
- The heating performance takes into account the drop that occurs during defrost operation.
- The air flow rate and bypass factor are mentioned in the table.
- The rated power input for each model is mentioned in the table below.

Indoor	Outdoor temperature (°C DB)												
	25			30			35			40			
	TC	SHC	CPI	TC	SHC	CPI	TC	SHC	CPI	TC	SHC	CPI	
°C WB	°C DB	kW	kW	—	kW	kW	—	kW	kW	—	kW	kW	—
18.0	22	15.5	10.47	0.98	14.9	10.26	1.08	14.4	10.08	1.18	13.9	9.69	1.28
18.0	25	16.2	10.35	0.98	15.6	10.21	1.09	15.1	10.04	1.19	14.5	9.71	1.30
19.0	27	16.6	10.43	0.99	16.0	10.18	1.09	15.4	9.98	1.19	14.8	9.76	1.30
19.5	27	16.7	10.49	0.99	16.1	10.16	1.10	15.6	10.00	1.19	15.0	9.66	1.30
22.0	30	17.6	10.37	0.98	17.0	10.16	1.10	16.4	9.83	1.21	15.8	9.60	1.31
24.0	32	18.4	10.20	1.00	17.7	10.00	1.11	17.0	9.67	1.22	16.4	9.47	1.32

Indoor	Outdoor temperature (°C WB)											
	-15.0		-10.0		-5.0		0.0		6.0		10.0	
	TC	CPI	TC	CPI	TC	CPI	TC	CPI	TC	CPI	TC	CPI
°C DB	kW	—	kW	—	kW	—	kW	—	kW	—	kW	—
18	11.6	0.91	12.7	0.97	13.6	1.00	13.9	1.03	18.0	1.09	19.4	1.16
18	11.6	0.95	12.7	1.00	13.6	1.04	13.9	1.07	18.0	1.14	19.4	1.21
20	11.6	0.99	12.7	1.05	13.6	1.09	13.9	1.11	18.0	1.19	19.4	1.25
21	11.6	1.00	12.7	1.06	13.6	1.11	13.9	1.13	18.0	1.21	19.4	1.28
22	11.6	1.02	12.7	1.08	13.6	1.12	13.9	1.16	18.0	1.24	19.4	1.30
24	11.6	1.07	12.6	1.12	13.6	1.17	13.9	1.20	18.0	1.29	19.4	1.35

Pair	FCAG140A	FVA140A	FHA140A	FBA140A
AFR	26.0	30.0	34.0	34.0
(BF)	(0.23)	(0.18)	(0.17)	(0.06)

Twin	FCAG71A X 2	FAA71A X 2	FHA71A X 2	FUA71A X 2	FBA71A X 2	FNA71A X 2
AFR	15.3 x 2	18.0 x 2	20.5 x 2	23.0 x 2	18.0 x 2	18.0 x 2
(BF)	(0.14 x 2)	(0.16 x 2)	(0.13 x 2)	(0.24 x 2)	(0.13 x 2)	(0.16 x 2)

Triple	FCAG50A X 3	FHA50A X 3	FFA50A X 3	FDXM50F3 X 3	FBA50A X 3	FNA50A X 3
AFR	12.6 x 3	15.0 x 3	12.0 x 3	15.0 x 3	16.0 x 3	16.0 x 3
(BF)	(0.22 x 3)	(0.18 x 3)	(0.16 x 3)	(0.11 x 3)	(0.13 x 3)	(0.11 x 3)

Double twin	FCAG35A X 4	FHA35A X 4	FFA35A X 4	FDXM35F3 X 4	FBA35A X 4	FNA35A X 4
AFR	12.5 x 4	14.0 x 4	10.0 x 4	15.0 x 4	15.0 x 4	15.0 x 4
(BF)	(0.4 x 4)	(0.20 x 4)	(0.25 x 4)	(0.17 x 4)	(0.08 x 4)	(0.17 x 4)

Pair	FCAG140A	FVA140A	FHA140A	FBA140A
Cooling	4.88	5.12	4.84	4.76
Heating	5.01	5.43	5.59	5.13

Twin	FCAG71A X 2	FAA71A X 2	FHA71A X 2	FUA71A X 2	FBA71A X 2	FNA71A X 2
Cooling	3.87	4.14	3.91	3.62	3.82	4.52
Heating	4.72	4.85	4.58	4.22	5.01	5.21

Triple	FCAG50A X 3	FHA50A X 3	FFA50A X 3	FDXM50F3 X 3	FBA50A X 3	FNA50A X 3
Cooling	3.39	4.14	4.32	2.86	3.91	2.86
Heating	4.34	4.21	5.15	4.12	4.43	4.12

Double twin	FCAG35A X 4	FHA35A X 4	FFA35A X 4	FDXM35F3 X 4	FBA35A X 4	FNA35A X 4
Cooling	3.05	3.06	3.66	3.65	3.51	3.65
Heating	3.97	3.58	5.62	4.93	4.63	4.93

3D112147

6 Capacity tables

6 - 2 Capacity Correction Factor

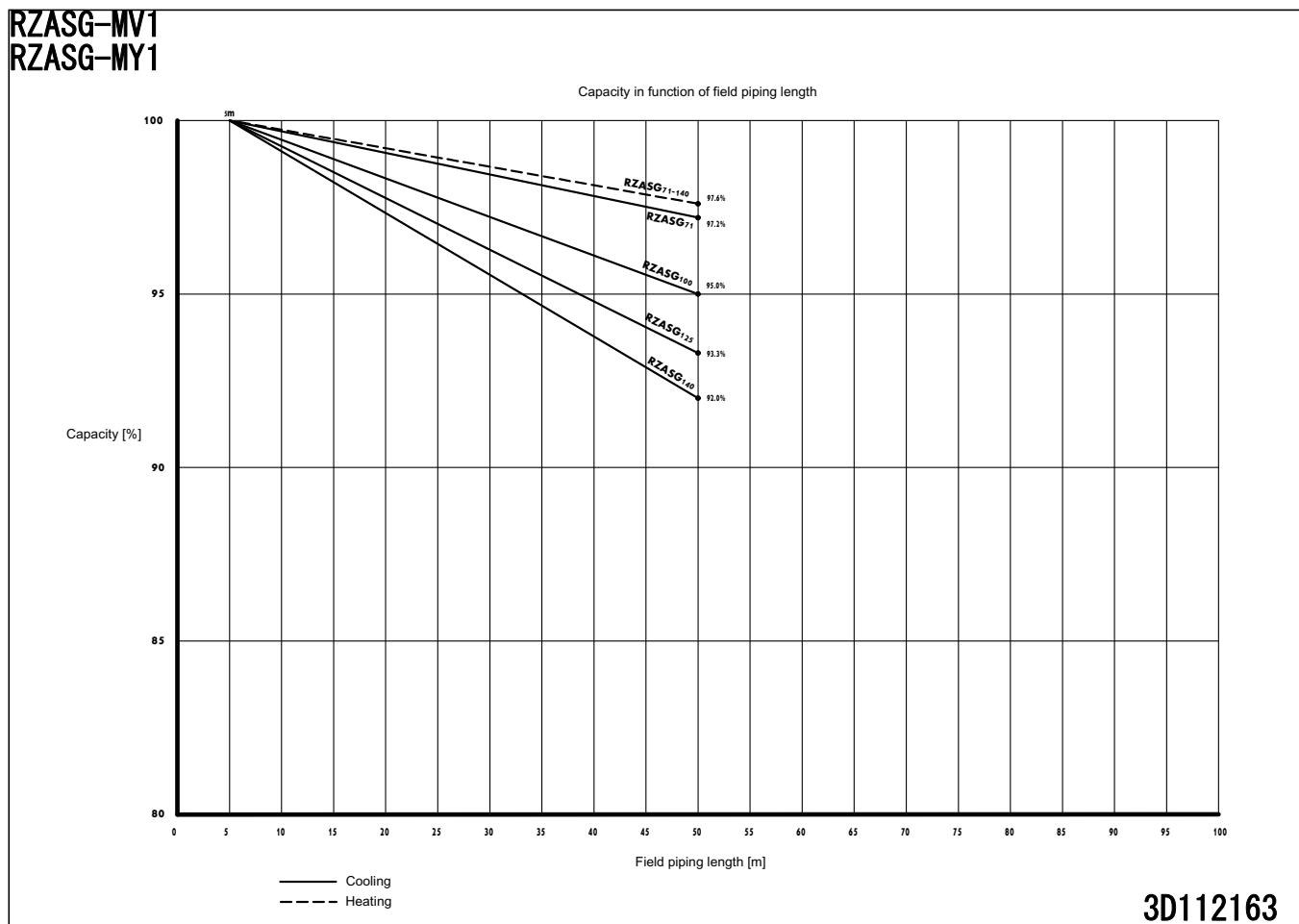

7 Dimensional drawings

7 - 1 Dimensional Drawings

7

AZAS71MV1 RZASG71MV1

4 holes for anchor bolts
M12

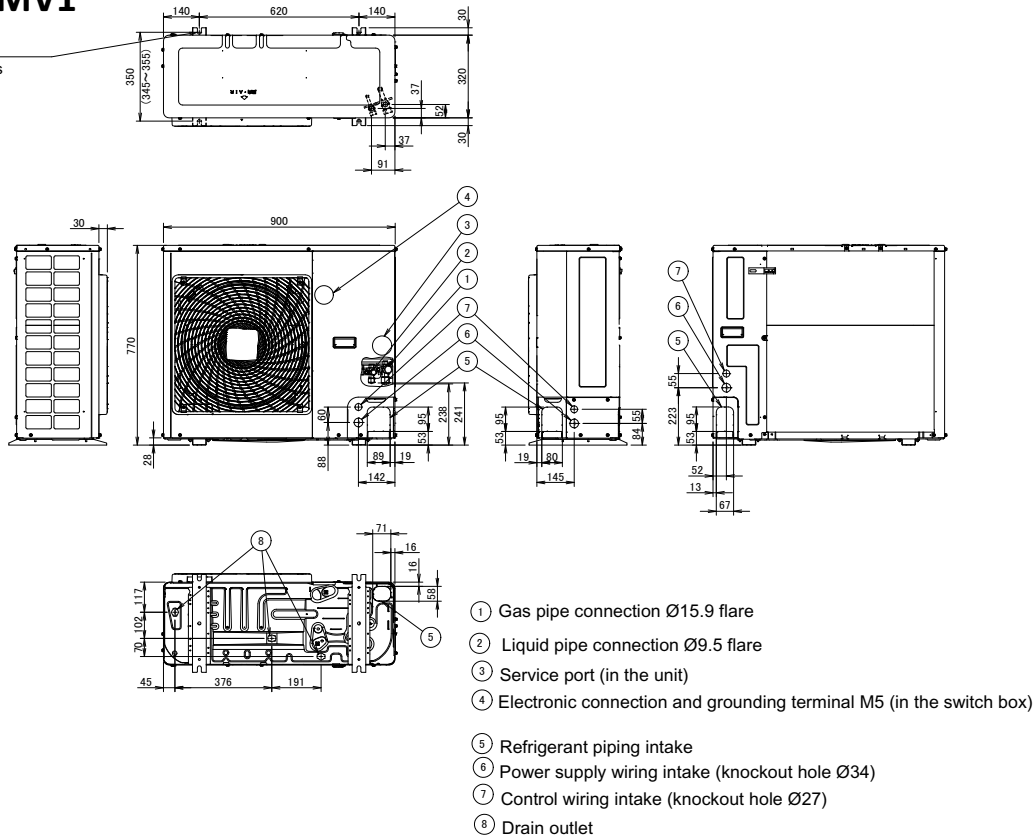

3D110013

AZAS100-140MV1 AZAS-MY1 RZAG71MV1 RZAG71MY1 RZASG100-140MV1 RZASG-MY1

4 holes for anchor bolts
M12

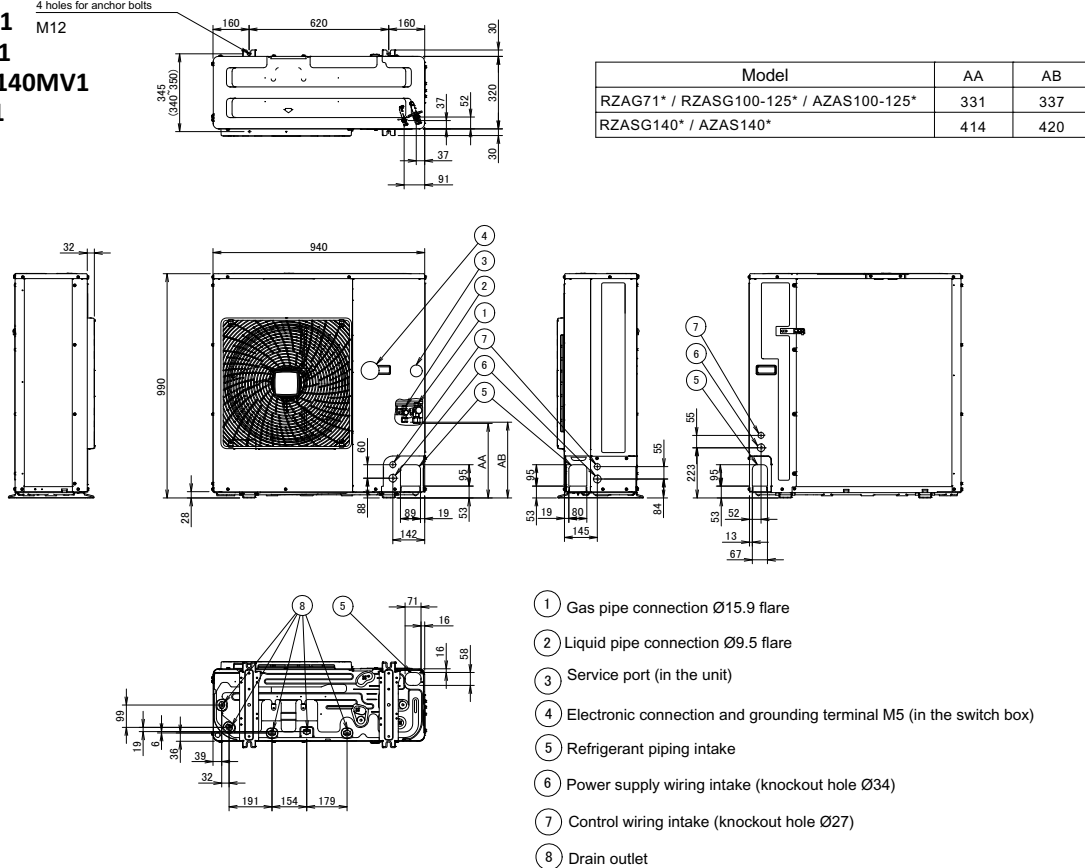

3D110011

8 Centre of gravity

8 - 1 Centre of Gravity

AZAS71MV1
RZASG71MV1



4D110027

8 Centre of gravity

8 - 1 Centre of Gravity

8

AZAS100-140MV1

AZAS-MY1

RZAG71MV1

RZAG71MY1

RZASG100-140MV1

RZASG-MY1

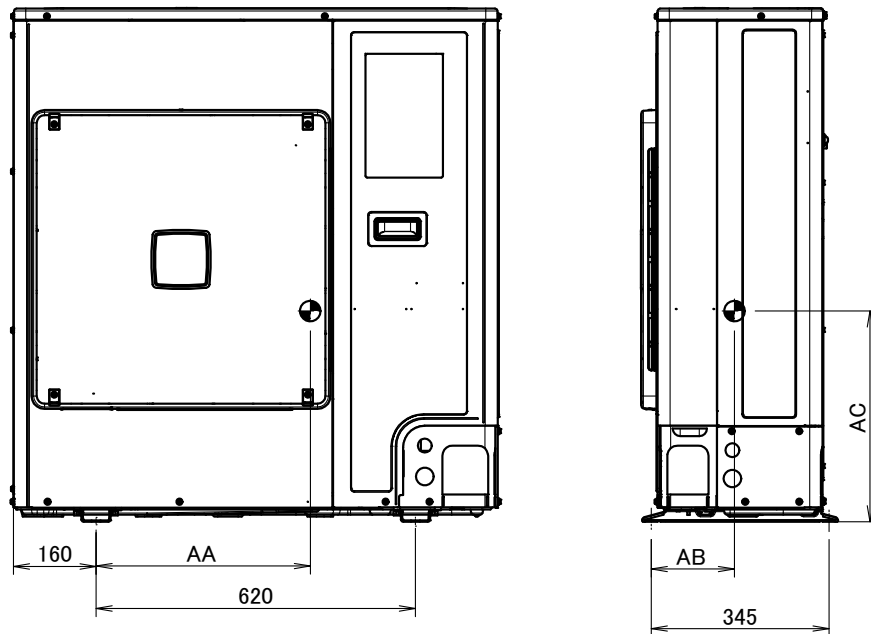

Model	AA	AB	AC
RZAG71M7V*	414	163	407
RZAG71M7Y*	432	137	407
RZASG100-125M7V* / AZAS100-125M7V*	425	181	422
RZASG100-125M7Y* / AZAS100-125M7Y*	414	156	417
RZASG140M7V* / AZAS140M7V*	414	161	423
RZASG140M7Y* / AZAS140M7Y*	416	151	418

4D110025

9 Piping diagrams

9 - 1 Piping Diagrams

AZAS-MV1
 AZAS-MY1
 RZAG-MV1
 RZAG-MY1
 RZASG-MV1
 RZASG-MY1

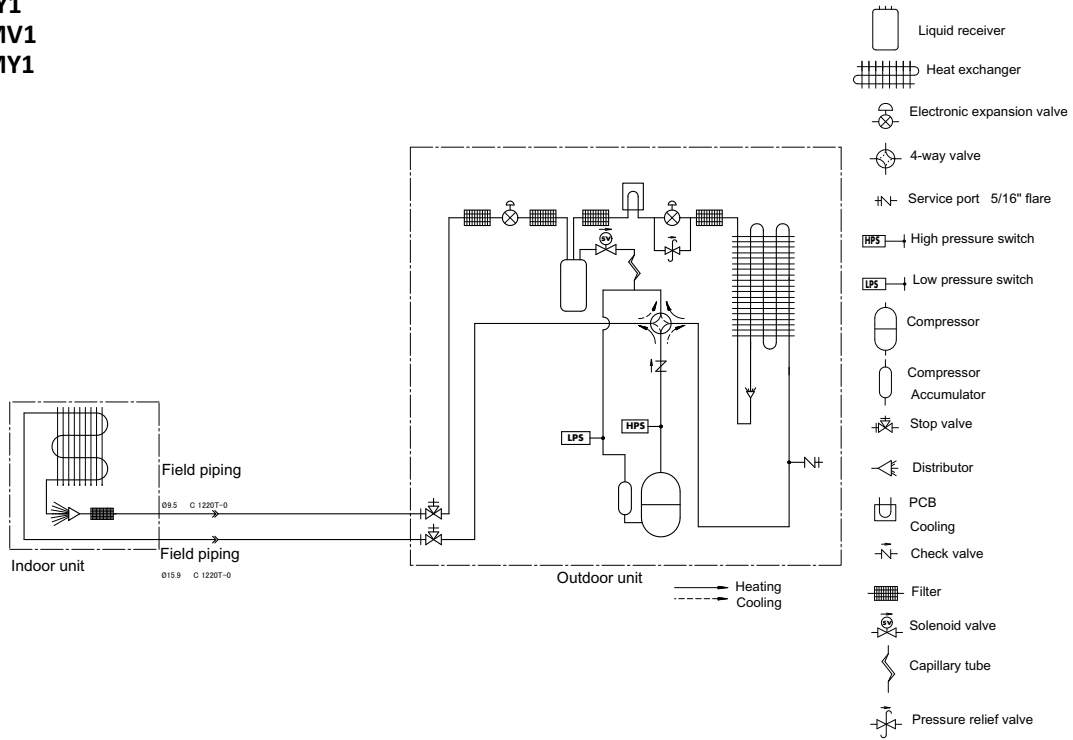

Notes

- The pipes between the branch and the indoor units should have the same size as the indoor connections.

3D108855A

9 Piping diagrams

9 - 2 Piping Diagram Twin Application

9

RZAG-MV1
RZAG-MY1
RZASG-MV1
RZASG-MY1

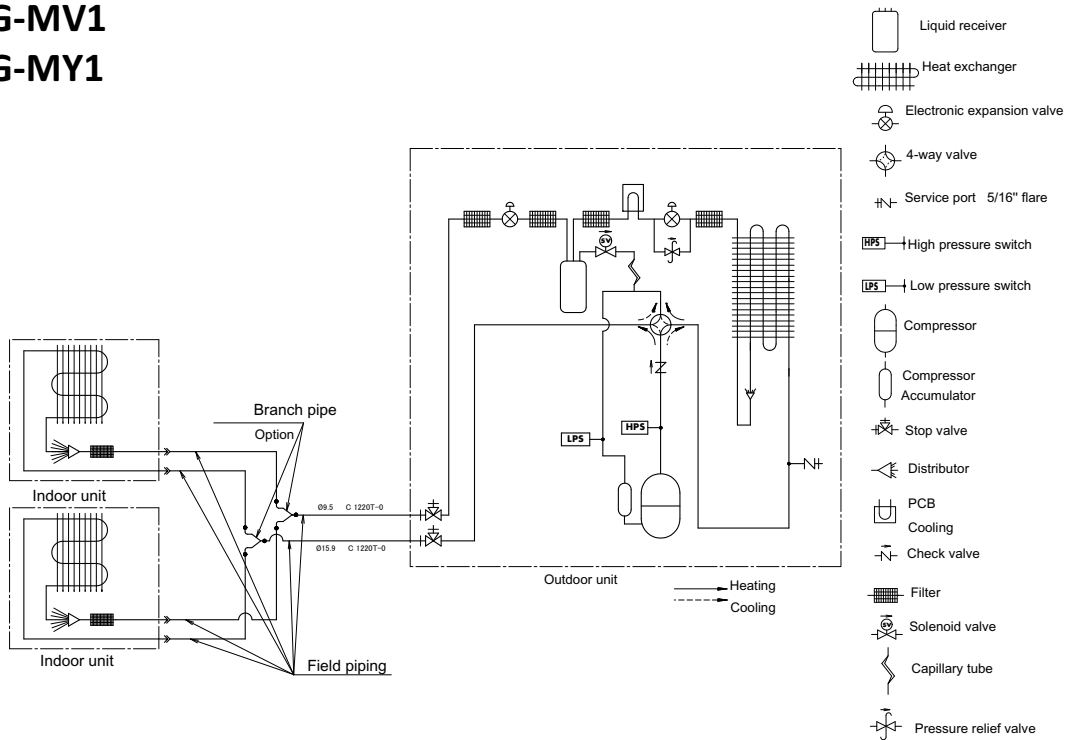

Notes

1. The pipes between the branch and the indoor units should have the same size as the indoor connections.

3D108856A

9 Piping diagrams

9 - 3 Piping Diagram Triple Application

RZAG100-140MV1
RZAG100-140MY1
RZASG100-140MV1
RZASG-MY1

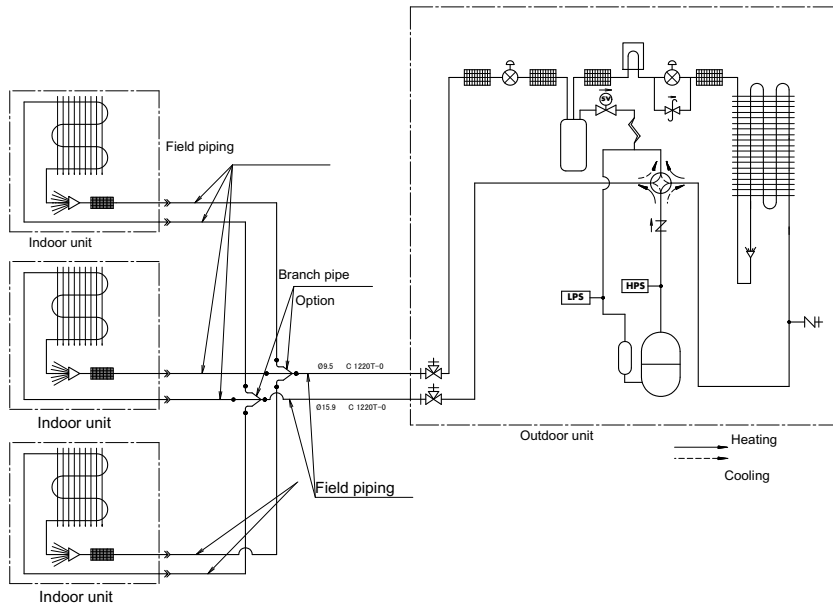

- Liquid receiver
- Heat exchanger
- Electronic expansion valve
- 4-way valve
- Service port 5/16" flare
- High pressure switch
- Low pressure switch
- Compressor
- Accumulator
- Stop valve
- Distributor
- PCB
- Cooling
- Check valve
- Filter
- Solenoid valve
- Capillary tube
- Pressure relief valve

Notes

1. The pipes between the branch and the indoor units should have the same size as the indoor connections.

3D108857A

9 Piping diagrams

9 - 4 Piping Diagram Double Twin Application

9

RZAG125-140MV1
 RZAG125-140MY1
 RZASG125-140MV1
 RZASG125-140MY1

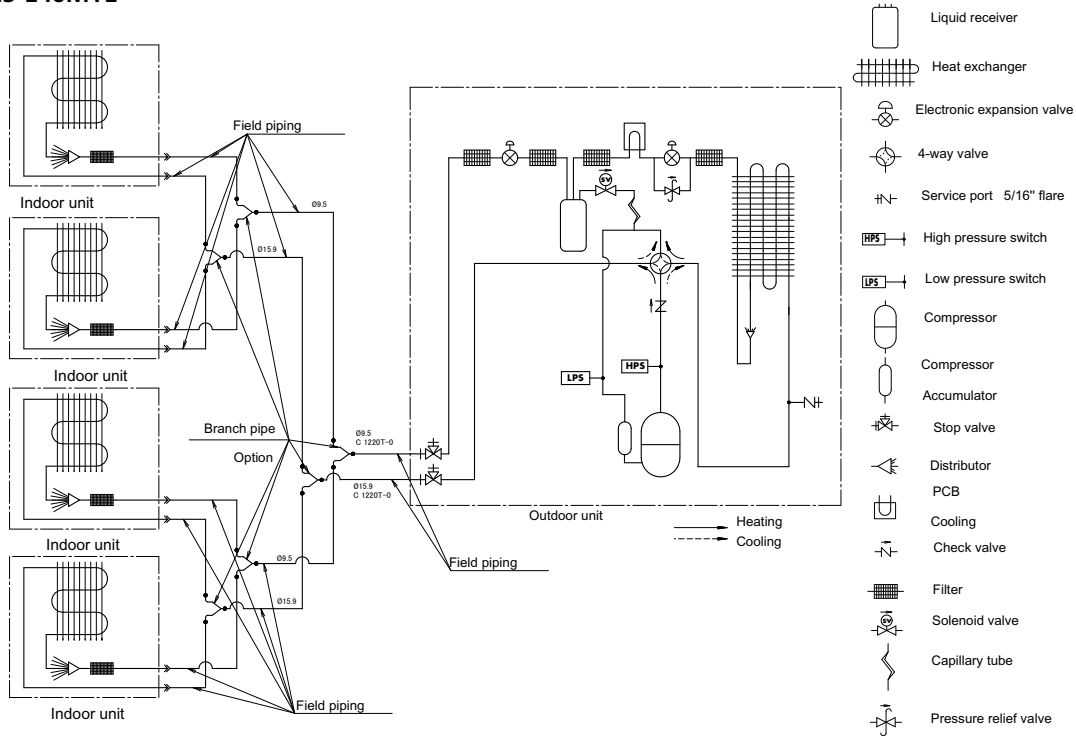

Notes
 1. The pipes between the branch and the indoor units should have the same size as the indoor connections.

3D108858A

10 Wiring diagrams

10 - 1 Wiring Diagrams - Single Phase

AZAS71MV1, RZASG71MV1

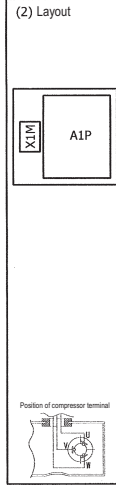
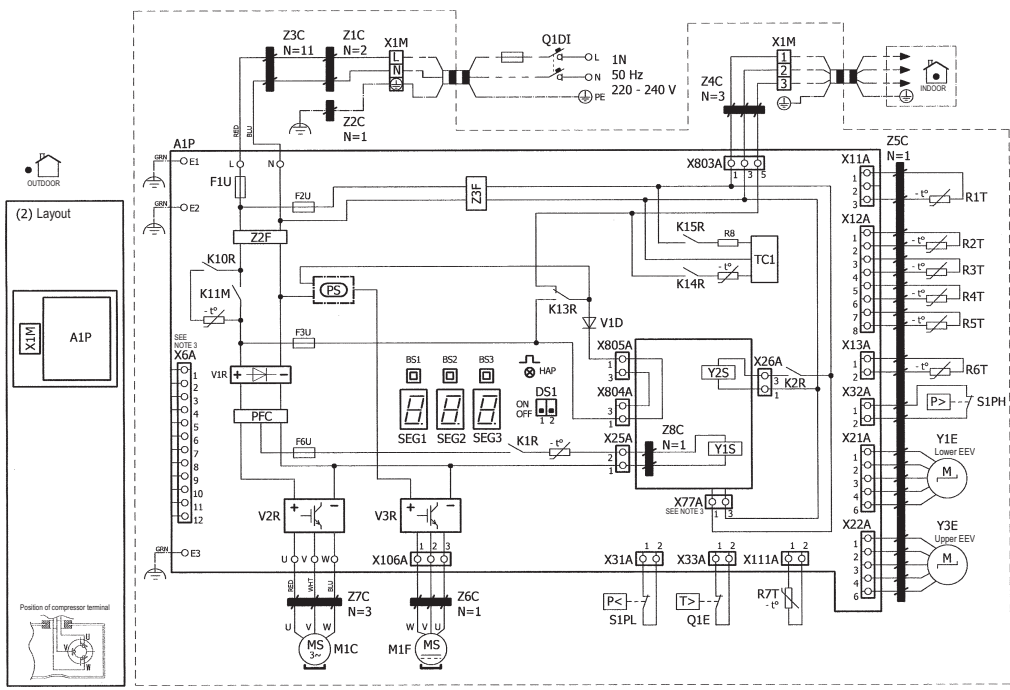

+ : Connection
 X1M : Main terminal
 --- : Earth wiring
 - - - : Field supply
 [] : Option
 [] : Switch box
 [] : PCB
 [] : Wiring depending on model
 [] : Protective earth
 [] : Field wire

- NOTES**
1. Refer to the wiring diagram sticker (on the back of the front plate) for how to use the BS1-BS3 and DS1 switches.
 2. When operating, do not short-circuit protection device(s) S1PH, S1PL and Q1E.
 3. Refer to the combination table and the option manual for how to connect the wiring to X6A and X77A.
 4. Colours: BLK: Black, RED: Red, BLU: Blue, WHT: White, GRN: Green.

Part n°	Description
A1P	Printed circuit board (main)
BS1-3 (A1P)	Push-button switch
DS1 (A1P)	Dipswitch
E1-3 (AAP)	Connector
F1U (A1P)	Fuse T 31.5 A 250 V
F2U (A1P)	Fuse T 6.3 A 250 V
F3U (A1P)	Fuse T 6.3 A 250 V
F4U (A1P)	Fuse T 5 A 250 V
F6U (A1P)	Fuse T 5 A 250 V
F8U (A1P)	Fuse F 1 A 250 V
HAP (A1P)	Light-emitting diode (service monitor is green)
K1R (A1P)	Magnetic relay (Y1S)
K2R (A1P)	Magnetic relay (Y2S)
K4R (A1P)	Magnetic relay (E1H)
K13R-K15R, K10R (A1P)	Magnetic relay
K11M (A1P)	Magnetic contactor
L (A1P)	Connector
M1C	Compressor motor
M1F	Fan motor
N (A1P)	Connector
PFC (A1P)	Power factor correction
PS (A1P)	Switching power supply
Q1DI	Earth leakage circuit breaker (30mA)
Q1E	Overload protection
R1T	Thermistor (air)
R2T	Thermistor (discharge)
R3T	Thermistor (suction)
R4T	Thermistor (heat exchanger)
R5T	Thermistor (heat exchanger middle)
R6T	Thermistor (liquid)
R7T	Thermistor (fin)
R8 (A1P)	Resistor
S1PH	High pressure switch
S1PL	Low pressure switch
SEG1-3 (A1P)	7-segment display
TC1 (A1P)	Signal transceiver circuit
U, V, W (A1P)	Connector
V1D (A1P)	Diode
V'R (A1P)	Diode module
X'A (A1P)	Connector
X1M	Terminal strip
Y1E, Y3E	Electronic expansion valve
Y1-2S	Solenoid valve (4-way valve)
Z'C	Noise filter (ferrite core)
Z'F (A1P)	Noise filter

4D110098

RZAG71MV1, RZASG100MV1, AZAS100MV1

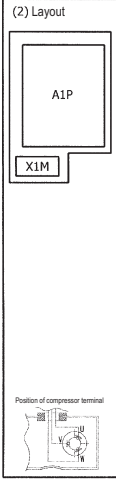
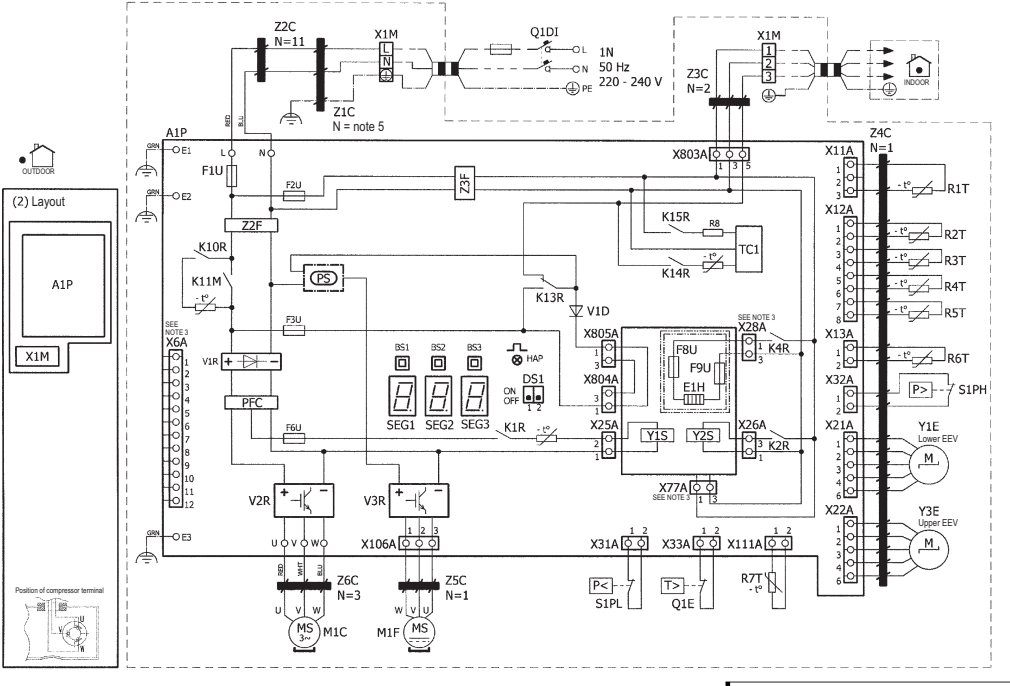

+ : Connection
 X1M : Main terminal
 --- : Earth wiring
 - - - : Field supply
 [] : Option
 [] : Switch box
 [] : PCB
 [] : Wiring depending on model
 [] : Protective earth
 [] : Field wire

- NOTES**
1. Refer to the wiring diagram sticker (on the back of the front plate) for how to use the BS1-BS3 and DS1 switches.
 2. When operating, do not short-circuit protection device(s) S1PH, S1PL and Q1E.
 3. Refer to the combination table and the option manual for how to connect the wiring to X6A, X28A and X77A.
 4. Colours: BLK: Black, RED: Red, BLU: Blue, WHT: White, GRN: Green.
 5. Windings: L-N: 2-Earth: 1

Part n°	Description
A1P	Printed circuit board (main)
BS1-3 (A1P)	Push-button switch
DS1 (A1P)	Dipswitch
E1-3 (AAP)	Connector
E1H	Bottom plate heater
F1U (A1P)	Fuse T 31.5 A 250 V
F2U (A1P)	Fuse T 6.3 A 250 V
F3U (A1P)	Fuse T 6.3 A 250 V
F4U (A1P)	Fuse T 5 A 250 V
F6U (A1P)	Fuse T 5 A 250 V
F8-9U	Fuse F 1 A 250 V
HAP (A1P)	Light-emitting diode (service monitor is green)
K1R (A1P)	Magnetic relay (Y1S)
K2R (A1P)	Magnetic relay (Y2S)
K4R (A1P)	Magnetic relay (E1H)
K13R-K15R, K10R (A1P)	Magnetic relay
K11M (A1P)	Magnetic contactor
L (A1P)	Connector
M1C	Compressor motor
M1F	Fan motor
N (A1P)	Connector
PFC (A1P)	Power factor correction
PS (A1P)	Switching power supply
Q1DI	Earth leakage circuit breaker (30mA)
Q1E	Overload protection
R1T	Thermistor (air)
R2T	Thermistor (discharge)
R3T	Thermistor (suction)
R4T	Thermistor (heat exchanger)
R5T	Thermistor (heat exchanger middle)
R6T	Thermistor (liquid)
R7T	Thermistor (fin)
R8 (A1P)	Resistor
S1PH	High pressure switch
S1PL	Low pressure switch
SEG1-3 (A1P)	7-segment display
TC1 (A1P)	Signal transceiver circuit
U, V, W (A1P)	Connector
V1D (A1P)	Diode
V'R (A1P)	Diode module
X1M	Terminal strip
Y1E, Y3E	Electronic expansion valve
Y1-2S	Solenoid valve (4-way valve)
Z'C	Noise filter (ferrite core)
Z'F (A1P)	Noise filter

4D109936

10 Wiring diagrams

10 - 1 Wiring Diagrams - Single Phase

10

RZAG100-140MV1, RZASG125-140MV1, AZAS125-140MV1

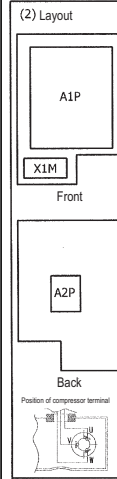
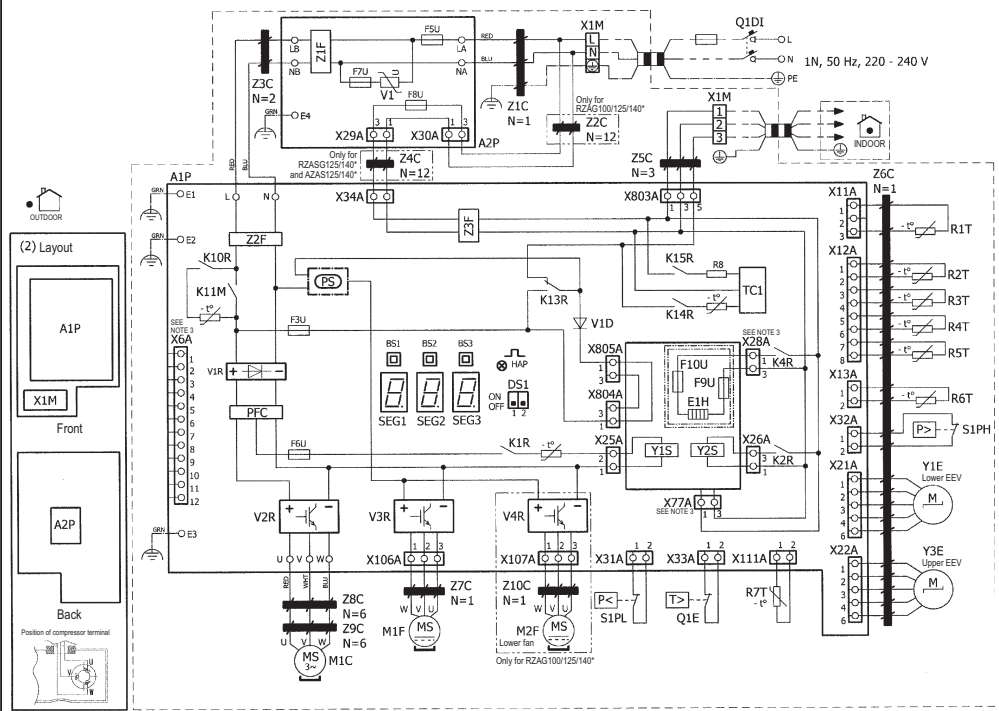

Part n°	Description
A1P	Printed circuit board (main)
A2P	Printed circuit board (noise filter)
BS1-3 (A1P)	Push-button switch
DS1 (A1P)	Dipswitch
E1-3 (A1-2P)	Connector
E1H	Bottom plate heater
F3U (A1P)	Fuse T 6.3 A 250 V
F5U (A2P)	Fuse T 56 A 250 V
F6U (A1P)	Fuse T 5 A 250 V
F7U (A2P)	Fuse T 6.3 A 250 V
F8U (A2P)	Fuse F 6.3 A 250 V
F9-10U	Fuse F 1 A 250 V
HAP (A1P)	Light-emitting diode (service monitor is green)
K1R (A1P)	Magnetic relay (Y1S)
K2R (A1P)	Magnetic relay (Y2S)
K4R (A1P)	Magnetic relay (E1H)
K13-15R, K10R (A1P)	Magnetic relay
K11M (A1P)	Magnetic contactor
L* (A1-2P)	Connector
M1C	Compressor motor
M1-2F	Fan motor
PFC (A1P)	Power factor correction
PS (A1P)	Switching power supply
Q1DI	Earth leakage circuit breaker (30mA)
Q1E	Overload protection
R1T	Thermistor (air)
R2T	Thermistor (discharge)
R3T	Thermistor (suction)
R4T	Thermistor (heat exchanger)
R5T	Thermistor (heat exchanger middle)
R6T	Thermistor (liquid)
R7T	Thermistor (fin)
R8 (A1P)	Resistor
S1PH	High pressure switch
S1PL	Low pressure switch
SEG1-3 (A1P)	7-segment display
TC1 (A1P)	Signal transceiver circuit
U, V, W (A1P)	Connector
V1 (A2P)	Varistor
V1D (A1P)	Diode
VTR (A1P)	Diode module
X*A (A1-2P)	Connector
X1M	Terminal strip
Y1E, Y3E	Electronic expansion valve
Y1-2S	Solenoid valve (4-way valve)
Z'C	Noise filter (ferite core)
Z'F (A1-2P)	Noise filter

- ⊕ : Connection
- ⊕ : Main terminal
- ⊕ : Earth wiring
- ⊕ : Field supply
- ⊕ : Several wiring possibilities
- ⊕ : Protective earth
- ⊕ : Field wire
- ⊕ : Wiring depending on model
- ⊕ : option
- ⊕ : switch box
- ⊕ : PCB

- NOTES**
1. Refer to the wiring diagram sticker (on the back of the front plate) for how to use the BS1-BS3 and DS1 switches.
 2. When operating, do not short-circuit protection device(s) S1PH, S1PL and Q1E.
 3. Refer to the combination table and the option manual for how to connect the wiring to X8A, X28A and X77A.
 4. Colours: BLK: Black, RED: Red, BLU: Blue, WHT: White, GRN: Green.

4D109863

11 Sound data

11 - 1 Sound Power Spectrum

AZAS71MV1
RZASG71MV1

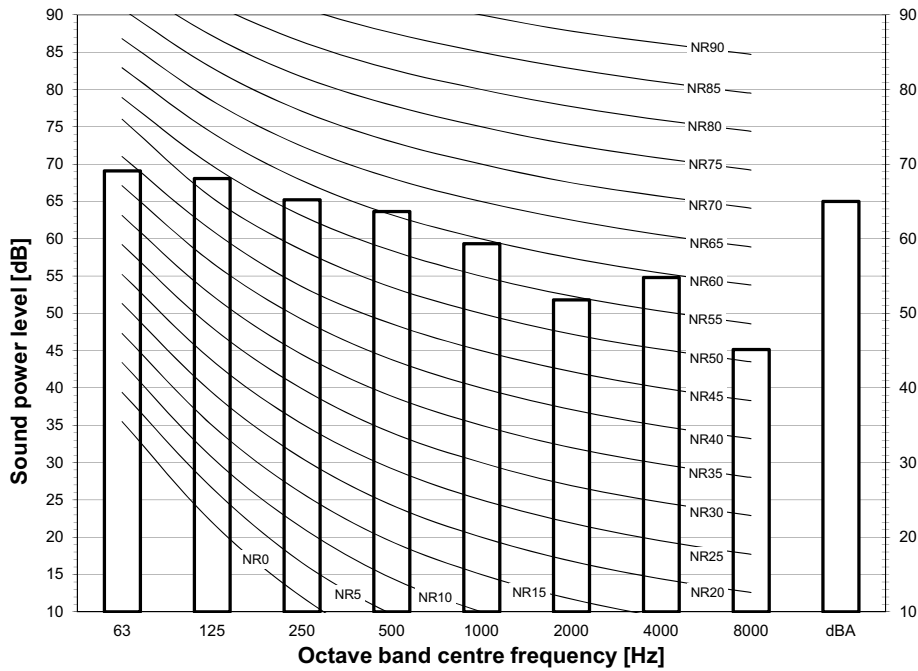

Notes

- dBA = A-weighted sound power level (A scale according to IEC).
- Reference acoustic intensity 0dB = 10E-6μW/m²
- Measured according to ISO 3744

3D110037

AZAS100MV1
AZAS100MY1
RZASG100MV1
RZASG100MY1

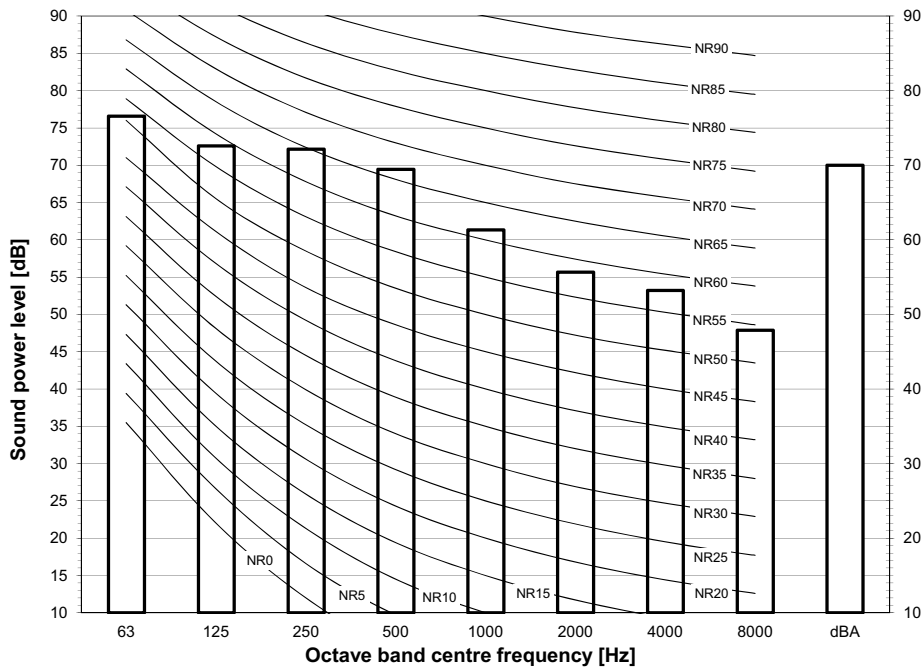

Notes

- dBA = A-weighted sound power level (A scale according to IEC).
- Reference acoustic intensity 0dB = 10E-6μW/m²
- Measured according to ISO 3744

3D110038

11 Sound data

11 - 1 Sound Power Spectrum

11

AZAS125MV1
 AZAS125MY1
 RZASG125MV1
 RZASG125MY1

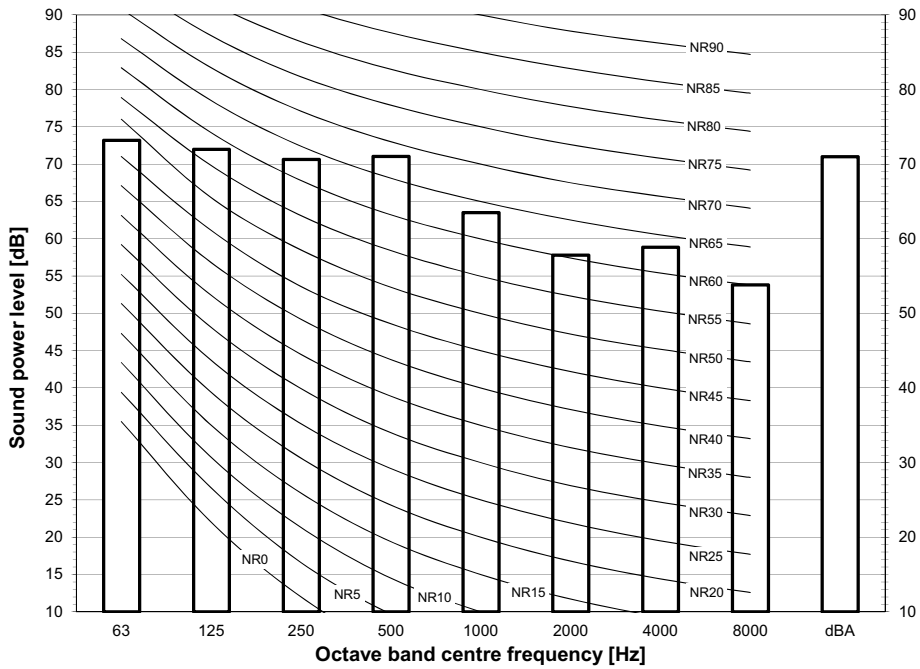

Notes
 - dBA = A-weighted sound power level (A scale according to IEC).
 - Reference acoustic intensity 0dB = 10E-6μW/m²
 - Measured according to ISO 3744

3D110039

AZAS140MV1
 AZAS140MY1
 RZASG140MV1
 RZASG140MY1

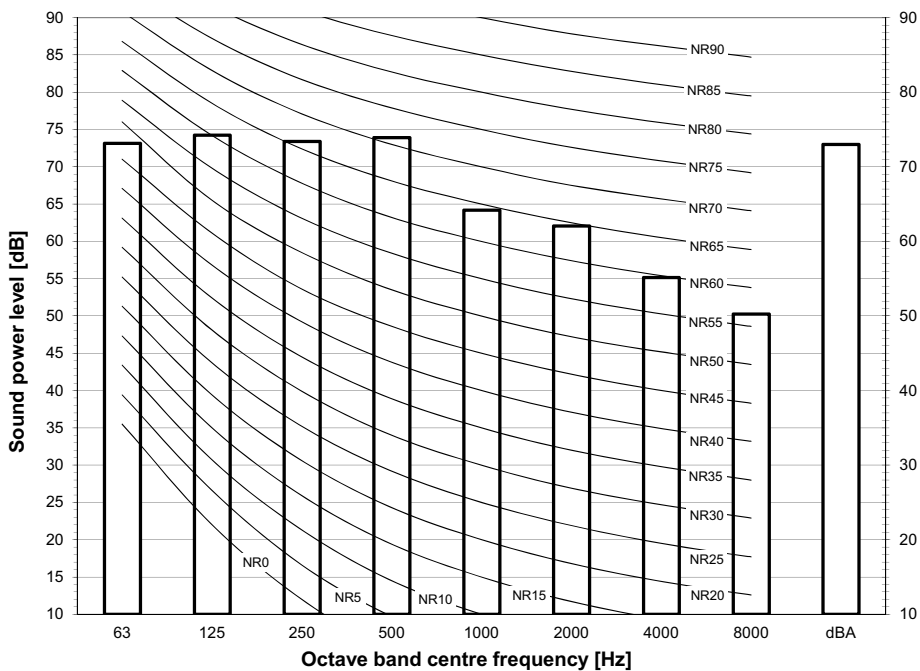

Notes
 - dBA = A-weighted sound power level (A scale according to IEC).
 - Reference acoustic intensity 0dB = 10E-6μW/m²
 - Measured according to ISO 3744

3D110040

11 Sound data

11 - 2 Sound Pressure Spectrum - Cooling

AZAS71MV1
RZASG71MV1

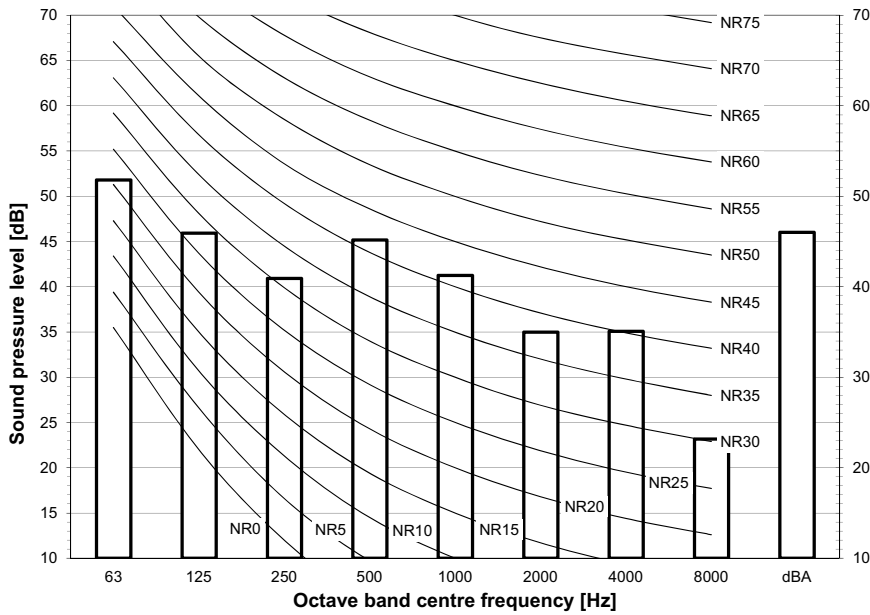

Notes

- Data is valid at free field condition.
- Data is valid at nominal operation condition.
- dBA = A-weighted sound pressure level (A scale according to IEC).
- Reference acoustic pressure 0 dB = 20 µPa

3D110049

AZAS100MV1
AZAS100MY1
RZASG100MV1
RZASG100MY1

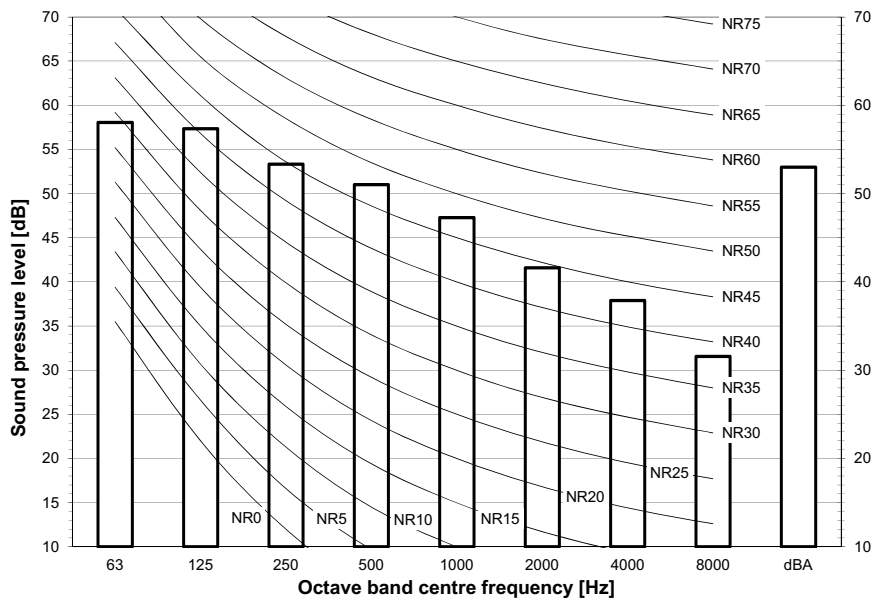

Notes

- Data is valid at free field condition.
- Data is valid at nominal operation condition.
- dBA = A-weighted sound pressure level (A scale according to IEC).
- Reference acoustic pressure 0 dB = 20 µPa

3D110050

11 Sound data

11 - 2 Sound Pressure Spectrum - Cooling

11

AZAS125MV1
 AZAS125MY1
 RZASG125MV1
 RZASG125MY1

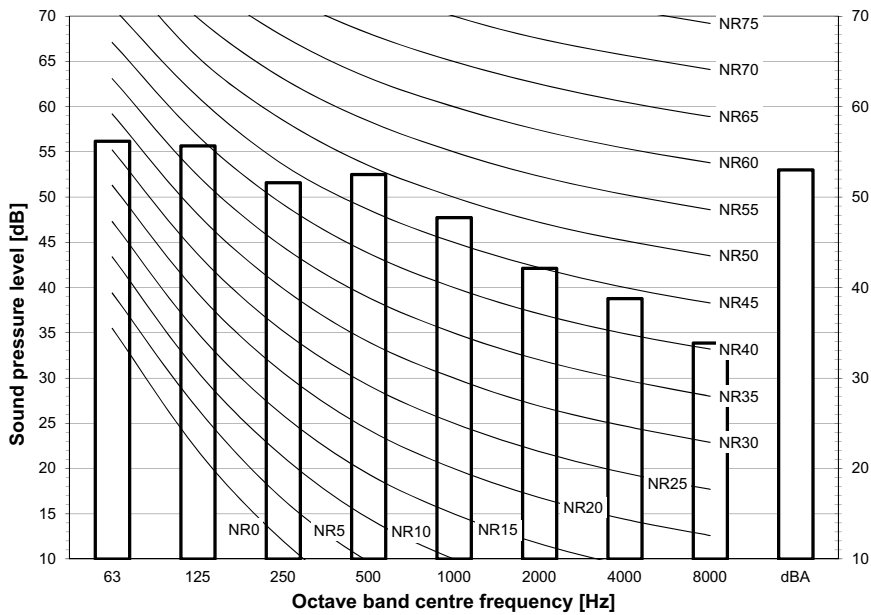

- Notes**
- Data is valid at free field condition.
 - Data is valid at nominal operation condition.
 - dBA = A-weighted sound pressure level (A scale according to IEC).
 - Reference acoustic pressure 0 dB = 20 μPa

3D110051

AZAS140MV1
 AZAS140MY1
 RZASG140MV1
 RZASG140MY1

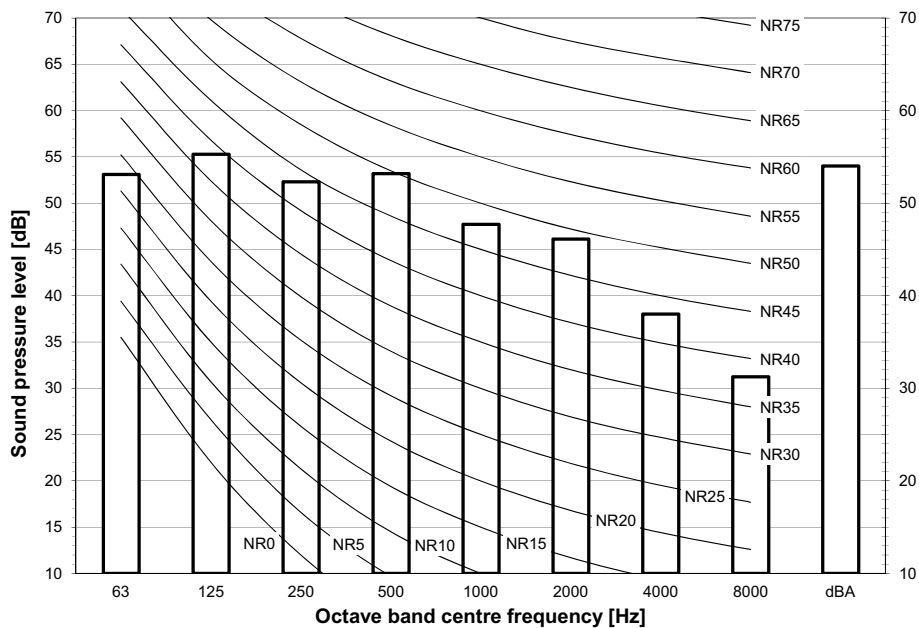

- Notes**
- Data is valid at free field condition.
 - Data is valid at nominal operation condition.
 - dBA = A-weighted sound pressure level (A scale according to IEC).
 - Reference acoustic pressure 0 dB = 20 μPa

3D111310

11 Sound data

11 - 3 Sound Pressure Spectrum - Heating

AZAS71MV1
RZASG71MV1

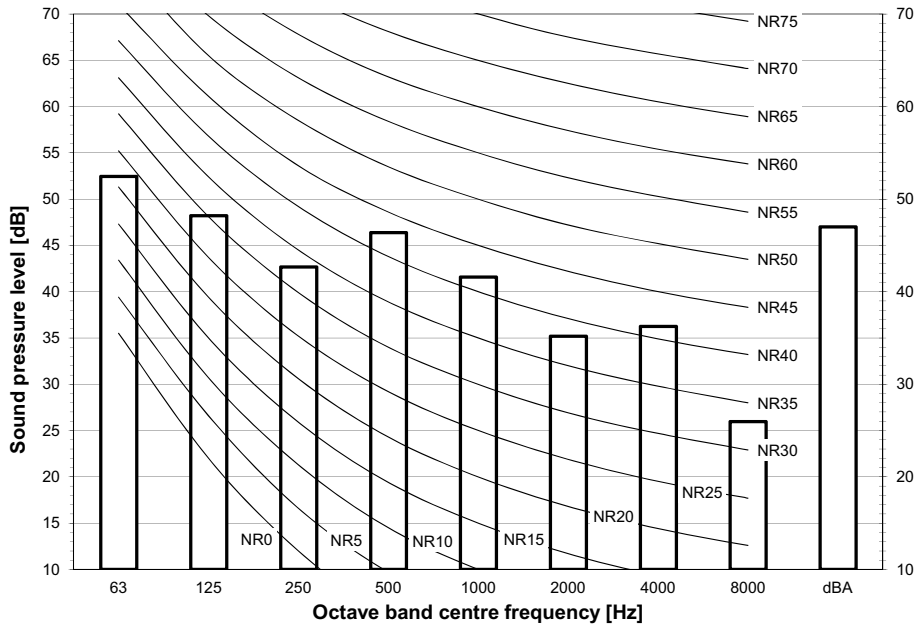

Notes

- Data is valid at free field condition.
- Data is valid at nominal operation condition.
- dBA = A-weighted sound pressure level (A scale according to IEC).
- Reference acoustic pressure 0 dB = 20 µPa

3D111293

AZAS100MV1
AZAS100MY1
RZASG100MV1
RZASG100MY1

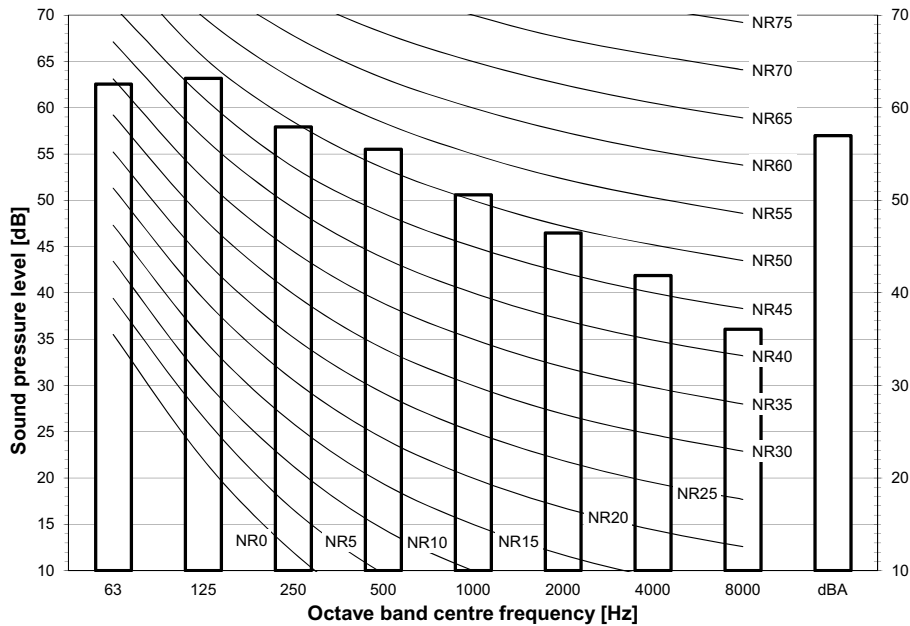

Notes

- Data is valid at free field condition.
- Data is valid at nominal operation condition.
- dBA = A-weighted sound pressure level (A scale according to IEC).
- Reference acoustic pressure 0 dB = 20 µPa

3D111294

11 Sound data

11 - 3 Sound Pressure Spectrum - Heating

11

AZAS125MV1
 AZAS125MY1
 RZASG125MV1
 RZASG125MY1

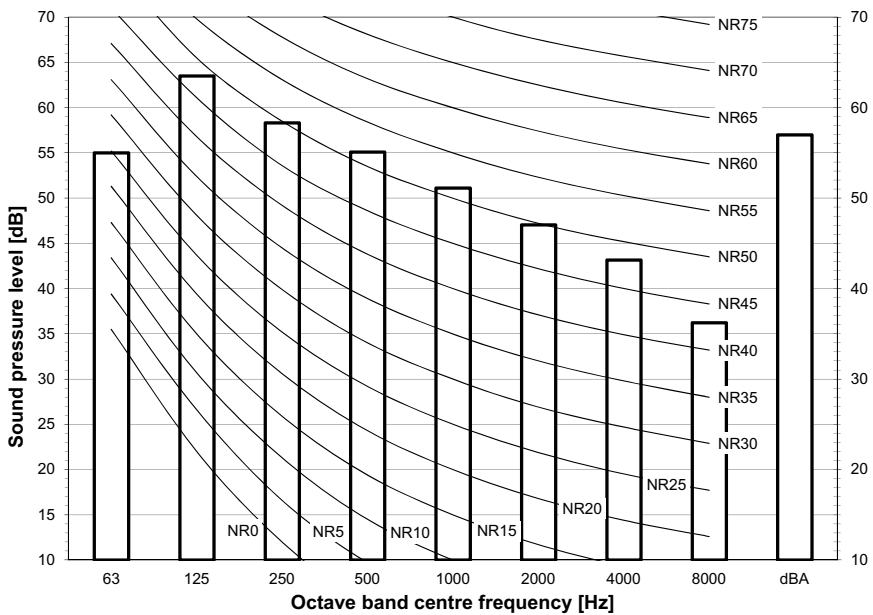

- Notes**
- Data is valid at free field condition.
 - Data is valid at nominal operation condition.
 - dBA = A-weighted sound pressure level (A scale according to IEC).
 - Reference acoustic pressure 0 dB = 20 μ Pa

3D111295

AZAS140MV1
 AZAS140MY1
 RZASG140MV1
 RZASG140MY1

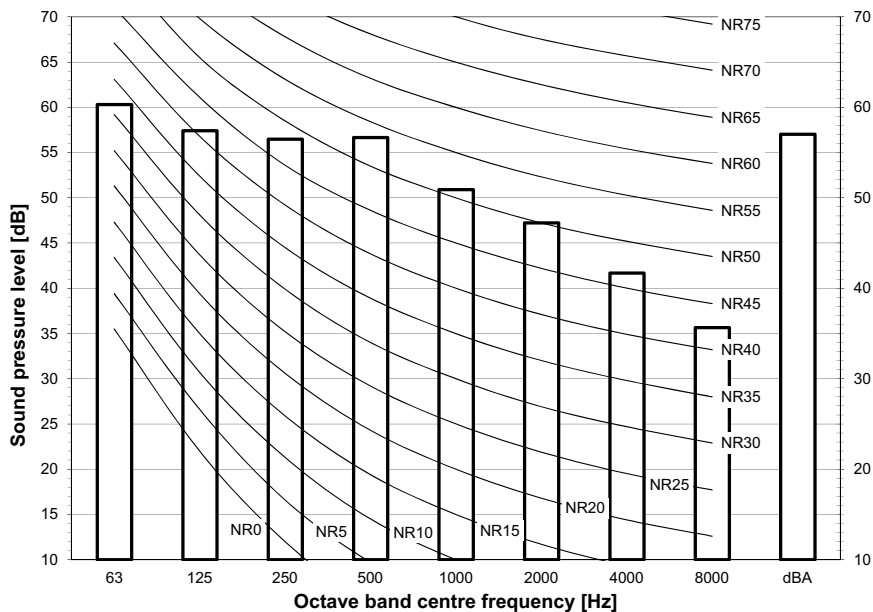

- Notes**
- Data is valid at free field condition.
 - Data is valid at nominal operation condition.
 - dBA = A-weighted sound pressure level (A scale according to IEC).
 - Reference acoustic pressure 0 dB = 20 μ Pa

3D111296

11 Sound data

11 - 4 Sound Pressure Spectrum Quiet Mode

AZAS71MV1
RZASG71MV1

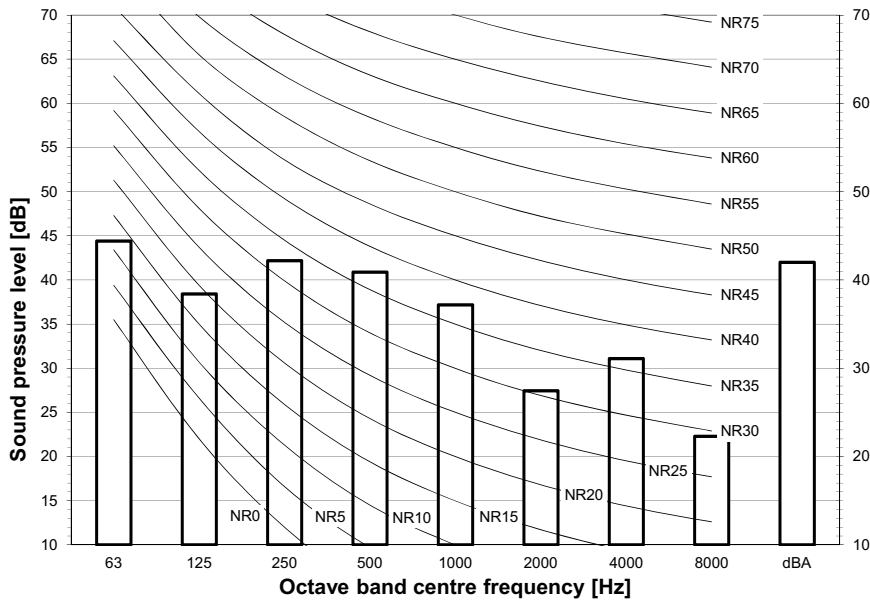

Notes

- Data is valid at free field condition.
- Data is valid at nominal operation condition.
- dBA = A-weighted sound pressure level (A scale according to IEC).
- Reference acoustic pressure 0 dB = 20 μPa

3D111315

AZAS100MV1
AZAS100MY1
RZASG100MV1
RZASG100MY1

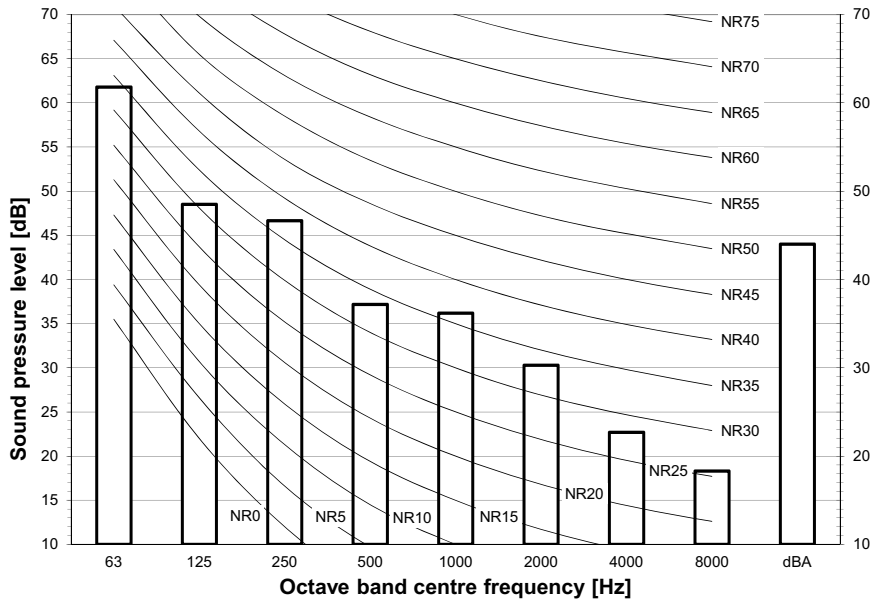

Notes

- Data is valid at free field condition.
- Data is valid at nominal operation condition.
- dBA = A-weighted sound pressure level (A scale according to IEC).
- Reference acoustic pressure 0 dB = 20 μPa

3D111316

11 Sound data

11 - 4 Sound Pressure Spectrum Quiet Mode

11

AZAS125MV1
 AZAS125MY1
 RZASG125MV1
 RZASG125MY1

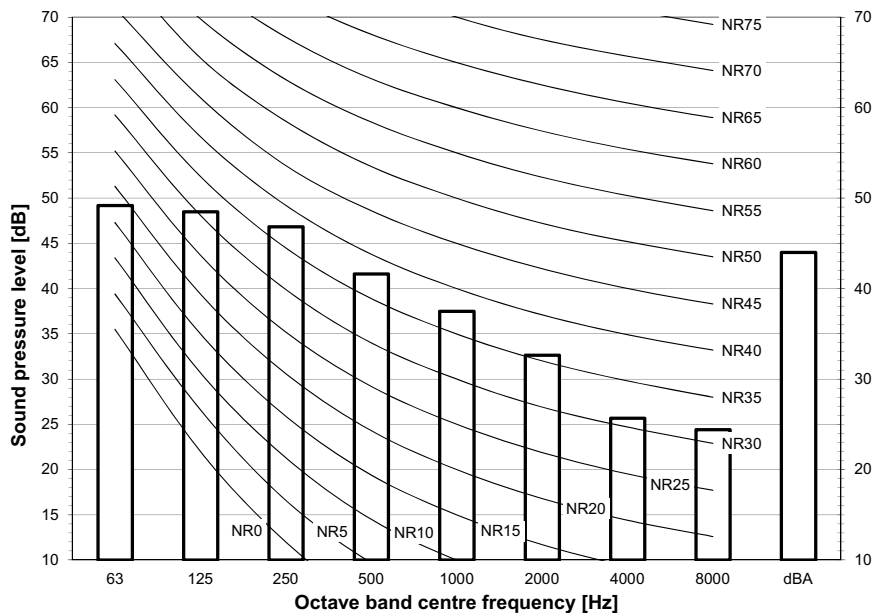

- Notes**
- Data is valid at free field condition.
 - Data is valid at nominal operation condition.
 - dBA = A-weighted sound pressure level (A scale according to IEC).
 - Reference acoustic pressure 0 dB = 20 μPa

3D111317

AZAS140MV1
 AZAS140MY1
 RZASG140MV1
 RZASG140MY1

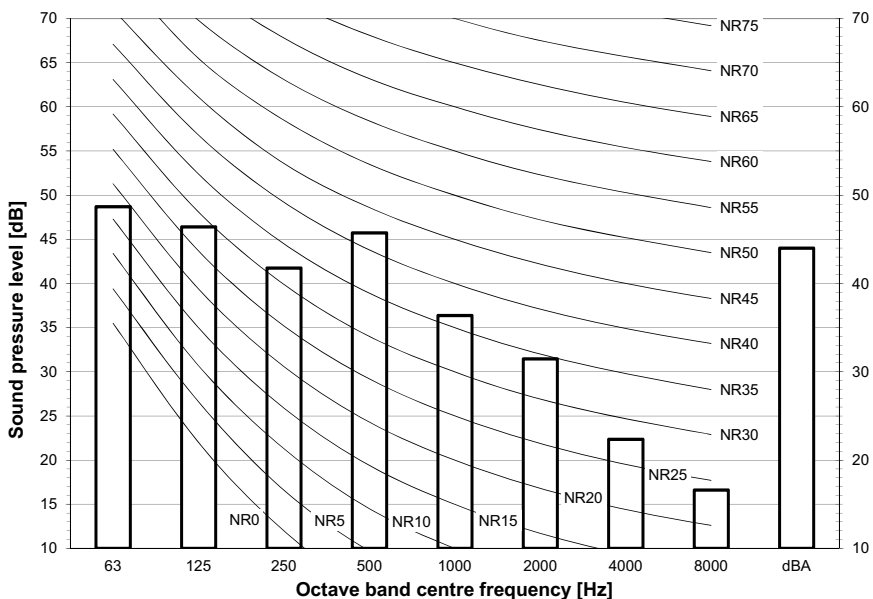

- Notes**
- Data is valid at free field condition.
 - Data is valid at nominal operation condition.
 - dBA = A-weighted sound pressure level (A scale according to IEC).
 - Reference acoustic pressure 0 dB = 20 μPa

3D111318

12 Installation

12 - 1 Installation Method

RZAG-MV1
 RZAG-MY1
 RZASG-MV1
 RZASG-MY1
 AZAS-MV1
 AZAS-MY1

Installation service space

The measure of these values is "mm".

(A) When there are obstacles on suction sides.

• No obstacle above

- ① Stand-alone installation
 - Obstacle on the suction side only

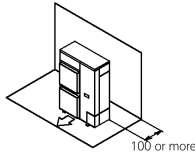

- Obstacle on both sides and suction side, too

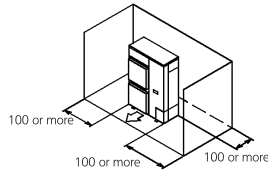

- ② Series installation (2 or more) (Note 1)
 - Obstacle on the suction side and both sides

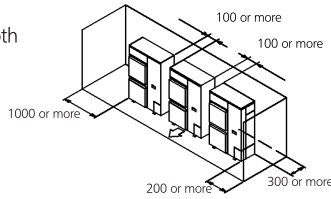

• Obstacle above, too.

- ① Stand-alone installation
 - Obstacle on the suction side, too

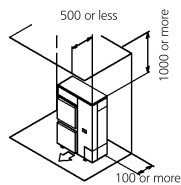

- Obstacle on both sides and suction side, too

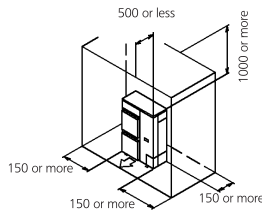

- ② Series installation (2 or more) (Note 1)
 - Obstacle on the suction side and both sides

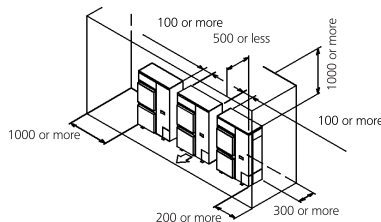

(B) When there are obstacles on discharge sides.

• No obstacle above

- ① Stand-alone installation
 - Obstacle on the discharge side only

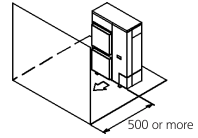

- ② Series installation (2 or more) (Note 1)
 - Obstacle on the discharge side only

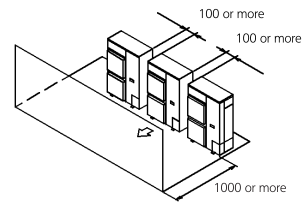

• Obstacle above, too

- ① Stand-alone installation
 - Obstacle on the discharge side only, too

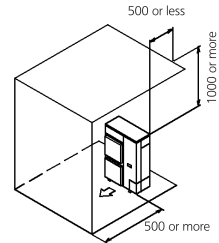

- ② Series installation (2 or more) (Note 1)
 - Obstacle on the discharge side

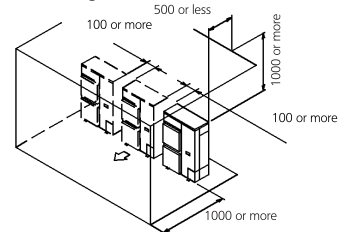

(C) When there are obstacles on both suction and discharge sides.:

Pattern 1

When the obstacles on the discharge side is higher than the unit. (L>H)
 (There is no limit for the height of obstructions on the suction side.)

• No obstacle above

- ① Stand-alone installation
 - No obstacle above

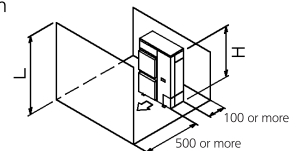

- ② Series installation (2 or more) (Note 1)
 - No obstacle above

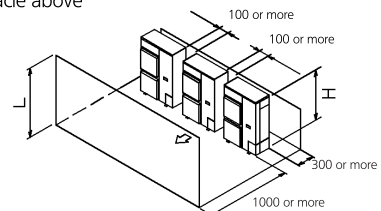

3D069554

12 Installation

12 - 1 Installation Method

12

RZAG-MV1
 RZAG-MY1
 RZASG-MV1
 RZASG-MY1
 AZAS-MV1
 AZAS-MY1

● **Obstacle above, too**

- ① Stand-alone installation (Note 2)
 ● When there are obstacles on suction, discharge and top sides.

The relations between H, A and L are as follows.

	L	A
$L \leq H$	$L \leq 1/2 H$ $1/2 H < L \leq H$	750 or more 1000 or more
$L > H$	Set the stand as : $L \leq H$ Refer to the column of $L \leq H$ for A	

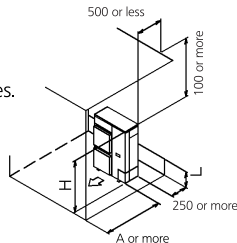

- ② Series installation (2 or more) (Note 1, 2)
 ● When there are obstacles on suction, discharge and top sides.

The relations between H, A and L are as follows.

	L	A
$L \leq H$	$L \leq 1/2 H$ $1/2 H < L \leq H$	1000 or more 1250 or more
$L > H$	Set the stand as : $L \leq H$ Refer to the column of $L \leq H$ for A	

Limit of series installation is 2 units.

Pattern 2

When the obstacle on the discharge side is lower than the unit ($L \leq H$) (There is no limit for the height of obstructions on the suction side.)

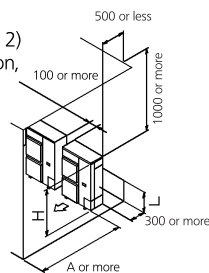

● **No obstacle above**

- ① Stand-alone installation
 ● No obstacle above

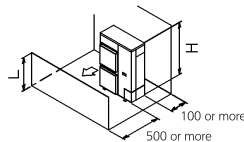

- ② Series installation (2 or more) (Note 1, 2)
 ● When there are obstacles on both suction and discharge sides.

The relations between H, A and L are as follows.

	L	A
$L \leq H$	$L \leq 1/2 H$ $1/2 H < L \leq H$	250 or more 300 or more

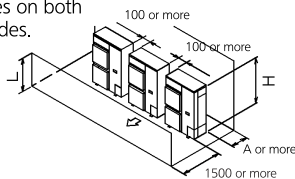

● **obstacle above**

- ① Stand-alone installation (Note 2)
 ● When there are obstacles on suction, discharge and top sides.

The relations between H, A and L are as follows.

	L	A
$L \leq H$	$L \leq 1/2 H$ $1/2 H < L \leq H$	100 or more 200 or more
$L > H$	Set the stand as : $L \leq H$ Refer to the column of $L \leq H$ for A	

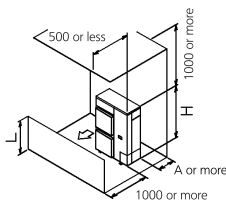

- ② Series installation (2 or more) (Note 1, 2)

- When there are obstacles on suction, discharge and top sides.

The relations between H, A and L are as follows.

	L	A
$L \leq H$	$L \leq 1/2 H$ $1/2 H < L \leq H$	250 or more 300 or more
$L > H$	Set the stand as : $L \leq H$ Refer to the column of $L \leq H$ for A	

Limit of series installation is 2 units.

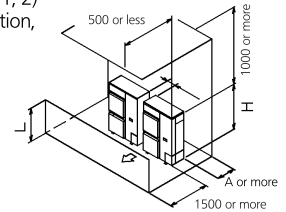

(D) Double-decker installation

- ① Obstacle on the discharge side. (1)

- Do not exceed two levels for stacked installation.
- Install a roof cover similar to A (field supply), as outdoor units with downward drainage are prone to dripping and freezing.
- Install the upper-level outdoor unit so that its bottom plate is a sufficient height above the roof cover. This is to prevent the buildup of ice on the underside of the bottom plate.

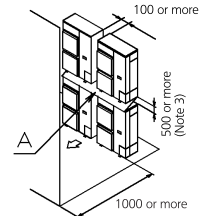

- ② Obstacle on the suction side. (1)

- Do not exceed two levels for stacked installation.
- Install a roof cover similar to A (field supply), as outdoor units with downward drainage are prone to dripping and freezing.
- Install the upper-level outdoor unit so that its bottom plate is a sufficient height above the roof cover. This is to prevent the buildup of ice on the underside of the bottom plate.

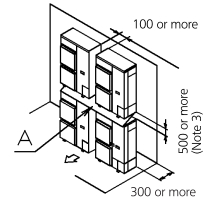

(E) Multiple rows of series installation (on the rooftop, etc.)

- ① One row of stand-alone installation

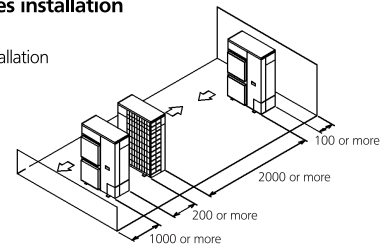

- ② Rows of series installation (2 or more)

The relations between H, A and L are as follows.

	L	A
$L \leq H$	$L \leq 1/2 H$ $1/2 H < L \leq H$	250 or more 300 or more
$L > H$	Can not be installed	

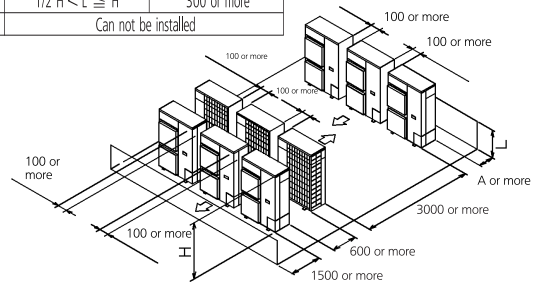

NOTES

- 1 In case of the sideways's piping, make a 100mm gap between the unit above.
- 2 Close the bottom of the installation frame to prevent the discharged air from being bypassed.
- 3 It is not necessary to install a roof cover if there is no danger of drainage dripping and freezing. In this case, the space between the upper and lower outdoor units should be at least 100mm. Close off the gap between the upper and lower units so there is no reintake of discharged air.

3D069554

13 Operation range

13 - 1 Operation Range

RZASG-MV1 RZASG-MY1

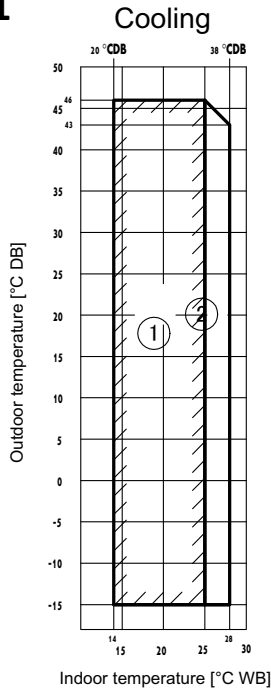

- ① Operation range
- ② Pull-down operation range
- ③ Warm-up operation range

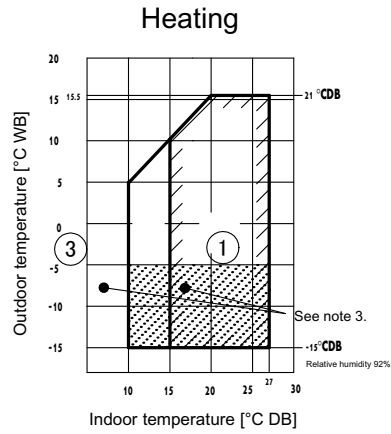

Notes

1. Depending on operation and installation conditions, the indoor unit can change over to freeze-up operation (indoor de-icing).
2. To reduce the freeze-up operation (indoor de-icing) frequency, it is recommended to install the outdoor unit in a location not exposed to wind.
3. In case of high humidity conditions (> 92%) at ambient temperatures of < -5°C, a RZAG model should be used instead to avoid freeze-up of the outdoor unit.

3D110021

14 Appropriate Indoors

14 - 1 Appropriate Indoors

14

RZAG-MV1/MY1
RZASG-MV1/MY1
AZAS-MV1/MY1

ENER Lot 21
 Recommended combinations

Sky Air		High Cassette				Thin cassette				2x2 cassette			Duct (medium ESP)			Concealed floor standing type			Ceiling-mounted - 4-way blow			Wall mounted type		Duct (high ESP)							
Model		FCAG100	FCAG125	FCAG140	FCAG35	FCAG50	FCAG60	FCAG71	FCAG100	FCAG125	FCAG140	FFA35	FFA60	FFA60	FBA35	FBA60	FBA60	FBA71	FBA100	FBA125	FBA140	FMA35	FMA60	FMA60	FUA71	FUA100	FUA125	FAA71	FAA100	FDA125	
RZAG125M7V1B	RZAG125M7Y1B		P		4										4																P
RZAG140M7V1B	RZAG140M7Y1B			P											4																P
RZASG125M7V1B	RZASG125M7Y1B				4										4												P				P
RZASG140M7V1B	RZASG140M7Y1B				4										4																P
AZAS125M7V1B	AZAS125M7Y1B									P											P										
AZAS140M7V1B	AZAS140M7Y1B										P																				

Sky Air		Floor standing type				Slim duct			Ceiling-suspended						Floor standing type	
Model		FVA71	FVA100	FVA125	FVA140	FDX35	FDX60	FDX60	FHA35	FHA50	FHA60	FHA71	FHA100	FHA125	FHA140	AVA125
RZAG125M7V1B	RZAG125M7Y1B			P												P
RZAG140M7V1B	RZAG140M7Y1B				P											P
RZASG125M7V1B	RZASG125M7Y1B			P												P
RZASG140M7V1B	RZASG140M7Y1B				P											P
AZAS125M7V1B	AZAS125M7Y1B															P
AZAS140M7V1B	AZAS140M7Y1B															P

P= Pair
 2= Twin
 3= Triple
 4= Double twin

3D112646A

14 Appropriate Indoors

14 - 1 Appropriate Indoors

RZAG-MV1/MY1

RZASG-MV1/MY1

AZAS-MV1/MY1

ENER Lot 21

Appropriate indoor units

Connectable to RZAG125M7V1B / RZAG125M7Y1B and covered by ENER Lot 21

FCAHG125	FCAG35	FFA35	FBA35	FNA35	FUA125	-	FDA125	FVA125	FDXM35	FHA35	-
-	FCAG50	FFA50	FBA50	FNA50	-	-	-	-	FDXM50	FHA50	-
-	FCAG60	FFA60	FBA60	FNA60	-	-	-	-	FDXM60	FHA60	-
-	FCAG125	-	FBA125	-	-	-	-	-	-	FHA125	-

Connectable to RZASG125M7V1B / RZASG125M7Y1B and covered by ENER Lot 21

-	FCAG35	FFA35	FBA35	FNA35	FUA125	-	FDA125	FVA125	FDXM35	FHA35	-
-	FCAG50	FFA50	FBA50	FNA50	-	-	-	-	FDXM50	FHA50	-
-	FCAG60	FFA60	FBA60	FNA60	-	-	-	-	FDXM60	FHA60	-
-	FCAG125	-	FBA125	-	-	-	-	-	-	FHA125	-

Connectable to AZAS125M7V1B / AZAS125M7Y1B and covered by ENER Lot 21

-	FCAG125	-	FBA125	-	-	-	-	-	-	-	AVA125
---	---------	---	--------	---	---	---	---	---	---	---	--------

Connectable to RZAG140M7V1B / RZAG140M7Y1B and covered by ENER Lot 21

FCAHG71	FCAG35	FFA35	FBA35	FNA35	FUA71	FAA71	-	FVA71	FDXM35	FHA35	-
FCAHG140	FCAG50	FFA50	FBA50	FNA50	-	-	-	FVA140	FDXM50	FHA50	-
-	FCAG71	-	FBA71	-	-	-	-	-	-	FHA71	-
-	FCAG140	-	FBA140	-	-	-	-	-	-	FHA140	-

Connectable to RZASG140M7V1B / RZASG140M7Y1B and covered by ENER Lot 21

-	FCAG35	FFA35	FBA35	FNA35	FUA71	FAA71	-	FVA71	FDXM35	FHA35	-
-	FCAG50	FFA50	FBA50	FNA50	-	-	-	FVA140	FDXM50	FHA50	-
-	FCAG71	-	FBA71	-	-	-	-	-	-	FHA71	-
-	FCAG140	-	FBA140	-	-	-	-	-	-	FHA140	-

Connectable to AZAS140M7V1B / AZAS140M7Y1B and covered by ENER Lot 21

-	FCAG140	-	FBA140	-	-	-	-	-	-	-	-
---	---------	---	--------	---	---	---	---	---	---	---	---

ENER Lot 10

Appropriate indoor units

Connectable to RZAG71M7V1B / RZAG71M7Y1B and covered by ENER Lot 10

FCAHG71	FCAG35	FFA35	FBA35	FNA35	FUA71	FAA71	-	FVA71	FDXM35	FHA35	-
-	FCAG71	-	FBA71	-	-	-	-	-	-	FHA71	-

Connectable to RZASG71M2V1B and covered by ENER Lot 10

-	FCAG35	FFA35	FBA35	FNA35	FUA71	FAA71	-	FVA71	FDXM35	FHA35	-
-	FCAG71	-	FBA71	-	-	-	-	-	-	FHA71	-

Connectable to AZAS71M2V1B and covered by ENER Lot 10

-	FCAG71	-	FBA71	-	-	FAA71	-	-	-	-	-
---	--------	---	-------	---	---	-------	---	---	---	---	---

Connectable to RZAG100M7V1B / RZAG100M7Y1B and covered by ENER Lot 10

FCAHG100	FCAG35	FFA35	FBA35	FNA35	FUA100	FAA100	-	FVA100	FDXM35	FHA35	-
-	FCAG50	FFA50	FBA50	FNA50	-	-	-	-	FDXM50	FHA50	-
-	FCAG100	-	FBA100	-	-	-	-	-	-	FHA100	-

Connectable to RZASG100M7V1B / RZASG100M7Y1B and covered by ENER Lot 10

-	FCAG35	FFA35	FBA35	FNA35	FUA100	FAA100	-	FVA100	FDXM35	FHA35	-
-	FCAG50	FFA50	FBA50	FNA50	-	-	-	-	FDXM50	FHA50	-
-	FCAG100	-	FBA100	-	-	-	-	-	-	FHA100	-

Connectable to AZAS100M7V1B / AZAS100M7Y1B and covered by ENER Lot 10

-	FCAG100	-	FBA100	-	-	FAA100	-	-	-	-	-
---	---------	---	--------	---	---	--------	---	---	---	---	---

3D112646A



Daikin Europe N.V. Naamloze Vennootschap - Zandvoordestraat 300, B-8400 Oostende - Belgium - www.daikin.eu - BE 0412 120 336 - RPR Oostende

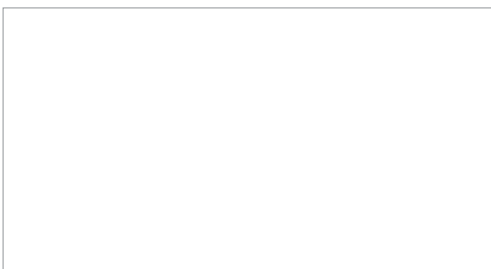

EEEN18 02/18



Daikin Europe N.V. participates in the Eurovent Certified Performance programme for Liquid Chilling Packages and Hydronic Heat Pumps, Fan Coil Units and Variable Refrigerant Flow systems. Check ongoing validity of certificate: www.eurovent-certification.com



The present leaflet is drawn up by way of information only and does not constitute an offer binding upon Daikin Europe N.V.. Daikin Europe N.V. has compiled the content of this leaflet to the best of its knowledge. No express or implied warranty is given for the completeness, accuracy, reliability or fitness for particular purpose of its content and the products and services presented therein. Specifications are subject to change without prior notice. Daikin Europe N.V. explicitly rejects any liability for any direct or indirect damage, in the broadest sense, arising from or related to the use and/or interpretation of this leaflet. All content is copyrighted by Daikin Europe N.V.