



ESIE10-04



Service Manual

RZQ71~140D7/9

Table of Contents

1. Introduction	vi
1.1 Safety Cautions	vi
Part 1 - General Information	1
1. Combination	2
1.1 Combination Overview	2
1.2 Combination Matrix	3
2. External Appearance.....	4
Part 2 - Specifications	5
1. Specifications	6
1.1 RZQ71D7, 100D7, 125D7 and 140D7 (Single phase)	6
Part 3 - Remote Controller	11
1. Wired Remote Controller.....	12
1.1 Features	12
1.2 Installation	14
2. Wireless Remote Controller	16
2.1 Features	16
3. Method of Operating Remote Controller	18
3.1 The INSPECTION / TEST Button.....	18
3.2 Maintenance Mode Setting.....	19
3.3 Operation of the Remote Controller's Inspection / Test Operation Button	21
3.4 Remote Controller Service Mode	22
3.5 Remote Controller Self-Diagnosis Function	23
Part 4 - Functional Description	25
1. General Functionality	27
1.1 Functions of Thermistors	27
1.2 Forced Operating Mode (Emergency Operation)	28
1.3 Outdoor Unit Identification Function	30
1.4 Simulated Operation Function	31
1.5 Restart Standby.....	32
1.6 Automatic Restart.....	33
1.7 Using Conditions for Remote Controller Thermostat.....	34
1.8 Forced Thermostat OFF	36
1.9 Test Run Control	37
1.10 4-way Valve Control	38
1.11 Pump Down Operation	39
1.12 Defrost Operation	40
1.13 Freeze Prevention Function	42
1.14 PMV Control	43
1.15 Crankcase Heater Control	44
2. Indoor Unit Functional Concept.....	45

2.1	Thermostat Control.....	45
2.2	Drain Pump Control.....	46
2.3	Condensation Avoidance Control.....	47
2.4	Draft Avoidance Control 1	48
2.5	Draft Avoidance Control 2	49
2.6	Fan and Flap Operation	50
2.7	Indoor Unit Fan Control	51
3.	Outdoor Unit Functional Concept.....	53
3.1	Function Outline in Cooling Mode	53
3.2	Function Outline in Heating Mode	54
4.	Frequency Regulating Functions	55
4.1	Starting Frequency Control	55
4.2	Starting Control	56
4.3	General Frequency Control	57
4.4	Low Pressure Protection Control.....	59
4.5	High Pressure Protection Control.....	61
4.6	Discharge Pipe Temperature Control.....	62
4.7	Suction Pipe Superheat Protection Control (Heating Mode)	63
4.8	Inverter Current Protection Control	64
4.9	Protection Control by Overall Current	65
4.10	Inverter Cooling Fin Temperature Control.....	66
4.11	Pressure Difference Control	67
4.12	Oil Recovery Operation	70
5.	Expansion Valve Regulating Functions.....	71
5.1	Expansion Valve Control at Startup	71
5.2	General Expansion Valve Control	72
5.3	Discharge Pipe Temperature Protection Control.....	73
6.	Outdoor Unit Fan Speed Control.....	74
6.1	Outdoor Unit Fan Speed Control.....	74

Part 5 - Test Operation 75

1.	Test Operation	76
1.1	Test Run Checks.....	76
1.2	Setting the Wireless Remote Controller	77
2.	Field Settings	81
2.1	How to Change the Field Settings with the Wired Remote Controller....	81
2.2	Field Setting from Remote Controller	83
2.3	How to Change the Field Settings with the Wireless Remote Controller	85
2.4	Overview of the Field Settings on the Indoor Units	86
2.5	Overview of the Factory Settings on the Indoor Units	87
2.6	MAIN/SUB Setting when Using Two Remote Controllers	88
2.7	Setting the Centralized Group No.	89
2.8	The Field Setting Levels.....	91
2.9	Overview of the Field Settings on the Outdoor Units	94
2.10	Overview of the Factory Settings on the Outdoor Units	94
2.11	Existence of DIP Switch and BS Button	95
2.12	Quiet (Low Noise) Operation.....	101
2.13	I-Demand Function.....	103
2.14	Setting for Low Humidity Application.....	105
2.15	Defrost Start Setting	110
3.	Test Run and Operation Data	111

3.1 General Operation Data 111
 3.2 Operation Range 114

Part 6 - Troubleshooting..... 115

1. How to Handle Request for Maintenance 117
 1.1 General Troubleshooting Flowchart 117
 2. Troubleshooting Based on Equipment Condition 118
 2.1 Overview of General Problems 118
 2.2 Equipment does not Operate 119
 2.3 Indoor Fan Operates, but Compressor does not..... 121
 2.4 Cooling/Heating Operation Starts but Stops Immediately 123
 2.5 After Unit Shuts Down, It cannot be Restarted for a While 125
 2.6 Equipment Operates but does not Provide Cooling 127
 2.7 Equipment Operates but does not Provide Heating 129
 2.8 Equipment Discharges White Mist 131
 2.9 Equipment Produces Loud Noise or Shakes..... 132
 2.10 Equipment Discharges Dust..... 134
 2.11 Remote Controller LCD Displays "88" 135
 2.12 Swing Flap does not Operate..... 136
 3. Procedure of Self-Diagnosis by Remote Controller 138
 3.1 The Inspection/Test Button 138
 3.2 Fault-diagnosis by Wired Remote Controller..... 139
 3.3 Fault-diagnosis by Wireless Remote Controller 140
 3.4 Remote Controller Display Malfunction Code and Contents 144
 4. Troubleshooting by LED Indications 146
 4.1 Troubleshooting by LED on the Indoor Units 146
 4.2 Troubleshooting by LED on Outdoor Unit PC Board..... 147
 5. Troubleshooting by Remote Controller Display / LED Display 148
 5.1 Indoor Malfunctions 148
 5.2 Outdoor Malfunctions 149
 5.3 System Malfunctions 150
 5.4 Overview of the Outdoor Safety Devices 151
 5.5 Overview of the Indoor Safety Devices 152
 5.6 "R1" Malfunctioning Indoor PC Board 153
 5.7 "R3" Malfunction of Drain Water Level System 154
 5.8 "R6" Indoor Unit Fan Motor Lock 156
 5.9 "R7" Swing Flap Motor Malfunction / Lock..... 158
 5.10 "RF" Malfunctioning Drain System 160
 5.11 "RJ" Malfunctioning Capacity Setting 162
 5.12 "C4", "C9" Thermistor Abnormality..... 164
 5.13 "CJ" Malfunctioning Remote Controller Air Thermistor 166
 5.14 "CL" Humidity Sensor System Malfunction 167
 5.15 "E1" Failure of Outdoor Unit PC Board..... 168
 5.16 "E3" Abnormal High Pressure (Detected by the HPS)..... 169
 5.17 "E4" Actuation of Low Pressure Sensor: Single phase C Series..... 171
 5.18 "E5" Compressor Motor Lock 173
 5.19 "E7" Malfunction of Outdoor Unit Fan Motor 175
 5.20 "E9" Malfunction of Electronic Expansion Valve..... 178
 5.21 "F3" Malfunctioning in Discharge Pipe Temperature 181
 5.22 "H3" Malfunctioning HPS System 183
 5.23 "H9", "J3", "J5", "J6", "J7", "J8" Malfunction of Thermistor System 184

5.24	“U1” Malfunction of Pressure Sensor	185
5.25	“L1” Faulty Outdoor PC Board	187
5.26	“L4” Radiation Fin Temperature Increased	189
5.27	“L5” DC Output Overcurrent (Instantaneous)	191
5.28	“L8” Electronic Thermal (Time Lag)	193
5.29	“L9” Stall Prevention (Time Lag)	195
5.30	“LC” Malfunction of Transmission System (between Control and Inverter PC Board)	197
5.31	“P1” Open Phase or Power Supply Voltage Imbalance	199
5.32	“P4” Malfunction of Radiator Fin Temperature Thermistor	200
5.33	“PU” Failure of Capacity Setting	201
5.34	“UD” Gas Shortage (Malfunction)	202
5.35	“U2” Abnormal Power Supply Voltage	204
5.36	“U4”, “UF” Malfunction of Transmission between Indoor and Outdoor Unit	206
5.37	“UF” Malfunction of Transmission between Indoor and Outdoor Unit / Piping and Wiring Mismatch / Gas Shortage	209
5.38	“U5” Malfunction of Transmission between Indoor Unit and Remote Controller	210
5.39	“UB” Malfunction of Transmission between MAIN Remote Controller and SUB Remote Controller	211
5.40	“UR” Malfunctioning Field Setting Switch	212
5.41	“UC” Centralized Address Setting Error	214

Part 7 - Appendix 231

1.	Dimensions	232
1.1	RZQ71D7V1B (Single phase)	232
1.2	RZQ100~140D7V1B (Single phase)	233
2.	Installation and Service Space (RZQ100~140)	234
2.1	Non Stacked	234
2.2	Stacked	235
2.3	Multiple Rows	235
3.	Piping Diagrams	236
3.1	Piping Symbol	236
3.2	Pair System	237
3.3	Triple System	239
3.4	Double Twin System	240
3.5	Pipe Connection Diameters	241
3.6	Re-using Existing Field Piping	242
4.	Wiring Diagrams	247
4.1	Outdoor Unit	247
5.	Switch Box Layout	248
5.1	RZQ71~140D7V1B (Single phase)	248
6.	PCB Layout	249
6.1	RZQ71~140D7V1B (Single phase)	249

Part 8 - Removal Procedure 251

1.	RZQ71	252
1.1	Removal of Outside Panels	252
1.2	Removal of Propeller Fan and Fan Motor	253

- 2. RZQ100~140254
 - 2.1 Removal of Outside Panels254
 - 2.2 Removal of Propeller Fan and Fan Motor255
 - 2.3 Removal of Switch Box256
 - 2.4 Removal of PC Board.....257
 - 2.5 Removal of Pressure Sensor, Electronic Expansion Valve,
and Others.....258
 - 2.6 Removal of Thermistor259
 - 2.7 Removal of Four Way Valve.....260
 - 2.8 Removal of Compressor.....261





Index i

Drawings & Flow Charts v







1. Introduction







1.1 Safety Cautions

Cautions and Warnings

- Be sure to read the following safety cautions before conducting repair work.
- The caution items are classified into “ **Warning**” and “ **Caution**”. The “ **Warning**” items are especially important since they can lead to death or serious injury if they are not followed closely. The “ **Caution**” items can also lead to serious accidents under some conditions if they are not followed. Therefore, be sure to observe all the safety caution items described below.
- About the pictograms
 - △ This symbol indicates an item for which caution must be exercised.
The pictogram shows the item to which attention must be paid.
 - This symbol indicates a prohibited action.
The prohibited item or action is shown inside or near the symbol.
 - This symbol indicates an action that must be taken, or an instruction.
The instruction is shown inside or near the symbol.
- After the repair work is complete, be sure to conduct a test operation to ensure that the equipment operates normally, and explain the cautions for operating the product to the customer



1.1.1 Caution in Repair



 Warning	
Be sure to disconnect the power cable plug from the plug socket before disassembling the equipment for a repair. Working on the equipment that is connected to a power supply can cause an electrical shock. If it is necessary to supply power to the equipment to conduct the repair or inspecting the circuits, do not touch any electrically charged sections of the equipment.	
If the refrigerant gas discharges during the repair work, do not touch the discharging refrigerant gas. The refrigerant gas can cause frostbite.	
When disconnecting the suction or discharge pipe of the compressor at the welded section, release the refrigerant gas completely at a well-ventilated place first. If there is a gas remaining inside the compressor, the refrigerant gas or refrigerating machine oil discharges when the pipe is disconnected, and it can cause injury.	
If the refrigerant gas leaks during the repair work, ventilate the area. The refrigerant gas can generate toxic gases when it contacts flames.	
The step-up capacitor supplies high-voltage electricity to the electrical components of the outdoor unit. Be sure to discharge the capacitor completely before conducting repair work. A charged capacitor can cause an electrical shock.	
Do not start or stop the air conditioner operation by plugging or unplugging the power cable plug. Plugging or unplugging the power cable plug to operate the equipment can cause an electrical shock or fire.	

 Caution	
Do not repair the electrical components with wet hands. Working on the equipment with wet hands can cause an electrical shock.	
Do not clean the air conditioner by splashing water. Washing the unit with water can cause an electrical shock.	
Be sure to provide the grounding when repairing the equipment in a humid or wet place, to avoid electrical shocks.	
Be sure to turn off the power switch and unplug the power cable when cleaning the equipment. The internal fan rotates at a high speed, and cause injury.	
Do not tilt the unit when removing it. The water inside the unit can spill and wet the furniture and floor.	
Be sure to check that the refrigerating cycle section has cooled down sufficiently before conducting repair work. Working on the unit when the refrigerating cycle section is hot can cause burns.	
Use the welder in a well-ventilated place. Using the welder in an enclosed room can cause oxygen deficiency.	





1.1.2 Cautions Regarding Products after Repair



 Warning	
Be sure to use parts listed in the service parts list of the applicable model and appropriate tools to conduct repair work. Never attempt to modify the equipment. The use of inappropriate parts or tools can cause an electrical shock, excessive heat generation or fire.	
When relocating the equipment, make sure that the new installation site has sufficient strength to withstand the weight of the equipment. If the installation site does not have sufficient strength and if the installation work is not conducted securely, the equipment can fall and cause injury.	
Be sure to install the product correctly by using the provided standard installation frame. Incorrect use of the installation frame and improper installation can cause the equipment to fall, resulting in injury.	For integral units only
Be sure to install the product securely in the installation frame mounted on a window frame. If the unit is not securely mounted, it can fall and cause injury.	For integral units only
Be sure to use an exclusive power circuit for the equipment, and follow the technical standards related to the electrical equipment, the internal wiring regulations and the instruction manual for installation when conducting electrical work. Insufficient power circuit capacity and improper electrical work can cause an electrical shock or fire.	

 Warning	
Be sure to use the specified cable to connect between the indoor and outdoor units. Make the connections securely and route the cable properly so that there is no force pulling the cable at the connection terminals. Improper connections can cause excessive heat generation or fire.	
When connecting the cable between the indoor and outdoor units, make sure that the terminal cover does not lift off or dismount because of the cable. If the cover is not mounted properly, the terminal connection section can cause an electrical shock, excessive heat generation or fire.	
Do not damage or modify the power cable. Damaged or modified power cable can cause an electrical shock or fire. Placing heavy items on the power cable, and heating or pulling the power cable can damage the cable.	
Do not mix air or gas other than the specified refrigerant (R-410A) in the refrigerant system. If air enters the refrigerating system, an excessively high pressure results, causing equipment damage and injury.	
If the refrigerant gas leaks, be sure to locate the leak and repair it before charging the refrigerant. After charging refrigerant, make sure that there is no refrigerant leak. If the leak cannot be located and the repair work must be stopped, be sure to perform pump-down and close the service valve, to prevent the refrigerant gas from leaking into the room. The refrigerant gas itself is harmless, but it can generate toxic gases when it contacts flames, such as fan and other heaters, stoves and ranges.	
When replacing the coin battery in the remote controller, be sure to disposed of the old battery to prevent children from swallowing it. If a child swallows the coin battery, see a doctor immediately.	

 Caution	
Installation of a leakage breaker is necessary in some cases depending on the conditions of the installation site, to prevent electrical shocks.	
Do not install the equipment in a place where there is a possibility of combustible gas leaks. If a combustible gas leaks and remains around the unit, it can cause a fire.	
Be sure to install the packing and seal on the installation frame properly. If the packing and seal are not installed properly, water can enter the room and wet the furniture and floor.	For integral units only

1.1.3 Inspection after Repair





 Warning	
Check to make sure that the power cable plug is not dirty or loose, then insert the plug into a power outlet all the way. If the plug has dust or loose connection, it can cause an electrical shock or fire.	
If the power cable and lead wires have scratches or deteriorated, be sure to replace them. Damaged cable and wires can cause an electrical shock, excessive heat generation or fire.	
Do not use a joined power cable or extension cable, or share the same power outlet with other electrical appliances, since it can cause an electrical shock, excessive heat generation or fire.	

 Caution	
Check to see if the parts and wires are mounted and connected properly, and if the connections at the soldered or crimped terminals are secure. Improper installation and connections can cause excessive heat generation, fire or an electrical shock.	
If the installation platform or frame has corroded, replace it. Corroded installation platform or frame can cause the unit to fall, resulting in injury.	
Check the grounding, and repair it if the equipment is not properly grounded. Improper grounding can cause an electrical shock.	
Be sure to measure the insulation resistance after the repair, and make sure that the resistance is 1 Mohm or higher. Faulty insulation can cause an electrical shock.	
Be sure to check the drainage of the indoor unit after the repair. Faulty drainage can cause the water to enter the room and wet the furniture and floor.	

1.1.4 Using Icons

Icons are used to attract the attention of the reader to specific information. The meaning of each icon is described in the table below:

1.1.5 Using Icons List

Icon	Type of Information	Description
 Note:	Note	A “note” provides information that is not indispensable, but may nevertheless be valuable to the reader, such as tips and tricks.
 Caution	Caution	A “caution” is used when there is danger that the reader, through incorrect manipulation, may damage equipment, lose data, get an unexpected result or has to restart (part of) a procedure.
 Warning	Warning	A “warning” is used when there is danger of personal injury.
	Reference	A “reference” guides the reader to other places in this binder or in this manual, where he/she will find additional information on a specific topic.

Part 1

General Information

1. Combination	2
1.1 Combination Overview	2
1.2 Combination Matrix	3
2. External Appearance.....	4

1. Combination

1.1 Combination Overview

The table below contains the possible combinations between indoor units and outdoor units of the Sky Air RZQ-series.

MODEL NAME	FCQ35	FCQ50	FCQ60	FCQ71	FCQ100	FCQ125	FCQ140	FCQH71	FCQH100	FCQH125	FCQH140	FFQ35	FFQ50	FFQ60	FBQ35	FBQ50	FBQ60	FBQ71	FBQ100	FBQ125
RZQ71	2			P				P				2			2			P		
RZQ100	3	2			P				P			3	2		3	2			P	
RZQ125	4	3	2			P				P		4	3	2	4	3	2			P
RZQ140	4	3		2			P	2			P	4	3		4	3		2		

MODEL NAME	FDQ125	FHQ35	FHQ50	FHQ60	FHQ71	FHQ100	FHQ125	FUQ71	FUQ100	FUQ125	FAQ71	FAQ100
RZQ71		2			P			P			P	
RZQ100		3	2			P			P			P
RZQ125	P	4	3	2			P			P		
RZQ140		4	3		2			2			2	

- Notes:**
- Explanation of connection (P~4)
 - P : Pair
 - 2 : Twin
 - 3 : Triple
 - 4 : Double twin
 - Always consult the combination database on the extranet for the latest allowed combinations.

1.2 Combination Matrix

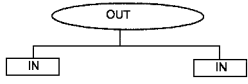
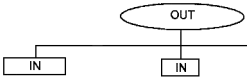
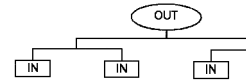
Possible indoor combination			
Simultaneous operation			
Outdoor models	Twin	Triple	Double Twin
			
RZQ71D	35-35 (KHRQ22M20TA7)	—	—
RZQ100D	50-50 (KHRQ22M20TA7)	35-35-35 (KHRQ127H7)	—
RZQ125D	60-60 (KHRQ22M20TA7)	50-50-50 (KHRQ127H7)	35-35-35-35 (3×KHRQ22M20TA7)
RZQ140D	71-71 (KHRQ22M20TA7)	50-50-50 (KHRQ127H7)	35-35-35-35 (3×KHRQ22M20TA7)

- Notes:**
- Possible indoor types:
 FCQH71
 FCQ35-71
 FFQ35-60
 FHQ35-71
 FBQ35-71
 FUQ71
 FAQ71
 - Individual indoor capacities are not given because the combinations are for simultaneous operation (=indoor units installed in same room).
 - When different indoor models are used in combination, designate the remote controller that is equipped with the most functions as the main unit. In note 1 are the indoor units mentioned in order of the possible function (most functions are on FCQ , less functions are on FAQ).
 - Between brackets are the required Refnet kits mentioned, that are necessary to install the combination.

2. External Appearance

Indoor Units



FCQ(H)



FFQ



FBQ



FDQ



FHQ



FUQ



FAQ

Remote Controller

Wireless Type



BRC7 Type

Wired Type



BRC1D52 Type

Outdoor Units



RZQ71D7



RZQ100-125-140D7

Part 2

Specifications

1. Specifications	6
1.1 RZQ71D7, 100D7, 125D7 and 140D7 (Single phase)	6

1. Specifications

1.1 RZQ71D7, 100D7, 125D7 and 140D7 (Single phase)

1.1.1 Technical Specifications

The table below contains the technical specifications.

Specification		RZQ71D7V1B	RZQ100D7V1B	RZQ125D7V1B	RZQ140D7V1B
Casing	Colour	Ivory white			
	Material	Painted galvanized steel			
Dimensions	Unit height	770 mm	1,345 mm		
	Unit width	900 mm			
	Unit depth	320 mm			
	Packing height	900 mm	1,524 mm		
	Packing width	980 mm			
	Packing depth	420 mm			
	Weight	Unit	67 kg	109 kg	
Packed unit		71 kg	126 kg		
Heat exchanger	Length	857 mm			
	Nr. of rows	2			
	Fin pitch	1.40 mm			
	Nr. of passes	8	10		
	Face area	0.641 m ²	1.131 m ²		
	Nr. of stages	34	60		
	Tube type	Hi-XSS(8)			
	Fin type	WF fin			
	Fin treatment	Anti-corrosion treatment (PE)			
Fan	Type	Propeller			
	Discharge direction	Horizontal			
	Quantity	1	2		
	Air flow rate (nominal at 230 V) cooling	52 m ³ /min	96 m ³ /min	100 m ³ /min	97 m ³ /min
	Air flow rate (nominal at 230 V) heating	48 m ³ /min	90 m ³ /min		
	Motor quantity	1	2		
	Motor model	KFD-325-70-8A	Brushless DC motor		
Motor	Speed (nominal) nr. of steps	8			
	Speed (nominal) cooling (standard)	800 rpm		850 rpm	830 rpm
	Speed (nominal) heating (standard)	745 rpm	760 rpm		
Fan	Motor output	70 W			
	Motor drive	Direct drive			
Compressor	Quantity	1			
	Motor model	2YC63DXD	JT100G-VD		
	Motor type	Hermetically sealed swing compressor	Hermetically sealed scroll compressor		
	Motor output	1,700 W	2,200 W		
	Motor crankcase heater	33 W			
	Motor starting method	Inverter driven			
Operation range	Cooling min.	-15.0°C DB			
	Cooling max.	50.0°C DB			
	Heating min.	-20.0°C WB			
	Heating max.	15.5°C WB			
Sound level (nominal)	Cooling sound power	64 dBA	65 dBA	67 dBA	68 dBA
	Cooling sound pressure (standard)	48 dBA	50 dBA	51 dBA	
	Heating sound pressure (standard)	50 dBA	52 dBA	53 dBA	
Sound level (night quiet)	Sound pressure	43 dBA	45 dBA		46 dBA
Refrigerant	Type	R-410A			
	Charge	2.75 kg	3.95 kg		
	Control	Expansion valve (electronic type)			
	Nr. of circuits	1			
Refrigerant oil	Type	FVC50K	Daphne FVC68D		
	Charged volume	0.75 l	1.0 l		

Specification		RZQ71D7V1B	RZQ100D7V1B	RZQ125D7V1B	RZQ140D7V1B
Piping connections	Liquid quantity	1			
	Liquid type	Flare connection			
	Liquid diameter (OD)	9.52 mm			
	Gas quantity	1			
	Gas type	Flare connection			
	Gas diameter (OD)	15.9 mm			
	Drain quantity	3			
	Drain type	Hole			
	Drain diameter (OD)	26 mm			
	Piping length min.	5 m			
	Piping length max.	50 m	75 m		
	Piping length equivalent	70 m	95 m		
	Piping length chargeless	30 m			
	Additional refrigerant charge	See installation manual 4PW48323-1			
	Installation height difference max.	30.0 m			
	Max. intern unit level difference	0.5 m			
Heat insulation	Both liquid and gas pipes				
Defrost method	Pressure equalising				
Defrost control	Temperature				
Capacity control method	Inverter controlled				
Safety devices	High pressure switch				
	Fan motor thermal protector				
	Fuse				
Standard accessories	Item	Tie-wraps			
	Quantity	2			
	Item	Installation manual			
	Quantity	1			

Notes:

- Nominal cooling capacities are based on:
 Indoor temperature: 27°C DB/19°C WB
 Outdoor temperature: 35°C DB
 Equivalent refrigerant piping: 5 m
 Level difference: 0 m
- Nominal heating capacities are based on:
 Indoor temperature: 20°C DB
 Outdoor temperature: 7°C DB/6°C WB
 Equivalent refrigerant piping length: 5 m
 Level difference: 0 m

1.1.2 Electrical Specifications

The table below contains the electrical specifications.

Specification	RZQ71D7V1B	RZQ100D7V1B	RZQ125D7V1B	RZQ140D7V1B
Power supply	Name			
	Phase			
	Frequency			
	Voltage			
	Voltage range min.			
	Voltage range max.			
Current	Recommended fuses		20 A	32 A
Wire connections	For power supply - remark			
	For connection with indoor - remark			
Power supply intake				
Outdoor unit only				
Notes	See separate drawing for electrical data.			
	(1) European/international technical standard setting the limits for harmonic currents produced by equipment connected to public low-voltage system with input current > 16A smaller than or equal to 75A per phase.			
	(2) Short-circuit power			
			Power supply to the FDQ indoor unit is separate	

1.1.3 Electrical Data

Unit combination		Power supply				Compressor			OFM		IFM			
Indoor unit	Outdoor unit	Hz-volts	Voltage range	MCA	TOCA	MFA	MSC	RLA	kW	FLA	kW	FLA		
FCQH71D7VEB	RZQ71D7V1B	50-220 50-230 50-240	Max. 50Hz 264V Min. 50Hz 198V	17.0	-	20	-	16.2	0.07	0.3	0.056	0.5		
FCQ71C7VEB	RZQ71D7V1B			17.0	-	20	-	16.2	0.07	0.3	0.056	0.5		
FCQ35C7VEB×2	RZQ71D7V1B			17.1	-	20	-	16.2	0.07	0.3	0.056×2	0.3×2		
FFQ35BV1B×2	RZQ71D7V1B			17.7	-	20	-	16.2	0.07	0.3	0.055×2	0.6×2		
FBQ71C7VEB	RZQ71D7V1B			17.6	-	20	-	16.2	0.07	0.3	0.350	1.1		
FBQ35C7VEB×2	RZQ71D7V1B			18.9	-	20	-	16.2	0.07	0.3	0.140×2	1.2×2		
FHQ71BUBV1B	RZQ71D7V1B			17.1	-	20	-	16.2	0.07	0.3	0.062	0.6		
FHQ35BUBV1B×2	RZQ71D7V1B			17.7	-	20	-	16.2	0.07	0.3	0.062×2	0.6×2		
FAQ71BUBV1B	RZQ71D7V1B			16.8	-	20	-	16.2	0.07	0.3	0.043	0.3		
FUQ71BUBV1B	RZQ71D7V1B			17.2	-	20	-	16.2	0.07	0.3	0.045	0.7		
FCQH100D7VEB	RZQ100D7V1B	50-220 50-230 50-240	Max. 50Hz 264V Min. 50Hz 198V	25.6	-	32	-	23.4	0.07+0.07	0.3+0.3	0.120	1.6		
FCQ100C7VEB	RZQ100D7V1B			24.7	-	32	-	23.4	0.07+0.07	0.3+0.3	0.120	0.7		
FCQ50C7VEB×2	RZQ100D7V1B			24.6	-	32	-	23.4	0.07+0.07	0.3+0.3	0.056×2	0.3×2		
FCQ35C7VEB×3	RZQ100D7V1B			24.9	-	32	-	23.4	0.07+0.07	0.3+0.3	0.056×3	0.3×3		
FFQ50BV1B×2	RZQ100D7V1B			25.4	-	32	-	23.4	0.07+0.07	0.3+0.3	0.055×2	0.7×2		
FFQ35BV1B×3	RZQ100D7V1B			25.8	-	32	-	23.4	0.07+0.07	0.3+0.3	0.055×3	0.6×3		
FBQ100C7VEB	RZQ100D7V1B			25.6	-	32	-	23.4	0.07+0.07	0.3+0.3	0.350	1.6		
FBQ50C7VEB×2	RZQ100D7V1B			26.4	-	32	-	23.4	0.07+0.07	0.3+0.3	0.140×2	1.2×2		
FBQ35C7VEB×3	RZQ100D7V1B			27.6	-	32	-	23.4	0.07+0.07	0.3+0.3	0.140×3	1.2×3		
FHQ100BUBV1B	RZQ100D7V1B			24.7	-	32	-	23.4	0.07+0.07	0.3+0.3	0.130	0.7		
FHQ50BUBV1B×2	RZQ100D7V1B			25.2	-	32	-	23.4	0.07+0.07	0.3+0.3	0.062×2	0.6×2		
FHQ35BUBV1B×3	RZQ100D7V1B			25.8	-	32	-	23.4	0.07+0.07	0.3+0.3	0.062×3	0.6×3		
FAQ100BUBV1B	RZQ100D7V1B			24.4	-	32	-	23.4	0.07+0.07	0.3+0.3	0.049	0.4		
FUQ100BUBV1B	RZQ100D7V1B			25.1	-	32	-	23.4	0.07+0.07	0.3+0.3	0.090	1.1		
FCQH125D7VEB	RZQ125D7V1B			50-220 50-230 50-240	Max. 50Hz 264V Min. 50Hz 198V	25.6	-	32	-	23.4	0.07+0.07	0.3+0.3	0.120	1.6
FCQ125C7VEB	RZQ125D7V1B					25.0	-	32	-	23.4	0.07+0.07	0.3+0.3	0.120	1.0
FCQ60C7VEB×2	RZQ125D7V1B					24.8	-	32	-	23.4	0.07+0.07	0.3+0.3	0.056×2	0.4×2
FCQ50C7VEB×3	RZQ125D7V1B					24.9	-	32	-	23.4	0.07+0.07	0.3+0.3	0.056×3	0.3×3
FCQ35C7VEB×4	RZQ125D7V1B	25.2	-			32	-	23.4	0.07+0.07	0.3+0.3	0.056×4	0.3×4		
FFQ60BV1B×2	RZQ125D7V1B	25.4	-			32	-	23.4	0.07+0.07	0.3+0.3	0.055×2	0.7×2		
FFQ50BV1B×3	RZQ125D7V1B	26.1	-			32	-	23.4	0.07+0.07	0.3+0.3	0.055×3	0.7×3		
FFQ35BV1B×4	RZQ125D7V1B	26.4	-			32	-	23.4	0.07+0.07	0.3+0.3	0.055×4	0.6×4		
FBQ125C7VEB	RZQ125D7V1B	26.1	-			32	-	23.4	0.07+0.07	0.3+0.3	0.350	2.1		
FBQ60C7VEB×2	RZQ125D7V1B	26.2	-			32	-	23.4	0.07+0.07	0.3+0.3	0.350×2	1.1×2		
FBQ50C7VEB×3	RZQ125D7V1B	27.6	-			32	-	23.4	0.07+0.07	0.3+0.3	0.140×3	1.2×3		
FBQ35C7VEB×4	RZQ125D7V1B	28.8	-			32	-	23.4	0.07+0.07	0.3+0.3	0.140×4	1.2×4		
FHQ125BUBV1B	RZQ125D7V1B	24.7	-			32	-	23.4	0.07+0.07	0.3+0.3	0.130	0.7		
FHQ60BUBV1B×2	RZQ125D7V1B	25.2	-			32	-	23.4	0.07+0.07	0.3+0.3	0.062×2	0.6×2		
FHQ50BUBV1B×3	RZQ125D7V1B	25.8	-			32	-	23.4	0.07+0.07	0.3+0.3	0.062×3	0.6×3		
FHQ35BUBV1B×4	RZQ125D7V1B	26.4	-			32	-	23.4	0.07+0.07	0.3+0.3	0.062×4	0.6×4		
FUQ125BUBV1B	RZQ125D7V1B	25.1	-			32	-	23.4	0.07+0.07	0.3+0.3	0.090	1.1		
FDQ125B7V3B	RZQ125D7V1B	24.0	-			32	-	23.4	0.07+0.07	0.3+0.3	0.500	4.2		

Unit combination		Power supply					Compressor		OFM		IFM	
Indoor unit	Outdoor unit	Hz-volts	Voltage range	MCA	TOCA	MFA	MSC	RLA	kW	FLA	kW	FLA
FCQH140D7VEB	RZQ140D7V1B	50-220 50-230 50-240	Max. 50Hz 264V Min. 50Hz 198V	25.6	-	32	-	23.4	0.07+0.07	0.3+0.3	0.120	1.6
FCQH71D7VEB×2	RZQ140D7V1B			25.0	-	32	-	23.4	0.07+0.07	0.3+0.3	0.056×2	0.5×2
FCQ140C7VEB	RZQ140D7V1B			25.0	-	32	-	23.4	0.07+0.07	0.3+0.3	0.120	1.0
FCQ71C7VEB×2	RZQ140D7V1B			25.0	-	32	-	23.4	0.07+0.07	0.3+0.3	0.056×2	0.5×2
FCQ50C7VEB×3	RZQ140D7V1B			24.9	-	32	-	23.4	0.07+0.07	0.3+0.3	0.056×3	0.3×3
FCQ35C7VEB×4	RZQ140D7V1B			25.2	-	32	-	23.4	0.07+0.07	0.3+0.3	0.056×4	0.3×4
FFQ50BV1B×3	RZQ140D7V1B			26.1	-	32	-	23.4	0.07+0.07	0.3+0.3	0.055×3	0.7×3
FFQ35BV1B×4	RZQ140D7V1B			26.4	-	32	-	23.4	0.07+0.07	0.3+0.3	0.055×4	0.6×4
FBQ140C7VEB	RZQ140D7V1B			26.1	-	32	-	23.4	0.07+0.07	0.3+0.3	0.350	2.1
FBQ71C7VEB×2	RZQ140D7V1B			26.2	-	32	-	23.4	0.07+0.07	0.3+0.3	0.350×2	1.1×2
FBQ50C7VEB×3	RZQ140D7V1B			27.6	-	32	-	23.4	0.07+0.07	0.3+0.3	0.140×3	1.2×3
FBQ35C7VEB×4	RZQ140D7V1B			28.8	-	32	-	23.4	0.07+0.07	0.3+0.3	0.140×4	1.2×4
FHQ71BUV1B×2	RZQ140D7V1B			25.2	-	32	-	23.4	0.07+0.07	0.3+0.3	0.062×2	0.6×2
FHQ50BUV1B×3	RZQ140D7V1B			25.8	-	32	-	23.4	0.07+0.07	0.3+0.3	0.062×3	0.6×3
FHQ35BUV1B×4	RZQ140D7V1B			26.4	-	32	-	23.4	0.07+0.07	0.3+0.3	0.062×4	0.6×4
FAQ71BUV1B×2	RZQ140D7V1B			24.6	-	32	-	23.4	0.07+0.07	0.3+0.3	0.043×2	0.3×2
FUQ71BUV1B×2	RZQ140D7V1B			25.4	-	32	-	23.4	0.07+0.07	0.3+0.3	0.045×2	0.7×2

Symbols:

- MCA: Min. Circuit Amps (A)
- TOCA: Total Over-current Amps (A)
- MFA: Max. Fuse Amps (A) (see note 7)
- MSC: MSC means the max. current during the starting of compressor (A)
- RLA: Rated Load Amps (A)
- OFM: Outdoor Fan Motor (A)
- IFM: Indoor Fan Motor
- FLA: Full Load Amps
- kW: Fan Motor Rated Output (kW)

Notes:

1. RLA is based on the following conditions:
 Power supply: 50Hz - 230V
 Cooling
 Indoor temperature: 27°C DB/19.0°C WB
 Outdoor temperature: 35.0°C DB
 Heating
 Indoor temperature: 20.0°C DB
 Outdoor temperature: 7.0°C DB/6.0°C WB
2. TOCA means the total value of each OC set.
3. Voltage range
 Units are suitable for use on electrical systems where voltage supplied to unit terminals is not below or above listed operation range limits.
4. Maximum allowable voltage unbalance between phases is 2%.
5. MCA represents maximum input current. MFA represents capacity which may accept MCA (next lower standard fuse rating, minimum 15A).
6. Select wire size based on the larger value of MCA or TOCA.
7. MFA is used to select the circuit breaker and the ground fault circuit interruptor (earth leakage circuit breaker).

Part 3

Remote Controller

1. Wired Remote Controller	12
1.1 Features	12
1.2 Installation	14
2. Wireless Remote Controller	16
2.1 Features	16
3. Method of Operating Remote Controller	18
3.1 The INSPECTION / TEST Button.....	18
3.2 Maintenance Mode Setting.....	19
3.3 Operation of the Remote Controller's Inspection / Test Operation Button	21
3.4 Remote Controller Service Mode	22
3.5 Remote Controller Self-Diagnosis Function	23

1. Wired Remote Controller

1.1 Features

BRC1D52 Type

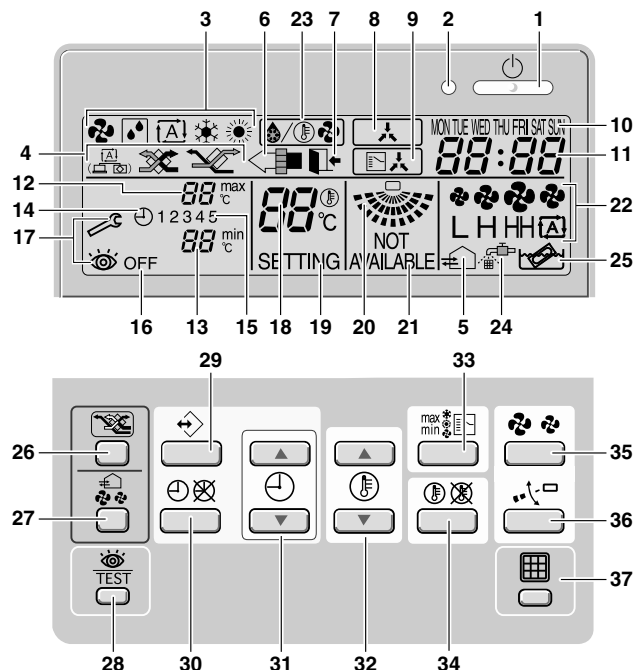

1. ON/OFF BUTTON

Press the ON/OFF button to start or stop the system.
2. OPERATION LAMP

The operation lamp lights up during operation or blinks if a malfunction occurs.
3. OPERATION MODE ICON

These icons indicate the current operation mode (FAN, DRY, AUTOMATIC, COOLING, HEATING).
4. VENTILATION MODE ICON

These icons indicate the current ventilation mode (HRV only) (AUTOMATIC, HEAT EXCHANGE, BYPASS).
5. VENTILATION ICON

The ventilation icon appears when the ventilation is adjusted with the ventilation amount button (HRV only). Simultaneously, the ventilation amount is indicated by the fan speed icon.
6. AIR CLEANING ICON

This icon indicates that the air cleaning unit (option) is operational.
7. LEAVE HOME ICON

The leave home icon shows the status of the leave home function.



















ON	Leave home is enabled
FLASHING	Leave home is active
OFF	Leave home is disabled
8. EXTERNAL CONTROL ICON

This icon indicates that another controller with higher priority is controlling or disabling your installation.
9. CHANGE-OVER UNDER CENTRALISED CONTROL ICON

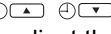
This icon indicates that the change-over of the installation is under centralised control assigned to another indoor unit or optional cool/heat selector connected to the outdoor unit (= master remote controller).
10. DAY OF THE WEEK INDICATOR MON TUE WED THU FRI SAT SUN

The day of the week indicator shows the current week day (or the set day when reading or programming the schedule timer).
11. CLOCK DISPLAY

The clock display indicates the current time (or the action time when reading or programming the schedule timer).

12. MAXIMUM SET TEMPERATURE $88^{\text{max}}_{\text{C}}$
The maximum set temperature indicates the maximum set temperature when in limit operation.
13. MINIMUM SET TEMPERATURE $88^{\text{min}}_{\text{C}}$
The minimum set temperature indicates the minimum set temperature when in limit operation.
14. SCHEDULE TIMER ICON 
This icon indicates that the schedule timer is enabled.
15. ACTION ICONS 1 2 3 4 5
These icons indicate the actions for each day of the schedule timer.
16. OFF ICON OFF
This icon indicates that the OFF action is selected when programming the schedule timer.
17. INSPECTION REQUIRED  and 
These icons indicate that inspection is required. Consult your installer.
18. SET TEMPERATURE DISPLAY 88°C
This indicates the current set temperature of the installation (not shown in LIMIT operation or in FAN or DRY mode).
19. SETTING SETTING
Not used, for service purposes only.
20. AIR FLOW DIRECTION ICON 
This icon indicates the air flow direction (only for installations with motorised air flow flaps).
21. NOT AVAILABLE $\frac{\text{NOT}}{\text{AVAILABLE}}$
 $\frac{\text{NOT}}{\text{AVAILABLE}}$ is displayed whenever a non-installed option is addressed or a function is not available.
22. FAN SPEED ICON $\bullet\bullet\bullet\bullet$
This icon indicates the set fan speed.
23. DEFROST/HOTSTART MODE ICON 
This icon indicates that the defrost/hotstart mode is active.
24. AIR FILTER CLEANING TIME ICON 
This icon indicates the air filter must be cleaned. Refer to the manual of the indoor unit.
25. ELEMENT CLEANING TIME ICON 
This icon indicates the element must be cleaned (HRV only).
26. VENTILATION MODE BUTTON 
The ventilation mode button operates the HRV; refer to the manual for more details.
27. VENTILATION AMOUNT BUTTON 
This button sets the ventilation amount; refer to the manual for more details.
28. INSPECTION/TEST OPERATION BUTTON 
Not used, for service purposes only.
29. PROGRAMMING BUTTON 
This button is a multi-purpose button.
Depending on the previous manipulations of the user, the programming button can have various functions.
30. SCHEDULE TIMER BUTTON 
This button enables or disables the schedule timer.
31. TIME ADJUST BUTTON 
These buttons are used to adjust the clock or, when in programming mode, to adjust the programmed action time. Both buttons have an auto-repeat function.
32. TEMPERATURE ADJUST BUTTONS 
These buttons are used to adjust the current setpoint or, when in programming mode, to adjust the programmed setpoint temperature (step = 1°C). Both buttons are also used to adjust the day of the week.
33. OPERATION CHANGE/MIN-MAX BUTTON $\frac{\text{max}}{\text{min}}$
This button is a multi-purpose button. Depending on the previous manipulations of the user, it can have following functions:
1 select the operation mode of the installation (FAN, DRY, AUTOMATIC, COOLING, HEATING)
2 toggle between minimum temperature and maximum temperature when in limit operation
34. SETPOINT/LIMIT BUTTON 
This button toggles between setpoint, limit operation or OFF (programming mode only).
35. FAN SPEED BUTTON 
This button toggles between L (Low), H (High), HH (very High),  (Automatic).
36. AIR FLOW DIRECTION ADJUST BUTTON 
This button enables to adjust the air flow direction.
37. AIR FILTER CLEANING TIME ICON RESET BUTTON 
This button is used to reset the air filter cleaning time icon.

1.2 Installation

1. Remove the upper part of remote controller.

Insert minus screwdriver into the slots in the lower part of remote controller (2 places), and remove the upper part of remote controller.

The P C board is mounted in the upper part of remote controller. Be careful not to damage the board with the minus screwdriver.

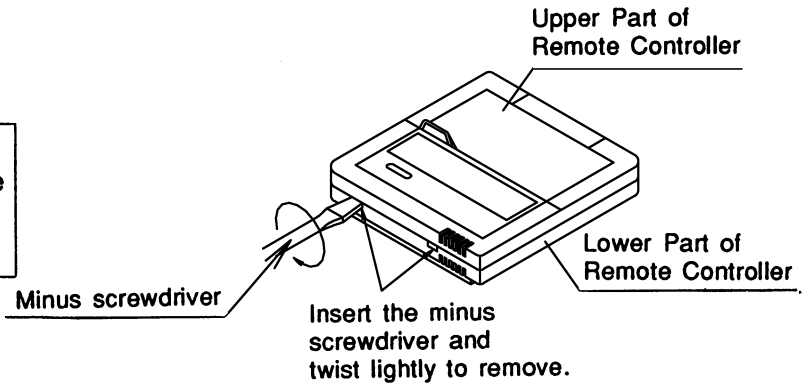

2. Fasten the remote controller.

- ① For exposed mounting, fasten with the included wood screws (2).
- ② For flush-mounting, fasten with the included machine screws (2).

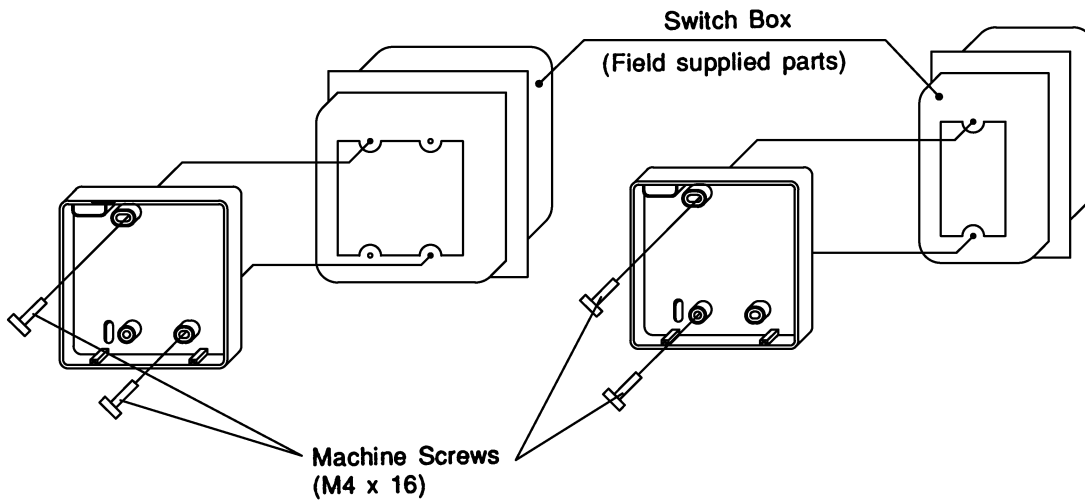
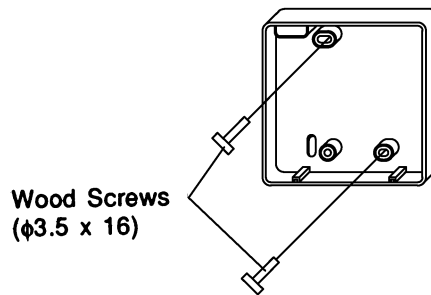

For the field supplied switch box, use optional accessories KJB111A or KJB211A.

NOTE

Choose the flattest place possible for the mounting surface. Be careful not to distort the shape of the lower part of remote controller by over-tightening the mounting screws.

(S1019)

3. Wire the indoor unit.

Connect the terminals on top of the upper part of remote controller(P1, P2), and the terminals of the indoor unit (P1, P2). (P1 and P2 do not have polarity.)

NOTE
When wiring, run the wiring away the power supply wiring in order to avoid receiving electric noise (external noise).

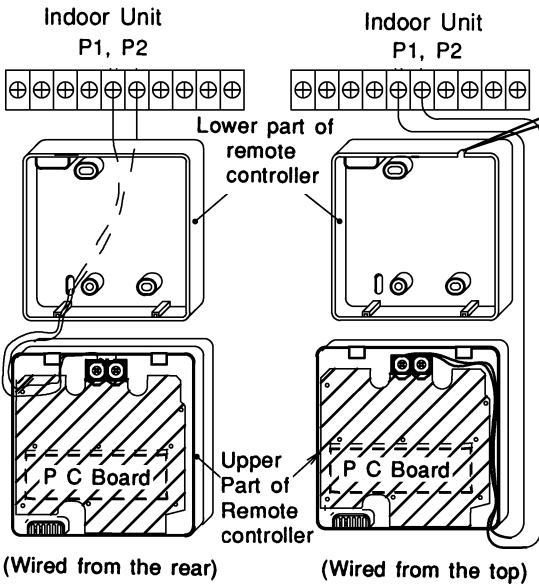

Notch the part for the wiring to pass through with nippers, etc.

Wiring Specifications

Wiring Type	Sheathed vinyl code or cable (2 wire) (See NOTE 2)
Size	0.75 – 1.25 mm ²

NOTE) 1. Peel the shield and sheath for the part that is to pass through the inside of the remote controller case, as shown in the figure below.

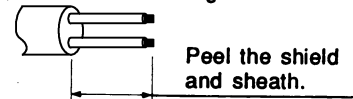

NOTE) 2. Shield wire (2 wire) can be used for remote controller wiring, but it must confirm to EMC (Electromagnetic Compatibility) (Australian regulation).

4. Reattach the upper part of remote controller.

Be careful not to pinch the wiring when attaching.

NOTE

1. The switch box and wiring for connection are not included.
2. Do not directly touch the PC board with your hand.

First, begin fitting from the clips at the bottom.

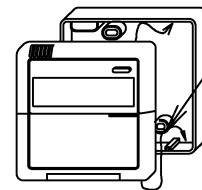

If controlling one indoor unit with two remote controllers

Change the MAIN/SUB changeover switch setting as described below.

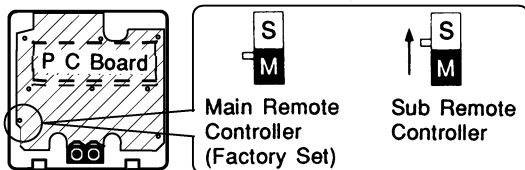

Set one remote controller to "main," and the other to "sub."

NOTE

- If controlling with one remote controller, be sure to set it to "main."
- Set the remote controller before turning power supply on.

"88" is displayed for about one minute when the power supply is turned on, and the remote controller cannot be operated in some cases.

(S1020)

2. Wireless Remote Controller

2.1 Features





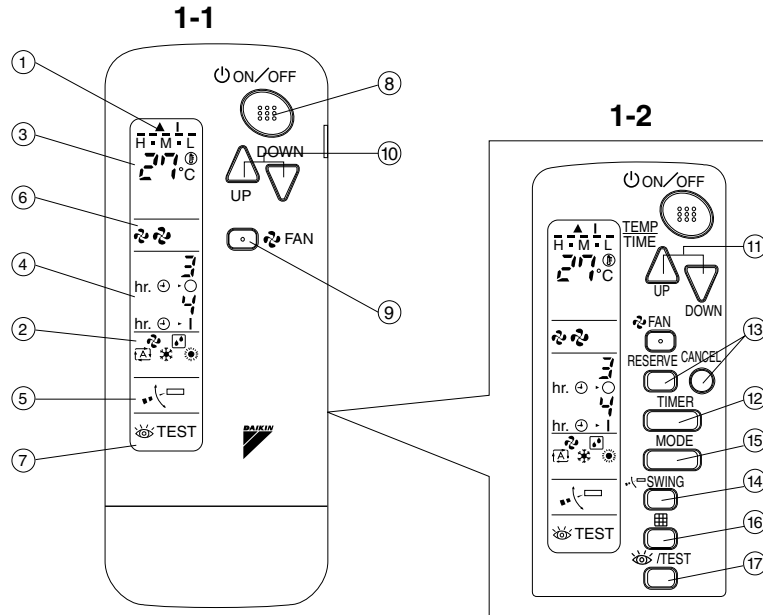



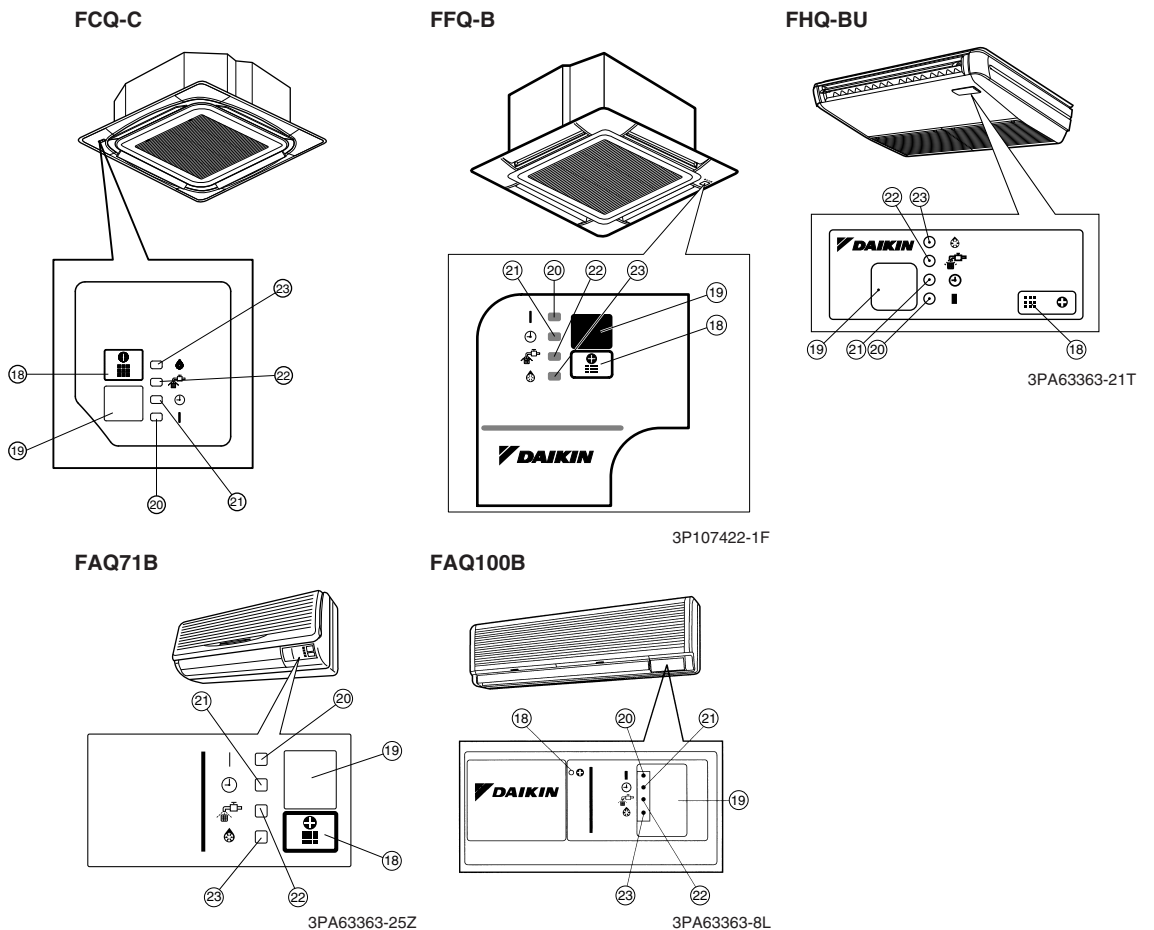



Names and Function

Name of Option		Model Series				
		FCQ-C	FFQ-B	FHQ-BU	FAQ71B	FAQ100B
Remote Controller	H / P	BRC7F532F	BRC7E530W	BRC7E63W	BRC7E618	BRC7C510W



Explanation of Receiver



1	DISPLAY “▲” (SIGNAL TRANSMISSION)
	This lights up when a signal is being transmitted.
2	DISPLAY “” “” “” “” “” (OPERATION MODE)
	This display shows the current OPERATION MODE. For straight cooling type, “  ” (Auto) and “  ” (Heating) are not installed.
3	DISPLAY “” (SET TEMPERATURE)
	This display shows the set temperature.
4	DISPLAY “” (PROGRAMMED TIME)
	This display shows PROGRAMMED TIME of the system start or stop.
5	DISPLAY “” (AIR FLOW FLAP)
6	DISPLAY “” “” (FAN SPEED)
	The display shows the set fan speed.
7	DISPLAY “ TEST” (INSPECTION/ TEST OPERATION)
	When the INSPECTION/TEST OPERATION BUTTON is pressed, the display shows the system mode is in.
8	ON/OFF BUTTON
	Press the button and the system will start. Press the button again and the system will stop.
9	FAN SPEED CONTROL BUTTON
	Press this button to select the fan speed, HIGH or LOW, of your choice.
10	TEMPERATURE SETTING BUTTON
	Use this button for SETTING TEMPERATURE (Operates with the front cover of the remote controller closed.)
11	PROGRAMMING TIMER BUTTON
	Use this button for programming “START and/or STOP” time. (Operates with the front cover of the remote controller opened.)
12	TIMER MODE START/STOP BUTTON

13	TIMER RESERVE/CANCEL BUTTON
14	AIR FLOW DIRECTION ADJUST BUTTON
15	OPERATION MODE SELECTOR BUTTON
	Press this button to select OPERATION MODE.
16	FILTER SIGN RESET BUTTON
	Refer to the section of MAINTENANCE in the operation manual attached to the indoor unit.
17	INSPECTION/TEST OPERATION BUTTON
	This button is used only by qualified service persons for maintenance purposes.
18	EMERGENCY OPERATION SWITCH
	This switch is readily used if the remote controller does not work.
19	RECEIVER
	This receives the signals from the remote controller.
20	OPERATING INDICATOR LAMP (Red)
	This lamp stays lit while the air conditioner runs. It flashes when the unit is in trouble.
21	TIMER INDICATOR LAMP (Green)
	This lamp stays lit while the timer is set.
22	AIR FILTER CLEANING TIME INDICATOR LAMP (Red)
	Lights up when it is time to clean the air filter.
23	DEFROST LAMP (Orange)
	Lights up when the defrosting operation has started. (For straight cooling type this lamp does not turn on.)

C: 3PA63363-25Z
 C: 3PA63363-21T
 C: 3P107422-1F
 C: 3PA63363-8L

3. Method of Operating Remote Controller

3.1 The INSPECTION / TEST Button

The following modes can be selected by using the [Inspection/Test Operation] button on the remote control.

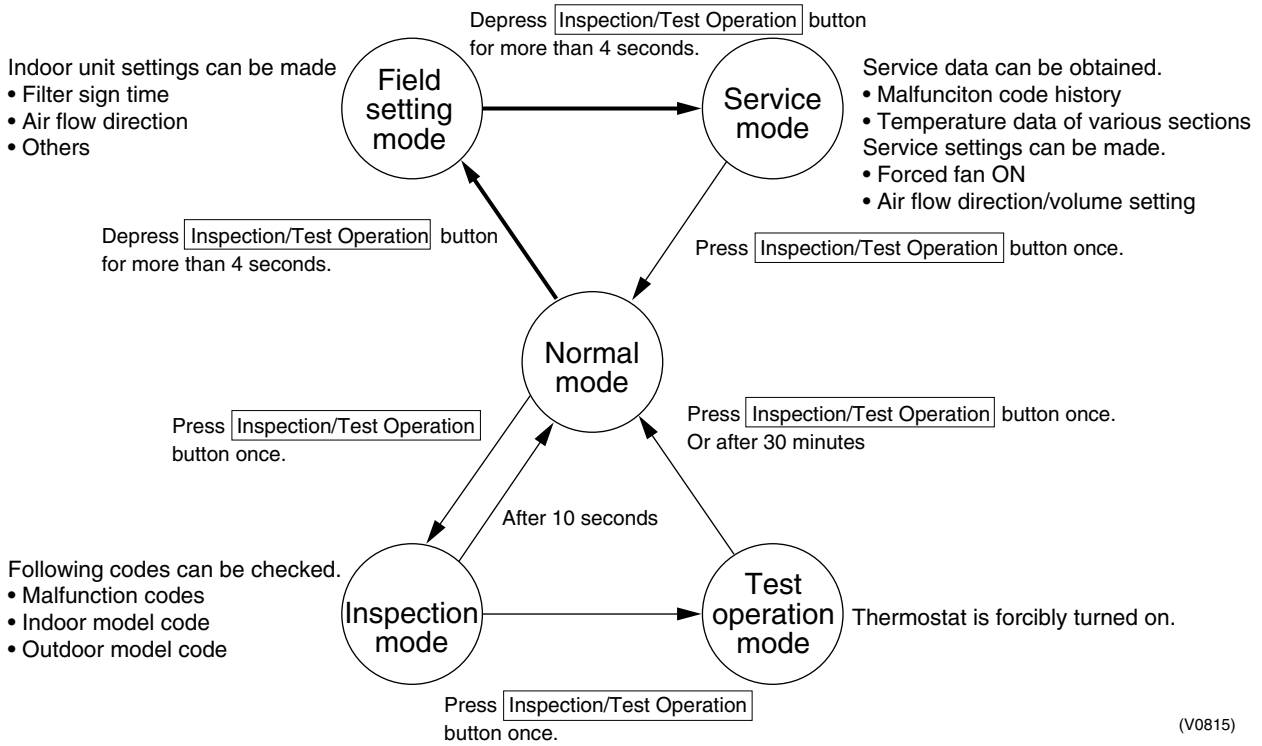

(V0815)

3.2 Maintenance Mode Setting

3.2.1 Service Data Confirmation

Procedure

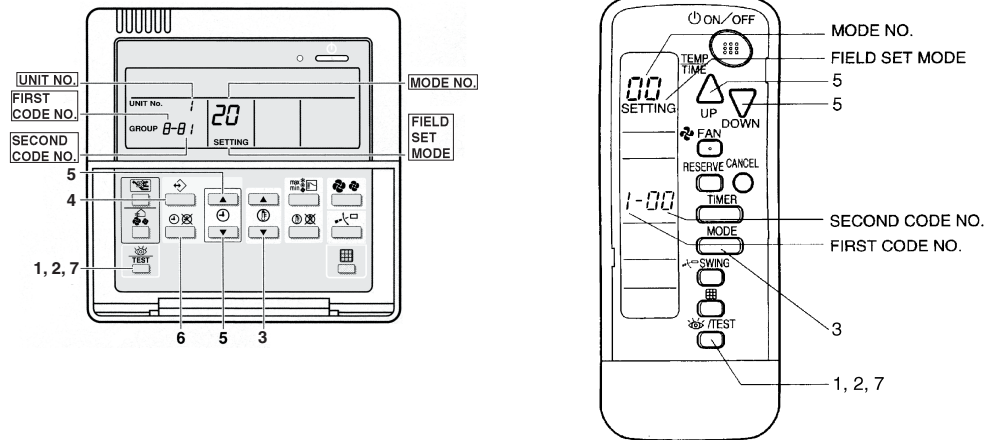

1. Enter the field set mode.
Continue to push the inspection / test operation button for a minimum of 4 seconds.
2. Enter the service mode.
After having entered the field set mode, continue to push the inspection / test operation button for a minimum of 4 seconds.
3. Select the mode No.
Set the desired mode No. with the up/down temperature setting button.
4. Select the unit No.
Select the indoor unit No. set with the TIME MODE START/STOP button.
5. Select the necessary settings for each mode. (Modes 40 or 41)
6. Select the desired malfunction hysteresis of sensor data display with or button.
(In case of wireless remote controller, use or button.)
Each data displays (Refer below display)
7. Return to the normal operation mode.
Press the inspection / test operation button one time.

Table

Mode No.	Function	Content and Operation Method	Example of Remote Controller Display
40	Malfunction Hysteresis	You can change the history with the programming time up-down button.	<p>(S1958)</p>
41	Sensor Data Display	Select the display sensor with the programming time up-down button Display sensor 00 Remote control sensor 01 Suction 02 Heat exchange	<p>(S1954)</p>

3.2.2 Service Mode Setting

Procedure

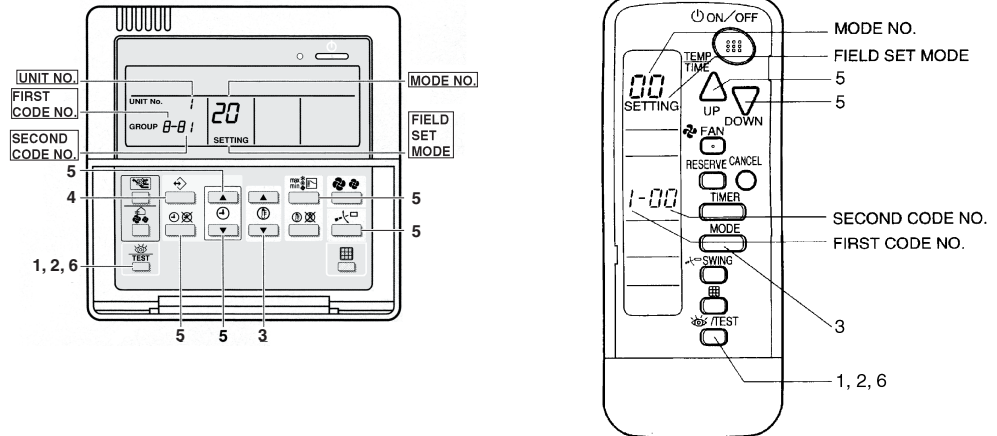

1. Enter the field set mode.
Continue to push the inspection / test operation button for a minimum of 4 seconds.
2. Enter the maintenance mode.
After having entered the field set mode, continue to push the inspection / test operation button for a minimum of 4 seconds.
3. Select the mode No. (Mode 43, 44 or 45)
Set the desired mode No. with the up/down temperature setting button.
4. Select the unit No.
Select the indoor unit No. set with the TIME MODE START/STOP button.
5. Carry out the necessary settings for each mode. (Mode 43 only possible for wireless remote controller)
 - In case of Mode 43;
Press TIMER ON / OFF BUTTON to decide the forced Fan ON.
 - In case of Mode 44;
Set "Fan speed" with FAN SPEED CONTROL BUTTON and "Air flow direction" with AIR FLOW DIRECTION ADJUSTING BUTTON, then press TIMER ON / OFF BUTTON to decide.
 - In case of Mode 45;
Select the changed unit No. with or button, then press TIMER ON / OFF BUTTON to decide.
6. Return to the normal operation mode.
Tap the inspection / test operation button one time.

Table

Mode No.	Function	Content and Operation Method	Example of Remote Controller Display
43	Forced Fan ON	Turns the fan ON for each unit individually.	
44	Individual Setting	Sets fan speed and air flow direction for each unit individually when using group control. Settings are made using the "air flow direction adjust" and "fan speed adjust" buttons.	
45	Unit No. Change	Changes unit No. Set the unit No. after changing with the programming time up-down button.	

3.3 Operation of the Remote Controller's Inspection / Test Operation Button

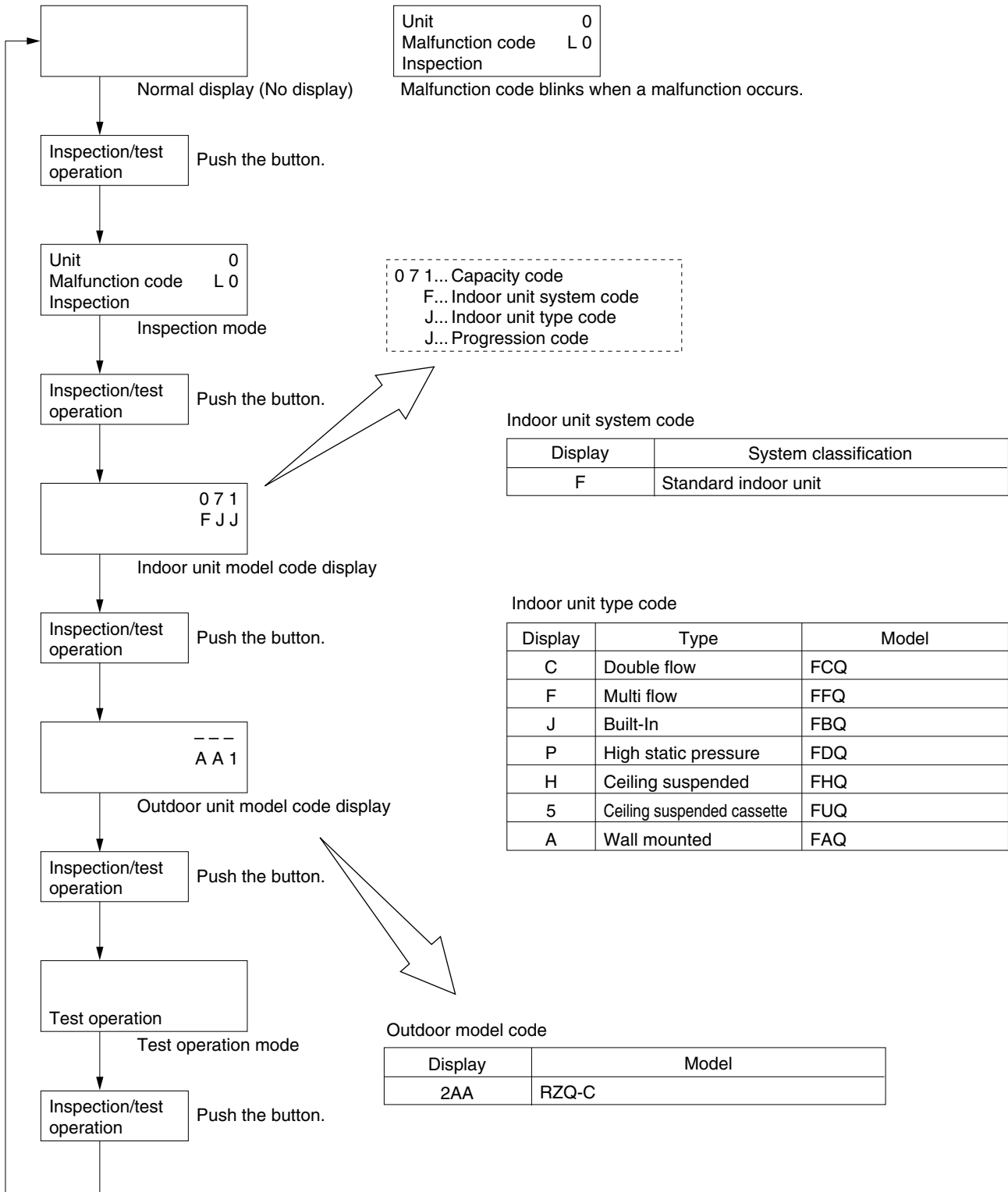

(V2775)

3.4 Remote Controller Service Mode

How to Enter the Service Mode

The operation of the Inspection/Test Operation button on the remote controller allows the unit to enter the Test Operation mode.

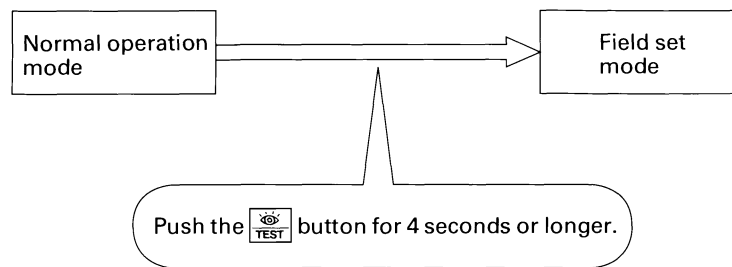

When the Start/Stop button is pushed after the Test Operation mode is set, test operation starts. ("Test Operation" appears on the remote controller.)

3.5 Remote Controller Self-Diagnosis Function

The following will be displayed on the screen when a malfunction (or a warning) occurs during operation.

Check the malfunction code and take the corrective action specified for the particular model.

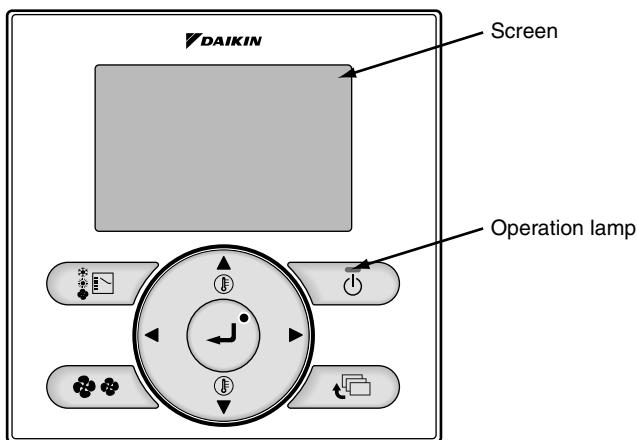

(1) Checking a malfunction or warning

	Operation Status	Display
Abnormal shutdown	The system stops operating.	<p>The operation lamp (green) starts to blink. The message "Malfunction: Press Menu button" will appear and blink at the bottom of the screen.</p>
Warning	The system continues its operation.	<p>The operation lamp (green) remains on. The message "Warning: Press Menu button" will appear and blink at the bottom of the screen.</p>

(2) Taking corrective action

· Press the Menu/Enter button to check the malfunction code.



· Take the corrective action specific to the model.

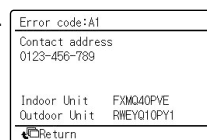

— Malfunction code

— Applicable model names

Part 4

Functional Description

1.	General Functionality	27
1.1	Functions of Thermistors	27
1.2	Forced Operating Mode (Emergency Operation)	28
1.3	Outdoor Unit Identification Function	30
1.4	Simulated Operation Function	31
1.5	Restart Standby	32
1.6	Automatic Restart	33
1.7	Using Conditions for Remote Controller Thermostat	34
1.8	Forced Thermostat OFF	36
1.9	Test Run Control	37
1.10	4-way Valve Control	38
1.11	Pump Down Operation	39
1.12	Defrost Operation	40
1.13	Freeze Prevention Function	42
1.14	PMV Control	43
1.15	Crankcase Heater Control	44
2.	Indoor Unit Functional Concept	45
2.1	Thermostat Control	45
2.2	Drain Pump Control	46
2.3	Condensation Avoidance Control	47
2.4	Draft Avoidance Control 1	48
2.5	Draft Avoidance Control 2	49
2.6	Fan and Flap Operation	50
2.7	Indoor Unit Fan Control	51
3.	Outdoor Unit Functional Concept	53
3.1	Function Outline in Cooling Mode	53
3.2	Function Outline in Heating Mode	54
4.	Frequency Regulating Functions	55
4.1	Starting Frequency Control	55
4.2	Starting Control	56
4.3	General Frequency Control	57
4.4	Low Pressure Protection Control	59
4.5	High Pressure Protection Control	61
4.6	Discharge Pipe Temperature Control	62
4.7	Suction Pipe Superheat Protection Control (Heating Mode)	63
4.8	Inverter Current Protection Control	64
4.9	Protection Control by Overall Current	65
4.10	Inverter Cooling Fin Temperature Control	66
4.11	Pressure Difference Control	67
4.12	Oil Recovery Operation	70
5.	Expansion Valve Regulating Functions	71
5.1	Expansion Valve Control at Startup	71
5.2	General Expansion Valve Control	72
5.3	Discharge Pipe Temperature Protection Control	73

6. Outdoor Unit Fan Speed Control.....	74
6.1 Outdoor Unit Fan Speed Control.....	74

1. General Functionality

1.1 Functions of Thermistors

Locating the thermistors

■ RZQ71~140D7V1B (Single phase)

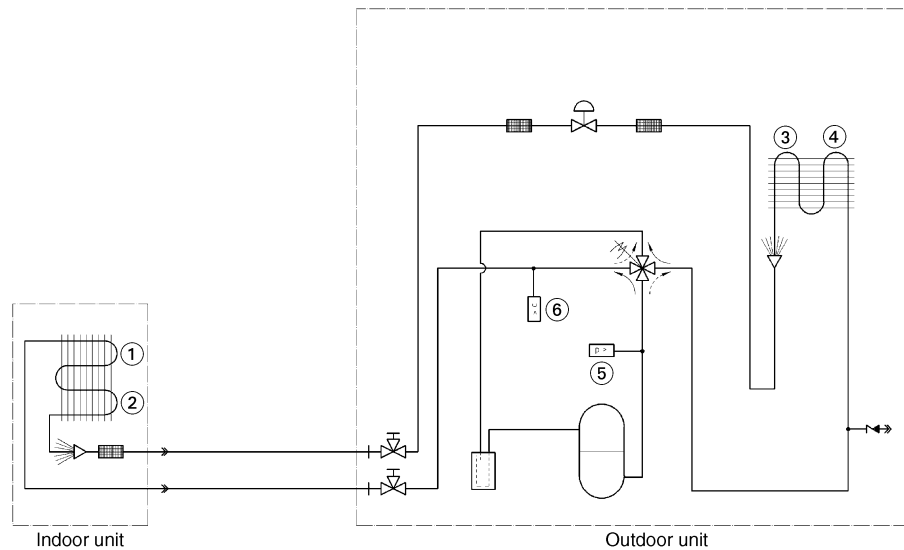

Note: Sensor R3T on indoor coil of **FCQ35~60, FFQ35~60, FBQ35~60 & FHQ35~60** is not used when the indoor units are connected to RZQ outdoor units.

Functions of the thermistors

Thermistor	Location	Wiring symbol	Mode	Function
1	Indoor heat exchanger	R2T	Cooling	<ul style="list-style-type: none"> ■ Compressor frequency control (target Te) ■ Inverter current protection control ■ Freeze-up control
			Heating	<ul style="list-style-type: none"> ■ Compressor frequency control (target Tc) ■ Inverter current protection control ■ Hot start control ■ Peak cut-off
2	Indoor air return	R1T	Cooling	<ul style="list-style-type: none"> ■ Thermostat control ■ PMV control ■ General frequency control
			Heating	<ul style="list-style-type: none"> ■ Thermostat control ■ PMV control ■ General frequency control
3	Outdoor heat exchanger	R2T	Cooling	<ul style="list-style-type: none"> ■ Inverter current protection control
			Heating	<ul style="list-style-type: none"> ■ Inverter current protection control ■ Defrost control
4	Outdoor ambient	R1T	Cooling	<ul style="list-style-type: none"> ■ Outdoor fan speed control ■ PMV control ■ Pressure difference control ■ Overall current protection control ■ Preheating operation control (RZQ71)
			Heating	<ul style="list-style-type: none"> ■ Defrost control ■ PMV control ■ Forced thermostat OFF ■ Overall current protection control ■ Preheating operation control (RZQ71)
5	Discharge pipe	R3T	Cooling	<ul style="list-style-type: none"> ■ Discharge superheat control ■ Expansion valve control ■ Crankcase heater / preheating control
			Heating	<ul style="list-style-type: none"> ■ Expansion valve control ■ Crankcase heater / preheating control
6	Suction pipe	R4T	Cooling	<ul style="list-style-type: none"> ■ Expansion valve control (SH control)
			Heating	<ul style="list-style-type: none"> ■ Expansion valve control (SH control) ■ Suction pipe superheat protection control
7	Inverter power module	R5T	Cooling	<ul style="list-style-type: none"> ■ Outdoor fan speed control ■ Inverter fin temperature control ■ Pressure difference control
			Heating	<ul style="list-style-type: none"> ■ Inverter fin temperature control

1.2 Forced Operating Mode (Emergency Operation)

Purpose

The table below describes the purpose of the forced operating mode.

If...	Then...
<ul style="list-style-type: none"> ■ R/C is defective ■ Indoor PC board is defective ■ Outdoor PC board is defective 	Forced operating mode can be used to go to cooling or heating. In forced operating mode, the compressor is forced to operate until the defective indoor or outdoor PC board is back online.

Starting conditions

You can operate the system manually by changing the emergency switch on the indoor and outdoor PC board from "normal" to "emergency". When the system is operating in "emergency" it can not control the room temperature.

Both the indoor and outdoor unit must be set to "emergency" while the power is off.

Ending conditions

You can end the emergency operation by changing the "emergency" switch back to "normal" while the power is OFF.

Emergency operation

Below table explains what will happen when the switch is set to "emergency":

Changing the switch to "emergency" for the...	Switches ON the...
Indoor unit	<ul style="list-style-type: none"> ■ Indoor fan ■ Drain pump
Outdoor unit	<ul style="list-style-type: none"> ■ Compressor ■ Outdoor fan(s)

How to set Emergency Operation

To set emergency operation, proceed as follows:

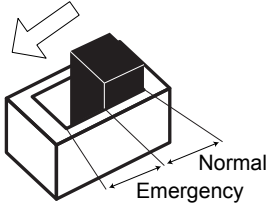
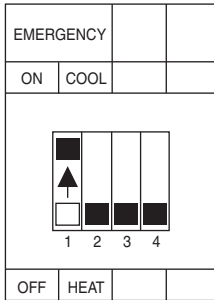
Step	Action
1	Turn OFF the power.
2	Switch ON the emergency switch (SS1) on the indoor PC board. 
3	Switch ON the emergency switch on the outdoor PC board. 

Step	Action
4	<p>Set the emergency switch on the outdoor PCB to the forced mode you prefer (Cooling or Heating).</p>
5	Turn ON the power supply.

Active components

Component	Forced cooling	Forced heating	Forced defrosting
Compressor	ON	ON	ON
4-way valve	OFF	ON	OFF
Outdoor unit fan	H fan speed	H fan speed	OFF
Indoor unit fan	H fan speed	H fan speed	H fan speed
Drain pump	ON	ON	ON

Additional info

- During emergency operation, do not attempt to operate the equipment from the remote controller. The remote controller shows "88" while the emergency operation is active on the indoor unit
- If a safety device is activated during emergency, all actuators are turned OFF
- In cooling, the unit runs for 20min and then stops for 10min in order to avoid freeze-up of the indoor coil.
- In heating, defrost is activated for 3 minutes once every hour.
- Emergency operation can not be carried out when the PC board itself is defective.
- Be sure to set the emergency switch on both the outdoor and indoor unit.
- The unit will not regulate the temperature during emergency operation.
- Change the position of the emergency switch only when the power is turned off.

1.3 Outdoor Unit Identification Function

Purpose

The purpose of the outdoor unit identification function is to enable the indoor unit to automatically determine which operating mode has to be set in function of the type of connected outdoor unit (C/O or H/P).

Operating modes

The possible operating modes are:

Outdoor unit	Operating modes
H/P	<ul style="list-style-type: none"> ■ Fan ■ Cooling ■ Dry keep ■ Heating
C/O	<ul style="list-style-type: none"> ■ Fan ■ Cooling ■ Dry keep

Used input

The outdoor unit identification function uses the following inputs:

Input	Connection on indoor PCB	Connection on outdoor PCB
Indoor PC board	TC & RC	—
Outdoor PC board	—	TC & RC

TC: Transmission circuit

RC: Receiving circuit

1.4 Simulated Operation Function

■ RZQ71~140D7V1B (1 phase)

In case of a thermistor malfunction, simulated operation is performed in two different ways as shown below even while the malfunction is detected.

A. Operation continues while the malfunction code is displayed on the remote controller.

Applicable thermistors

- Outside air temperature thermistor
- Heat exchanger distribution pipe thermistor (in cooling operation only)
- Intermediate heat exchanger thermistor (in heating operation only)
- Liquid pipe thermistor
- Indoor suction air thermistor
- Indoor heat exchanger thermistor

B. Operation continues even the malfunction is detected. The remote controller displays "Inspection/Test Run". Only when the button is pushed, the malfunction code appears.

Applicable thermistors

- Remote controller thermistor
- Radiation fin thermistor

**Note:**

In case of a thermistor malfunction other than A and B above, a malfunction stop is made and no simulated operation is carried out.

Applicable thermistors

- Suction pipe thermistor
- Discharge pipe thermistor
- Heat exchanger distribution pipe thermistor (in heating operation only)
- Intermediate heat exchanger thermistor (in cooling operation only)

1.5 Restart Standby

■ RZQ71~140D7V1B (1 phase)

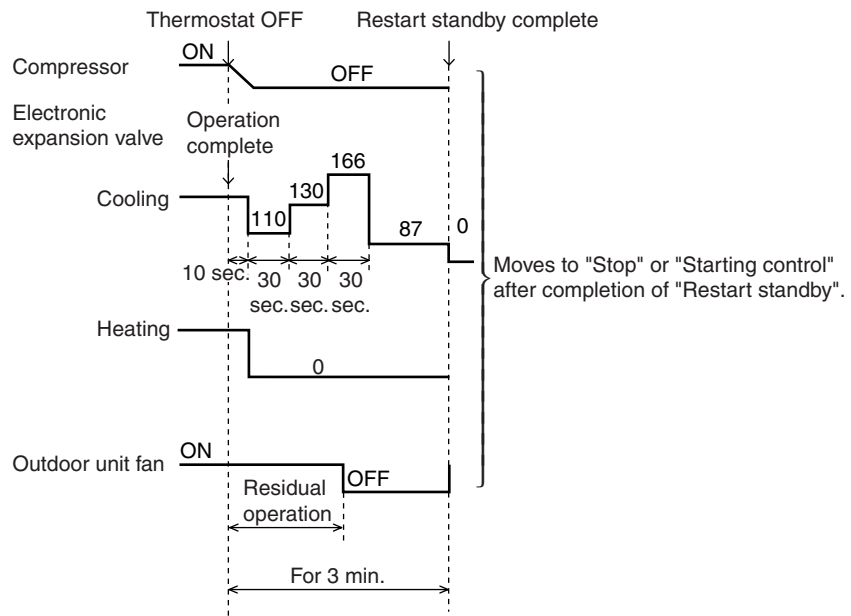

1.6 Automatic Restart

Purpose

The purpose of the auto-restart function is to automatically resume the same operating mode as when the unit was operating when the power supply is restored after a power failure.

Do not use the "Automatic Restart" function to daily start/stop the unit.

**Precautions
when turning OFF
power**

- When you have to turn OFF the power supply in order to carry out maintenance, make sure to turn the remote control's ON/OFF switch OFF firstly.
- If you turn OFF the power supply while the remote control's ON/OFF switch is still ON, the "automatic restart function" automatically starts the indoor fan immediately and the outdoor unit fan starts automatically 3 minutes after the power supply is turned back ON.
- Do not start/stop the unit by disconnecting the power supply. Stop the unit by stop commando from the remote controller or optional controller before disconnecting the power supply. Be sure that the compressor and the outdoor fans are stopped before disconnecting the power supply so the "Refrigerant Recovery function" has been finished correctly.
- When restarting the unit after the power was disconnected for a longer period leave the unit OFF with the power supply connected for about half an hour (See "Crankcase Heater Control" & "Preheating Operation Control").

1.7 Using Conditions for Remote Controller Thermostat

Applicable The remote control thermostat is only available in wired remote controls.

Method The remote control sensor is standard disabled for sky-air units. The use of the remote control sensor can be enabled by changing field setting 10(20)-2-02 to 10(20)-2-01.

Conditions The table below contains the condition in which the remote control thermostat is not used:

Condition	The remote controller thermostat is not used when...
1	The remote controller thermostat malfunctions.
2	Group control is used.
3	The set temperature / air suction temperature combination is out of range. (See below graph)

Cooling The diagram below shows the operation range of the set temperature / air suction temperature combination in cooling operation:

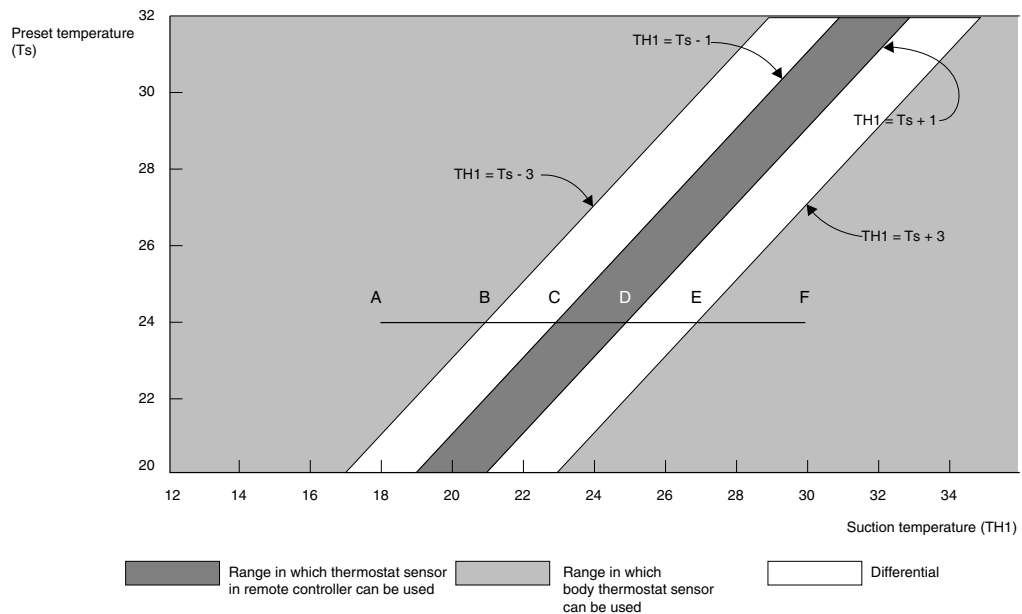

Example Assuming the preset temperature above is 24°C, and the suction temperature has changed from 18°C to 30°C (A --> F):
 (This example also assumes there are several other air conditioners, the VRV system is off, and that temperature changes even when the thermostat sensor is off.)
 Body thermostat sensor is used for temperatures from 18°C to 23°C (A --> C).
 Remote controller thermostat sensor is used for temperatures from 23°C to 27°C (C --> E).
 Body thermostat sensor is used for temperatures from 27°C to 30°C (E --> F).

And assuming suction temperature has changed from 30°C to 18°C (F --> A):
 Body thermostat sensor is used for temperatures from 30°C to 25°C (F --> D).
 Remote controller thermostat sensor is used for temperatures from 25°C to 21°C (D --> B).
 Body thermostat sensor is used for temperatures from 21°C to 18°C (B --> A).

Heating

The diagram below shows the operation range of the set temperature / air suction temperature combination in heating operation:

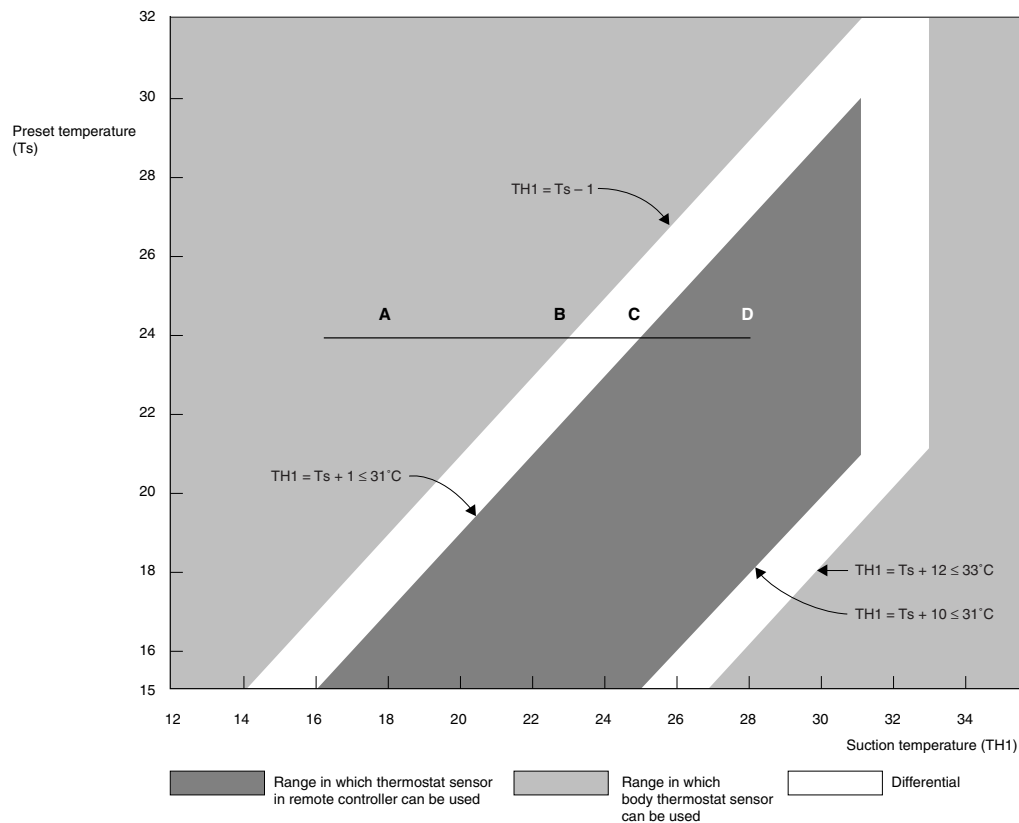

Example

Assuming the preset temperature above is 24°C, and the suction temperature has changed from 18°C to 28°C (A --> D):

(This example also assumes there are several other air conditioners, the VRV system is off, and that temperature changes even when the thermostat sensor is off.)

Body thermostat sensor is used for temperatures from 18°C to 25°C (A --> C).

Remote controller thermostat sensor is used for temperatures from 25°C to 28°C (C --> D).

And assuming suction temperature has changed from 28°C to 18°C (D --> A):

Remote controller thermostat sensor is used for temperatures from 28°C to 23°C (D --> B).

Body thermostat sensor is used for temperatures from 23°C to 18°C (B --> A).

When heating, the hot air rises to the top of the room, resulting in the temperature being lower near the floor where the occupants are. When controlling by body thermostat sensor only, the unit may therefore be turned off by the thermostat before the lower part of the room reaches the preset temperature. The temperature can be controlled so the lower part of the room where the occupants are doesn't become cold by widening the range in which thermostat sensor in remote controller can be used so that suction temperature is higher than the preset temperature.

1.8 Forced Thermostat OFF

The unit will perform the forced thermostat off function in following conditions:

- Condition 1 (cooling)
 - Thermostat off due to freeze-up prevention.
 - Based on the judgment to prevent the indoor heat exchanger from freezing, the thermostat is forcedly turned OFF.

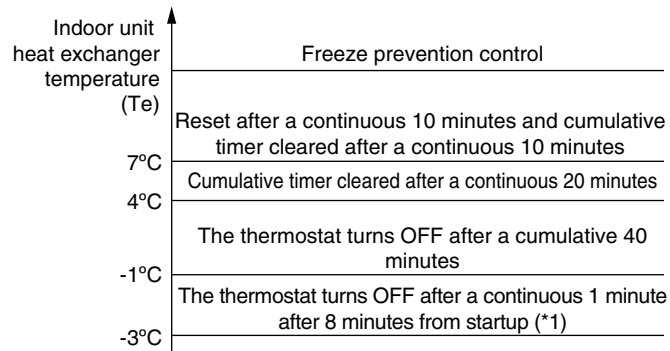

*1 FHQ Only

- Condition 2 (heating)
 - Thermostat off due to high outdoor temperature.
 - RZQ71~140D7V1B (1 phase)
 - When the outside temperature is > 32°CDB in heating mode, the unit will conduct a forced thermostat off operation to protect the system.



"Freeze Prevention Function". Refer to P42.

1.9 Test Run Control

Purpose When operating the RZQ units for the first time after installation, the unit will - depending on the selected operation mode - perform a test run operation first.

Situation 1

Cooling - first operation after installation in "Cooling mode"

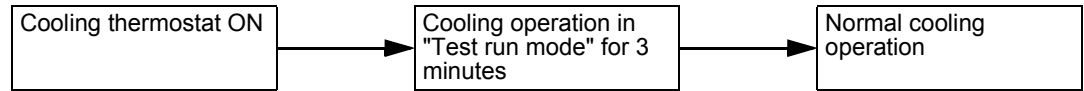

Situation 2

Cooling - first operation after installation in "Test run mode"

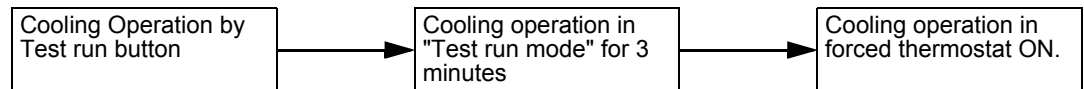

Situation 3

Heating - first operation after installation in "Heating mode"

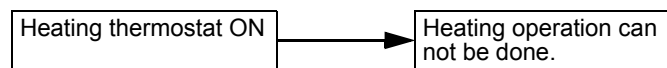

Situation 4

Heating - first operation after installation in "Test run mode"

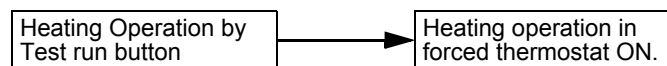

Note:

- When running in test run mode, the unit will sense on site installation parameters (e.g.: failure to open stop valves,...) and indicate the applicable malfunction code if required.
- If the remote controller shows E3, E4 or L8 as an error code, there is possibility that either the stop valve is closed or the air flow outlet is obstructed.
- Check the inter unit branch wiring connection (1-2-3 wiring) when the error code U4 or UF is displayed on the remote controller.
- When the error code U2 is displayed on the remote controller, check for voltage imbalance.
- When the error code L4 is displayed on the remote controller, there is possibility that the air flow passage is closed.
- When there is no error code display, cooling operation continues without interruption. (However, this control is once again performed after refrigerant is recovered by means of the pump down switch and at the time of the first operation after the outdoor PC board replacement.)

1.10 4-way Valve Control

Purpose

The purpose of the 4-way valve control is to control how the superheated refrigerant passes through the 4-way valve. The 4-way valve control carries out the changeover switching of the 4-way valve. This changeover switching is only carried out during operation, because a certain pressure difference is required to move the internal cylinder.

When...	Then the 4-way valve connects the outlet of the compressor with...
Cooling	Outdoor heat exchanger
Heating	Indoor heat exchanger

Method

The table below describes the 4-way valve control operation.

In...	The 4-way valve is...
Heating, except for defrosting	ON
Cooling Dry keep Defrosting	OFF

Time chart

The time chart below illustrates the 4-way valve control.

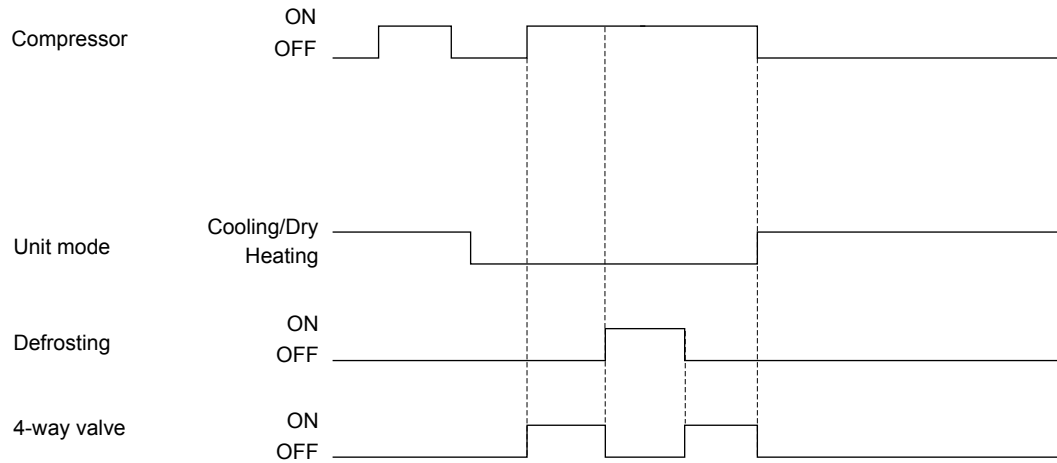

1.11 Pump Down Operation

Outline

Whenever the units need to be moved or removed, perform a pump-down operation before disconnecting the field piping. By performing a pump-down operation, all of the refrigerant will be collected in the outdoor unit.

Procedure

Procedure		Precautions
1	Start "Fan only operation" from the remote controller.	Confirm that both the liquid and gas stop valves are open.
2	Push the pump-down button BS1 on the outdoor PCB.	Compressor and outdoor fan will start automatically.
3	Once the operation stops (after 3~5 minutes) close the liquid stop valve first and then the gas stop valve.	
	After the "Pump Down Operation" has been finished the wired remote controller screen may be blank or show "U4" error indication. It will not be able to start the unit from the remote controller without switching OFF the power supply first.	Make sure the stop valves are opened before restarting the unit.

Cautions

- Pressing the pump down switch (BS1) on the outdoor PCB may cause the outdoor and indoor fan to start operating automatically.
- Be sure to open the stop valves after the pipe work has been finished. Be sure not to operate the unit with closed stop valves, or the compressor may brake down.

1.12 Defrost Operation

Outline

When the unit is operating in heating mode, a defrost operation will be conducted in order to avoid ice formation on the outdoor unit heat exchanger.

Defrost starting conditions

Defrost will start when the following conditions have been realized:

- &
 - Integrated compressor running time is 25 minutes or more since the completion of the previous defrost operation.
 - OR
 - Defrost upper limit time A is met.
 - Outdoor unit heat exchanger area temperature (Tb) is within the defrost requesting area.

■ RZQ71~140D7V1B (1 phase)

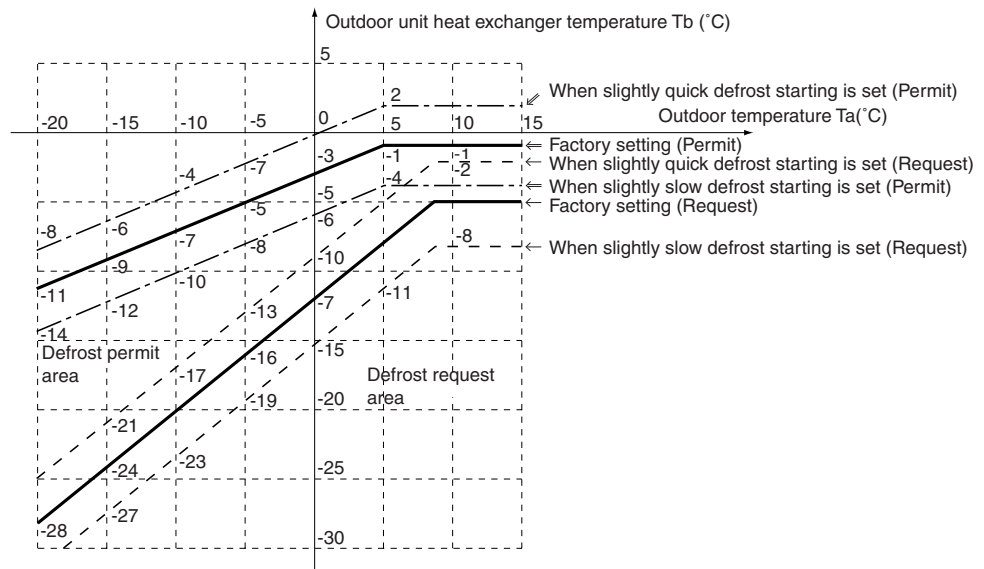

Areas

Defrost upper limit A

	When quick defrost starting is set 16(26)-3-03	Factory setting 16(26)-3-01	When slow defrost starting is set 16(26)-3-02
Outdoor temperature > -5°C	40 minutes	A hours	6 hours
Outdoor temperature ≤ -5°C	40 minutes	6 hours	8 hours

	A hours
RZQ71	3 hours
RZQ100~140	2 hours

Defrost control

■ RZQ71~140D7V1B (1 phase)

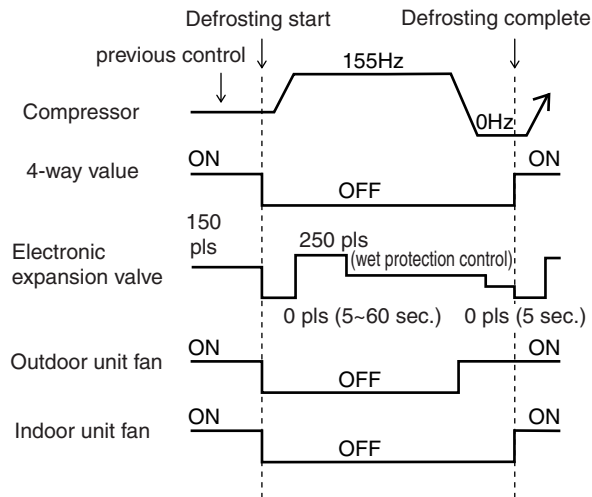

Defrost ending conditions

Defrosting ends when the following conditions have been realized. Note that defrosting can be operated for 10 minutes at longest.

■ RZQ71~140D7V1B (1 phase)

- OR
 - & {
 - Defrost Time > 10 sec.
 - Hp > 2.45 MPa
 - & {
 - Defrost Time > 1 min.
 - Hp > 12°C
 - & {
 - Defrost Time > 9 min.
 - Tb > 10°C

1.13 Freeze Prevention Function

Purpose

In order to avoid formation of ice on the indoor unit heat exchanger in cooling and dry mode, the system automatically starts up a freeze prevention cycle when a number of specific conditions are fulfilled.

Freeze Prevention start conditions

Freeze prevention start decided by the indoor unit (factory setting):

- OR {
 - Indoor coil temperature $\leq 1^{\circ}\text{C}$ for 40 minutes accumulated
 - & {
 - Indoor coil temperature $< A^{\circ}\text{C}$ for 1 minute continuous
 - Compressor is running for minimum 8 minutes since operation start or end of previous freeze up cycle.

Freeze Prevention stop conditions

Freeze prevention stop decided by the indoor unit (factory setting):

- Indoor coil temperature $> 7^{\circ}\text{C}$ for 10 minutes continuous

Parameters

	FAQ	FHQ	All except FAQ & FHQ
A	-1°C	-3°C	-5°C

Reference

Please refer to "Outdoor Field Settings" in Part 5 "Test Operation" for details on possible use of EDP room settings in case of low latent heat applications. (Refer to P94)

1.14 PMV Control

Outline

When the automatic mode is selected on the remote-controller, the unit will automatically activate the PMV control.

The PMV index is a calculated average comfort level.

Refer to ISO 7730 for details.

Function

An optimized indoor temperature will be calculated using the following inputs:

- Outdoor air temperature
- Indoor air temperature
- Remote controller set temperature

In practice, the set point will be moved with 1 or 2 degrees whenever the conditions change. This will result in a combination of power saving and increased comfort level.

PMV control can be disabled by changing the field settings:

From: 11(21)-4-01 to: 11(21)-4-02

1.15 Crankcase Heater Control

- RZQ71~140D7V1B (1 phase)

Outline

After the compressor has been turned off, the crankcase heater control will be activated in order to avoid refrigerant from dissolving in the compressor oil.

Trigger conditions

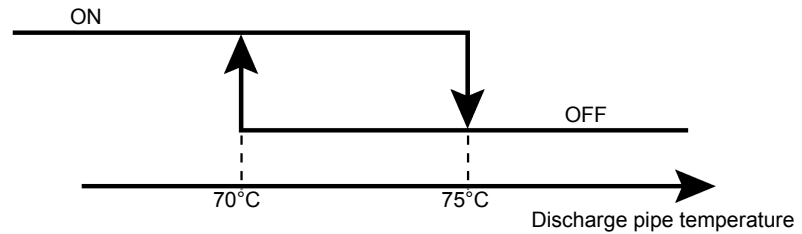

2. Indoor Unit Functional Concept

2.1 Thermostat Control

According to a difference between the temperature set by the remote controller and the actually detected room temperature (*1), the thermostat is turned ON or OFF.

■ In normal operation

In cooling

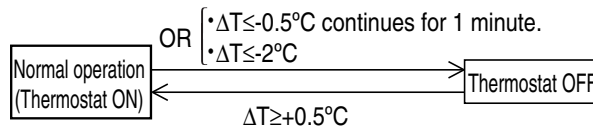

In heating

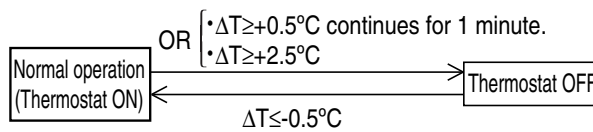

■ In dry operation

$T_{ro} > 24^{\circ}\text{C}$

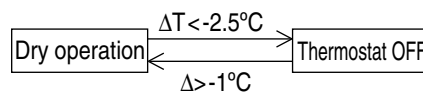

$24^{\circ}\text{C} \geq T_{ro} > 16^{\circ}\text{C}$

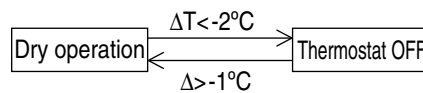

$16^{\circ}\text{C} \geq T_{ro}$

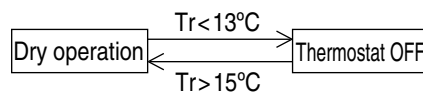

Note:

- *1: The thermistor to detect room temperature is as follows according to field setting.
 - a. Factory setting: Indoor unit suction air thermistor
 - b. When set to remote controller thermistor: Indoor air thermistor in the remote controller

2: Explanation of each symbol

ΔT : Detected room temperature - Temperature set by remote controller

T_{ro} : Room temperature detected when dry operation is started

T_r : Room temperature detected by thermistor

2.2 Drain Pump Control

2.2.1 Cooling Operation, Dry Operation

FCQ

Normally drain pump ON (Thermostat ON/OFF)

Excluding FCQ

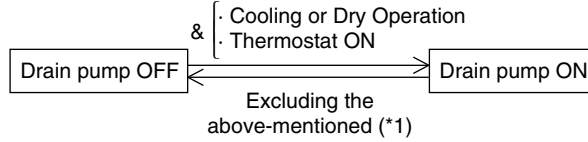

*1: When changing over from ON to OFF, the residual operation is done for 5 minutes.

2.2.2 Heating Operation

When the following condition consists by mounting the adaptor for wiring PC board and the humidifier, the drain pump is turned on.

Humidifier interlock not-equipped

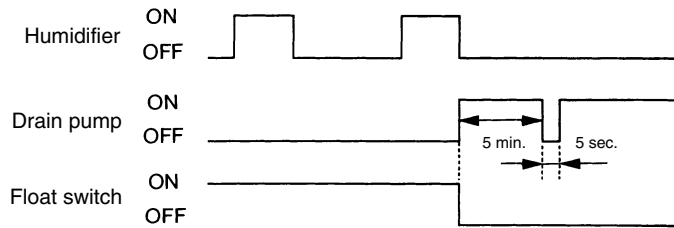

Humidifier interlock equipped

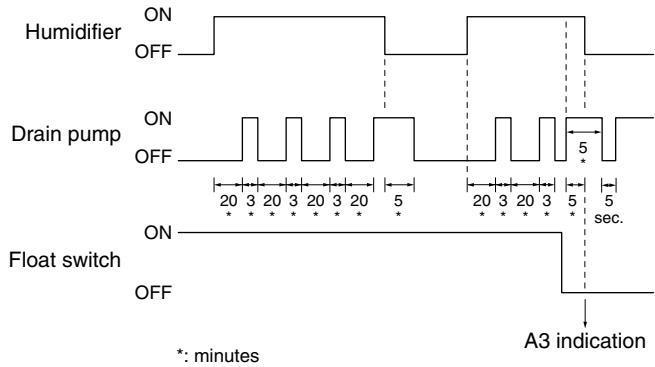

2.3 Condensation Avoidance Control

■ FHQ71~125, FAQ71~100

In cooling and dry operation, the following control is carried out in order to prevent dew condensation when the horizontal blade blows air downward.

[Start condition]

- & [
- Horizontal blade is set to downward flow
 - Cooling operation (compressor operation) continues for A minutes.

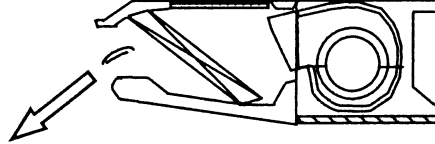

	FHQ	FAQ
A	30 min.	20 min.

[Dew condensation prevention control]

Dry operation with horizontal air flow is carried out for one hour (*1).

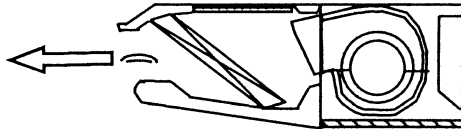

Note

1. When there is any change to heating/fan modes, airflow direction and operation ON/OFF state during dew condensation prevention control, this control is reset.
2. *1: For FAQ71, the air flow is 44 degrees downward from the horizontal direction.

2.4 Draft Avoidance Control 1

Purpose

Avoid draft for the customer by delaying transfer of the flap to the Po0 (horizontal) position for a certain amount of time when defrosting and in heating thermostat OFF.

Heating thermostat OFF

The time chart below illustrates the draft avoidance control 1 in heating thermostat OFF.

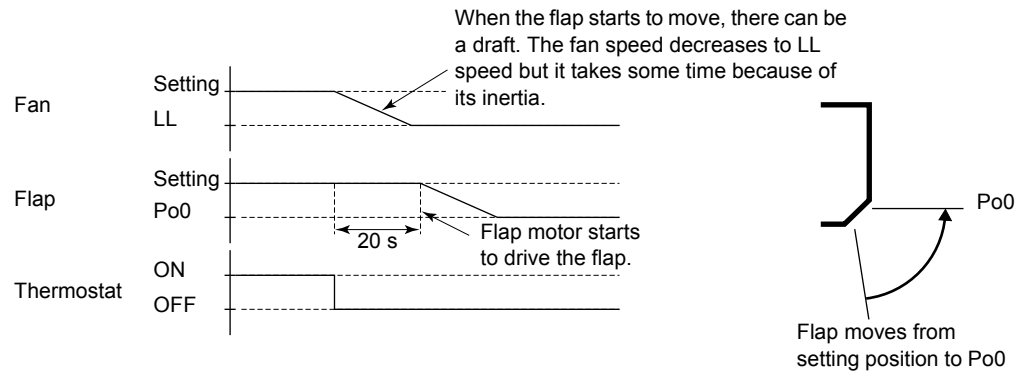

Defrosting

The time chart below illustrates the draft avoidance control 1 in defrosting.

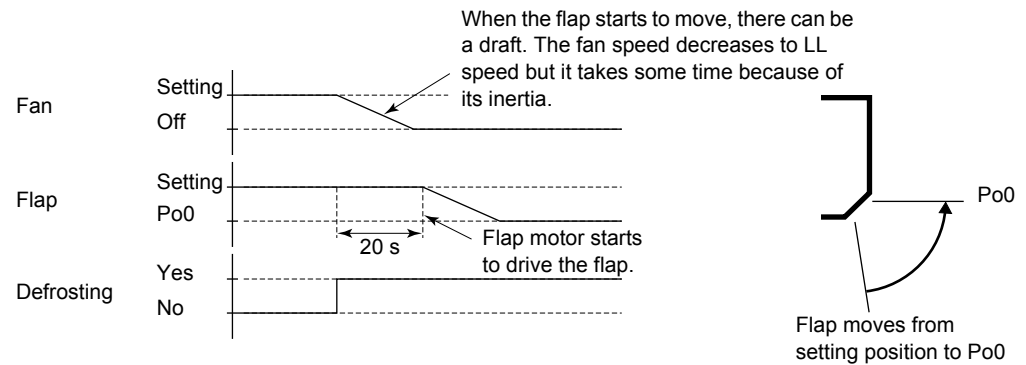

Used inputs

The draft avoidance control 1 uses the following inputs:

Input	Connection on indoor PCB	Connection on outdoor PCB
Limit switch for flap	33S	—
No. of fan turns	X26A	—
Outdoor heat exchanger thermistor (defrost control)	—	R2T

2.5 Draft Avoidance Control 2

Purpose The purpose of the draft avoidance control 2 is to avoid draft when the flap is moving.

Starting conditions The draft avoidance control 2 is activated when:

- Hot start is finished, or
- Cold air prevention control is finished.

Time chart If the fan speed is set to "H", the fan turns at low speed for a certain amount of time.

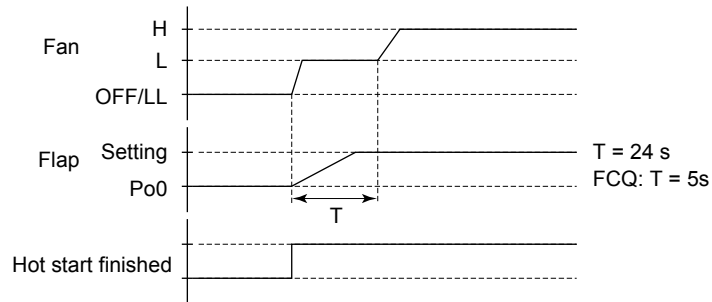

Used input Draft avoidance control 2 uses the following inputs:

Input	Connection on indoor PCB	Connection on outdoor PCB
Limit switch for flaps	33S	—
No. of fan turns	X26A	—

2.6 Fan and Flap Operation

Cooling operation

The table below contains the fan and flap operations.

Function	In...	Fan	Flap (FCQ(H) and FHQ)	Flap (FAQ)	Remote control indication
Thermostat ON in Dry Keep Mode	Swing operation	L	Swing	Swing	Swing
	Airflow direction setting		Set position	Set position	Set position
Thermostat OFF in Dry Keep Mode	Swing operation	OFF	Swing	Swing	Swing
	Airflow direction setting		Set position	Set position	Set position
Thermostat OFF in Cooling Mode	Swing operation	Set	Swing	Swing	Swing
	Airflow direction setting		Set position	Set position	Set position
Stop (Error)	Swing operation	OFF	Horizontal	Downward	—
	Airflow direction setting		Set position	Downward	
Freeze-prevention	Swing operation	L(*)	Swing	Swing	Swing
	Airflow direction setting		Set position	Set position	Set position

(*) LL operation on cassette type units

Heating operation

The table below contains the fan and flap operations.

Function	In...	Fan	Flap (FCQ(H) and FHQ)	Flap (FAQ)	Remote control indication
Hot start after defrost	Swing operation	OFF	Horizontal	Horizontal	Swing
	Airflow direction setting				Set position
Defrost	Swing operation	LL	Horizontal	Horizontal	Swing
	Airflow direction setting				Set position
Thermostat OFF	Swing operation	LL	Horizontal	Horizontal	Swing
	Airflow direction setting				Set position
Hot start after thermostat OFF (cold air prevention)	Swing operation	LL	Horizontal	Horizontal	Swing
	Airflow direction setting				Set position
Stop (error)	Swing operation	OFF	Horizontal	Fully closed (horizontal)	—
	Airflow direction setting			Fully closed	
Overload thermostat OFF	Swing operation	LL	Horizontal	Horizontal	Swing
	Airflow direction setting				Set position

2.7 Indoor Unit Fan Control

Outline

During compressor start and stop control, the indoor fan will receive instruction from the outdoor unit in order to protect the compressor from receiving liquid and to assure a smooth compressor start up:

- Indoor fan control during compressor stop
- Indoor fan control before compressor startup
- Indoor fan control at compressor startup

During compressor stop

		Indoor fan tap
Indoor cooling / Automatic cooling	Thermostat OFF	Remote controller setting
	Remote controller OFF	OFF
Indoor heating / Automatic heating	Thermostat OFF	LL
	Remote controller OFF	OFF
Indoor drying	Thermostat OFF	OFF
	Remote controller OFF	OFF

Before compressor startup

	Indoor fan tap
Indoor cooling / Automatic cooling	Remote controller setting
Indoor heating / Automatic heating	OFF
Indoor drying	L

At compressor startup

- In heating: Hot startup control when performing a startup, or after the defrosting cycle has been completed, the indoor fan will be controlled as to prevent cold air draft and secure the starting performance (quick pressure build-up).

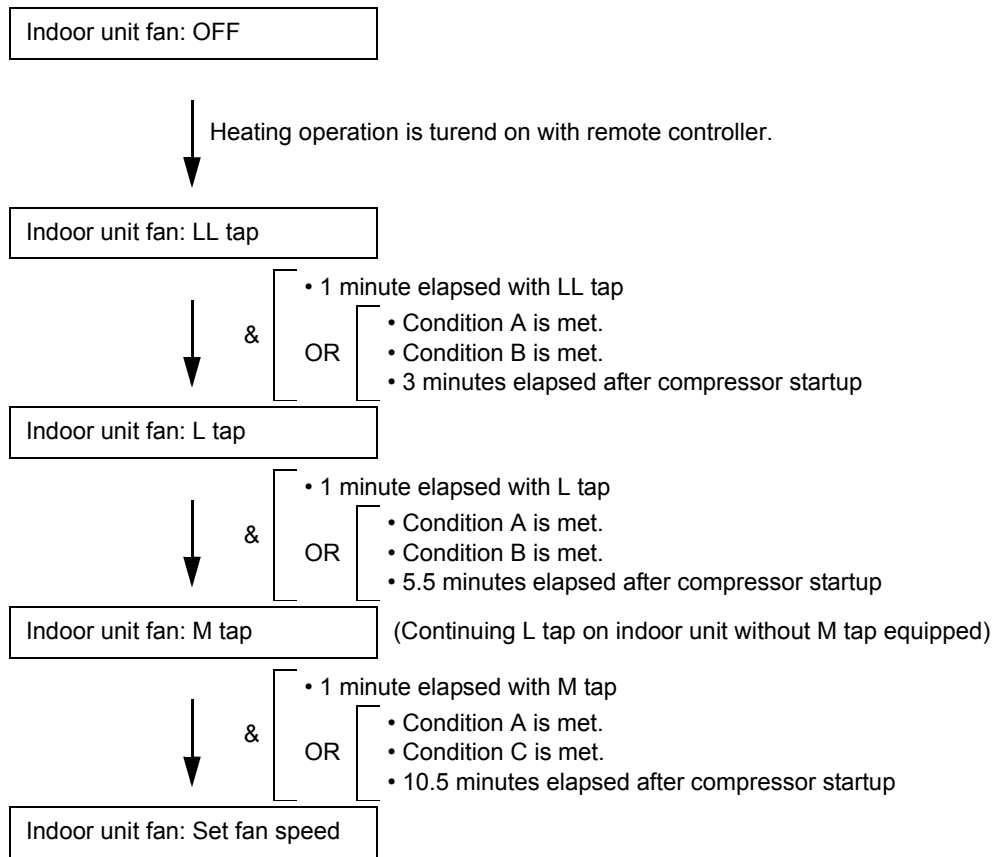

Condition	
A	Indoor unit h/e temp > 34°C
B	Indoor unit h/e temp > indoor suction air temp +17°C (+12°C if outside temperature is < 5°C)
C	Indoor unit h/e temp > indoor suction air temp +22°C (+20°C if outside temperature is < 5°C)

3. Outdoor Unit Functional Concept

3.1 Function Outline in Cooling Mode

Flow chart

Cooling/Dry operation

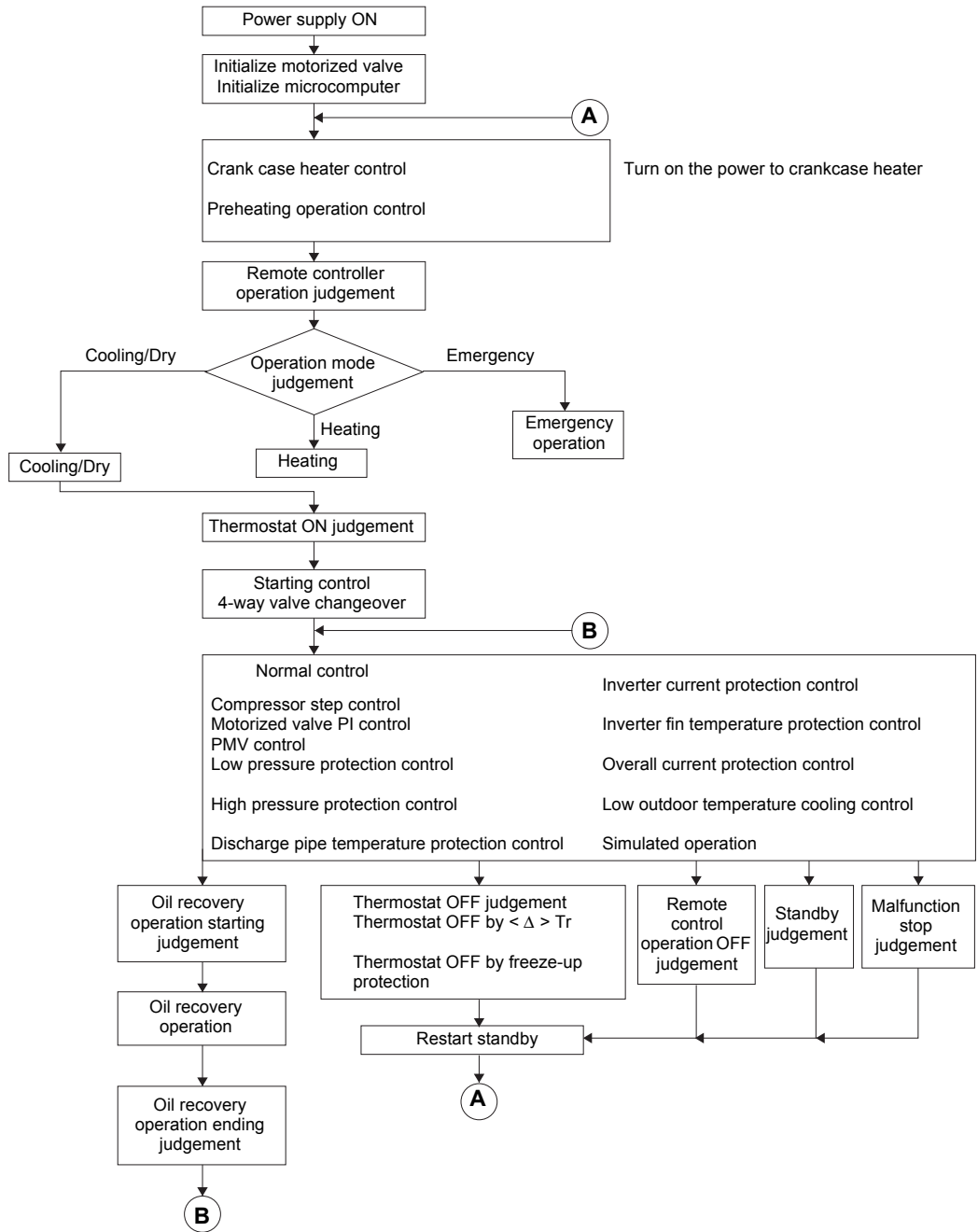

3.2 Function Outline in Heating Mode

Flow chart

Heating operation

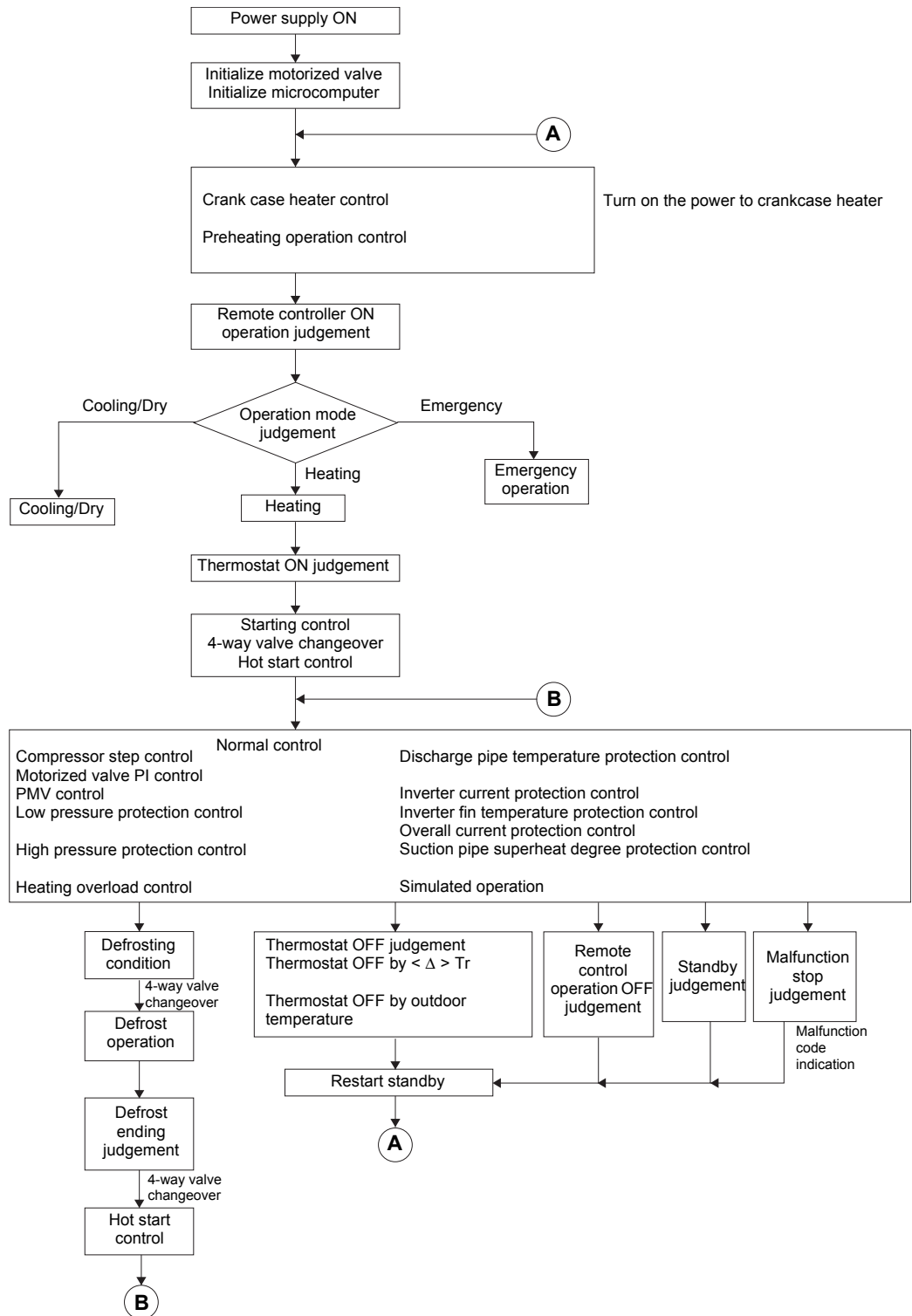

4. Frequency Regulating Functions

4.1 Starting Frequency Control

Outline The inverter compressor will start up with a limited fixed frequency value for a specified period of time in order to prevent liquid back to the compressor, and to limit the starting current.

General The normal starting control time is 2~3 minutes. The maximum starting frequency control time is limited to 10 minutes.

During compressor start-up, a pressure difference will be build up in order to have sufficient pressure difference for the 4-way valve to change over.

Graph

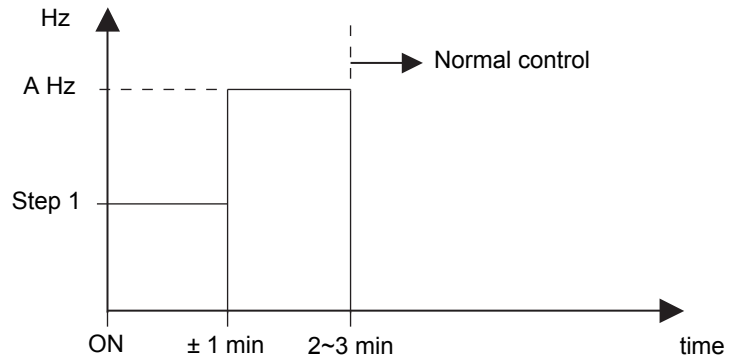

	1 phase	
	RZQ71D7V1B	RZQ100~140D7V1B
A Hz	73 Hz	112 Hz

Ending condition The starting control will be terminated when the low pressure value < 6 bar or when the maximum starting time of 10 minutes has been reached in case the low pressure value stays > 6 bar.

4.2 Starting Control

Starting control

When compressor start up, the starting frequency is fixed for specified period of time at low frequency to prevent returning of refrigerant.

- RZQ71~140D7V1B (1 phase)

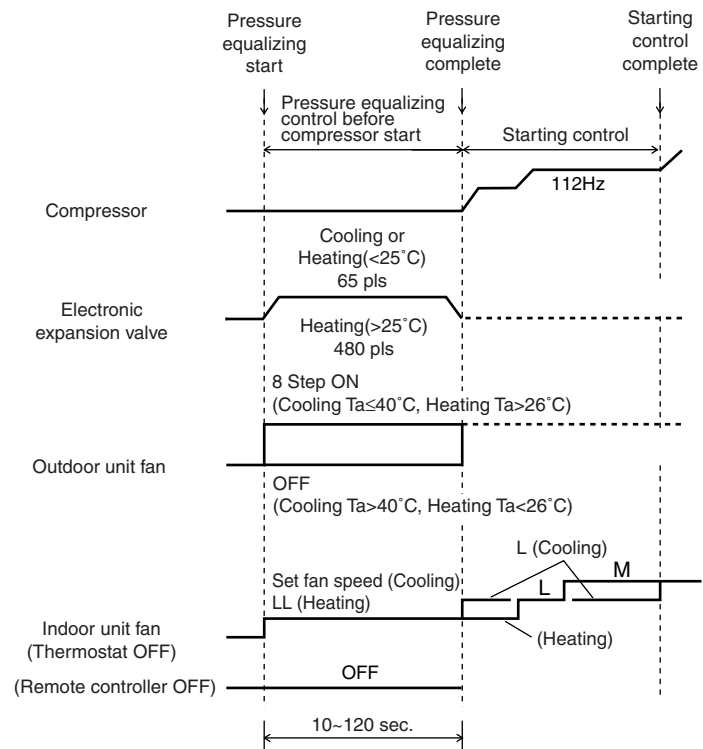

4.3 General Frequency Control

Outline	After the "Starting frequency control" function has been terminated, the ideal compressor frequency will be determined by the "General frequency control".
General	<p>The compressor operation frequency is controlled in order to keep a constant evaporation temperature in cooling and a constant condensing temperature in heating.</p> <p>The frequency can be changed every 20 seconds. The maximum frequency change = 2 steps/change. (= max 6 steps/min)</p> <p>During abnormal situations (e.g. inverter current protection) the change per step is also = 2 steps/change, but the 20 seconds interval may be decreased, so a quicker change is possible.</p>
Note	When other control functions are activated (e.g. discharge pipe control), they can change the compressor frequency using other inputs than the ones normally being used by the "General frequency control" function.
Cooling	<p>In cooling, the target operation frequency will be determined by the indoor Δt and the evaporating temperature.</p> <p>$\Delta t_{\text{cool}} = \text{Remote controller set temperature} - \text{Indoor return air temperature.}$</p> <p>Depending on the cooling load, the target evaporating temperature (T_e) will be a value between $2^\circ\text{C} \leq T_e \leq 20^\circ\text{C}$.</p>
Heating	<p>In heating, the target operation frequency will be determined by the indoor Δt and the condensing temperature.</p> <p>$\Delta t_{\text{heat}} = \text{Indoor return air temperature} - \text{Remote controller set temperature.}$</p> <p>Depending on the heating load, the target condensing temperature (T_c) will be a value between $42^\circ\text{C} \leq T_c \leq 54^\circ\text{C}$.</p>

Frequency steps

The operating frequency for the sky-air RZQ inverter units will be a value chosen from a list with fixed frequency settings that is programmed in the unit's memory:

Step No.	Compressor operation frequency	
	1 phase	
	RZQ71D7V1B	RZQ100~140D7V1B
1	32 Hz	32 Hz
2	35 Hz	36 Hz
3	38 Hz	41 Hz
4	41 Hz	44 Hz
5	44 Hz	48 Hz
6	48 Hz	52 Hz
7	52 Hz	57 Hz
8	57 Hz	62 Hz
9	62 Hz	67 Hz
10	67 Hz	72 Hz
11	73 Hz	78 Hz
12	79 Hz	84 Hz
13	85 Hz	90 Hz
14	91 Hz	94 Hz
15	97 Hz	98 Hz
16	103 Hz	102 Hz
17	109 Hz	107 Hz
18	116 Hz	112 Hz
19	119 Hz	117 Hz
20	122 Hz	123 Hz
21	139 Hz	131 Hz
22	141 Hz	139 Hz
23	148 Hz	147 Hz
24	155 Hz	155 Hz
25	162 Hz	164 Hz
26	169 Hz	—
27	—	—

: Maximum frequency in cooling

4.4 Low Pressure Protection Control

In order to prevent abnormal low pressures in the system, the below control function will be activated. Low pressure is detected by the low pressure sensor.

■ RZQ71D7V1B

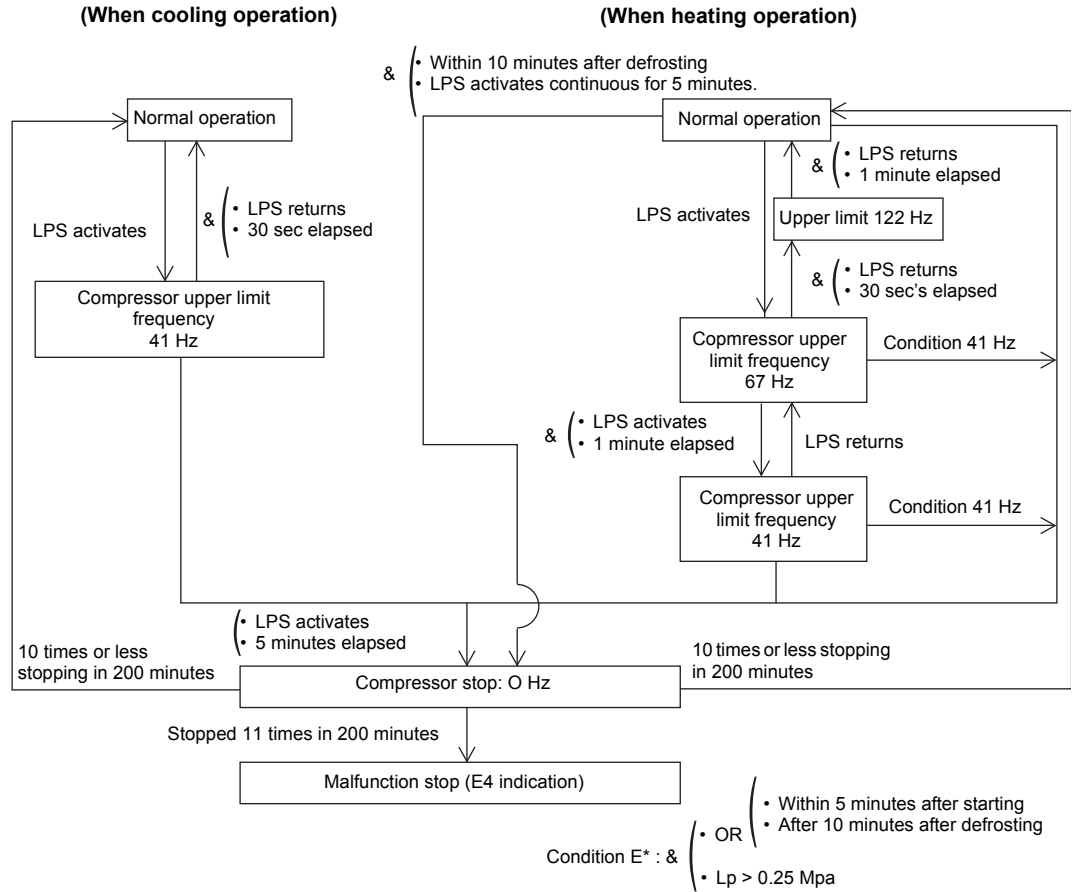

■ RZQ100~140D7V1B

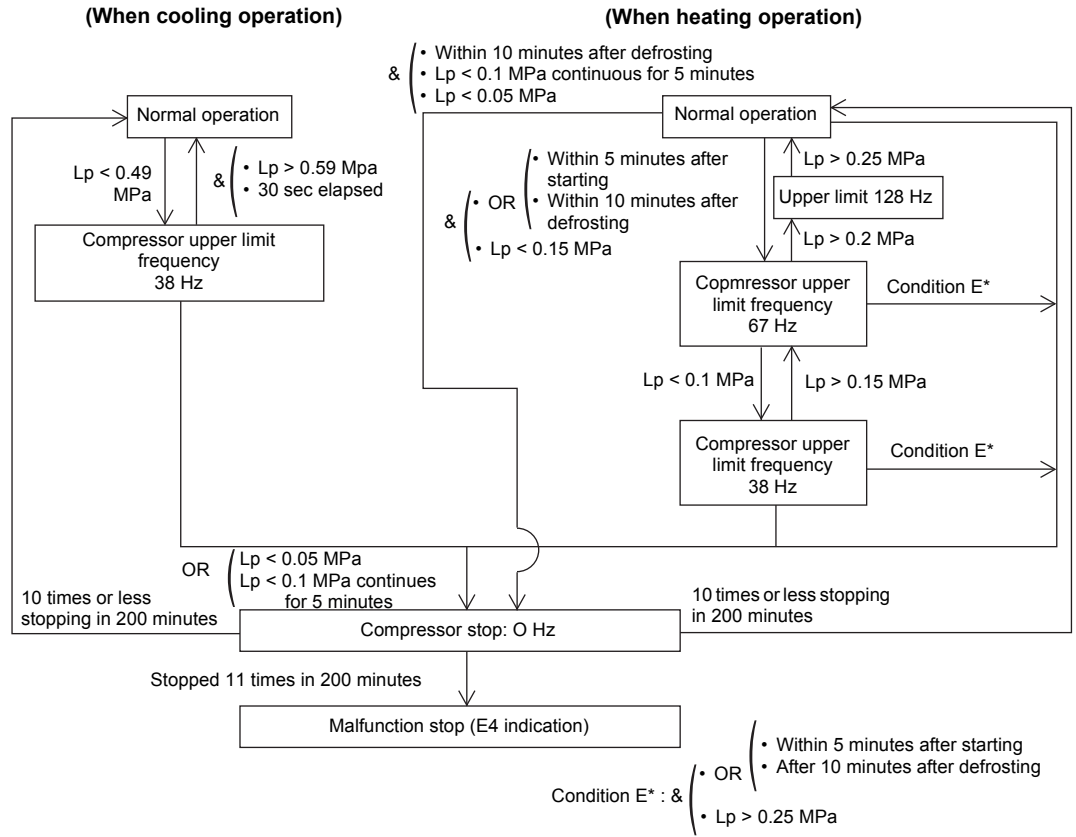

4.5 High Pressure Protection Control

Outline

In order to prevent abnormal high pressures in the system and hence avoiding activation of the high pressure safety device the below control function will be activated.

Details

The high pressure value will be calculated from the low pressure, power input and compressor frequency. In case of RZQ100~140D7V1B, low pressure is a calculated value.

- HPS opens at : 40 bar (tolerance: +0 / -0.15)
- HPS closes at : 30 bar (tolerance : +/- 0.15)

Flow chart

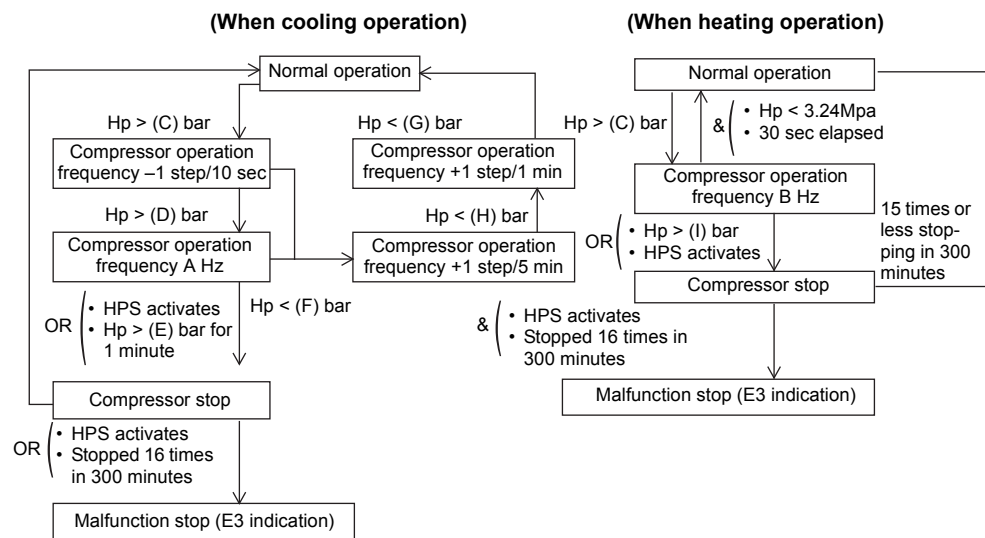

Parameters

	1 phase	
	RZQ71	RZQ100~140
A Hz	79 Hz	62 Hz
B Hz	62 Hz	62 Hz
C bar	35.3 bar	36.8 bar
D bar	36.3 bar	37.7 bar
E bar	38.2 bar	39.2 bar
F bar	34.8 bar	36.3 bar
G bar	32.9 bar	34.3 bar
H bar	33.8 bar	35.8 bar
I bar	38.2 bar	39.2 bar

As the bearing resistance limit pressure decreases during slow operation of the compressor, the lower limit of frequency is restricted.

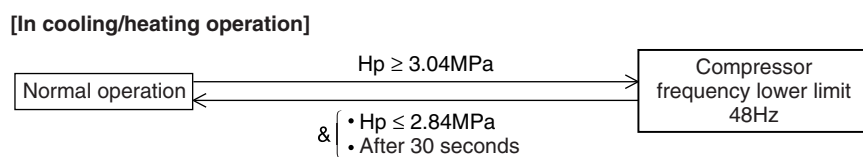

4.6 Discharge Pipe Temperature Control

Outline

The compressor operating frequency will be controlled in order to avoid abnormal high compressor temperatures (see also expansion valve control).

Flow chart

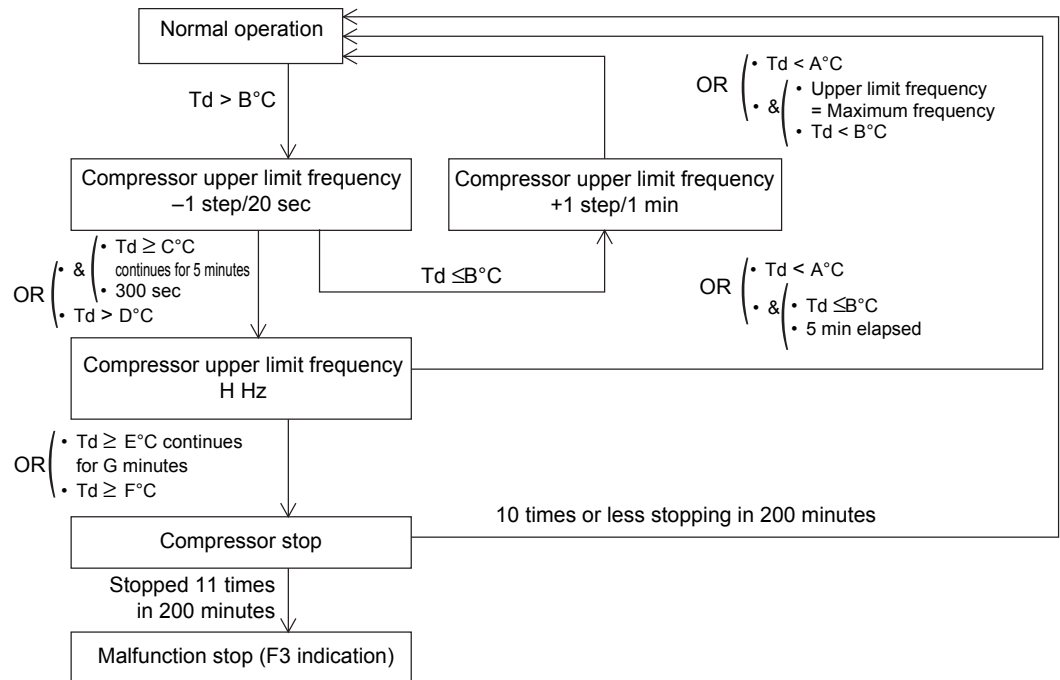

Parameters

	1 phase	
	RZQ71	RZQ100~140
A°C	100°C	100°C
B°C	105°C	105°C
C°C	110°C	110°C
D°C	115°C	120°C
E°C	105°C	115°C
F°C	120°C	135°C
Gmin	15min	10min
H Hz	79Hz	62Hz

Td = Discharge pipe temperature

4.7 Suction Pipe Superheat Protection Control (Heating Mode)

Outline

In case the suction superheat value in heating mode is too high, the oil return to the compressor will be insufficient. In order to avoid that the compressor oil will be accumulated in the outdoor unit heat exchanger, the upper limit frequency will be decreased.

Flow chart

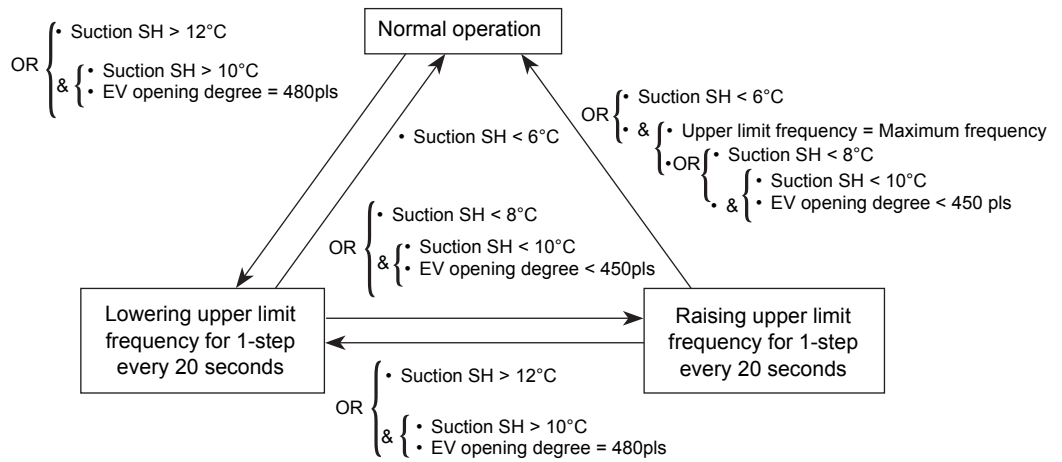

4.8 Inverter Current Protection Control

4.8.1 Control by inverter fin temperature

Restricts compressor operation upper limit frequency to prevent compressor from tripping due to inverter fin temperature.

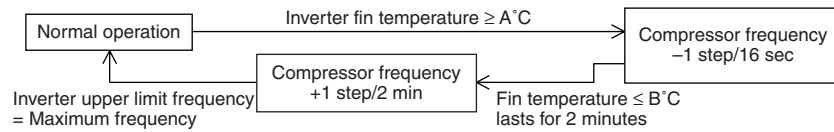

	1 phase	3 phase
A	84	80
B	81	77

4.8.2 Inverter current protection control

Restricts compressor operation frequency to prevent compressor from tripping due to inverter overcurrent.

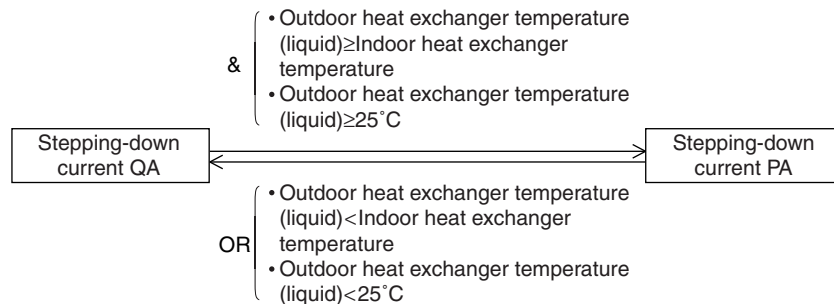
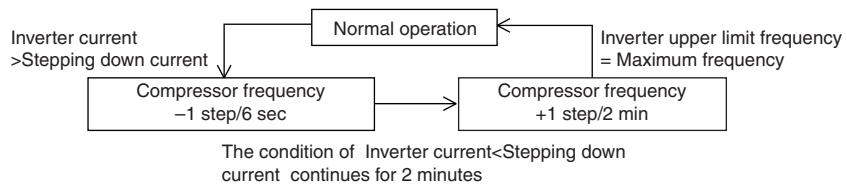

	1 phase	
	RZQ71	RZQ100~140
PA	11.7 A	20 A
QA	12.9 A	20 A

4.9 Protection Control by Overall Current

Monitors the overall current and restricts the upper limit compressor operating frequency to prevent circuit breakers from exceeding the rated capacity.

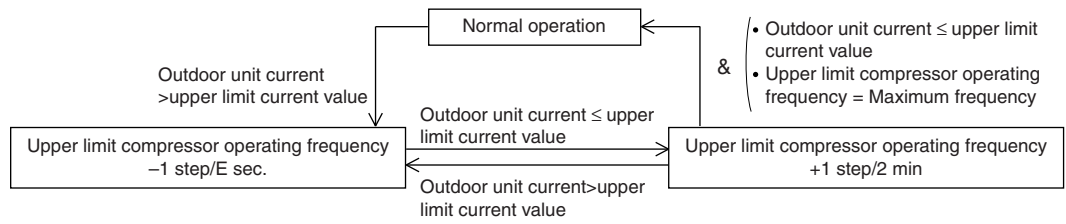

Upper limit current (A)

Takes the following values depending on the outside temperature. Also varies depending on model.

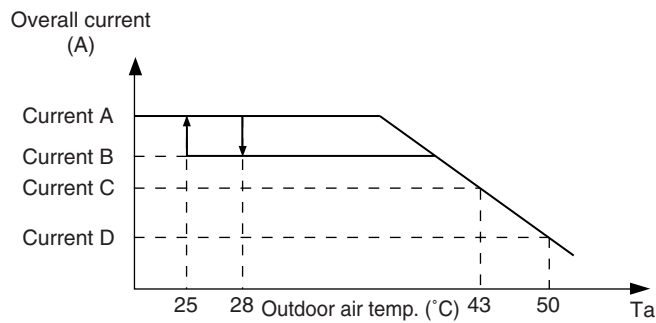

	1 phase	
	RZQ71	RZQ100~140
A	16.5 A	24.0 A
B	16.5 A	24.0 A
C	14.2 A	23.0 A
D	8.4 A	16.0 A
E	6 (sec.)	10 (sec.)

4.10 Inverter Cooling Fin Temperature Control

Outline

This control will restrict the compressor upper limit frequency in order to protect the electronic components in the switch box from overheating (L4-error activation).

By lowering the compressor frequency, the current drawn by the compressor will be reduced and as a result the temperature inside the switch box will drop.

Flow chart

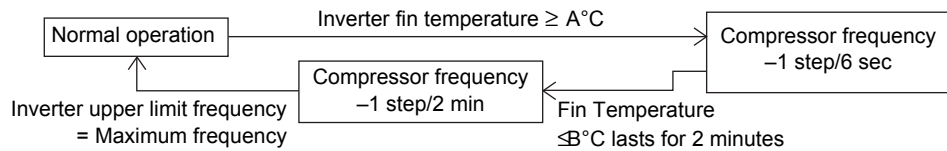

Parameters

	1 phase	
	RZQ71	RZQ100~140
A°C	82°C	83°C
B°C	79°C	80°C

4.11 Pressure Difference Control

Outline

To ensure the compression ratio (pressure difference between high and low pressure) at low outdoor temperature conditions in cooling mode and high outdoor temperature conditions in heating mode, the outdoor fan and target compressor frequency may be varied.

Cooling

In cooling low ambient conditions, the outdoor fan speed and compressor frequency will be adapted to secure the differential pressure between high and low pressure.

Fan control in cooling

■ B : RZQ71

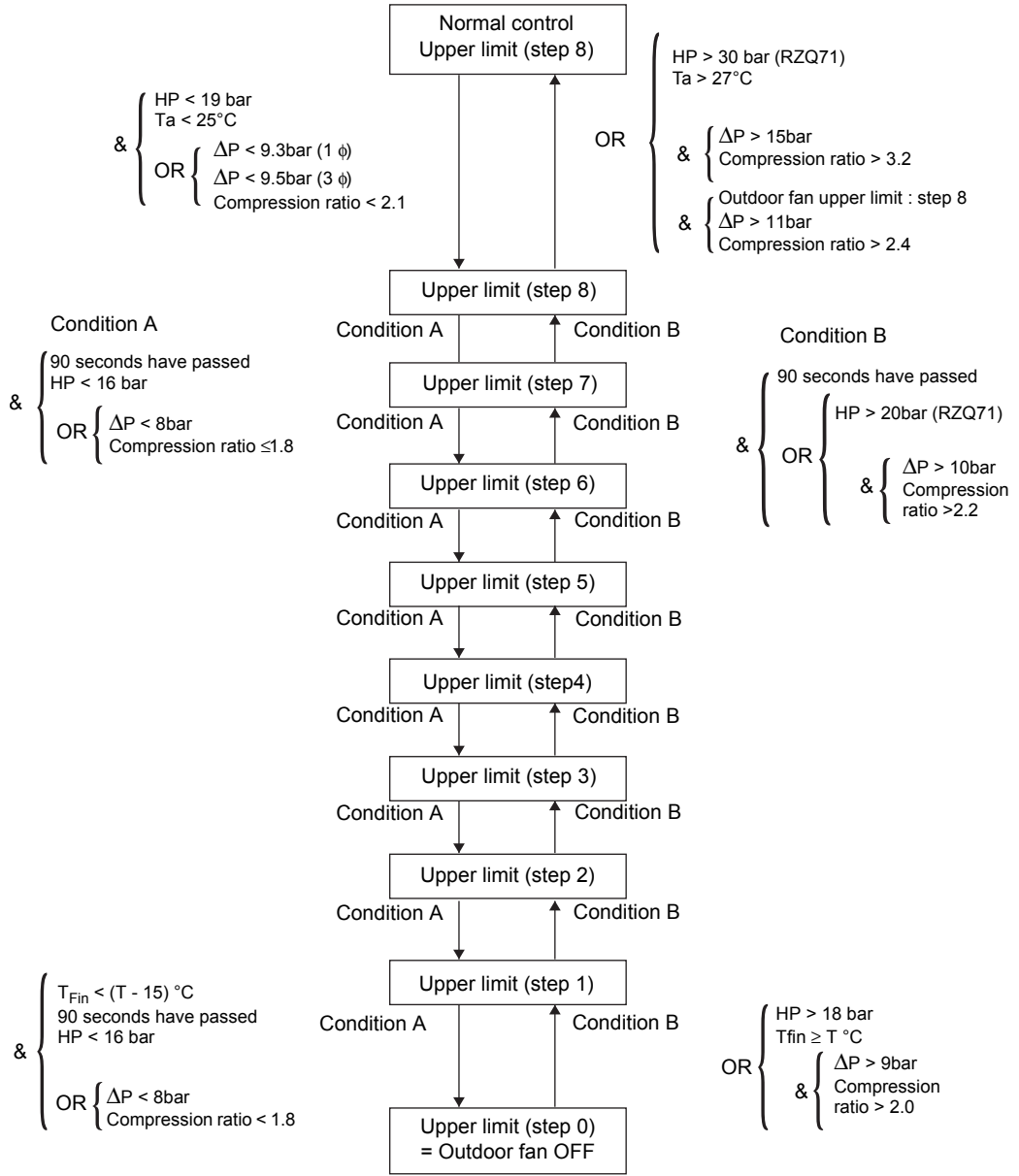

Parameters

	1 phase
	RZQ71
T°C	79°C

■ C : RZQ100~140

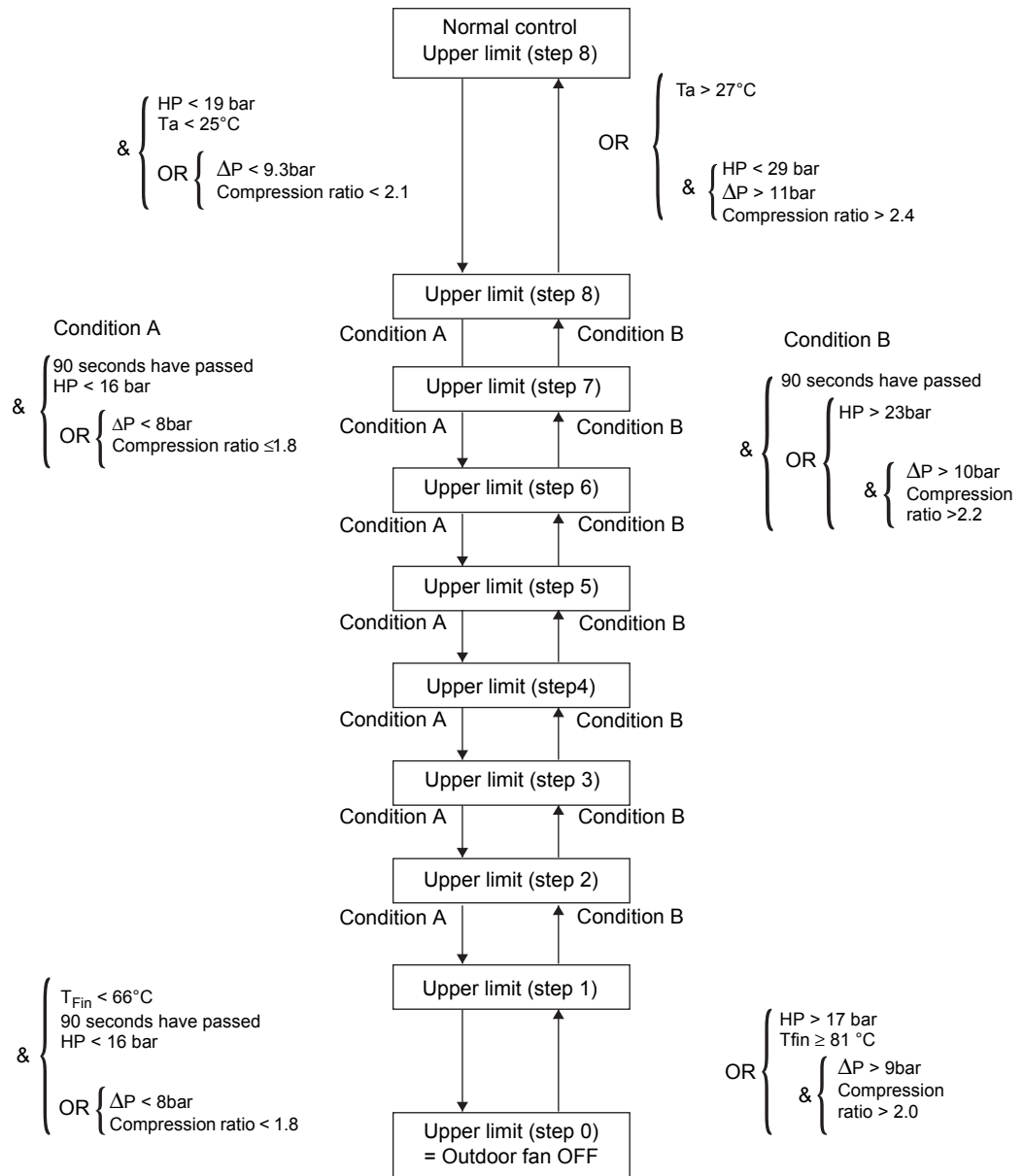

Frequency restriction in cooling

■ RZQ100~140

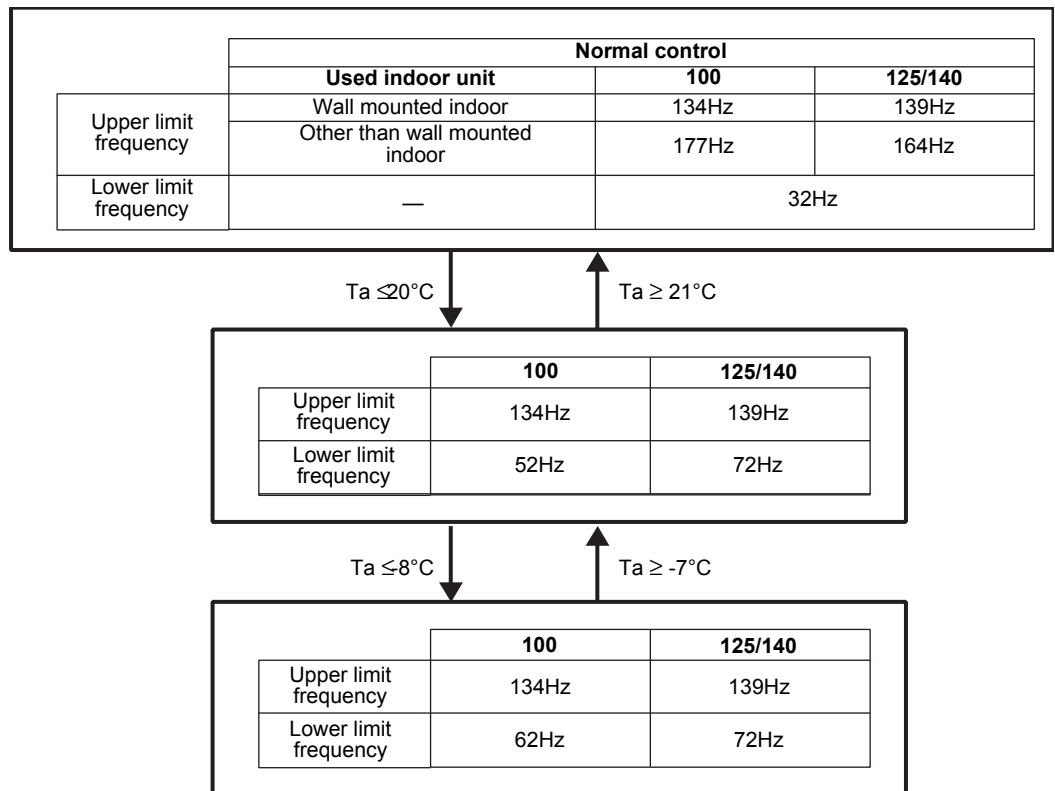

■ RZQ71

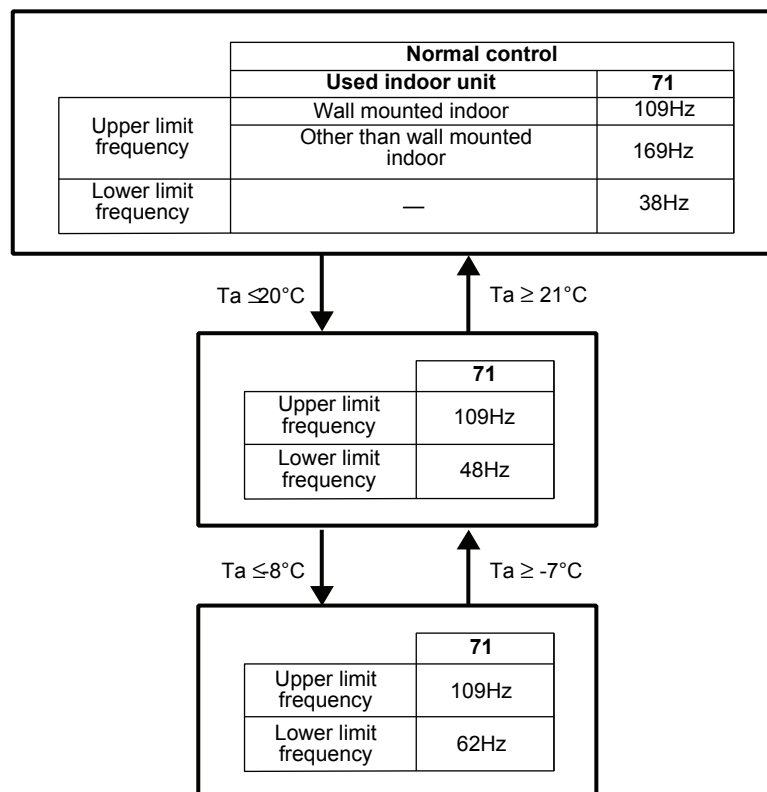

Heating

High outdoor ambient (overload conditions):

In heating overload conditions, the outdoor fan speed will be adapted to secure the differential pressure between high and low pressure.

■ RZQ100~140

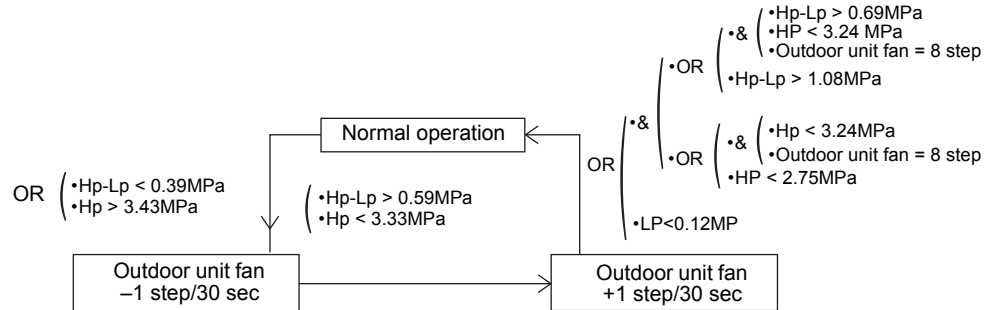

■ RZQ71

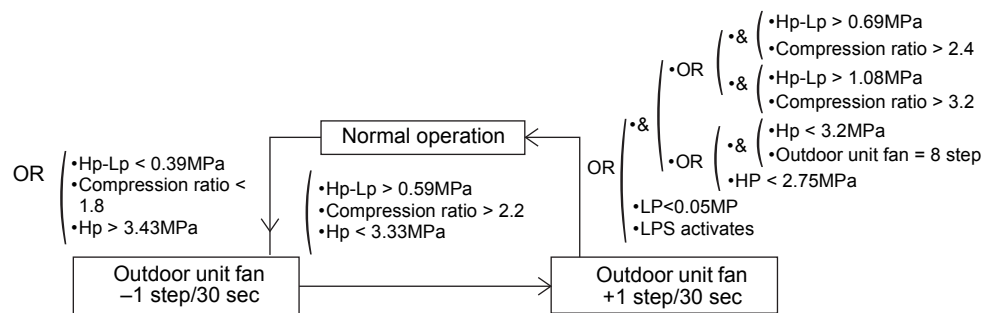

Only the fan speed will be adapted in heating overload conditions. No adjustments to the compressor frequency will be made.

4.12 Oil Recovery Operation

Outline

When the compressor operates for a certain period of time at low frequency, the oil level in the compressor may become low due to incomplete oil return. To prevent damage to the compressor and in worst case avoid compressor lock, an oil recovery operation will be conducted.

Details

During the oil recovery operation, the operation frequency of the compressor will be increased for a time period of 5 minutes. Oil recovery operation is only executed in cooling mode. In heating mode, oil return to the compressor is guaranteed by the defrost operation.

5. Expansion Valve Regulating Functions

5.1 Expansion Valve Control at Startup

Outline Before going to the general expansion valve control, the expansion valve opening will be limited in order to avoid the risk of liquid back and allow quick build up of pressure difference.

Details During startup, the opening degree is determined by both the compressor frequency & the suction superheat. During startup, it is not possible to use only the value of the suction superheat because the operation is not stable yet. As a consequence also the SH value will not be stable.

Graph

■ RZQ71

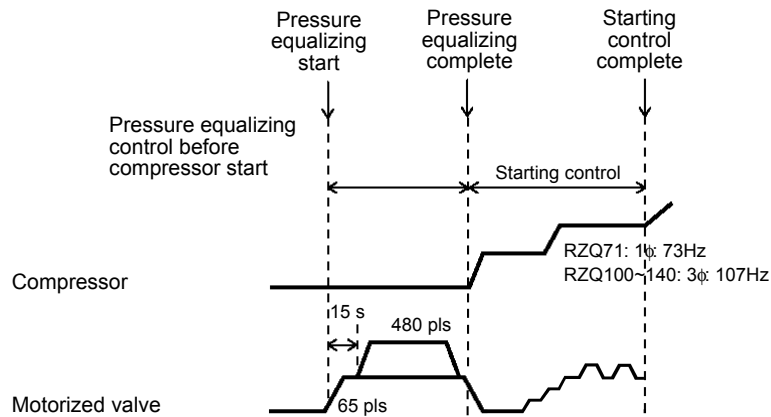

■ RZQ100~140

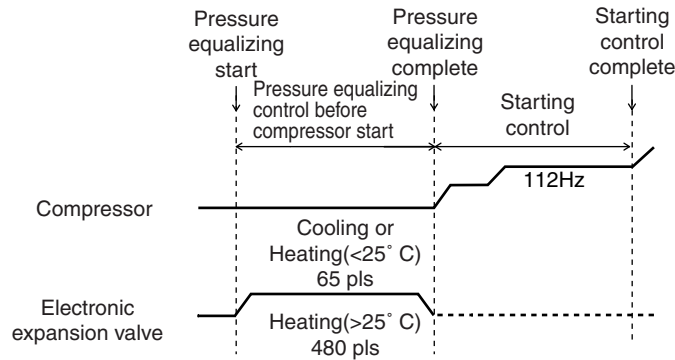

Expansion valve opening during pressure equalization

On RZQ71 units (using double swing compressor) the expansion valve will be fully opened (to 480 pulses) for pressure equalisation before compressor start-up. Just before compressor start up, the expansion valve opening will be set to 65 pulses, same as for the RZQ100~140 class.

Ending condition

The starting control will be terminated when the low pressure value < 6 bar or when the maximum starting time of 10 minutes has been reached in case the low pressure value stays > 6 bar.

5.2 General Expansion Valve Control

Outline	<p>After the start up control function has been terminated the general expansion valve control function will regulate the expansion valve opening in function of the target suction SH value.</p> <p>The discharge SH value will be used to set the target SH value.</p> <p>The measured suction SH value will be used to control the opening of the expansion to the target SH value.</p>
Details	<p>When the unit is in cooling or heating operation the opening of the expansion valve will be controlled in order to keep the amount of superheat at the evaporator outlet constant. This way the evaporator can be used at maximum efficiency under all conditions. The initial target heat exchanger outlet superheat value = 5°C.</p> <p>The target heat exchanger outlet superheat value can be increased in case the discharge superheat value decreases.</p> <p>The target heat exchanger outlet superheat value can be decreased in case the discharge superheat value increases.</p>
Control	<p>During normal control 2 situations can decide on the expansion valve opening degree:</p> <ol style="list-style-type: none"> 1. Target superheat amount: <ul style="list-style-type: none"> When the target heat exchanger outlet superheat > actual heat exchanger outlet superheat --> the expansion valve will close. When the target heat exchanger outlet superheat < actual heat exchanger outlet superheat --> the expansion valve will open. The superheat amount is checked every 10 seconds. 2. Frequency change: At the time of compressor frequency change, the expansion valve opening will be changed with a fixed value. This value will be in function of the amount of compressor frequency change.
Calculations RZQ71	<p>The heat exchanger outlet superheat value is calculated from the saturated suction temperature T_e (using LP sensor) and the suction pipe temperature $R4T$: $SH = R4T - T_e$</p> <p>The discharge superheat value is calculated from the saturated discharge temperature T_d (HP value calculated out of PI, frequency and LP) and the discharge pipe temperature $R3T$: $SH = R3T - T_d$</p>
Calculations RZQ100~140	<p>The heat exchanger outlet superheat value is calculated from the saturated suction temperature T_e (using indoor coil sensor in cooling, outdoor coil sensor in heating) and the suction pipe temperature $R4T$: $SH = R4T - T_e$</p> <p>The discharge superheat value is calculated from the saturated discharge temperature T_d (HP value calculated out of PI, frequency and T_e) or T_c and the discharge pipe temperature $R3T$: $SH = R3T - T_d$ or $R3T$ or $SH = R3T - T_c$ (whichever is the lowest)</p>

5.3 Discharge Pipe Temperature Protection Control

Outline

The expansion valve opening will be controlled in order to avoid abnormal high compressor discharge temperatures (see also compressor operating frequency control).

Details

■ RZQ71

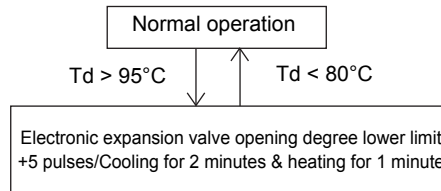

■ RZQ100~140

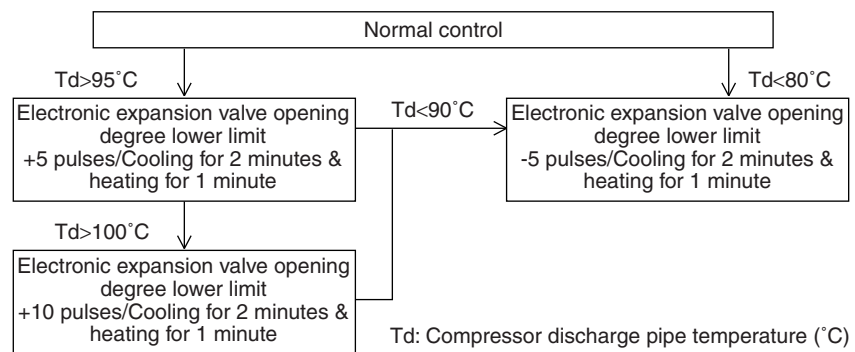

6. Outdoor Unit Fan Speed Control

6.1 Outdoor Unit Fan Speed Control

Fan speed control

The outdoor fan speed will be controlled in function of the actual outdoor ambient temperature, the condensation pressure, pressure difference between low and high pressure and compression ratio.

For details please refer to "Pressure Difference Control".

Fan step table RZQ71

Step	Cooling	Heating
0	0 rpm	0 rpm
1	200 rpm	200 rpm
2	250 rpm	250 rpm
3	300 rpm	300 rpm
4	360 rpm	360 rpm
5	430 rpm	430 rpm
6	515 rpm	515 rpm
7	620 rpm	715 rpm
8	818 rpm	738 rpm

Fan step table RZQ100~140

Step	Cooling		Heating	
	M1F	M2F	M1F	M2F
0	0 rpm	0 rpm	0 rpm	0 rpm
1	250 rpm	0 rpm	250 rpm	0 rpm
2	400 rpm	0 rpm	285 rpm	250 rpm
3	285 rpm	250 rpm	335 rpm	300 rpm
4	360 rpm	325 rpm	395 rpm	360 rpm
5	445 rpm	410 rpm	470 rpm	435 rpm
6	545 rpm	510 rpm	560 rpm	525 rpm
7	660 rpm	625 rpm	660 rpm	625 rpm
8	850 rpm	815 rpm	842 rpm	807 rpm



Note: Refer to "Pressure Difference Control" on P67
Refer to "Defrost Operation" on P40

Part 5

Test Operation

1. Test Operation	76
1.1 Test Run Checks	76
1.2 Setting the Wireless Remote Controller	77
2. Field Settings	81
2.1 How to Change the Field Settings with the Wired Remote Controller	81
2.2 Field Setting from Remote Controller	83
2.3 How to Change the Field Settings with the Wireless Remote Controller	85
2.4 Overview of the Field Settings on the Indoor Units	86
2.5 Overview of the Factory Settings on the Indoor Units	87
2.6 MAIN/SUB Setting when Using Two Remote Controllers	88
2.7 Setting the Centralized Group No.	89
2.8 The Field Setting Levels	91
2.9 Overview of the Field Settings on the Outdoor Units	94
2.10 Overview of the Factory Settings on the Outdoor Units	94
2.11 Existence of DIP Switch and BS Button	95
2.12 Quiet (Low Noise) Operation	101
2.13 I-Demand Function	103
2.14 Setting for Low Humidity Application	105
2.15 Defrost Start Setting	110
3. Test Run and Operation Data	111
3.1 General Operation Data	111
3.2 Operation Range	114

1. Test Operation

1.1 Test Run Checks

1.1.1 Checks before Test Run

Before carrying out a test run, proceed as follows:

Step	Action
1	Make sure the voltage at the primary side of the safety breaker is: <ul style="list-style-type: none"> ● 230 V \pm 10% for 1-phase units ● 400 V \pm 10% for 3-phase units
2	Fully open the liquid and the gas stop valve.

1.1.2 Test Run Checks

To carry out a test run, check the following:

- Check that the temperature setting of the remote controller is at the lowest level in cooling mode or use test mode.
- Go through the following checklist:

Checkpoints	Cautions or warnings
Are all units securely installed?	<ul style="list-style-type: none"> ● Dangerous for turning over during storm. ● Possible damage to pipe connections.
Is the earth wire installed according to the applicable local standard?	Dangerous if electric leakage occurs.
Are all air inlets and outlets of the indoor and outdoor units unobstructed?	<ul style="list-style-type: none"> ● Poor cooling. ● Poor heating.
Does the drain flow out smoothly?	Water leakage.
Is piping adequately heat-insulated?	Water leakage.
Have the connections been checked for gas leakage?	<ul style="list-style-type: none"> ● Poor cooling. ● Poor heating. ● Stop.
Is the supply voltage conform to the specifications on the name plate?	Incorrect operation.
Are the cable sizes as specified and according to local regulations?	Damage of cables.
Are the remote controller signals received by the unit?	No operation.

1.2 Setting the Wireless Remote Controller

Introduction

To set the wireless remote controller, you have to set the address for:

- The receiver of the wireless remote controller
- The wireless remote controller.

Setting the address for the receiver

The address for the receiver of the wireless remote controller is factory set to 1. To change this setting, proceed as follows:

Step	Action																	
1	Turn OFF the power.																	
2	Remove the sealing pad on the top of the receiver. <div style="text-align: center;"> </div>																	
3	Set the wireless address switch (SS2) according to the table below. You can find the wireless address switch attached on the PCB of the receiver and it is visible through the small opening on the back of the receiver. <table border="1" style="margin: 10px auto;"> <thead> <tr> <th>Unit No.</th> <th>No. 1</th> <th>No. 2</th> <th>No. 3</th> </tr> </thead> <tbody> <tr> <td>SS2</td> <td style="text-align: center;"> <table border="1"> <tr><td style="background-color: black;">1</td></tr> <tr><td>2</td></tr> <tr><td>3</td></tr> </table> </td> <td style="text-align: center;"> <table border="1"> <tr><td>1</td></tr> <tr><td style="background-color: black;">2</td></tr> <tr><td>3</td></tr> </table> </td> <td style="text-align: center;"> <table border="1"> <tr><td>1</td></tr> <tr><td>2</td></tr> <tr><td style="background-color: black;">3</td></tr> </table> </td> </tr> </tbody> </table>	Unit No.	No. 1	No. 2	No. 3	SS2	<table border="1"> <tr><td style="background-color: black;">1</td></tr> <tr><td>2</td></tr> <tr><td>3</td></tr> </table>	1	2	3	<table border="1"> <tr><td>1</td></tr> <tr><td style="background-color: black;">2</td></tr> <tr><td>3</td></tr> </table>	1	2	3	<table border="1"> <tr><td>1</td></tr> <tr><td>2</td></tr> <tr><td style="background-color: black;">3</td></tr> </table>	1	2	3
Unit No.	No. 1	No. 2	No. 3															
SS2	<table border="1"> <tr><td style="background-color: black;">1</td></tr> <tr><td>2</td></tr> <tr><td>3</td></tr> </table>	1	2	3	<table border="1"> <tr><td>1</td></tr> <tr><td style="background-color: black;">2</td></tr> <tr><td>3</td></tr> </table>	1	2	3	<table border="1"> <tr><td>1</td></tr> <tr><td>2</td></tr> <tr><td style="background-color: black;">3</td></tr> </table>	1	2	3						
1																		
2																		
3																		
1																		
2																		
3																		
1																		
2																		
3																		
4	If you use a wired and a wireless remote controller for one indoor unit, proceed as follows: <ol style="list-style-type: none"> 1. Set the wired remote controller to MAIN: On the remote controller. 2. Set the wireless remote controller to SUB: On the receiver with the MAIN/SUB switch (SS1). <table border="1" style="margin: 10px auto;"> <thead> <tr> <th>MAIN/SUB</th> <th>MAIN</th> <th>SUB</th> </tr> </thead> <tbody> <tr> <td>SS1</td> <td style="text-align: center;"> <table border="1"> <tr><td>S</td></tr> <tr><td style="background-color: black;">M</td></tr> </table> </td> <td style="text-align: center;"> <table border="1"> <tr><td style="background-color: black;">S</td></tr> <tr><td>M</td></tr> </table> </td> </tr> </tbody> </table>	MAIN/SUB	MAIN	SUB	SS1	<table border="1"> <tr><td>S</td></tr> <tr><td style="background-color: black;">M</td></tr> </table>	S	M	<table border="1"> <tr><td style="background-color: black;">S</td></tr> <tr><td>M</td></tr> </table>	S	M							
MAIN/SUB	MAIN	SUB																
SS1	<table border="1"> <tr><td>S</td></tr> <tr><td style="background-color: black;">M</td></tr> </table>	S	M	<table border="1"> <tr><td style="background-color: black;">S</td></tr> <tr><td>M</td></tr> </table>	S	M												
S																		
M																		
S																		
M																		
5	Seal off the opening of the address switch and the MAIN/SUB switch with the attached sealing pad. <div style="text-align: center;"> </div>																	
6	Make sure to also change the address on the remote controller.																	

Setting the address for the wireless remote controller

The address for the wireless remote controller is factory set to 1. To change this setting, proceed as follows:

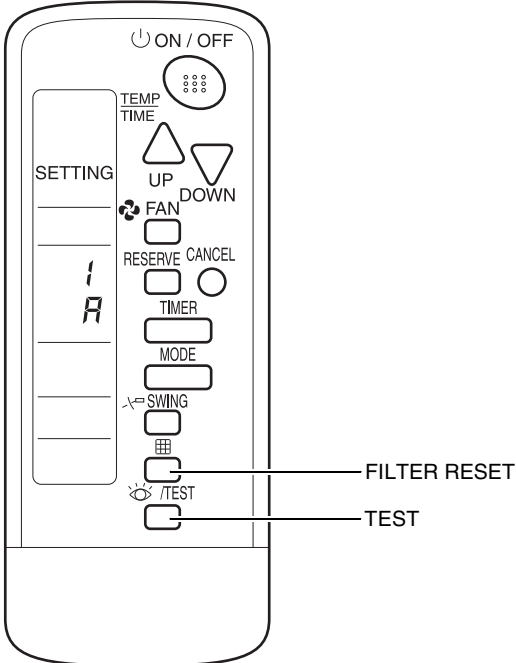
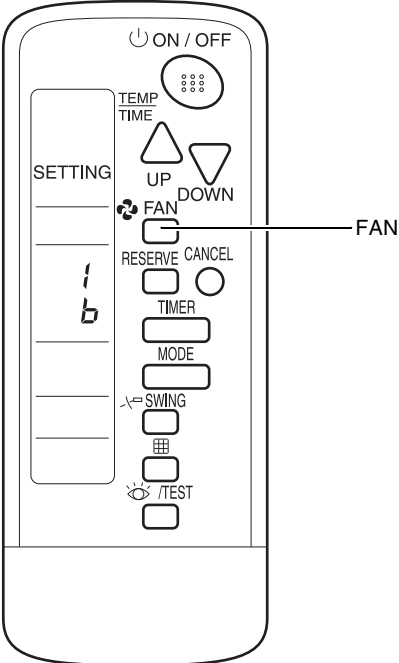
Step	Action
1	<p>Hold down the FILTER RESET button and the TEST button for at least 4 s, to go to field set mode. The display indicates the field set mode.</p>  <p>The diagram shows a remote controller with a display showing '1 A'. The 'FILTER RESET' button (a button with a grid icon) and the 'TEST' button (a button with a lightbulb icon) are highlighted with lines pointing to their labels.</p>
2	<p>Press the FAN button to select a multiple setting (A/b), see 'Multiple settings A/b' further in this section. Each time you press the button, the display switches between "A" and "b".</p>  <p>The diagram shows the same remote controller, but the display now shows '1 b'. The 'FAN' button (a button with a fan icon) is highlighted with a line pointing to its label.</p>

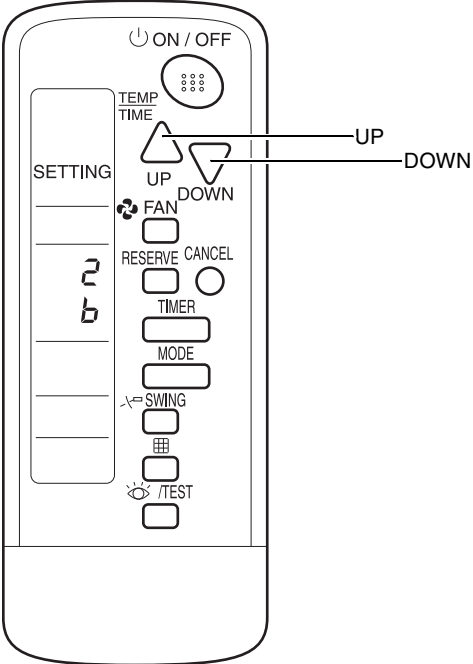
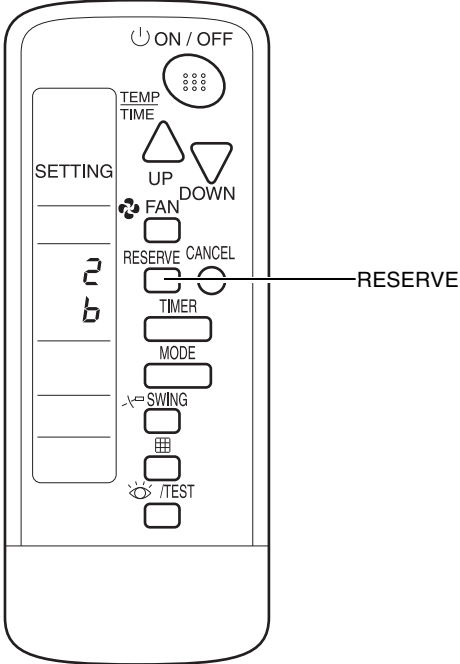
Step	Action
<p>3</p>	<p>Press the UP and DOWN buttons to set the address. Set the same address as the receiver (1, 2 or 3). The receiver does not work with addresses 4, 5 and 6.</p>  <p>The diagram shows a remote control with a digital display showing '2' and 'b'. The 'UP' and 'DOWN' buttons are highlighted with arrows and labels. Other buttons include ON/OFF, TEMP TIME, FAN, RESERVE, CANCEL, TIMER, MODE, SWING, and /TEST.</p>
<p>4</p>	<p>Press the RESERVE button to confirm the setting.</p>  <p>The diagram shows the same remote control as in step 3, but with the 'RESERVE' button highlighted by an arrow and label. The display still shows '2' and 'b'.</p>

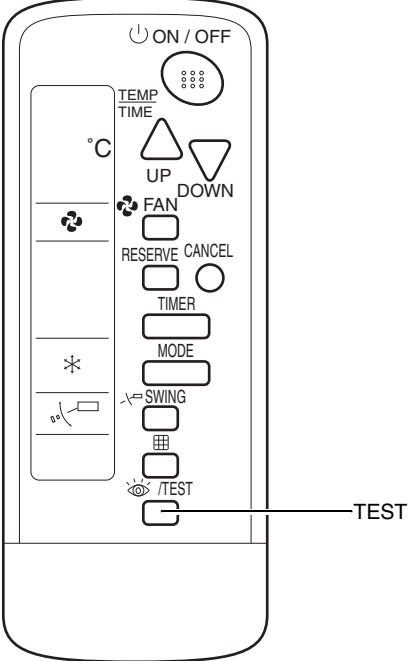
Step	Action
5	<p>Press the TEST button to quit the field set mode and return to the normal display.</p> 

**Multiple settings
A/b**

When an outside control (central remote controller...) controls an indoor unit, sometimes the indoor unit does not respond to ON/OFF and temperature settings commands from this controller.

Remote controller		Indoor unit	
Setting	Remote controller display	Control of other air conditioners and units	No other control
A: Standard	All items are displayed.	Commands other than ON/OFF and temperature setting accepted. (1 long beep or 3 short beeps emitted)	
b: Multi System	Only one item is displayed. This item is only shown for a few seconds.	All commands accepted (2 short beeps)	

2. Field Settings

2.1 How to Change the Field Settings with the Wired Remote Controller

Installation conditions

The field settings have to be changed with the remote controller according to the installation conditions.

Wired remote controller (BRC1D527)

The illustration below shows the wired remote controller.

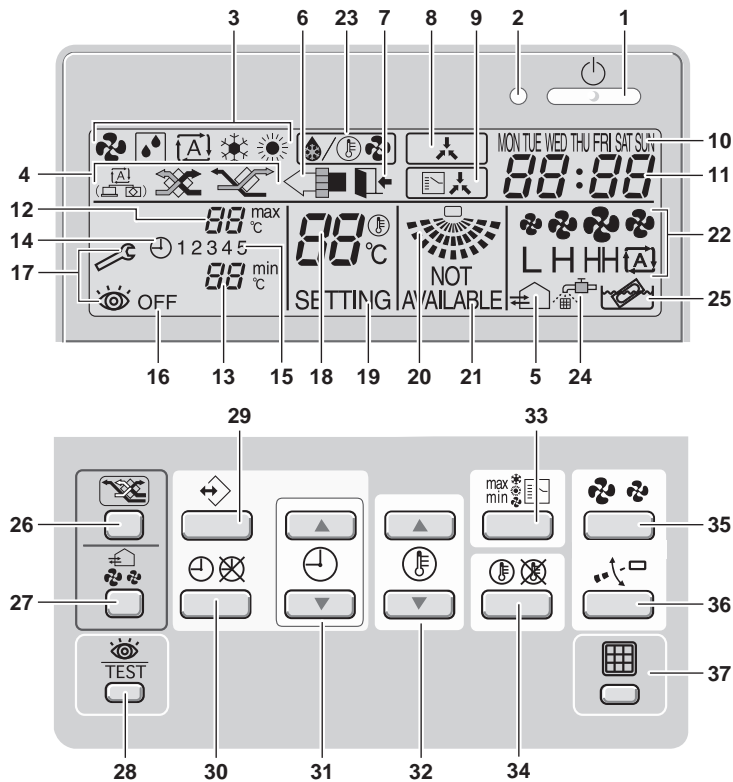

Components

The table below contains the components of the wired remote controller.

No.	Component	No.	Component
1	ON/OFF button	20	Air flow direction icon
2	Operation lamp	21	Not available
3	Operation mode icon	22	Fan speed icon
4	Ventilation mode icon	23	Defrost/hotstart mode icon
5	Ventilation icon	24	Air filter cleaning time icon
6	Air cleaning icon	25	Element cleaning time icon
7	Leave home icon	26	Ventilation mode button
8	External control icon	27	Ventilation amount button
9	Change-over under centralised control icon	28	Inspection/test operation button
10	Day of the week indicator	29	Programming button
11	Clock display	30	Schedule timer button
12	Maximum set temperature	31	Time adjust button
13	Minimum set temperature	32	Temperature adjust buttons
14	Schedule timer icon	33	Operation change/ button
15	Action icons	34	Setpoint/limit button
16	Off icon	35	Fan speed button
17	Inspection required	36	Air flow direction adjust button
18	Set temperature display	37	Air filter cleaning time icon reset
19	Setting		

Setting

To set the field settings, you have to change:

- “Mode No.”
- “First code No.”
- “Second code No.”.

To change the field settings, proceed as follows:

Step	Action
1	Hold down the INSPECTION/TEST button for at least 4 s during normal mode to enter the “Field setting mode”.
2	Press the TEMPERATURE CONTROL button until the desired “Mode No.” appears.
3	<ul style="list-style-type: none"> ■ If the indoor unit is under group control, all settings for all the indoor units are set at the same time. Use the codes 10 to 15 to apply this group control and proceed to the next step. ■ If you want to set the indoor units of one group individually or if you want to read out the last settings, use the codes 20 to 25 which are displayed in brackets. Press the TIMER SELECTION button to select the “Indoor unit No.” for which you want to adjust the field settings.
4	Press the upper part of the PROGRAMMING TIME button to select the “First code No.”.
5	Press the lower part of the PROGRAMMING TIME button to select the “Second code No.”.
6	Press the CONFIRMATION button to confirm the changed setting.
7	Press the INSPECTION/TEST button to return to “Normal mode”.

2.2 Field Setting from Remote Controller

Individual function of indoor unit can be changed from the remote controller. At the time of installation or after service inspection / repair, make the local setting in accordance with the following description.

Wrong setting may cause malfunction.

(When optional accessory is mounted on the indoor unit, setting for the indoor unit may be required to change. Refer to information in the option handbook.)

2.2.1 Wired Remote Controller <BRC1E61>

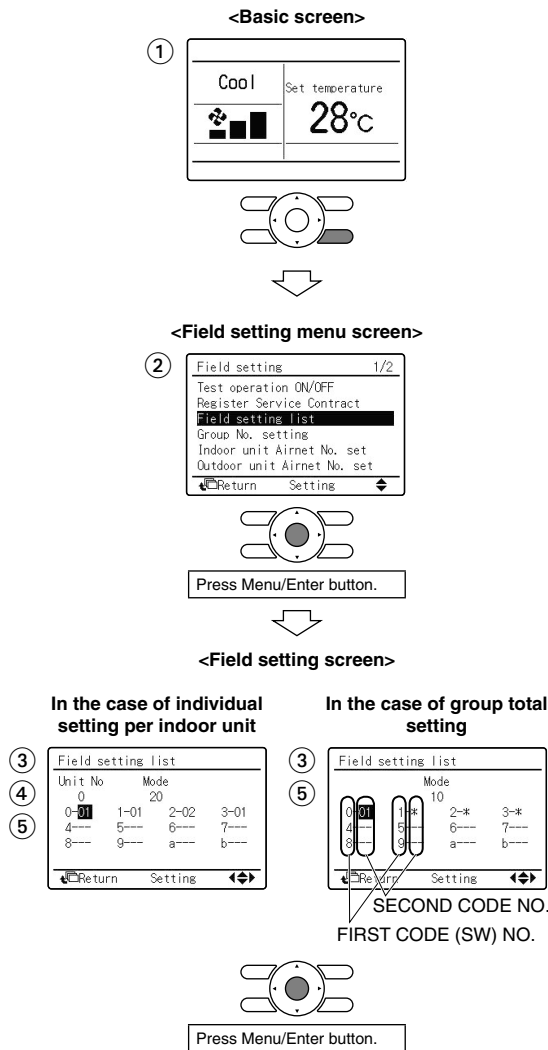

1 Press and hold Cancel button for 4 seconds or more .
Field setting menu is displayed.

2 Select **Field setting list** in the field setting menu, and press Menu/Enter button.
Field setting list screen is displayed.

3 Highlight the mode, and select desired "Mode No." by using ▲▼ (Up/Down) button.

4 In the case of setting per indoor unit during group control (When Mode No. such as 20 , 21 , 22 , 23 , 25 are selected), highlight the unit No. and select "Indoor unit No." to be set by using ▲▼ (Up/Down) button. (In the case of group total setting, this operation is not needed.)

[In the case of individual setting per indoor unit, current settings are displayed. And, SECOND CODE NO. "-" means no function.

5 Highlight SECOND CODE NO. of the FIRST CODE NO. to be changed, and select desired "SECOND CODE NO." by using ▲▼ (Up/Down) button. Multiple identical mode number settings are available.

[In the case of group total setting, all of SECOND CODE NO. which may be set are displayed as "*". "*" is changed to SECOND CODE NO. to be set. And, SECOND CODE NO. "-" means no function.

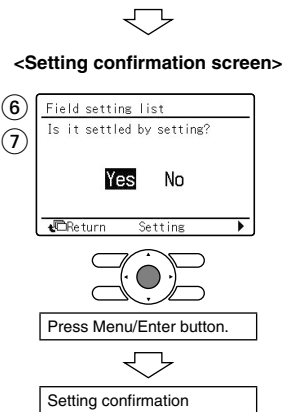

6 Press Menu/Enter button. Setting confirmation screen is displayed.

7 Select **Yes** and press Menu/Enter button. Setting details are determined and field setting list screen returns.

8 In the case of multiple setting changes, repeat “③” to “⑦”.

9 After all setting changes are completed, press Cancel button twice.

10 Backlight goes out, and “Connection under check Please wait for a moment” is displayed for initialization. After the initialization, the basic screen returns.

⚠ CAUTION

- When an optional accessory is installed on the indoor unit, settings of the indoor unit may be changed. See the manual of the optional accessory.
- For field setting details of the outdoor unit, see installation manual attached to the outdoor unit.

2.3 How to Change the Field Settings with the Wireless Remote Controller

Optional accessories

If optional accessories are mounted on the indoor unit, the indoor unit setting may have to be changed.

Refer to OH06-1 or the installation manual (optional handbook) for each optional accessory.

Wireless remote controller

The illustration below shows the wireless remote controller.

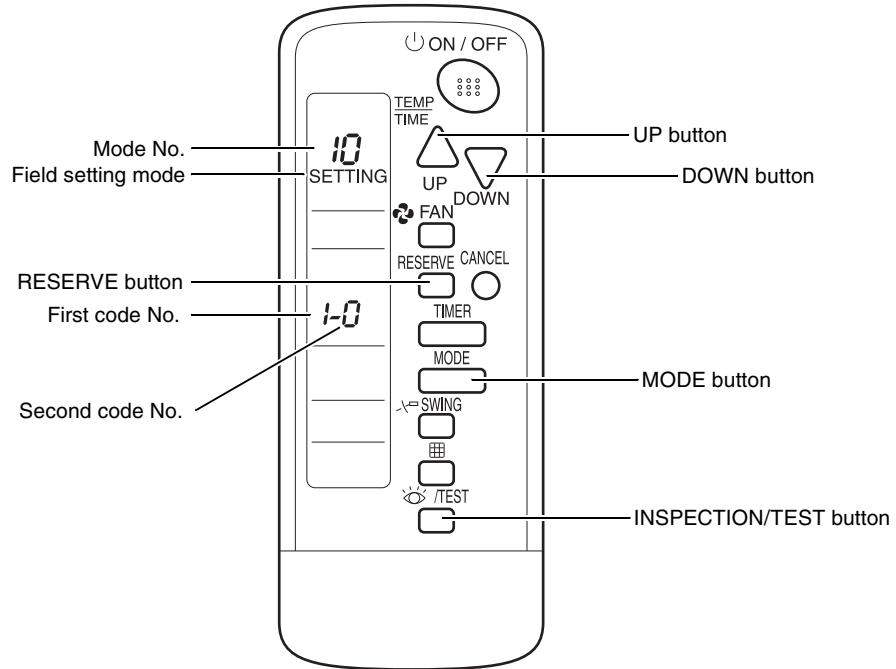

Setting

To set the field settings, you have to change:

- "Mode No."
- "First code No."
- "Second code No."

To change the field settings, proceed as follows:

Step	Action
1	Hold down the INSPECTION/TEST button for at least 4 s during normal mode to enter the "Field setting mode".
2	Press the MODE button to select the desired "Mode No."
3	Press the UP button to select the "First code No."
4	Press the DOWN button to select the "Second code No."
5	Press the RESERVE button to set the present settings.
6	Press the INSPECTION/TEST button to return to the "Normal mode".

2.4 Overview of the Field Settings on the Indoor Units

Field settings

The table below contains the possible field settings of all indoor units.

Mode No.	First code No.	Description of the setting	Second code No.			
			01	02	03	04
10 (20)	0	Filter counter	Light contamination	heavy contamination	—	—
	1	Filter type	Long	Super long	External	Oil mist
	2	Remote thermistor of the remote controller	TH1 = rem. controller	TH1 = air return	—	—
	3	Filter display	Filter indic.	No filter indic.	—	—
11 (21)	0	Number indoor to 1 outdoor	Pair	Twin	Triple	Double twin
	1	Unified or indiv. set twin	Group setting	Indiv. setting	—	—
	2	Fan OFF at thermostat OFF	LL-speed	OFF	—	—
12 (22)	0	KRP1B51/52/53 X1/X2 output	Thermostat ON	Option	Operation	Malfunction
	1	EKRORO	Forced OFF	ON/OFF operation	—	—
	3	Fan speed heating thermostat OFF	LL-speed	Set speed	—	—
	5	Automatic restart	Disabled	Enabled	—	—
13 (23)	0	Ceiling height setting	Normal	High	Extra high	—
			≤ 2.7 m	> 2.7 ≤ 3.0 m	> 3.0 ≤ 3.5 m	—
	1	Selection of air flow direction (setting for when a blocking pad kit has been installed).	4-way flow	3-way flow	2-way flow	—
	3	Horizontal discharge grill	Enabled	Disabled	—	—
	4	Air flow direction adjust range setting	Draft prevention	Standard	Ceil soil prevention	—
	5	Field fan speed changeover air outlet (domestic only)	Standard	Option 1	Option 2	—
6	External static pressure	Normal	High	Low	—	
14 (24)	0	Additional timer to guard timer	0 s	5 s	10 s	15 s
1b (Only in case of BRC1D52)	0	Permission level setting	Level 2	Level 3	—	—
	1	Leave home function	Not permitted	Permitted	—	—
	2	Thermostat sensor in remote controller (for limit operation and leave home function only)	Use	Not use	—	—

2.5 Overview of the Factory Settings on the Indoor Units

Factory settings The table below contains the factory settings of all indoor units

Mode No.	First code No.	Second code No.							
		FCQ	FFQ	FBQ	FAQ	FDQ	FUQ	FHQ	FCQ
10 (20)	0	01	01	01	01	01	01	01	01
	1	01	01	01	—	02	01	—	01
	2	02	02	02	02	02	02	02	02
	3	01	01	01	01	01	01	01	01
11 (21)	0	01	01	01	01	01	01	01	01
	1	01	01	01	01	01	01	01	01
	2	01	01	01	01	01	01	01	01
12 (22)	0	01	01	01	01	01	01	01	01
	3	01	01	01	—	—	—	—	01
	5	02	02	02	02	02	02	02	02
13 (23)	0	01	—	—	01	—	01	01	01
	1	01	01	—	—	—	—	—	01
	3	—	—	—	—	—	—	—	—
	4	02	02	—	—	—	—	—	02
	5	01	01	—	01	—	01	01	01
	6	—	—	01	—	—	—	—	—
14 (24)	0	01	01	01	—	01	01	01	01

2.6 MAIN/SUB Setting when Using Two Remote Controllers

Situation The MAIN/SUB setting is necessary when one indoor unit is controlled by two remote controllers. When you use two remote controllers (control panel and separate remote controller), set one to MAIN and the other to SUB. You can do this by setting the switch on the remote controller's PCB.

Setting The remote controllers are factory set to MAIN, so you only have to change one remote controller from MAIN to SUB. To change a remote controller from MAIN to SUB, proceed as follows:

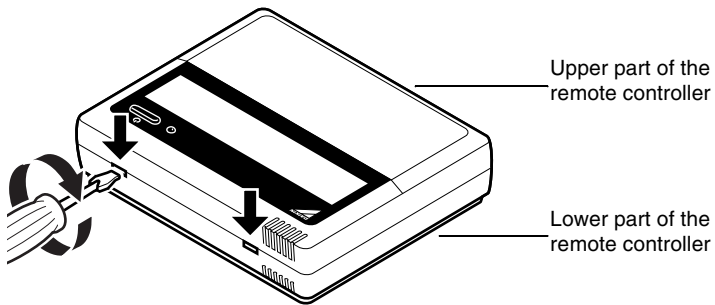
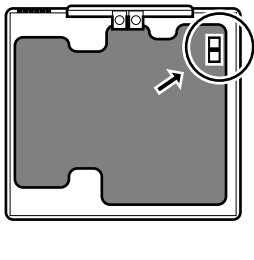
Step	Action
1	<p>Insert a flathead screwdriver into the recess between the upper and lower part of the remote controller, as shown in the illustration below. Gently pry off the upper part of the controller, working from the two possible positions.</p> 
2	<p>Turn the MAIN/SUB changeover switch on the PCB to "S".</p>  <p>The switch is set to MAIN (factory setting)</p> <p>↓</p> <p>Set the switch to SUB.</p>

2.7 Setting the Centralized Group No.

When?

If you want to carry out centralized control with a central remote controller and a unified ON/OFF controller, you have to set the group No. for each group with the remote controller.

Wired remote controller

The illustration below shows the wired remote controller.

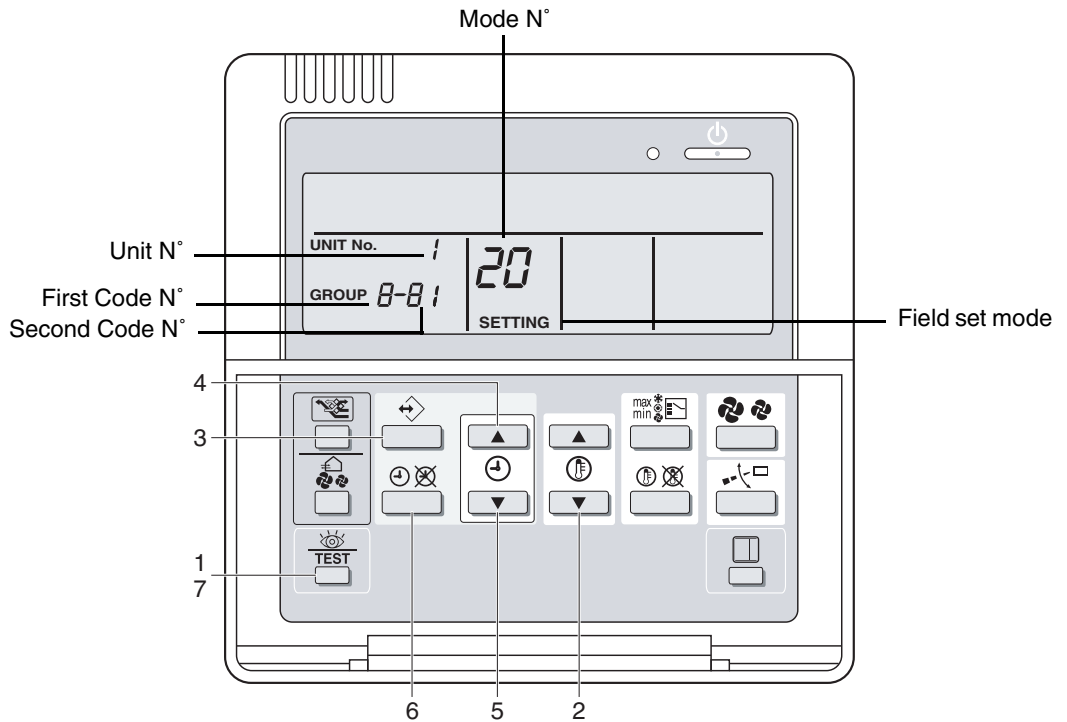

Setting

To set the “Centralized group No.”, proceed as follows:

Step	Action
1	Switch ON the power supply of the central remote controller, the unified ON/OFF controller and the indoor unit(s).
2	Hold down the INSPECTION/TEST button for at least 4 s during normal mode to enter the “Field setting mode”.
3	Press the TEMPERATURE CONTROL button until “Mode No.” “00” appears.
4	Press the INSPECTION/TEST button to inspect the group No. display.
5	Set the “Group No.” for each group by pressing the PROGRAMMING TIME button. The “Group No.” rises in the order of 1—00, 1—01, ..., 1—15, 2—00, ..., 2—15, 3—00, etc. The unified ON/OFF controller however displays only the range of group numbers selected by the switch for setting each address.
6	Press the CONFIRMATION button to enter the selected group No.
7	Press the INSPECTION/TEST button to return to normal mode.

Individually address setting

If the address must be set individually for each unit, set the “Mode No.” to “30”. For example, for power consumption counting.

2.7.1 Centralized Control Group No. Setting

BRC1E Type

In order to conduct the central remote control using the central remote controller and the unified ON/OFF controller, Group No. settings should be made by group using the operating remote controller.

Make Group No. settings for central remote control using the operating remote controller.

(1) <Basic screen>

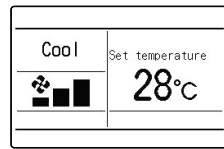

1. Press and hold Cancel button for 4 seconds or more. Field setting menu is displayed.

(2) <Field setting menu screen>

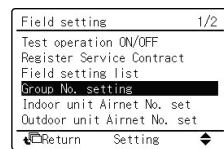

2. Select **Group No. setting** the field setting menu, and press Menu/Enter button. Group No. setting screen is displayed.

(3) <Group No. setting>

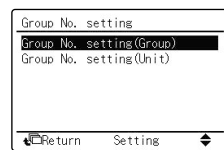

3. Select Group No. setting (Group), and press Menu/Enter button. Group No. setting (Group) screen is displayed.

(3) <Group No. setting (Group)>

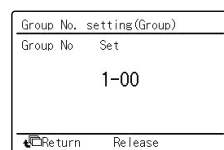

4. Select the group No. by using ▲▼ (Up/Down) button. Press Menu/Enter button.

Note:

- For wireless remote controller, see the following.
- For setting group No. of HRV and wiring adaptor for other air conditioners, etc., refer to the instruction manual attached.

NOTICE

Enter the group No. and installation place of the indoor unit into the attached installation table. Be sure to keep the installation table with the operation manual for maintenance.

2.8 The Field Setting Levels

Introduction

The three field setting levels are:

- Inspection level
- Monitoring level
- Maintenance mode settings.

The inspection level

The inspection level is the highest level of the three field setting levels. You can change the views in the inspection level by pressing the INSPECTION/TEST button.

The flow chart below explains the different windows of the inspection level.

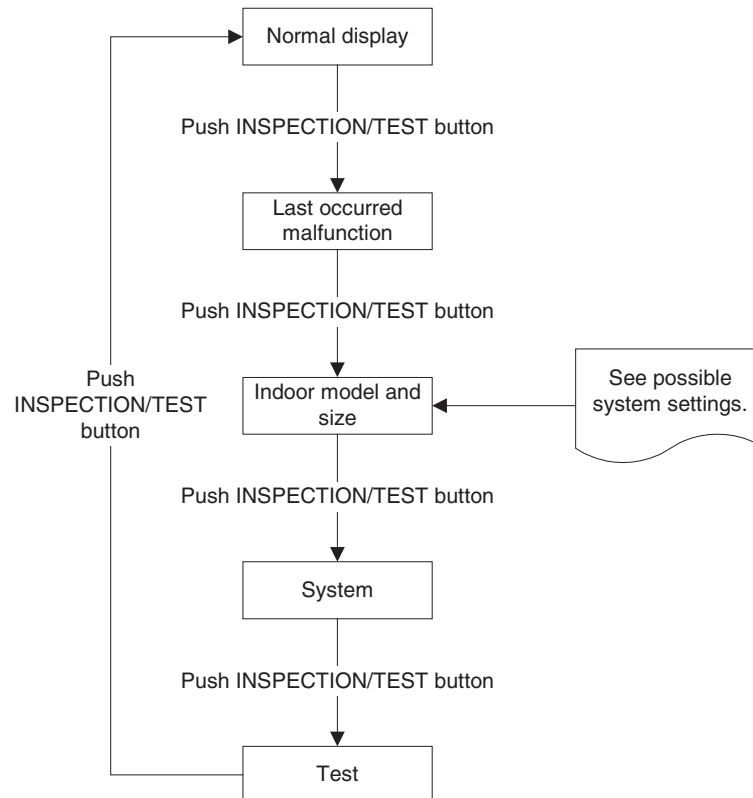

Possible system settings

The table below contains the possible system settings, which are displayed on the remote controller if the TEST button is pushed twice shortly.

Size		Software	Type	
Settings	Display		Settings	Display
35	35	5	FCQ-B	FJ
45	45		FHQ	HJ
60	63		FAQ	AJ
71	71		FFQ	GJ
100	100		FBQ	JJ
125	125		FUQ	3J
140	140		FCQ-D	FJ
200	200		FDQ	UJ
250	250		–	–

Changing the mode settings

To enter the monitoring level and to change the maintenance mode settings, proceed as follows:

Step	Action
1	Hold down the INSPECTION/TEST button for at least 4 s to enter the field setting mode.
2	Hold down the INSPECTION/TEST button for at least 4 s to enter the maintenance mode.
3	Press the TEMPERATURE CONTROL buttons as many times as needed to select the mode No. you want.
4	Press the TIMER SELECTION button as many times as needed to select the unit No. you want.
5	Carry out the settings for modes 44 and 45. See "Maintenance Mode Settings" further in this section.
6	Press the CONFIRMATION button to confirm the settings of modes 44 and 45.
7	Press the INSPECTION/TEST button to return to the normal operating mode.

Maintenance Mode Settings

The table below describes the maintenance mode settings.

Mode No.	Function	Content and operation method	Example of the remote controller display
40	History error codes	Display malfunction history	<p>Unit No. 1 CODE 2-4 SETTING 40 Malfunction history: 0: Newest, 2: Oldest * "00" displayed for 3 and subsequent</p>
		The history No. can be changed with the programming time button.	
41	Thermistor data display	Select the display thermistor with the programming time button.	<p>Unit No. 1 27 SETTING 41</p>
		Thermistor: 0. Remote control thermistor 1. Suction thermistor 2. Heat exchanger thermistor.	
43	Forced fan ON	Turns the fan ON for each unit individually.	<p>Unit No. 1 SETTING 43</p>
44	Individual setting	Sets fan speed and air flow direction for each unit individually when using group control.	<p>Unit No. 1 CODE 10 SETTING 44 Fan speed: 1: Low, 3: High Air flow direction</p>
		Settings are made using the "air flow direction adjust" and "fan speed adjust" buttons. Confirmation by the confirmation button is required.	
45	Unit No. change	Changes unit No.	<p>Unit No. 1 CODE 02 SETTING 45 Field set No No after change</p>
		Set the unit No. after changing with the programming time buttons. Confirmation by the confirmation button is required.	

2.9 Overview of the Field Settings on the Outdoor Units

Remote controller settings

The table below contains the remote controller settings.

Mode N°	First code	Description	Second n°					Details
			01	02	03	04	05	
16 (26)	0	Night time low noise operation	Disabled (Factory setting)	Automatic low noise activation	Capacity preceding setting (when using KRP58 option)	Automatic low noise + capacity preceding	—	Refer to P101.
	1	Automatic low noise start and stop time	—	—	22h00 ~ 06h00	22h00 ~ 08h00 (Factory)	20h00 ~ 08h00	Refer to P101.
	2	EDP room setting	Disabled (Factory setting)	—	EDP room setting	EDP room setting + no freeze up	—	Refer to P105.
	3	Defrost starting setting	Standard (Factory setting)	Defrost slow starting setting	Defrost quick starting setting	—	—	Refer to P110.

2.10 Overview of the Factory Settings on the Outdoor Units

Factory settings

The table below contains the factory settings of all outdoor units

		All outdoor units
26	0	01
	1	04
	2	01
	3	01

2.11 Existence of DIP Switch and BS Button

2.11.1 RZQ71~140

Various settings are available by using the DIP switches and the BS buttons on the Printed-Circuit Board (Display PC board: A2P).

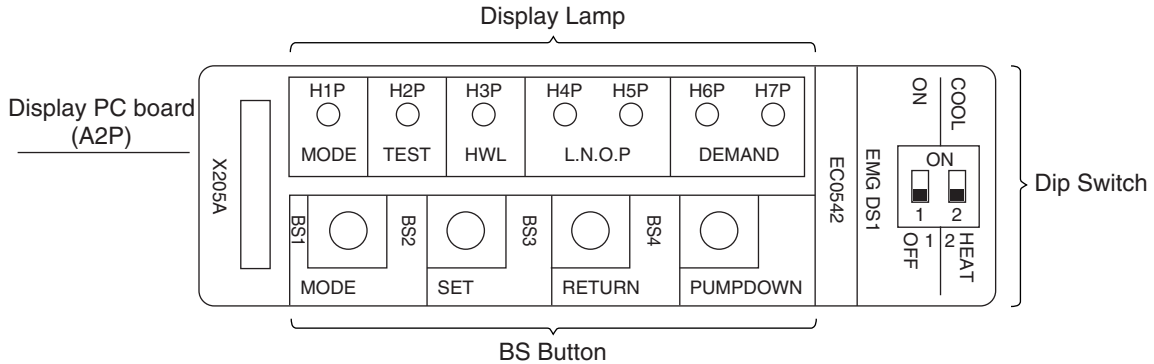

	Display		Function or Operating Procedure		
	Mark	Name			
Display Lamp	H1P	MODE	During "Setting mode 1," the lamp is OFF (●).	During "Monitor mode," the lamp blinks (●).	
	H2P	TEST	During test operation in "Setting mode 1," the lamp is ON (○).	During "Monitor mode," the lamp is OFF (●).	
	H3P	HWL	When a malfunction occurs during "Setting mode 1," the lamp turns ON (○).		
	H4P	L.N.O.P	During "Setting mode 1," low noise level is displayed.	During "Monitor mode," various combinations of the lamp indicate the following conditions: <ul style="list-style-type: none"> • Indication of oil return operation • Indication of outdoor unit class • Indication of malfunction code (the latest and up to 2 cycles before) • Indication of causes of stepping-down 	
	H5P				
	H6P				
	H7P	DEMAND	During "Setting mode 1," demand level is displayed.		
BS Button	BS1	MODE	Used to change "Setting mode".		
	BS2	SET	Used to change "Setting item" and "Setting condition".		
	BS3	RETURN	Used to decide "Setting item" and "Setting condition".		
	BS4	PUMP DOWN	Used for pump down operation, forced oil return operation and forced defrost operation.		
Dip Switch	DS1-1	ON	EMERGENCY	Switch from "OFF" to "ON" for emergency operation (forced operation).	
		OFF(*)			
DS1-2	COOL	In case of heating in emergency operation, maintain "HEAT" and in case of cooling in emergency operation, switch to "COOL".			
	HEAT(*)				

*Factory settings: "OFF" and "HEAT"

Notes: BS button (Pump down / Forced defrosting)

Pressing the BS button forcibly operates the air conditioner in the cooling mode.

1. To conduct a pump-down operation (sending refrigerant to outdoor unit), press the BS button to forcibly operate the equipment in the cooling mode, then operate the unit for about 1 minute to stabilize the system. After stabilizing system, close the liquid pipe stop valve on the outdoor unit, and after the pressure decreases and the low pressure sensor activates, close the gas pipe stop valve.

2. Forced defrost

To activate the defrost operation during the heating operation, press the BS button. This will activate the forced defrost operation (cooling operation).

When the defrost cancel conditions are met, the equipment automatically switches off the defrost operation.

■ Setting by BS buttons

With "Setting mode 1," "Setting mode 2" and "Monitor mode," various settings and data can be checked.

① **Setting mode 1**

The initial status (normal operation) is "Setting mode 1." This mode indicates operating status - "TEST (test operation)," "HWL (malfunction)," "L.N.O.P (low noise operation)" or "DEMAND (demand operation)."

② **Setting mode 2**

Each operating status can be modified.

③ **Monitor mode**

This mode indicates "oil return operation," "outdoor unit class," "contents of retry," "contents of malfunction," "causes of stepping-down operation," etc.

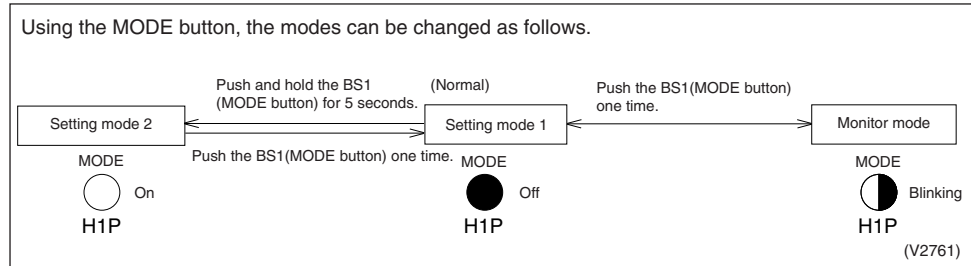

a. "Setting mode 1"

Using this mode, the following conditions can be checked:

- Current operating condition (normal/test operation/line inspection and normal/malfunction)
- Low noise operating condition (normal/low noise level setting)
- Demand operating condition (normal/demand level 1, 2 and 3)

These conditions above can be checked by performing the following steps:

Procedure for checking check items

The system is normally set to "Setting mode 1". Should the system be set to any mode other than that, push the **MODE (BS1)** button to set the system to "Setting mode 1".

Check the system for each condition through LED displays. (Refer to information in table on the right.)

MODE	TEST	HWL	L.N.O.P			DEMAND	
H1P	H2P	H3P	H4P	H5P	H6P	H7P	
●	●	●	●	●	●	●	

○ : ON ◐ : OFF ● : BLINK

- During "Setting mode 1," the lamp is always OFF.
- Test operation display
 - In normal operation ○ In test operation
 - ◐ In line inspection operation
- Malfunction display
 - Normal ○ Malfunction
- Low noise operation display
 - Normal operation
 - Low noise level setting
- Demand level display
 - Normal operation
 - Demand level 1
 - Demand level 2
 - Demand level 3

b. "Setting mode 2"

In this mode, settings for the following items can be made by using BS buttons.

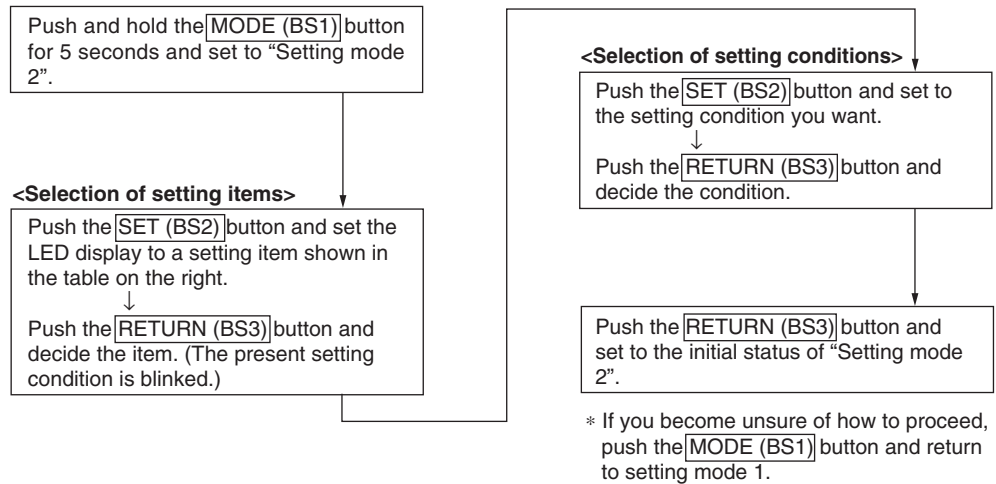

No.	Display of setting items							Display of setting condition								
	Setting item	LED display							Setting condition	LED display						
		H1P	H2P	H3P	H4P	H5P	H6P	H7P		H1P	H2P	H3P	H4P	H5P	H6P	H7P
3	Demand 2 operation	○	●	●	●	●	○	○	30% demand	○	●	●	●	○	●	●
									40% demand (factory setting)	○	●	●	●	●	○	●
									50% demand	○	●	●	●	●	●	○
28	Refrigerant recovery mode	○	●	○	○	○	●	●	OFF (factory setting)	○	●	●	●	●	○	○
									ON	○	●	●	●	●	○	●

↑ The figures in the columns under "No." represent the number of times to push the SET (BS2) button.

■ Setting of Demand 2 operation

With this setting, compressor operation can be controlled to reduce power consumption. (60% - 80% demand is available when a demand adapter (optional accessory) is used.)

Setting item	Setting condition	Description
Demand 2 operation	30% demand	Operates with 30% of rated power consumption.
	40% demand (factory setting)	Operates with 40% of rated power consumption.
	50% demand	Operates with 50% of rated power consumption.

[Work procedure]

● : OFF ○ : BLINK ○ : ON

Operating procedure	H1P	H2P	H3P	H4P	H5P	H6P	H7P
Push and hold the MODE (BS1) button of "Setting mode 1" for 5 seconds or more and set to "Setting mode 2."	○	●	●	●	●	●	●
Push the SET (BS2) button three times to set the LED display as shown in the table on the right.	○	●	●	●	●	○	○
Push the RETURN (BS3) button once. (Present settings are displayed.)	○	●	●	●	●	○	●
Push the SET (BS2) button to set the LED display as shown in the table on the right.	30% of rated power consumption	○	●	●	●	○	●
	40% of rated power consumption	○	●	●	●	●	○
	50% of rated power consumption	○	●	●	●	●	○
Push the RETURN (BS3) button once to make a decision.	30% of rated power consumption	○	●	●	●	○	●
	40% of rated power consumption	○	●	●	●	●	○
	50% of rated power consumption	○	●	●	●	●	○
Push the RETURN (BS3) button once again for execution. (The LED display is in the initial status of "Setting mode 2".)	○	●	●	●	●	●	●
Push the MODE (BS1) button once to return to Setting mode 1 (normal operation).	●	●	●	●	●	●	●

■ **Setting of refrigerant recovery mode**

When a refrigerant recovery unit is connected on site to recover refrigerant, fully open the expansion valve of the outdoor unit to help the recovery.

[Work procedure]

- (1) Stop operation.
- (2) Turn ON refrigerant recovery mode by performing the following steps.

● : OFF ◐ : BLINK ○ : ON

Operating procedure	H1P	H2P	H3P	H4P	H5P	H6P	H7P
Push and hold the MODE (BS1) button of "Setting mode 1" for 5 seconds or more and set to "Setting mode 2."	○	●	●	●	●	●	●
Push the SET (BS2) button 28 times to set the LED display as shown in the table on the right. (*1)	○	●	○	○	○	●	●
Push the RETURN (BS3) button once. (Present settings are displayed.)	○	●	●	●	●	●	◐
Push the SET (BS2) button once to set the LED display as shown in the table on the right.	○	●	●	●	●	◐	●
Push the RETURN (BS3) button once to make a decision.	○	●	●	●	●	○	●
When the RETURN (BS3) button is pushed once again, the electronic expansion valve opens fully. (For RZQ-KTLT, the solenoid valve also opens.)	○	●	●	●	●	●	●

- (3) Connect a refrigerant recovery unit to perform refrigerant recovery. (For a refrigerant recovery port, refer to the installation manual.)
- (4) Upon completion of refrigerant recovery, turn OFF refrigerant recovery mode by taking the following steps or turning OFF the power of outdoor unit.

Operating procedure	H1P	H2P	H3P	H4P	H5P	H6P	H7P
Push the SET (BS2) button 28 times to set the LED display as shown in the table on the right. (*1)	○	●	○	○	○	●	●
Push the RETURN (BS3) button once. (Present settings are displayed.)	○	●	●	●	●	◐	●
Push the SET (BS2) button once to set the LED display as shown in the table on the right.	○	●	●	●	●	●	◐
Push the RETURN (BS3) button once to make a decision.	○	●	●	●	●	●	○
When the RETURN (BS3) button is pushed once again, the electronic expansion valve fully opens. (For RZQ-KTLT, the solenoid valve also closes.)	○	●	●	●	●	●	●

*1: If you become unsure how many times you have pushed the button, push the MODE (BS1) button once to return to "Setting mode 1" and start the operating procedure all over again.

c. "Monitor mode"

In this mode, the following items can be checked by using the BS buttons.

To enter the monitor mode, push the **MODE (BS1)** button when in "Setting mode 1".

<Selection of setting item>

Push the **SET (BS2)** button and set the LED display to a setting item.

<Confirmation on setting contents>

Push the **RETURN (BS3)** button to display different data of set items.

Push the **RETURN (BS3)** button and switches to the initial status of "Monitor mode".

* Push the **MODE (BS1)** button and returns to "Setting mode 1".

No.	Setting item	LED display							Data display
		H1P	H2P	H3P	H4P	H5P	H6P	H7P	
0	Indication of oil return operation	●	●	●	●	●	●	●	See Data display ①.
1	Indication of outdoor unit class	●	●	●	●	●	●	○	See Data display ②.
2	Contents of retry (the latest)	●	●	●	●	●	○	●	See "Malfunction code display" on the next page.
3	Contents of retry (1 cycle before)	●	●	●	●	●	○	○	
4	Contents of retry (2 cycle before)	●	●	●	●	○	●	●	
5	Contents of malfunction (the latest)	●	●	●	●	○	●	○	
6	Contents of malfunction (1 cycle before)	●	●	●	●	○	○	●	
7	Contents of malfunction (2 cycle before)	●	●	●	●	○	○	○	
10	Indication of causes of stepping-down operation	●	●	●	○	●	○	●	See Data display ③.

↑ The numbers in the "No." column represent the number of times to press the **SET (BS2)** button .

Data display ①

Display contents	LED display						
	H1P	H2P	H3P	H4P	H5P	H6P	H7P
In normal operation	●	●	●	●	●	●	●
In oil return operation	●	●	●	●	●	●	○

Data display ②

Display contents	LED display						
	H1P	H2P	H3P	H4P	H5P	H6P	H7P
No setting	○	●	●	●	●	●	○
RZQ 125 KTLT	○	●	●	○	●	●	○
RZQ 140 KTLT	○	●	●	○	●	○	●

Data display ③

Display contents	LED display						
	H1P	H2P	H3P	H4P	H5P	H6P	H7P
Normal (not in stepping-down operation)	○	●	●	●	●	●	○
Low pressure stepping-down	○	●	●	●	●	○	●
High pressure stepping-down	○	●	●	●	●	○	○
Inverter discharge pipe stepping-down	○	●	●	●	○	●	●
Inverter current stepping-down	○	●	●	●	○	●	○
Radiation fin temperature stepping-down	○	●	●	●	○	○	●
Inverter stepping-down	○	●	●	●	○	○	○
Overall current stepping-down	○	●	●	○	●	●	●
Other stepping-down	○	●	●	○	●	●	○

d. "List of contents of retry and malfunction"

Take the following steps to check contents of retry and malfunction.

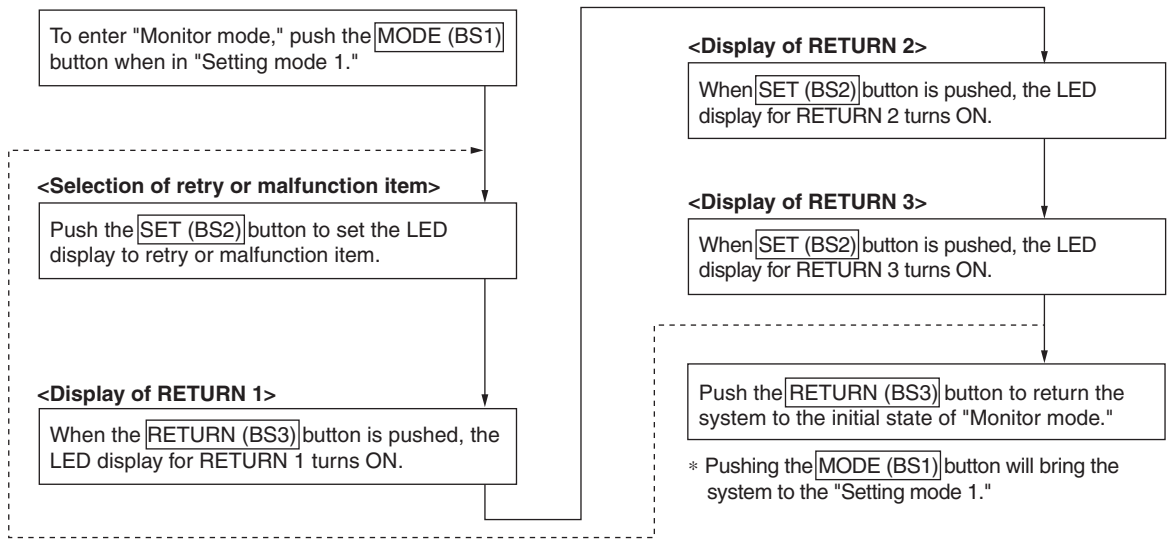

○: ON ●: OFF ◐: BLINK

Malfunction code	Contents of retry or malfunction		1							2							3								
			HAP	H1P	H2P	H3P	H4P	H5P	H6P	H7P	HAP	H1P	H2P	H3P	H4P	H5P	H6P	H7P	HAP	H1P	H2P	H3P	H4P	H5P	H6P
C4	Indoor heat exchanger thermistor		◐	◐	○	●	●	●	◐	●	◐	◐	○	●	●	◐	●	◐	◐	○	○	●	●	●	●
E1	Faulty outdoor PC board		◐	◐	●	○	●	●	◐	◐	◐	◐	○	●	●	●	◐	◐	◐	○	○	●	●	●	●
E3	Abnormal high pressure		◐	◐	○	●	●	◐	◐	◐	◐	○	●	●	◐	◐	◐	◐	○	○	●	●	●	●	●
E4	Abnormal low pressure		◐	◐	○	●	●	◐	◐	◐	◐	○	●	●	◐	◐	◐	◐	○	○	●	●	●	●	●
E5	Compressor motor lock		◐	◐	○	●	●	◐	◐	◐	◐	○	●	●	◐	◐	◐	◐	○	○	●	●	●	●	●
E7	Abnormal outdoor fan motor	DC motor 1 lock	◐	◐	○	●	●	◐	◐	◐	◐	○	●	●	◐	◐	◐	◐	○	○	●	●	●	●	◐
		DC motor 2 lock	◐	◐	○	●	●	◐	◐	◐	◐	○	●	●	◐	◐	◐	◐	○	○	●	●	●	●	◐
		Abnormal inverter transmission	◐	◐	○	●	●	◐	◐	◐	◐	○	●	●	◐	◐	◐	◐	○	○	●	●	●	●	◐
E9	Abnormal electronic expansion valve	Disconnected electronic expansion valve connector	◐	◐	○	●	●	◐	◐	◐	◐	○	●	●	◐	◐	◐	◐	○	○	●	●	●	●	◐
		Malfunction due to wet conditions	◐	◐	○	●	●	◐	◐	◐	◐	○	●	●	◐	◐	◐	◐	○	○	●	●	●	●	◐
F3	Abnormal discharge pipe temperature	Abnormal discharge pipe temperature	◐	◐	●	○	●	●	◐	◐	◐	◐	○	●	●	◐	◐	◐	◐	○	○	●	●	●	◐
		Disconnected discharge pipe thermistor	◐	◐	○	●	●	◐	◐	◐	◐	○	●	●	◐	◐	◐	◐	○	○	●	●	●	●	◐
H3	Abnormal high pressure switch		◐	◐	●	○	●	●	◐	◐	◐	◐	○	●	●	◐	◐	◐	◐	○	○	●	●	●	●
H9	Abnormal outdoor air thermistor		◐	◐	○	●	●	◐	◐	◐	◐	○	●	●	◐	◐	◐	◐	○	○	●	●	●	●	●
J1	Abnormal pressure sensor		◐	◐	●	○	●	●	◐	◐	◐	◐	○	●	●	◐	◐	◐	◐	○	○	●	●	●	●
J3	Abnormal discharge pipe thermistor		◐	◐	○	●	●	◐	◐	◐	◐	○	●	●	◐	◐	◐	◐	○	○	●	●	●	●	●
J5	Abnormal suction pipe thermistor		◐	◐	○	●	●	◐	◐	◐	◐	○	●	●	◐	◐	◐	◐	○	○	●	●	●	●	●
J6	Abnormal heat exchanger distributor pipe thermistor		◐	◐	○	●	●	◐	◐	◐	◐	○	●	●	◐	◐	◐	◐	○	○	●	●	●	●	●
J7	Abnormal intermediate heat exchanger thermistor		◐	◐	○	●	●	◐	◐	◐	◐	○	●	●	◐	◐	◐	◐	○	○	●	●	●	●	●
J8	Abnormal liquid pipe thermistor		◐	◐	○	●	●	◐	◐	◐	◐	○	●	●	◐	◐	◐	◐	○	○	●	●	●	●	●
L1	PC board failure		◐	◐	●	○	●	●	◐	◐	◐	◐	○	●	●	◐	◐	◐	◐	○	○	●	●	●	●
L4	Elevated radiation fin temperature		◐	◐	○	●	●	◐	◐	◐	◐	○	●	●	◐	◐	◐	◐	○	○	●	●	●	●	●
L5	Compressor instantaneous overcurrent		◐	◐	○	●	●	◐	◐	◐	◐	○	●	●	◐	◐	◐	◐	○	○	●	●	●	●	●
L8	Compressor overload		◐	◐	○	●	●	◐	◐	◐	◐	○	●	●	◐	◐	◐	◐	○	○	●	●	●	●	●
L9	Compressor lock		◐	◐	○	●	●	◐	◐	◐	◐	○	●	●	◐	◐	◐	◐	○	○	●	●	●	●	●
LC	Abnormal transmission (between the control and the inverter)		◐	◐	○	●	●	◐	◐	◐	◐	○	●	●	◐	◐	◐	◐	○	○	●	●	●	●	●
P1	Unbalanced power supply voltage		◐	◐	●	○	●	●	◐	◐	◐	◐	○	●	●	◐	◐	◐	◐	○	○	●	●	●	●
P4	Abnormal radiation fin thermistor		◐	◐	○	●	●	◐	◐	◐	◐	○	●	●	◐	◐	◐	◐	○	○	●	●	●	●	●
PJ	Faulty capacity setting		◐	◐	○	●	●	◐	◐	◐	◐	○	●	●	◐	◐	◐	◐	○	○	●	●	●	●	●
U0	Abnormal gas shortage	Gas shortage warning	◐	◐	●	○	●	●	◐	◐	◐	◐	○	●	●	◐	◐	◐	◐	○	○	●	●	●	◐
		Abnormal gas shortage	◐	◐	○	●	●	◐	◐	◐	◐	○	●	●	◐	◐	◐	◐	○	○	●	●	●	●	◐
U2	Abnormal power supply voltage	Inverter undervoltage and overvoltage	◐	◐	○	●	●	◐	◐	◐	◐	○	●	●	◐	◐	◐	◐	○	○	●	●	●	◐	
		SP-PAM overvoltage	◐	◐	○	●	●	◐	◐	◐	◐	○	●	●	◐	◐	◐	◐	○	○	●	●	●	◐	◐
U4	Abnormal transmission (between indoor and outdoor units)		◐	◐	○	●	●	◐	◐	◐	◐	○	●	●	◐	◐	◐	◐	○	○	●	●	●	●	●
UA	Faulty field setting switch		◐	◐	○	●	●	◐	◐	◐	◐	○	●	●	◐	◐	◐	◐	○	○	●	●	●	●	●
UF	Improper piping and improper communication wiring													◐	◐	◐	◐	◐	○	○	●	●	●	●	

2.12 Quiet (Low Noise) Operation

Purpose Lower the operation sound of the outdoor unit.

Setting Silent Operation can be activated by:
 1. Automatic control (By field setting from remote controller)
 2. External activation (from optional PC board KRP58M)

2.12.1 Quiet (Low Noise) Operation by Automatic Control

Table Silent operation can be set by field setting from the wired remote controller:

Description	Mode	First Code	Second Code				
			01	02	03	04	05
Silent Operation	16(26)	0	OFF	Low noise activation	—	Low noise + capacity priority	—
Low noise start & stop time		1	—	—	22h00 ~ 06h00	22h00 ~ 08h00	20h00 ~ 08h00

Method When setting mode 16(26)-0-02, quiet (low noise) operation will be carried out by presuming the current time in accordance with the outside temperature.
 Automatic mode will start when the outdoor temperature is = average max of last 10 days -5°C and will be conducted for 10 hours.
 The maximum outdoor temperature is supposed to occur at 14:00h.
 As the time judgement is made in accordance with the outdoor temperature, the above mentioned timing is an estimation only.

Capacity precedence setting When setting mode 16(26)-0-04, the low noise operation will be stopped when the heating or cooling load increases. In that case, the operation will return to normal operation. The unit will return to low-noise operation when the heating or cooling load decreases again.

Graph

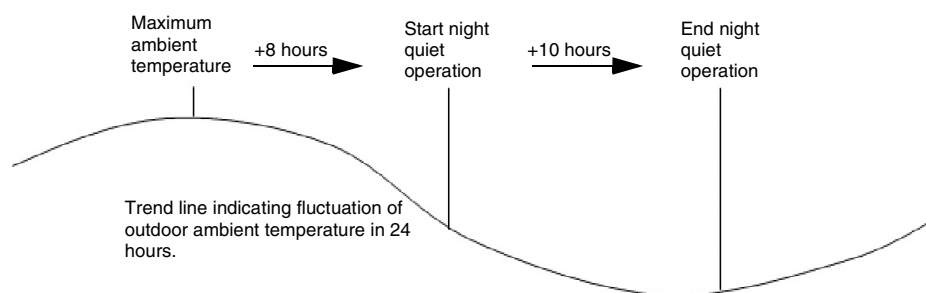

2.12.2 External Activation from Optional PC board

Graph

Quiet (low noise) operation can also be activated from the optional PC board.

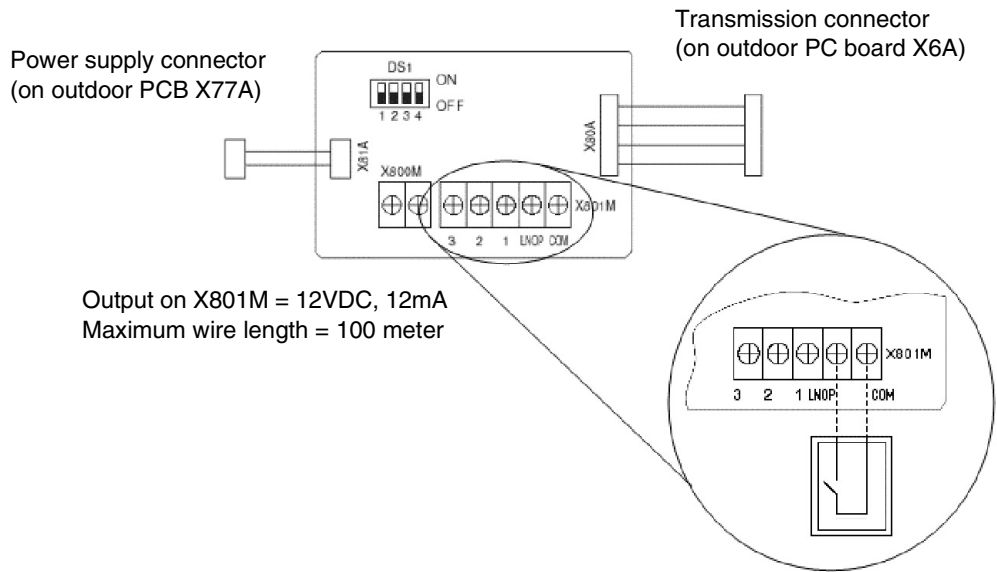

Quiet (low noise) operation will start when the contact on LNOP-COM is closed and will remain active as long as the contact is closed. No field setting on the outdoor unit or by remote controller is required.

Quiet (low noise) operation will be ended when the contact is re-opened.
Use of the KRP58M enables the use of an external time clock.

Capacity priority Setting

Same as with the automatic control, priority for capacity can be set. Priority for capacity will be activated by changing field setting 26-0-03 in combination with the closed contact on KRP58M.

Description	Mode	First Code	Second Code			
			01	02	03	04
Quiet (low noise) operation	16(26)	0	Factory	—	Capacity priority	—

Exceptions

The Quiet (low noise) operation will be overruled in the following conditions:

- Pump down residual operation
- Startup control
- Defrost operation
- Oil recovery

Sound reduction

	71	100	125
Sound reduction	4 dBA	4 dBA	5 dBA

2.13 I-Demand Function

Purpose Set a limitation towards the power consumption from the system.(e.g. budget control, limit power consumption during peak moments,..)

Setting 3 different demand setting can be selected by using terminal X801M:

- Demand 1 →Close contact between COM and contact 1
- Demand 2 →Close contact between COM and contact 2
- Demand 3 →Close contact between COM and contact 3

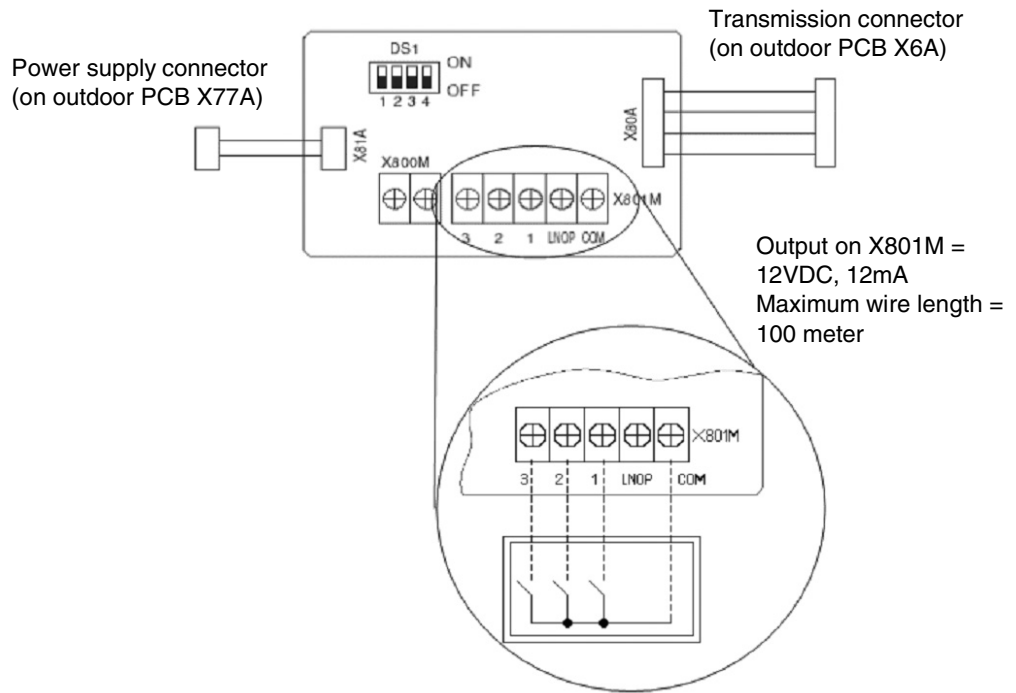

Demand 1

Power consumption limitation in function of setting on DS1:

DS1 SETTING			Maximum Power Consumption
1	2		
OFF	OFF	 ON OFF 1 2 3 4	60%
ON	OFF	 ON OFF 1 2 3 4	70%
OFF	ON	 ON OFF 1 2 3 4	80%
ON	ON	 ON OFF 1 2 3 4	100%

Demand 2

Power consumption limitation set to 40%.

Demand 3

Forced thermostat OFF.

2.14 Setting for Low Humidity Application

Purpose

Can be set when using the RZQ units for year round cooling in low humidity applications such as computerrooms (EDP rooms), technical rooms, etc...to increase the capacity of the unit.

Definition of Low Humidity Area

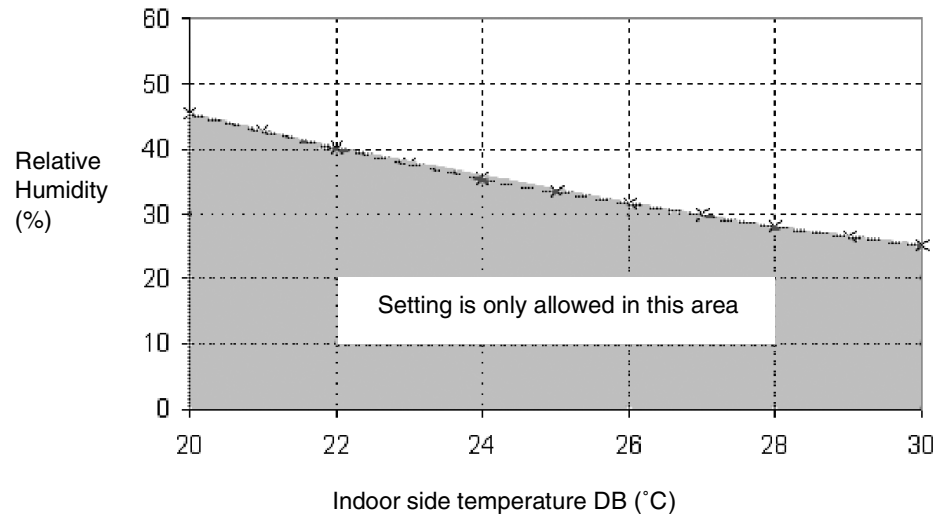

Caution

When using the "LH settings" outside the "Low Humidity Area" there is an increased risk of ice accumulation on the indoor coil or water blowing out from the indoor unit.

Function details

	Factory setting	Low humidity application setting	Low humidity application + freeze up operation prevention
Field Setting	16(26)-2-01	16(26)-2-03	16(26)-2-04
Compressor control	<ul style="list-style-type: none"> ■ The compressor frequency is controlled in function of the target evaporating temperature. ■ The target evaporating temperature is controlled in function of the cooling load. 		
	Minimum target Te = 2°C See graph 1	Minimum target Te = 0°C See graph 2	Initial minimum target Te = 2°C, but can be changed in function of actual Te, to avoid freeze up activation: <ul style="list-style-type: none"> ■ Te ≤ -1°C for 20 minutes accumulated => Change target Te ≥ 5°C ■ Te ≤ -1°C for 30 minutes accumulated => Change target Te ≥ 8°C See graph 3
Freeze protection function	Start	Te ≤ -1°C for 40 minutes accumulated OR Te ≤ A°C for 1 minute continuous (Indoor decision)	Te ≤ -1°C for 40 minutes accumulated OR Te ≤ -3°C for 1 minute continuous (Outdoor decision)
	End	Te > 7°C for 10 minutes continuously. (Indoor decision)	Te > 7°C for 3 minutes continuously OR Te > 4°C for 20 minutes continuously (Outdoor decision)

Parameters

	FAQ	FHQ	All except FAQ & FHQ
A	-1°C	-3°C	-5°C

Graph 1

Target evaporating temperature control in case of factory setting 16(26)-2-01:

Te target acceptable area

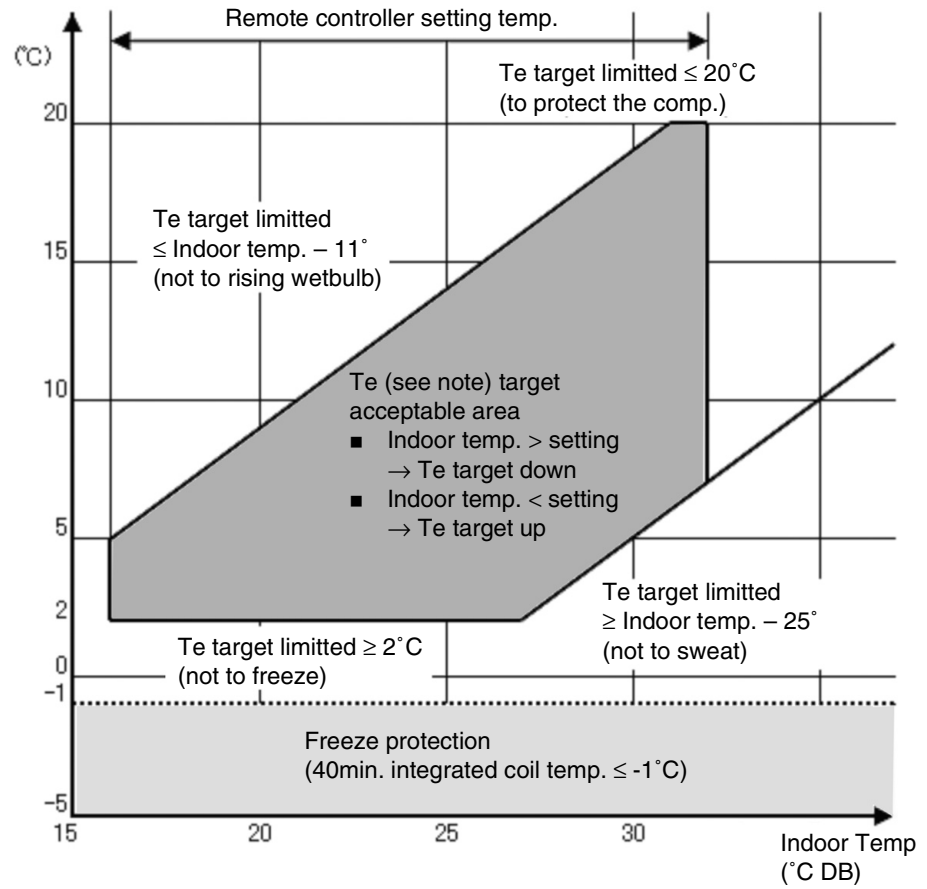

Note:

Te by LP sensor	RZQ71~140
-----------------	-----------

Graph 2

Target evaporating temperature control when "low humidity application" is selected. Field setting 16(26)-2-03:

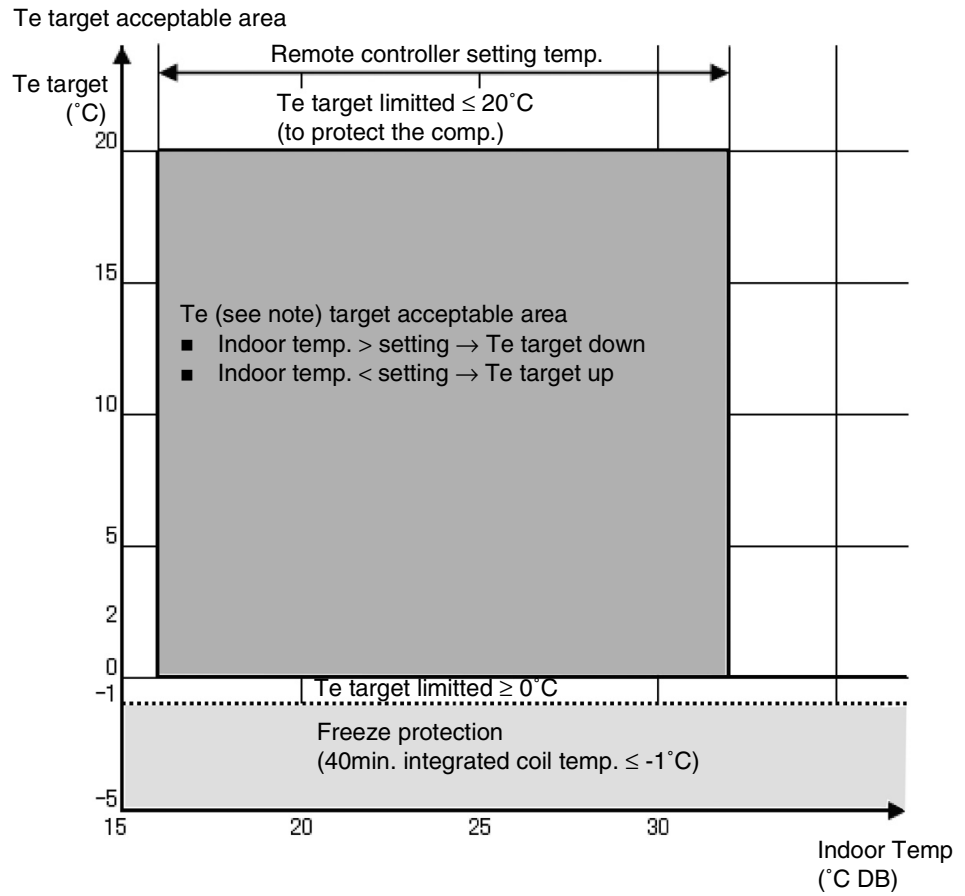

Note:

Te by LP sensor	RZQ71~140
-----------------	-----------

Graph 3

Target evaporating temperature control when "low humidity application + freeze up operation prevention" is selected. Field setting 16(26)-2-04:

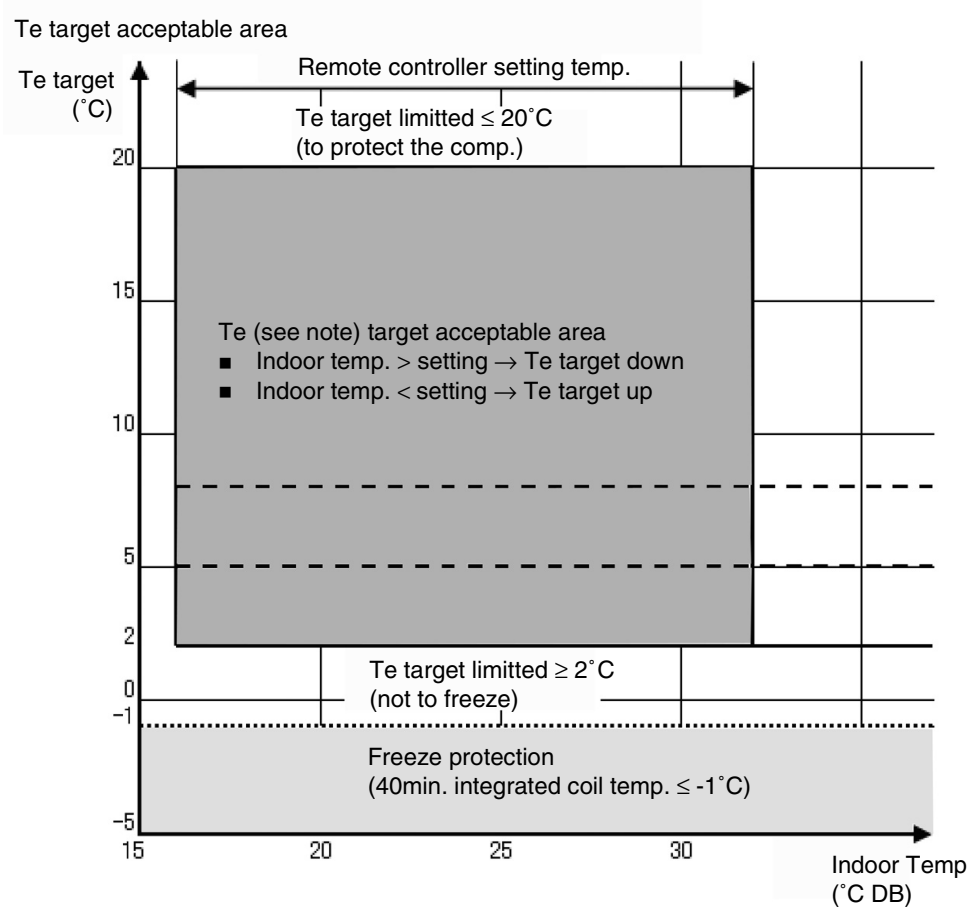

Note:

Te by LP sensor	RZQ71~140
-----------------	-----------

Change thermostat control

In order to increase continuous operation of the unit in low latent heat applications and avoid the rise of temperature after thermostat OFF, the thermostat control will be changed when using field settings 16(26)-2-03 & 16(26)-2-04.

Thermostat ON

- $\Delta Trs \geq 0.5 \text{ }^\circ\text{C}$ (No change from standard setting)

Thermostat OFF

- $\Delta Trs \leq -2.0 \text{ }^\circ\text{C}$ for 5 minutes continuously.
- $\Delta Trs \leq 4.5 \text{ }^\circ\text{C}$

Capacity

When "low humidity application" is selected. Field setting 16(26)-2-03:

Outdoor Temp. (°C-DB)	Indoor Temp. (°C-WB)							
	11	14	16	18	19	20	22	24
	Capacity (% of standard point)							
-15	0.62	0.76	0.86	0.95	1.00	1.02	1.07	1.11
-10	0.62	0.76	0.86	0.95	1.00	1.02	1.07	1.11
-5	0.62	0.81	0.91	1.01	1.06	1.16	1.21	1.26
0	0.62	0.81	0.91	1.01	1.06	1.16	1.21	1.26
5	0.62	0.81	0.91	1.01	1.06	1.16	1.21	1.26
10	0.62	0.81	0.91	1.01	1.06	1.16	1.21	1.26
15	0.62	0.81	0.91	1.01	1.12	1.14	1.19	1.24
20	0.62	0.81	0.91	1.07	1.10	1.12	1.16	1.21
25	0.62	0.81	0.91	1.05	1.07	1.09	1.13	1.18
30	0.61	0.81	0.91	1.01	1.04	1.06	1.10	1.14
35	0.61	0.81	0.94	0.98	1.00	1.02	1.06	1.11
40	0.61	0.81	0.90	0.94	0.96	0.98	1.02	1.06

Capacity

When "low humidity application + freeze up operation prevention" is selected. Field setting 16(26)-2-04:

Outdoor Temp. (°C-DB)	Indoor Temp. (°C-WB)							
	11	14	16	18	19	20	22	24
	Capacity (% of standard point)							
-15	0.51	0.68	0.78	0.95	1.01	1.06	1.16	1.26
-10	0.51	0.68	0.78	0.95	1.01	1.06	1.16	1.26
-5	0.51	0.68	0.78	0.95	1.01	1.06	1.16	1.26
0	0.51	0.68	0.78	0.95	1.01	1.06	1.16	1.26
5	0.51	0.68	0.78	0.95	1.01	1.06	1.16	1.26
10	0.51	0.68	0.78	0.95	1.01	1.06	1.16	1.26
15	0.51	0.68	0.78	0.95	1.01	1.06	1.16	1.24
20	0.51	0.68	0.78	0.95	1.01	1.06	1.16	1.21
25	0.51	0.68	0.78	0.95	1.00	1.06	1.13	1.18
30	0.51	0.68	0.78	0.95	1.00	1.05	1.10	1.14
35	0.51	0.68	0.78	0.95	1.00	1.02	1.06	1.11
40	0.51	0.67	0.78	0.94	0.96	0.98	1.02	1.06

- Note:**
- Operation range on indoor side expanded from minimum 12°CWB to 11°CWB when using LH setting.
 - Do not use a setpoint below 20°C to avoid operation out of the indoor operation range (11°CWB).
 - Be sure to set the indoor fan to high speed.

2.15 Defrost Start Setting

Refer to 'Defrost Operation' on P40.

3. Test Run and Operation Data

3.1 General Operation Data

Guide Lines for Optimal Operation Condition

The operation value guide lines when operating under standard conditions (**at Rated frequency**) by pushing the test run button on the remote controller are as given in the table below.

Indoor Unit Fan:

“H” Operation Compressor: Rated Frequency

	High Pressure (Mpa)	Low Pressure (Mpa)	Discharge Pipe Temperature (°C)	Suction Temperature (°C)	Indoor Unit Side: Differential Between Suction Temperature and Discharge Temperature (°C)	Outdoor Unit Side: Differential Between Suction Temperature and Discharge Temperature (°C)
Cooling	26 bar ~ 34 bar	6 bar ~ 10 bar	60~100	-2~10	8~18	7~12
Heating	25 bar ~ 32.6 bar	5.3 bar ~ 7.5 bar	60~100	-6~2	14~30	2~6

Standard Conditions

	Indoor Unit Conditions	Outdoor Unit Conditions
Cooling Operation	27°C DB/19°C WB	35°C DB
Heating Operation	20°C DB	7°C DB/6°C WB

During or after maintenance, when the power supply is turned back on, operation restarts automatically by the “auto restart function.” Please exercise the proper caution.

When performing maintenance, you should at least perform the following inspections:

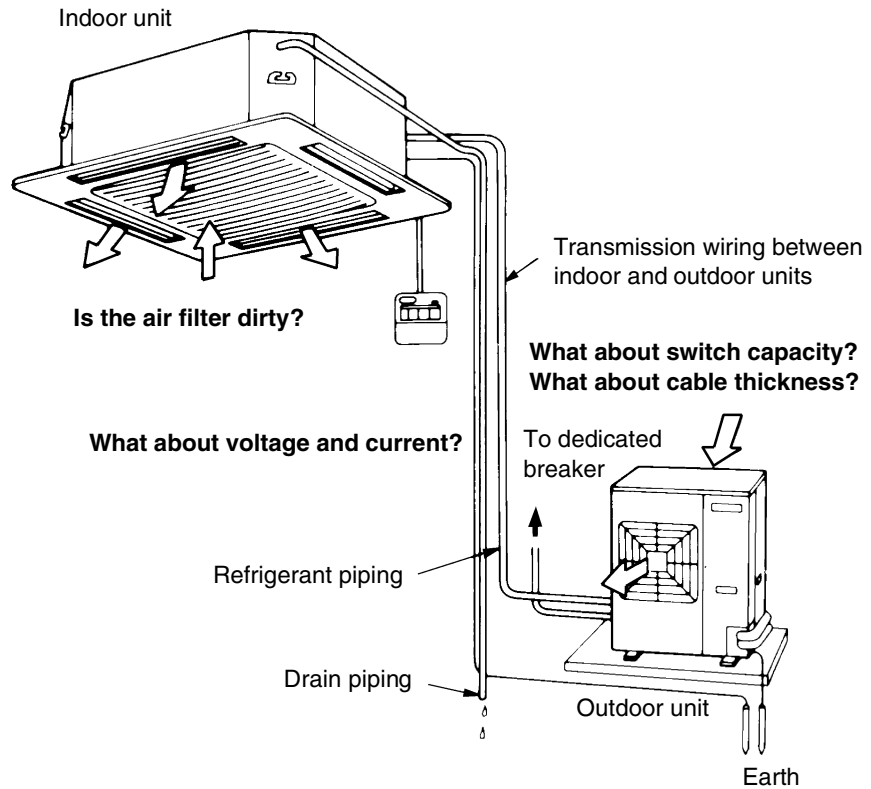

Correlation of Air-Conditioner's Operation Status and Pressure / Running Current

What happens in comparison to normal values is summarized in the table below.
(Measured from 15 ~ 20 minutes or more after operation starts.)

When Cooling

Air-Conditioner Status	Low Pressure	High Pressure	Running Current
Air Filter Fouling	Lower	Lower	Lower
Short Circuit of Indoor Unit Inlet/Outlet Air	Lower	Lower	Lower
Outdoor Unit Fin Fouling	Higher	Higher	Higher
Short Circuit of Outdoor Unit Inlet/Outlet Air	Higher	Higher	Higher
Air Mixed in Refrigerant	Higher	Higher	Higher
Water Mixed in Refrigerant	*1 Lower	Lower	Lower
Dirt Mixed in Refrigerant	*2 Lower	Lower	Lower
Lack of Refrigerant (Gas)	Lower	Lower	Lower
Unsatisfactory Compression	*3 Higher	Lower	Lower

When Heating

Air-Conditioner Status	Low Pressure	High Pressure	Running Current
Air Filter Fouling	Higher	Higher	Higher
Short Circuit of Indoor Unit Inlet/Outlet Air	Higher	Higher	Higher
Outdoor Unit Fin Fouling	Lower	Lower	Lower
Short Circuit of Outdoor Unit Inlet/Outlet Air	Lower	Lower	Lower
Air Mixed in Refrigerant	Higher	Higher	Higher
Water Mixed in Refrigerant	*1 Lower	Lower	Lower
Dirt Mixed in Refrigerant	*2 Lower	Lower	Lower
Lack of Refrigerant (Gas)	Lower	Lower	Lower
Unsatisfactory Compression	*3 Higher	Lower	Lower

- Notes:**
- *1. Water in the refrigerant freezes inside the capillary tube or expansion valve, and is basically the same phenomenon as pump down.
 - *2. Dirt in the refrigerant clogs filters inside the piping, and is basically the same phenomenon as pump down.
 - *3. Pressure differential between high and low pressure becomes low.

3.2 Operation Range

Conditions

The illustrations in this section are based on the following conditions:

- Equivalent piping length: 7.5 m
- Level difference: 0 m
- Air flow rate: High.

**Operation range:
Cooling**

The illustration below shows the operation range.

- RZQ Series

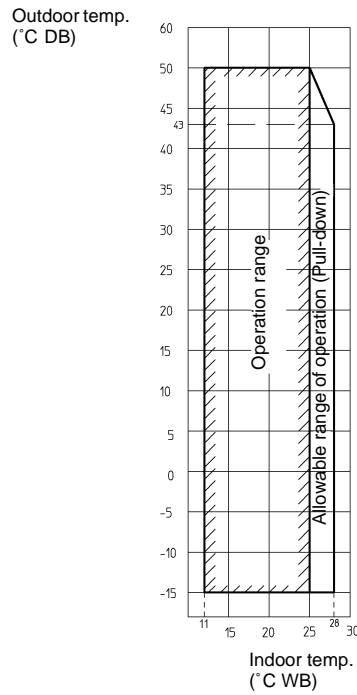

**Operation range:
Heating**

The illustration below shows the operation range.

- RZQ Series

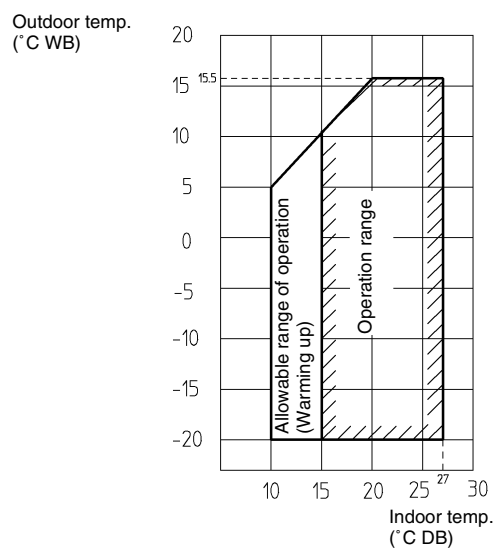

- Notes:**
- Depending on operation and installation conditions, the indoor unit can change over to freeze-up operation (Indoor de-icing).
 - To reduce the freeze-up operation (Indoor de-icing) frequency it is recommended to install the outdoor unit in a location not exposed to wind.

Part 6

Troubleshooting

1. How to Handle Request for Maintenance	117
1.1 General Troubleshooting Flowchart	117
2. Troubleshooting Based on Equipment Condition	118
2.1 Overview of General Problems	118
2.2 Equipment does not Operate	119
2.3 Indoor Fan Operates, but Compressor does not	121
2.4 Cooling/Heating Operation Starts but Stops Immediately	123
2.5 After Unit Shuts Down, It cannot be Restarted for a While	125
2.6 Equipment Operates but does not Provide Cooling	127
2.7 Equipment Operates but does not Provide Heating	129
2.8 Equipment Discharges White Mist	131
2.9 Equipment Produces Loud Noise or Shakes	132
2.10 Equipment Discharges Dust	134
2.11 Remote Controller LCD Displays "88"	135
2.12 Swing Flap does not Operate	136
3. Procedure of Self-Diagnosis by Remote Controller	138
3.1 The Inspection/Test Button	138
3.2 Fault-diagnosis by Wired Remote Controller	139
3.3 Fault-diagnosis by Wireless Remote Controller	140
3.4 Remote Controller Display Malfunction Code and Contents	144
4. Troubleshooting by LED Indications	146
4.1 Troubleshooting by LED on the Indoor Units	146
4.2 Troubleshooting by LED on Outdoor Unit PC Board	147
5. Troubleshooting by Remote Controller Display / LED Display	148
5.1 Indoor Malfunctions	148
5.2 Outdoor Malfunctions	149
5.3 System Malfunctions	150
5.4 Overview of the Outdoor Safety Devices	151
5.5 Overview of the Indoor Safety Devices	152
5.6 "R1" Malfunctioning Indoor PC Board	153
5.7 "R3" Malfunction of Drain Water Level System	154
5.8 "R5" Indoor Unit Fan Motor Lock	156
5.9 "R7" Swing Flap Motor Malfunction / Lock	158
5.10 "RF" Malfunctioning Drain System	160
5.11 "RJ" Malfunctioning Capacity Setting	162
5.12 "C4", "C9" Thermistor Abnormality	164
5.13 "CU" Malfunctioning Remote Controller Air Thermistor	166
5.14 "CL" Humidity Sensor System Malfunction	167
5.15 "E1" Failure of Outdoor Unit PC Board	168
5.16 "E3" Abnormal High Pressure (Detected by the HPS)	169
5.17 "E4" Actuation of Low Pressure Sensor: Single phase C Series	171
5.18 "E5" Compressor Motor Lock	173
5.19 "E7" Malfunction of Outdoor Unit Fan Motor	175
5.20 "E9" Malfunction of Electronic Expansion Valve	178
5.21 "F3" Malfunctioning in Discharge Pipe Temperature	181

5.22	"H3" Malfunctioning HPS System	183
5.23	"H9", "J3", "J5", "J6", "J7", "J8" Malfunction of Thermistor System	184
5.24	"J1" Malfunction of Pressure Sensor	185
5.25	"L1" Faulty Outdoor PC Board	187
5.26	"L4" Radiation Fin Temperature Increased	189
5.27	"L5" DC Output Overcurrent (Instantaneous).....	191
5.28	"L8" Electronic Thermal (Time Lag)	193
5.29	"L9" Stall Prevention (Time Lag)	195
5.30	"LC" Malfunction of Transmission System (between Control and Inverter PC Board)	197
5.31	"P1" Open Phase or Power Supply Voltage Imbalance	199
5.32	"P4" Malfunction of Radiator Fin Temperature Thermistor	200
5.33	"PJ" Failure of Capacity Setting	201
5.34	"UD" Gas Shortage (Malfunction)	202
5.35	"U2" Abnormal Power Supply Voltage.....	204
5.36	"U4", "UF" Malfunction of Transmission between Indoor and Outdoor Unit.....	206
5.37	"UF" Malfunction of Transmission between Indoor and Outdoor Unit / Piping and Wiring Mismatch / Gas Shortage.....	209
5.38	"U5" Malfunction of Transmission between Indoor Unit and Remote Controller	210
5.39	"U8" Malfunction of Transmission between MAIN Remote Controller and SUB Remote Controller.....	211
5.40	"UR" Malfunctioning Field Setting Switch.....	212
5.41	"UL" Centralized Address Setting Error	214

1. How to Handle Request for Maintenance

1.1 General Troubleshooting Flowchart

Find out the situation according to the following procedure when there is a request for service from the customer.

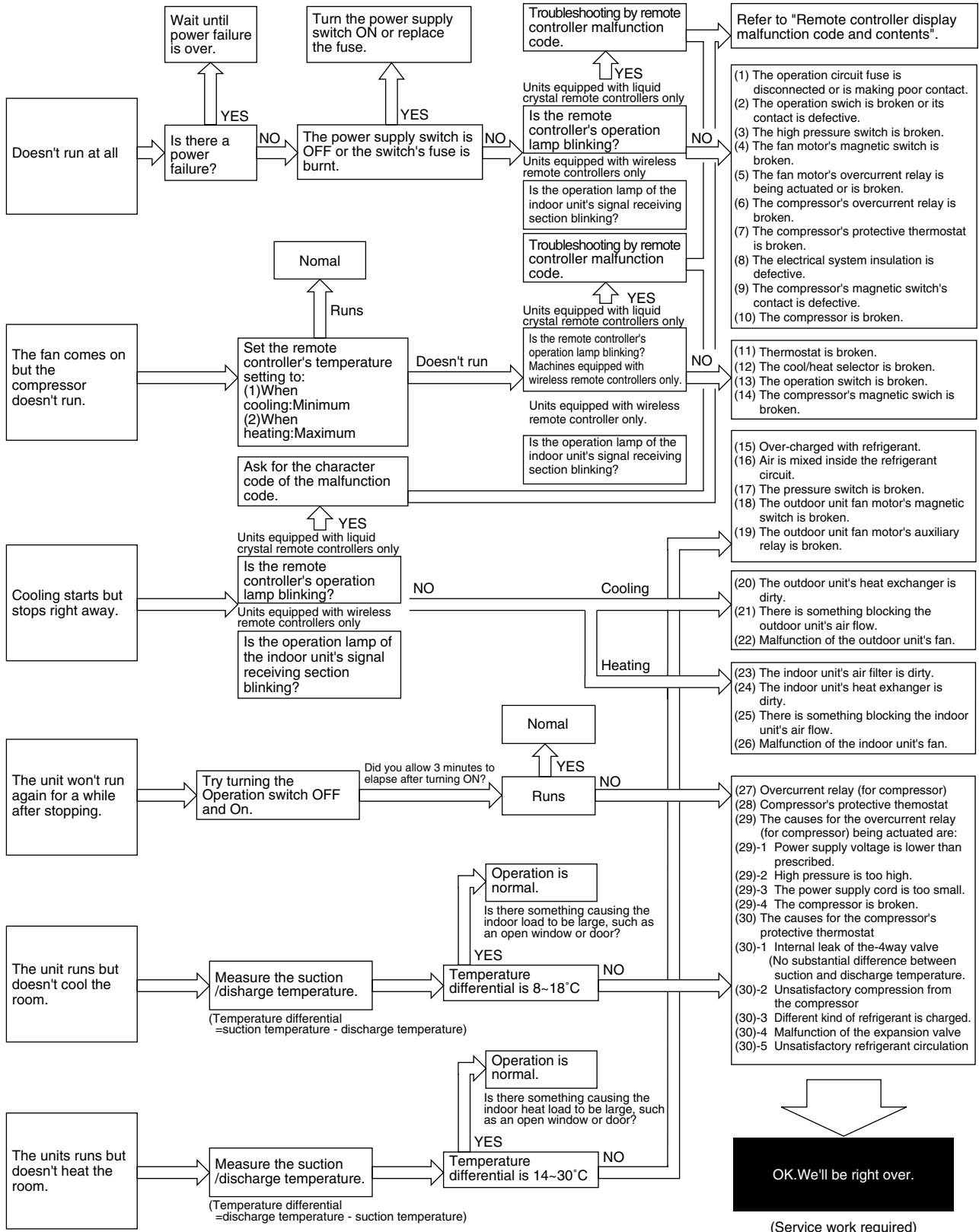

(S1989)

2. Troubleshooting Based on Equipment Condition

2.1 Overview of General Problems

Overview

	Equipment Condition	Remedy
1	Equipment does not operate.	See page 119
2	Fan operates, but compressor does not.	See page 121
3	Cooling/heating operation starts but stops immediately.	See page 123
4	After unit shuts down, it cannot be restarted for a while.	See page 125
5	Equipment operates but does not provide cooling.	See page 127
6	Equipment operates but does not provide heating.	See page 129
7	Equipment discharges white mist.	See page 131
8	Equipment produces loud noise or shakes.	See page 132
9	Equipment discharges dust.	See page 134
10	Remote controller LCD displays "88."	See page 135
11	Indoor swing flap does not operate.	See page 136
12	Equipment emits odor.	Room smell and cigarette odors accumulated inside the indoor unit are discharged with air. Inside of the indoor unit must be cleaned.
13	Flap operates when power is turned on.	It is normal. The flap initializes for accurate positioning.
14	Change of operation mode causes flap to move.	It is normal. There is a control function that moves the flap when operation mode is changed.
15	Fan operates in "M" mode during heating even if remote controller is set to "Low."	It is normal. It is caused by the activation of the overload control (airflow shift control).
16	Flap automatically moves during cooling.	It is normal. It is caused by the activation of the dew prevention function or ceiling soiling prevention function.
17	Indoor unit fan operates in "L" mode for 1 minute in microcomputer-controlled dry mode even if compressor is not operating.	It is normal. The monitoring function forcibly operates the fan for one minute.
18	In simultaneous ON/OFF multi-system setup, indoor unit (sub) does not operate in sync with the other indoor unit (main). (Flat, fan, etc.)	It is normal. It is caused by a signal transmission lag.
19	Indoor unit fan operates after heating operation stops.	It is normal. The fan operates in the "LL" mode for 60 to 100 seconds to dissipate the residual heat in the heater.
20	Drain pump operates when equipment is not operating.	It is normal. The drain pump continues to operate for several minutes after equipment is turned off.
21	Horizontal swing sends air to different directions in cooling and heating even if it is set to the same position.	It is normal. The airflow direction in cooling/dry operation is different from that in heating/fan operation.
22	Flap remains horizontal even if it is set to Swing.	It is normal. The flap does not swing in the thermostat OFF mode.

2.2 Equipment does not Operate

Applicable Model All models of SkyAir series

Error Detection Method

Error Generating Condition

Supposed Causes

- Fuse blown or disorder of contact in operation circuit
- Faulty operation switch or contact point
- Faulty high pressure switch
- Faulty magnetic switch for fan motor
- Activation or fault of overcurrent relay for fan motor
- Faulty overcurrent relay for compressor
- Faulty compressor protection thermostat
- Insufficient insulation in electric system
- Faulty contact point of magnetic switch for compressor
- Malfunction of compressor
- Defective remote controller or low batteries (wireless)
- Check if address is set correctly on wireless R.C.

Troubleshooting



Caution

Be sure to turn off power switch before connect or disconnect connector, or parts damage may be occurred.

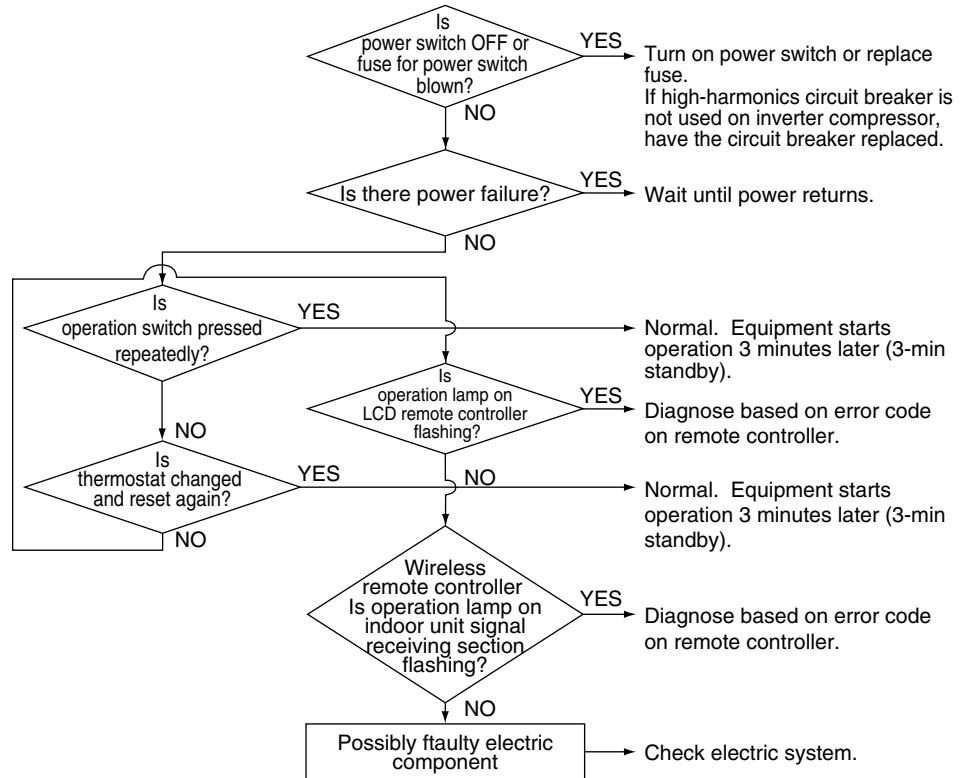

(S2575)

2.3 Indoor Fan Operates, but Compressor does not

Applicable Model All models of SkyAir series

Method of Malfunction Detection

Malfunction Decision Conditions

Supposed Causes

- Faulty thermistor
- Faulty indoor/outdoor unit PC board
- Faulty magnetic switch
- Faulty power transistor
- Faulty compressor

Troubleshooting



Caution Be sure to turn off power switch before connect or disconnect connector, or parts damage may be occurred.

- Indoor unit fan runs at set airflow rate.
- (In cooling operation)
When air thermistor ambient temperature is higher than set temperature
- (In heating operation)
When air thermistor ambient temperature is lower than set temperature

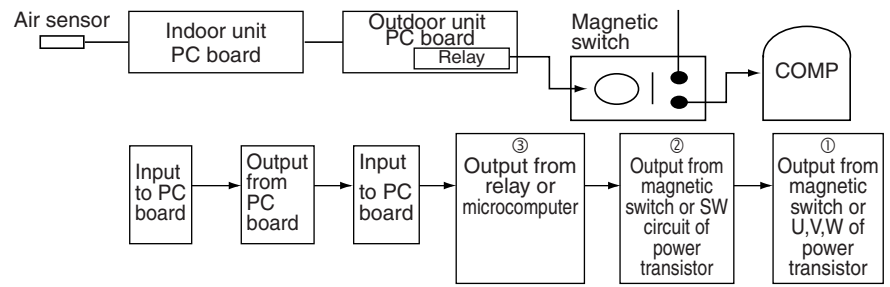
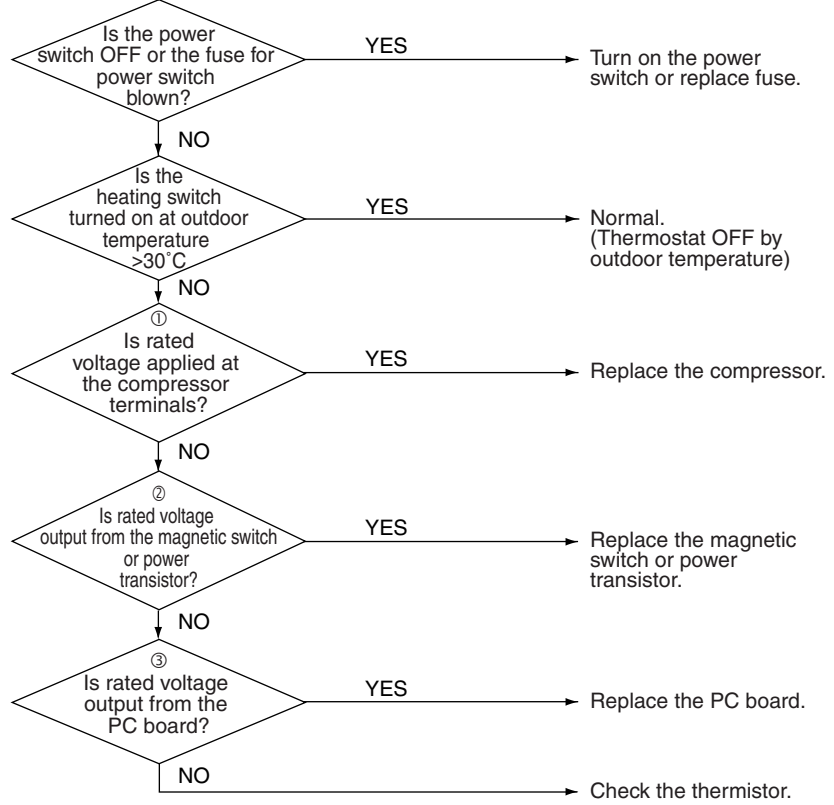

(S2576)

2.4 Cooling/Heating Operation Starts but Stops Immediately

Applicable Model All models of SkyAir series

Error Detection Method

Error Generating Condition

Supposed Causes

- Excess charge of refrigerant
- Air intrudes into refrigerant system
- Faulty pressure switch
- Faulty magnetic switch for outdoor unit fan motor
- Faulty aux. relay for outdoor unit fan motor
- Soiled heat exchanger of outdoor unit
- There is an interfering item in air flow of outdoor unit
- Malfunction of outdoor unit fan
- Soiled air filter of indoor unit
- Soiled heat exchanger of indoor unit
- There is some interfering item in airflow of indoor unit
- Malfunction of indoor unit fan

Troubleshooting



Caution Be sure to turn off power switch before connect or disconnect connector, or parts damage may be occurred.

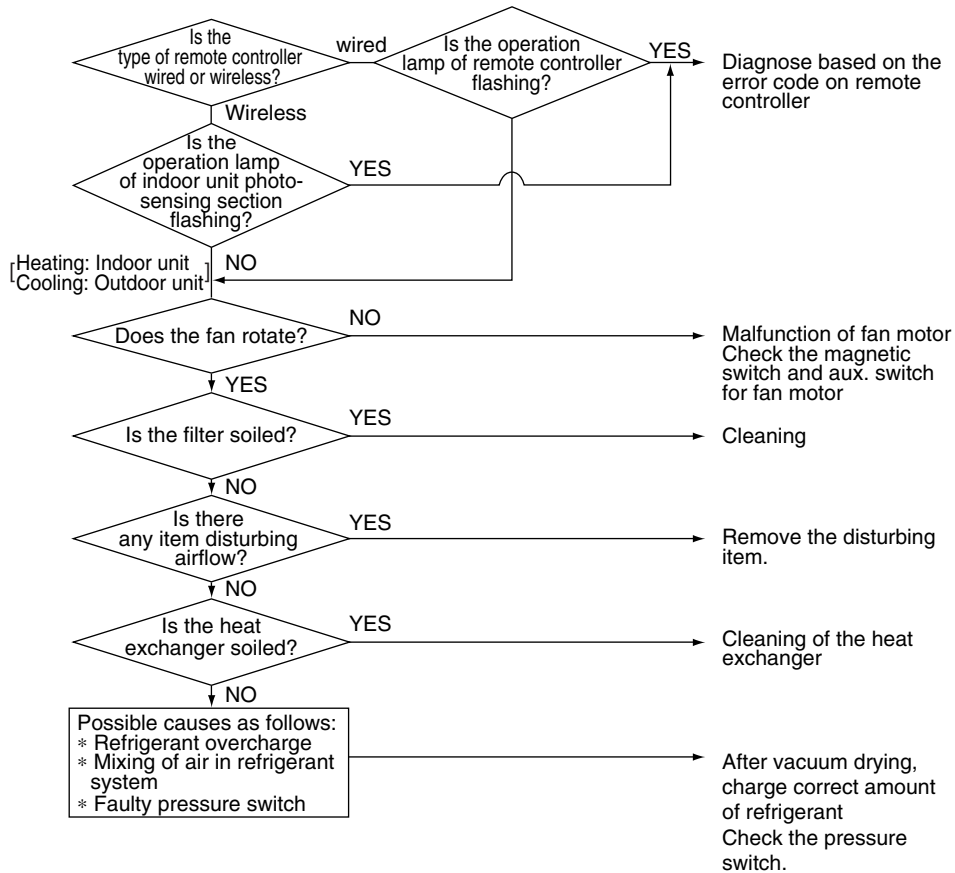

(S1992)

2.5 After Unit Shuts Down, It cannot be Restarted for a While

Applicable Model All models of SkyAir series

Error Detection Method

Error Generating Condition

Supposed Causes

- Overcurrent relay (for compressor)
- Compressor protection thermostat
- Overcurrent relay may act due to the following reasons
 - Lower voltage of power supply
 - Excess level of high pressure
 - Insufficient size of power cable
 - Malfunction of compressor
- Compressor protection thermostat may act due to the following reasons
 - Internal leakage of four-way valve (There is no difference between suction and discharge temperature)
 - Insufficient compression of compressor
 - Incorrect refrigerant
 - Faulty expansion valve
 - Insufficient circulation of refrigerant

Troubleshooting



Caution

Be sure to turn off power switch before connect or disconnect connector, or parts damage may be occurred.

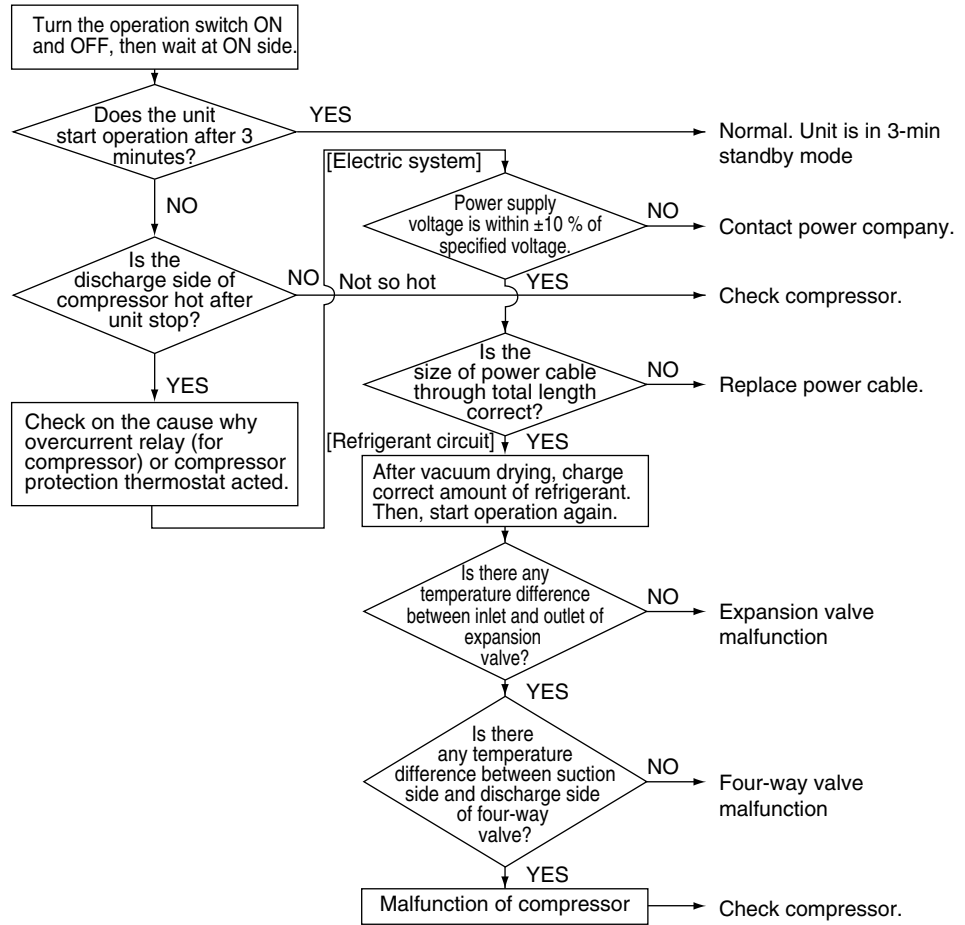

(S1993)

2.6 Equipment Operates but does not Provide Cooling

Applicable Model All models of SkyAir series

Error Detection Method

Error Generating Condition

Supposed Causes

- Overcurrent relay (for compressor)
- Compressor protection thermostat
- Overcurrent relay may act due to the following reasons
 - Lower voltage of power supply
 - Excess level of high pressure
 - Insufficient size of power cable
 - Malfunction of compressor
- Compressor protection thermostat may act due to the following reasons
 - Internal leakage of four-way valve (There is no difference between suction and discharge temperature)
 - Insufficient compression of compressor
 - Incorrect refrigerant charge/leak
 - Faulty expansion valve
 - Insufficient circulation of refrigerant
- Malfunction of thermistors or thermistor out of position.

Troubleshooting



Caution Be sure to turn off power switch before connect or disconnect connector, or parts damage may be occurred.

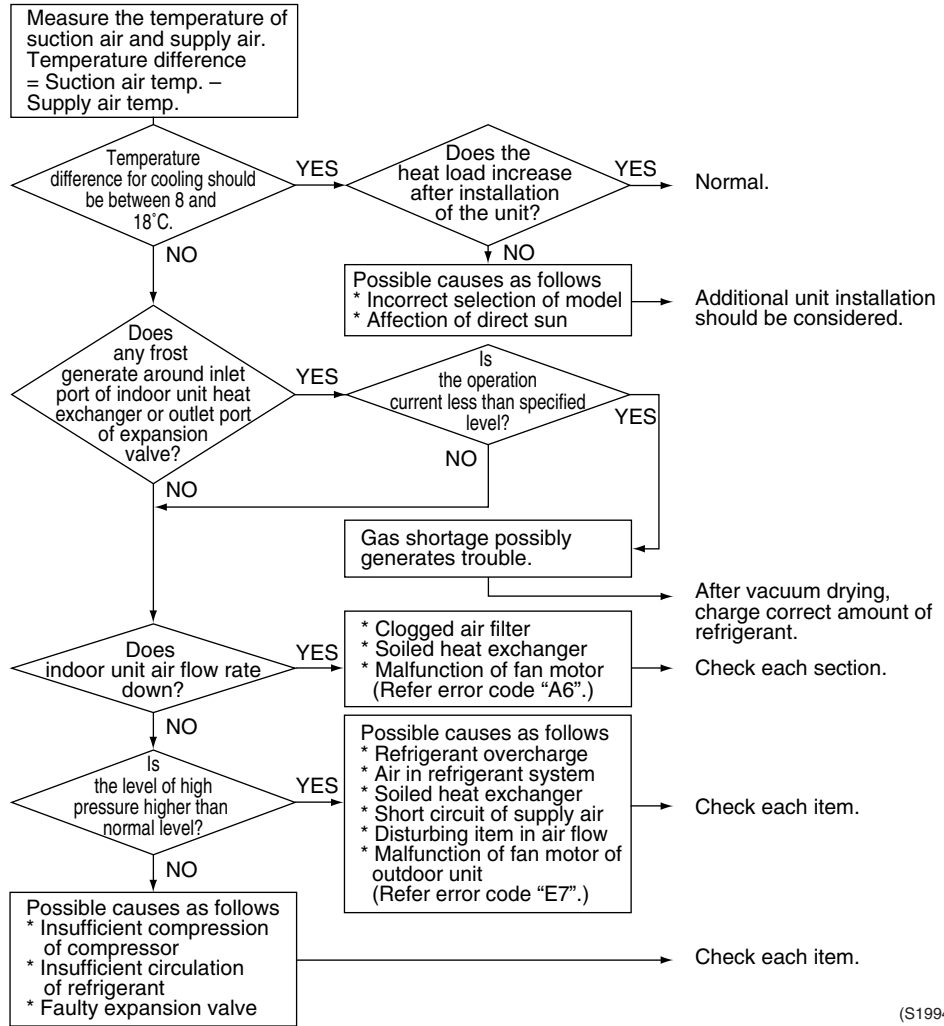

(S1994)

2.7 Equipment Operates but does not Provide Heating

Applicable Model All models of SkyAir series

Error Detection Method

Error Generating Condition

Supposed Causes

- Excess charge of refrigerant
- Air intrudes into refrigerant system
- Faulty pressure switch
- Faulty magnetic switch for outdoor unit fan motor
- Faulty aux. relay for outdoor unit fan motor
- Soiled heat exchanger of outdoor unit
- There is an interfering item in air flow of outdoor unit
- Malfunction of outdoor unit fan
- Soiled air filter of indoor unit
- Soiled heat exchanger of indoor unit
- There is some interfering item in airflow of indoor unit
- Malfunction of indoor unit fan

Troubleshooting



Caution

Be sure to turn off power switch before connect or disconnect connector, or parts damage may be occurred.

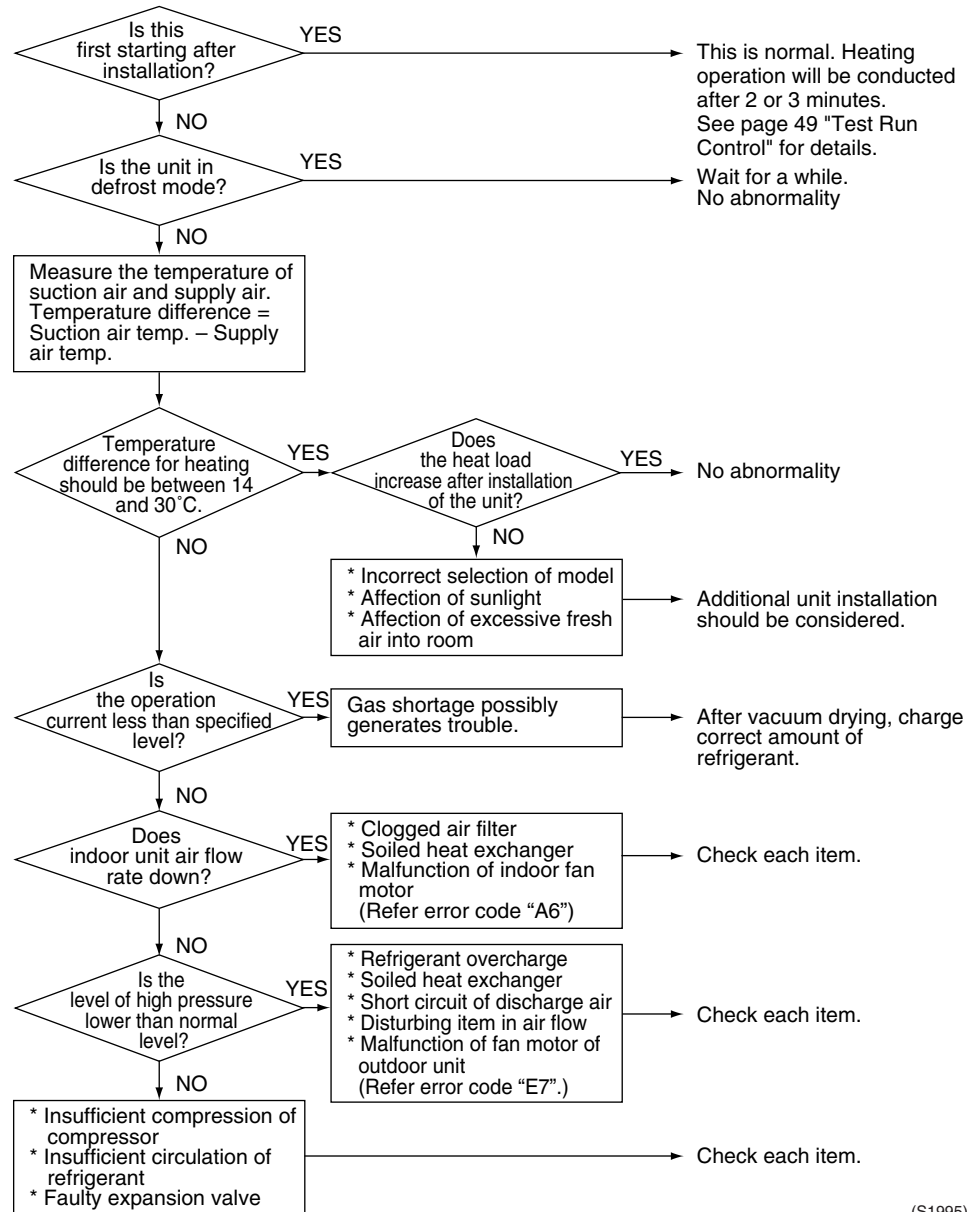

(S1995)

2.8 Equipment Discharges White Mist

Applicable Model All models of SkyAir series

Error Detection Method

Error Generating Condition

- Supposed Causes**
- Humid installation site
 - Installation site is dirty and with dense oil mists.
 - Soiled heat exchanger
 - Clogged air filter
 - Malfunction of fan motor

Troubleshooting

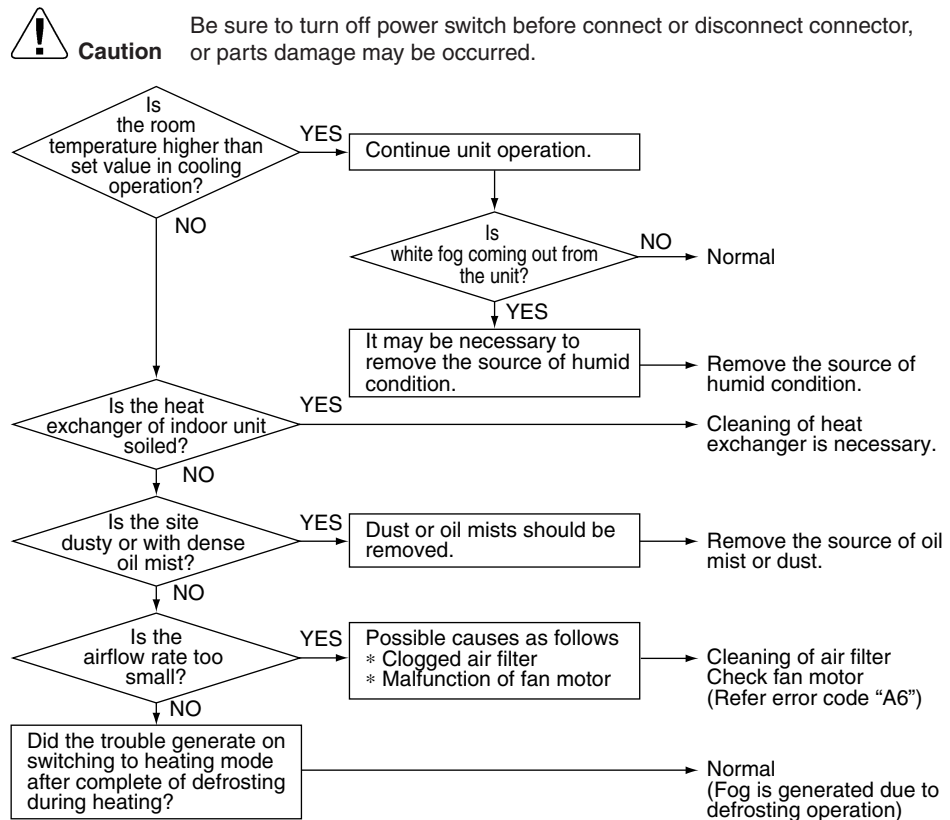

(S1996)

2.9 Equipment Produces Loud Noise or Shakes

Applicable Model All models of SkyAir series

Error Detection Method

Error Generating Condition

Supposed Causes

- Faulty installation
- Excess charge of refrigerant
- Air intrudes into refrigerant system
- Flushing noise due to refrigerant shortage. (Sound of shoo...)

Troubleshooting



Caution

Be sure to turn off power switch before connect or disconnect connector, or parts damage may be occurred.

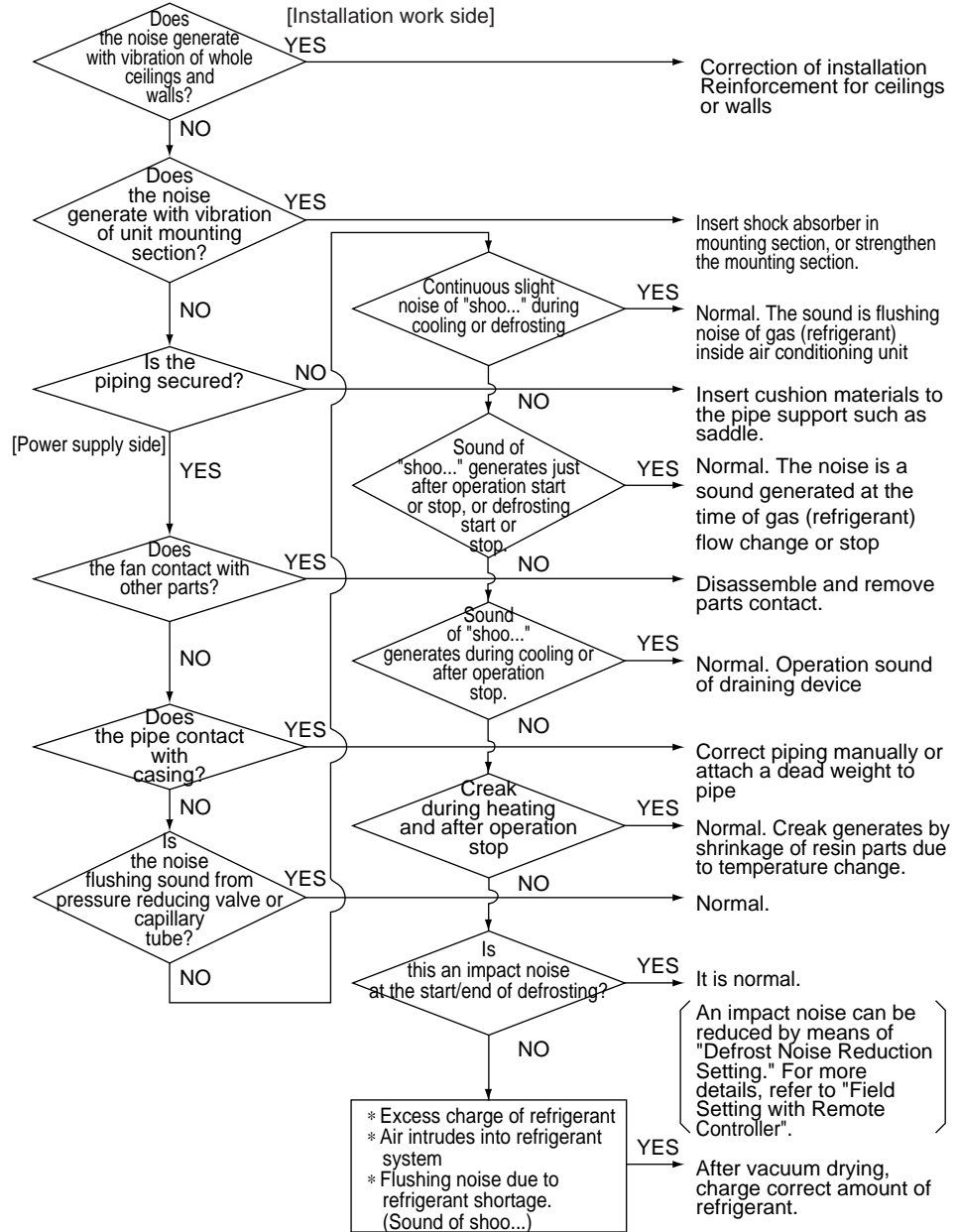

(S1997)

2.10 Equipment Discharges Dust

Applicable Model All models of SkyAir series

Error Detection Method

Error Generating Condition

- Supposed Causes**
- Carpet
 - Animal's hair
 - Application (cloth shop,...)

Troubleshooting



Caution

Be sure to turn off power switch before connect or disconnect connector, or parts damage may be occurred.

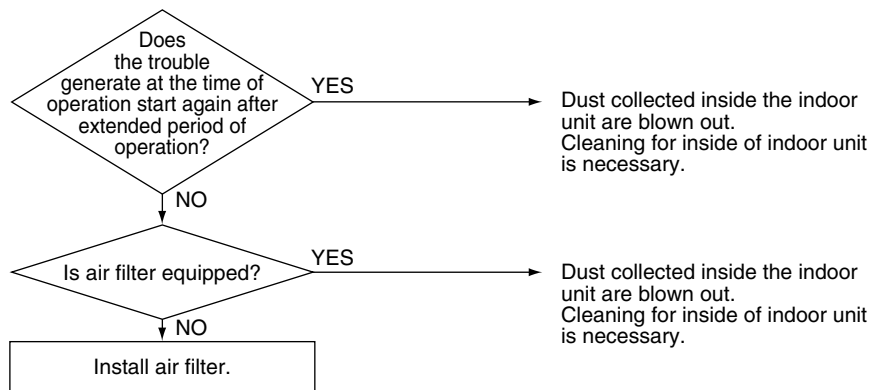

(S1998)

2.11 Remote Controller LCD Displays "88"

Applicable Model All models of SkyAir series

Error Detection Method

Error Generating Condition

Supposed Causes

Troubleshooting

 **Caution** Be sure to turn off power switch before connect or disconnect connector, or parts damage may be occurred.

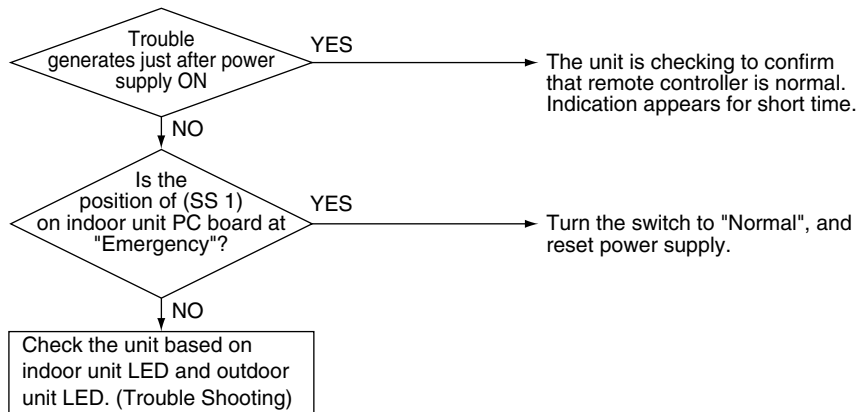

(S1999)

2.12 Swing Flap does not Operate

Applicable Models	FBQ, FHQ, FAQ, FUQ
Method of Malfunction Detection	Utilizes ON/OFF of the limit switch when the motor turns.
Malfunction Decision Conditions	When ON/OFF of the micro switch for positioning cannot be reversed even through the swing flap motor for a specified amount of time (about 30 seconds).
Remark	<p>Some functions can force the swing flap into a fixed position, although swing mode is selected on the remote controller. This is not an unit error, but a control function to prevent draft to the customer.</p> <p>Before starting the troubleshooting, make sure the swing flap is not forced into such a fixed position. (e.g. Hot start, defrost operation, thermostat OFF in heating operation or freeze prevention in cooling operation. For details see "Fan and Flap Operations" on P77)</p>
Supposed Causes	<ul style="list-style-type: none"> ■ Faulty swing motor ■ Faulty micro switch ■ Faulty connector connection ■ Faulty indoor unit PC board

Troubleshooting



Caution

Be sure to turn off power switch before connect or disconnect connector, or parts damage may be occurred.

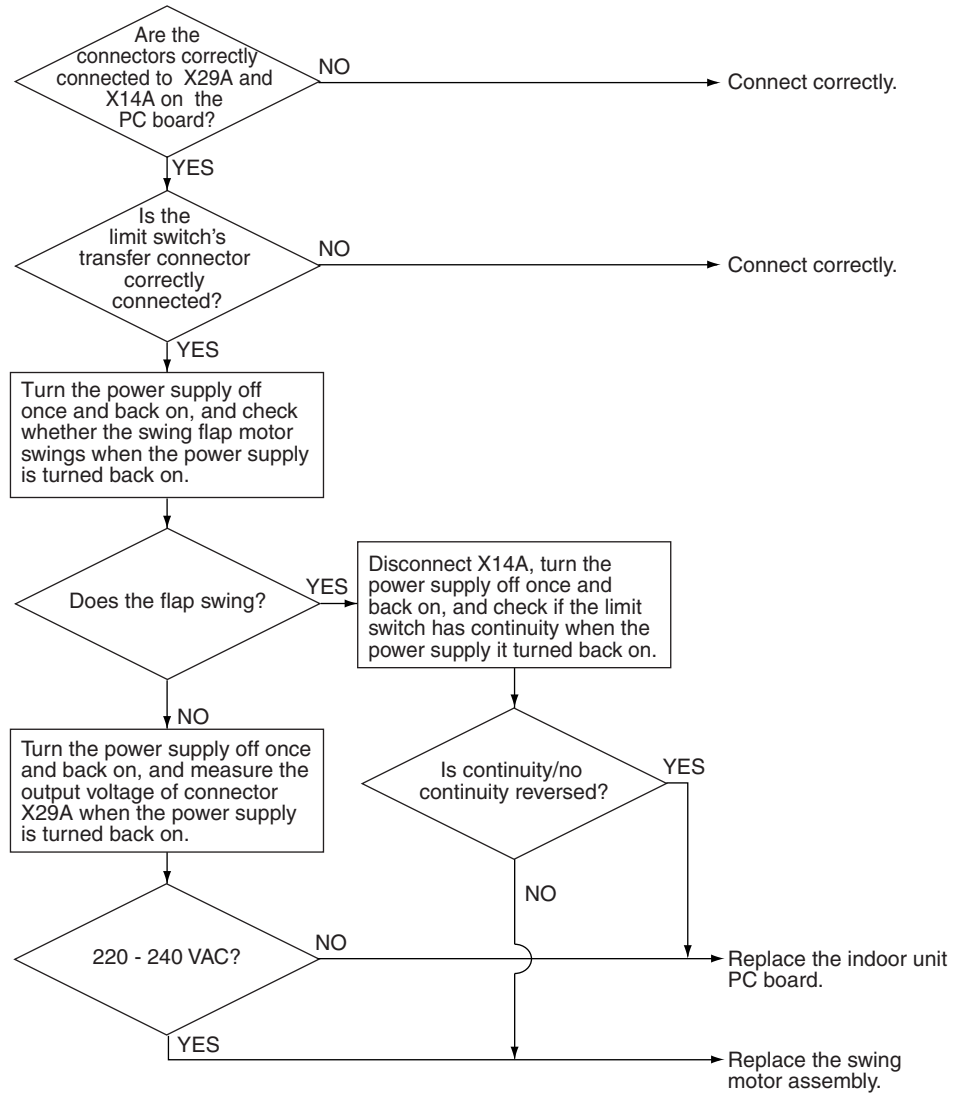

(S2577)

3. Procedure of Self-Diagnosis by Remote Controller

3.1 The Inspection/Test Button

The following modes can be selected by using the [Inspection/Test Operation] button on the remote control.

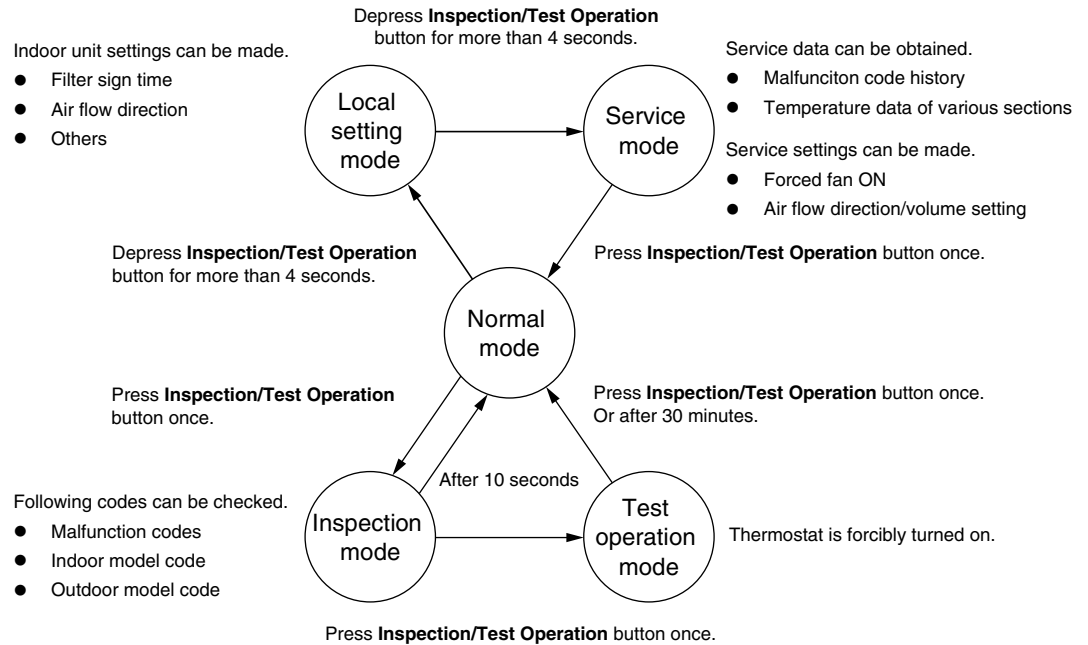

3.2 Fault-diagnosis by Wired Remote Controller

Explanation

If operation stops due to malfunction, the remote controller's operation LED blinks, and malfunction code is displayed. (Even if stop operation is carried out, malfunction contents are displayed when inspection mode is entered.) The malfunction code enables you to tell what kind of malfunction caused operation to stop. Refer to P144 for malfunction code and malfunction contents.

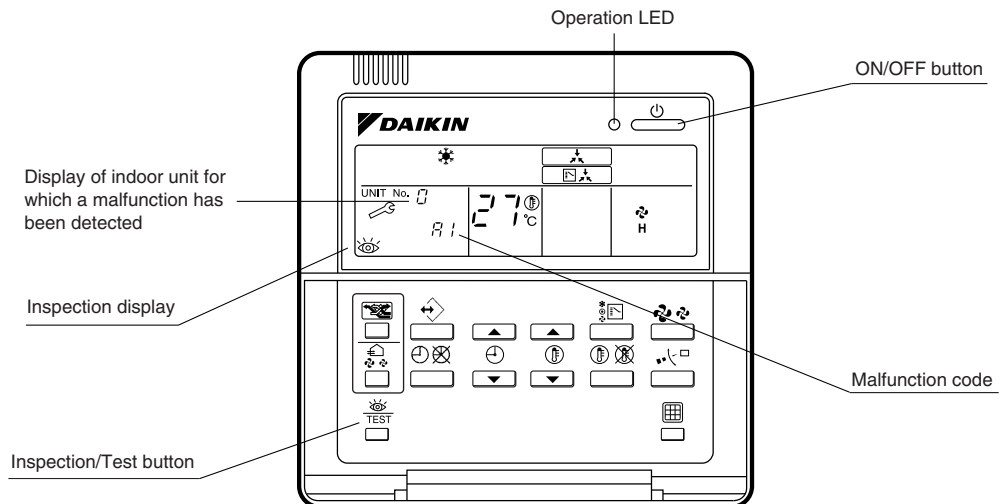

Note:

1. Pressing the INSPECTION/TEST button will blink the check indication.
2. While in check mode, pressing and holding the ON/OFF button for a period of five seconds or more will clear the failure history indication shown above. In this case, on the codes display, the malfunction code will blink twice and then change to "00" (=Normal), the Unit No. will change to "0", and the operation mode will automatically switch from check mode to normal mode (displaying the set temperature).

3.3 Fault-diagnosis by Wireless Remote Controller

Introduction

Contrary to the wired remote controller, the wireless remote controller does not display the error code. Instead, the operation LED on the light reception section flashes.

Checking

To find the error code, proceed as follows:

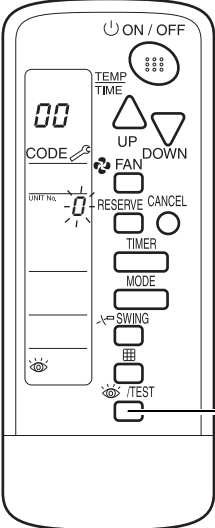
Step	Action
1	<p>Press the INSPECTION/TEST button to select "inspection". The equipment enters the inspection mode. "0" flashes in the UNIT No. display.</p>  <p>The diagram shows a vertical remote controller with various buttons. At the top is an ON/OFF button. Below it are buttons for TEMP TIME, UP, and DOWN. Further down are CODE, FAN, RESERVE, CANCEL, TIMER, MODE, and SWING buttons. At the bottom is the INSPECTION/TEST button, which is pointed to by a line from the text 'INSPECTION/TEST'.</p>

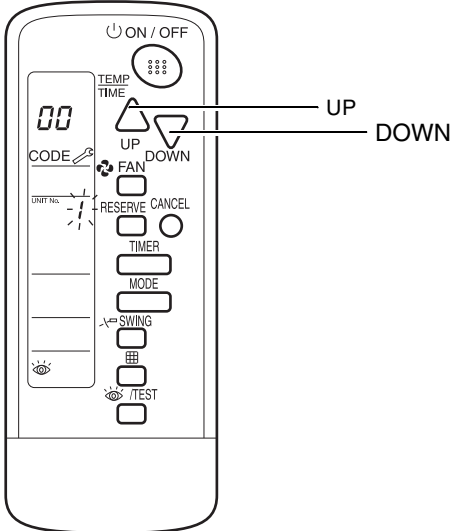
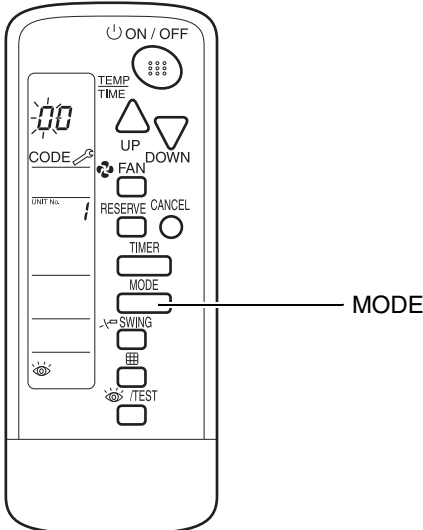
Step	Action								
<p data-bbox="453 239 469 262">2</p>	<p data-bbox="539 239 1452 293">Press the UP or DOWN button and change the UNIT No. until the receiver of the remote controller starts to beep.</p> <div data-bbox="772 309 1225 837" style="text-align: center;">  </div> <table border="1" data-bbox="616 909 1375 1149" style="margin: 10px auto;"> <thead> <tr> <th data-bbox="616 909 995 943">If you hear...</th> <th data-bbox="995 909 1375 943">Then...</th> </tr> </thead> <tbody> <tr> <td data-bbox="616 943 995 976">3 short beeps</td> <td data-bbox="995 943 1375 976">Follow all steps below.</td> </tr> <tr> <td data-bbox="616 976 995 1111">1 short beep</td> <td data-bbox="995 976 1375 1111">Follow steps 3 and 4. Continue the operation in step 4 until you hear a continuous beep. This continuous beep indicates that the error code is confirmed.</td> </tr> <tr> <td data-bbox="616 1111 995 1149">1 continuous beep</td> <td data-bbox="995 1111 1375 1149">There is no abnormality.</td> </tr> </tbody> </table>	If you hear...	Then...	3 short beeps	Follow all steps below.	1 short beep	Follow steps 3 and 4. Continue the operation in step 4 until you hear a continuous beep. This continuous beep indicates that the error code is confirmed.	1 continuous beep	There is no abnormality.
If you hear...	Then...								
3 short beeps	Follow all steps below.								
1 short beep	Follow steps 3 and 4. Continue the operation in step 4 until you hear a continuous beep. This continuous beep indicates that the error code is confirmed.								
1 continuous beep	There is no abnormality.								
<p data-bbox="453 1182 469 1205">3</p>	<p data-bbox="539 1182 1452 1236">Press the MODE selector button. The left "0" (upper digit) indication of the error code flashes.</p> <div data-bbox="785 1252 1209 1780" style="text-align: center;">  </div>								

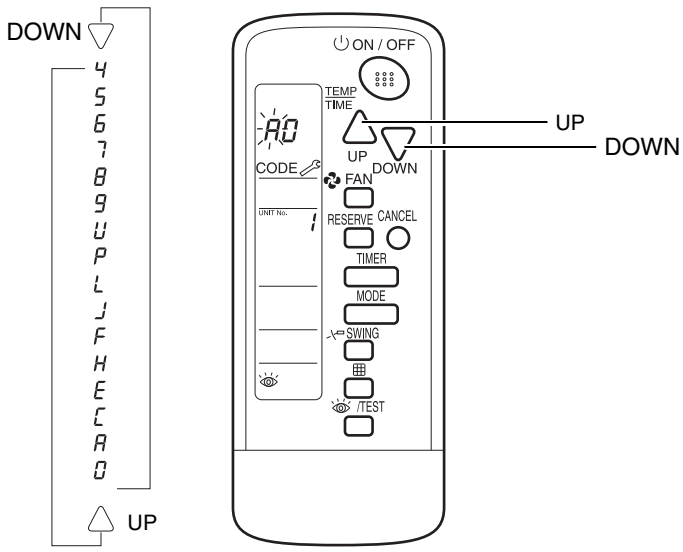
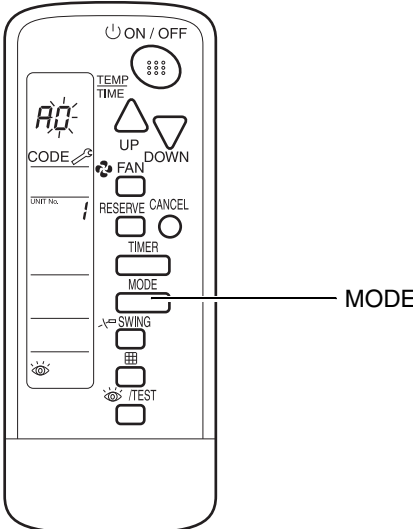
Step	Action								
4	<p>Press the UP or DOWN button to change the error code upper digit until the receiver of the remote controller starts to beep.</p>  <table border="1" data-bbox="614 913 1375 1059"> <thead> <tr> <th>If you hear...</th> <th>Then...</th> </tr> </thead> <tbody> <tr> <td>2 short beeps</td> <td>The upper digit matches.</td> </tr> <tr> <td>1 short beep</td> <td>No digits match.</td> </tr> <tr> <td>1 continuous beep</td> <td>Both upper and lower digits match.</td> </tr> </tbody> </table>	If you hear...	Then...	2 short beeps	The upper digit matches.	1 short beep	No digits match.	1 continuous beep	Both upper and lower digits match.
If you hear...	Then...								
2 short beeps	The upper digit matches.								
1 short beep	No digits match.								
1 continuous beep	Both upper and lower digits match.								
5	<p>Press the MODE selector button. The right "0" (lower digit) indication of the error code flashes.</p> 								

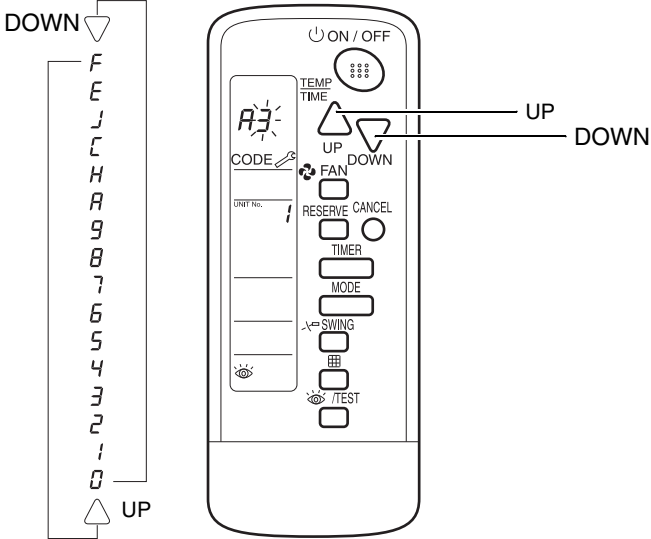
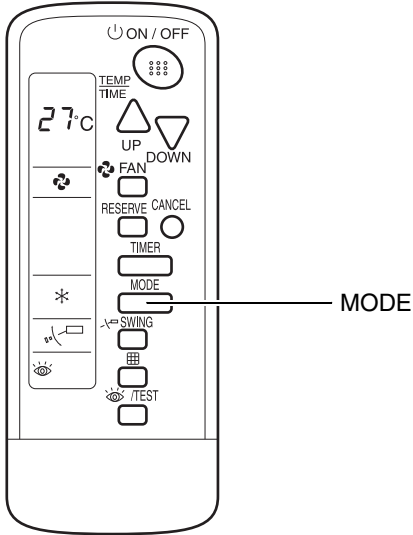
Step	Action
<p>6</p>	<p>Press the UP or DOWN button and change the error code lower digit until the receiver of the remote controller generates a continuous beep.</p> 
<p>7</p>	<p>Press the MODE button to return to normal status. If you do not press any button for at least 1 min, the remote controller returns automatically to normal status.</p> 

3.4 Remote Controller Display Malfunction Code and Contents

Malfunction Code	Contents/Processing	Remarks
A1	Failure of PC board ass'y for indoor unit	
A3	Malfunction of drain water level system	
A6	Indoor unit fan motor overload / overcurrent / lock	(Note 1)
A7	Swing flap motor lock	
AF	Abnormal drain water level	Activation of float switch during compressor off.
AJ	Failure of capacity setting	Either capacity data is set incorrectly, or capacity has not been set for the data IC
C4	Malfunction of heat exchanger temperature sensor system	
C9	Malfunction of suction air temperature sensor system	
CJ	Malfunction of remote control air temperature sensor system	Failure of remote controller air thermistor. Unit can be operated by indoor unit thermistor.
CC	Malfunction of humidity sensor system	
E1	Outdoor unit PC board malfunction	
E3	High pressure malfunction (outdoor unit)	
E4	Abnormality of low pressure (outdoor)	Failure of low pressure sensor system. Check if the stop valve open.
E5	Compressor motor lock malfunction	Compressor motor lock, incorrect wiring.
E7	Outdoor fan motor lock or outdoor fan instantaneous overcurrent malfunction	
E9	Malfunction of electronic expansion valve (outdoor unit)	
F3	Discharge pipe temperature malfunction (outdoor unit)	
H3	Failure of high pressure switch (outdoor unit)	
H9	Malfunction of outdoor air temperature sensor system (outdoor unit)	(Note 2)
J1	Malfunction of pressure sensor	Applicable Models : (Note 3)
J3	Malfunction of discharge pipe temperature sensor system (outdoor unit)	
J3	Malfunction of discharge pipe temperature sensor system (outdoor unit)	Applicable Models : (Note 3)
J5	Suction pipe thermistor malfunction	Failure of suction pipe thermister system
J6	Malfunction of heat exchanger temperature sensor system (outdoor unit)	(Note 2)
J7	Malfunction of subcooling heat exchanger thermistor (outdoor unit)	Applicable Models : (Note 3)
J8	Malfunction of liquid pipe thermistor (outdoor unit)	Applicable Models : (Note 3)
JC	Malfunction of suction pressure sensor	Failure of suction pressure sensor system
L1	Outdoor PC board malfunction	Applicable Models : (Note 3)
L4	Radiation fin temperature rise	Malfunction of inverter cooling
L5	Instantaneous over current	Possibility of compressor motor grounding or shortage of motor winding
L8	Electronic thermal	Possibility of compressor overload, open circuit in compressor motor
L9	Stall prevention	Possibility of compressor seizing
LC	Malfunction of transmission system (between control PC board and inverter PC board)	

Malfunction Code	Contents/Processing	Remarks
P1	Open phase or voltage unbalance	
P4	Abnormal radiation fin temperature sensor (outdoor unit)	
PJ	Failure of capacity setting (outdoor unit)	Either capacity data is set incorrectly, or capacity has not been set for the data IC
U0	Lack of gas malfunction	Abnormal suction pipe temperature Applicable Models : (Note 4)
U0		Abnormal suction pipe temperature Applicable Models : (Note 3)
U0		
U2	Abnormal power supply voltage	Including malfunction of K1M, K2M
U4/UF	Failure of transmission (between indoor and outdoor unit)	Transmission between indoor and outdoor unit is not being correctly carried out. (Note 1, Note 2)
UF	Failure of transmission (between indoor and outdoor unit) or Piping and wiring mismatch or Gas shortage	Transmission between indoor and outdoor unit is not being correctly carried out. or There is very little or no refrigerant flow within the indoor unit Applicable Models : (Note 3)
U5	Failure of transmission (between indoor unit and remote controller)	Transmission between indoor and remote controller is not being correctly carried out.
U8	Failure of transmission (between "main" and "sub" remote controller)	Transmission between "main" and "sub" remote controller is not being correctly carried out.
UA	Failure of fieldsetting	System fieldsetting error pair, twin, triple, double twin or wrong capacity class.
UC	Address error of central remote controller	

: Error code displays automatically and system stops.
Inspect and repair it.

: In the case of the shaded error codes, "inspection" is not displayed. The system operates, but be sure to inspect and repair it.

: Error code displays with blinking.
The system operates, but be sure to inspect and repair it.

- Notes:**
1. There is a possibility of open phase power supply, check power supply also.
 2. Operation when a malfunction occurs may differ according to the model.

4. Troubleshooting by LED Indications

4.1 Troubleshooting by LED on the Indoor Units

Foreword

Troubleshooting can be carried out by service monitor LED (green). (Blinks when normal)

☉ : LED on / ● : LED off / ⚡ : LED blinks / — : No connection with troubleshooting

Microcomputer Normal Monitor	Transmission Normal Monitor	Contents/Processing
HAP (LED-A)	HBP (LED-B)	
⚡	⚡	Indoor unit normal →Outdoor unit trouble shooting
⚡	☉	Incorrect transmission wiring between indoor and outdoor unit
	●	If outdoor unit's LED-A is off, proceed outdoor unit's trouble shooting. If outdoor unit's LED-A blinks, failure of wiring or indoor or outdoor unit P.C board ass'y. (Note 4)
☉	—	Failure of indoor unit PC board ass'y (Note 5)
●		Malfunction of power supply or failure of PC board ass'y or broken transmission wire between indoor and outdoor unit. (Note 5)

- Notes:**
1. When the INSPECTION/TEST button of remote controller is pushed, **INSPECTION** display blinks entering **INSPECTION** mode.
 2. In the **INSPECTION** mode, when the ON/OFF button is pushed and held for 5 seconds or more, the aforementioned malfunctioning history display is off. In this case, after the malfunction code blinks 2 times, the code display turns to "00" (=Normal) and the unit No. turns to "0". The INSPECTION mode automatically switches to the normal mode (set temperature display).
 3. Operation halts due to malfunction depending on the model or condition.
 4. If LED-B is off, the transmission wiring between indoor and outdoor unit may be incorrect or disconnected. Before performing the previously described troubleshooting, check the transmission wiring.
 5. Troubleshoot by turning off the power supply for a minimum of 5 seconds, turning it back on, and then rechecking the LED display.

4.2 Troubleshooting by LED on Outdoor Unit PC Board

The following diagnosis can be conducted by turning on the power switch and checking the LED indication on the printed circuit board of the outdoor unit.

☉ : LED on / ● : LED off / ⚡ : LED blinks / — : No connection with troubleshooting

■ RZQ71~140

LED detection		Description
Microcomputer in normal operation HAP	Error detection H3P	
(Green)	(Red)	
⚡	●	Normal
☉	—	Faulty outdoor unit PC board (Note 1)
●	—	Power supply abnormality, or faulty outdoor unit PC board (Note 2)
⚡	☉	Activation of protection device (Note 3)

- Notes:**
1. Turn off the power switch, and turn it on again after 5 seconds or more. Check the error condition, and diagnose the problem.
 2. Turn off the power switch. After 5 seconds or more, disconnect the connection wire (2). Then turn on the power switch. If the HAP on the outdoor unit PCB flashes after about 10 seconds, the indoor unit PCB is faulty.
 3. Also check for open phase.

Remark: The error detection monitor continues to indication the previously generated error until the power switch is turned off.
Be sure to turn off the power switch after inspection.

5. Troubleshooting by Remote Controller Display / LED Display

Explanation for Symbols

◐ : LED blinks / ◑ : LED on / ● : LED off / — : No connection with troubleshooting

- ◎ : High probability of malfunction
- : Possibility of malfunction
- ◻ : Low probability of malfunction
- : No possibility of malfunction (do not replace)

5.1 Indoor Malfunctions

Indoor Unit Malfunctions	Indoor Unit LED Display Note 2		Remote Controller Display	Location of Malfunction			Contents of Malfunction	Details of Malfunction (Reference Page)	
	H1P	H3P		Other than PC Board	PC Board				
					Outdoor Unit	Indoor Unit			Remote Controller
	◐	◐	*Note 1	—	—	—	—	Normal →to outdoor unit	
	◐	◑	R1	—	—	○	—	Malfunction indoor unit PC board (For troubleshooting by LED, refer to P146.)	
	◐	●							
	◑	—							
	●	—							
	◐	◐	R3	◎	—	—	—	Malfunction of drain water level system	
	◐	◐	RF	◎	—	—	—	Malfunction of drain system	
	◐	◐	RE	◎	—	◻	—	Indoor unit fan motor lock	
	◐	◐	R7	◎	—	◻	—	Swing flap motor malfunction / Lock	
	◐	◐	RJ	◎	—	○	—	Malfunction of capacity setting	
	◐	◐	E4	◎	—	◻	—	Malfunctioning heat exchanger thermistor system.	
	◐	◐	E9	◎	—	◻	—	Malfunctioning suction air thermistor system.	
	◐	◐	EJ	—	—	◻	—	Malfunctioning remote controller air thermisto	
	◐	◐	EL	◎	—	◻	—	Humidity sensor system malfunction	

5.2 Outdoor Malfunctions

Outdoor Unit Malfunction	Remote Controller Display	Location of Malfunction			Contents of Malfunction	Details of Malfunction (Reference Page)	
		Other than PC Board	PC Board				
			Outdoor Unit	Indoor Unit			Remote Controller
E1	⊙	⊙	—	—	Outdoor unit PC board malfunction	168	
E3	⊙	—	—	—	Abnormality of high pressure (HPS)	169	
E4	⊙	□	—	—	Abnormality of low pressure (outdoor)	171	
E5	⊙	□	—	—	Compressor motor lock malfunction	173	
E7	⊙	□	—	—	Malfunction of outdoor unit fan motor	175	
E9	⊙	□	—	—	Malfunction of Electronic expansion valve	178	
F3	⊙	□	—	—	Discharge pipe temperature malfunction	181	
H3	⊙	⊙	—	—	Faulty high pressure switch (HPS)	183	
H4	⊙	⊙	—	—	Abnormal low pressure sensor		
H9	⊙	□	—	—	Malfunction of outdoor air temperature sensor system	184	
J1	⊙	□	—	—	Malfunction of pressure sensor	185	
J3	⊙	□	—	—	Malfunction of discharge pipe temperature sensor system	184	
J5	⊙	□	—	—	Suction pipe thermistor malfunction	184	
J6	⊙	□	—	—	Malfunction of heat exchanger temperature sensor system	184	
J7	⊙	□	—	—	Malfunction of subcooling heat exchanger thermistor (outdoor unit)	184	
J8	⊙	□	—	—	Malfunction of liquid pipe thermistor (outdoor unit)	184	
JC	⊙	□	—	—	Suction pipe pressure sensor malfunction		
L1	○	⊙	—	—	Outdoor PC board malfunction	187	
L4	⊙	□	—	—	High temperature of radiation fin	189	
L5	⊙	□	—	—	Overcurrent of DC output (instantaneous)	191	
L8	⊙	□	—	—	Electronic thermal switch (time lag)	193	
L9	⊙	□	—	—	Stall prevention (time lag)	195	
LC	⊙	○	—	—	Malfunction of transmission system (between control PC board and inverter PC board)	197	
P1	⊙	□	—	—	Open phase or voltage unbalance	199	
P4	⊙	□	—	—	Malfunction of radiator fin temperature thermistor	200	
PJ	⊙	□	—	—	Error in capacity setting	201	
U0	⊙	—	—	—	Gas shortage	202	
U2	⊙	□	—	—	Abnormal power supply voltage	204	

Notes: 1. Possibility of open phase in power supply.

5.3 System Malfunctions

System Malfunction	Remote Controller Display	Location of Malfunction				Contents of Malfunction	Details of Malfunction (Reference Page)
		Other than PC Board	PC Board				
			Outdoor Unit	Indoor Unit	Remote Controller		
<i>U4</i> or <i>UF</i>	⊙	○	○	—	Transmission error (between indoor and outdoor unit)	206	
<i>UF</i>	⊙	○	○	—	Malfunction of transmission (between indoor and outdoor unit) or Piping and wiring mismatch or Gas shortage	209	
<i>U5</i>	⊙	—	○	○	Transmission error (between indoor and remote controller)	210	
<i>U8</i>	⊙	—	○	○	Transmission error between “main” remote controller and “sub” remote controller	211	
<i>UR</i>	⊙	—	○	—	Excessive indoor units connected to this system.	212	
<i>UC</i>	⊙	—	—	○	Centralized address setting error	214	

5.4 Overview of the Outdoor Safety Devices

	High pressure switch		Fuse
	Open	Close	
RZQ71	4.0 Mpa +0/-0.15	3.0 +/-0.15	6.3A/250V
RZQ100			
RZQ125			
RZQ140			

5.5 Overview of the Indoor Safety Devices

	Thermal protector		Thermal fuse fan motor
	Abnormal	Reset (automatic)	
FFQ35~60	>130°C +/-5°C	<83°C +/-20°C	N.A.
FCQ35~71	>130°C +/-5°C	<83°C +/-20°C	N.A.
FCQ100~140	>140°C +/-5°C	<45°C +/-15°C	N.A.
FBQ35~125	N.A.	N.A.	>152°C
FDQ125	N.A.	N.A.	>160°C
FHQ35~125	>130°C +/-5°C	<83°C +/-20°C	N.A.
FUQ71~125	>130°C +/-5°C	<83°C +/-20°C	N.A.
FAQ71/100	>130°C +/-5°C	<83°C +/-20°C	N.A.

5.6 “A1” Malfunctioning Indoor PC Board

Remote
Controller
Display

A1

LED indications

The table below shows the LED indications.

Operation	HAP (green)	HBP (green)
Normal	●	●
Malfunctioning	●	☼
	●	●
	☼	—
	●	—

Error generation

The error is generated when the data from the EEPROM is not received correctly.

EEPROM (Electrically Erasable Programmable Read Only Memory): A memory chip that holds its content without power. It can be erased, either within the computer or externally and usually requires more voltage for erasure than the common +5 volts used in logic circuits. It functions like non-volatile RAM, but writing to EEPROM is slower than writing to RAM.

Supposed Causes

The possible cause is a malfunctioning indoor PC board.

Troubleshooting



Caution

Be sure to turn off power switch before connect or disconnect connector, or parts damage may be occurred.

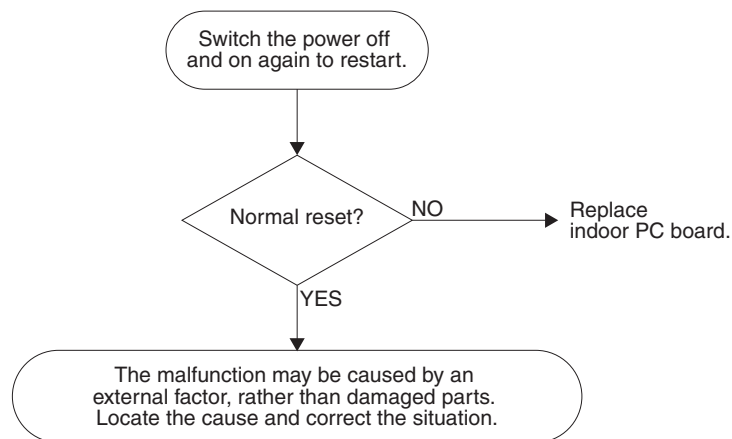

5.7 “R3” Malfunction of Drain Water Level System

Remote
Controller
Display

R3

LED indications

The table below shows the LED indications.

Operation	HAP (green)	HBP (green)
Normal	●	●
Malfunctioning	●	●

Error generation

The error is generated when the water level reaches its upper limit and when the float switch turns OFF.

Supposed
Causes

The possible causes are:

- Malfunctioning drain pump
- Improper drain piping work
- Drain piping clogging
- Malfunctioning float switch
- Malfunctioning indoor unit PC board
- Malfunctioning short-circuit connector X15A on PC board.

Troubleshooting

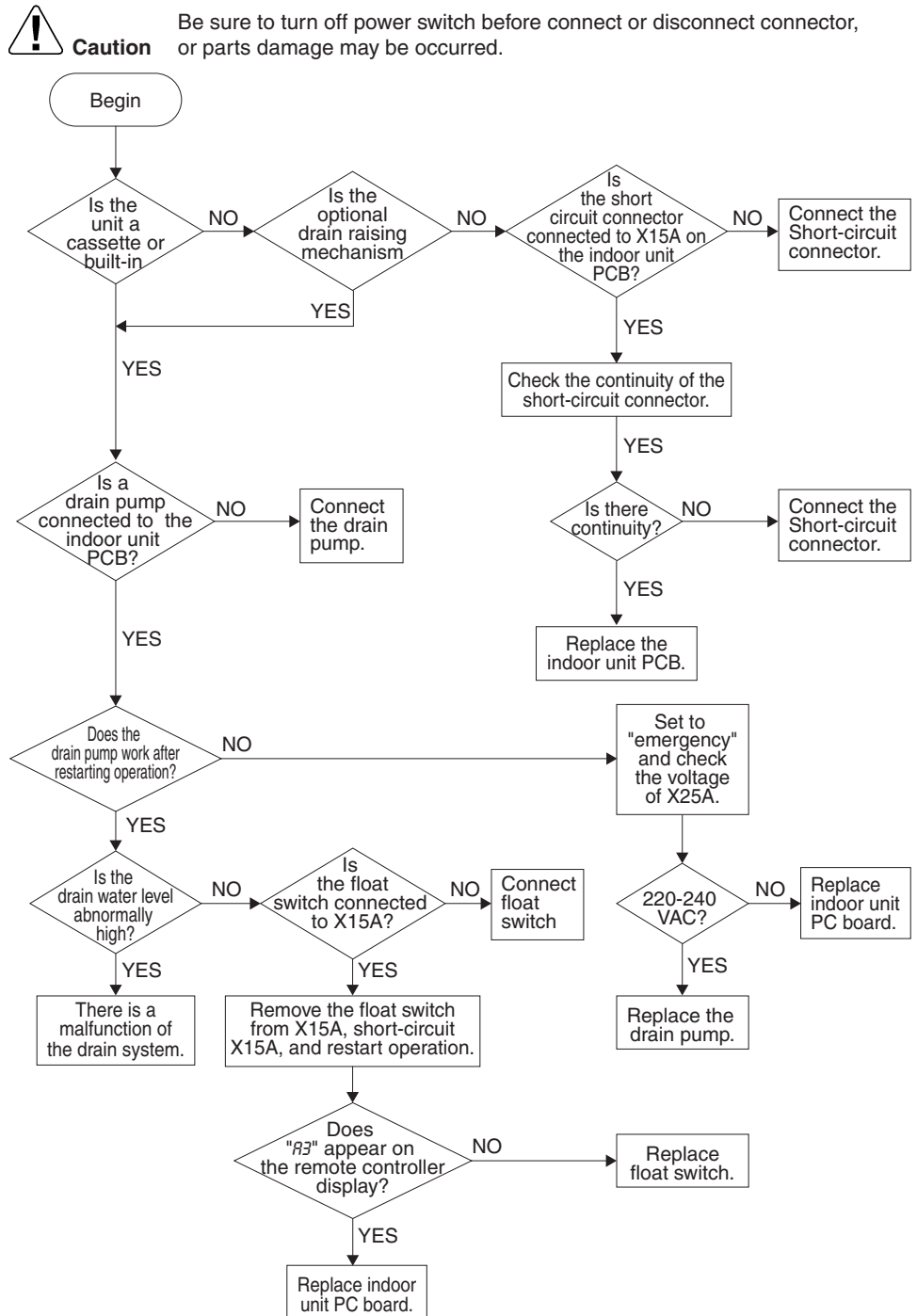

i Note: If "R3" is detected by a PC board which is not mounted with X15A, the PC board is defective.

5.8 “R6” Indoor Unit Fan Motor Lock

Remote
Controller
Display

R6

LED indications

The table below shows the LED indications.

Operation	HAP (green)	HBP (green)
Normal	●	●
Malfunctioning	●	●

Error generation

The error is generated when the fan rotations are not detected while the output voltage to the fan is at its maximum.

Supposed
Causes

The possible causes are:

- Malfunctioning indoor unit fan motor
- Broken or disconnected wire
- Malfunctioning contact
- Malfunctioning indoor unit PC board.

Troubleshooting

 **Caution** Be sure to turn off power switch before connect or disconnect connector, or parts damage may be occurred.

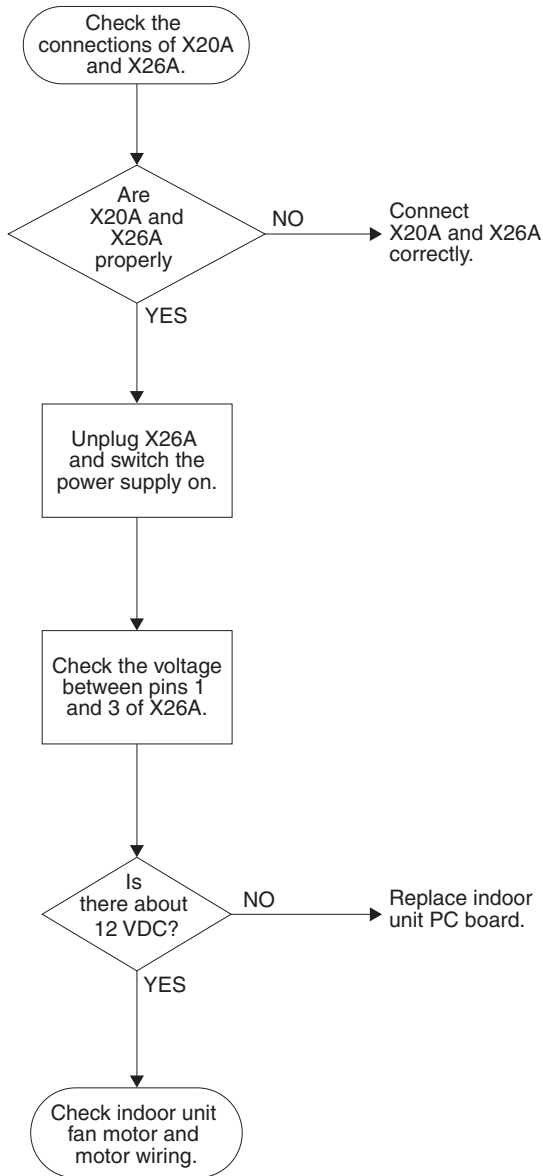

5.9 “A7” Swing Flap Motor Malfunction / Lock

Remote
Controller
Display

A7

LED indications

The table below shows the LED indications.

Operation	HAP (green)	HBP (green)
Normal	●	●
Malfunctioning	●	●

Error generation

The error is detected by the limit switch when the motor turns.

When ON/OFF of the microswitch for position detection cannot be reversed even though the swing flap motor is energized for a specified amount of time (about 30 seconds).

Supposed
Causes

The possible causes are:

- Failure of swing flap motor
- Failure of microswitch
- Failure of connector connection
- Failure of indoor unit PC board

Troubleshooting

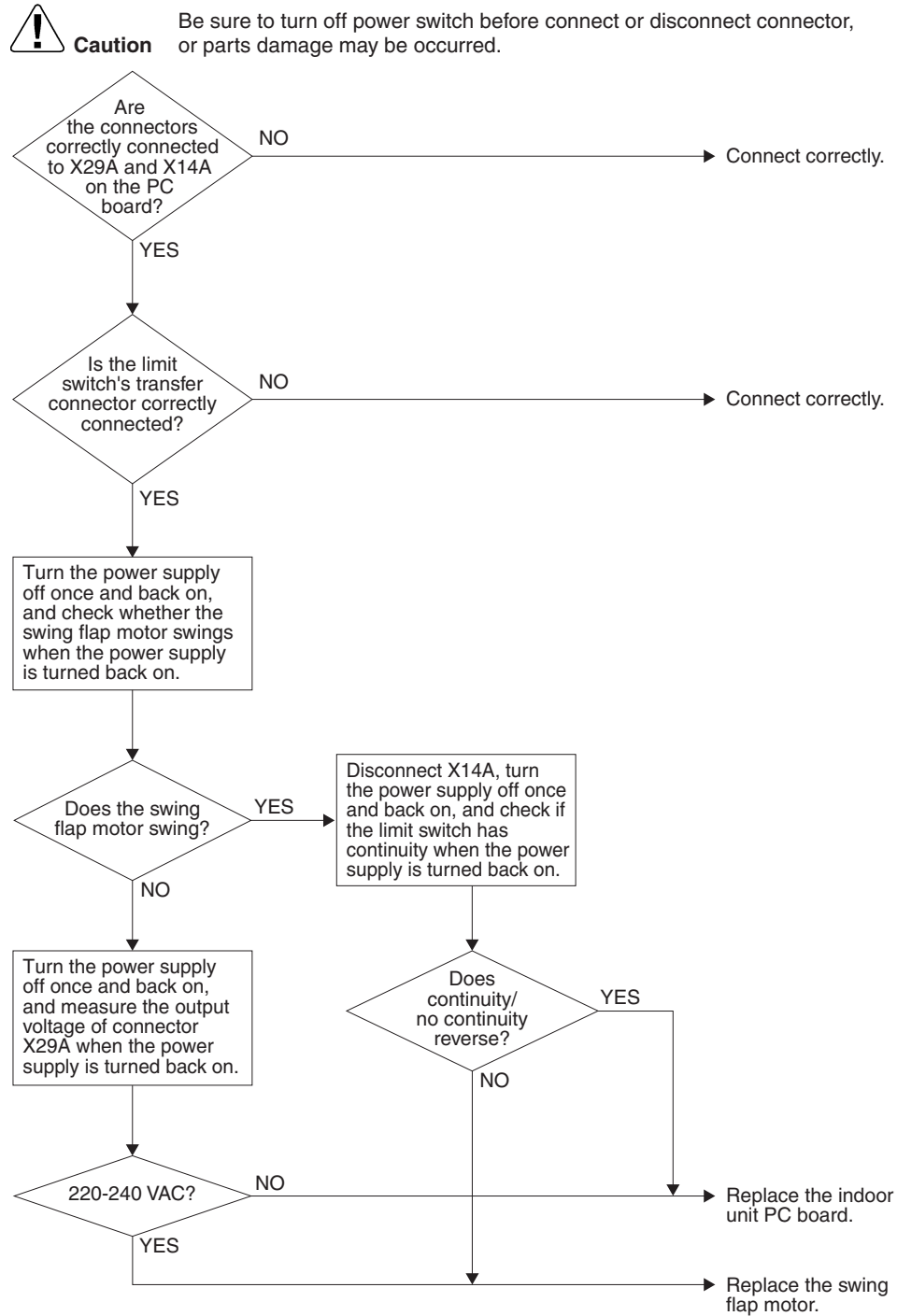

5.10 “AF” Malfunctioning Drain System

Remote
Controller
Display

AF

LED indications

The table below shows the LED indications.

Operation	HAP (green)	HBP (green)
Normal	●	●
Malfunctioning	●	●

Error generation

The error is generated when the float switch changes from ON to OFF while the compressor is OFF.

Supposed
Causes

The possible causes are:

- Error in the drain pipe installation
- Malfunctioning float switch
- Malfunctioning indoor unit PC board.

Troubleshooting



Caution

Be sure to turn off power switch before connect or disconnect connector, or parts damage may be occurred.

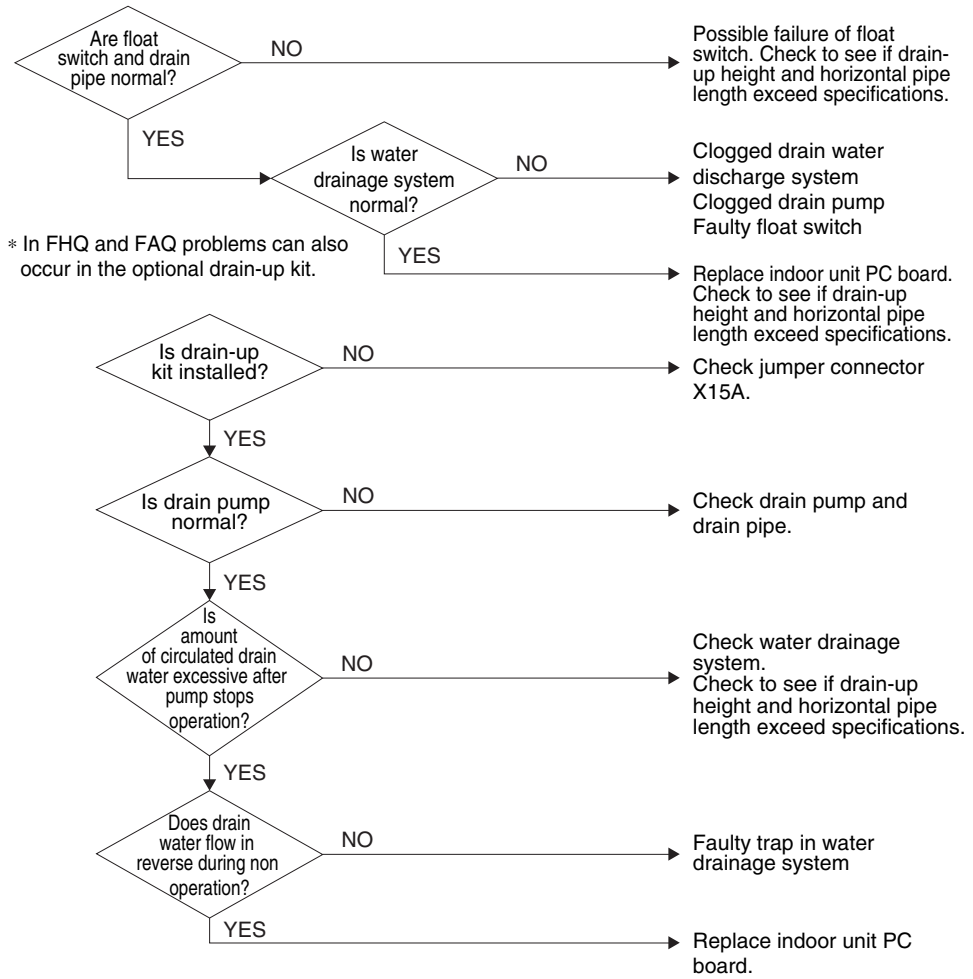

5.11 “RU” Malfunctioning Capacity Setting

Remote
Controller
Display

RU

LED indications

The table below shows the LED indications.

Operation	HAP (green)	HBP (green)
Normal	●	●
Malfunctioning	●	●

Error generation

The error is generated when the following conditions are fulfilled:

Condition	Description
1	<ul style="list-style-type: none"> ● The unit is in operation. ● The PCB's memory IC does not contain the capacity code. ● The capacity setting adaptor is not connected.
2	<ul style="list-style-type: none"> ● The unit is in operation. ● The capacity that is set, does not exist for that unit.

Supposed
Causes

The possible causes are:

- Malfunctioning capacity setting adaptor connection
- Malfunctioning indoor unit PC board.

Capacity setting
adaptor

The capacity is set in the PC board's memory IC. A capacity setting adaptor that matches the capacity of the unit is required in the following case:

In case the indoor PC board installed at the factory is for some reason changed at the installation site, the capacity will not be contained in the replacement PC board. To set the correct capacity for the PC board you have to connect a capacity setting adaptor with the correct capacity setting to the PC board. The capacity setting for the PC board will become the capacity setting of the adaptor because the capacity setting adaptor has priority.

Troubleshooting

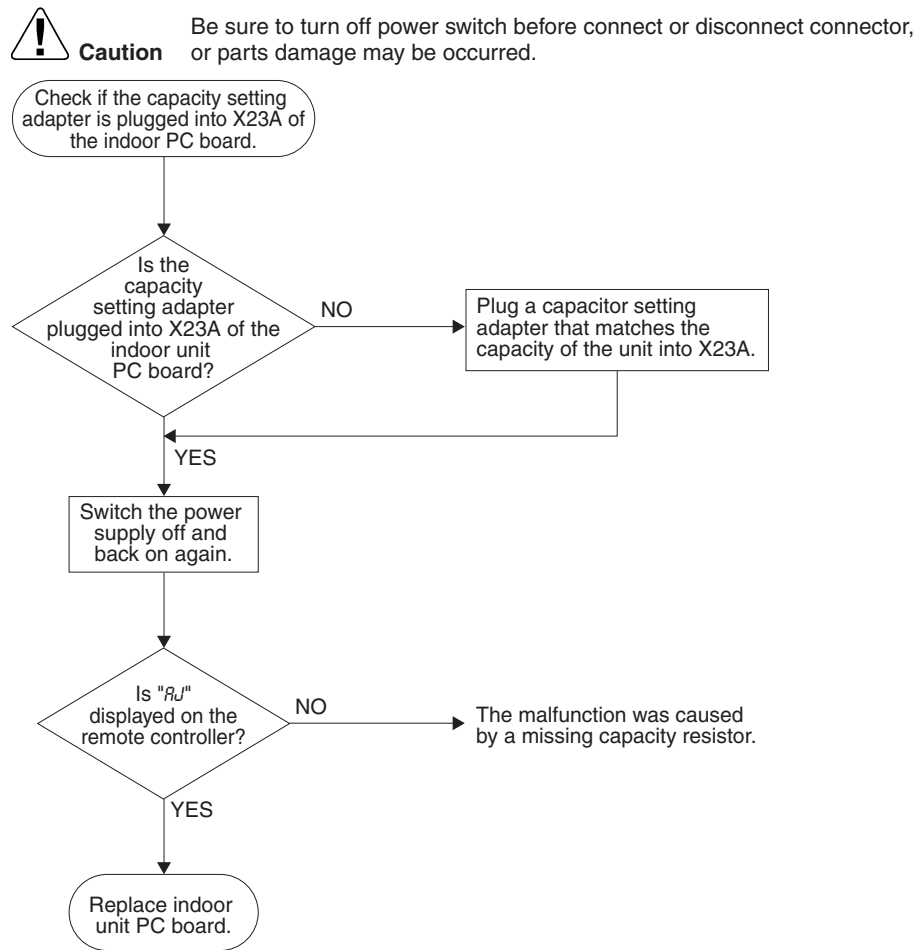

5.12 “E4”, “E9” Thermistor Abnormality

Remote Controller Display

The table below describes the two thermistor abnormalities.

Error	Description
E4	Malfunctioning heat exchanger thermistor system.
E9	Malfunctioning suction air thermistor system.

LED indications

The table below shows the LED indications.

Operation	HAP (green)	HBP (green)
Normal	●	●
Malfunctioning	●	●

Error generation

The error is generated when during compressor operation:

- Thermistor input > 4.96 V, or
- Thermistor output < 0.04 V.

Supposed Causes

The possible causes are:

- Malfunctioning connector connection
- Malfunctioning thermistor
- Malfunctioning PC board
- Broken or disconnected wire.

Checking thermistors

Refer to P217.

Troubleshooting

Caution Be sure to turn off power switch before connect or disconnect connector, or parts damage may be occurred.

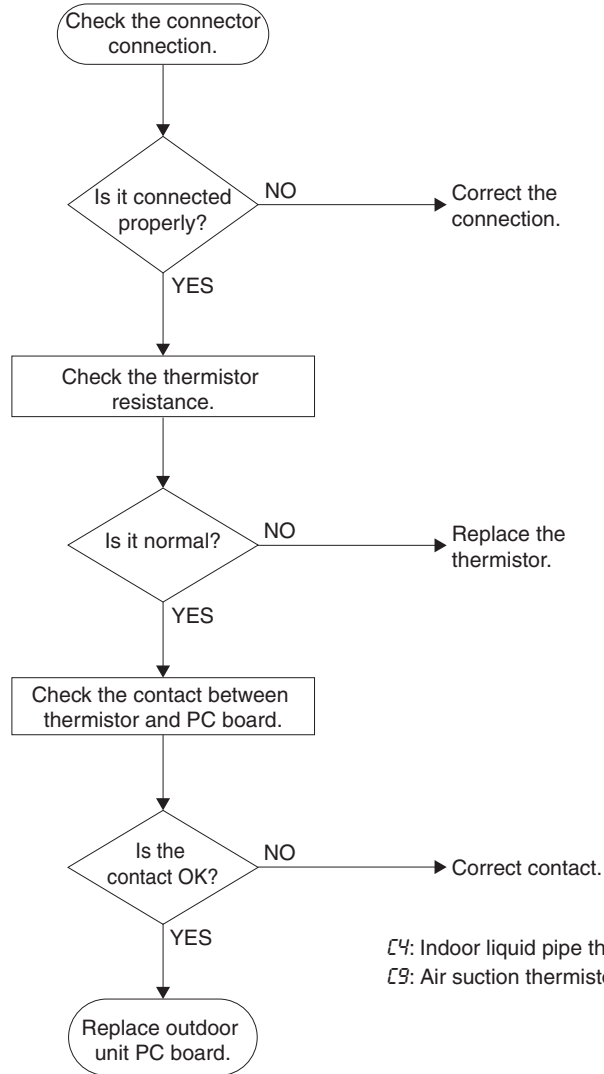

5.13 “EJ” Malfunctioning Remote Controller Air Thermistor

Remote Controller Display

EJ

LED indications

The table below shows the LED indications.

Operation	HAP (green)	HBP (green)
Normal	●	●
Malfunctioning	●	●

Error generation

The error is generated when the remote controller thermistor becomes disconnected or shorted while the unit is running.

Even if the remote controller thermistor is malfunctioning, the system can operate with the system thermistor.

Supposed Causes

The possible causes are:

- Malfunctioning thermistor
- Broken wire.

Troubleshooting

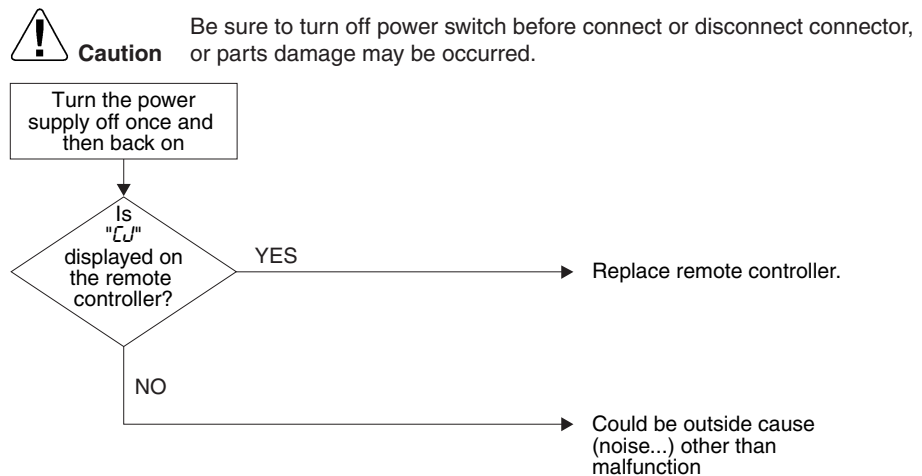

5.14 “[[” Humidity Sensor System Malfunction

Remote
Controller
Display

[[

LED indications

The table below shows the LED indications.

Operation	HAP (green)	HBP (green)
Normal	●	●
Malfunctioning	●	●

Error generation

The error is generated when the humidity sensor becomes disconnected or shorted while the unit is running.

Even if the sensor is malfunctioning, the system can operate.

Supposed
Causes

The possible causes are:

- Malfunctioning sensor
- Broken wire.

Troubleshooting

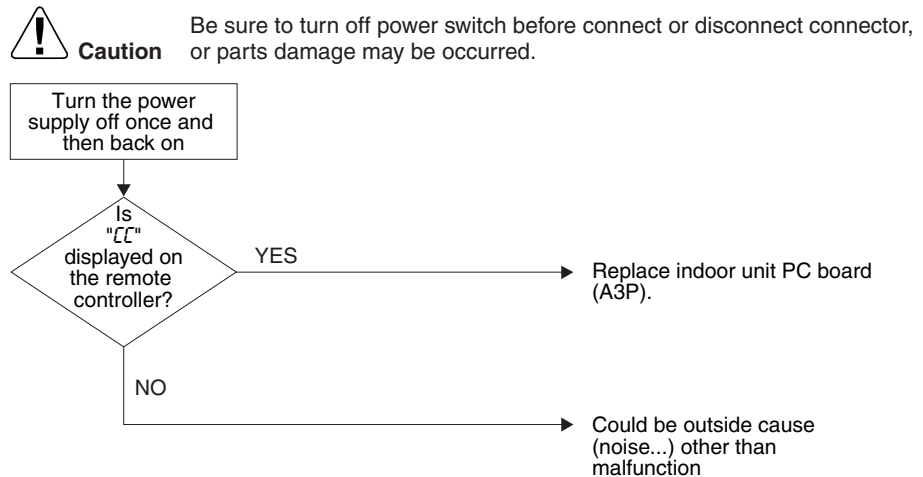

5.15 “E1” Failure of Outdoor Unit PC Board

Remote
Controller
Display

E1

Method of
Malfunction
Detection

Microcomputer checks whether E²PROM is normal.

Malfunction
Decision
Conditions

E²PROM:
When E²PROM malfunctions when turning the power supply on

Supposed
Causes

- Faulty outdoor unit PC board

Troubleshooting

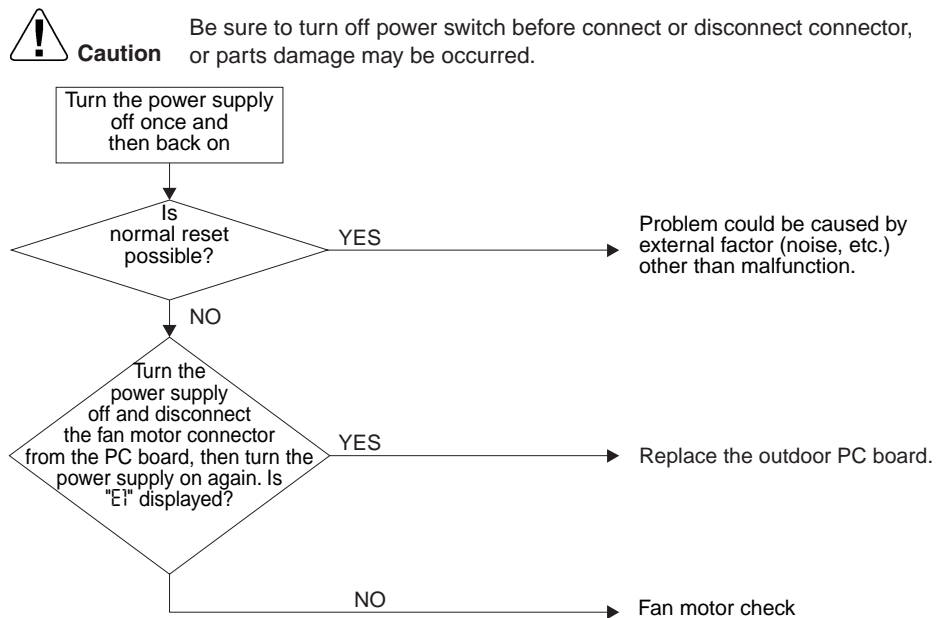

5.16 “E3” Abnormal High Pressure (Detected by the HPS)

Remote
Controller
Display

E3

Method of
Malfunction
Detection

The protection device circuit checks continuity in the high pressure switch.

Malfunction
Decision
Conditions

When the high pressure switch is actuated
Actuating pressure:
RZQ71~140

Supposed
Causes

- Faulty high pressure switch
- Disconnection in high pressure switch harness
- Faulty connection of high pressure switch connector
- Clogged indoor unit suction filter (in heating operation)
- Dirty outdoor unit heat exchanger
- Faulty outdoor unit fan
- Refrigerant overcharge
- Stop valve is left in closed.

HPS settings

The table below contains the preset HPS values.

High pressure switch		Fuse
Open	Close	
4.0 Mpa +0/-0.15	3.0 +/-0.15	6.3A/250V

Troubleshooting

 **Caution** Be sure to turn off power switch before connect or disconnect connector, or parts damage may be occurred.

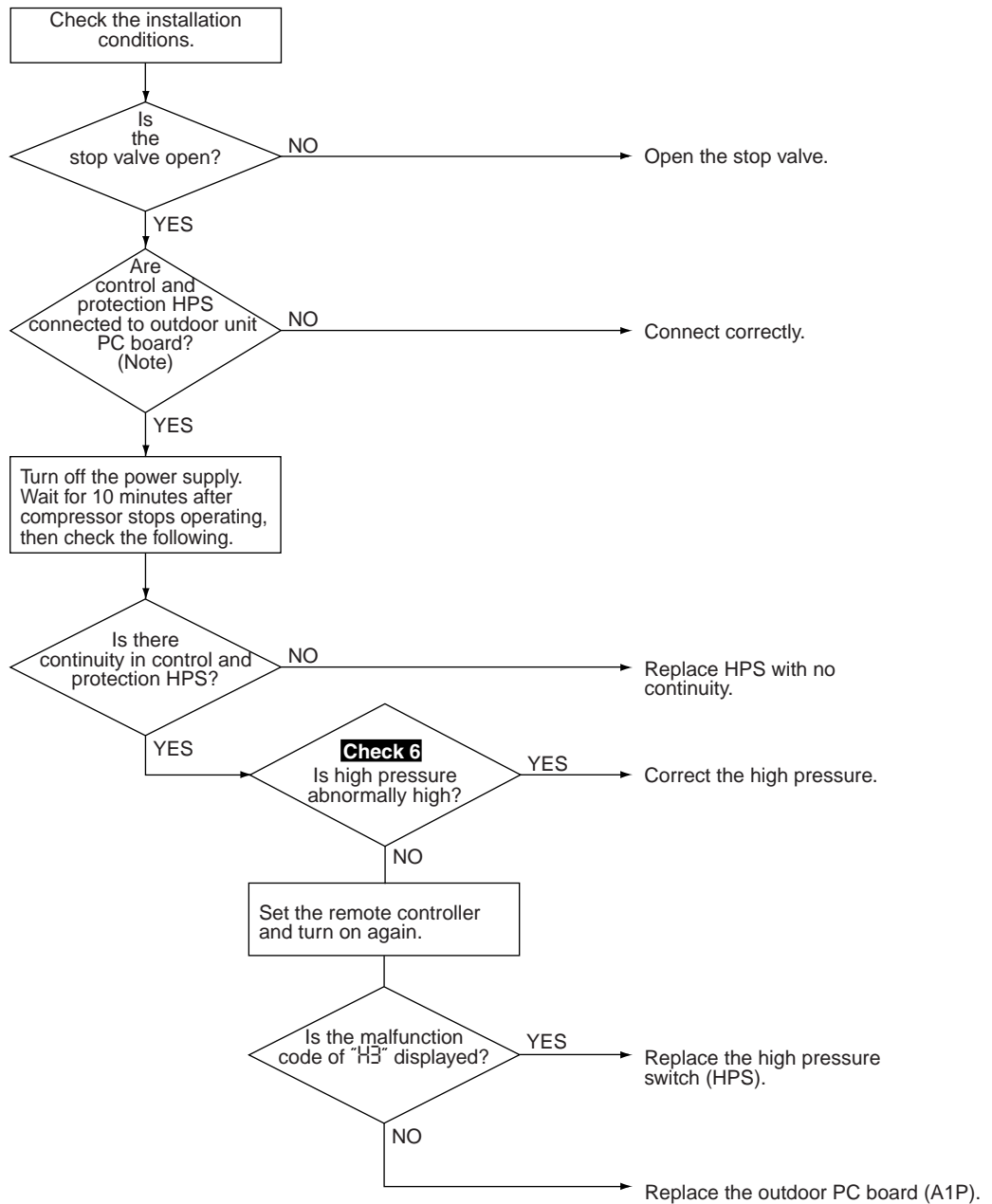

(S2582)

5.17 “E4” Actuation of Low Pressure Sensor: Single phase C Series

Remote Controller Display	<i>E4</i>
Applicable Models	RZQ71~140
Method of Malfunction Detection	<p>[In cooling]</p> <ul style="list-style-type: none"> ■ Detect malfunctions by the pressure sensor (S1NPH). <p>[In heating]</p> <ul style="list-style-type: none"> ■ Detect malfunctions by the heat exchanger distribution pipe thermistor (R4T).
Malfunction Decision Conditions	<p>[In cooling]</p> <ul style="list-style-type: none"> ■ When the detection pressure is the following value 0.12 MPa or less continues for 5 minutes ■ When the saturated pressure equivalent to the detection temperature is the following value 0.12 MPa or less continues for 5 minutes
Supposed Causes	<ul style="list-style-type: none"> ■ The stop valve remained closed ■ Faulty pressure sensor and intermittent harness ■ Faulty outdoor PC board ■ Abnormal drop of low pressure (Inadequate refrigerant) (Abnormal refrigerant piping system (liquid pipe system)) (Faulty electronic expansion valve)

Troubleshooting



Caution Be sure to turn off power switch before connect or disconnect connector, or parts damage may be occurred.

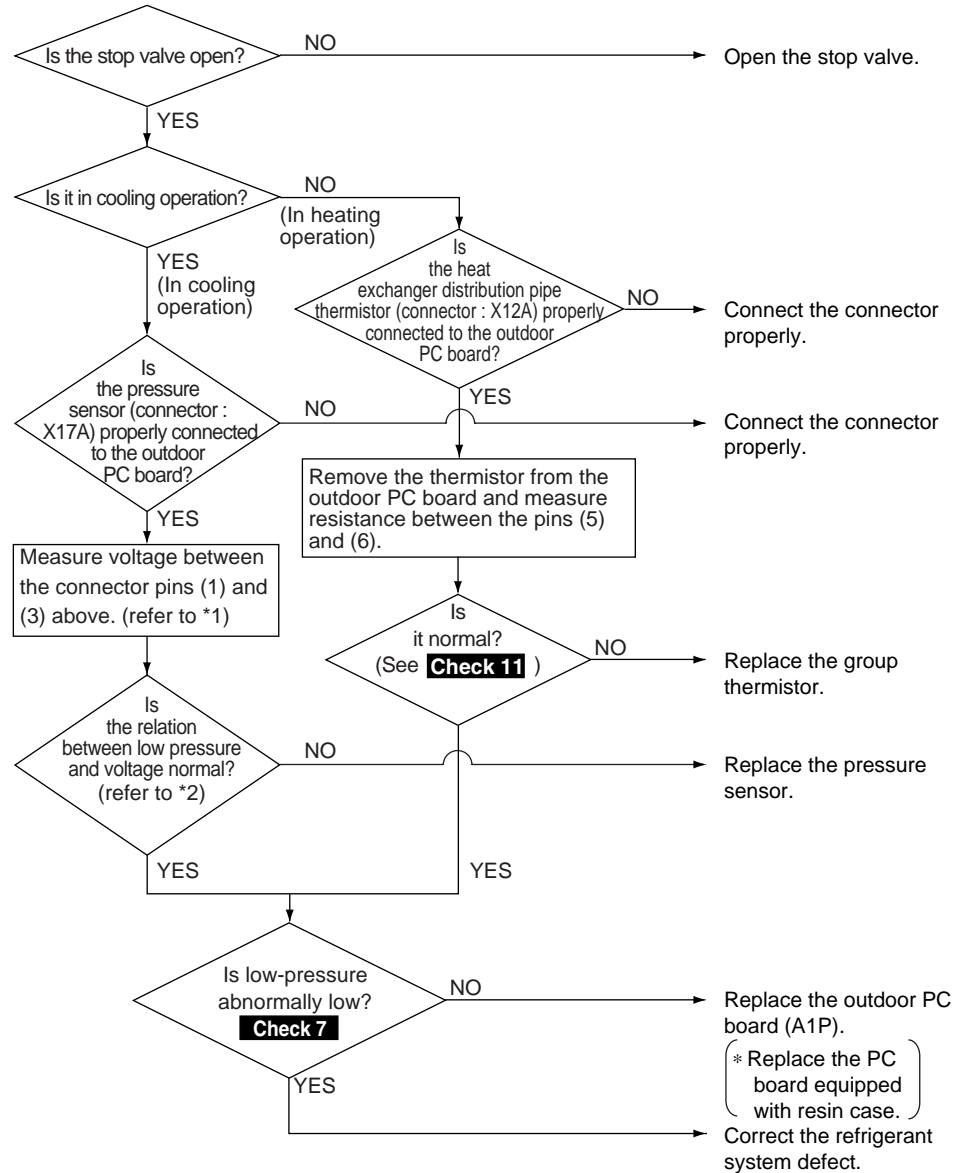

*1: Voltage measurement point

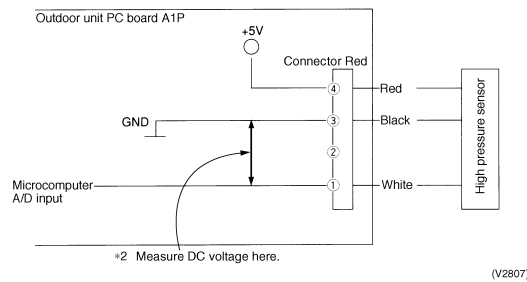

*2: "Pressure Sensor", pressure / voltage characteristics table.

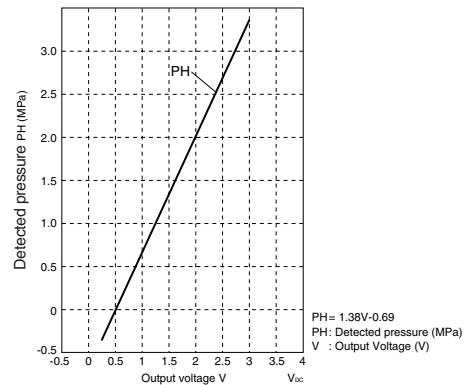

5.18 “E5” Compressor Motor Lock

Remote
Controller
Display

E5

Applicable
Models

RZQ71~140

Method of
Malfunction
Detection

Inverter PC board takes the position signal from UVWN line connected between the inverter and compressor, and detects the position signal pattern.

Malfunction
Decision
Conditions

The position signal with 3 times cycle as imposed frequency is detected when compressor motor operates normally, but 2 times cycle when compressor motor locks. When the position signal in 2 times cycle is detected

Supposed
Causes

- Compressor lock
- High differential pressure (2.6MPa or more) starting
- Incorrect UVWN wiring
- Faulty inverter PC board
- Stop valve is left in closed.

Troubleshooting

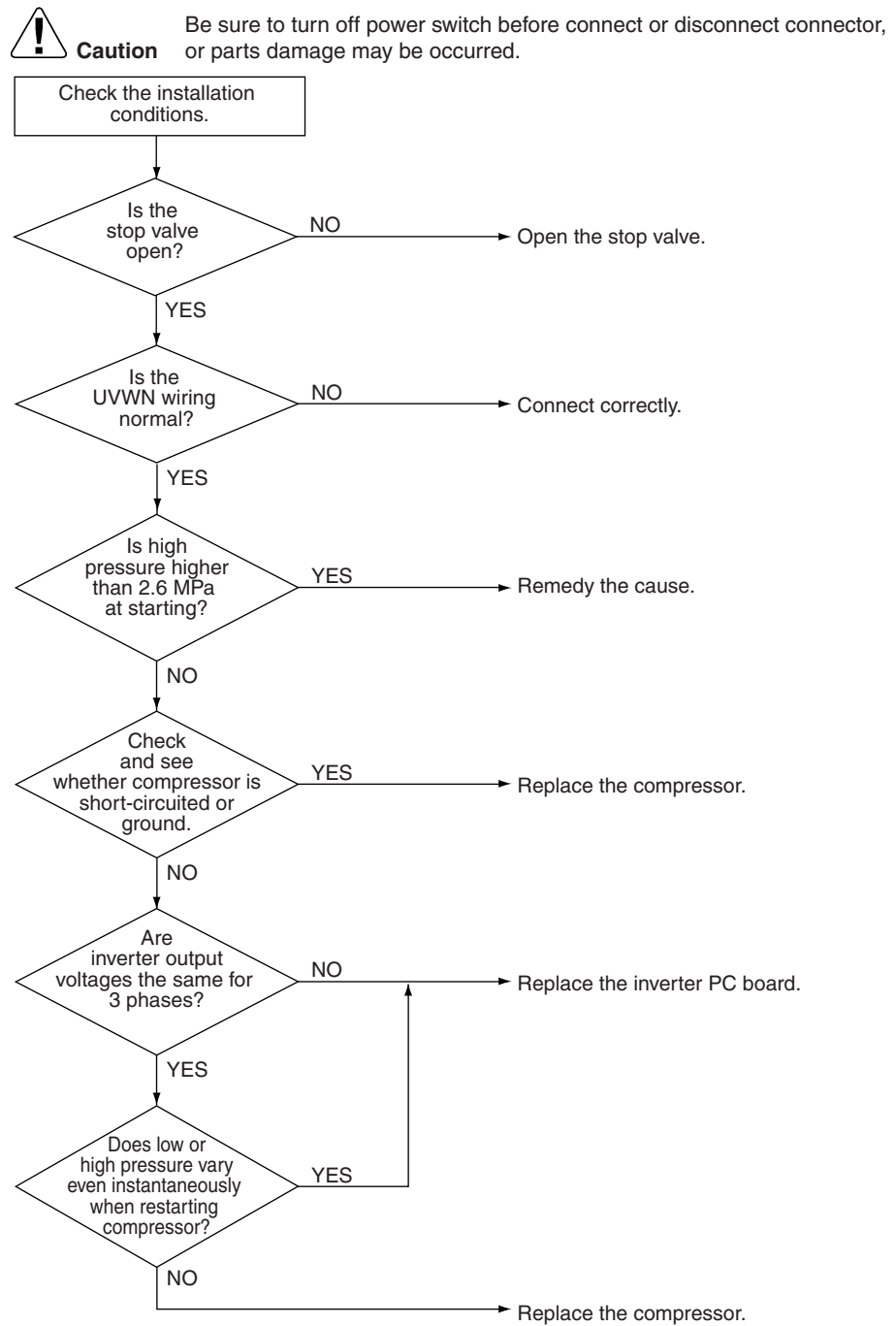

5.19 “E7” Malfunction of Outdoor Unit Fan Motor

Remote
Controller
Display

E7

Applicable
Models

RZQ71~140

Method of
Malfunction
Detection

Abnormality of fan motor system is detected according to the fan speed detected by hall IC when the fan motor runs.

Malfunction
Decision
Conditions

- When the fan runs with speed less than a specified one for 15 seconds or more when the fan motor running conditions are met
- When connector detecting fan speed is disconnected
- When malfunction is generated 4 times, the system shuts down.

Supposed
Causes

- Malfunction of fan motor
- The harness connector between fan motor and PC board is left in disconnected, or faulty connector
- Fan does not run due to foreign matters tangled
- Malfunction of the outdoor (inverter) PC board
- Blowout of fuse

Troubleshooting

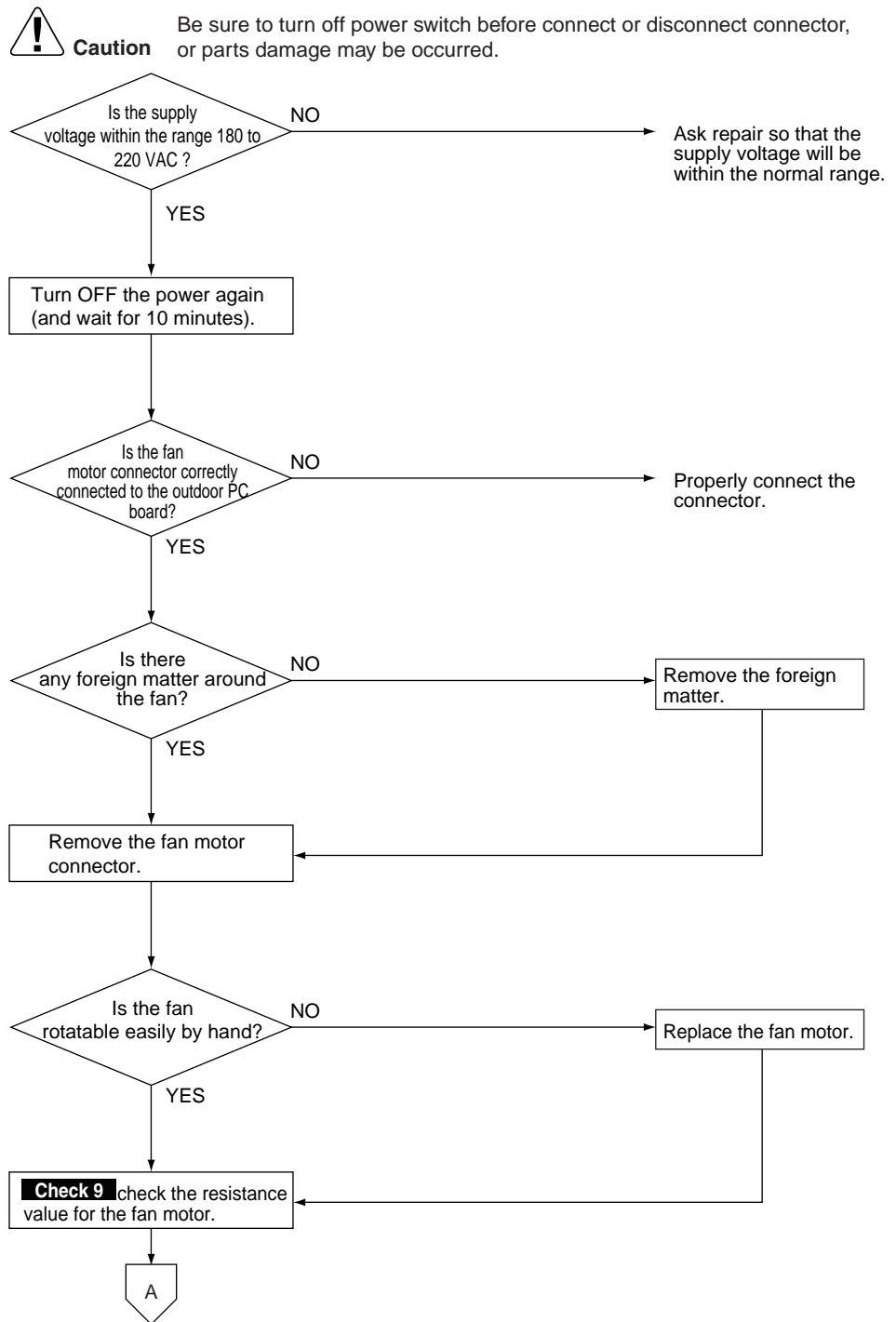

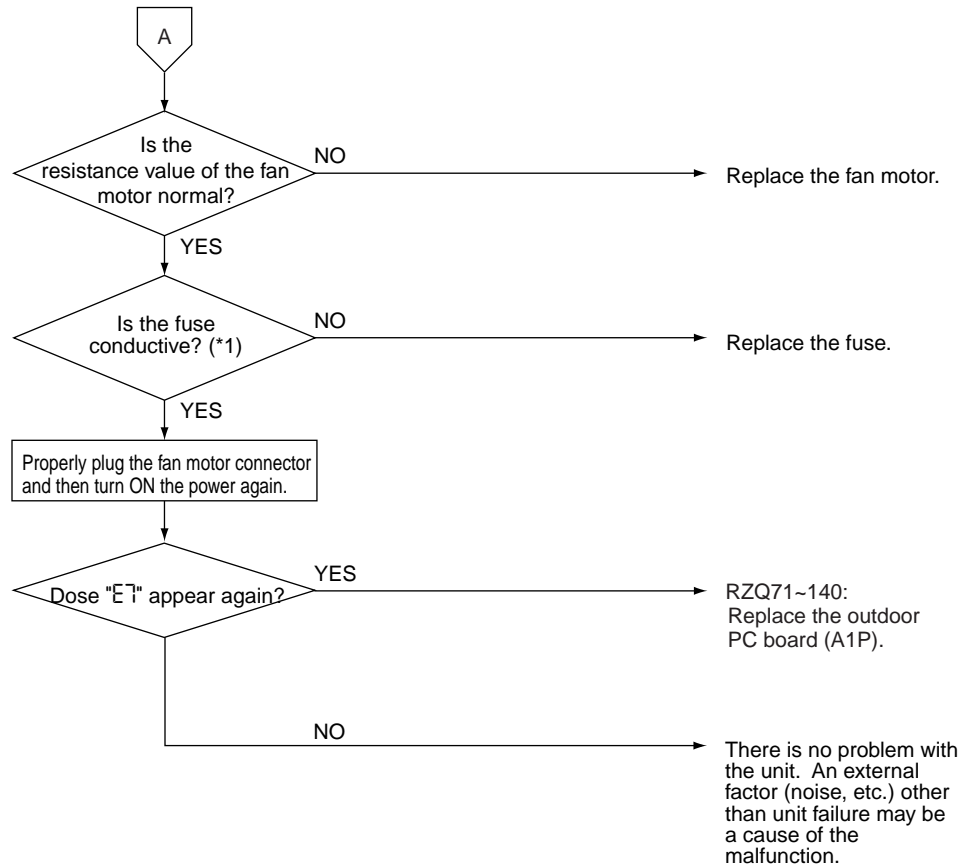

*1 Fuse conductive

RZQ71~140	F6U
-----------	-----

5.20 “E9” Malfunction of Electronic Expansion Valve

Remote
Controller
Display

E9

Applicable
Models

RZQ71~140

Method of
Malfunction
Detection

Method is determined according to the suction pipe superheat degree and electronic expansion valve opening degree calculated by values of low pressure sensor and suction pipe temperature thermistor.

Malfunction
Decision
Conditions

When the following conditions are met for 10 minutes

- Suction pipe superheat degree < 4°C
- Minimum electronic expansion valve opening degree
- Connector of electronic expansion valve is missing when the power is on.

Supposed
Causes

- Faulty electronic expansion valve
- Faulty solenoid valve
- Faulty check valve
- Disconnection of electronic expansion valve harness
- Faulty connection of electronic expansion valve connector
- Faulty each thermistor
- Faulty mounting
- Faulty pressure sensor
- Faulty Outdoor control PC board

Troubleshooting



Caution

Be sure to turn off power switch before connect or disconnect connector, or parts damage may be occurred.

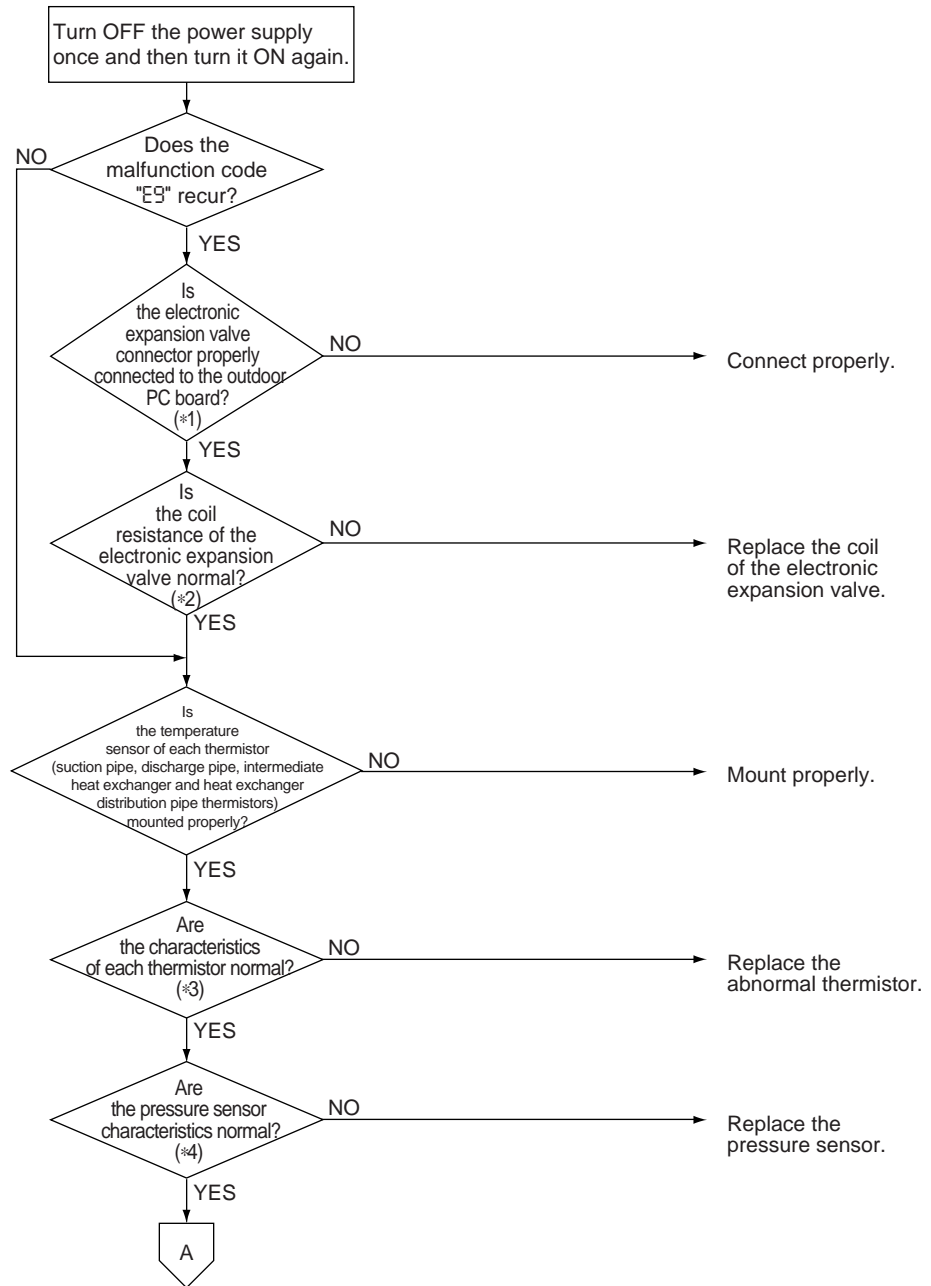

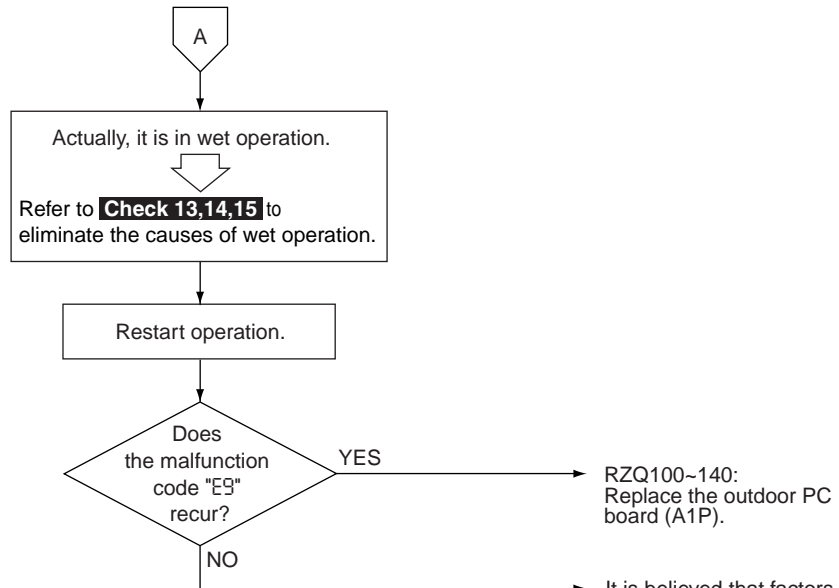

- *1: Electronic expansion valve and connector No. RZQ71~140
- *2: Electronic expansion valve connector and coil resistance criteria

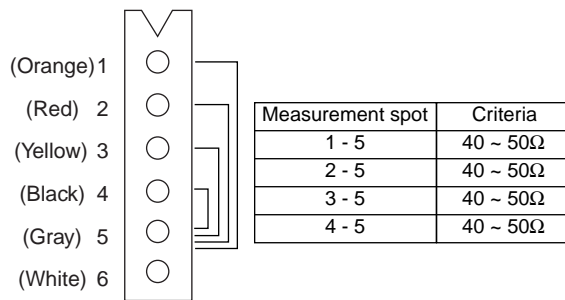

- *3: For thermistor temperature and resistance characteristics, Refer to **Check 4,5**.
- *4: For voltage characteristics of the pressure sensor, see the right figure.

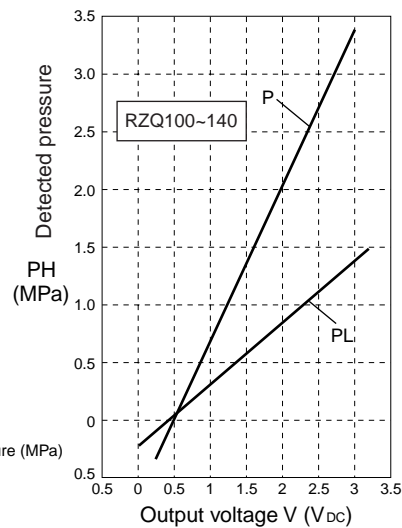

5.21 “F3” Malfunctioning in Discharge Pipe Temperature

Remote
Controller
Display

F3

Applicable
Models

RZQ71~140

Method of
Malfunction
Detection

Abnormality is detected according to the temperature detected by the discharge pipe temperature sensor.

Malfunction
Decision
Conditions

- When the discharge pipe temperature rises to an abnormally high level
 - When the discharge pipe temperature rises suddenly
-

Supposed
Causes

- Faulty discharge pipe thermistor
- Faulty connection of discharge pipe thermistor
- Insufficient refrigerant amount
- Faulty compressor
- Disconnection of discharge pipe thermistor

Troubleshooting



Caution

Be sure to turn off power switch before connect or disconnect connector, or parts damage may be occurred.

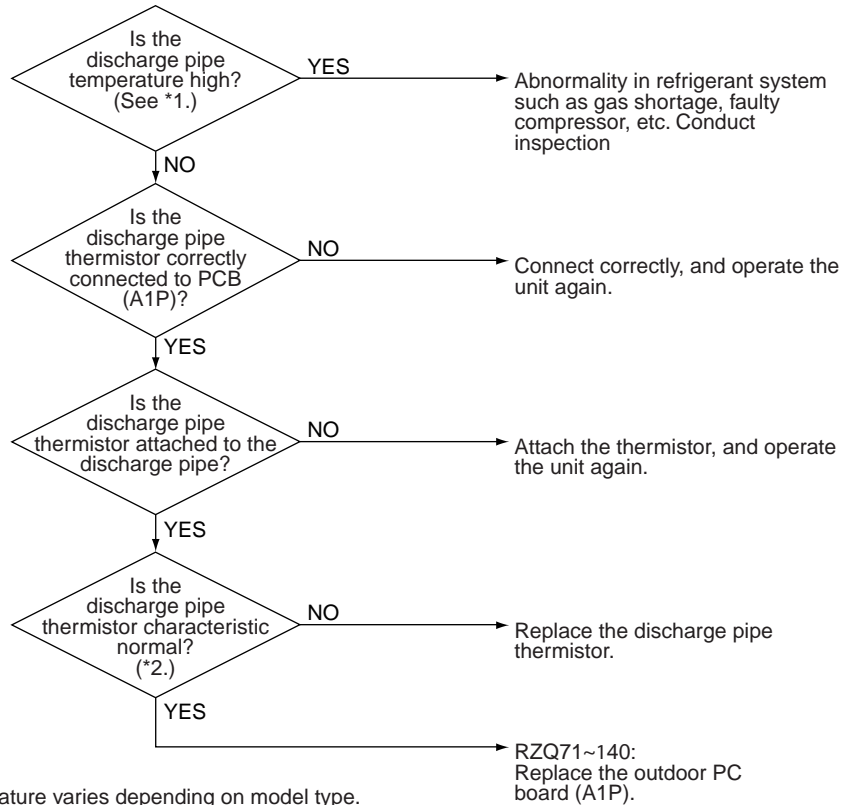

*1 Temperature varies depending on model type.

Model name	Temperature
RZQ71	110°C
RZQ100 ~ 140	115°C

*2 Refer to "**Check 5**" for "Thermistor temperature - resistance conversion table"

5.22 “H3” Malfunctioning HPS System

Remote Controller Display	H3
Applicable Models	RZQ71~140
Method of Malfunction Detection	The protection device circuit checks continuity in the high pressure switch.
Malfunction Decision Conditions	When there is no continuity in the high pressure switch during compressor stops operating.
Supposed Causes	<ul style="list-style-type: none"> ■ Incomplete high pressure switch ■ Disconnection in high pressure switch harness ■ Faulty connection of high pressure switch connector ■ Faulty outdoor unit PC board ■ Disconnected lead wire

Troubleshooting

 **Caution** Be sure to turn off power switch before connect or disconnect connector, or parts damage may be occurred.

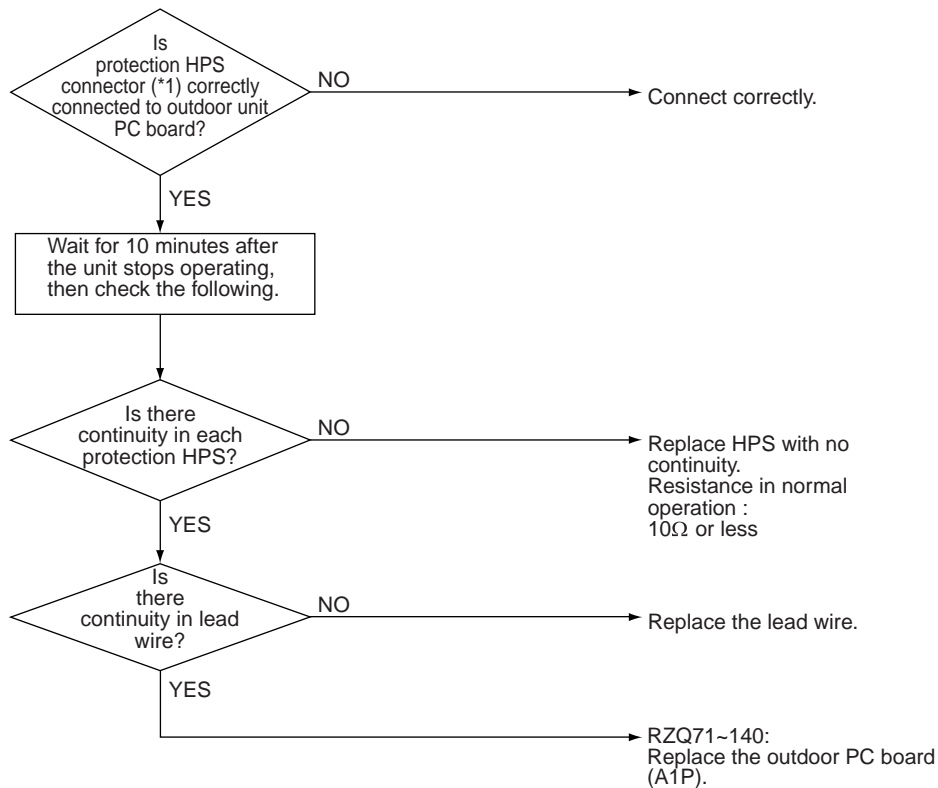

*1 Connector symbol

RZQ71~140	X32A (A1P)
-----------	------------

5.23 “H9”, “J3”, “J5”, “J6”, “J7”, “J8” Malfunction of Thermistor System

Remote Controller Display	H9, J3, J5, J6, J7, J8
Applicable Models	RZQ71~140
Method of Malfunction Detection	Abnormality is detected according to the temperature detected by each individual thermistor.
Malfunction Decision Conditions	When thermistor is disconnected or short-circuited during operation
Supposed Causes	<ul style="list-style-type: none"> ■ Faulty thermistor ■ Faulty connection of connector ■ Faulty outdoor unit PC board (control PC board)

Troubleshooting

 **Caution** Be sure to turn off power switch before connect or disconnect connector, or parts damage may be occurred.

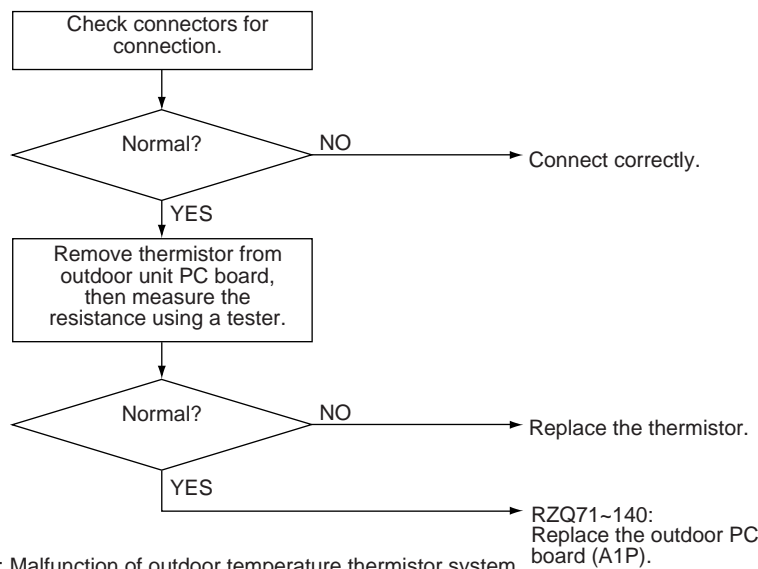

- H9 : Malfunction of outdoor temperature thermistor system
- J3 : Malfunction of discharge pipe thermistor system
- J5 : Malfunction of suction pipe thermistor system
- J6 : Malfunction of heat exchange thermistor
- J7 : Malfunction of subcooling heat exchanger thermistor
- J8 : Malfunction of liquid thermistor

* Refer to P218~219 for “Thermistor temperature/Resistance characteristics”.

5.24 “J1” Malfunction of Pressure Sensor

Remote
Controller
Display

J1

Applicable
Models

RZQ71~140

Method of
Malfunction
Detection

The malfunction is detected by the pressure measured with pressure sensor (S1NPH)

Malfunction
Decision
Conditions

When the detect pressure becomes following;

- Detected pressure $\leq 0.05\text{MPa}$ continues 185 sec.
- Detected pressure $\geq 4.4\text{MPa}$ continues 185 sec.

Supposed
Causes

- Faulty pressure sensor
- Faulty outdoor unit PC board
- Incorrect connection of connector

Troubleshooting

Caution Be sure to turn off power switch before connect or disconnect connector, or parts damage may be occurred.

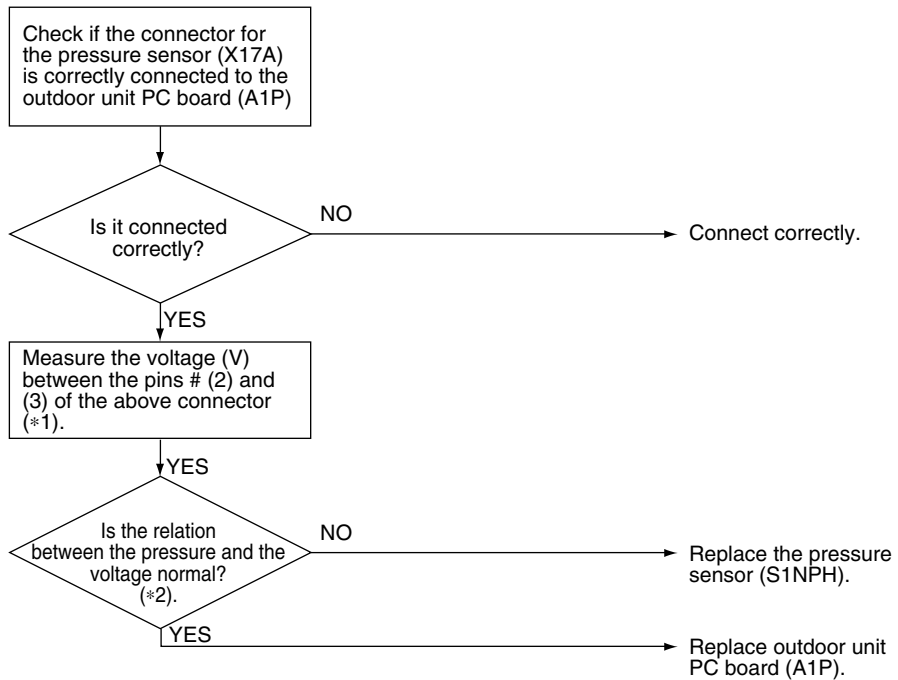

(V2808)

*1: Voltage measurement point

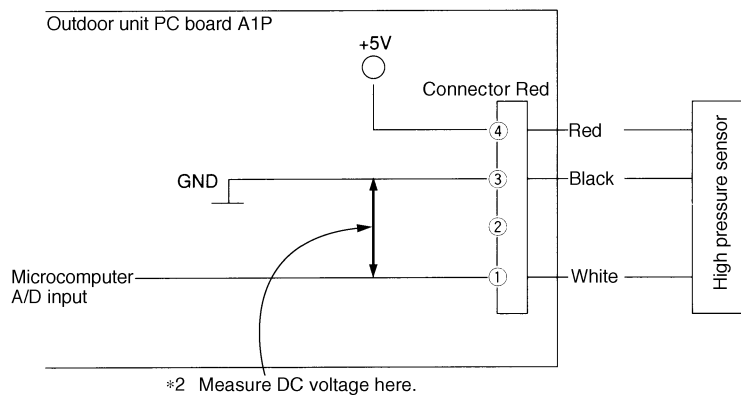

(V2807)

*2: "Pressure Sensor", pressure / voltage characteristics table.

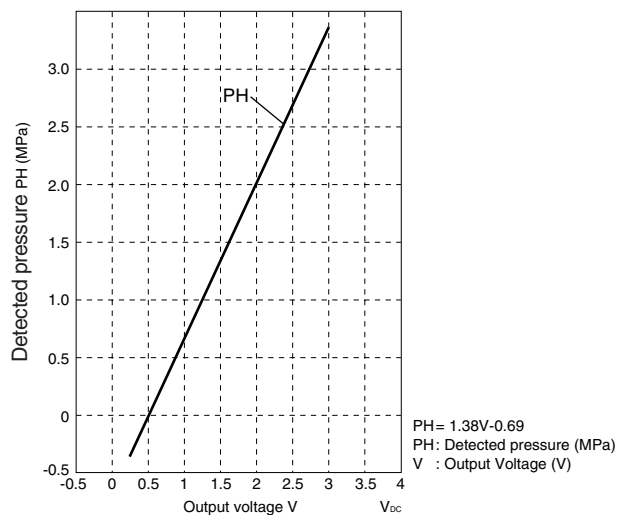

5.25 “L1” Faulty Outdoor PC Board

Remote Controller Display	L1
Applicable Models	RZQ71~140
Method of Malfunction Detection	<ul style="list-style-type: none"> ■ Detect malfunctions by current value during waveform output before compressor startup. ■ Detect malfunctions by current sensor value during synchronized operation at the time of startup. ■ Detect malfunctions using an MP-PAM series capacitor overvoltage sensor.
Malfunction Decision Conditions	<ul style="list-style-type: none"> ■ When over-current is detected at the time of waveform output before operating the compressor ■ When the current sensor malfunctions during synchronized operation ■ When overvoltage occurs in MP-PAM ■ In case of IGBT malfunction ■ In case of faulty jumper setting
Supposed Causes	<ul style="list-style-type: none"> ■ Faulty outdoor PC board (A1P) <ul style="list-style-type: none"> • IPM failure • Current sensor failure • MP-PAM failure • Failure of IGBT or drive circuit

Troubleshooting

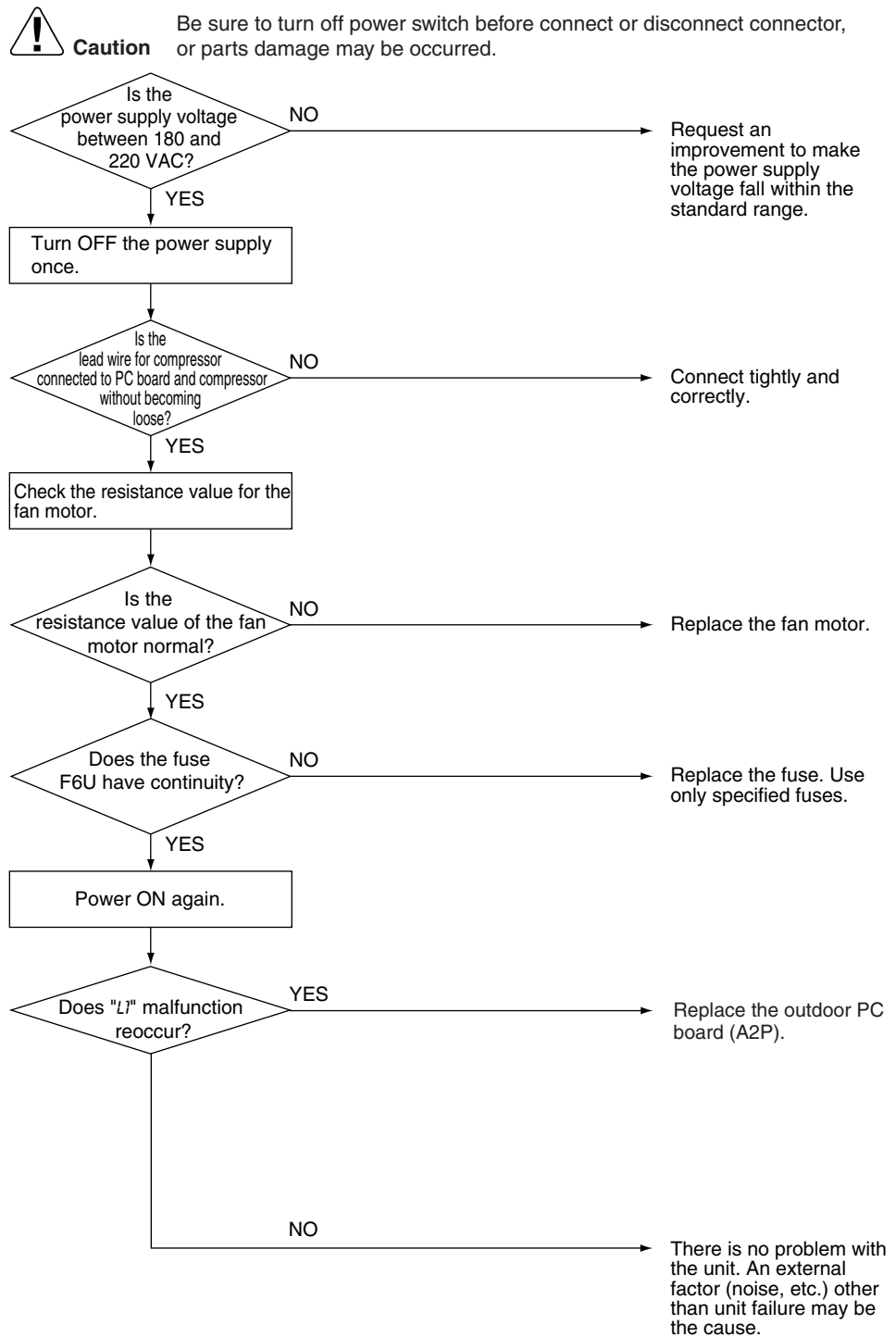

5.26 “L4” Radiation Fin Temperature Increased

**Remote
Controller
Display**

L4

**Applicable
Models**

RZQ71~140

**Method of
Malfunction
Detection**

Fin temperature is detected by the thermistor of the radiation fin.

**Malfunction
Decision
Conditions**

When the temperature of the inverter radiation fin increases abnormally due to faulty heat dissipation.

**Supposed
Causes**

- Activation of fin thermal switch
- Faulty fin thermistor
- High outside air temperature
- Insufficient cooling of inverter radiation fin
- Blocked suction opening
- Dirty radiation fin
- Faulty outdoor inverter PC board

Troubleshooting



Caution

Be sure to turn off power switch before connect or disconnect connector, or parts damage may be occurred.

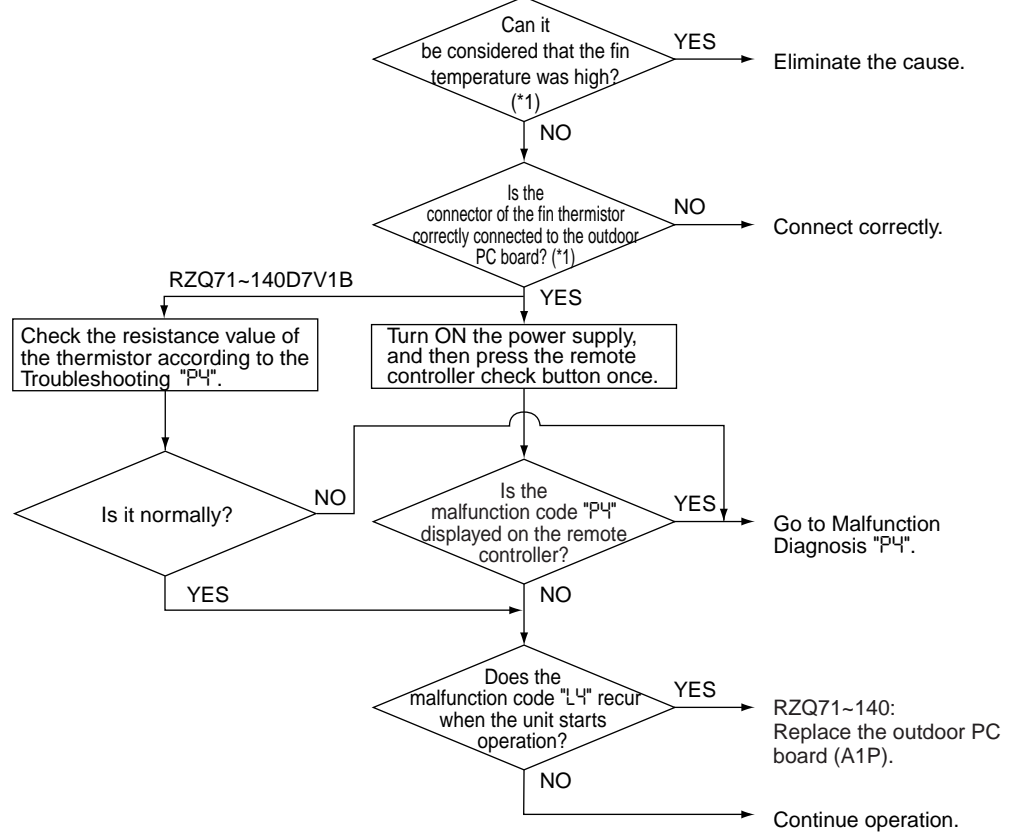

* Fin temperature detection value

	Detection	Reset
RZQ71~140	88°C	78°C

5.27 “L5” DC Output Overcurrent (Instantaneous)

Remote
Controller
Display

L5

Applicable
Models

RZQ71~140

Method of
Malfunction
Detection

Malfunction is detected by converting the current flowing to power transistor into voltage with CT1 (DC current sensor).

Malfunction
Decision
Conditions

When overcurrent has run to power transistor.
(Actuated even by instantaneous overcurrent)

Supposed
Causes

- Faulty compressor coil (disconnection, poor insulation)
- Compressor startup malfunction (mechanical lock)
- Faulty inverter PC board
- Instantaneous fluctuation of power supply voltage
- Faulty compressor (if bearing is scratched)
- The stop valve is left in closed.

Troubleshooting



Caution

Be sure to turn off power switch before connect or disconnect connector, or parts damage may be occurred.

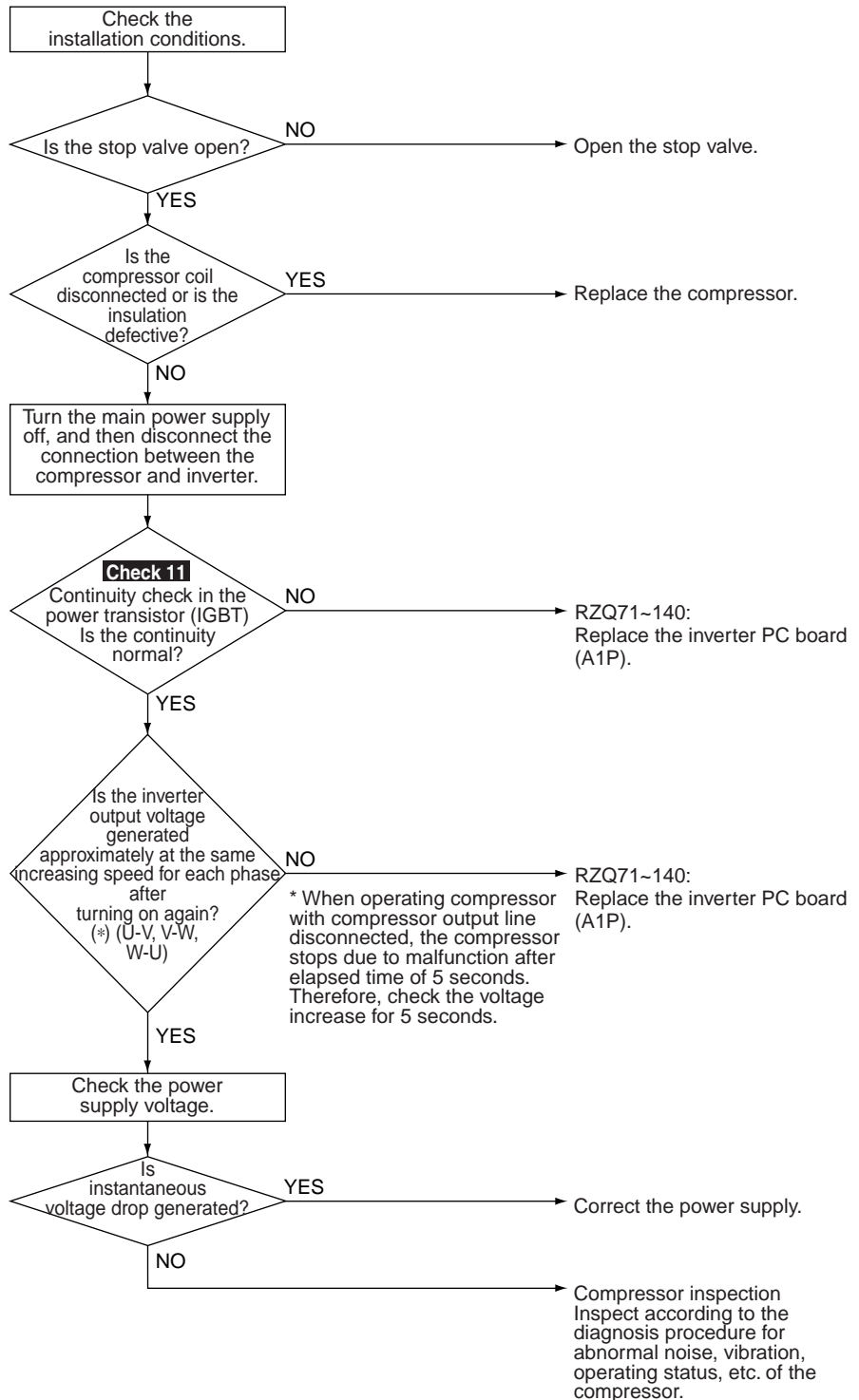

* Approximate value

	Instantaneous overcurrent detection value
RZQ71~140	51.7A

5.28 “LB” Electronic Thermal (Time Lag)

Remote
Controller
Display

LB

Applicable
Models

RZQ71~140

Method of
Malfunction
Detection

Malfunction is detected by converting the current flowing to power transistor into voltage with CT1 (DC current sensor).
Inverter PC board detects the disorder of position signal.

Malfunction
Decision
Conditions

When compressor overload (except for when startup) is detected.

Supposed
Causes

- Compressor overload (during operation)
- Disconnected compressor coil
- Faulty inverter
- Faulty compressor (if bearing is scratched)

Troubleshooting



Caution

Be sure to turn off power switch before connect or disconnect connector, or parts damage may be occurred.

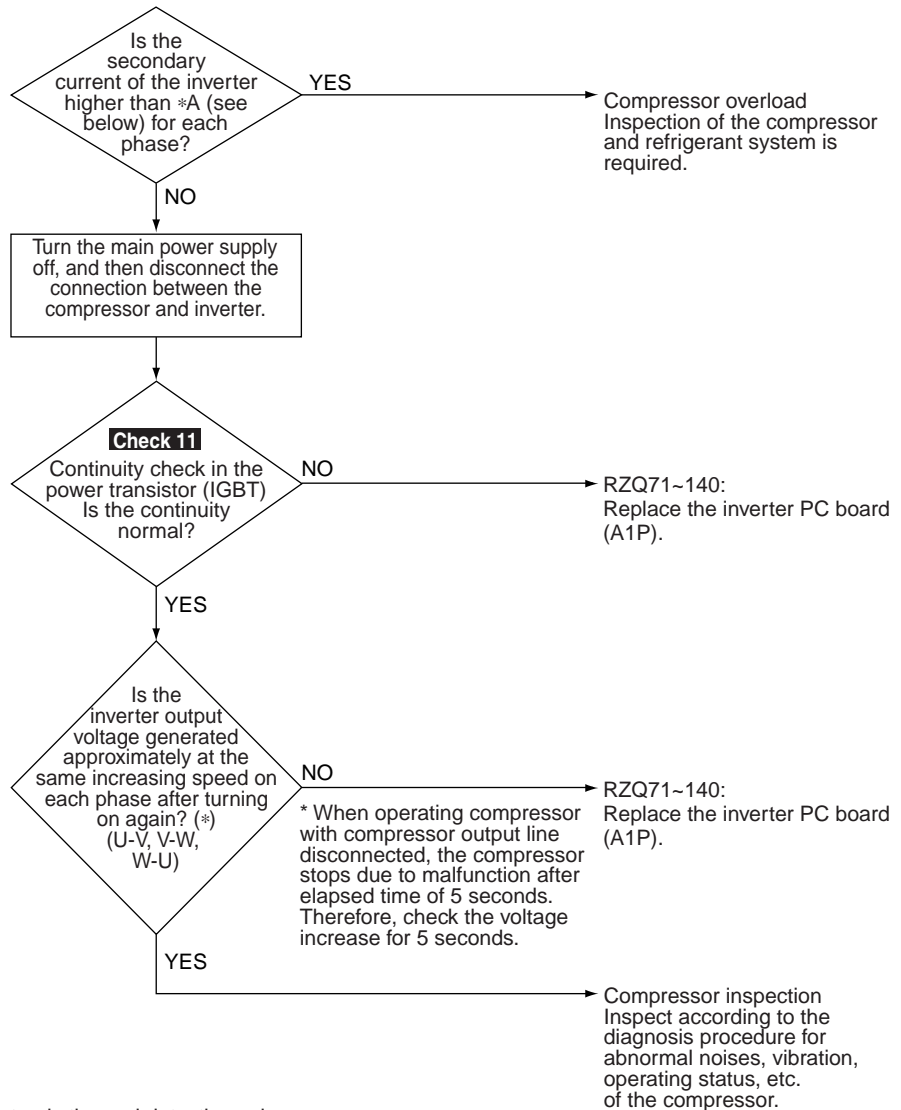

* Electronic thermal detection value

		Detection value
RZQ71~140	Cooling	31A × 5 seconds or 21.1A × 260 seconds
	Heating	

5.29 “L9” Stall Prevention (Time Lag)

Remote
Controller
Display

L9

Applicable
Models

RZQ71~140

Method of
Malfunction
Detection

Malfunction is detected by converting the current flowing to power transistor into voltage with CT1 (DC current sensor).
Inverter PC board detects the disorder of position signal.

Malfunction
Decision
Conditions

When compressor overload (except for when startup) is detected
When position signal is disordered

Supposed
Causes

- Faulty compressor (lock)
- Pressure differential startup
- Faulty inverter
- The stop valve is left in closed.

Troubleshooting

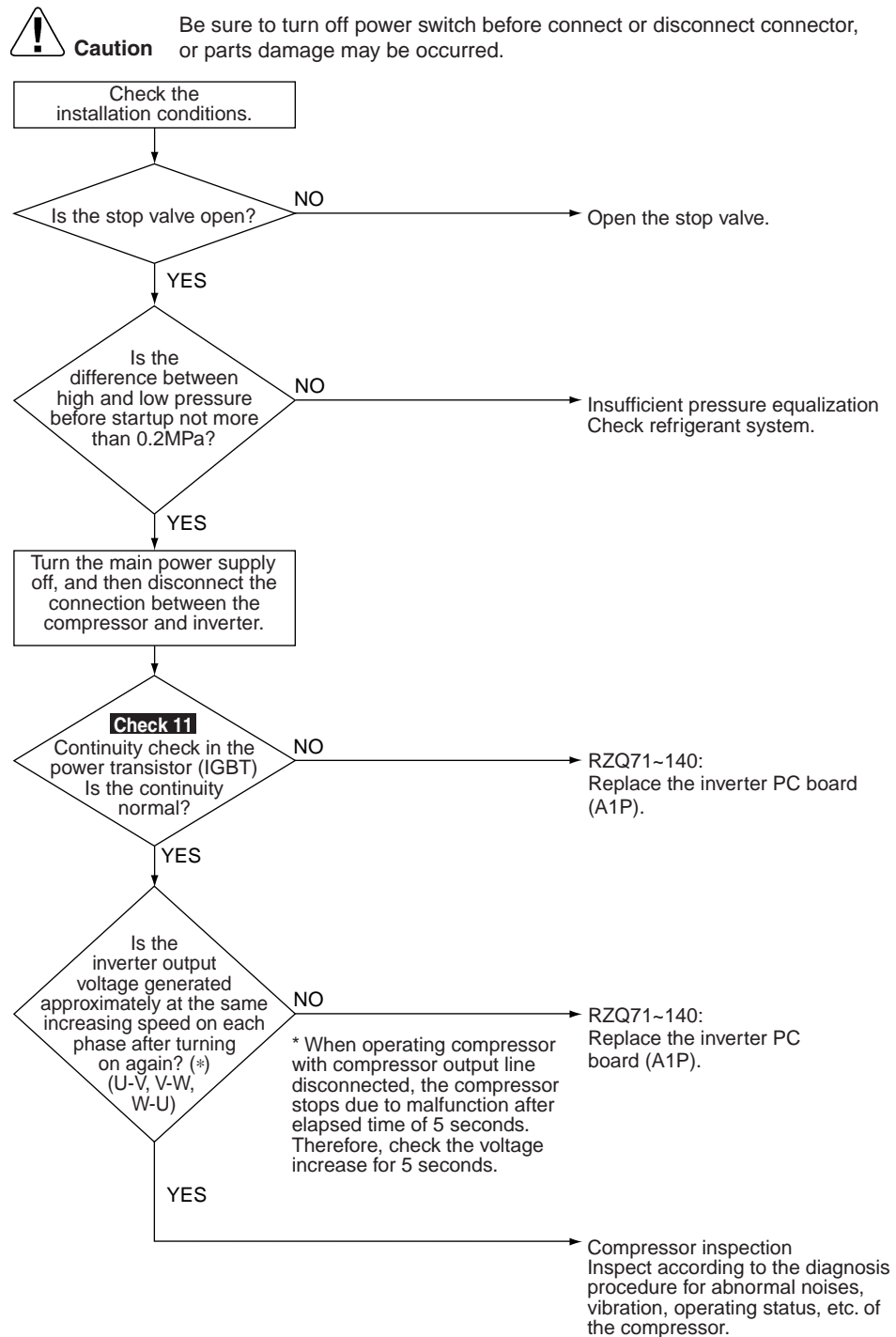

5.30 “LC” Malfunction of Transmission System (between Control and Inverter PC Board)

Remote Controller Display	LC
Applicable Models	RZQ71~140
Method of Malfunction Detection	Checks and sees whether transmission between control and inverter PC board is carried out normally.
Malfunction Decision Conditions	When the transmission is not carried out in a specified period of time or longer
Supposed Causes	<ul style="list-style-type: none"> ■ Incorrect transmission wiring between control and inverter PC board/insufficient contact in wiring ■ Faulty control and inverter PC board ■ External factors (noise, etc.) ■ Faulty outdoor Fan motor ■ Faulty of fan motor connector contact

Troubleshooting

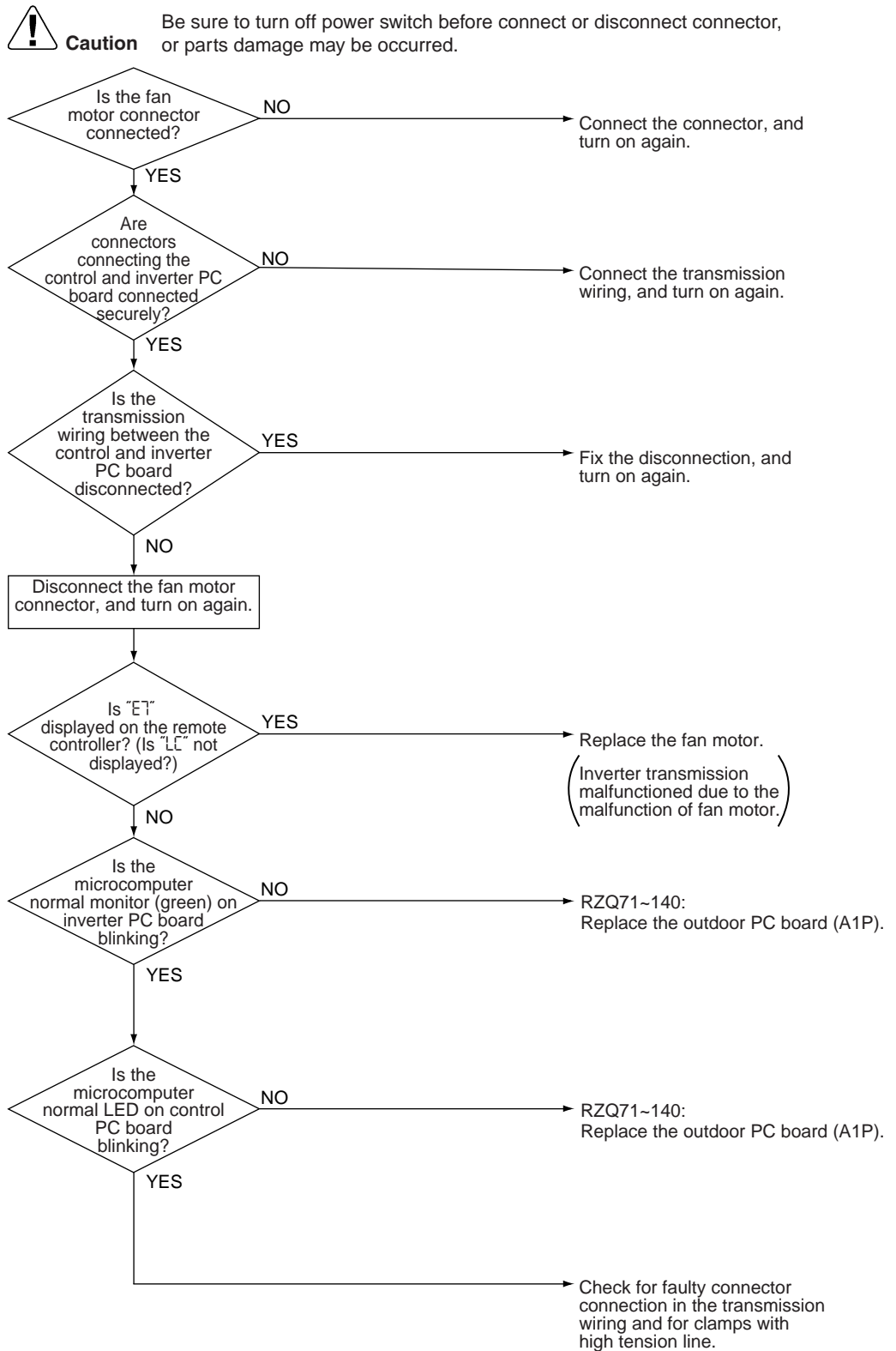

5.31 “P1” Open Phase or Power Supply Voltage Imbalance

Remote
Controller
Display

P1

Applicable
Models

RZQ71~140

Method of
Malfunction
Detection

Malfunction is detected according to the voltage waveform of main circuit capacitor built in inverter.

Malfunction
Decision
Conditions

When the aforementioned voltage waveform becomes identical with the waveform of the power supply open phase.

Supposed
Causes

- Open phase
- Voltage imbalance between phases
- Faulty outdoor inverter PC board
 - Faulty main circuit capacitor
 - Power unit (Disconnection in diode module)
 - Faulty Magnetic Relay (K11R, K12R)
 - Improper main circuit wiring

Troubleshooting



Caution

Be sure to turn off power switch before connect or disconnect connector, or parts damage may be occurred.

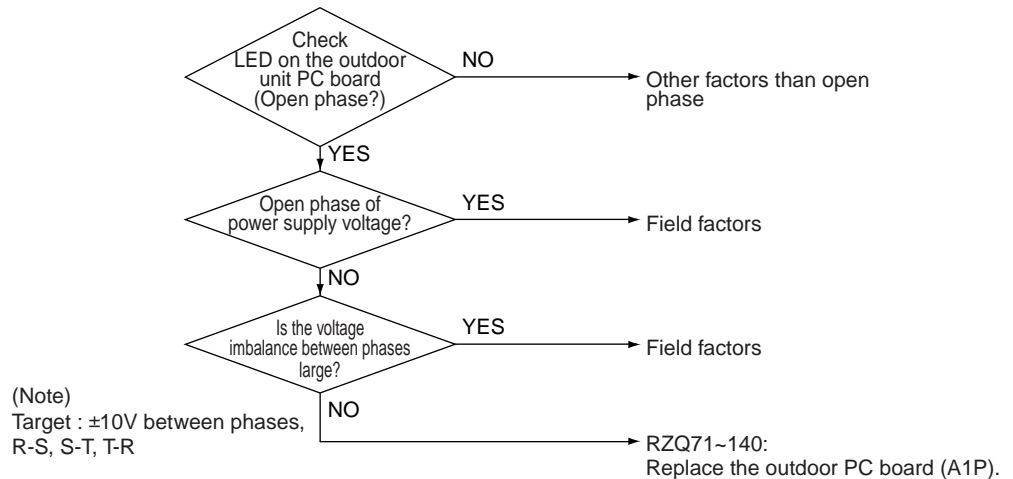

5.32 “P4” Malfunction of Radiator Fin Temperature Thermistor

Remote Controller Display	<i>P4</i>
Applicable Models	RZQ71~140
Method of Malfunction Detection	Detection by open or short circuit of the radiator fin temperature thermistor during the compressor stops operating.
Malfunction Decision Conditions	When open or short circuit of the radiator fin temperature thermistor is detected during the compressor stops operating
Supposed Causes	<ul style="list-style-type: none"> ■ Faulty radiator fin temperature thermistor ■ Faulty outdoor unit PC board

Troubleshooting

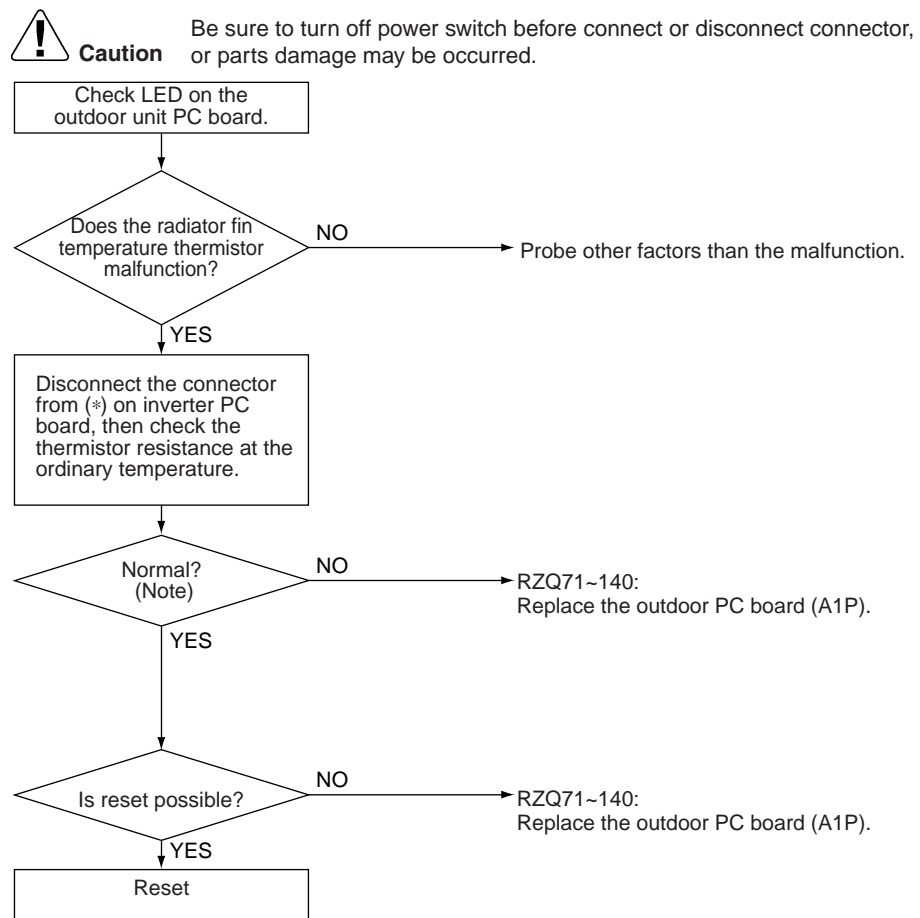

(*) Connector number

RZQ71~140	X111A
-----------	-------

* Refer to P218~219 for “Thermistor temperature/Resistance characteristics”.

5.33 “PJ” Failure of Capacity Setting

Remote Controller Display	<i>PJ</i>
Applicable Models	RZQ71~140
Method of Malfunction Detection	Check whether set value written in E ² PROM (at factory) or set value of capacity setting adaptor (for replacement) is the same as outdoor unit capacity.
Malfunction Decision Conditions	When the set value on E ² PROM differs from the outdoor unit capacity or a capacity setting adaptor except for PC board applicable models is installed. (Malfunction decision is made only when turning the power supply on.)
Supposed Causes	<ul style="list-style-type: none"> ■ Improper set value of E²PROM ■ Improper capacity setting adaptor ■ Faulty outdoor unit PC board

Troubleshooting

 **Caution** Be sure to turn off power switch before connect or disconnect connector, or parts damage may be occurred.

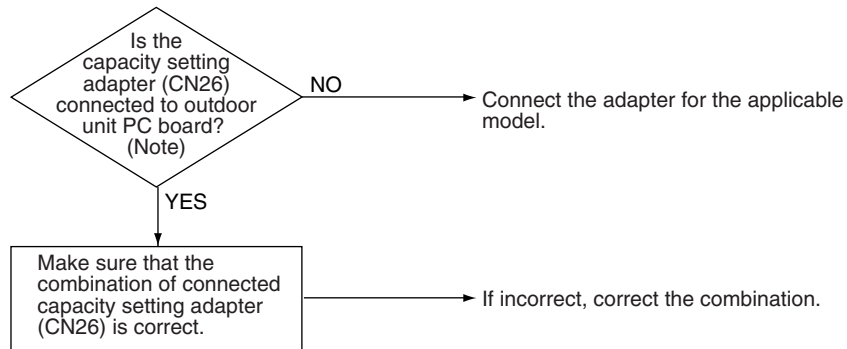

(Note)
Capacity setting adapter is not connected at factory. (Capacity is written in E²PROM.) Capacity setting adapter is required only when the PC board was replaced with spare PC board.

5.34 “U0” Gas Shortage (Malfunction)

Remote Controller Display	U0
Applicable Models	RZQ71~140D7V1B
Method of Malfunction Detection	<p>(In cooling operation) Detection based on difference in temperature between temperature preset by remote controller and indoor suction air temperature, motorized valve opening degree, compressor frequency and low pressure.</p> <p>(In heating operation) Detection based on difference in temperature between temperature preset by remote controller and indoor suction air temperature, motorized valve opening degree during the control of suction air superheating, high pressure, indoor heat exchanger temperature and indoor suction air temperature.</p>
Malfunction Decision Conditions	<p>(In cooling operation) When compressor frequency does not increase even though the load is heavy because the motorized valve is opened to the fullest extent [If low pressure drops when the compressor is at 41Hz, malfunction is confirmed.]</p> <p>(In heating operation) When suction gas superheat degree is large, compressor frequency is low and the motorized valve is opened to the fullest extent even though heating load is heavy [If high pressure is lower than saturated pressure for indoor heat exchanger temperature (or indoor suction air temperature), malfunction is confirmed.]</p>
Supposed Causes	<ul style="list-style-type: none"> ■ Refrigerant shortage (out of gas) ■ Clogged refrigerant piping system ■ Mismatching of wiring and piping

Troubleshooting



Caution

Be sure to turn off power switch before connect or disconnect connector, or parts damage may be occurred.

Check 13 Check for refrigerant shortage.

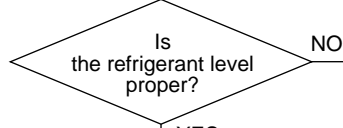

Collect refrigerant and recharge a proper amount of refrigerant after vacuum drying.

Check the inter-unit wiring and piping between the indoor and outdoor units.

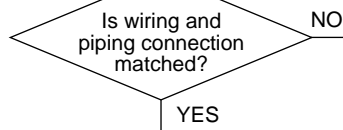

Match wiring and piping connection.

Check the refrigerant piping system for clogging. **Check 8**

5.35 “U2” Abnormal Power Supply Voltage

Remote Controller Display	U2
Applicable Models	RZQ71~140
Method of Malfunction Detection	Malfunction is detected according to the voltage of main circuit capacitor built in the inverter and power supply voltage.
Malfunction Decision Conditions	When the voltage of main circuit capacitor built in the inverter and power supply voltage drop (150-170 VAC) or when the power failure of several tons of ms or longer is generated. * Remote controller does not decide the abnormality.
Supposed Causes	<ul style="list-style-type: none"> ■ Drop in power supply voltage (180 V or less) ■ Instantaneous power failure ■ Inverter open phase (Phase T) ■ Faulty main circuit wiring ■ Faulty outdoor inverter PC board ■ Main circuit parts damaged

Troubleshooting



Caution

Be sure to turn off power switch before connect or disconnect connector, or parts damage may be occurred.

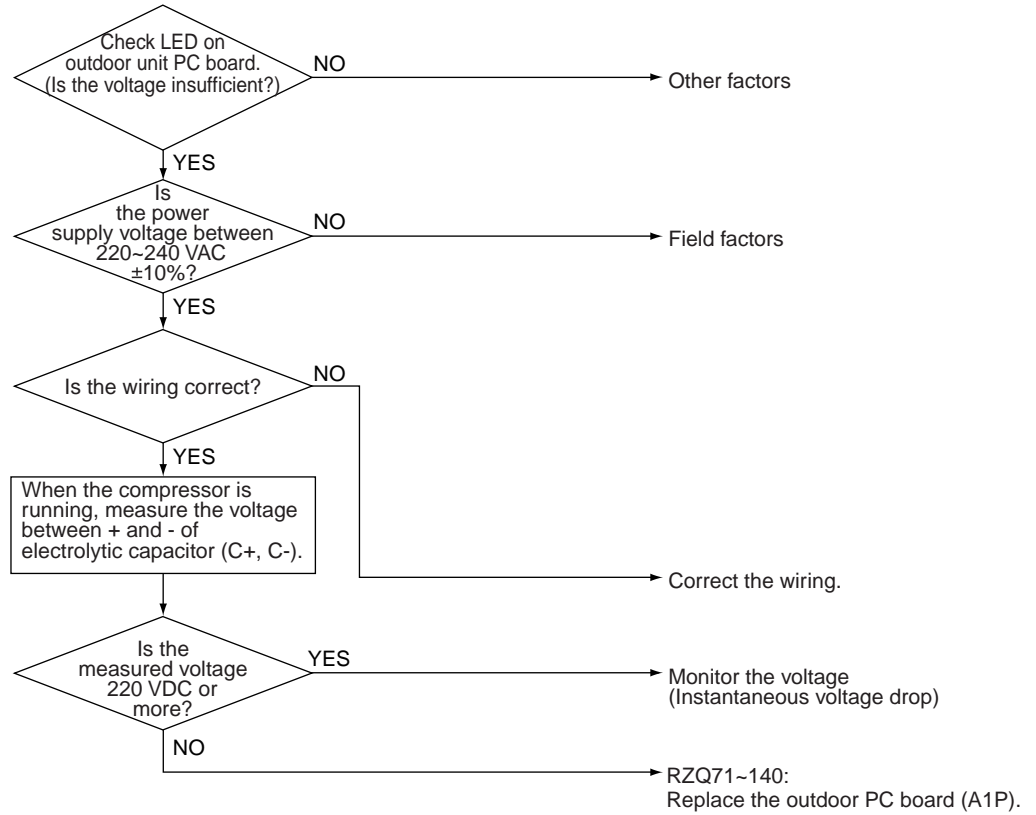

5.36 “U4”, “UF” Malfunction of Transmission between Indoor and Outdoor Unit

Remote Controller Display	<i>U4</i> or <i>UF</i>
Applicable Models	RZQ71~140
Error generation	The error is generated when the microprocessor detects that the transmission between the indoor and the outdoor unit is not normal over a certain amount of time.
Supposed Causes	<p>The possible causes are:</p> <ul style="list-style-type: none"> ■ Wiring indoor-outdoor transmission wire is incorrect ■ Malfunctioning indoor unit PC board ■ Malfunctioning outdoor unit PC board ■ burning out fuse ■ Faulty fan motor ■ Outside cause (noise...).

Troubleshooting

Diagnosis of incorrect or broken/disconnected wiring. If the LEDs on the indoor unit PC board are off, it indicates that the transmission wiring between indoor and outdoor units may be incorrect or broken/disconnected.



Caution

Be sure to turn off power switch before connect or disconnect connector, or parts damage may be occurred.

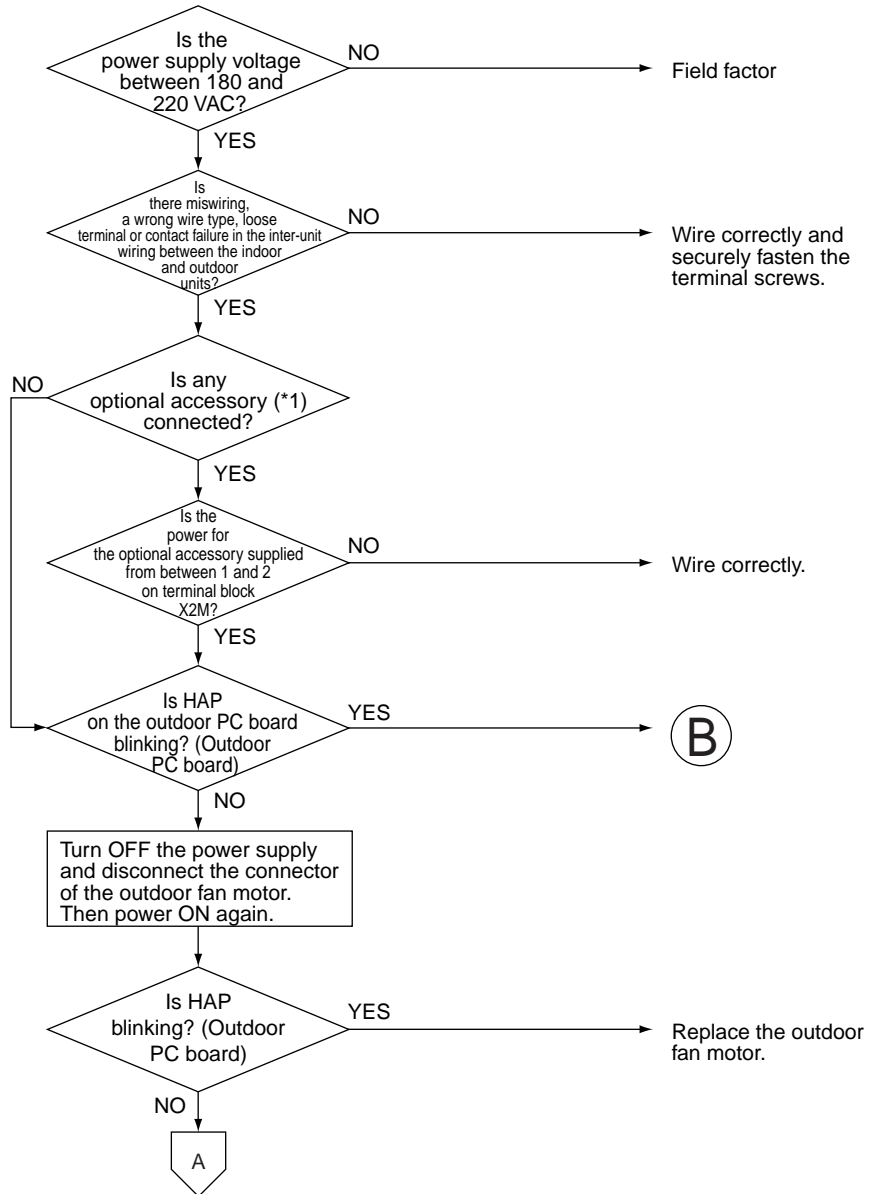

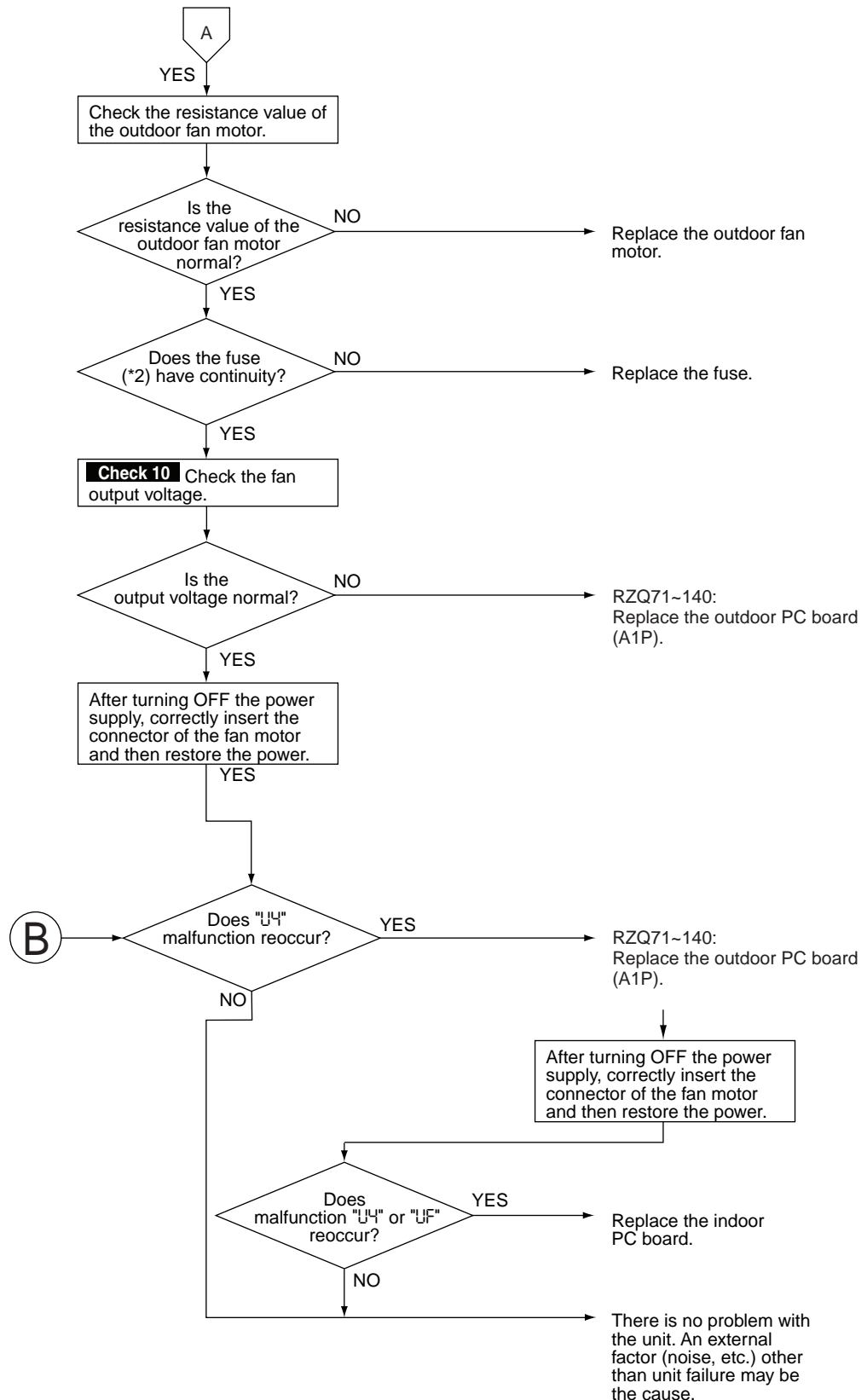

Note *1: Optional accessories refer to wire adapter, auto grill and other accessories.

*2: RZQ71~140=>F6U

5.37 “UF” Malfunction of Transmission between Indoor and Outdoor Unit / Piping and Wiring Mismatch / Gas Shortage

Remote Controller Display	UF
Applicable Models	RZQ71~140
Method of Malfunction Detection	<p>Check the transmission between the indoor and outdoor units with a microcomputer when the power turned ON.</p> <p>Detect by checking the following temperature differences during compressor operation.</p> <p>A: Difference in temperature detected by the indoor heat exchanger thermistor (R2T) and the indoor suction air thermistor (R1T)</p> <p>B: Difference in evaporation temperature (Te) (or condensation temperature (Tc) during heating operation) detected by the indoor heat exchanger thermistor (R2T) and the compressor sensor</p>
Malfunction Decision Conditions	<p>When the inter-unit wiring between the indoor and outdoor units is incorrect</p> <p>When the following conditions continue for 20 minutes during compressor operation</p> <p>A: $R2T - R1T < 4^{\circ}\text{C}$, and</p> <p>B: $R2T - T_e$ (or T_c during heating operation) $> 14^{\circ}\text{C}$ (24°C during heating operation)</p>
Supposed Causes	<ul style="list-style-type: none"> ■ Faulty inter-unit wiring between the indoor and outdoor units ■ Mismatching of wiring and piping ■ Refrigerant shortage (out of gas) ■ Clogged refrigerant piping system

Troubleshooting

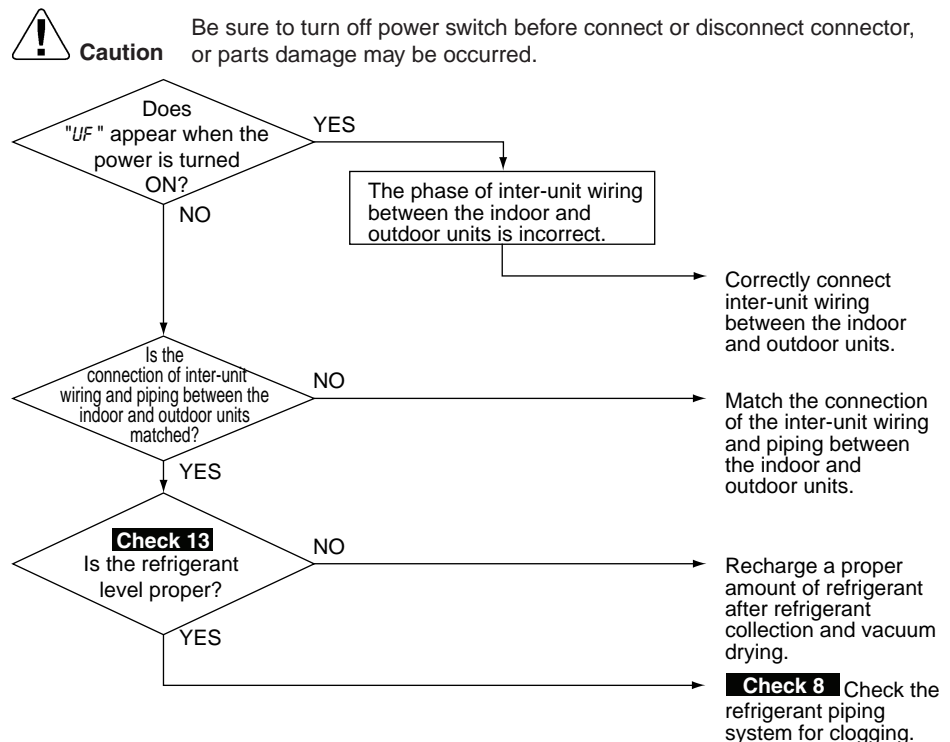

5.38 “U5” Malfunction of Transmission between Indoor Unit and Remote Controller

Remote Controller Display	U5
Applicable Models	All models of indoor units
Error generation	The error is generated when the microprocessor detects that the transmission between the indoor unit and the remote controller is not normal over a certain amount of time.
Supposed Causes	<p>The possible causes are:</p> <ul style="list-style-type: none"> ■ Malfunctioning remote controller ■ Malfunctioning indoor PC board ■ Outside cause (noise...) ■ Connection of two master remote controllers (when using two remote controllers).
Troubleshooting	

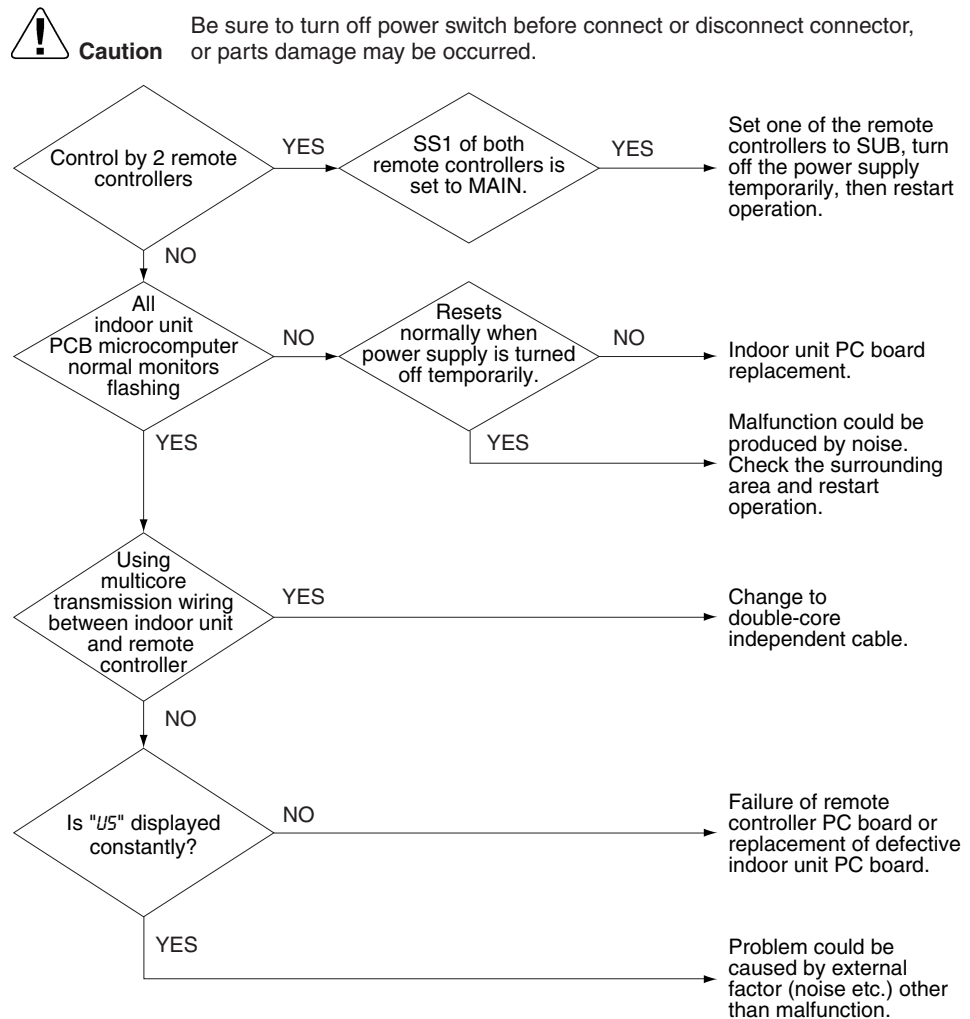

5.39 “UB” Malfunction of Transmission between MAIN Remote Controller and SUB Remote Controller

Remote Controller Display	UB
Applicable Models	All models of indoor units
Error generation	The error is generated when, in case of controlling with two remote controllers, the microprocessor detects that the transmission between the indoor unit and the remote controllers (MAIN and SUB) is not normal over a certain amount of time.
Supposed Causes	<p>The possible causes are:</p> <ul style="list-style-type: none"> ■ Transmission error between MAIN remote controller and SUB remote controller ■ Connection among SUB remote controllers ■ Malfunctioning remote controller PC board.

Troubleshooting

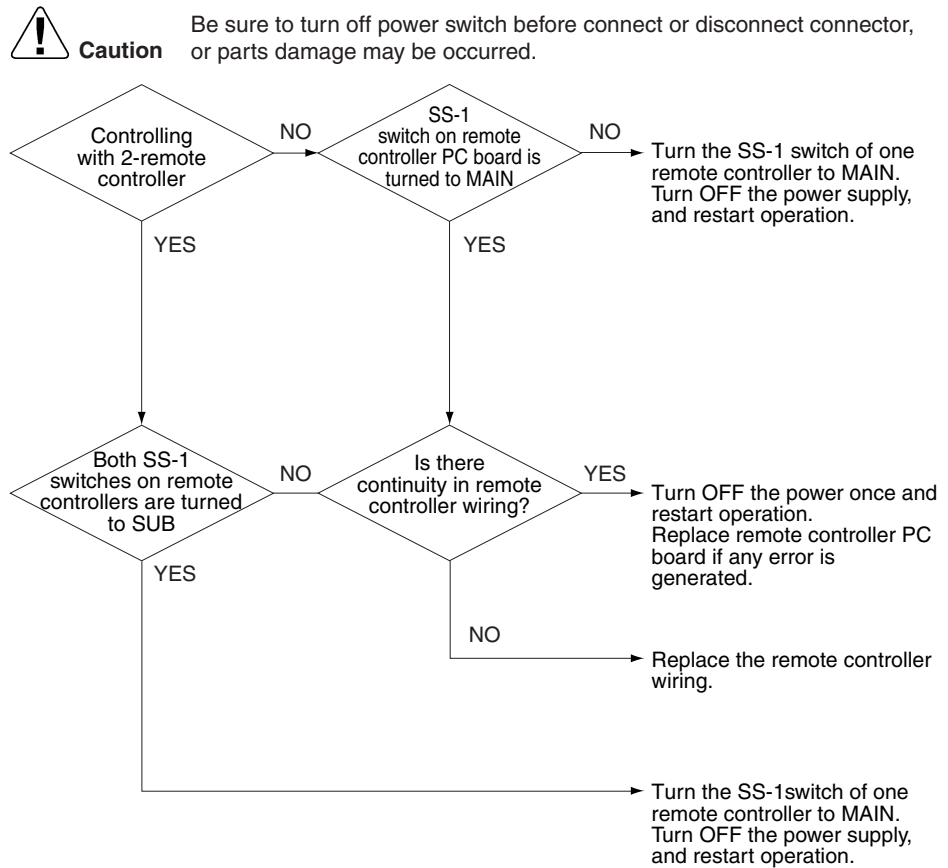

5.40 “UR” Malfunctioning Field Setting Switch

**Remote
Controller
Display**

UR

**Applicable
Models**

All models of indoor units

Error generation

The error is generated when incorrect field settings have been set for pair/twin/triple/double twin.

**Supposed
Causes**

The possible causes are:

- Malfunctioning indoor or outdoor unit PC board
- Malfunctioning power supply PC board
- Indoor-outdoor, indoor-indoor unit transmission wiring
- Malfunctioning remote controller wiring.

Troubleshooting



Caution

Be sure to turn off power switch before connect or disconnect connector, or parts damage may be occurred.

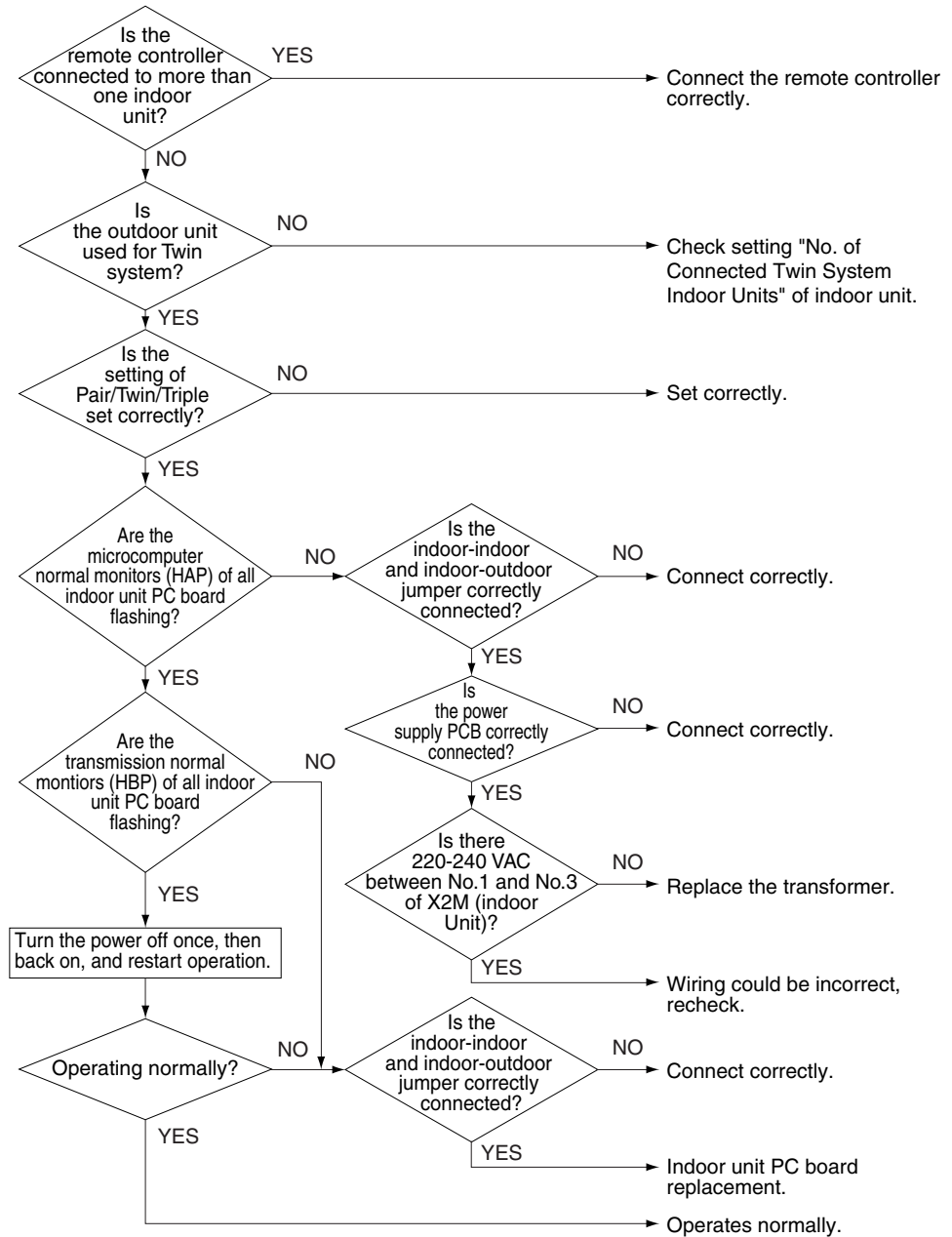

5.41 “UC” Centralized Address Setting Error

Remote
Controller
Display

UC

Applicable
Models

All models of indoor units

Method of
Malfunction
Detection

Indoor unit microcomputer detects and judges the centralized address signal according to the transmission between indoor units.

Malfunction
Decision
Conditions

When the microcomputer judges that the centralized address signal is duplicated

Supposed
Causes

- Faulty centralized address setting
- Faulty indoor unit PC board

Troubleshooting



Caution

Be sure to turn off power switch before connect or disconnect connector, or parts damage may be occurred.

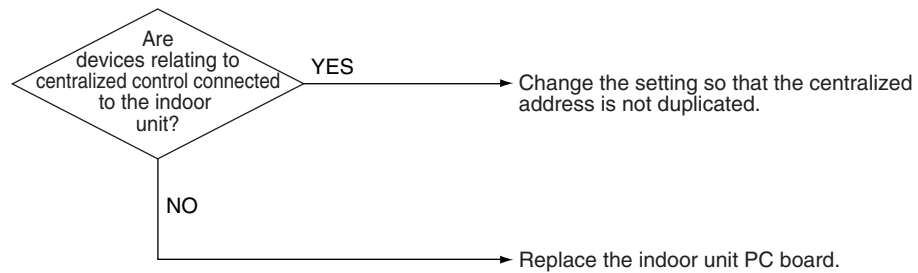

Check No.1 Outdoor Unit: Checking the Installation Condition

Checking

To check the installation condition, proceed as follows:

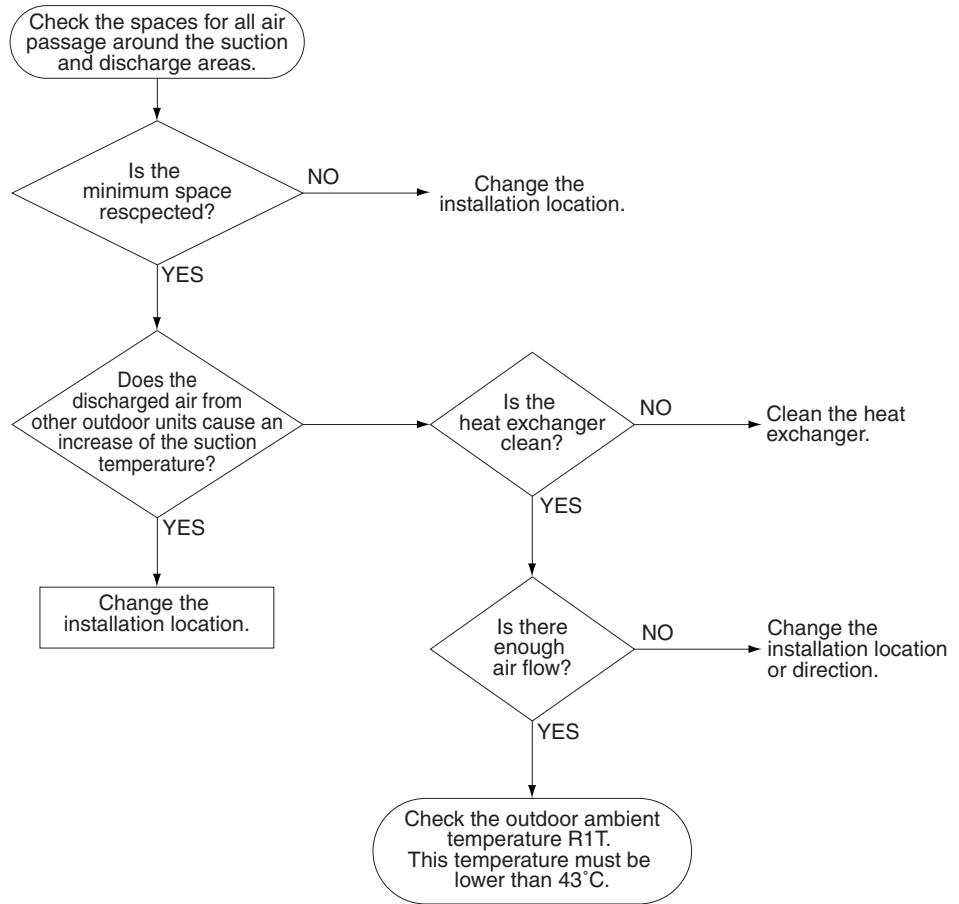

Check No.2 Outdoor Unit: Checking the Expansion Valve

Checking

To check the electronic expansion valve, proceed as follows:

Step	Action																																																	
1	Check if the expansion valve connector is correctly inserted in the X12A of A1P.																																																	
2	Compare the expansion valve unit with the number of the connector to make sure it is correctly connected.																																																	
3	Switch the power OFF.																																																	
4	Switch the power ON to check whether the expansion valve is producing a clicking sound. <table border="1" style="margin-left: 20px;"> <thead> <tr> <th>If...</th> <th>Then...</th> </tr> </thead> <tbody> <tr> <td>The expansion valve has no clicking sound</td> <td>Disconnect the valve connector without the clicking sound and proceed to step 5.</td> </tr> </tbody> </table>	If...	Then...	The expansion valve has no clicking sound	Disconnect the valve connector without the clicking sound and proceed to step 5.																																													
If...	Then...																																																	
The expansion valve has no clicking sound	Disconnect the valve connector without the clicking sound and proceed to step 5.																																																	
5	Check the coil current: Open circuit < normal < short circuit The table below contains the reference resistance values. <table border="1" style="margin-left: 20px;"> <thead> <tr> <th>—</th> <th>White</th> <th>Grey</th> <th>Black</th> <th>Yellow</th> <th>Red</th> <th>Orange</th> </tr> </thead> <tbody> <tr> <td>White</td> <td>—</td> <td>∞</td> <td>45 Ω</td> <td>∞</td> <td>45 Ω</td> <td>∞</td> </tr> <tr> <td>Grey</td> <td>∞</td> <td>—</td> <td>∞</td> <td>45 Ω</td> <td>∞</td> <td>45 Ω</td> </tr> <tr> <td>Black</td> <td>45 Ω</td> <td>∞</td> <td>—</td> <td>∞</td> <td>90 Ω</td> <td>∞</td> </tr> <tr> <td>Yellow</td> <td>∞</td> <td>45 Ω</td> <td>∞</td> <td>—</td> <td>∞</td> <td>90 Ω</td> </tr> <tr> <td>Red</td> <td>45 Ω</td> <td>∞</td> <td>90 Ω</td> <td>∞</td> <td>—</td> <td>∞</td> </tr> <tr> <td>Orange</td> <td>∞</td> <td>45 Ω</td> <td>∞</td> <td>90 Ω</td> <td>∞</td> <td>—</td> </tr> </tbody> </table>	—	White	Grey	Black	Yellow	Red	Orange	White	—	∞	45 Ω	∞	45 Ω	∞	Grey	∞	—	∞	45 Ω	∞	45 Ω	Black	45 Ω	∞	—	∞	90 Ω	∞	Yellow	∞	45 Ω	∞	—	∞	90 Ω	Red	45 Ω	∞	90 Ω	∞	—	∞	Orange	∞	45 Ω	∞	90 Ω	∞	—
—	White	Grey	Black	Yellow	Red	Orange																																												
White	—	∞	45 Ω	∞	45 Ω	∞																																												
Grey	∞	—	∞	45 Ω	∞	45 Ω																																												
Black	45 Ω	∞	—	∞	90 Ω	∞																																												
Yellow	∞	45 Ω	∞	—	∞	90 Ω																																												
Red	45 Ω	∞	90 Ω	∞	—	∞																																												
Orange	∞	45 Ω	∞	90 Ω	∞	—																																												
6	Check the clicking sound again. <table border="1" style="margin-left: 20px;"> <thead> <tr> <th>If...</th> <th>Then...</th> </tr> </thead> <tbody> <tr> <td>There is a clicking sound</td> <td>The expansion valve works properly.</td> </tr> <tr> <td>There is no clicking sound</td> <td>Replace the expansion valve unit.</td> </tr> <tr> <td>There is still no clicking sound</td> <td>Replace outdoor PC board A1P.</td> </tr> </tbody> </table>	If...	Then...	There is a clicking sound	The expansion valve works properly.	There is no clicking sound	Replace the expansion valve unit.	There is still no clicking sound	Replace outdoor PC board A1P.																																									
If...	Then...																																																	
There is a clicking sound	The expansion valve works properly.																																																	
There is no clicking sound	Replace the expansion valve unit.																																																	
There is still no clicking sound	Replace outdoor PC board A1P.																																																	

Check No.3 Checking the Thermistors**Thermistors**

If the cause of the problem is related to the thermistors, then the thermistors should be checked prior to changing the PC board.

For more information about these thermistors, see:

- “Wiring Diagrams” (outdoor units)
- “Functions of Thermistors” on P27.

Overview of thermistors

The table below contains an overview of the thermistors:

Thermistor		Description	
Indoor	R1T	Suction air thermistor	
	R2T	Heat exchanger thermistor	
Outdoor	RZQ71~140	R1T	Ambient air thermistor
		R2T	Discharge pipe thermistor
		R3T	Suction pipe thermistor
		R4T	Heat exchanger thermistor
		R5T	Intermediate heat exchanger thermistor
		R6T	Liquid pipe thermistor
		R10T	Power module fin thermistor

Checking

To check the thermistors, proceed as follows:

Step	Action
1	Disconnect the thermistor from the PC board.
2	Read the temperature and the resistor value.
3	Check if the measured values correspond with the values in the table on the next pages.

Check No.4 Resistance Conversion Table (Ambient, Coil, Fin)

Temperature – resistance

The table below is the thermistor (Indoor : Suction air, Coil / Outdoor : Ambient, Coil, Pipe without discharge, Fin) temperature – resistance conversion table.

Temp. (°C)	A (kΩ)	B (kΩ)	Temp. (°C)	A (kΩ)	B (kΩ)	Temp. (°C)	A (kΩ)	B (kΩ)
-20	197.81	192.08	20	25.01	24.45	60	4.96	4.87
-19	186.53	181.16	21	23.91	23.37	61	4.79	4.70
-18	175.97	170.94	22	22.85	22.35	62	4.62	4.54
-17	166.07	161.36	23	21.85	21.37	63	4.46	4.38
-16	156.80	152.38	24	20.90	20.45	64	4.30	4.23
-15	148.10	143.96	25	20.00	19.56	65	4.16	4.08
-14	139.94	136.05	26	19.14	18.73	66	4.01	3.94
-13	132.28	128.63	27	18.32	17.93	67	3.88	3.81
-12	125.09	121.66	28	17.54	17.17	68	3.75	3.68
-11	118.34	115.12	29	16.80	16.45	69	3.62	3.56
-10	111.99	108.96	30	16.10	15.76	70	3.50	3.44
-9	106.03	103.18	31	15.43	15.10	71	3.38	3.32
-8	100.41	97.73	32	14.79	14.48	72	3.27	3.21
-7	95.14	92.61	33	14.18	13.88	73	3.16	3.11
-6	90.17	87.79	34	13.59	13.31	74	3.06	3.01
-5	85.49	83.25	35	13.04	12.77	75	2.96	2.91
-4	81.08	78.97	36	12.51	12.25	76	2.86	2.82
-3	76.93	74.94	37	12.01	11.76	77	2.77	2.72
-2	73.01	71.14	38	11.52	11.29	78	2.68	2.64
-1	69.32	67.56	39	11.06	10.84	79	2.60	2.55
0	65.84	64.17	40	10.63	10.41	80	2.51	2.47
1	62.54	60.96	41	10.21	10.00	—		
2	59.43	57.94	42	9.81	9.61			
3	56.49	55.08	43	9.42	9.24			
4	53.71	52.38	44	9.06	8.88			
5	51.09	49.83	45	8.71	8.54			
6	48.61	47.42	46	8.37	8.21			
7	46.26	45.14	47	8.05	7.90			
8	44.05	42.98	48	7.75	7.60			
9	41.95	40.94	49	7.46	7.31			
10	39.96	39.01	50	7.18	7.04			
11	38.08	37.18	51	6.91	6.78			
12	36.30	35.45	52	6.65	6.53			
13	34.62	33.81	53	6.41	6.33			
14	33.02	32.25	54	6.65	6.53			
15	31.50	30.77	55	6.41	6.29			
16	30.06	29.37	56	6.18	6.06			
17	28.70	28.05	57	5.95	5.84			
18	27.41	26.78	58	5.74	5.43			
19	26.18	25.59	59	5.14	5.05			

Applicable sensors

A: Indoor: Suction air, Coil
Outdoor: Ambient, Coil, Pipe without discharge

B: Outdoor: Fin

Check No.5 Resistance Conversion Table (Discharge Pipe Sensor)

Temperature – resistance

The table below is the discharge pipe thermistor temperature – resistance conversion table.

Temp. (°C)	Resist. (kΩ)
—	—
—	—
-6.0	1120.0
-4.0	1002.5
-2.0	898.6
0.0	806.5
2.0	724.8
4.0	652.2
6.0	587.6
8.0	530.1
10.0	478.8
12.0	432.9
14.0	392.0
16.0	355.3
18.0	322.4
20.0	292.9
22.0	266.3
24.0	242.5
26.0	221.0
28.0	201.6
30.0	184.1
32.0	168.3
34.0	154.0
36.0	141.0
38.0	129.3
40.0	118.7
42.0	109.0
44.0	100.2
46.0	92.2
48.0	84.9
50.0	78.3
52.0	72.2
54.0	66.7
56.0	61.6
48.0	57.0

Temp. (°C)	Resist. (kΩ)
60.0	52.8
62.0	48.9
64.0	45.3
66.0	42.0
68.0	39.0
70.0	36.3
72.0	33.7
74.0	31.4
76.0	29.2
78.0	27.2
80.0	25.4
82.0	23.7
84.0	22.1
86.0	20.7
88.0	19.3
90.0	18.1
92.0	16.9
94.0	15.8
96.0	14.8
98.0	13.9
100.0	13.1
102.0	12.3
104.0	11.5
106.0	10.8
108.0	10.2
110.0	9.6
112.0	9.0
114.0	8.5
116.0	8.0
118.0	7.6
120.0	7.1
122.0	6.7
124.0	6.4
126.0	6.0
128.0	5.7

Temp. (°C)	Resist. (kΩ)
130.0	5.4
132.0	5.4
134.0	4.8
136.0	4.6
138.0	4.3
140.0	4.1
142.0	3.9
144.0	3.7
146.0	3.5
148.0	3.3
150.0	3.2
152.0	3.0
154.0	2.9
156.0	2.7
158.0	2.6
160.0	2.5
162.0	2.3
164.0	2.5
166.0	2.1
168.0	2.0
170.0	1.9
172.0	1.9
174.0	1.8
176.0	1.7
178.0	1.6
180.0	1.5
—	—

Check No.6 Evaluation of Abnormal High Pressure

Abnormally high pressure level is mostly caused by the condenser side. The following contents are provided by service engineer based on their field checks. Further, the number is listed in the order of degree of influence.

In cooling operation

Check items (Possible causes)	Judgment
Does the outdoor unit fan run normally?	Visual inspection
Is the outdoor unit heat exchanger clogged?	Visual inspection
Is there clogging before or after the EV (capillary)?	Check if there is a temperature difference before and after EV (capillary). Check if the main valve unit of EV operates (by noise, vibration).
Is the check valve clogged? *Heat pump model only	Check if there is a temperature difference before and after check valve. →If YES, the check valve is caught.
Is the HPS normal?	Check continuity by using a tester.
Is the outdoor unit installed under such conditions that short circuit easily occurs?	Visual inspection
Is the piping length 5 meters or less?	Visual inspection
Does air enter the refrigerant system?	Conduct refrigerant collection and vacuum drying, and then add proper amount refrigerant.
Is the refrigerant overcharged?	Conduct refrigerant collection and vacuum drying, and then add proper amount refrigerant.

In heating operation

Check items (Possible causes)	Judgment
Does the indoor unit fan run normally?	Visual inspection
Is the indoor unit heat exchanger clogged?	Visual inspection
Is the indoor unit installed under such conditions that short circuit easily occurs?	Visual inspection
Is there clogging before or after the EV (capillary)?	Check if there is a temperature difference before and after EV (capillary). Check if the main valve unit of EV operates (by noise, vibration).
Is the check valve clogged?	Check if there is a temperature difference before and after check valve. →If YES, the check valve is caught.
Is the HPS normal?	Check continuity using a tester.
Is the piping length 5 meters or less?	Visual inspection
Does air enter the refrigerant system?	Conduct refrigerant collection and vacuum drying, and then add proper amount refrigerant.
Is the refrigerant overcharged?	Conduct refrigerant collection and vacuum drying, and then add proper amount refrigerant.

Check No.7 Evaluation of Abnormal Low Pressure

Abnormally low pressure level is mostly caused by the evaporator side. The following contents are provided based on field checking of service engineer. Further, the number is listed in the order of degree of influence.

In cooling operation

Check items (Possible causes)	Judgment
Does the outdoor unit fan run normally?	Visual inspection
Is the indoor unit filter clogged?	Visual inspection
Is there clogging before or after the EV (capillary)?	Check if there is a temperature difference before and after EV (capillary). Check if the main valve unit of EV operates (by noise, vibration).
Is the check valve clogged? *Heat pump model only	Check if there is a temperature difference before and after check valve. →If YES, the check valve is caught.
Is the LPS normal?	Check continuity using a tester.
Is the indoor unit installed under such conditions that short circuit easily occurs?	Visual inspection
Is the refrigerant gas short?	Conduct refrigerant collection and vacuum drying, and then add proper amount refrigerant.

In heating operation

Check items (Possible causes)	Judgment
Does the outdoor unit fan run normally?	Visual inspection
Is the outdoor unit heat exchanger clogged?	Visual inspection
Is the outdoor unit installed under such conditions that short circuit easily occurs?	Visual inspection
Is there clogging before or after the EV (capillary)?	Check if there is a temperature difference before and after EV (capillary). Check if the main valve unit of EV operates (by noise, vibration).
Is the check valve clogged?	Check if there is a temperature difference before and after check valve. →If YES, the check valve is caught.
Is the LPS normal?	Check continuity using a tester.
Is the refrigerant gas short?	Conduct refrigerant collection and vacuum drying, and then add proper amount refrigerant.

Check No.8 Clogged Points

Temperature differences must occur before or after the clogged points!

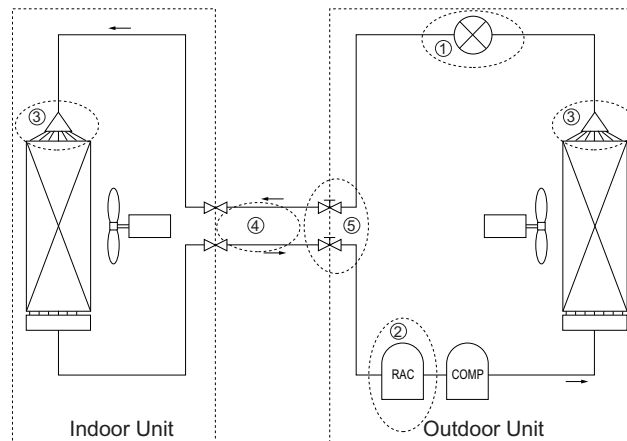

Check points		Check factor	Causes	Remedies
1	Around expansion mechanism	Temperature difference	<ul style="list-style-type: none"> ● Dust ● Choked moisture ● Reduced effective pipe diameter due to adherent contamination, etc. 	Replace the expansion valve.
2	Accumulator	Frosting	<ul style="list-style-type: none"> ● Choked moisture 	Blow a nitrogen gas, and then replace the refrigerant.
3	Distributor	Temperature difference	<ul style="list-style-type: none"> ● Dust ● Choked moisture ● Reduced effective pipe diameter due to adherent contamination, etc. 	Replace the heat exchanger or distributor.
4	Field piping	Temperature difference	<ul style="list-style-type: none"> ● Collapsed pipe 	Replace the pipe.
5	Stop valve	Temperature difference	<ul style="list-style-type: none"> ● The stop valve is not fully open. 	Open the stop valve fully.

Check No.9 Outdoor Unit: Fan Motor Signal Line

For RZQ71~140 models

- (1) Turn the power supply off.
- (2) With the fan motor connector disconnected, measure the resistance between each pin, then make sure that the resistance is more than the value mentioned in the following table.

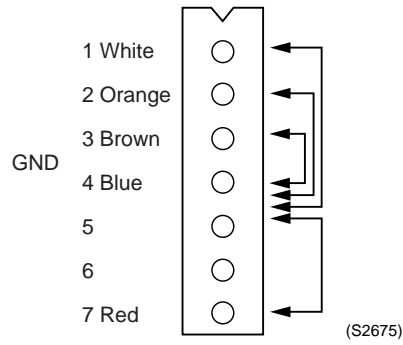

Measurement point	Judgment
1 - 4	1MΩ or more
2 - 4	100kΩ or more
3 - 4	100Ω or more
4 - 7	100kΩ or more

Check No.10 Outdoor Unit: Fan Speed Pulse

For 1 Fan & 2 Fan models

- (1) Disconnect the connector A* with the power supply OFF and Operation OFF.
- (2) Is the voltage between pins 4 and 3 of A* about 15 VDC after turning the power supply on?
- (3) Is the voltage between pins 4 and 1 of A* about 5 VDC?
- (4) Connect the connector A* with the power supply OFF and Operation OFF.
- (5) When making one turn of the upper fan motor by hand after turning the power supply on, is a pulse (0 and 5 V) generated 4 times between pins 4 and 1 of A*? (Measure at the contact terminal on the harness side with the connector connected.)

For 2 Fan models

- (6) Disconnect the connector X107A with the power supply OFF and Operation OFF.
- (7) Is the voltage between pins 4 and 3 of X107A about 15 VDC after turning the power supply on?
- (8) Is the voltage between pins 4 and 1 of X107A about 5 VDC?
- (9) Connect the connector X107A with the power supply OFF and Operation OFF.
- (10) When making one turn of the lower fan motor by hand after turning the power supply on, is a pulse (0 and 5 V) generated 4 times between pins 4 and 1 of X107A?

-
- (2) (7): NO →Faulty PC board →Replace the PC board.
 (3) (8): NO →Faulty PC board →Replace the PC board.
 (5)(10): NO →Faulty hall IC →Replace the DC fan motor.
 (2) (3) (5) (7) (8) (10): YES →Replace the PC board.
-

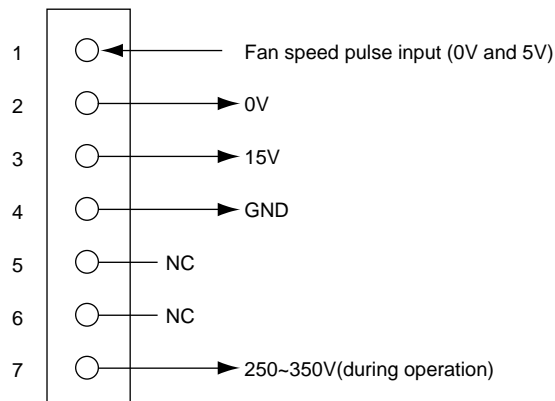

(S2679)

Note

	RZQ71~140
A*	106 A

Check No.11 Outdoor Unit: Check for Power Transistor

Judgment according to the continuity check by using an analog tester:

- (1) Do not touch the charged area (high voltage) for 10 minutes after turning the power supply off.
- (2) If you must touch such an area, make sure that the power supply voltage of power transistor is 50 V or less.
- (3) Disconnect the connector of the outdoor unit fan motor.
When the outdoor unit fan is rotating against a strong wind, the condenser is charged and electric shock may result. Therefore, disconnect the connector from the outdoor unit fan motor after confirming that the outdoor unit fan has stopped.
- (4) Before measuring the continuity, disconnect the connection between compressor and power transistor.
- (5) Measure the continuity in the following procedure.
[Judgment] Normal if the continuity check results in the following.

**Power transistor
(on inverter PC board)**

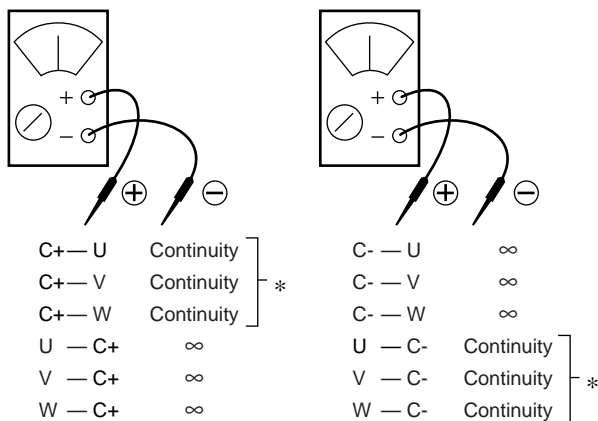

(S2678)

- * If there is continuity, the resistance should be the same as each phase.
- * If a digital tester is used for the measurement of continuity, ∞ and continuity may be reversed.

Check No.12 Check for Inadequate Refrigerant

As criteria for judging whether refrigerant is inadequate or not, refer to the following operating conditions.

<Diagnosis of inadequate refrigerant>

In cooling operation

- (1) As suction superheat degree increases due to gas shortage, the electronic expansion valve tends to open (opens fully) in order to avoid overheat operation.
- (2) In response to decreased evaporator capacity caused by gas shortage, capacity is controlled in the inverter in order to maintain low pressure, which results in a decrease in frequency.
- (3) Because of (1) and (2) above, the compressor frequency decreases despite a large difference (large load) between temperature set by the remote controller and indoor suction temperature, resulting that cooling capacity becomes unavailable.
- (4) If gas shortage worsens, the electronic expansion valve remains fully open and suction superheat degree further increases. In addition, because the compressor frequency drops to the level of the lowest frequency (52 Hz) and the refrigerant flow rate decrease, low pressure cannot be maintained.

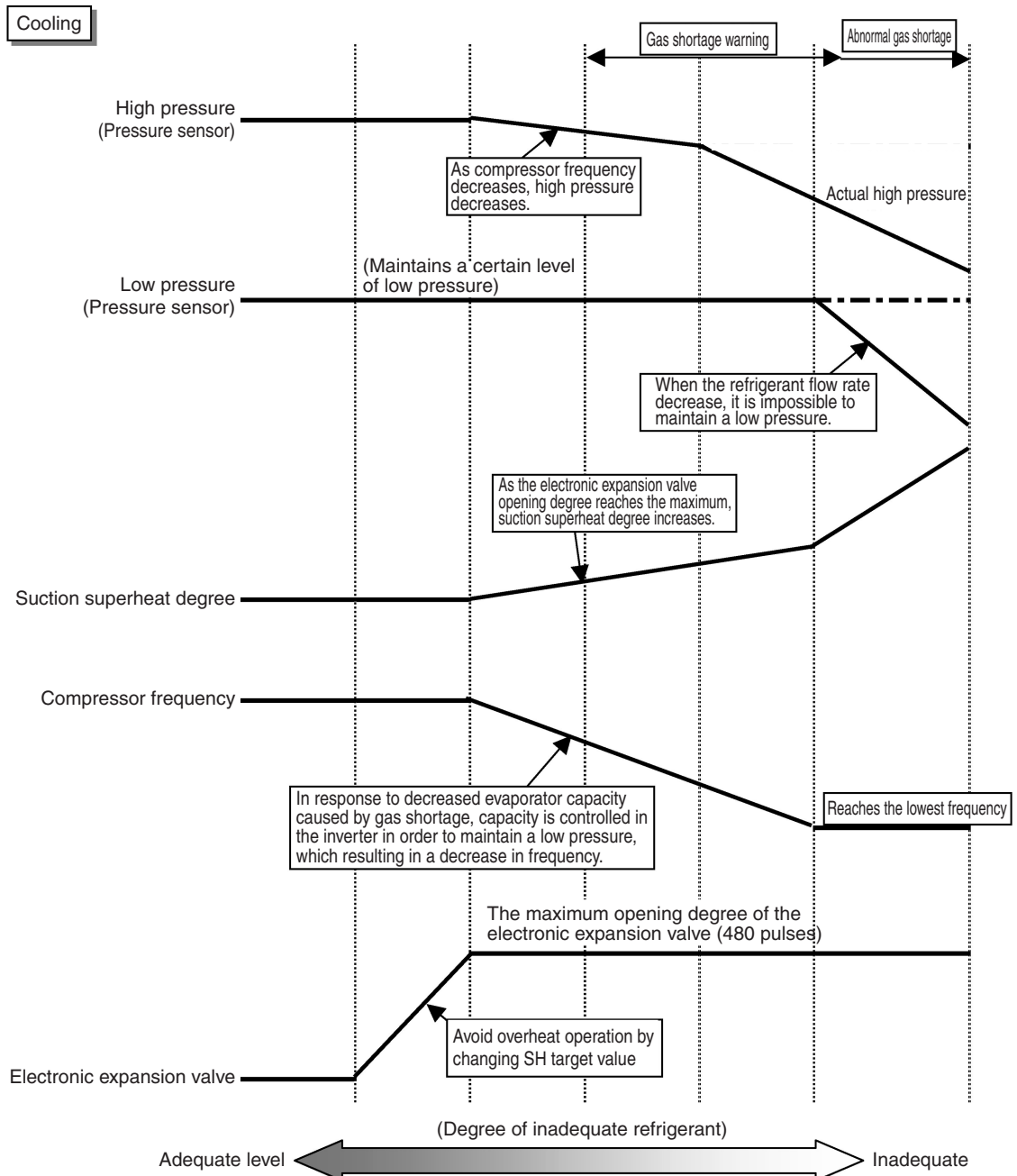

<Diagnosis of inadequate refrigerant>

In heating operation

- (1) As suction superheat degree increases due to gas shortage, the electronic expansion valve tends to open (opens fully) to avoid overheat operation.
- (2) As suction superheat degree increases due to gas shortage, compressor frequency decreases because suction superheat degree is controlled in order to prevent oil to the outdoor heat exchanger from being retained.
- (3) Because of (1) and (2) above, evaporator capacity and compressor frequency decrease despite a large difference (large load) between temperature set by the remote controller and indoor suction temperature, resulting that high pressure cannot be maintained and heating capacity becomes unavailable. Also a decrease in evaporator capacity frequently puts the system in defrost operation.
- (4) If gas shortage worsens, high pressure becomes smaller than saturated pressure equivalent to indoor heat exchanger temperature (or indoor suction temperature).

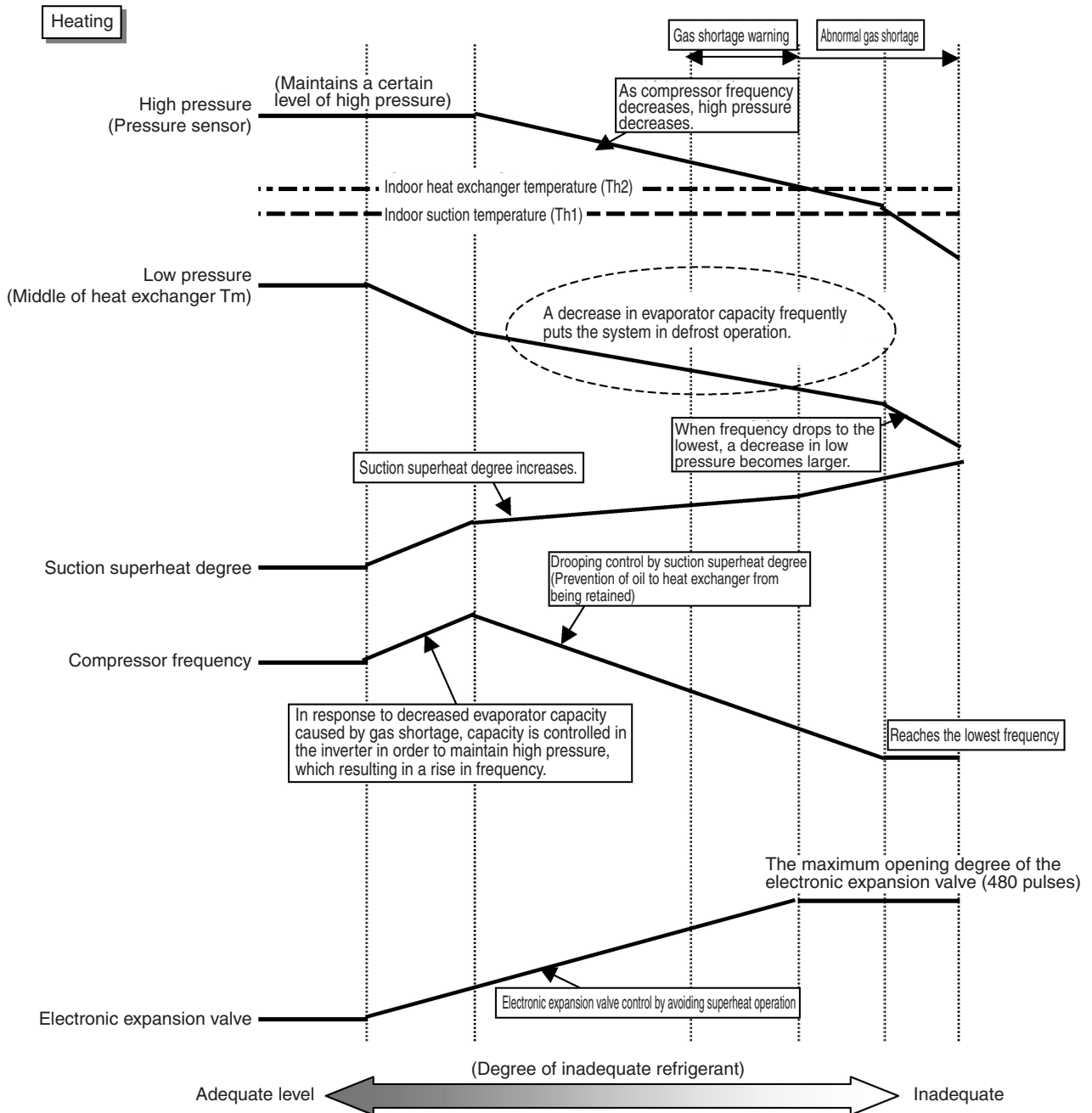

Check No.13 Check for Excessive Refrigerant Charging

As criteria for judging whether refrigerant is excessively charged or not, refer to the following operating conditions.

<Diagnosis of excessive refrigerant charging>

In cooling operation

- (1) Because high pressure rises due to excessive charging, overload control is carried out and capacity tends to run short.
- (2) Considering pressure load, compressor discharge pipe temperature is low.
- (3) Subcooled degree of condensate liquid becomes large. Therefore, temperature of blown air passing through subcooled part decreases in heating operation.

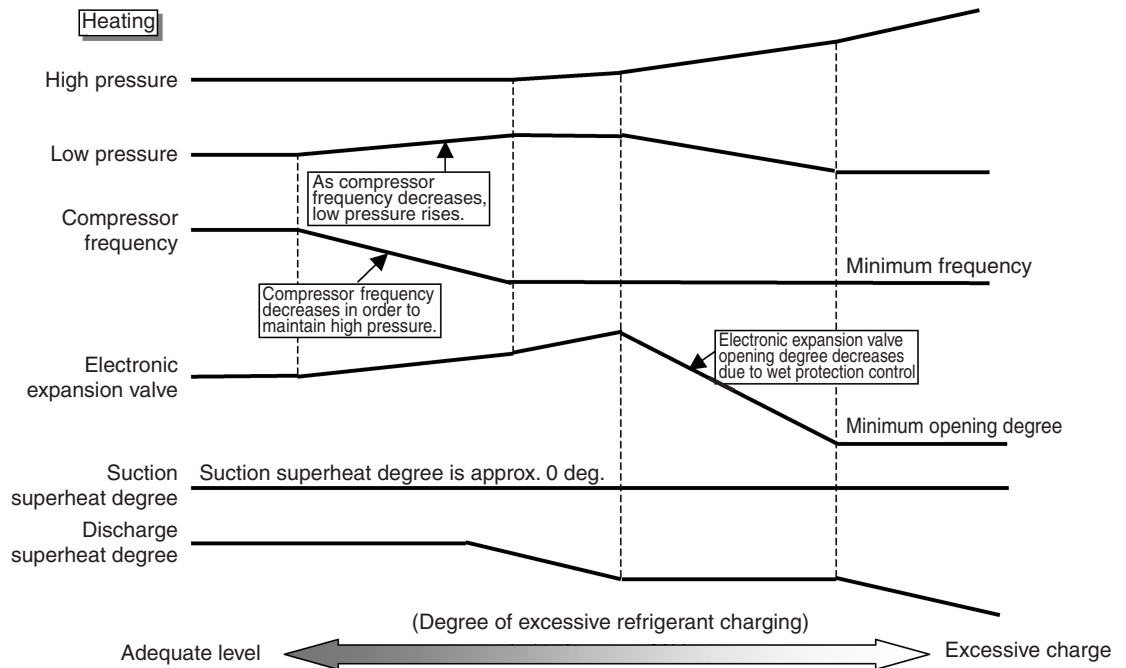
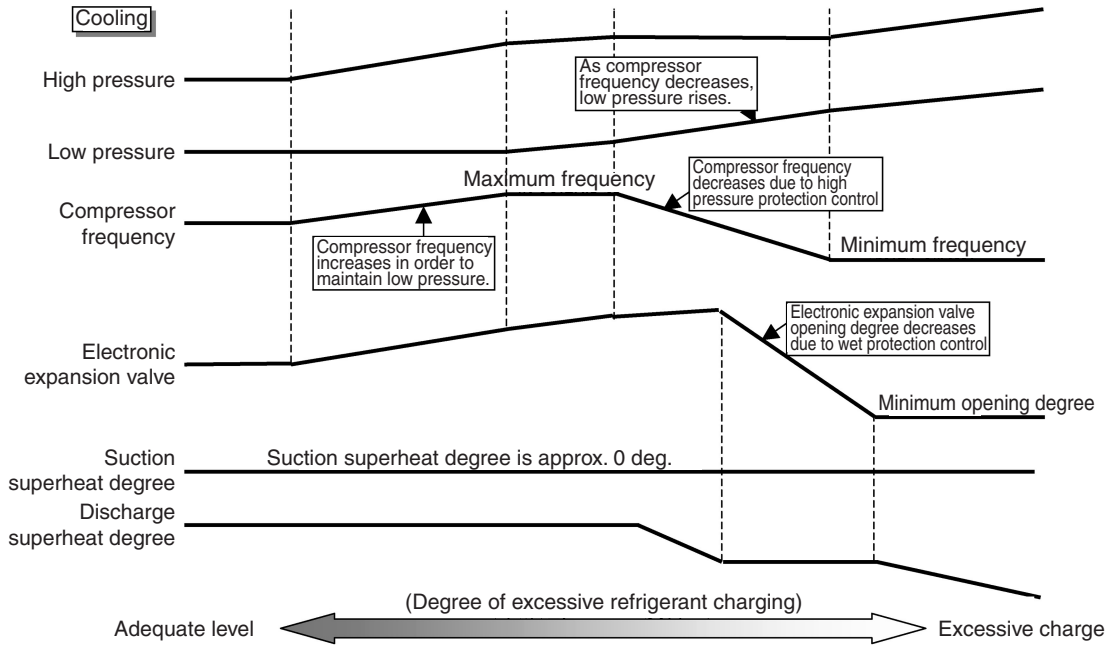

Check No.14 Check for Factors Causing Wet Operation

Referring to the Fault Tree Analysis (FTA) shown below, identify the faulty points.

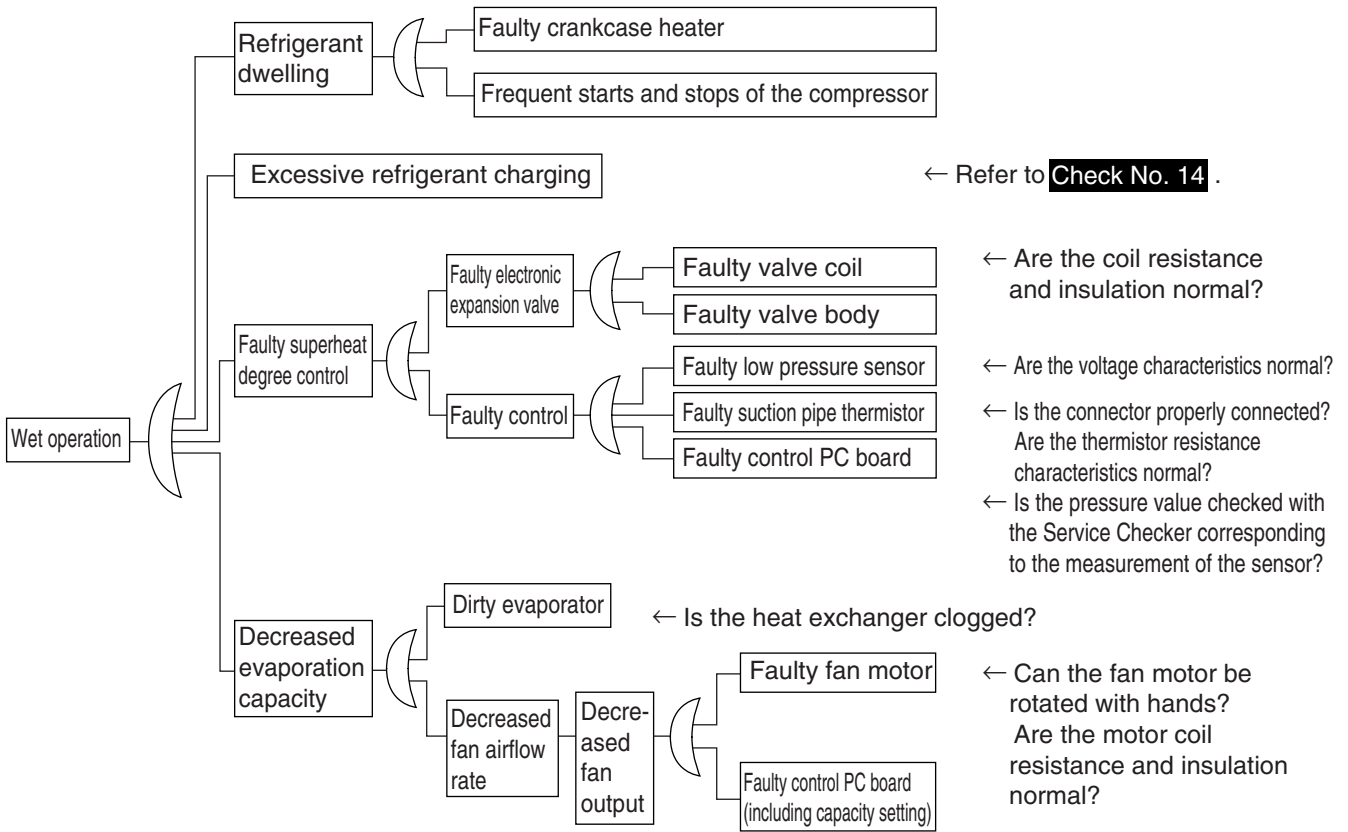

※: Reference values for superheat degree to be used in the judgment of wet operation
 ① Suction pipe superheat degree: 4°C or more ② Discharge pipe superheat degree: 5°C or less
 (The values above must be used only for reference purposes. Even it is operated within the range above, operation may be normal in other conditions.)

Part 7

Appendix

1. Dimensions	232
1.1 RZQ71D7V1B (Single phase)	232
1.2 RZQ100~140D7V1B (Single phase)	233
2. Installation and Service Space (RZQ100~140)	234
2.1 Non Stacked	234
2.2 Stacked	235
2.3 Multiple Rows	235
3. Piping Diagrams	236
3.1 Piping Symbol	236
3.2 Pair System	237
3.3 Triple System	239
3.4 Double Twin System	240
3.5 Pipe Connection Diameters	241
3.6 Re-using Existing Field Piping	242
4. Wiring Diagrams	247
4.1 Outdoor Unit	247
5. Switch Box Layout	248
5.1 RZQ71~140D7V1B (Single phase)	248
6. PCB Layout	249
6.1 RZQ71~140D7V1B (Single phase)	249

1. Dimensions

1.1 RZQ71D7V1B (Single phase)

1.1.1 Outlook and Dimensions

The illustration below shows the outlook and the dimensions of the unit (mm).

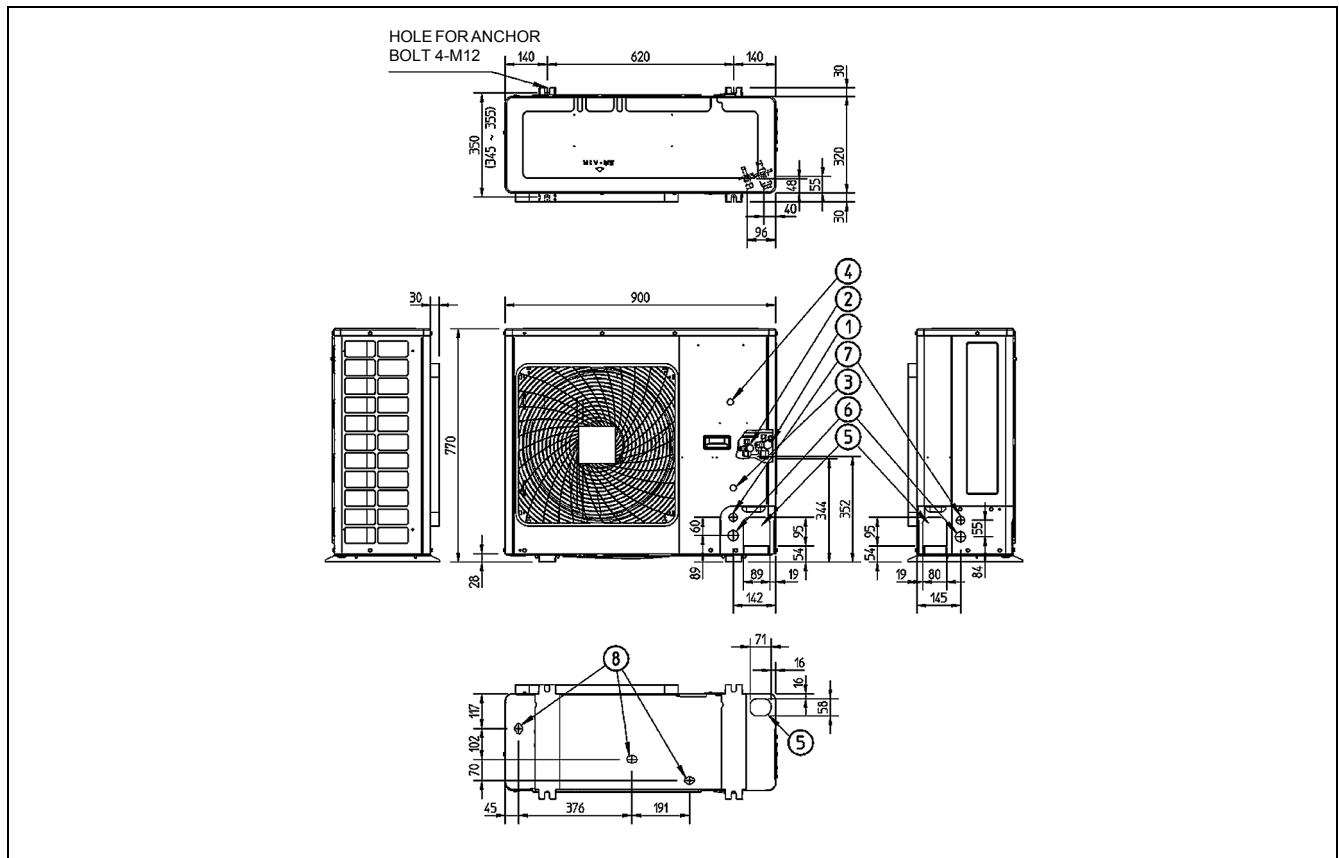

1.1.2 Components

The table below contains the different components of the unit.

No.	Component
1	Gas pipe connection - $\varnothing 15.9$ flare
2	Liquid pipe connection - $\varnothing 9.5$ flare
3	Service port (inside the unit)
4	Grounding terminal M5 (inside the switch box)
5	Refrigerant piping intake
6	Power supply wiring intake (knock out hole $\varnothing 34$)
7	Control wiring intake (knock out hole $\varnothing 27$)
8	Drain outlet

1.2 RZQ100~140D7V1B (Single phase)

1.2.1 Outlook and Dimensions

The illustration below shows the outlook and the dimensions of the unit (mm).

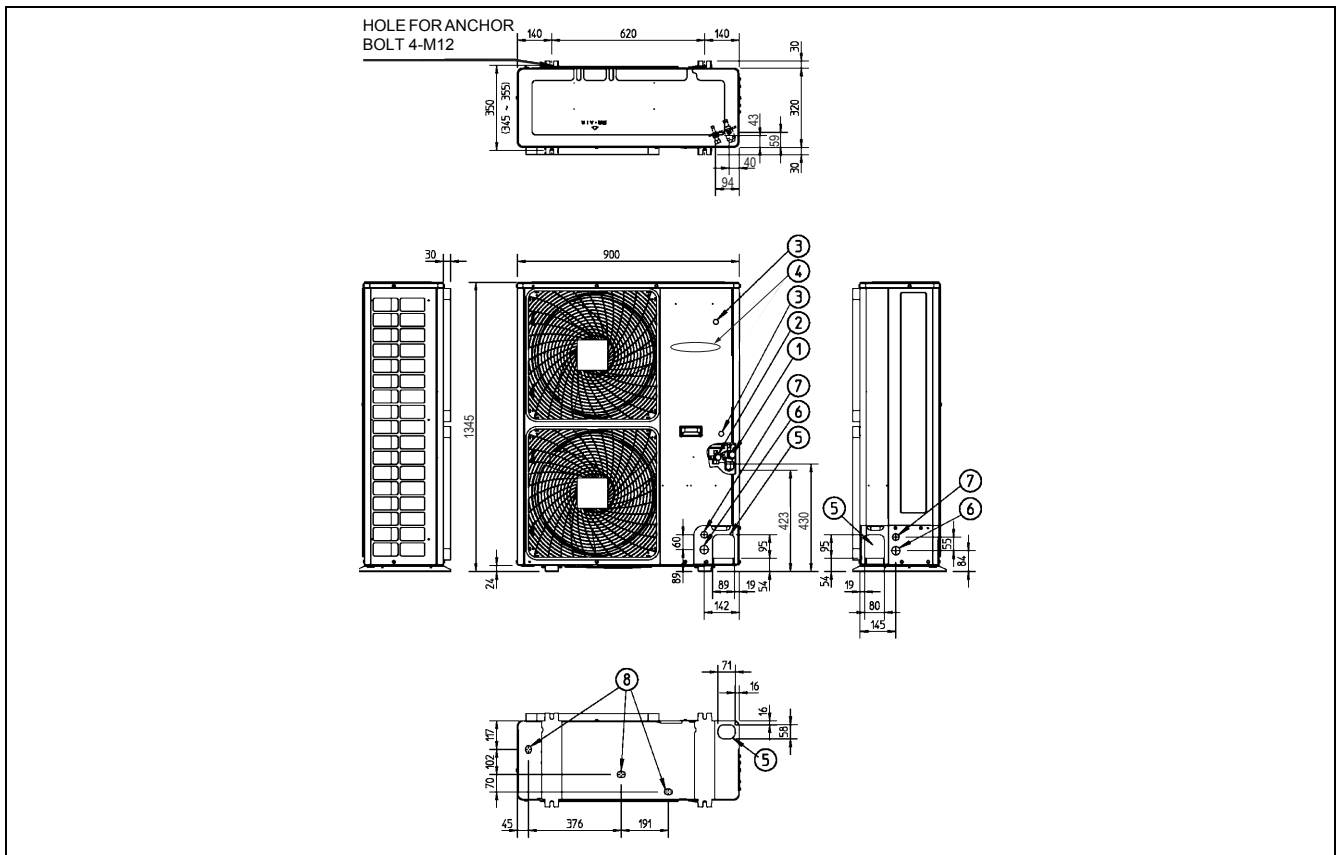

1.2.2 Components

The table below contains the different components of the unit.

No.	Component
1	Gas pipe connection - $\varnothing 15.9$ flare
2	Liquid pipe connection - $\varnothing 9.5$ flare
3	Service port (inside the unit) (2x)
4	Grounding terminal M5 (inside the switch box)
5	Refrigerant piping intake
6	Power supply wiring intake (knock out hole $\varnothing 34$)
7	Control wiring intake (knock out hole $\varnothing 27$)
8	Drain outlet

2. Installation and Service Space (RZQ100~140)

2.1 Non Stacked

The illustrations and table below show the required installation and service space (mm). The values between brackets are for RZQ100~140 class.

	←	→	↶	↷		A	B1	B2	C	D1	D2	E	L1/L2	
	✓						≥50(100)							
	✓		✓	✓		≥100	≥100		≥100					
	✓				✓		≥100				≤500	≥1000		
	✓		✓	✓	✓	≥150	≥150		≥150		≤500	≥1000		
		✓									≥500			
		✓			✓						≤500	≥500	≥1000	
	✓	✓				L1<L2	≥50(100)				≥500			
						L2<L1	≥50(100)				≥500			
		✓	✓				≥200	≥200(300)		≥1000				
		✓		✓	✓		≥200	≥200(300)		≥1000		≤500	≥1000	
		✓									≥1000			
		✓			✓				≤500	≥1000		≥1000		
✓		✓				L1<L2	≥200(300)			≥1000			0<L2≤1/2H	
						L2<L1	≥150(250)			≥1000			1/2H<L2≤H	
							≥200(300)							
		✓	✓				≥200(300)	≤500		≥1000		≥1000	0<L1≤1/2H	
							≥1250						1/2H<L1≤H	
			✓	✓				L1≤H						
							L1<L2	≥150(250)			≥1000	≤500	≥1000	0<L2≤1/2H
					L2<L1	≥200(300)						1/2H<L2≤H		

- ← Suction side obstacle
- Discharge side obstacle
- ↶ Left side obstacle
- ↷ Right side obstacle
- ↘ Top side obstacle
- ✓ Obstacle is present

- 1** In these cases, close the bottom of the installation frame to prevent discharged air from being bypassed
- 2** In these cases, only 2 units can be installed

This situation is not allowed

2.2 Stacked

The illustration below shows the required installation and service space (mm). The values in brackets are for RZQ100~140 class.

- Do not stack more than one unit.
- ± 100 mm is required as the dimension for laying the upper outdoor unit's drain pipe.
- Get the portion A sealed so that air from the outlet does not bypass.

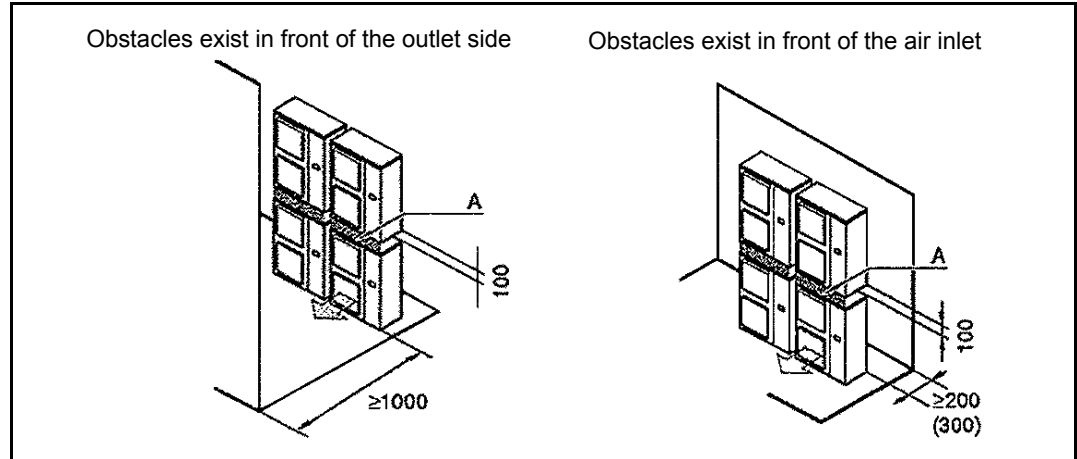

2.3 Multiple Rows

The illustration below shows the required installation and service space (mm). The values in brackets are for the 100~140 class.

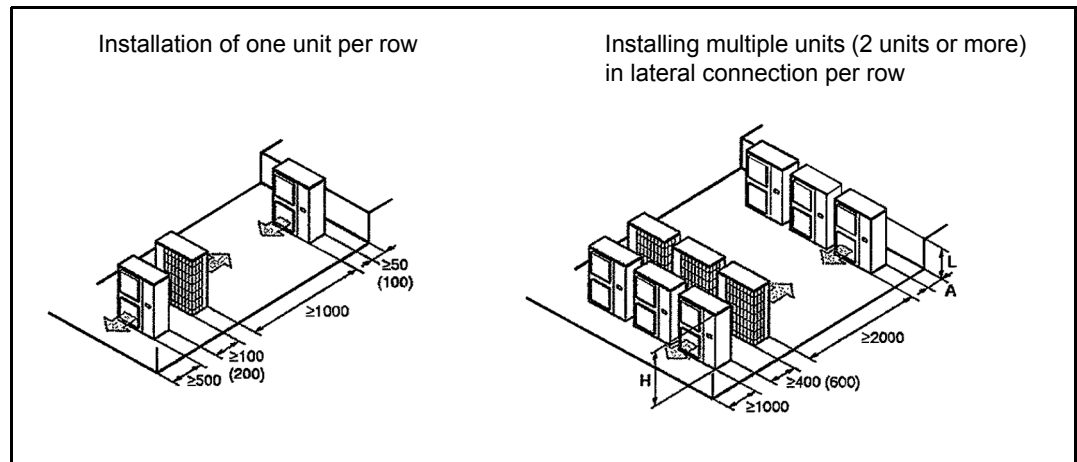

Relation of dimensions of H, A and L are shown in the table below.

	L	A
L ≤ H	0 < L ≤ 1/2H	150 (250)
	1/2H < L	200 (300)
H < L	installation impossible	

3. Piping Diagrams

3.1 Piping Symbol

Components

The table below contains the different components of the piping diagrams.

No.	Component	Function / remark
1	Flare connection	See pipe connection diameter.
2	Liquid stop valve	The liquid stop valve is used as shut-off valve in case of a pump-down.
3	Gas stop valve with service port	The gas stop valve is used as shut-off valve in case of a pump-down.
4	Compressor	The compressor can restart after 3 min from last stop.
5	Capillary tube	The capillary tube allows pressure equalization during a compressor OFF-cycle.
6	Electronic expansion valve	The expansion valve expands the liquid to enable evaporation in the evaporator. The opening degree is controlled to obtain the optimum discharge temperature.
7	Heat exchanger	The heat exchanger is of the multi louvre fin type. Hi-X -tubes and coated waffle louvre fins are used.
8	Filter	The filter is used to collect impurities, which may enter the system during installation and is also used to avoid blockage of the capillaries and other fine mechanical parts of the unit.
9	Liquid receiver	The liquid receiver is used to make sure only completely liquefied refrigerant is sent to the expansion valve. It is also used as a container in which surplus refrigerant is stored.
10	Check valve with service port	The check valve allows you to connect a gauge.
11	Low-pressure sensor	The low pressure sensor is used to control the unit's actuators (expansion valve, frequency,...)
12	High-pressure switch	The high-pressure switch stops the operation of the unit when the pressure becomes abnormally high.
13	Propeller fan and fan motor	The propeller fan creates air displacement across the heat exchanger.
14	One-way valve	The one-way valve is used to force the refrigerant liquid to flow through the receiver and the expansion valve in the same direction both in cooling and heating.
15	4-way valve (reversing solenoid valve)	The 4-way valve is used to select refrigerant flow in cooling or heating mode. When the 4-way valve switches from ON to OFF, a timer starts counting up to 150 as soon as the cooling or defrosting operation is stopped. This delay time is to eliminate the switching sound.
16	Muffler	The muffler is used to absorb the refrigerant noise from the compressor.
17	Solenoid valve	Y1S: Capacity control solenoid valve Y3S: Liquid injection solenoid valve SV: Solenoid valve (Purge liquid receiver)
18	Thermistor	R1T: Air thermistor R2T: Coil thermistor R3T: Discharge pipe thermistor

3.2 Pair System

3.2.1 RZQ71~140D7V1B (Single phase)

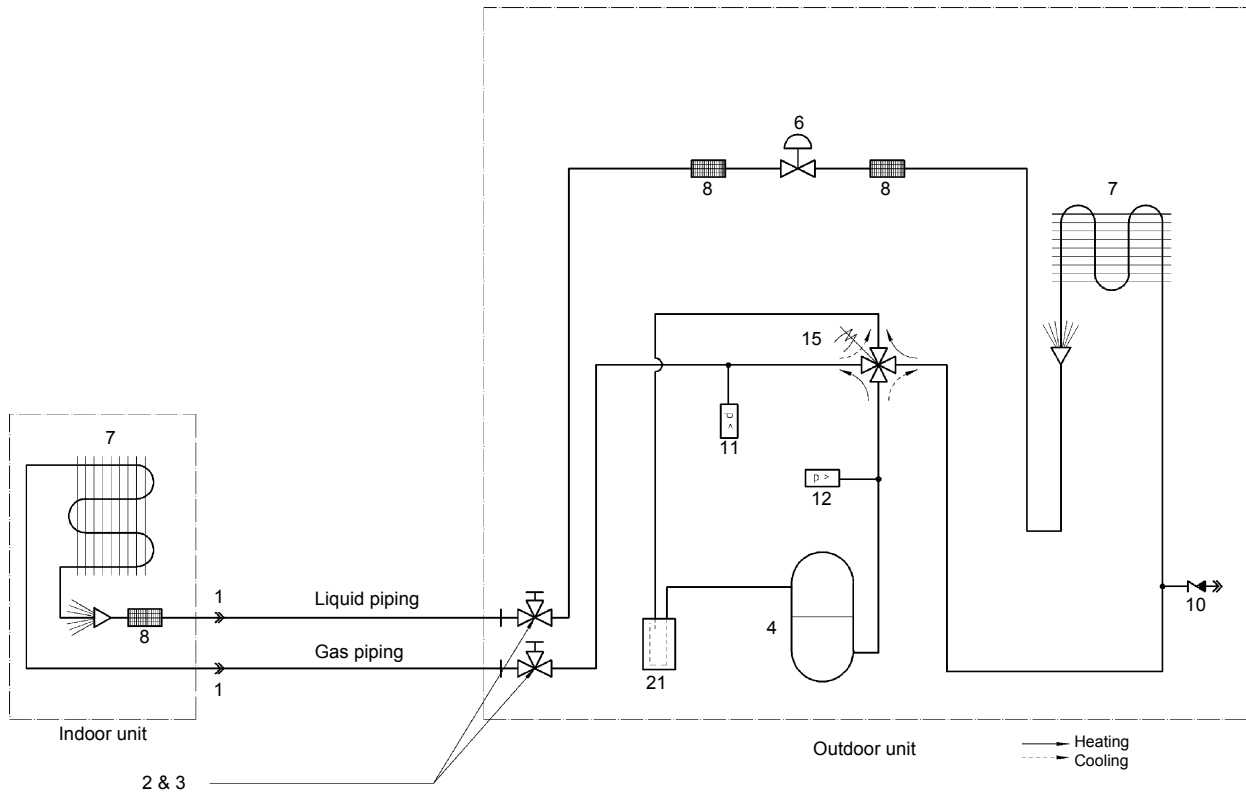

Note: Piping Symbol Number : Refer to P236.

3.2.2 RZQ71~140D7V1B (Single phase)

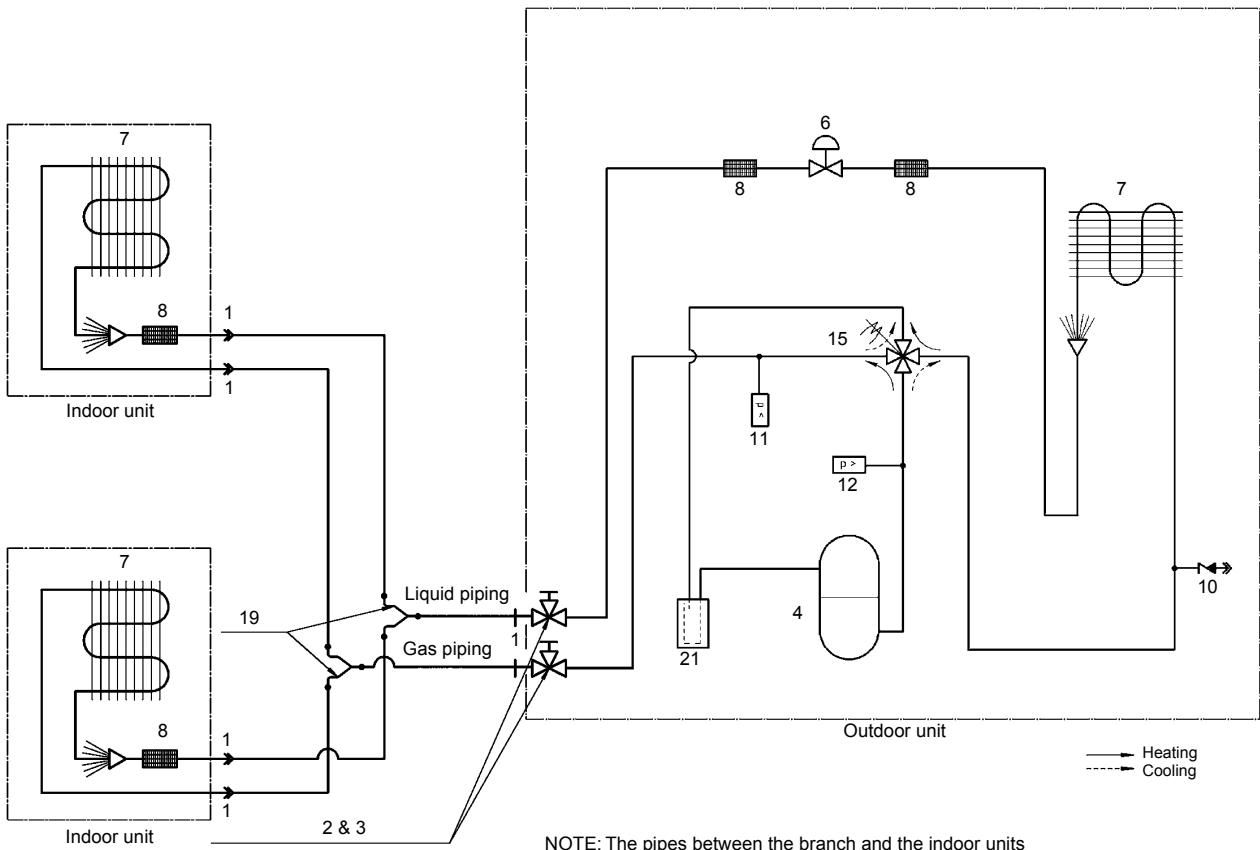

NOTE: The pipes between the branch and the indoor units should have the same size as the indoor connections.

Note: Piping Symbol Number : Refer to P236.

3.3 Triple System

3.3.1 RZQ71~140D7V1B (Single phase)

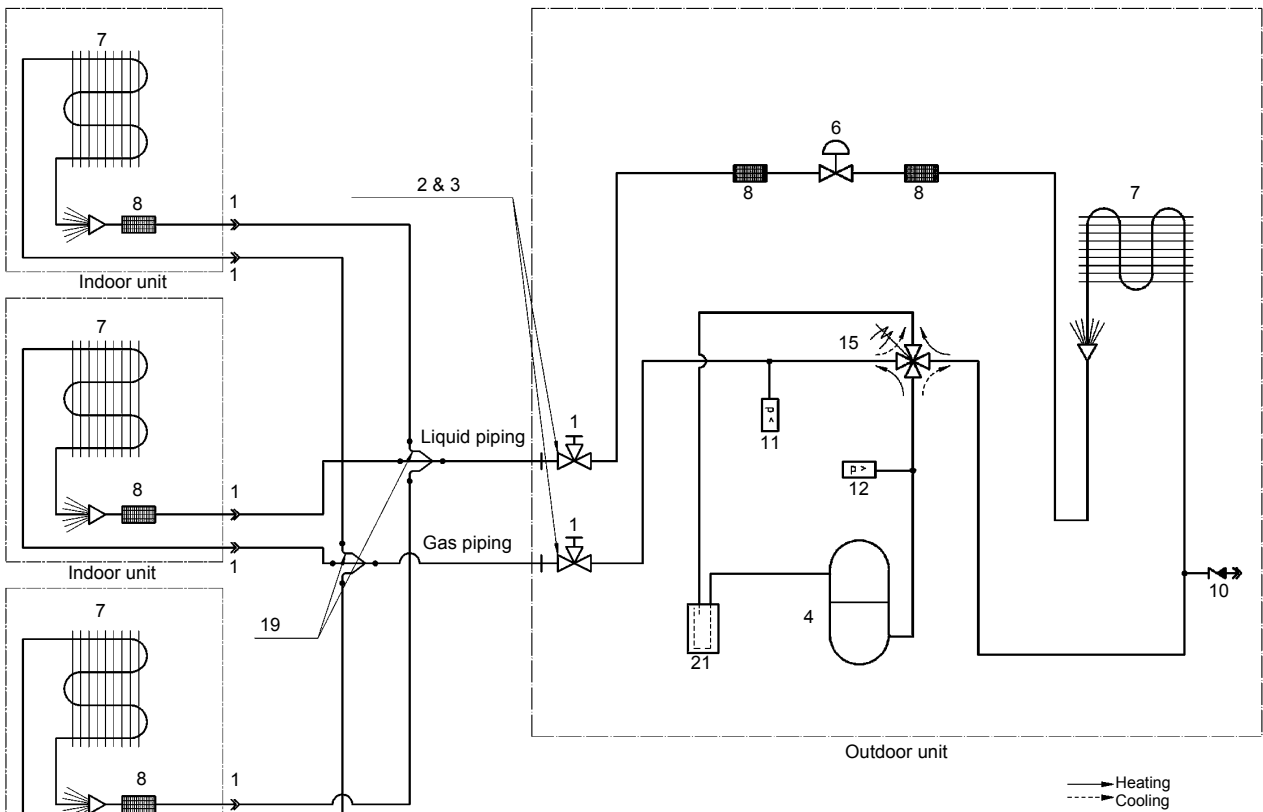

NOTE: The pipes between the branch and the indoor units should have the same size as the indoor connections.

Note: Piping Symbol Number : Refer to P236.

3.4 Double Twin System

3.4.1 RZQ71~140D7V1B (Single phase)

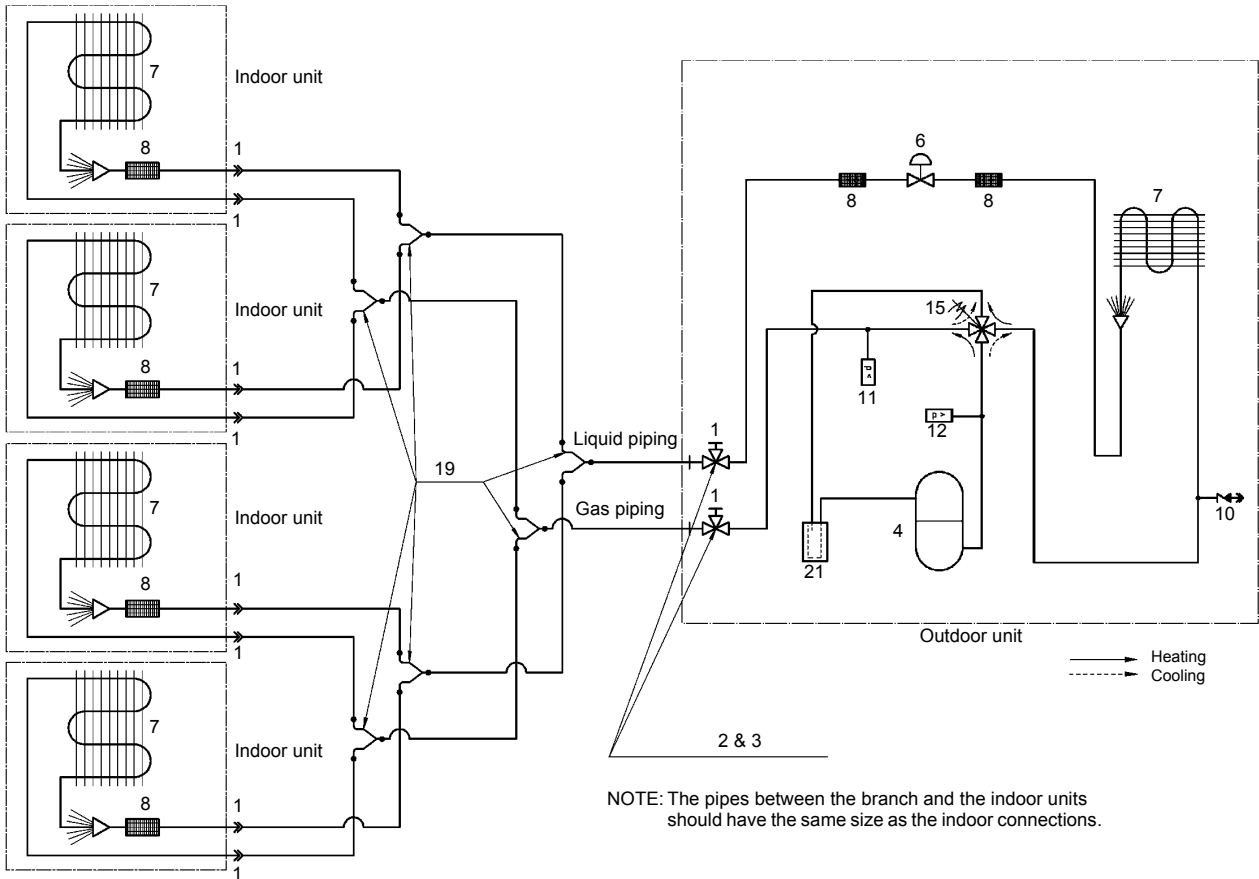

Note: Piping Symbol Number : Refer to P236.

3.5 Pipe Connection Diameters

Outdoor units

The table below contains the refrigerant pipe connection diameters.

Model	φ Gas pipe (flare)	φ Liquid pipe (flare)
RZQ71~140	15.9 mm	9.52 mm

3.6 Re-using Existing Field Piping

3.6.1 Introduction

When installing a system using an RZQ outdoor unit, existing or pre-installed piping can be used according to below specified conditions.

In all circumstances where these conditions can not be fully met, new piping has to be installed.

* RZQS can not be reused.

3.6.2 How to Re-use Existing Piping?

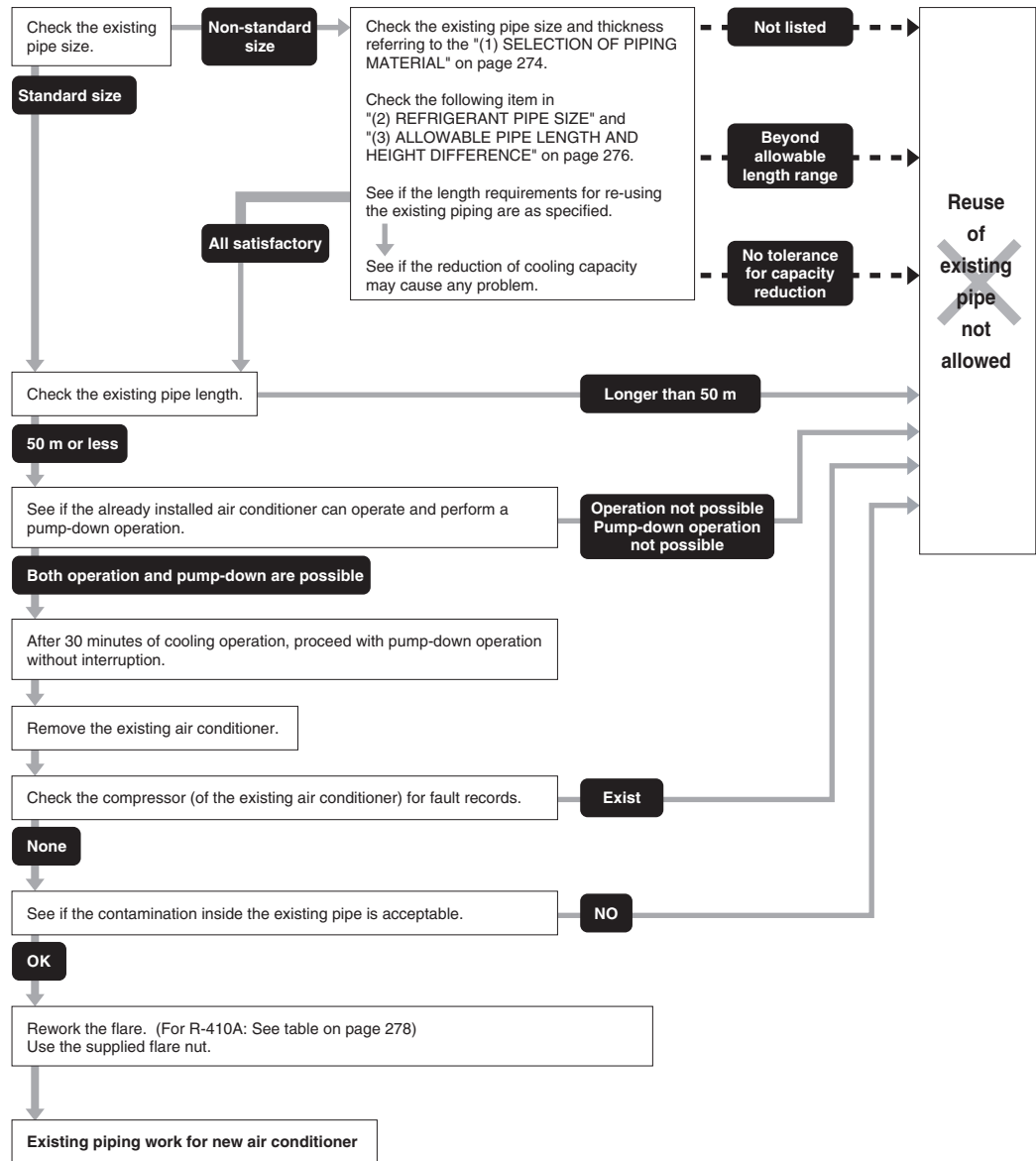

i Notes: Oil contamination can be checked using the Daikin “Oil Checker Card”.

- ! Caution:**
- If copper piping is corroded, existing piping re-use is not allowed.
 - Single side thermal insulation is not allowed for re-use.
 - See further notes in this section for Twin, Triple and Double Twin applications.

3.6.3 Precautions on Refrigerant Piping

- Do not allow anything other than the designated refrigerant to get mixed into the freezing cycle (air, moisture,...). If any refrigerant gas leaks while working on the unit, ventilate the room thoroughly immediately.
- Use R-410A only when adding refrigerant.
- Make sure all installation tools are designed for use on R-410A refrigerant to withstand the pressure.
- Vacuum pump. Use a 2-stage vacuum pump with a non-return valve. Make sure the pump oil does not flow oppositely into the new system while the pump is not working. Use a vacuum pump which can evacuate to -100.7 kPa (5 Torr, -755 mmHg).
- Check welded connections for gas leaks, if the local piping has welded connections.

3.6.4 Notes for Twin, Triple and Double Twin

- Main piping (L1) can be re-used, size up & size down is allowed (see further in this section for restrictions).
- Re-use of branch piping is not allowed.
- Branch piping (L2~L7) can be re-used, but standard pipe size only.

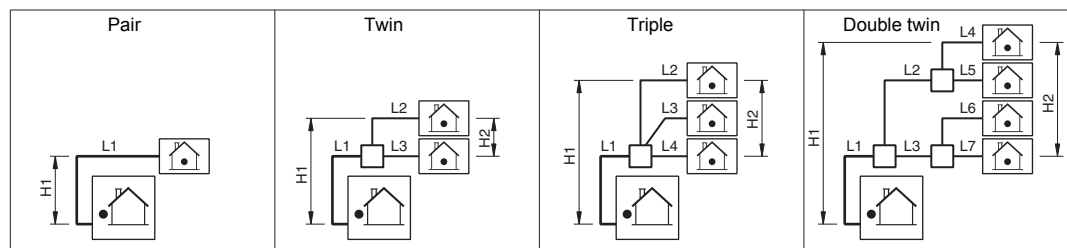

3.6.5 Selection of Piping Material

- Construction material: phosphoric acid deoxidized seamless copper for refrigerant.
- Temper grade: use piping with temper grade in function of the pipe diameter as listed in table below.
- The pipe thickness of the refrigerant piping should comply with relevant local and national regulations. The minimal pipe thickness for R-410A piping must be in accordance with the table below.

Pipe ϕ	Temper grade of piping material	Minimal thickness t(mm)
6.4 / 9.5 / 12.7	O	0.80
15.9	O	1
19.1	1/2H	1

O = Annealed
 1/2H = Half hard

3.6.6 Refrigerant Pipe Size

- Pipe size down and pipe size up is available for main piping (L1) only.

Model	Refrigerant pipe size		
	Gas pipe		
	Size-down	Standard size	Size-up
RZQ71	φ 12.7	φ 15.9	—
RZQ100~140	—		φ 19.1
Model	Liquid pipe		
	Size-down	Standard size	Size-up
RZQ71~140	φ 6.4	φ 9.5	φ 12.7

- Not using the standard pipe size may result in capacity decrease. It is up to the installer to judge on this phenomenon carefully in function of the complete installation.

3.6.7 Allowable Pipe Length and Height Difference

When re-using existing piping, refer to below table for allowable piping length and height difference (figures in brackets are equivalent lengths).

RZQ

	Liquid pipe size	RZQ71	RZQ100	RZQ125 & 140
Maximum allowable piping length (*)				
Pair: L1 Twin and triple: L1 + L2 Double twin: L1 + L2 + L4	size-down	10 m (15 m)		
	standard	50 m (70 m)	50 m (70 m)	50 m (70 m)
	size-up	25 m (35 m)	35 m (45 m)	35 m (45 m)
Maximum total one-way piping length				
Twin: L1 + L2 + L3	—	50 m	50 m	50 m
Triple: L1 + L2 + L3 + L4		—		
Double twin: L1 + L2 + L3 + L4 + L5 + L6 + L7		—		
Maximum branch piping length				
Twin: L2 Double twin: L2 + L4	—	20 m		
Maximum difference between branch lengths				
Twin: L2 - L3	—	10 m	10 m	10 m
Triple: L2 - L4		—		
Double twin: L2 - L3, L4 - L5, L6 - L7, (L2 + L4) - (L3 + L7)		—		
Maximum height between indoor and outdoor				
All: H1	—	30 m		
Maximum height between indoors				
Twin, triple and double twin: H2	—	0.5 m		
Chargeless length				
All: L1 + L2 + L3 + L4 + L5 + L6 + L7	size-down	10 m		
	standard	30 m		
	size-up	15 m		

Caution for flare connections

- Refer to below table for correct flare dimensions and tightening torques. Too high tightening force may cause refrigerant leak because of flare cracking:

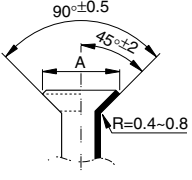
Piping size	Flare nut tightening torque	A dimensions for processing flares (mm)	Flare shape
φ 6.4	14.2~17.2 N·m (144~176 kgf·cm)	8.7~9.1	
φ 9.5	32.7~39.9 N·m (333~407 kgf·cm)	12.8~13.2	
φ 12.7	49.5~60.3 N·m (504~616 kgf·cm)	16.2~16.6	
φ 15.9	61.8~75.4 N·m (630~770 kgf·cm)	19.3~19.7	
φ 19.1	97.2~118.6 N·m (989.8~1208 kgf·cm)	23.6~24.0	

- When connecting the flare nut, apply refrigerating machine oil to the flare (inside and outside) and first screw the nut 3 or 4 turns by hand. Coat the indicated surfaces using ether or ester oil:



- After completing the installation, carry out an inspection of the piping connections by pressure test using nitrogen.

4. Wiring Diagrams

4.1 Outdoor Unit

4.1.1 RZQ71~140D7V1B (Single phase)

The illustration below shows the wiring diagram of the unit.

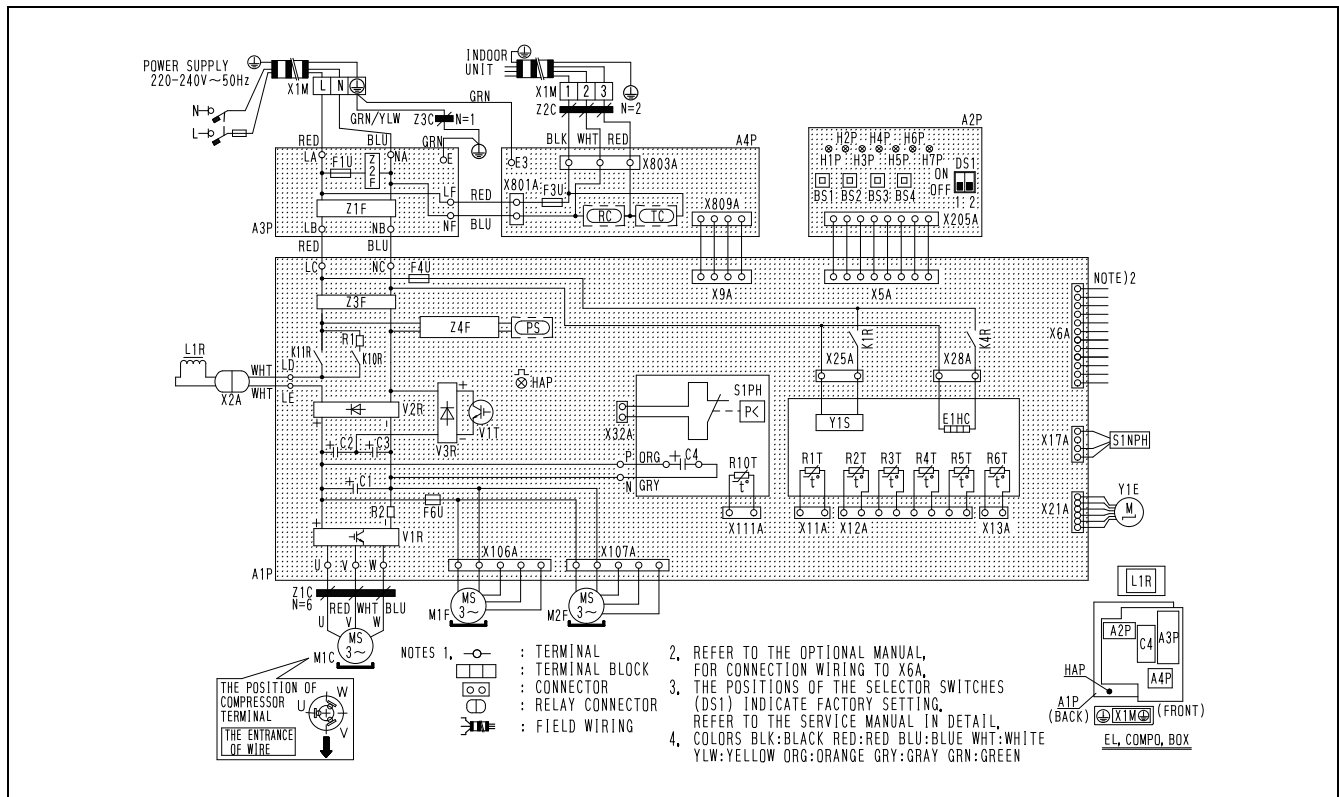

A1P	Printed circuit board	PS	Power supply
A2P	Printed circuit board	R1	Resistor
A3P	Printed circuit board	R2	Resistor
A4P	Printed circuit board	R1T	Thermistor (Air)
BS1~4	Push button switch	R2T	Thermistor (M1C discharge)
C1~4	Capacitor	R3T	Thermistor (Suction)
DS1	Dip switch	R4T	Thermistor (Coil)
E1HC	Crankcase heater	R5T	Thermistor (Coil middle)
F1U, F3U, F4U	Fuse (T 6.3A/250V)	R6T	Thermistor (Liquid)
F6U	Fuse (T 5A/250V)	RC	Signal receiver circuit
H1P~7P (A2P)	Pilot lamp (Service monitor orange)	R10T	Thermistor (Fin)
H1P (A1P)	Flashing lamp (Service monitor green)	S1NPH	Pressure switch (High)
		S1PH	High pressure switch
		TC	Signal transmission circuit
		V1R	Power module
K1R	Magnetic relay (Y1S)	V2R, V3R	Diode module
K4R	Magnetic relay (E1HC)	V1T	IGBT
K10R	Magnetic relay	X1M	Terminal block
K11R	Magnetic relay	Y1E	Electric expansion valve
L1R	Reactor	Y1S	Solenoid valve (4-way valve)
M1C	Motor (compressor)	Z1C~Z3C	Noise filter (Ferrite core)
M1F	Motor (fan) (upper)	Z1F~Z4F	Noise filter
M2F	Motor (fan) (lower)		

5. Switch Box Layout

5.1 RZQ71~140D7V1B (Single phase)

The illustration below shows the switch box layout:

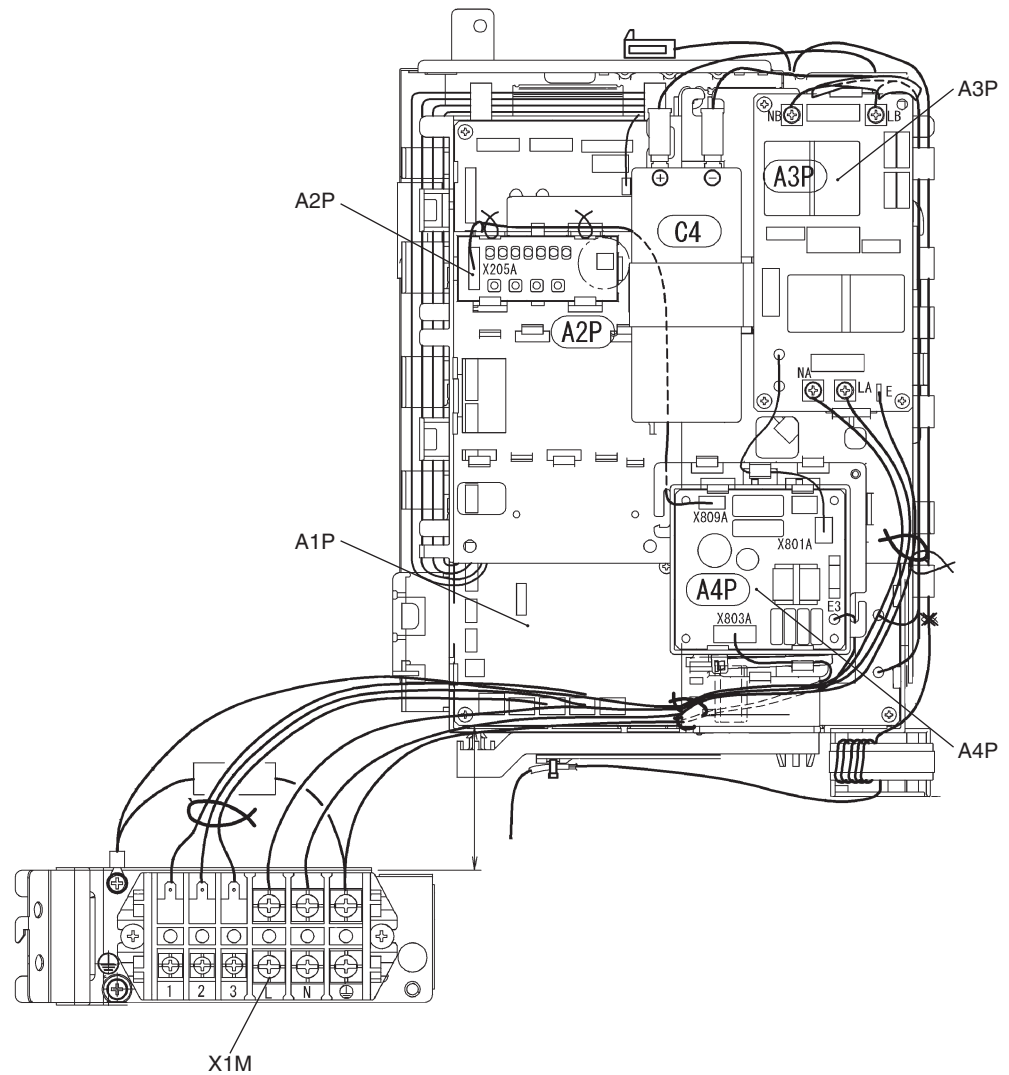

Item	Description
A1P	Printed circuit board (control)
A2P	Printed circuit board (inverter)
A3P	Printed circuit board
A4P	Printed circuit board
X1M	Terminal strip

6. PCB Layout

6.1 RZQ71~140D7V1B (Single phase)

Control & Inverter PC board (A1P)

The illustration below shows the PC board connectors.

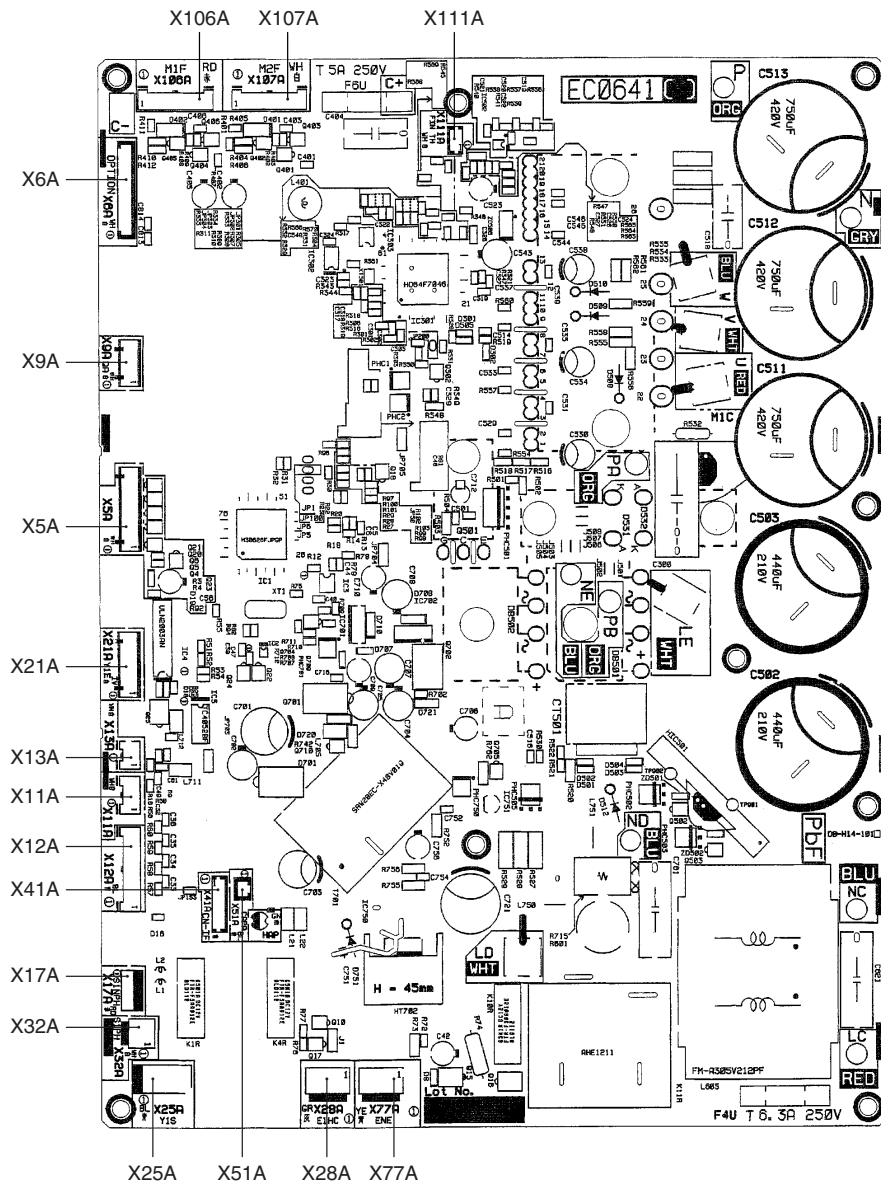

Connectors

The table below describes the PC board connectors.

Connector	Connected to	Description
X5A	X205A (on inverter PC board)	
X6A		For optional PCB KRP58M51
X9A	X809A (on inverter PC board)	
X11A	R1T	Air thermistor
X12A	R2T~R5T	Coil thermistor
X13A	R6T	Discharge pipe thermistor
X17A	S1NPH	Suction pipe thermistor
X21A	Y1E	Expansion valve
X25A	Y1S	4-way valve
X28A	E1HC	Crankcase heater
X31A	S1PL	Low pressure sensor
X32A	S1PH	High pressure switch
X51A		Connector for spare parts adaptor
X77A		For optional PC board KRP58M51
X106A	M1F	Fan motor
X107A	M2F	Fan motor
X111A	R10T	Fin thermistor

Part 8

Removal Procedure

1. RZQ71.....	252
1.1 Removal of Outside Panels.....	252
1.2 Removal of Propeller Fan and Fan Motor	253
2. RZQ100~140	254
2.1 Removal of Outside Panels.....	254
2.2 Removal of Propeller Fan and Fan Motor	255
2.3 Removal of Switch Box	256
2.4 Removal of PC Board.....	257
2.5 Removal of Pressure Sensor, Electronic Expansion Valve, and Others.....	258
2.6 Removal of Thermistor	259
2.7 Removal of Four Way Valve.....	260
2.8 Removal of Compressor.....	261

1. RZQ71

1.1 Removal of Outside Panels

Procedure



Warning

Be sure to commence the disassembling work after 10 minutes or more elapsed from all power supplies have been turned off.

Step	Procedure	Points
1	<p>For the suction grille, pull the lower parts (in 7 places) frontward, disengage the hooks at the top of the grille with a slotted screwdriver, and then push the overall grille downward to disassemble it.</p>	
2	<p>For the front panel (side front panel), unscrew a single mounting screw and then push this panel downward to remove it.</p>	
3	<p>For the top panel, unscrew the eight mounting screws and then remove this panel.</p>	
4	<p>For the front panel of the piping cover, unscrew a single mounting screw and then remove this panel.</p>	
5	<p>For the side panel of the piping cover, unscrew the four mounting screws and then remove this panel.</p>	
6	<p>For the side rear panel, unscrew the (1φ:seven, 3φ:six) mounting screws and then remove this panel.</p>	

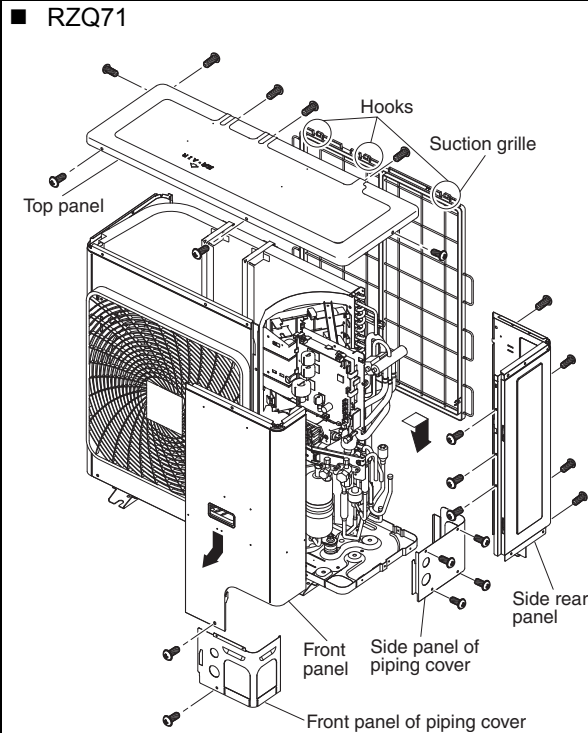

1.2 Removal of Propeller Fan and Fan Motor

Procedure



Warning Be sure to commence the disassembling work after 10 minutes or more elapsed from all power supplies have been turned off.

Step	Procedure	Points
<p>■ Remove the front and top panels in accordance with the Removal Procedure for Outside Panels.</p>		
<p>1. Remove the propeller fan</p>		
<p>1 Unscrew the four screws that fix the air discharge grille and disengage the four hooks at the top and bottom of the grille, and then remove this air discharge grille.</p> <p>2 Unfasten the fan lock nut that fixes the propeller fan.</p>		
<p>2. Remove the fan motor</p>		
<p>1 Remove the connector for the fan motor from the PC board. One phase models: X206A Three phase models: X206A, X207A</p> <p>2 The lead wire is clamped in three places. (Click on partition plate×3 places)</p> <p>3 Unscrew the three screws that fix the front panel and then pull up the lead wire.</p> <p>4 Unfastening the four lock bolts from the fan motor enables the removal of this fan motor.</p>		<p>■ In order to disconnect the connector, do not pull the lead wire. Hold the connector part and then push the hooks.</p> <p>■ Cautions in mounting the motor Be sure to fix the motor lead wire with a clamp. Not heeding this caution will cause the entanglement of the lead wire around the fan, which will result in damage to the fan.</p>

2. RZQ100~140

2.1 Removal of Outside Panels

Procedure



Warning

Be sure to commence the disassembling work after 10 minutes or more elapsed from all power supplies have been turned off.

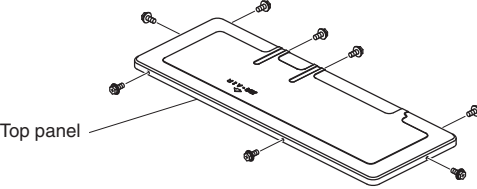
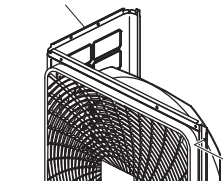
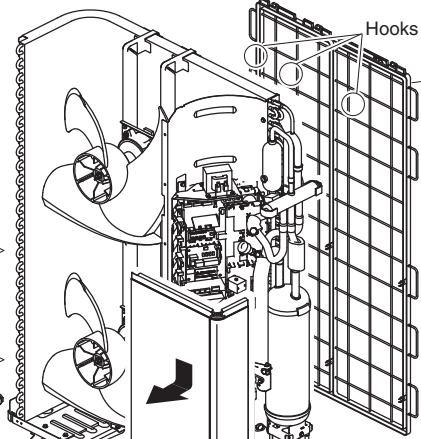
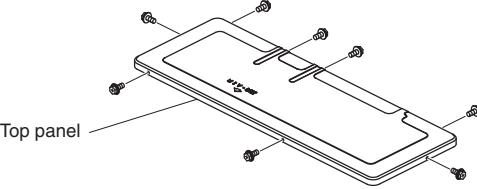
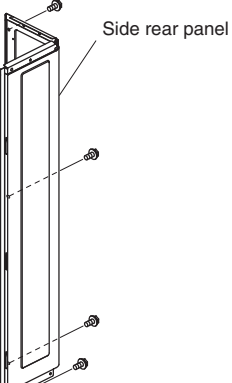
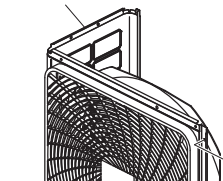
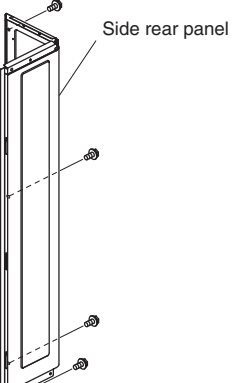
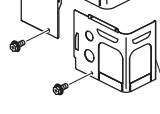
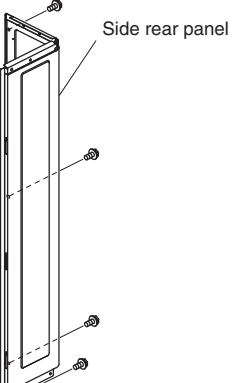
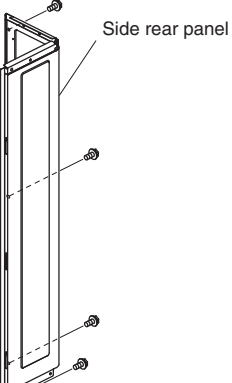
Step	Procedure	Procedure	Points
1	For the suction grille, pull the lower parts (in 7 places) frontward, disengage the hooks at the top of the grille with a slotted screwdriver, and then push the overall grille downward to disassemble it.	 <p>Top panel</p>	
2	For the front panel (1), unscrew a single mounting screw and then push this panel downward to remove it.	 <p>Front panel (1)</p>	 <p>Hooks</p> <p>Suction grille</p>
3	For the top panel, unscrew the eight mounting screws and then remove this panel.	 <p>Top panel</p>	 <p>Side rear panel</p>
4	For the front panel (1), unscrews the seven mounting screws and the remove this panel.	 <p>Front panel (1)</p>	 <p>Side piping cover</p>
5	For the front piping cover, unscrew a single mounting screw and then remove this panel.	 <p>Front piping cover</p>	
6	For the side piping cover, unscrew the four mounting screws and then remove this panel.	 <p>Side piping cover</p>	
7	For the side rear panel, unscrew the five mounting screws and then remove this panel.	 <p>Side rear panel</p>	

2.2 Removal of Propeller Fan and Fan Motor

Procedure



Warning Be sure to commence the disassembling work after 10 minutes or more elapsed from all power supplies have been turned off.

Step	Procedure	Points
<p>■ Remove the front panel (2) accordance with the Removal Procedure for Outside Panels.</p>		
<p>1. Remove the propeller fan</p>	<p>1 Unscrew the four screws that fix the air discharge grille and disengage the four hooks at the top and bottom of the grille, and then remove this air discharge grille.</p> <p>2 Unfasten the fan lock nut that fixes the propeller fan.</p>	
<p>2. Remove the fan motor</p>	<p>■ Remove the front panel (1) accordance with the Removal Procedure for Outside Panels.</p>	
<p>1</p>	<p>Remove the connector (X206A, X207A) for fan motor from the PC board.</p>	<p>■ In order to disconnect the connector, do not pull the lead wire. Hold the connector part and then push the hooks.</p>
<p>2</p>	<p>Cut the cable tie of lead wires (located on the reverse side of the stop valve mounting plate).</p>	
<p>3</p>	<p>Pull out the lead wires through the opening of the partition panel, and then unclamp the three clamps. (Note that the partition plate has three hooks.)</p>	
<p>4</p>	<p>Unfastening the four lock from the fan motor, enables the removal of this motor.</p>	<p>■ Cautions in mounting the motor Be sure to fix the motor lead wire with a clamp. Not heeding this caution will cause the entanglement of the lead wire around the fan, which will result in damage to the fan.</p>
<p>1</p>	<p>Remove the connector (X206A, X207A) for fan motor from the PC board.</p>	
<p>2</p>	<p>Cut the cable tie of lead wires (located on the reverse side of the stop valve mounting plate).</p>	
<p>3</p>	<p>Pull out the lead wires through the opening of the partition panel, and then unclamp the three clamps. (Note that the partition plate has three hooks.)</p>	
<p>4</p>	<p>Unfastening the four lock from the fan motor, enables the removal of this motor.</p>	

2.3 Removal of Switch Box

Procedure



Warning

Be sure to commence the disassembling work after 10 minutes or more elapsed from all power supplies have been turned off.

Step	Procedure	Points
<p>■ Remove the front panel (2) accordance with the Removal Procedure for Outside Panels.</p>		<p>■ If the top panel cannot be removed</p> <p style="text-align: center;">↓</p> <p>Even though workability is degraded, it is possible to pull the switch box to the front panel without removing the top panel.</p>
<p>1 Disconnect each connector on the PC board. (Refer to the Points column.)</p>		<p>■ The figure below shows connectors to be disconnected.</p>
<p>2 Remove the two Faston terminals. After that, unscrew the three screws that fix the reactor, and then remove the reactor.</p>		
<p>3 Cut the clamp.</p>		
<p>4 Remove the clamp of the pressure sensor lead wire.</p>		
<p>5 Cut the clamp of the outdoor air temperature thermistor.</p>		
<p>6 Disconnect a set of lead wires together from the clamp.</p>		
<p>7 Remove the terminal cover, and then disconnect the three lead wires from the terminal block for the compressor.</p>		
<p>8 Unscrew the two screws that fix the terminal block.</p>		<p>■ Precaution for mounting the pressure sensor</p> <p style="text-align: center;">↓</p>
<p>9 Disengage the three hooks, and then pull out the switch box upward.</p>		<p>To prevent the lead wire from hanging over the PC board, hook the lead wire of 160 to 170 mm in length from the front end of the connector on the clamp.</p>

2.4 Removal of PC Board

Procedure



Warning

Be sure to commence the disassembling work after 10 minutes or more elapsed from all power supplies have been turned off.

Step	Procedure	Points	
<p>■ Remove the top panel and the front panel (2) accordance with the Removal Procedure for Outside Panels.</p>			
<p>1. Remove the PC board (A2P)</p>			
<p>1 Disconnect the connector (X205A) from the PC board.</p> <p>2 While pressing the two hooks, remove the PC board (A2P).</p>			
<p>2. Remove the PC board (A1P)</p>			
<p>■ Remove the switch box accordance with the Removal procedure for the switch box.</p>			
<p>1 Remove the clamp from the compressor harness.</p>			
<p>2 Press the hooks to remove the terminal block.</p>			
<p>3 Cut the two clamps (A).</p>			
<p>4 Extend the hooks, and then remove the support leg of the cover of electrical components.</p>			
<p>5 Disengage the three hooks on the left side, and then while pushing down the two hooks on the right side, remove the whole cover of the electric components.</p>			
<p>6 Cut the clamps (B).</p>			
<p>7 Disconnect the connector listed in point column.</p>			
<p>8 Remove the PC board (A1P) together with the radiating fin.</p>			<p>■ Connectors used on the PC board</p> <ul style="list-style-type: none"> · Compressor (X102A) · Ground cable (E1) · Reactors (P1 and P2) · Power supply cable (X1A) · Indoor-Outdoor connection cable (X803A)

2.5 Removal of Pressure Sensor, Electronic Expansion Valve, and Others

Procedure



Warning

Be sure to commence the disassembling work after 10 minutes or more elapsed from all power supplies have been turned off.

Step	Procedure	Points
<p>■ Remove the top panel and the front panel (2) accordance with the Removal Procedure for Outside Panels.</p>		<p>■ Before removing the solenoid valve or the electronic expansion valve, be sure to recover the refrigerant.</p> <p>■ Precaution for mounting the coil for the electronic expansion valve</p> <p style="text-align: center;">↓</p> <p>Align the dimple of the electronic expansion valve and the stopper of the coil for the electronic expansion valve, and then push them in until you hear them click.</p> <div style="text-align: center;"> <p>Stopper</p> <p>↓</p> <p>Dimple</p> </div>
<p>1. Remove the pressure sensor</p>		
<p>1 Disconnect the pressure sensor connector (X17A).</p> <p>2 Use two spanners to remove the pressure sensor.</p>		
<p>2. Remove the solenoid valve</p>		
<p>1 Disconnect the solenoid valve connector (X26A or X27A).</p> <p>2 Unscrew the one screw that fixes the coil for the solenoid valve, and then remove the coil.</p> <p>3 Remove brazing from the two places, and then remove the solenoid valve.</p>		
<p>3. Remove the electronic expansion valve.</p>		
<p>1 Disconnect the electronic expansion valve connector (X21A).</p> <p>2 Pull out the coil for the electronic expansion valve coil upward.</p> <p>3 Remove brazing from the two places, and then remove the electronic expansion valve.</p>		

2.6 Removal of Thermistor

Procedure



Warning Be sure to commence the disassembling work after 10 minutes or more elapsed from all power supplies have been turned off.

Step	Procedure	Points
<p>■ Remove the top panel and the front panel (2) and side panel accordance with the Procedure for Outside Panels.</p>	<p>Thermistor</p> <p>Discharge pipe thermistor (R2T)</p>	
<p>1 Pull out the outdoor air temperature thermistor to the front, and then slide this thermistor to the right to remove it.</p>	<p>Thermistor</p> <p>Outdoor air thermistor (R1T)</p>	
<p>2 Pinch the mounting spring that fixes the discharge pipe thermistor to pull out this thermistor.</p>	<p>Mounting spring thermistor</p> <p>Suction pipe thermistor (R3T)</p>	
<p>3 Press the fixing section of the suction pipe thermistor to pull out this thermistor.</p>	<p>Thermistor</p> <p>Intermediate heat exchanger thermistor (R5T)</p>	
<p>4 Pull the fixing bracket of the heat exchanger's distribution pipe thermistor to the front, and then remove this thermistor.</p>	<p>Mounting spring</p> <p>Thermistor</p> <p>Liquid pipe thermistor (R6T)</p>	
<p>5 Press the fixing section of the heat exchanger's intermediate temperature thermistor to pull out this thermistor.</p>	<p>Heat exchanger distribution pipe thermistor (R4T)</p>	
<p>6 Press the fixing section of the liquid pipe thermistor to pull out this thermistor.</p>	<p>※ 1 The heat exchanger's distribution pipe thermistor, heat exchanger's intermediate temperature thermistor, and liquid pipe thermistor are jointed together with a single connector. Consequently, these three thermistors should be replaced at the same time.</p>	

2.7 Removal of Four Way Valve

Procedure



Warning Be sure to commence the disassembling work after 10 minutes or more elapsed from all power supplies have been turned off.

Step	Procedure	Points
<ul style="list-style-type: none"> ■ Recover the refrigerant. ■ According to the procedure for the removal related to the outside panel, remove the front panel (2) and the side panel. ■ According to the procedure for the removal of switch box, remove the switch box. 		<ul style="list-style-type: none"> ■ Be sure to remove the four way valve only after the refrigerant is completely recovered.
<p>1 Unscrew the one screw that fixes the coil for the four way valve, and then remove this coil.</p> <p>2 Remove brazing from the four places, and then remove the four way valve. (Refer to point column.)</p>		<ul style="list-style-type: none"> ■ To prevent the four way valve from exceeding a temperature of 120°C, conduct brazing work while cooling the valve with wet cloths or else.

2.8 Removal of Compressor

Procedure



Warning Be sure to commence the disassembling work after 10 minutes or more elapsed from all power supplies have been turned off.

Step	Procedure	Points
<ul style="list-style-type: none"> ■ Recover the refrigerant. (Refer to point column.) ■ Remove the front panel (2) and the front piping cover bracket. 		<ul style="list-style-type: none"> ■ Be sure to remove the compressor only after the refrigerant is completely recovered.
<p>1 Unscrew the five screws that fix the stop valve mounting plate, and then remove this mounting plate.</p>		<ul style="list-style-type: none"> ■ Terminal block
<p>2 Remove the gas piping and the liquid piping.</p>		
<p>3 Remove the compressor terminal cover.</p>		
<p>4 Disconnect the lead wires from the terminal block.</p>		
<p>5 Loosen the two strings, and then pull out the sound insulation of the compressor.</p>		<ul style="list-style-type: none"> ■ One out of the nuts that fix the compressor is located outside of the partition panel.
<p>6 Unfasten to remove the three nuts that fix the compressor. (Refer to point column.)</p>		
<p>7 Cut the suction pipe and the discharge pipe using a pipe cutter. (Refer to point column.)</p>		<ul style="list-style-type: none"> ■ Be sure to cut thee pipes by using a pipe cutter before disconnecting the brazed sections of pipes. A sudden disconnection of the brazed sections can cause oil to catch fire.
<p>8 Remove brazing from the three places.</p>		
<p>9 Lift to pull out the compressor.</p>		

Index

Numerics

4-way Valve Control38

A

A1153
 A3154
 A6156
 A7158
 Abnormal High Pressure (Detected by the HPS) .169
 Abnormal Power Supply Voltage204
 Actuation of Low Pressure Sensor
 Single phase C Series171
 AF160
 After Unit Shuts Down, It cannot be Restarted
 for a While125
 AJ162
 Automatic Restart33

C

CC167
 Centralized Address Setting Error214
 Check
 Check for Excessive Refrigerant Charging ...228
 Check for Factors Causing Wet Operation ...229
 Check for Inadequate Refrigerant226
 Checking the Thermistors217
 Clogged Points222
 Evaluation of Abnormal High Pressure220
 Evaluation of Abnormal Low Pressure221
 Outdoor Unit: Check for Power Transistor225
 Outdoor Unit: Checking the Expansion Valve 216
 Outdoor Unit: Checking the Installation
 Condition215
 Outdoor Unit: Fan Motor Signal Line223
 Outdoor Unit: Fan Speed Pulse224
 Resistance Conversion Table
 (Ambient, Coil, Fin)218
 Resistance Conversion Table (Discharge
 Pipe Sensor)219
 CJ166
 Combination Matrix3
 Combination Overview2
 Compressor Motor Lock173
 Condensation Avoidance Control47
 Cooling/Heating Operation Starts but Stops
 Immediately123
 Crankcase Heater Control44

D

DC Output Overcurrent (Instantaneous)191
 Defrost Operation40
 Defrost Start Setting110
 Discharge Pipe Temperature Control62
 Discharge Pipe Temperature Protection Control ...73
 Draft Avoidance Control 148

Draft Avoidance Control 2 49
 Drain Pump Control 46

E

E1 168
 E3 169
 E4 171
 E5 173
 E7 175
 E9 178
 Electronic Thermal (Time Lag) 193
 Equipment Discharges Dust 134
 Equipment Discharges White Mist 131
 Equipment does not Operate 119
 Equipment Operates but does not Provide
 Cooling 127
 Equipment Operates but does not Provide
 Heating 129
 Equipment Produces Loud Noise or Shakes 132
 Existence of DIP Switch and BS Button 95
 Expansion Valve Control at Startup 71

F

F3 181
 Factory Settings on the Indoor Units 87
 Failure of Capacity Setting 201
 Failure of Outdoor Unit PC Board 168
 Fan and Flap Operation 50
 Fault-diagnosis by Wired Remote Controller 139
 Fault-diagnosis by Wireless Remote Controller .. 140
 Faulty Outdoor PC Board 187
 Field Setting Levels 91
 Field Settings on the Indoor Units 86
 Field Settings on the Outdoor Units 94
 Field Settings with the Wired Remote Controller ... 81
 Field Settings with the Wireless Remote
 Controller 85
 Forced Operating Mode (Emergency Operation) .. 28
 Forced Thermostat OFF 36
 Freeze Prevention Function 42
 Functions of Thermistors 27

G

Gas Shortage (Malfunction) 202
 General Expansion Valve Control 72
 General Frequency Control 57

H

H3 183
 H9, J3, J5, J6, J7, J8 184
 High Pressure Protection Control 61
 Humidity Sensor System Malfunction 167

I

I-Demand Function 103

Indoor Fan Operates, but Compressor does not ..	121		
Indoor Safety Devices	152	P	
Indoor Unit Fan Control	51	P1	199
Indoor Unit Fan Motor Lock	156	P4	200
Inverter Cooling Fin Temperature Control	66	PJ	201
Inverter Current Protection Control	64	PMV Control	43
		Pressure Difference Control	67
J		Procedure of Self-Diagnosis by Remote Controller	138
J1	185	Protection Control by Overall Current	65
		Pump Down Operation	39
L			
L1	187	Q	
L4	189	Quiet (Low Noise) Operation	101
L5	191	Quiet (Low Noise) Operation by Automatic Control	101
L8	193		
L9	195	R	
LC	197	Radiation Fin Temperature Increased	189
Low Pressure Protection Control	59	Remote Controller LCD Displays "88"	135
		Remote Controller Service Mode	22
M		Restart Standby	32
MAIN/SUB Setting when Using Two Remote Controllers	88	S	
Maintenance Mode Setting	19	Safety Cautions	vi
Malfunction of Drain Water Level System	154	Setting for Low Humidity Application	105
Malfunction of Electronic Expansion Valve	178	Setting the Centralized Group No.	89
Malfunction of Outdoor Unit Fan Motor	175	Setting the Wireless Remote Controller	77
Malfunction of Pressure Sensor	185	Simulated Operation Function	31
Malfunction of Radiator Fin Temperature Thermistor	200	Specifications	
Malfunction of Thermistor System	184	RZQ71D7, 100D7, 125D7 and 140D7 (Single phase)	6
Malfunction of Transmission between Indoor and Outdoor Unit	206	Stall Prevention (Time Lag)	195
Malfunction of Transmission between Indoor and Outdoor Unit / Piping and Wiring Mismatch / Gas Shortage	209	Starting Control	56
Malfunction of Transmission between Indoor Unit and Remote Controller	210	Starting Frequency Control	55
Malfunction of Transmission between MAIN Remote Controller and SUB Remote Controller	211	Suction Pipe Superheat Protection Control (Heating Mode)	63
Malfunction of Transmission System (between Control and Inverter PC Board)	197	Swing Flap does not Operate	136
Malfunctioning Capacity Setting	162	Swing Flap Motor Malfunction / Lock	158
Malfunctioning Drain System	160		
Malfunctioning Field Setting Switch	212	T	
Malfunctioning HPS System	183	Test Run Checks	76
Malfunctioning in Discharge Pipe Temperature ...	181	Test Run Control	37
Malfunctioning Indoor PC Board	153	The INSPECTION / TEST Button	18
Malfunctioning Remote Controller Air Thermistor	166	Thermistor Abnormality	164
Method of Operating Remote Controller	18	Thermostat Control	45
		Troubleshooting Based on Equipment Condition	118
O		Troubleshooting by LED Indications	146
Oil Recovery Operation	70	Troubleshooting by Remote Controller Display / LED Display	148
Open Phase or Power Supply Voltage Imbalance	199		
Operation Range	114	U	
Outdoor Safety Devices	151	U0	202
Outdoor Unit Fan Speed Control	74	U2	204
Outdoor Unit Identification Function	30	U4 or UF	206
		U5	210
		U8	211
		UA	212
		UC	214
		UF	209
		Using Conditions for Remote Controller Thermostat	34

W

Wired Remote Controller12
Wireless Remote Controller16

Drawings & Flow Charts

A	Abnormal High Pressure (Detected by the HPS) .169	Non Stacked 234
	Abnormal Power Supply Voltage204	Stacked 235
	Actuation of Low Pressure Sensor	L
	Single phase C Series171	Locating the thermistors
	After Unit Shuts Down, It cannot be Restarted	RZQ71~140D7V1B (Single phase) 27
	for a While125	M
C	Centralized Address Setting Error214	Malfunction of Drain Water Level System 154
	Centralized Control Group No. Setting90	Malfunction of Electronic Expansion Valve 178
	BRC1E Type90	Malfunction of Outdoor Unit Fan Motor 175
	Compressor Motor Lock173	Malfunction of Pressure Sensor 185
	Cooling/Heating Operation Starts but Stops	Malfunction of Radiator Fin Temperature
	Immediately123	Thermistor 200
D	DC Output Overcurrent (Instantaneous)191	Malfunction of Thermistor System 184
	Dimensions	Malfunction of Transmission between Indoor and
	RZQ100~140D7V1B (Single phase)233	Outdoor Unit 206
	RZQ71D7V1B (Single phase)232	Malfunction of Transmission between Indoor and
E	Electronic Thermal (Time Lag)193	Outdoor Unit / Piping and Wiring Mismatch /
	Equipment Discharges Dust134	Gas Shortage 209
	Equipment Discharges White Mist131	Malfunction of Transmission between Indoor Unit
	Equipment does not Operate119	and Remote Controller 210
	Equipment Operates but does not Provide	Malfunction of Transmission between MAIN
	Cooling127	Remote Controller and SUB Remote
	Equipment Operates but does not Provide	Controller 211
	Heating129	Malfunction of Transmission System (between
	Equipment Produces Loud Noise or Shakes132	Control and Inverter PC Board) 197
	External Appearance4	Malfunctioning Capacity Setting 162
F	Failure of Capacity Setting201	Malfunctioning Drain System 160
	Failure of Outdoor Unit PC Board168	Malfunctioning Field Setting Switch 212
	Faulty Outdoor PC Board187	Malfunctioning HPS System 183
	Function Outline in Cooling Mode53	Malfunctioning in Discharge Pipe Temperature .. 181
	Function Outline in Heating Mode54	Malfunctioning Indoor PC Board 153
G	Gas Shortage (Malfunction)202	Malfunctioning Remote Controller Air Thermistor 166
	General Troubleshooting Flowchart117	O
H	Humidity Sensor System Malfunction167	Open Phase or Power Supply Voltage
I	Indoor Fan Operates, but Compressor does not .121	Imbalance 199
	Indoor Malfunctions148	Operation of the Remote Controller's Inspection /
	Indoor Unit Fan Motor Lock156	Test Operation Button 21
	Inspection/Test Button138	Operation Range 114
	Installation and Service Space	Outdoor Malfunctions 149
	Multiple Rows235	P
		PCB Layout
		RZQ71~140D7V1B (Single phase) 249
		Piping Diagrams
		Double Twin System 240
		Pipe Connection Diameters 241
		Piping Symbol 236
		Triple System 239
		R
		Radiation Fin Temperature Increased 189
		Remote Controller Display Malfunction Code and

Contents	144
Remote Controller LCD Displays "88"	135
Remote Controller Self-Diagnosis Function	23
RZQ100~140	
Removal of Compressor	261
Removal of Four Way Valve	260
Removal of Outside Panels	254
Removal of PC Board	257
Removal of Pressure Sensor, Electronic Expansion Valve, and Others	258
Removal of Propeller Fan and Fan Motor	255
Removal of Switch Box	256
Removal of Thermistor	259
RZQ7	
Removal of Outside Panels	252
Removal of Propeller Fan and Fan Motor	253
S	
Stall Prevention (Time Lag)	195
Swing Flap does not Operate	136
Swing Flap Motor Malfunction / Lock	158
Switch Box Layout	
RZQ71~140D7V1B (Single phase)	248
System Malfunctions	150
T	
Thermistor Abnormality	164
Troubleshooting by LED on Outdoor Unit	
PC Board	147
Troubleshooting by LED on the Indoor Units	146
W	
Wired Remote Controller	83
Wiring Diagrams	
RZQ71~140D7V1B (Single phase)	247