



# INSTALLATION MANUAL

## Split system air conditioners

RZQG71L7V1B  
RZQG100L7V1B  
RZQG125L7V1B  
RZQG140L7V1B

RZQG71L7Y1B9  
RZQG100L7Y1B  
RZQG125L7Y1B  
RZQG140L7Y1B

RZQSG100L7V1B  
RZQSG125L7V1B  
RZQSG140L7V1B

RZQSG100L7Y1B9  
RZQSG125L7Y1B9  
RZQSG140L7Y1B

		←	→	↖	↗	↘	A	B1	B2	C	D1	D2	E	L1/L2	
(A-1)		✓						≥100							
		✓		✓	✓		≥100	≥100		≥100					
		✓				✓						≤500	≥1000		
		✓		✓	✓	✓	≥150	≥150		≥150		≤500	≥1000		
			✓									≥500			
			✓			✓				≤500		≥500		≥1000	
		✓	✓				L1<L2	H<L2	≥100			≥500			
							L2<L1	L2<H	≥100			≥500			
							L1<L2	L1≤H	≥250	≤500		≥750		≥1000	L1≤1/2H
								H<L1	L1≤H					1/2H<L1≤H	
(A-2)		✓		✓	✓		≥200	≥300		≥1000					
		✓		✓	✓	✓	≥200	≥300		≥1000		≤500	≥1000		
			✓								≥1000				
			✓			✓				≤500		≥1000		≥1000	
		✓	✓				L1<L2	H<L2	≥300			≥1000			L2≤1/2H
							L2<L1	L2<H	≥250			≥1500			1/2H<L2≤H
									≥300						
							L1<L2	L1≤H	≥300	≤500		≥1000		≥1000	L1≤1/2H
								H<L1	L1≤H					1/2H<L1≤H	
							L2<L1	L2≤H	≥250			≥1500	≤500	≥1000	L2≤1/2H
						H<L2	≥300						1/2H<L2≤H		

1

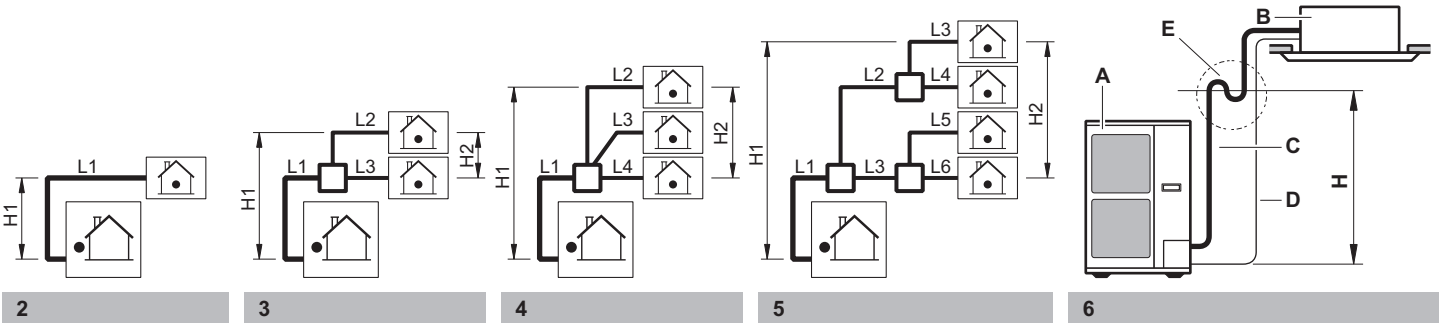

2

3

4

5

6

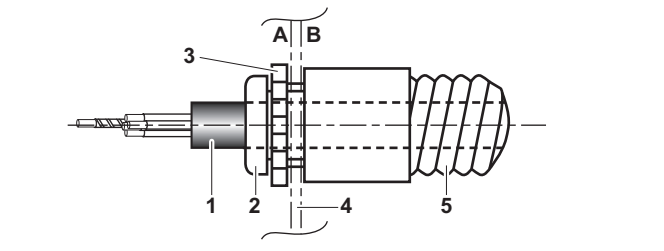

7

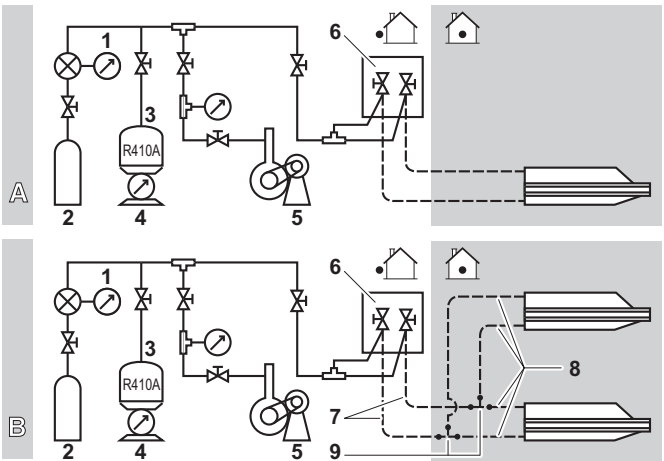

8

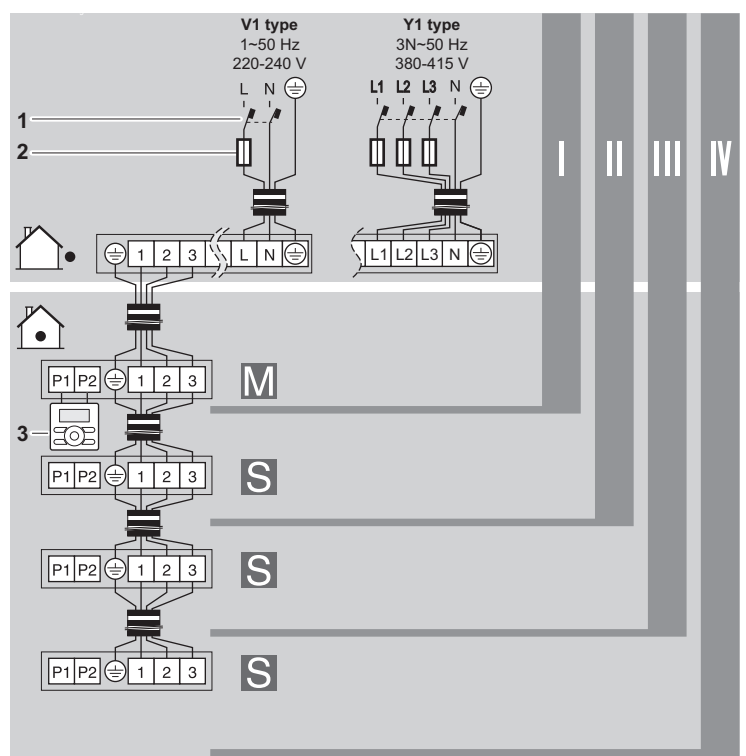

9



**Content**

	Page
1. Definitions.....	1
1.1. Meaning of warnings and symbols.....	1
1.2. Meaning of used terms .....	1
2. Safety considerations .....	2
3. Before installation .....	3
3.1. Scope of this manual .....	3
3.2. Precautions .....	3
3.3. Precautions for R410A.....	3
3.4. Installation.....	4
4. Accessories .....	4
4.1. Handling.....	4
5. Selecting installation site .....	4
5.1. General .....	4
5.2. Selecting a location in cold climates .....	5
6. Precautions on installation.....	5
6.2. Installation method for prevention of falling over .....	6
6.3. Drain pipe disposal .....	6
7. Installation service space .....	6
7.1. Precaution on installation .....	6
8. Refrigerant pipe size and allowable pipe length.....	7
8.1. Selection of piping material.....	7
8.2. Refrigerant pipe size .....	7
8.3. Selection of branch pipe .....	8
8.4. Allowable pipe length and height difference.....	8
9. Precautions on refrigerant piping.....	9
9.1. Flaring guidelines.....	9
9.2. Brazing guidelines.....	10
9.3. Stop valve operation .....	10
9.4. Tightening torques .....	11
10. Refrigerant piping .....	11
10.1. Preventing foreign objects from entering .....	11
10.2. Precautions when connecting field piping and regarding insulation.....	11
10.3. Cautions for necessity of a trap .....	12
11. Leak test and vacuum drying.....	12
11.1. General guidelines .....	12
11.2. Setup.....	12
11.3. Leak test .....	12
11.4. Vacuum drying .....	13
12. Charging refrigerant.....	13
12.1. Important information regarding the refrigerant used.....	13
12.2. Precautions and general guidelines.....	13
12.3. Calculating the additional refrigerant charge .....	14
12.4. Complete recharging.....	15
12.5. Total charging weight of the refrigerant (after a leak, etc.) .....	15
13. Pump down operation.....	15
14. Electrical wiring work .....	16
14.1. Precautions on electrical wiring work.....	16
14.2. Connecting power supply and inter-unit wiring .....	16
14.3. Precautions on wiring of power supply and inter-unit wiring.....	17
14.4. Specifications of standard wiring components .....	17
15. Test operation .....	18
15.1. Pre-run checks.....	18
15.2. Remote controller confirmation .....	18
15.3. Test run .....	18
15.4. Precautions regarding test-runs.....	19
15.5. Failure diagnosis at the moment of first installation .....	19
16. Wiring diagram .....	20

Thank you for purchasing this product.

The original instructions are written in English. All other languages are translations of the original instructions.



CAREFULLY READ THESE INSTRUCTIONS BEFORE INSTALLATION. THEY WILL TELL YOU HOW TO INSTALL AND HOW TO CONFIGURE THE UNIT PROPERLY. KEEP THIS MANUAL IN A HANDY PLACE FOR FUTURE REFERENCE.

**1. Definitions**

**1.1. Meaning of warnings and symbols**

Warnings in this manual are classified according to their severity and probability of occurrence.



**DANGER**

Indicates an imminently hazardous situation which, if not avoided, will result in death or serious injury.



**WARNING**

Indicates a potentially hazardous situation which, if not avoided, could result in death or serious injury.



**CAUTION**

Indicates a potentially hazardous situation which, if not avoided, may result in minor or moderate injury. It may also be used to alert against unsafe practices.



**NOTICE**

Indicates situations that may result in equipment or property-damage accidents only.



**INFORMATION**

This symbol identifies useful tips or additional information.

Some types of danger are represented by special symbols:



Electric current.



Danger of burning and scalding.

**1.2. Meaning of used terms**

**Installation manual:**

Instruction manual specified for a certain product or application, explaining how to install, configure and maintain it.

**Operation manual:**

Instruction manual specified for a certain product or application, explaining how to operate it.

**Maintenance instructions:**

Instruction manual specified for a certain product or application, which explains (if relevant) how to install, configure, operate and/or maintain the product or application.

**Dealer:**

Sales distributor for products as per the subject of this manual.

**Installer:**

Technical skilled person who is qualified to install products as per the subject of this manual.

**User:**

Person who is owner of the product and/or operates the product.

### Service company:

Qualified company which can perform or coordinate the required service to the unit.

### Applicable legislation:

All international, European, national and local directives, laws, regulations and/or codes which are relevant and applicable for a certain product or domain.

### Accessories:

Equipment which is delivered with the unit and which needs to be installed according to instructions in the documentation.

### Optional equipment:

Equipment which can optionally be combined to the products as per the subject of this manual.

### Field supply:

Equipment which needs to be installed according to instructions in this manual, but which are not supplied by Daikin.

## 2. Safety considerations

The precautions here, all cover very important topics, so be sure to follow them carefully.

All activities described in this manual shall be carried out by an installer.

Be sure to wear adequate personal protection equipment (protection gloves, safety glasses, ...) when performing installation, maintenance or service to the unit.

If not sure of installation procedures or operation of the unit, always contact your local dealer for advice and information.

Improper installation or attachment of equipment or accessories could result in electric shock, short-circuit, leaks, fire or other damage to the equipment. Be sure only to use accessories, optional equipment and spare parts made by Daikin which are specially designed for use with the products as of subject in this manual and have them installed by an installer.



### DANGER: ELECTRICAL SHOCK

Switch off all power supply before removing the switchbox service panel or before making any connections or touching electrical parts.

To avoid electric shock, be sure to disconnect the power supply 1 minute or more before servicing the electrical parts. Even after 1 minute, always measure the voltage at the terminals of main circuit capacitors or electrical parts and, before touching, be sure that those voltages are 50 V DC or less.

When service panels are removed, live parts can easily be touched by accident. Never leave the unit unattended during installation or servicing when the service panel is removed.



### DANGER: DO NOT TOUCH PIPING AND INTERNAL PARTS

Do not touch the refrigerant piping, water piping or internal parts during and immediately after operation. The piping and internal parts may be hot or cold depending on the working condition of the unit.

Your hand may suffer burns or frostbite if you touch the piping or internal parts. To avoid injury, give the piping and internal parts time to return to normal temperature or, if you must touch them, be sure to wear protective gloves.

## Warning

- Ask your dealer or qualified personnel to carry out installation work. Do not install the machine by yourself. Improper installation may result in water leakage, electric shocks or fire.
- Perform installation work in accordance with this installation manual. Improper installation may lead to water leakage, electric shocks or fire.
- The equipment is not intended for use in a potentially explosive atmosphere.
- For RZQG units only  
For year round cooling applications with low indoor humidity conditions, such as Electronic Data Processing rooms, contact your dealer or see the engineering databook or the service manual.
- Consult your local dealer regarding what to do in case of refrigerant leakage. When the unit is to be installed in a small room, it is necessary to take proper measures so that the amount of any leaked refrigerant does not exceed the concentration limit in the event of a leakage. Otherwise, this may lead to an accident due to oxygen depletion.
- Be sure to use only the specified accessories and parts for installation work.  
Failure to use the specified parts may result in water leakage, electric shocks, fire, or the unit falling.
- Install the unit on a foundation that can withstand its weight.  
Insufficient strength may result in the fall of equipment and causing injury.
- Carry out the specified installation work in consideration of strong winds, typhoons, or earthquakes.  
Improper installation work may result in accidents due to fall of equipment.
- Make sure that all electrical work is carried out by qualified personnel according to the applicable legislation and this installation manual, using a separate circuit.  
Insufficient capacity of the power supply circuit or improper electrical construction may lead to electric shocks or fire.
- Make sure that all wiring is secure, using the specified wires and ensuring that external forces do not act on the terminal connections or wires.  
Incomplete connection or fixing may cause a fire.
- When wiring between the indoor and outdoor units, and wiring the power supply, form the wires so that the frontside panel can be securely fastened.  
If the frontside panel is not in place, overheating of the terminals, electric shocks or a fire may be caused.
- If refrigerant gas leaks during installation work, ventilate the area immediately.  
Toxic gas may be produced if refrigerant gas comes into contact with fire.
- After completing the installation work, check to make sure that there is no leakage of refrigerant gas.  
Toxic gas may be produced if refrigerant gas leaks into the room and comes into contact with a source of fire, such as a fan heater, stove or cooker.
- When planning to relocate former installed units, you must first recover the refrigerant after the pump down operation. Refer to chapter "13. Pump down operation" on page 15.
- Never directly touch any accidental leaking refrigerant. This could result in severe wounds caused by frostbite.
- Be sure to install an earth leakage circuit breaker in accordance with applicable legislation. Failure to do so may cause electrical shock and fire.

## Caution

- Earth the unit.  
Earthing resistance should be according to applicable legislation.  
Do not connect the earth wire to gas or water pipes, lightning conductor or telephone earth wire.  
Incomplete earthing may cause electric shocks. 
- Gas pipe.  
Ignition or explosion may occur if the gas leaks.
- Water pipe.  
Hard vinyl tubes are not effective earths.
- Lightning conductor or telephone earth wire.  
Electric potential may rise abnormally if struck by a lightning bolt.
- Install drain piping according to this installation manual to ensure good drainage, and insulate the pipe to prevent condensation. Improper drain piping may cause water leakage, and make the furnitures get wet.
- Install the indoor and outdoor units, power wire and connecting wire at least 1 meter away from televisions or radios to prevent image interference or noise.  
(Depending on the radio waves, a distance of 1 meter may not be sufficient to eliminate the noise.)
- Do not rinse the outdoor unit. This may cause electric shocks or fire.
- Do not install the unit in places such as the following:
  - Where there is mist of mineral oil, oil spray or vapour for example a kitchen.  
Plastic parts may deteriorate, and cause them to fall out or water to leak.
  - Where corrosive gas, such as sulphurous acid gas, is produced.  
Corrosion of copper pipes or soldered parts may cause the refrigerant to leak.
  - Where there is machinery which emits electromagnetic waves.  
Electromagnetic waves may disturb the control system, and cause malfunction of the equipment.
  - Where flammable gases may leak, where carbon fiber or ignitable dust is suspended in the air or where volatile flammables, such as thinner or gasoline, are handled.  
Such gases may cause a fire.
  - Where the air contains high levels of salt such as that near the ocean.
  - Where voltage fluctuates a lot, such as in factories.
  - In vehicles or vessels.
  - Where acidic or alkaline vapour is present.
- Do not allow a child to mount on the outdoor unit or avoid placing any object on the unit. Falling or tumbling may result in injury.
- For use of units in applications with temperature alarm settings it is advised to foresee a delay of 10 minutes for signalling the alarm in case the alarm temperature is exceeded. The unit may stop for several minutes during normal operation for "defrosting the unit", or when in "thermostat stop" operation.
- This appliance is intended to be used by expert or trained users in shops, in light industry and on farms, or for commercial use by lay persons.
- Sound pressure level is less than 70 dB(A).

## Provide a logbook

In accordance with the relevant national and international codes, it may be necessary to provide a logbook with the equipment containing at least

- info on maintenance,
- repair work,
- results of tests,
- stand-by periods,
- etc...

In Europe, EN378 provides the necessary guidance for this logbook.

## 3. Before installation

### 3.1. Scope of this manual

This manual describes the procedures for handling, installing and connecting RZQ(S)G71~140 units.

### 3.2. Precautions



#### CAUTION

Since maximum working pressure is 4.0 MPa or 40 bar, pipes of larger wall thickness may be required. Refer to paragraph "8.1. Selection of piping material" on page 7.



#### NOTICE: Insulation resistance of the compressor

If, after installation, refrigerant accumulates in the compressor, the insulation resistance can drop, but if it is at least 1 MΩ, then the machine will not break down.

Turn the power on and leave it on for six hours. Then, check if the insulation resistance of the compressor has risen or not.

The compressor will heat up and evaporate any refrigerant in the compressor.

Check the following if the ground-fault circuit interrupter is triggered:  
Make sure that the interrupter is compatible with high frequencies.

This unit has an inverter, so an interrupter capable of handling high frequencies is needed to prevent malfunction of the interrupter itself.

### 3.3. Precautions for R410A

- The refrigerant requires strict cautions for keeping the system clean, dry and tight.
  - Clean and dry  
Foreign materials (including mineral oils or moisture) should be prevented from getting mixed into the system.
  - Tight  
Read "9. Precautions on refrigerant piping" on page 9 carefully and follow these procedures correctly.
- Since R410A is a mixed refrigerant, the required additional refrigerant must be charged in its liquid state. (If the refrigerant is in state of gas, its composition changes and the system will not work properly).
- The connected indoor units must be indoor units designed exclusively for R410A.

### 3.4. Installation

- For installation of the indoor unit(s), refer to the indoor unit installation manual.
- Illustrations show RZQG125L outdoor unit type. Other types also follow this installation manual.
- This outdoor unit requires the pipe branching kit (optional) when used as the outdoor unit for the simultaneous operation system. Refer to catalogues for details.
- Never operate the unit with a damaged or disconnected discharge thermistor and suction thermistor, burning of the compressor may result.
- Be sure to confirm the model name and the serial no. of the outer (front) plates when attaching/detaching the plates to avoid mistakes.
- When closing the service panels, take care that the tightening torque does not exceed 4.1 N•m.

### 3.5. Model identification

RZQG units include special equipment (insulation, optional bottom plate heater, ...) to ensure good operation in areas where low ambient temperature can occur together with high humidity conditions. In such conditions the RZQSG models may experience problems with severe ice build up on the air-cooled coil. If such conditions are expected, a RZQG unit must be installed instead. These models contain countermeasures (insulation, optional bottom plate heater, ...) to prevent freeze up.

## 4. Accessories

Check if the following accessories are included with the unit:

See the figure below for the location of the accessories.

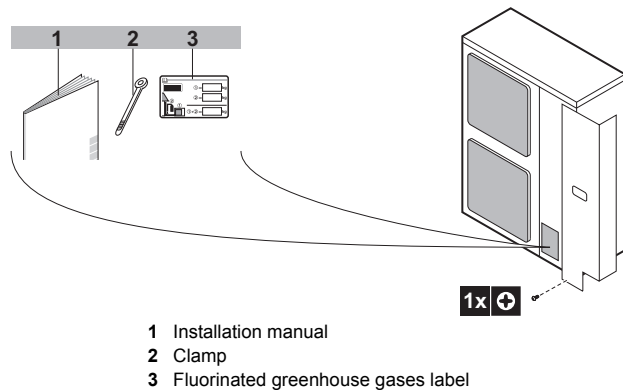

### 4.1. Handling

As shown in the figure, bring the unit slowly by grabbing the left and right grips.

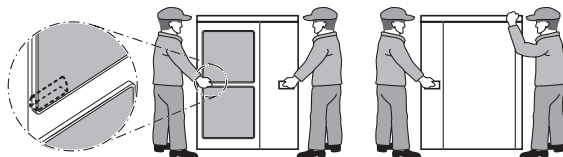

Place your hands on the corner instead of holding the suction inlet in the side of the casing, otherwise the casing could be deformed.



#### CAUTION

Take care not to let hands or objects come in contact with rear fins.

## 5. Selecting installation site

### 5.1. General



#### WARNING

- Be sure to provide for adequate measures in order to prevent that the outdoor unit be used as a shelter by small animals.
  - Small animals making contact with electrical parts can cause malfunctions, smoke or fire. Please instruct the customer to keep the area around the unit clean.
- 
- Select an installation site where the following conditions are satisfied and that meets with your customer's approval.
    - Places which are well-ventilated.
    - Places where the unit does not bother next-door neighbours.
    - Safe places which can withstand the unit's weight and vibration and where the unit can be installed level.
    - Places where there is no possibility of flammable gas or product leak.
    - The equipment is not intended for use in a potentially explosive atmosphere.
    - Places where servicing space can be well ensured.
    - Places where the indoor and outdoor units' piping and wiring lengths come within the allowable ranges.
    - Places where water leaking from the unit cannot cause damage to the location (e.g. in case of a blocked drain pipe).
    - Places where the rain can be avoided as much as possible.
    - Do not install the unit in places often used as work place. In case of construction works (e.g. grinding works) where a lot of dust is created, the unit must be covered.
    - Do not place any objects or equipment on top of the unit (top plate).
    - Do not climb, sit or stand on top of the unit,
    - Be sure that sufficient precautions are taken, in accordance with applicable legislation, in case of refrigerant leakage.



#### NOTICE

This is a class A product. In a domestic environment this product may cause radio interference in which case the user may be required to take adequate measures.

- When installing the unit in a place exposed to strong wind, pay special attention to the following. Strong winds of 5 m/sec or more blowing against the outdoor unit's air outlet causes short circuit (suction of discharge air), and this may have the following consequences:
  - Deterioration of the operational capacity.
  - Frequent frost acceleration in heating operation.
  - Disruption of operation due to rise of high pressure.
  - When a strong wind blows continuously on the face of the unit, the fan can start rotating very fast until it breaks. Refer to the figures for installation of this unit in a place where the wind direction can be foreseen.

- Install a baffle plate on the air suction side of the outdoor unit and set the outlet side at a right angle to the direction of the wind:

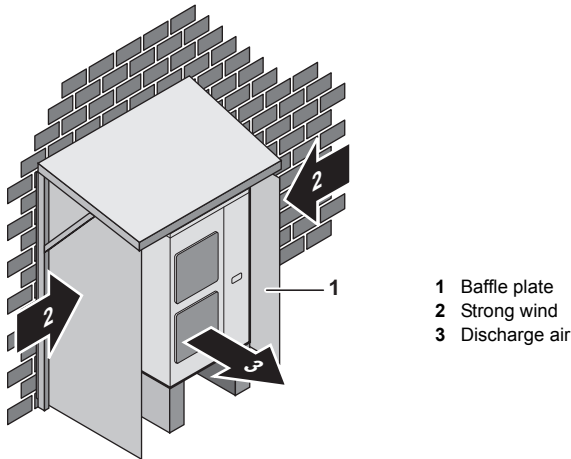

- 1 Baffle plate
- 2 Strong wind
- 3 Discharge air

- Prepare a water drainage channel around the foundation, to drain waste water from around the unit.
- If the water drainage of the unit is not easy, please build up the unit on a foundation of concrete blocks, etc. (the height of the foundation should be maximum 150 mm).
- If you install the unit on a frame, please install a waterproof plate (field supply) within 150 mm of the underside of the unit in order to prevent the invasion of water from the lower direction.
- When installing the unit in a place frequently exposed to snow, pay special attention to elevate the foundation as high as possible.
- If you install the unit on a building frame, please install a waterproof plate (field supply)(within 150 mm of the underside of the unit) or use a drain kit in order to avoid the drainwater dripping (field supply). (See figure).

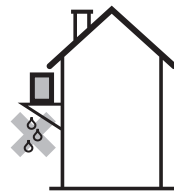

- Make sure that the unit is installed level.

## 5.2. Selecting a location in cold climates



### NOTICE

When operating the outdoor unit in a low outdoor ambient temperature, be sure to follow the instructions described below.

- To prevent exposure to wind, install the outdoor unit with its suction side facing the wall.
- Never install the outdoor unit at a site where the suction side may be exposed directly to wind.
- To prevent exposure to wind, install a baffle plate on the air discharge side of the outdoor unit.

- In heavy snowfall areas it is very important to select an installation site where the snow will not affect the unit and set the outlet side at a right angle to the direction of the wind:

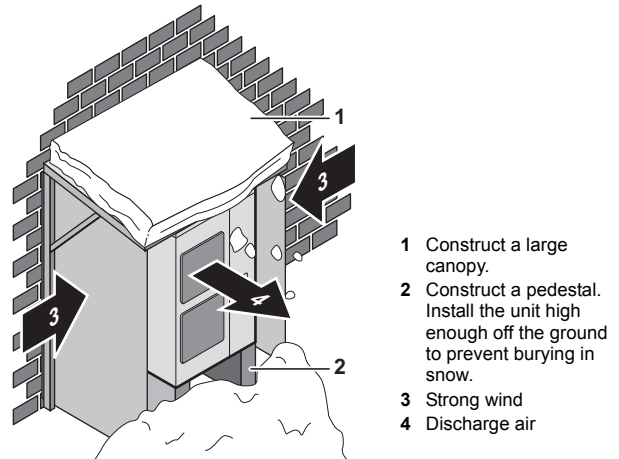

- 1 Construct a large canopy.
- 2 Construct a pedestal. Install the unit high enough off the ground to prevent burying in snow.
- 3 Strong wind
- 4 Discharge air

## 6. Precautions on installation



### NOTICE

If drain holes of the outdoor unit are covered by a mounting base or by floor surface, raise the unit in order to provide a free space of more than 150 mm under the outdoor unit.

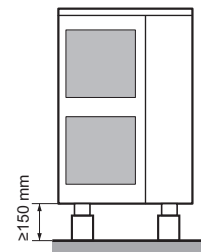

### 6.1. Foundation work

- Check the strength and level of the installation ground so that the unit will not cause any operating vibration or noise after installation.
- In accordance with the foundation drawing in the figure, fix the unit securely by means of the foundation bolts. (Prepare four sets of M12 foundation bolts, nuts and washers each which are available on the market.)
- It is best to screw in the foundation bolts until their length are 20 mm from the foundation surface.

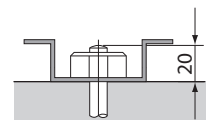

- Fix the outdoor unit to the foundation bolts using nuts with resin washers (1) as shown in the figure. If the coating on the fastening area is stripped off, the nuts rust easily.



Dimensions (bottom view) (unit of measurement: mm)

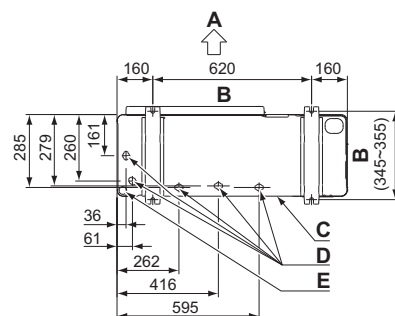

- Front (air outlet side)
- Leg pitch
- Bottom frame
- Drain hole
- Knock-out hole



## 6.2. Installation method for prevention of falling over

If it is necessary to prevent the unit from falling over, install as shown in the figure.

- prepare all 4 wires as indicated in the drawing
- unscrew the top plate at the 4 locations indicated A and B
- put the screws through the nooses and screw them back tight

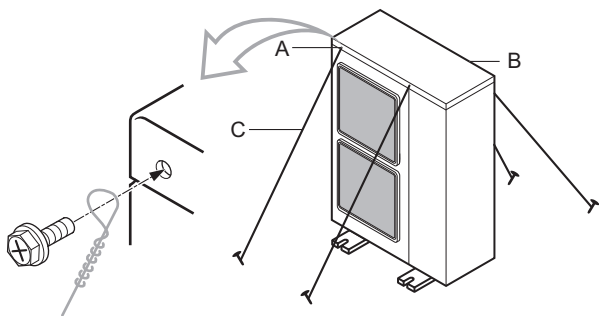

A Location of the 2 fixation holes on the front side of the unit  
 B Location of the 2 fixation holes on the rear side of the unit  
 C Wires: field supply

## 6.3. Drain pipe disposal

- Make sure the drain works properly.
- In regions where buildups of snow can be expected, the accumulation and freezing of snow in the space between the heat exchanger and external plate may lower operating efficiency. In this case, drill a knock-out hole in the lower part of the bottom frame so the snow can escape. When creating a knock-out hole, use a  $\varnothing 6$  mm drill bit to open round holes connected to the circumference of the knock-out hole (4 places).
- After punching the knock-out hole, the application of repair-type paint on the surface around the edge sections is recommended to prevent rust.

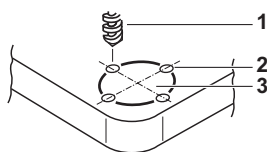

1 Drill  
 2 Area around knock-out hole  
 3 Knock-out hole

## 7. Installation service space

- The installation service spaces shown in the illustrations are based on an air intake temperature of  $35^{\circ}\text{C}$  (DB) for COOL operation. In regions where the air intake temperature regularly exceeds  $35^{\circ}\text{C}$  (DB), or if the heat load of outdoor units is expected to regularly exceed the maximum operating capacity, reserve a larger space than that indicated at the air intake side of units.
- Regarding the required air outlet space, position the units with consideration to the space required for the onsite refrigerant piping work as well. Consult your dealer if the work conditions do not match those in the drawings.

## 7.1. Precaution on installation

(A) In case of non-stacked installation (See figure 1) (Unit : mm)

(A-1) Single unit installation

(A-2) Multiple units installation (2 units or more)

- Secure appropriate space when using a side piping outlet.

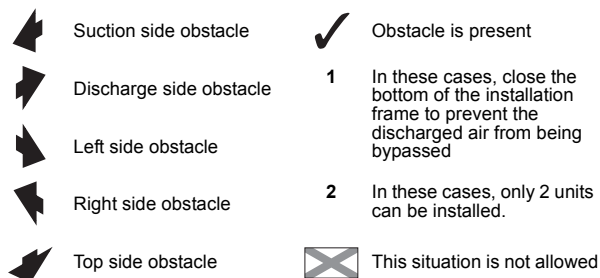

(B) In case of stacked installation

1. In case obstacles exist in front of the outlet side.

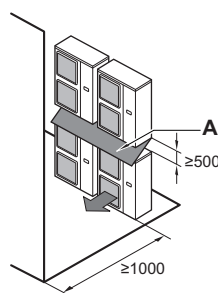

A Roof cover (field supply)

2. In case obstacles exist in front of the air inlet.

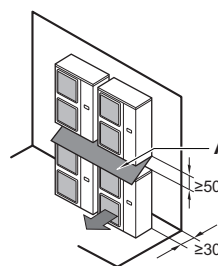

A Roof cover (field supply)

- Do not exceed two levels for stacked installation.
- Install a roof cover as shown in the figures above (field supply), as outdoor units with downward drainage are subject to dripping and freezing of that drain water.
- Install the upper outdoor unit so that its bottom plate is at sufficient height above the roof cover. This is to prevent the buildup of ice on the bottom plate outer surface. A space of at least 500 mm is recommended.
- It is not necessary to install a roof cover if there is no danger of drainage dripping and freezing. In this case, the space between the upper and lower outdoor units should be at least 100 mm. Close the gap between the upper and lower units so there is no re-intake of discharged air.

(C) In case of multiple-row installation (for roof top use, etc.)

1. In case of installing one unit per row.

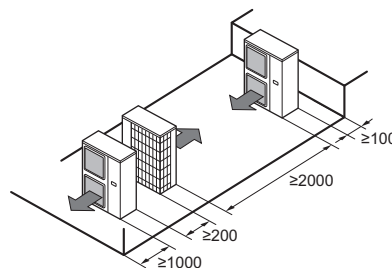

2. In case of installing multiple units (2 units or more) in lateral connection per row.

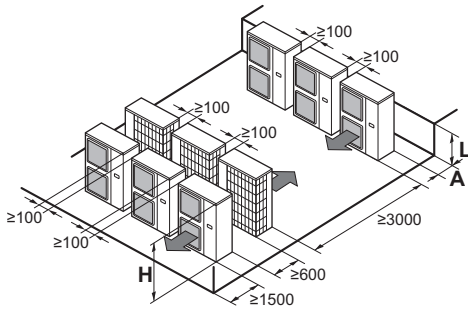

Relation of dimensions of H, A and L are shown in the table below.

	L	A
L ≤ H	L ≤ 1/2H	≥ 250
	1/2H < L ≤ H	≥ 300
H < L	Installation impossible	

## 8. Refrigerant pipe size and allowable pipe length



### DANGER

- Piping and other pressure containing parts shall comply with the applicable legislation and shall be suitable for refrigerant. Use phosphoric acid deoxidised seamless copper for refrigerant.
- Installation shall be done by an installer, the choice of materials and installation shall comply with applicable legislation. In Europe the EN378 is the application standard that shall be used.



### NOTICE

#### To persons in charge of piping work:

Be sure to open the stop valve after piping installing and vacuuming is complete. (Running the system with the valve closed may break the compressor.)



### INFORMATION

It is forbidden to discharge refrigerant into the atmosphere. Collect the refrigerant in accordance with the freon collection and destruction law.



### NOTICE

Do not use flux when brazing the refrigerant piping.

For brazing, use phosphor copper brazing filler metal (BCuP) which does not require a flux.

(If a chlorine flux is used, the piping will corrode, and if the flux contains fluoride, it will cause the coolant oil to deteriorate, adversely affecting the coolant piping system.)

## 8.1. Selection of piping material

- Construction material: phosphoric acid deoxidised seamless copper for refrigerant.
- Temper grade: use piping with temper grade in function of the pipe diameter as listed in table below.
- The pipe thickness of the refrigerant piping should comply with relevant local and national regulations. The minimal pipe thickness for R410A piping must be in accordance with the table below.

Pipe Ø	Temper grade of piping material	Minimal thickness t (mm)
6.4 / 9.5 / 12.7	Annealed	0.80
15.9	Annealed	1.00
19.1	Half hard	

Only use annealed material for flare connections.

## 8.2. Refrigerant pipe size

Refer to figure 3 for twin system, to figure 4 for triple system and to figure 5 for double twin system.

- Main pipe (pipe between outdoor and first branch). The pipes should have the same size as the outdoor connections.

Refrigerant pipe size <sup>(a)</sup>			
Gas pipe			
Model	Size-down	Standard size	Size-up
RZQG71	Ø12.7	Ø15.9	—
RZQG100~140	—	Ø15.9	Ø19.1
RZQSG100~140	—	Ø15.9	Ø19.1
Liquid pipe			
Model	Size-down	Standard size	Size-up
RZQG71~140	Ø6.4	Ø9.5	Ø12.7
RZQSG100~140	Ø6.4	Ø9.5	Ø12.7

(a) In case of twin, triple and double twin applications, the listed refrigerant pipe sizes relate to the main pipes only. (L1 = the pipes between the outdoor unit and the branch in figures 3-5).

- Pipe between first branch and second branch (L2+L3) (only for double twin).

Liquid	Ø9.5
Gas	Ø15.9

- Pipe between branch and indoor units (L2~L3 for twin, L2~L4 for triple and L4~L7 for double twin). These pipe sizes must have the same size as the connected indoor units pipe sizes. Branch: see marking '□' on figures 3, 4 and 5.



### NOTICE

- For new installations, use the standard pipe sizes.
- When using existing pipes, size-up is allowed as mentioned in the table above. Additional restrictions towards allowable pipe lengths, as mentioned in the table "Allowable pipe length and height difference" on page 8, must be taken into account. Not using the standard pipe size may result in capacity decrease. The installer must acknowledge this and judge this very carefully in function of the complete installation.

### 8.3. Selection of branch pipe

		 <b>RZQ(S)G71~140L7Y1B(9)+ FCQG35~71F/FCQHG71F</b>
Twin	KHRQ22M20TA	KHRQ58T
Triple	KHRQ127H	KHRQ58H
Double twin	KHRQ22M20TA (3x)	KHRQ58T (3x)

### 8.4. Allowable pipe length and height difference

See the table below concerning lengths and heights. Refer to figures 2, 3, 4 and 5. Assume that the longest line in the figure corresponds with the actual longest pipe, and the highest unit in the figure corresponds with the actual highest unit.

■ For RZQG units only

Allowable pipe length					
		Liquid pipe size		Model	
		71	100	125	140
<b>Maximum total one-way piping length<sup>(a)</sup></b>					
Pair	L1	size-down	10 m (10 m)		
		<b>standard</b>	<b>50 m (70 m)</b>	<b>75 m (90 m)</b>	
		size-up	25 m (35 m)	35 m (45 m)	
• Twin and triple • Double twin	• L1+L2 • L1+L2+L4	size-down	15 m (10 m)		
		<b>standard</b>	<b>50 m (70 m)</b>	<b>75 m (90 m)</b>	
		size-up	25 m (35 m)	35 m (45 m)	
<b>Minimum total one-way piping length</b>					
All	L1+L2+L3+L4+L5+L6+L7	—	3 m <sup>(b)</sup>		
<b>Maximum allowable piping length</b>					
Twin	L1+L2+L3	—	60 m	75 m	75 m
Triple	L1+L2+L3+L4		—	—	
Double twin	L1+L2+L3+L4+L5+L6+L7		—	—	
<b>Maximum branch piping length</b>					
• Twin and triple • Double twin	• L2 • L2+L4	—	20 m		
<b>Maximum difference between branch lengths</b>					
Twin	L2-L3	—	10 m	10 m	10 m
Triple	L2-L4		—	—	
Double twin	• L2-L3 • L4-L5 • L6-L7 • (L2+L4)-(L3+L7)		—	—	
<b>Maximum height between indoor and outdoor</b>					
All	H1	—	30 m		
<b>Maximum height between indoors</b>					
Twin, triple and double twin	H2	—	0.5 m		
<b>Chargeless length</b>					
All	L1+L2+L3+L4+L5+L6+L7	size-down	≤10 m		
		<b>standard</b>	<b>≤30 m</b>		
		size-up	≤15 m		

(a) Parenthesized figure represents the equivalent length.

(b) When piping length is less than 5 m, a complete recharging of the unit is required. See paragraph "Total charging weight of the refrigerant (after a leak, etc.)" on page 15.

■ For RZQSG units only

Allowable pipe length				
		Liquid pipe size		Model
		100	125	140
<b>Maximum total one-way piping length<sup>(a)</sup></b>				
Pair	L1	size-down	10 m (10 m)	
		<b>standard</b>	<b>50 m (70 m)</b>	
		size-up	25 m (35 m)	
• Twin and triple • Double twin	• L1+L2 • L1+L2+L4	size-down	10 m (10 m)	
		<b>standard</b>	<b>50 m (70 m)</b>	
		size-up	25 m (35 m)	
<b>Minimum total one-way piping length</b>				
All	L1+L2+L3+L4+L5+L6+L7	—	5 m	
<b>Maximum allowable piping length</b>				
Twin	L1+L2+L3	—	50 m	50 m
Triple	L1+L2+L3+L4		—	
Double twin	L1+L2+L3+L4+L5+L6+L7		—	
<b>Maximum branch piping length</b>				
• Twin and triple • Double twin	• L2 • L2+L4	—	20 m	
<b>Maximum difference between branch lengths</b>				
Twin	L2-L3	—	10 m	10 m
Triple	L2-L4		—	
Double twin	• L2-L3 • L4-L5 • L6-L7 • (L2+L4)-(L3+L7)		—	
<b>Maximum height between indoor and outdoor</b>				
All	H1	—	30 m	
<b>Maximum height between indoors</b>				
Twin, triple and double twin	H2	—	0.5 m	
<b>Chargeless length</b>				
All	L1+L2+L3+L4+L5+L6+L7	size-down	≤10 m	
		<b>standard</b>	<b>≤30 m</b>	
		size-up	≤15 m	

(a) Parenthesized figure represents the equivalent length.

■ Existing or pre-installed piping can be used

- Piping must comply with the criteria below.
  - Pipe diameter must comply with the limitations as indicated in paragraph "8.2. Refrigerant pipe size" on page 7.
  - Piping length must be within limits of the allowable piping length as in paragraph "8.4. Allowable pipe length and height difference" on page 8.
  - Piping must be designed for R410A. See paragraph "8.1. Selection of piping material" on page 7.
- Piping can be reused without cleaning when:
  - Total 1-way piping length: <50 m.
  - No compressor breakdown has occurred in the history of the unit to be replaced.
  - A correct pump down operation can be executed:
    - Operate the unit continuously for 30 minutes in cooling mode.
    - Execute a pump down operation.
    - Remove the air conditioning units to be replaced.
  - Check the contamination inside the existing piping.

If you cannot meet all these requirements, the existing pipes must be cleaned or replaced after removing the air conditioning units to be replaced.
- Prepare the flare connections for higher pressure. See paragraph "10.3. Cautions for necessity of a trap" on page 12.

## 9. Precautions on refrigerant piping

- Do not allow anything other than the designated refrigerant to get mixed into the freezing cycle, such as air, etc. If any refrigerant gas leaks while working on the unit, ventilate the room thoroughly right away.
- Use R410A only when adding refrigerant  
**Installation tools:**  
 Make sure to use installation tools (gauge manifold, charge hose, etc.) that are exclusively used for R410A installations to withstand the pressure and to prevent foreign materials (e.g. mineral oils and moisture) from mixing into the system.  
**Vacuum pump:**  
 Use a 2-stage vacuum pump with a non-return valve  
 Make sure the pump oil does not flow oppositely into the system while the pump is not working.  
 Use a vacuum pump which can evacuate to  $-100.7$  kPa (5 Torr,  $-755$  mm Hg).
- During tests never pressurize the appliances with a pressure higher than the maximum allowable pressure (see unit name plate: PS).
- In order to prevent dirt, liquid or dust from entering the piping, cure the piping with a pinch or taping.

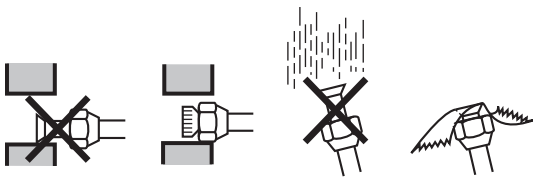

Place	Installation period	Protection method
Outdoor unit	More than a month	Pinch the pipe
	Less than a month	Pinch or tape the pipe
Indoor unit	Regardless of the period	

Great caution is needed when passing copper tubes through walls.

- Piping should be mounted so that the flare is not subjected to mechanical stress.
- In case of simultaneous operating system
  - Upward and downward piping should be performed at the main piping line.
  - Use branch piping kit (optional) for branching refrigerant pipes.

Precautions to be taken. (For details, refer to the manual attached to branch piping kit.)

- Install the branch pipes horizontally (with a maximum inclination of  $15^\circ$ ) or vertically.
- Length of branch pipe to the indoor unit should be as short as possible.
- Try to keep lengths of both branch pipes to the indoor unit equal.

- When using existing refrigerant piping  
 Pay attention to the following points when using existing refrigerant piping
  - Perform a visual check on quality of residual oil in existing refrigerant piping.  
 This check is extremely important because using existing piping with deteriorated oil will cause compressor breakdown.
    - Put some residual oil of the pipes you want to reuse on a piece of white paper or on the white surface of an oil checking reference card and compare that oil colour with the circled colour of the oil checking reference card.
    - If oil colour is identical to the circled colour or darker, replace the piping, install new piping or clean the piping thoroughly.
    - If oil colour is lighter, the pipes can be reused without cleaning.
 An oil checking reference card is indispensable for such evaluation and can be obtained at your dealer.
  - In the following situations, the existing piping should not be re-used and new piping should be installed.
    - If the previously used model had problems with its compressor (this might cause oxidised coolant oil, scale residue and other adverse effects).
    - If the indoor or outdoor units were disconnected from the piping for a long period of time (water or dirt might have gotten into the piping).
    - If copper piping is corroded.
  - Flares should not be re-used but rather new ones made in order to prevent leaks.
  - Check welded connections for gas leaks, if the local piping has welded connections.
  - Replace deteriorated insulation with new material.

### 9.1. Flaring guidelines

- Flares should not be re-used. New ones should be made in order to prevent leaks.
- Use a pipe cutter and flare tool suitable for the refrigerant used.
- Only use the flare nuts included with the unit. Using different flare nuts may cause the refrigerant to leak.
- Please refer to the table for flaring dimensions and tightening torques (too much tightening will result in splitting the flare).

Piping size (mm)	Tightening torque (N·m)	Flare dimensions A (mm)	Flare shape (mm)
Ø6.4	15~17	8.7~9.1	
Ø9.5	33~39	12.8~13.2	
Ø12.7	50~60	16.2~16.6	
Ø15.9	63~75	19.3~19.7	
Ø19.1	90~110	23.6~24.0	

- When connecting the flare nut, coat the flare inner surface with ether oil or with ester oil and initially tighten 3 or 4 turns by hand before tightening firmly.

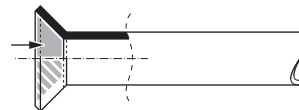

- When loosening a flare nut, always use two wrenches together. When connecting the piping, always use a spanner and torque wrench together to tighten the flare nut to prevent flare nut cracking and leaks.

- Torque wrench
- Spanner
- Piping union
- Flare nut

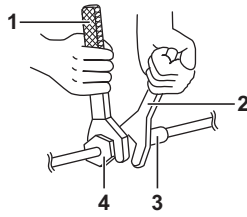

### Not recommended, but in case of emergency

Should you be forced to connect the piping without a torque wrench, follow the following installation method:

- Tighten the flare nut using a spanner until the tightening torque suddenly increases.
- From that position further tighten the flare nut to the angle listed below:

Piping size (mm)	Further tightening angle (degrees)	Recommended arm length of spanner (mm)
Ø6.4	60~90	150
Ø9.5		200
Ø12.7	30~60	250
Ø15.9		300
Ø19.1	20~35	450

## 9.2. Brazing guidelines

- Make sure to blow through with nitrogen when brazing. Blowing through with nitrogen prevents the creation of large quantities of oxidized film on the inside of the piping. An oxidized film adversely affects valves and compressors in the refrigerating system and prevents proper operation.
- The nitrogen pressure should be set to 0.02 MPa (i.e., just enough so it can be felt on the skin) with a pressure-reducing valve.

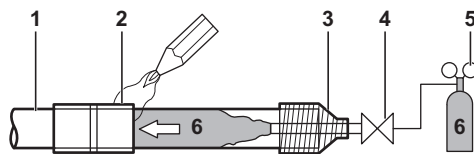

- Refrigerant piping
- Part to be brazed
- Taping
- Manual valve
- Pressure-reducing valve
- Nitrogen

- Do not use anti-oxidants when brazing the pipe joints. Residue can clog pipes and break equipment.
- Do not use flux when brazing copper-to-copper refrigerant piping. Use phosphor copper brazing filler alloy (BCuP) which does not require flux.
- Flux has an extremely harmful influence on refrigerant piping systems. For instance, if chlorine based flux is used, it will cause pipe corrosion or, in particular, if the flux contains fluorine, it will deteriorate the refrigerant oil.

## 9.3. Stop valve operation

### Cautions on handling the stop valve

- Make sure to keep both stop valves open during operation.
- The figure below shows the name of each part required in handling the stop valve.

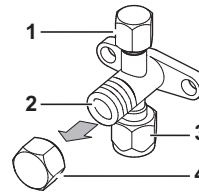

- Service port and service port cap
- Valve stem
- Field piping connection
- Stem cap

- The stop valve is factory closed.
- Do not apply excessive force to the valve stem. Doing so may break the valve body.
- Since the stop valve attachment plate may be deformed if only a torque wrench is used to loosen or tighten the flare nut, always make sure to secure the stop valve with a spanner, then loosen or tighten the flare nut with a torque wrench. Do not place the spanner on the stem cap, as this could cause a refrigerant leak.

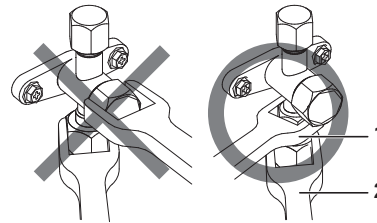

- Spanner
- Torque wrench

- When it is expected that the operating pressure will be low (for example, when cooling will be performed while the outside air temperature is low), sufficiently seal the flare nut in the stop valve on the gas line with silicon sealant to prevent freezing.

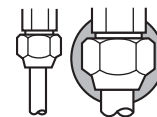

■ Silicon sealant  
(Make sure there is no gap)

### Opening/closing the stop valve

#### Opening the stop valve

- Remove the valve cover.
- Insert a hexagon wrench (liquid side: 4 mm/gas side: 6 mm) into the valve stem and turn the valve stem counterclockwise.
- When the valve stem cannot be turned any further, stop turning. The valve is now open.

#### Closing the stop valve

- Remove the valve cover.
- Insert a hexagon wrench (liquid side: 4 mm/gas side: 6 mm) into the valve stem and turn the valve stem clockwise.
- When the valve stem cannot be turned any further, stop turning. The valve is now closed.

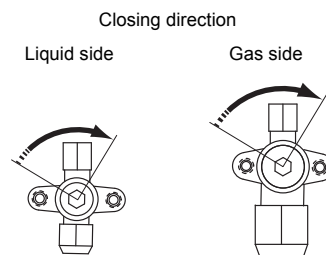

### Cautions on handling the stem cap

- The stem cap is sealed where indicated by the arrow. Take care not to damage it.
- After handling the stop valve, make sure to tighten the stem cap securely. For the tightening torque, refer to the table below.
- Check for refrigerant leaks after tightening the stem cap.

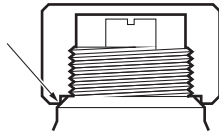

### Cautions on handling the service port

- Always use a charge hose equipped with a valve depressor pin, since the service port is a Schrader type valve.
- After handling the service port, make sure to tighten the service port cap securely. For the tightening torque, refer to the table below.
- Check for refrigerant leaks after tightening the service port cap.

### 9.4. Tightening torques

Item	Tightening torque (N·m)
Stem cap, liquid side	13.5~16.5
Stem cap, gas side	22.5~27.5
Service port cap	11.5~13.9

## 10. Refrigerant piping

- Field pipes can be installed in four directions (A, B, C, D).

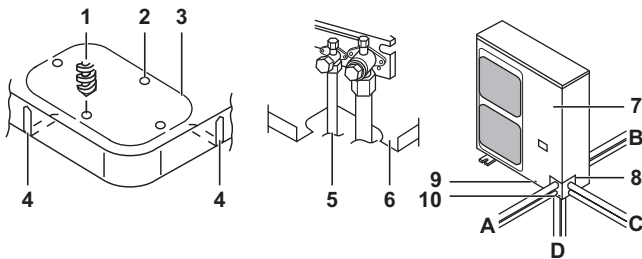
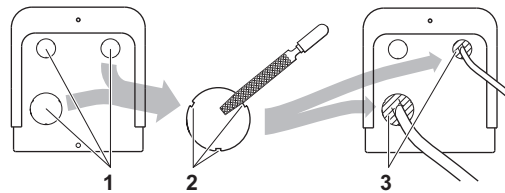

Figure - Field pipes in 4 directions

- 1 Drill
- 2 Centre area around knock-out hole
- 3 Knock-out hole
- 4 Slit
- 5 Connecting pipe
- 6 Bottom frame
- 7 Front plate
- 8 Pipe outlet plate
- 9 Screw front plate
- 10 Pipe outlet plate screw
- A Forward
- B Backward
- C Sideways
- D Downward

- Cutting out the two slits makes it possible to install as shown in the figure "Field pipes in 4 directions". (Use a metal saw to cut out the slits.)
- To install the connecting pipe to the unit in a downward direction, make a knock-out hole by penetrating the centre area around the knock-out hole using a Ø6 mm drill (4x). (See figure "Field pipes in 4 directions".)
- After knocking out the knock-out hole, it is recommended to apply repair paint to the edge and the surrounding end surfaces to prevent rusting.

- When passing electrical wiring through the knock-out holes, remove any burrs from the knock-out holes and wrap the wiring with protective tape to prevent damage.



- 1 Knock-out hole
- 2 Burr
- 3 Packing materials

### 10.1. Preventing foreign objects from entering

Plug the pipe through-holes with putty or insulating material (procured locally) to stop up all gaps, as shown in the figure.

- 1 Putty or insulating material (produced locally)

If there is any possibility that small animals enter the system through the knock-out holes, plug the holes with packing materials (field supplied).

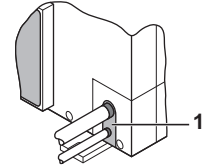

Insects or small animals entering the outdoor unit may cause a short circuit in the electrical box.

Seal knock-out holes to avoid snow and humidity entering.

### 10.2. Precautions when connecting field piping and regarding insulation

- Be careful not to let the indoor and outdoor piping come into contact with the compressor terminal cover. If the liquid-side piping insulation might come into contact with it, adjust the height as shown in the figure below. Also, make sure the field piping does not touch the bolts or outer panels of the compressor.
- When the outdoor unit is installed above the indoor unit the following can occur: The condensed water on the stop valve can move to the indoor unit. To avoid this, please cover the stop valve with sealing material.
- If the temperature is higher than 30°C and the humidity is higher than RH 80%, then the thickness of the sealing materials should be at least 20 mm in order to avoid condensation on the surface of the sealing.

- Be sure to insulate the liquid and gas-side field piping.



#### NOTICE

Any exposed piping may cause condensation.

(The highest temperature that the gas-side piping can reach is around 120°C, so be sure to use insulating material which is very resistant.)



#### DANGER

Do not touch piping and internal parts.

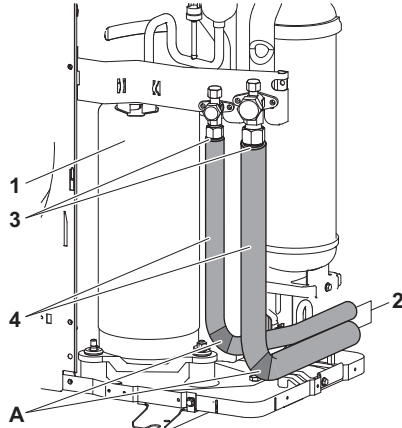

- 1 Compressor
- 2 Indoor and outdoor field piping
- 3 Sealant, etc.
- 4 Insulation material
- A Wind heat insulation material around the piping section so it is not exposed and then cover the insulation material with vinyl tape.

### 10.3. Cautions for necessity of a trap

To avoid the risk of oil held inside the riser piping flowing back into the compressor when stopped and causing liquid compression phenomenon, or cases of deterioration of oil return, it will be necessary to provide a trap at each difference in height of 10 m in the riser gas piping.

- Trap installation spacing. (See figure 6)
  - A Outdoor unit
  - B Indoor unit
  - C Gas piping
  - D Liquid piping
  - E Oil trap
  - H Install trap at each difference in height of 10 m.
- A trap is not necessary when the outdoor unit is installed at higher position than the indoor unit.

## 11. Leak test and vacuum drying

When all piping work is complete and the outdoor unit is connected to the indoor unit, it is necessary to:

- check for any leakages in the refrigerant piping
- to perform vacuum drying to remove all moisture in the refrigerant piping.

If there is a possibility of moisture being present in the refrigerant piping (for example, rainwater may have entered the piping), first carry out the vacuum drying procedure below until all moisture has been removed.

### 11.1. General guidelines

- All piping inside the unit has been factory tested for leaks.
- Use a 2-stage vacuum pump with a non-return valve which can evacuate to a gauge pressure of  $-100.7$  kPa (5 Torr absolute,  $-755$  mm Hg).
- Connect the vacuum pump to **both** the service port of the gas stop valve and the liquid stop valve to increase efficiency.



#### NOTICE

- Do not purge the air with refrigerants. Use a vacuum pump to evacuate the installation. No additional refrigerant is provided for air purging.
- Make sure that the gas stop valve and liquid stop valve are firmly closed before performing the leak test or vacuum drying.

### 11.2. Setup

(See figure 8)

- 1 Pressure gauge
- 2 Nitrogen
- 3 Refrigerant
- 4 Weighing machine
- 5 Vacuum pump
- 6 Stop valve

### 11.3. Leak test

The leak test must satisfy specification EN378-2.

- Vacuum leak test
  - Evacuate the system from the liquid and gas piping to  $-100.7$  kPa (5 Torr).
  - Once reached, turn off the vacuum pump and check that the pressure does not rise for at least 1 minute.
  - Should the pressure rise, the system may either contain moisture (refer to the paragraph "Vacuum drying") or have leaks.
- Pressure leak test
  - Break the vacuum by pressurizing with nitrogen gas to a minimum gauge pressure of 0.2 MPa (2 bar). Never set the gauge pressure higher than the maximum operation pressure of the unit, i.e. 4.0 MPa (40 bar).
  - Test for leaks by applying a bubble test solution to all piping connections.



#### NOTICE

Make sure to use a recommended bubble test solution from your wholesaler. Do not use soap water, which may cause cracking of flare nuts (soap water may contain salt, which absorbs moisture that will freeze when the piping gets cold), and/or lead to corrosion of flared joints (soap water may contain ammonia which causes a corrosive effect between the brass flare nut and the copper flare).

- Discharge all nitrogen gas.

## 11.4. Vacuum drying

To remove all moisture from the system, proceed as follows:

- 1 Evacuate the system for at least 2 hours to a target vacuum of  $-100.7$  kPa ( $= -1.007$  bar).
- 2 Check that, with the vacuum pump turned off, the target vacuum is maintained for at least 1 hour.
- 3 Should you fail to reach the target vacuum within 2 hours or maintain the vacuum for 1 hour, the system may contain too much moisture.
- 4 In that case, break the vacuum by pressurizing with nitrogen gas to a gauge pressure of  $0.05$  MPa ( $0.5$  bar) and repeat steps 1 to 3 until all moisture has been removed.
- 5 The stop valves can now be opened, and/or additional refrigerant can be charged (see "12. Charging refrigerant" on page 13).



### INFORMATION

After opening the stop valve, it is possible that the pressure in the refrigerant piping does not rise. This might be caused by e.g. the closed state of the expansion valve in the outdoor unit circuit, but does not present any problem for correct operation of the unit.

## 12. Charging refrigerant

### 12.1. Important information regarding the refrigerant used

This product contains fluorinated greenhouse gases covered by the Kyoto Protocol. Do not vent gases into the atmosphere.

Refrigerant type: R410A  
GWP(1) value: 1975

(1) GWP = global warming potential

Please fill in with indelible ink,

- ① the factory refrigerant charge of the product,
- ② the additional refrigerant amount charged in the field and
- ①+② the total refrigerant charge

on the fluorinated greenhouse gases label supplied with the product.

The filled out label must be adhered on the inside of the product and in the proximity of the product charging port (e.g. on the inside of the service cover).

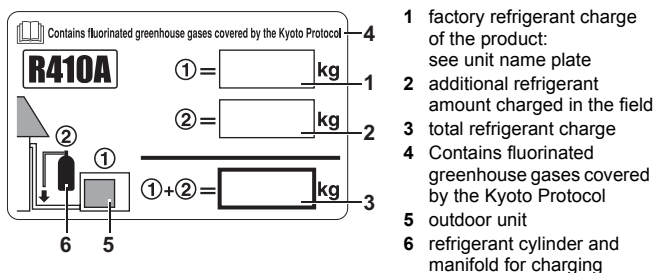

**To avoid compressor breakdown, do not charge the refrigerant more than the specified amount.**

## 12.2. Precautions and general guidelines

- When servicing the unit requires the refrigerant system to be opened, treatment and evacuation of refrigerant must be done in accordance with applicable legislation.
- Refrigerant can not be charged until field wiring has been completed.
- Refrigerant may only be charged after performing the leak test and vacuum drying (see "11. Leak test and vacuum drying" on page 12).



### CAUTION

When charging a system, care shall be taken that its maximum permissible charge is never exceeded, in view of the danger of liquid hammer.



### WARNING

- Refrigerant cylinders shall be opened slowly.
- Always use protective gloves and protect your eyes when charging refrigerant.



### DANGER

- When the power is on, please close the front panel when leaving the unit unattended.
- Charging with an unsuitable substance may cause explosions and accidents, so always ensure that the appropriate refrigerant (R410A) is charged.

- This unit requires additional charging of refrigerant according to the length of refrigerant piping connected at the site.
- Make sure to charge the refrigerant in liquid state to the liquid pipe. Since R410A is a mixed refrigerant, its composition changes if charged in its gaseous state and normal system operation would then no longer be assured.
- Before charging, check whether the refrigerant cylinder has a syphon attached or not and position the cylinder accordingly.

**Filling using a cylinder with a siphon attached**  
Charge the liquid refrigerant with the cylinder in upright position.



**Filling using a cylinder without a siphon attached**  
Charge the liquid refrigerant with the cylinder in up-side-down position.

On this model it is not necessary to charge additionally if the piping length  $\leq 30$  m.

For RZQG units only:

If the piping length  $< 5$  m: See "12.5. Total charging weight of the refrigerant (after a leak, etc.)" on page 15.



### 12.3. Calculating the additional refrigerant charge



#### NOTICE

Piping length is the one way length of liquid piping.

- The additional charging amounts relate to the refrigerant piping length as in "Maximum total one-way piping length" of the table in paragraph "8.4. Allowable pipe length and height difference" on page 8. (E.g. twin: L1+L2+L3).
- Over 30 m, please add refrigerant quantity according to following table.

For future servicing, mark with a circle the selected amount on the tables below

For pair system

**Table 1:** Additional charging of refrigerant <unit: kg>

Standard liquid pipe size				
Connected piping length is between				
Model	30~40 m	40~50 m	50~60 m	60~75 m
RZQG71	0.5	1.0	—	—
RZQG100~140	0.5	1.0	1.5	2.0
RZQSG100~140	0.5	1.0	—	—
Size up liquid pipe size				
Connected piping length is between				
Model	15~20 m	20~25 m	25~30 m	30~35 m
RZQG71	0.5	1.0	—	—
RZQG100~140	0.5	1.0	1.5	2.0
RZQSG100~140	0.5	1.0	—	—

For twin, triple, and double twin system

Please charge additional according to the following calculation. (additional amount is R1+R2)

1. G1: total length of Ø9.5 mm liquid piping  
G2: total length of Ø6.4 mm liquid piping
- 2.a G1>30 m  
calculate length over 30 m (=G1-30 m)  
Based on this length decide R1, R2 in the table
- 2.b G1≤30 m and G1+G2>30 m  
calculate total length over 30 m (=G1+G2-30 m)  
Based on this decide R2 in the table, R1=0
3. Total additional charge amount  
R=R1+R2 (kg)

**Table 2:** Length <unit: m>, additional charging of refrigerant <unit: kg>

Model	Liquid piping	Ø	Length exceeding "Chargeless length"					
			0~5	5~10	10~15	15~20	20~30	30~45
RZQG71	Main	9.5	0.5	1.0	—	—	—	
	Branch	6.4	0.3	0.6	—	—	—	
RZQG100~140	Main	9.5	0.5	1.0	1.5	2.0		
	Branch	9.5	0.5	1.0	1.5	2.0		
		6.4	0.3	0.6	0.9	1.2		
RZQSG100~140	Main	9.5	0.5	1.0	—	—		
	Branch	6.4	0.3	0.6	—	—		

#### Example 1

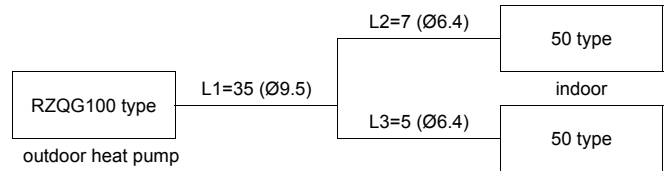

1. G1=L1=35 m      G2=L2+L3=7+5=12
2. Over 30 m
  - a G1-30=5 m      → Ø9.5 R1=0.5 kg
  - b G2=12 m      → Ø6.4 R2=0.6 kg
3. Refrigerant charge amount=R=R1+R2=0.5+0.6=1.1 kg

#### Example 2

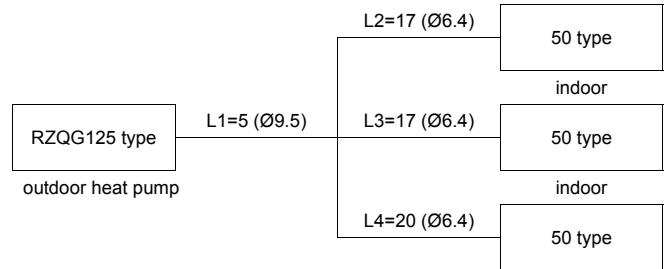

1. G1=L1=5 m      G2=L2+L3+L4=17+17+20=54
2. Over 30 m
  - a G1=5 m      → R1=0.0kg
  - b (G1+G2)-30=(5+54)-30=29      → Ø6.4 R2=0.9 kg
3. Refrigerant charge amount=R=R1+R2=0.0+0.9=0.9 kg



#### NOTICE: Systems with sized-up liquid pipe

- Replace 30 m by 15 m in calculations above and use the table below.
- G1: total length of Ø12.7 mm liquid piping.

Model	Liquid piping	Length exceeding "Chargeless length"			
		0~5	5~10	10~15	15~20
RZQG71	size-up	0.5	1.0	—	—
RZQG100~140	size-up	0.5	1.0	1.5	2.0
RZQSG100~140	size-up	0.5	1.0	—	—

## 12.4. Complete recharging



### NOTICE

Before recharging, make sure to execute vacuum drying of the internal piping of the unit as well. To do so, use the internal service port of the unit. Do NOT use the service ports located on the stop valve (see "9.3. Stop valve operation" on page 10), since vacuum drying can not be performed properly from these ports. Outdoor units have 1 port on the piping. It is between the heat exchanger and the 4-way valve.

In case complete recharging is required (after a leak, etc.), refer to the information below to determine the necessary amount of refrigerant.



### WARNING

Some sections of the refrigerant circuit may be isolated from other sections caused by components with specific functions (e.g. valves). The refrigerant circuit therefore features additional service ports for vacuuming, pressure relief or pressurizing the circuit.

In case it is required to perform **brazing** on the unit, ensure that there is no pressure remaining inside the unit. Internal pressures need to be released with ALL the service ports indicated on the figures below opened. The location is depending on mode type.

RZQG71/RZQSG100~125

RZQG100~140/RZQSG140

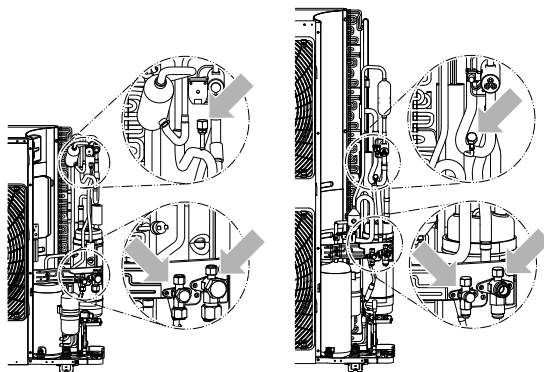

## 12.5. Total charging weight of the refrigerant (after a leak, etc.)

The total charging amounts relate to the refrigerant piping length as in "Maximum total one-way piping length" of the table in paragraph "8.4. Allowable pipe length and height difference" on page 8. (E.g. twin: L1+L2).

Table 3: Total charging amount <unit: kg>

Model	Liquid piping	Refrigerant piping length						
		5~10 m <sup>(a)(b)</sup>	10~20 m	20~30 m	30~40 m	40~50 m	50~60 m	60~75 m
RZQG71	size-down	1.9	—	—	—	—	—	—
	standard	1.9	2.4	2.9	3.4	3.9	—	—
RZQG100~140	size-down	3.0	—	—	—	—	—	—
	standard	3.0	3.5	4.0	4.5	5.0	5.5	6.0
RZQSG100+125	size-down	1.9	—	—	—	—	—	—
	standard	1.9	2.4	2.9	3.4	3.9	—	—
RZQSG140	size-down	3.0	—	—	—	—	—	—
	standard	3.0	3.5	4.0	4.5	5.0	—	—

(a) For RZQG units only: 3~10 m.

(b) For RZQG units only: When piping length is less than 5 m, a complete recharging of the unit is required. Charge the unit with the refrigerant charge as indicated.

Model	Liquid piping	Refrigerant piping length						
		3~5 m <sup>(a)</sup>	5~10 m	10~15 m	15~20 m	20~25 m	25~30 m	30~35 m
RZQG71	size-up	1.9	2.4	2.9	3.4	3.9	—	—
RZQG100~140	size-up	3.0	3.5	4.0	4.5	5.0	5.5	6.0
RZQSG100+125	size-up	—	2.4	2.9	3.4	3.9	—	—
RZQSG140	size-up	—	3.5	4.0	4.5	5.0	—	—

(a) When piping length is less than 5 m, a complete recharging of the unit is required. Charge the unit with the refrigerant charge as indicated.

## 13. Pump down operation

This unit is equipped with an automatic pump down operation which will collect all refrigerant from the field piping and indoor unit in the outdoor unit. To protect the environment, make sure to perform the following pump down operation when relocating or disposing of the unit.



### INFORMATION

For more details, refer to the applicable service manual.

	Procedure	Precaution
1	Make sure that stop valves both on liquid and on gas side are open.	—
2	Push the BS4 pumping-down operation button on the PC board of the outdoor unit (±8 seconds).	Compressor and outdoor fan will start operation automatically. The indoor unit fan may automatically start running. Please pay attention to this.
3	Close the stop valve on the liquid side securely about 2 minutes after the compressor started operation. (See "9.3. Stop valve operation" on page 10.)	Never leave the outdoor unit unattended with opened front panel when power supply is on. In case the stop valve on the liquid side is not securely closed during compressor operation, pumping-down operation cannot be executed.
4	Once compressor operation stops after 2 to 5 minutes <sup>(a)</sup> , close the stop valve on the gas side securely. (See "9.3. Stop valve operation" on page 10.)	
5	Turn off the power supply.	

(a) If after finishing pumping-down operation the outdoor unit does not operate, not even when the remote controller switch is turned on, the remote controller may or may not indicate "U4". But this is not a malfunction.

When in need of operation, turn off the main power supply and turn it on again. Make sure that stop valves both on liquid and gas side are open and be sure to operate the unit in cooling operation during test run.



### WARNING

Make sure to re-open both stop valves before restarting operation of the unit.

## 14. Electrical wiring work



### WARNING

- All wiring must be performed by an authorized electrician.
- All components procured on the site and all electric construction shall comply with the applicable legislation.



### DANGER: HIGH VOLTAGE

To avoid electrical shock, make sure to disconnect the power supply 1 minute or more before servicing the electrical parts. Even after 1 minute, always measure the voltage at the terminals of main circuit capacitors or electrical parts and, before touching, make sure that those voltages are 50 V DC or less.



### NOTICE

#### To persons in charge of electrical wiring work:

Do not operate the unit until the refrigerant piping is complete. (Running it before the piping is ready will break the compressor.)

### 14.1. Precautions on electrical wiring work



### DANGER

- Before obtaining access to terminal devices, all supply circuits must be interrupted.
- Be sure to install an earth leakage circuit breaker in accordance with applicable legislation. Failure to do so may cause electrical shock.

- Use only copper wires.
- A main switch or other means for disconnection, having a contact separation in all poles, must be incorporated in the fixed wiring in accordance with applicable legislation. Do not turn on the main switch until all the wiring is completed.
- For Y1
  - Make sure to connect power supply cables in normal phase. If connected in reverse phase, the remote controller of the indoor unit indicates "U1" and the equipment cannot operate. Change any two of the three power supply cables (L1, L2, L3) to correct phase.
  - If the contact in the magnetic switch should be forcibly turned on while the equipment is inoperative, the compressor will burn out. Never try to forcibly turn on the contact.
- Never squeeze bundled cables into a unit.
- Fix cables so that cables do not make contact with the pipes (especially on high pressure side).
- Secure the electrical wiring with cable ties as shown in the figure in chapter "14.2. Connecting power supply and inter-unit wiring" on page 16 so that it does not come in contact with the piping, particularly on the high-pressure side. Make sure no external pressure is applied to the terminal connectors.
- When installing the earth leakage circuit breaker make sure that it is compatible with the inverter (resistant to high frequency electrical noise) to avoid unnecessary opening of the earth leakage circuit breaker.
- As this unit is equipped with an inverter, installing a phase advancing capacitor not only will deteriorate power factor improvement effect, but also may cause capacitor abnormal heating accident due to high-frequency waves. Therefore, never install a phase advancing capacitor.



### CAUTION

Be sure to install the required fuses or circuit breakers.

## 14.2. Connecting power supply and inter-unit wiring

- Secure the earth wire to the stop valve attachment plate so that it does not slide.
- Secure the earth wire to the stop valve attachment plate one more time along with the electric wiring and the inter-unit wiring.
- Lay the electrical wiring so that the front cover does not rise up when doing wiring work and attach the front cover securely.

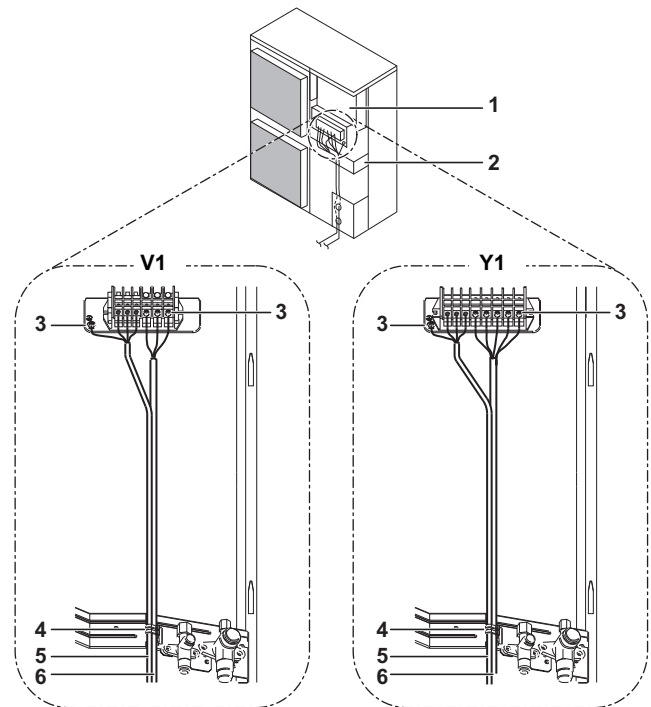

- 1 Switch box
- 2 Stop valve mounting plate
- 3 Ground
- 4 Tie-wrap
- 5 Wiring between units
- 6 Power supply and ground wiring

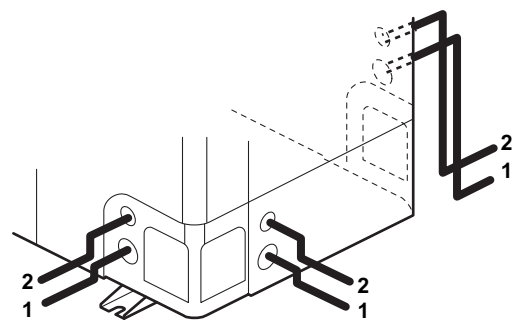

- 1 Power supply wiring and earth wire
- 2 Wiring between units

- When cables are routed from the unit, a protection sleeve for the conduits (PG-insertions) can be inserted at the knock-out hole. (See figure 7)

- 1 Wire
- 2 Bush
- 3 Nut
- 4 Frame
- 5 Hose
- A Inside
- B Outside

When you do not use a wire conduit, be sure to protect the wires with vinyl tubes to prevent the edge of the knock-out hole from cutting the wires.

- Follow the electric wiring diagram for electrical wiring works.
- Form the wires and fix the cover firmly so that the cover may be fit in properly.

### 14.3. Precautions on wiring of power supply and inter-unit wiring

- Use a round crimp-style terminal for connection to the power supply terminal board. In case it cannot be used due to unavoidable reasons, be sure to observe the following instruction.

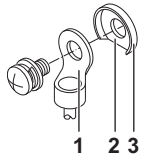

- 1 Round pressure terminal
- 2 Cut out section
- 3 Cup washer

- Do not connect wires of different gauge to the same power supply terminal. (Looseness in the connection may cause overheating.)
- When connecting wires of the same gauge, connect them according to the below figure.



- Use the correct screwdriver to tighten the terminal screws. Small screwdrivers can damage the screw head and prevent appropriate tightening.
- Over-tightening the terminal screws can damage the screws.
- See the table below for tightening torques for the terminal screws.

Tightening torque (N·m)	
M4 (X1M)	1.2~1.8
M4 (EARTH)	1.2~1.4
M5 (X1M)	2.0~3.0
M5 (EARTH)	2.4~2.9

- Refer to the installation manual attached to the indoor unit for wiring of indoor units, etc.
- Attach an earth leakage breaker and fuse to the power supply line. (See figure 9)
  - I Pair
  - II Twin
  - III Triple
  - IV Double twin
  - M Master
  - S Slave
  - 1 Earth leakage breaker
  - 2 Fuse
  - 3 Remote controller
- In wiring, make certain that prescribed wires are used, carry out complete connections, and fix the wires so that outside forces are not applied to the terminals.

### 14.4. Specifications of standard wiring components

RZQG	71V1	100V1	125V1	140V1	71Y1	100Y1	125Y1	140Y1
Minimum circuit amps (MCA) <sup>(a)</sup>	20.6	32.0	33.5	14.0	21.0	22.5		
Recommended field fuse (A)	25	40		16	25			
Wire type <sup>(b)</sup>	H05VV-U3G				H05VV-U5G			
Size	Wiring size must comply with the applicable local and national code							
Wire type of wiring between the units	H05VV-U4G2.5							

- (a) Stated values are maximum values (see electrical data of combination with indoor units for exact values).  
 (b) Only in protected pipes, use H07RN-F when protected pipes are not used.

RZQSG	100V1	125V1	140V1	100Y1	125Y1	140Y1
Minimum circuit amps (MCA) <sup>(a)</sup>	32.0	33.5	17.7	19.2	22.5	
Recommended field fuse (A)	40		20		25	
Wire type <sup>(b)</sup>	H05VV-U3G			H05VV-U5G		
Size	Wiring size must comply with the applicable local and national code					
Wire type of wiring between the units	H05VV-U4G2.5					

- (a) Stated values are maximum values (see electrical data of combination with indoor units for exact values).  
 (b) Only in protected pipes, use H07RN-F when protected pipes are not used.



#### CAUTION

- Select all cables and wire sizes in accordance with applicable legislation.
- After finishing the electrical work, confirm that each electric part and terminal inside the electric part box is connected securely.
- The earth leakage breaker must be a high-speed type breaker of 30 mA (<0.1 s).

Only for RZQ(S)G\*V1 + RZQSG100+125Y1:  
 Equipment complying with EN/IEC 61000-3-12<sup>(1)</sup>.

Only for RZQG100~140Y1 + RZQSG140Y1:

#### Point for attention regarding quality of the public electric power supply

This equipment complies with EN/IEC 61000-3-12<sup>(1)</sup> provided that the short-circuit power  $S_{sc}$  is greater than or equal to 1170 kVA at the interface point between the user's supply and the public system.

It is the responsibility of the installer or user of the equipment to ensure, by consultation with the distribution network operator if necessary, that the equipment is connected only to a supply with a short-circuit power  $S_{sc}$  greater than or equal to 1170 kVA. Above indicated value is the most stringent value. Refer to databooks for specific product-data.

(1) European/International Technical Standard setting the limits for harmonic currents produced by equipment connected to public low-voltage systems with input current >16 A and ≤75 A per phase.

## 15. Test operation



### DANGER

Never leave the unit unattended during installation or servicing. When the service panel is removed live parts can be easily touched by accident.



### INFORMATION

Note that during the first running period of the unit, required power input may be higher than stated on the nameplate of the unit. This phenomenon originates from the compressor that needs elapse of a 50 hours run in period before reaching smooth operation and stable power consumption.

### 15.1. Pre-run checks

Items to check	
Electrical wiring Inter-unit wiring Ground wire	<ul style="list-style-type: none"> <li>■ Is the wiring as mentioned on the wiring diagram? Make sure no wiring has been forgotten and that there are no missing phases or reverse phases.</li> <li>■ Is the unit properly grounded?</li> <li>■ Is the wiring between units connected in series correct?</li> <li>■ Are any of the wiring attachment screws loose?</li> <li>■ Is the insulation resistance at least 1 MΩ?               <ul style="list-style-type: none"> <li>- Use a 500 V mega-tester when measuring insulation.</li> <li>- Do not use a mega-tester for low-voltage circuits.</li> </ul> </li> </ul>
Refrigerant piping	<ul style="list-style-type: none"> <li>■ Is the size of the piping appropriate?</li> <li>■ Is the insulation material for the piping attached securely? Are both the liquid and gas pipes insulated?</li> <li>■ Are the stop valves for both the liquid side and the gas side open?</li> </ul>
Extra refrigerant	<ul style="list-style-type: none"> <li>■ Did you write down the extra refrigerant and the refrigerant piping length?</li> </ul>

- Be sure to perform a test run.
- Be sure to fully open the liquid-side and gas-side stop valves. If you operate the unit with stop valves closed, the compressor will break down.
- Be sure to execute the first test run of the installation in cooling mode operation.
- Never leave the unit unattended with an open front panel during test run.

### 15.2. Remote controller confirmation

- The settings of the remote controller for the BRC1E52 series should be made in accordance with procedure 15.3.
- The settings of the remote controller for the BRC1E51 series should be made in accordance with the procedure mentioned in the remote controller installation manual.
- The settings of the remote controller for the BRC1D series should be made in accordance with the procedure mentioned in the service manual.

## 15.3. Test run



### NOTICE

Do not interrupt the test run.

- 1 Be sure to turn power on at least 6 hours before starting operation in order to protect the compressor.
- 2 Make sure the liquid and gas stop valves are open.

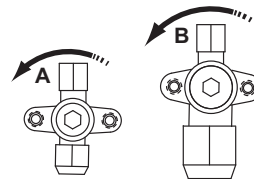

### Opening direction

- A Liquid side
  - B Gas side
- Remove the cap and turn counterclockwise with a hex wrench until it stops

- 3 Be sure to close the frontside panel before operation, as not doing so can cause electric shock.
- 4 Be sure to set the unit to cooling operation mode.



### NOTICE

- The backlight will be lit for approximately 30 seconds by pressing any operation button.
- Operate the buttons when the backlight is lit. However, On/Off can be operated directly when the backlight is not lit.

- 5 Press and hold the **Cancel** button for 4 seconds or longer.

#### <Basic screen>

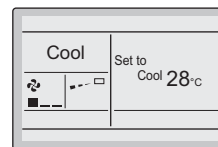

Press and hold the **Cancel** button for 4 seconds or longer during backlight lit.

The Service Setting menu is displayed

- 6 Select **Test operation** in the Service Settings menu, and press the **Menu/Enter** button.

#### <Service Settings menu screen>

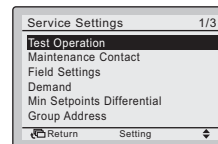

Press the **Menu/Enter** button.

The Basic screen returns and **Test operation** is displayed.

- 7 Press the **ON/OFF** button within  $\pm 10$  seconds. The test operation starts.

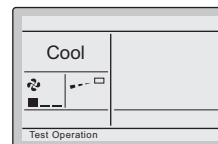

Press the **ON/OFF** button within  $\pm 10$  seconds.

Check operation condition for 3 minutes.



### INFORMATION

In case the above mentioned procedures 5 and 6 are performed in reverse order, test operation can start as well.

- 8 Press the **Fan speed/airflow direction** button.

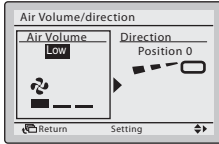

Press the **Fan speed/airflow direction** button.

The main menu screen is displayed

- 9 Select airflow direction setting by pressing the ► (right) button on the setting screen.  
Use the ▲ (up) ▼ (down) buttons to change the airflow direction.

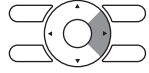

To select airflow direction setting, press the ► (right) button on the setting screen.

- 10 After the operation of airflow direction is confirmed, press the **Menu/Enter** button.

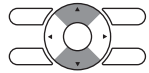
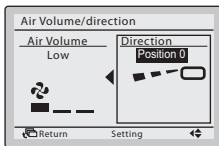

Change the airflow direction using the ▲ (up) and ▼ (down) buttons.

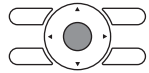

Press the **Menu/Enter** button.

The Basic screen returns.

- 11 Press and hold the **Cancel** button for 4 seconds or longer in the Basic screen.

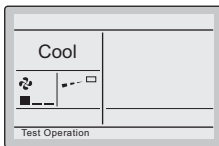

Press and hold the **Cancel** button for 4 seconds or longer during backlight lit.

The Service Settings menu is displayed.

- 12 Select **Test operation** in the Service Settings menu and press the **Menu/Enter** button.

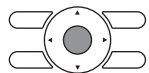
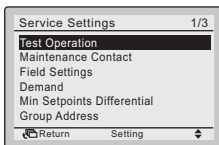

Press the **Menu/Enter** button.

The Basic screen returns and normal operation is conducted.





## 15.4. Precautions regarding test-runs

- 1 In order to detect stop valves failing to open, operation of the unit is compulsorily performed in cooling for 2-3 minutes during the first test run, even if the remote controller was set to heating operation. In this case, the remote controller will have kept displaying the heating symbol all the time and the unit will switch to heating operation automatically after elapse of that time.
- 2 In case you cannot operate the unit in test run mode for any unusual reason, refer to "15.5. Failure diagnosis at the moment of first installation" on page 19.
- 3 In case of a wireless remote controller, execute the test run only after having installed the indoor unit decoration panel with infrared receiver first.
- 4 In case the panels of indoor units are not yet installed to the indoor units, make sure to shut off the power supply after finishing the complete test run.
- 5 A complete test run surely includes shutting off power after having performed a normal operation stop on the remote controller. Do not stop operation by turning circuit breakers off.

## 15.5. Failure diagnosis at the moment of first installation

- If the malfunction code "UR" is displayed on the remote controller, there is a possibility that connection is with incompatible indoor unit.
- In case nothing is displayed on the remote controller (the currently set temperature does not display), check for any of the following abnormalities before you can diagnose possible malfunction codes.
  - Disconnection or wiring error (between power supply and outdoor unit, between outdoor unit and indoor units, between indoor unit and remote controller).
  - The fuse on the outdoor unit PCB may have run out.
- If the malfunction code "E3", "E4", "L8" or "U3" is displayed on the remote controller, there is a possibility that the stop valves are closed.
- If the malfunction code "E3", "E4", "L4" or "L8" is displayed on the remote controller, there is a possibility that air inlet or air outlet are blocked.
- If the malfunction code "U2" is displayed on the remote controller, check for voltage imbalance.
- If the malfunction code "U4" or "U5" is displayed on the remote controller, check the inter-unit branch wiring connection.
- The reversed phase protection detector of this product only works during the initialisation stage after a power reset. The reversed phase protection detector is designed to stop the product in case of an abnormality when the product is started up.
  - When the reversed phase protection circuit forced the unit to stop, check if all phases are existing. If this is the case, shut off the power supply to the unit and replace two of three phases. Turn on power again and start the unit.
  - Reversed phase detection is not performed while the product is operating.
  - In case of possible reversal of phases after a momentary black out of power and the power goes on and off while the product is operating, install a reversed phase protection circuit on site. Such situation is not unimaginable when using generators. Running the product in reversed phase can break the compressor and other parts.
- For a missing phase in case of Y1 units, "E7" or "U2" will be displayed on the remote controller of the indoor unit. Operation will be impossible with either one of these phenomena. If this happens, turn off the power, re-check the wiring and switch the position of two of the three electrical wires. (If operation is not possible, do not under any circumstances force the electromagnetic contactor on.)

## 16. Wiring diagram

	: Terminal strip		: Relay connector
	: Connector		: Terminal
	: Connection		: Noiseless earth
	: Protective earth (screw)	L	: Live
	: Field wiring	N	: Neutral
BLK	: Black	ORG	: Orange
BLU	: Blue	RED	: Red
BRN	: Brown	WHT	: White
GRN	: Green	YLW	: Yellow

- Notes**
- : This wiring diagram only applies to the outdoor unit
  - : Refer to the combination table and option manual for connecting wiring to X6A, X28A, X77A, X800M
  - : Refer to the wiring diagram sticker (on back of front plate) on how to use BS1~BS4 and DS1 switch
  - : Do not operate the unit by short-circuiting protection device S1PH
  - : Confirm the method of setting the selector switches (DS1) by service manual.  
Factory setting of all switches = "OFF".

Y1S.....	Solenoid 4-way valve
Z1C~Z7C.....	Noise filter (ferrite core)
Z1F~Z4F.....	Noise filter

A1P~A5P.....	Printed circuit board
BS1~BS4.....	Push button switch
C1~C4.....	Capacitor
DS1.....	DIP switch
E1H.....	Bottomplate heater (option)
F1U~F11U.....	Fuse
H1P~H7P.....	Light emitting diode (service monitor orange)
	H2P: prepare, test when flickering
	H2P: malfunction detection when light up
HAP.....	Light emitting diode (service monitor green)
K1M.....	Magnetic contactor
K11M.....	V1B: Magnetic contactor
K1R (A1P).....	Magnetic relay (Y1S)
K2R (A1P).....	Y1B: Magnetic relay (E1H) (option)
K2R~K4R.....	Y1B: Magnetic relay
K4R (A1P).....	V1B: Magnetic relay (E1H) (option)
K10R.....	V1B: Magnetic relay
L1R~L5R.....	Reactor
M1C.....	Motor (compressor)
M1F.....	Motor (fan) (upper)
M2F.....	Motor (fan) (lower)
PS.....	Switching power supply
Q1DI.....	Earth leakage circuit breaker (30 mA)
R1~R4.....	Resistor
R1T.....	Thermistor (air)
R2T.....	Thermistor (discharge)
R3T.....	Thermistor (suction)
R4T.....	Thermistor (heat exchanger)
R5T.....	Thermistor (heat exchanger middle)
R6T.....	Thermistor (liquid)
R10T.....	Thermistor (fin)
RC.....	V1B: Signal receiver circuit
S1PH.....	High pressure switch
TC.....	V1B: Signal transmission circuit
V1R.....	IGBT power module
V1T.....	V1B: Insulated gate bipolar transistor (IGBT)
V2R.....	V1B: Diode module
V2R.....	IGBT power module
X1M.....	Terminal (power supply) strip
X1Y.....	V1B: Optional connector
X6A.....	Y1B: Optional connector
Y1E.....	Electronic expansion valve

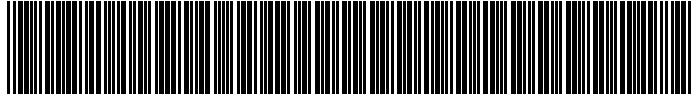

\*4P327537-1 0000000P\*

Copyright 2012 Daikin

**DAIKIN EUROPE N.V.**

Zandvoordestraat 300, B-8400 Oostende, Belgium

4P327537-1 2012.08