



ESIE15-13C



Service Manual

SkyAir

GQI-Eco Series

Heat Pump R-410A 50Hz

Smart

RZQG71~140L9V1

RZQG71~125L9Y1 / RZQG140LY1

Classic

RZQSG71L3V1 / RZQSG100~140L9V1

RZQSG100~125L8Y1 / RZQSG140LY1

www.daikineurope.com

SkyAir GQI-Eco Series Heat Pump R-410A 50Hz

1. Introduction	v
1.1 Version log	v
1.2 Safety Cautions	v
1.3 Used Icons	x
1.4 Preface	xi

Part 1 - General Information 1

1. Model Names of Indoor / Outdoor Units.....	2
2. Outlook Outdoor Units.....	4
3. Operating range	5
3.1 Smart.....	5
3.2 Classic.....	6
3.3 EDP	7

Part 2 - Remote Controller 9

1. Wired Remote Controller.....	10
1.1 Applicable Models	10
1.2 Names and Functions	10
1.3 MAIN/SUB Setting when Using 2 Remote Controllers	14
1.4 Centralized Control Group No. Setting.....	15
2. Wireless Remote Controller	17
2.1 Applicable Models	17
2.2 Names and Functions	17
2.3 MAIN/SUB Setting.....	19
3. Service Mode	20
3.1 BRC1D528	20
3.2 BRC1E52/53	22
4. Inspection Mode.....	25
4.1 BRC1D528	25
4.2 BRC1E52/53	26

Part 3 - Function and Control 27

1. Function of Main Components and Thermistors	28
2. Operation Flow Chart.....	30
2.1 Cooling / Dry Operation.....	30
2.2 Heating Operation	31
3. Function Details	32
3.1 Indoor Unit.....	32
3.2 Outdoor Unit.....	36

Part 4 - Field Setting	57
1. Test Operation	58
1.1 Pre-run Checks	58
1.2 Remote Controller Confirmation	58
1.3 Test Run	59
1.4 Precautions Regarding Test Run	59
1.5 Failure Diagnosis at the Moment of First Installation	60
2. Field Setting from Remote Controller	61
2.1 Wired Remote Controller	61
2.2 Wireless Remote Controller	66
2.3 Settings Contents and Code No. for Indoor Units	67
2.4 Overview of the Field Setting on the Outdoor Units	73
2.5 Quiet (Low Noise) Operation	74
2.6 I-Demand Function	76
2.7 Setting for Low Humidity Application	77
2.8 Defrost Start Setting	80
2.9 Slow start	80
3. Field Setting from Outdoor Unit PCB	81
3.1 Location of DIP Switch and BS Button	81
3.2 Field Setting for Outdoor Unit	82
4. Emergency Operation	92
4.1 Forced Operation	92
 Part 5 - Service Diagnosis	 95
1. Maintenance Inspection	97
1.1 Overview	97
2. Symptom-based Troubleshooting	99
2.1 Overview	99
2.2 Equipment does not Operate	100
2.3 Indoor Unit Fan Operates, but Compressor does not Operate	102
2.4 Cooling / Heating Operation Starts but Stops Immediately	104
2.5 After Unit Shuts Down, It cannot be Restarted for a While	105
2.6 Equipment Operates but does not Provide Cooling	107
2.7 Equipment Operates but does not Provide Heating	109
2.8 Equipment Discharges White Mist	111
2.9 Equipment Produces Loud Noise or Vibration	112
2.10 Equipment Discharges Dust	113
2.11 Remote Controller LCD Displays "88"	114
2.12 Swing Flap does not Operate	115
3. Troubleshooting by LED Indications	117
3.1 Troubleshooting by LED on the Indoor Unit	117
3.2 Troubleshooting by LED on Outdoor Unit PCB	117
4. Troubleshooting by Remote Controller	118
4.1 Procedure of Self-diagnosis by Remote Controller	118
4.2 Error Codes and Description	122
4.3 Safety Devices	123
4.4 Indoor Unit PCB Abnormality	124
4.5 Drain Water Level System Abnormality	125
4.6 Indoor Unit Fan Motor Abnormality	127
4.7 Capacity Setting Abnormality	128

4.8	Transmission Error (between Indoor Unit PCB and Adaptor PCB)	129
4.9	Thermistor Abnormality	131
4.10	Humidity Sensor System Abnormality	132
4.11	Malfunction of Motion Sensor / Floor Temperature Sensor.....	133
4.12	Remote Controller Thermistor Abnormality	138
4.13	Outdoor Unit PCB Abnormality.....	139
4.14	High Pressure Abnormality (Detected by the High Pressure Switch)...	140
4.15	Actuation of Pressure Sensor.....	142
4.16	Compressor Motor Lock	144
4.17	Outdoor Unit Fan Motor Abnormality.....	145
4.18	Electronic Expansion Valve Abnormality	147
4.19	Discharge Pipe Temperature Control.....	150
4.20	High Pressure Switch System Abnormality	152
4.21	Low Pressure Switch System Abnormality	153
4.22	Thermistor System Abnormality	154
4.23	Outdoor Unit PCB Abnormality.....	155
4.24	Radiation Fin Temperature Rise	157
4.25	Output Overcurrent Detection	159
4.26	Electronic Thermal (Time Lag)	161
4.27	Stall Prevention (Time Lag).....	163
4.28	Transmission System Abnormality (between Control and Inverter PCB).....	165
4.29	Open Phase or Power Supply Voltage Imbalance	166
4.30	Defective Capacity Setting	167
4.31	Refrigerant Shortage (Alert)	168
4.32	Refrigerant Shortage (Error).....	169
4.33	Power Supply Voltage Abnormality	171
4.34	Transmission Error between Indoor and Outdoor Unit.....	173
4.35	Transmission Error Between Remote Controller and Indoor Unit	176
4.36	Transmission Error between MAIN Remote Controller and SUB Remote Controller	177
4.37	Field Setting Switch Abnormality	178
4.38	“L” Address Duplication of Centralized Controller.....	180
4.39	Transmission Error Between Centralized Controller and Indoor Unit...	181
4.40	Transmission Error between Indoor and Outdoor Unit / Piping and Wiring Mismatch / Refrigerant Shortage	183
4.41	Check	185

Part 6 - Appendix 197

1.	Piping Diagrams	198
1.1	RZQG-L9V1	198
2.	Wiring Diagrams.....	199
2.1	Outdoor Unit.....	199
3.	Thermodynamic characteristic of R-410A	200
4.	Removing the switchbox	201

1. Introduction





1.1 Version log

Version history.





Version code	Description	Date
Version A	Preliminary release	November 2015
Version B	Addition of combination FUQ + RZQSG	February 2016
	New controller BRC1E53	
	Fieldsetting on outdoor PCB: setting 2-7 Reduced airflow added	
Version C	Manual also applicable for RZQG-LY1L	April 2017





1.2 Safety Cautions







Cautions and Warnings



- Be sure to read the following safety cautions before conducting repair work.
- The caution items are classified into “ **Warning**” and “ **Caution**”. The “ **Warning**” items are especially important since they can lead to death or serious injury if they are not followed closely. The “ **Caution**” items can also lead to serious accidents under some conditions if they are not followed. Therefore, be sure to observe all the safety caution items described below.
- About the pictograms
 - △ This symbol indicates the item for which caution must be exercised.
The pictogram shows the item to which attention must be paid.
 - This symbol indicates the prohibited action.
The prohibited item or action is shown in the illustration or near the symbol.
 - This symbol indicates the action that must be taken, or the instruction.
The instruction is shown in the illustration or near the symbol.
- After the repair work is complete, be sure to conduct a test operation to ensure that the equipment operates normally, and explain the cautions for operating the product to the customer.

1.2.1 Cautions Regarding Safety of Workers











 Warning	
Be sure to disconnect the power cable plug from the plug socket before disassembling the equipment for repair. Working on the equipment that is connected to the power supply may cause an electrical shock. If it is necessary to supply power to the equipment to conduct the repair or inspecting the circuits, do not touch any electrically charged sections of the equipment.	
If the refrigerant gas is discharged during the repair work, do not touch the discharged refrigerant gas. The refrigerant gas may cause frostbite.	
When disconnecting the suction or discharge pipe of the compressor at the welded section, evacuate the refrigerant gas completely at a well-ventilated place first. If there is a gas remaining inside the compressor, the refrigerant gas or refrigerating machine oil discharges when the pipe is disconnected, and it may cause injury.	
If the refrigerant gas leaks during the repair work, ventilate the area. The refrigerant gas may generate toxic gases when it contacts flames.	





 Warning	
The step-up capacitor supplies high-voltage electricity to the electrical components of the outdoor unit. Be sure to discharge the capacitor completely before conducting repair work. A charged capacitor may cause an electrical shock.	
Do not start or stop the air conditioner operation by plugging or unplugging the power cable plug. Plugging or unplugging the power cable plug to operate the equipment may cause an electrical shock or fire.	
Be sure to wear a safety helmet, gloves, and a safety belt when working at a high place (more than 2 m). Insufficient safety measures may cause a fall accident.	
In case of R-410A refrigerant models, be sure to use pipes, flare nuts and tools for the exclusive use of the R-410A refrigerant. The use of materials for R-22 refrigerant models may cause a serious accident such as a damage of refrigerant cycle as well as an equipment failure.	







 Caution	
Do not repair the electrical components with wet hands. Working on the equipment with wet hands may cause an electrical shock.	
Do not clean the air conditioner by splashing water. Washing the unit with water may cause an electrical shock.	
Be sure to provide the grounding when repairing the equipment in a humid or wet place, to avoid electrical shocks.	
Be sure to turn off the power switch and unplug the power cable when cleaning the equipment. The internal fan rotates at a high speed, and cause injury.	
Be sure to conduct repair work with appropriate tools. The use of inappropriate tools may cause injury.	
Be sure to check that the refrigerating cycle section has cooled down enough before conducting repair work. Working on the unit when the refrigerating cycle section is hot may cause burns.	





 Caution	
<p>Use the welder in a well-ventilated place. Using the welder in an enclosed room may cause oxygen deficiency.</p>	

1.2.2 Cautions Regarding Safety of Users

 Warning	
<p>Be sure to use parts listed in the service parts list of the applicable model and appropriate tools to conduct repair work. Never attempt to modify the equipment. The use of inappropriate parts or tools may cause an electrical shock, excessive heat generation or fire.</p>	
<p>If the power cable and lead wires have scratches or deteriorated, be sure to replace them. Damaged cable and wires may cause an electrical shock, excessive heat generation or fire.</p>	
<p>Do not use a joined power cable or extension cable, or share the same power outlet with other electrical appliances, since it may cause an electrical shock, excessive heat generation or fire.</p>	
<p>Be sure to use an exclusive power circuit for the equipment, and follow the local technical standards related to the electrical equipment, the internal wiring regulations, and the instruction manual for installation when conducting electrical work. Insufficient power circuit capacity and improper electrical work may cause an electrical shock or fire.</p>	
<p>Be sure to use the specified cable for wiring between the indoor and outdoor units. Make the connections securely and route the cable properly so that there is no force pulling the cable at the connection terminals. Improper connections may cause excessive heat generation or fire.</p>	
<p>When wiring between the indoor and outdoor units, make sure that the terminal cover does not lift off or dismount because of the cable. If the cover is not mounted properly, the terminal connection section may cause an electrical shock, excessive heat generation or fire.</p>	
<p>Do not damage or modify the power cable. Damaged or modified power cable may cause an electrical shock or fire. Placing heavy items on the power cable, and heating or pulling the power cable may damage the cable.</p>	
<p>Do not mix air or gas other than the specified refrigerant (R-410A / R-22) in the refrigerant system. If air enters the refrigerating system, an excessively high pressure results, causing equipment damage and injury.</p>	
<p>If the refrigerant gas leaks, be sure to locate the leaking point and repair it before charging the refrigerant. After charging refrigerant, make sure that there is no refrigerant leak. If the leaking point cannot be located and the repair work must be stopped, be sure to perform pump-down and close the service valve, to prevent the refrigerant gas from leaking into the room. The refrigerant gas itself is harmless, but it may generate toxic gases when it contacts flames, such as fan and other heaters, stoves and ranges.</p>	
<p>When relocating the equipment, make sure that the new installation site has sufficient strength to withstand the weight of the equipment. If the installation site does not have sufficient strength and if the installation work is not conducted securely, the equipment may fall and cause injury.</p>	





 Warning	
Check to make sure that the power cable plug is not dirty or loose, then insert the plug into a power outlet securely. If the plug has dust or loose connection, it may cause an electrical shock or fire.	
Be sure to install the product correctly by using the provided standard installation frame. Incorrect use of the installation frame and improper installation may cause the equipment to fall, resulting in injury.	For unitary type only 
Be sure to install the product securely in the installation frame mounted on the window frame. If the unit is not securely mounted, it may fall and cause injury.	For unitary type only 
When replacing the coin battery in the remote controller, be sure to disposed of the old battery to prevent children from swallowing it. If a child swallows the coin battery, see a doctor immediately.	

 Caution	
Installation of a leakage breaker is necessary in some cases depending on the conditions of the installation site, to prevent electrical shocks.	
Do not install the equipment in a place where there is a possibility of combustible gas leaks. If the combustible gas leaks and remains around the unit, it may cause a fire.	
Check to see if the parts and wires are mounted and connected properly, and if the connections at the soldered or crimped terminals are secure. Improper installation and connections may cause excessive heat generation, fire or an electrical shock.	
If the installation platform or frame has corroded, replace it. Corroded installation platform or frame may cause the unit to fall, resulting in injury.	
Check the grounding, and repair it if the equipment is not properly grounded. Improper grounding may cause an electrical shock.	

 Caution	
Be sure to measure the insulation resistance after the repair, and make sure that the resistance is 1 MΩ or higher. Faulty insulation may cause an electrical shock.	
Be sure to check the drainage of the indoor unit after the repair. Faulty drainage may cause the water to enter the room and wet the furniture and floor.	
Do not tilt the unit when removing it. The water inside the unit may spill and wet the furniture and floor.	
Be sure to install the packing and seal on the installation frame properly. If the packing and seal are not installed properly, water may enter the room and wet the furniture and floor.	For unitary type only 

1.3 Used Icons

Icons are used to attract the attention of the reader to specific information. The meaning of each icon is described in the table below:

Icon	Type of Information	Description
 Note:	Note	A “note” provides information that is not indispensable, but may nevertheless be valuable to the reader, such as tips and tricks.
 Caution	Caution	A “caution” is used when there is danger that the reader, through incorrect manipulation, may damage equipment, lose data, get an unexpected result or has to restart (part of) a procedure.
 Warning	Warning	A “warning” is used when there is danger of personal injury.
	Reference	A “reference” guides the reader to other places in this binder or in this manual, where he/she will find additional information on a specific topic.

1.4 Preface

Thank you for your continued patronage of Daikin products.

This is the new service manual for Daikin's Year 2017 RZQG-L & RZQSG-L series Heat Pump System.

Daikin offers a wide range of models to respond to building and office air conditioning needs. We are confident that customers will be able to find the models that best suit their needs.

This service manual contains information regarding the servicing of RZQG-L & RZQSG-L series R-410A Heat Pump System.

April, 2017

After Sales Service Division

Part 1

General Information

1. Model Names of Indoor / Outdoor Units.....	2
2. Outlook Outdoor Units.....	4
3. Operating range	5
3.1 Smart.....	5
3.2 Classic.....	6
3.3 EDP	7

1. Model Names of Indoor / Outdoor Units

Sky-Air		3x3 HH Cassette	3x3 Thin Cassette			2x2 cas-sette	2x2 cas-sette	Duct (medium ESP)				Ceil. Susp.				4W Ceiling	Wall Mount	High ESP duct	NEW Floor stand	Slim duct
MODEL NAME (current models)																				
1 Phase	3 Phase	FCQH71FVBE FCQH100FVBE FCQH125FVBE FCQH140FVBE	FCQG35FVBE FCQG50FVBE FCQG60FVBE FCQG71FVBE FCQG100FVBE FCQG125FVBE FCQG140FVBE	FFQ35B9V1B FFQ50B9V1B FFQ60B9V1B FFQ35C2VBE FFQ50C2VBE FFQ60C2VBE	FFQ35D2VBE FFQ50D2VBE FFQ60D2VBE FFQ71D2VBE FFQ100D2VBE FFQ125D2VBE FFQ140D2VBE	FHQ35CAVEB FHQ50CAVEB FHQ60CAVEB FHQ71CAVEB FHQ100CAVEB FHQ125CAVEB FHQ140CAVEB	FUQ71CVEB FUQ100CVEB FUQ125CVEB FAQ71CVEB FAQ100CVEB	FDQ125B9V3B FVQ71CVEB FVQ100CVEB FVQ125CVEB FVQ140CVEB FDX35F2VEB FDX50F2VEB FDX60F2VEB												
RZQG71L9V1	RZQG71L8Y1	P		2		2	2	2	2	2	2	2	2	2	P			P		2
RZQG100L9V1	RZQG100L8Y1	P	3	2		3	2	3	2	3	2	3	2	P			P		3	2
RZQG125L9V1	RZQG125L8Y1	P	4	3	2	4	3	4	3	4	3	4	3	P			P		4	3
RZQG140L9V1	RZQG140L7Y1	2	P	4	3	2	P	4	3	4	3	2	P	2		2			P	4

Sky-Air		3x3 HH Cassette	3x3 Thin Cassette			2x2 cas-sette	2x2 cas-sette	Duct (medium ESP)				Ceil. Susp.				4W Ceiling	Wall Mount	High ESP duct	NEW Floor stand	Slim duct
MODEL NAME (current models)																				
1 Phase	3 Phase	FCQH71FVBE FCQH100FVBE FCQH125FVBE FCQH140FVBE	FCQG35FVBE FCQG50FVBE FCQG60FVBE FCQG71FVBE FCQG100FVBE FCQG125FVBE FCQG140FVBE	FFQ35B9V1B FFQ50B9V1B FFQ60B9V1B FFQ35C2VBE FFQ50C2VBE FFQ60C2VBE	FFQ35D2VBE FFQ50D2VBE FFQ60D2VBE FFQ71D2VBE FFQ100D2VBE FFQ125D2VBE FFQ140D2VBE	FHQ35CAVEB FHQ50CAVEB FHQ60CAVEB FHQ71CAVEB FHQ100CAVEB FHQ125CAVEB FHQ140CAVEB	FUQ71CVEB FUQ100CVEB FUQ125CVEB FAQ71CVEB FAQ100CVEB	FDQ125B9V3B FVQ71CVEB FVQ100CVEB FVQ125CVEB FVQ140CVEB FDX35F2VEB FDX50F2VEB FDX60F2VEB												
RZQSG71L2/3V1		P		2		2	2	2	2	2	2	2	2	P				P		2
RZQSG100L9V1	RZQSG100L7/8Y1	P	3	2		3	2	3	2	3	2	3	2	P			P		3	2
RZQSG125L9V1	RZQSG125L7/8Y1	P	4	3	2	4	3	4	3	4	3	4	3	P			P		4	3
RZQSG140L9V1	RZQSG140L7Y1	2	P	4	3	2	P	4	3	4	3	2	P	2		2			P	4

Multi Combination Possibilities:

P = Pair	71	100	125	140
2 = Twin	35+35	50+50	60+60	71+71
3 = Triple		35+35+35	50+50+50 (*)	50+50+50 (*)
4 = Double Twin			35+35+35+35 (*)	35+35+35+35

(*) : Max Capacity depend on outdoor unit.

For EDP applications

Sky-Air		Hi Cassette	Thin Cassette			2x2 cassette			Duct (medium ESP)							Ceil. Susp.		4W Ceiling	Wall Mount	Floor Stand
MODEL NAME (current models)																				
1 Phase	3 phase	FCQH71FVBE FCQH100FVBE FCQH125FVBE FCQH140FVBE	FCQG35FVBE FCQG50FVBE FCQG60FVBE FCQG71FVBE FCQG100FVBE FCQG125FVBE FCQG140FVBE	FFQ35B9V1B FFQ50B9V1B FFQ60B9V1B FFQ35C2VBE FFQ50C2VBE FFQ60C2VBE	FFQ35D2VBE FFQ50D2VBE FFQ60D2VBE FFQ71D2VBE FFQ100D2VBE FFQ125D2VBE FFQ140D2VBE	FHQ35CAVEB FHQ50CAVEB FHQ60CAVEB FHQ71CAVEB FHQ100CAVEB FHQ125CAVEB FHQ140CAVEB	FUQ71CVEB FUQ100CVEB FUQ125CVEB FAQ71CVEB FAQ100CVEB	FDQ125B9V3B FVQ71CVEB FVQ100CVEB FVQ125CVEB FVQ140CVEB FDX35F2VEB FDX50F2VEB FDX60F2VEB												
RZQG71L9V1	RZQG71L8Y1	P		2		2	2	2	2	2	2	2	2	2	P			P		2
RZQG100L9V1	RZQG100L8Y1	2	P	4	3	2	P	4	3	4	3	2	P	4	3	2		2		P
RZQG125L9V1	RZQG125L8Y1	2	P	4	3	2	P	4	3	4	3	2	P	4	3	2		2		P
RZQG140L9V1	RZQG140LY1																			

Multi Combination Possibilities:

- P = Pair
- 2 = Twin
- 3 = Triple
- 4 = Double Twin



- Note:**
1. Individual indoor capacities are not given because the combinations are for simultaneous operation (= indoor units installed in the same room)
 2. When different indoor models are used in combination, designate the remote controller that is equipped with the most functions as the main unit.
 3. See the option list for the selection of the refnet kits that are necessary to install the combinations:
TWIN: KHRQ22M20TA or KHRQ58T
TRIPLE: KHRQ127H or KHRQ58T
DOUBLE TWIN: KHRQ22M20TA or KHRQ58T

Type of branch piping will depend on the model of indoor unit. Check the option list in the data-book for more information.

2. Outlook Outdoor Units

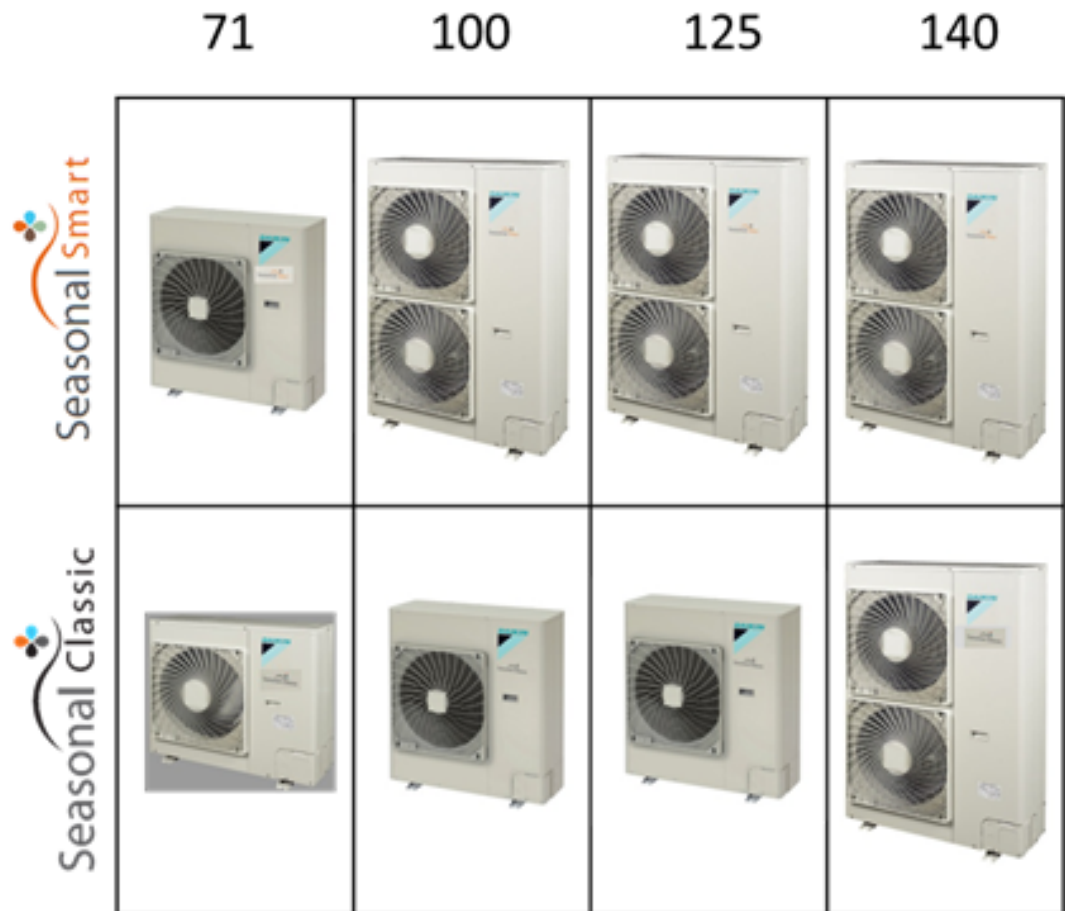

3. Operating range

3.1 Smart

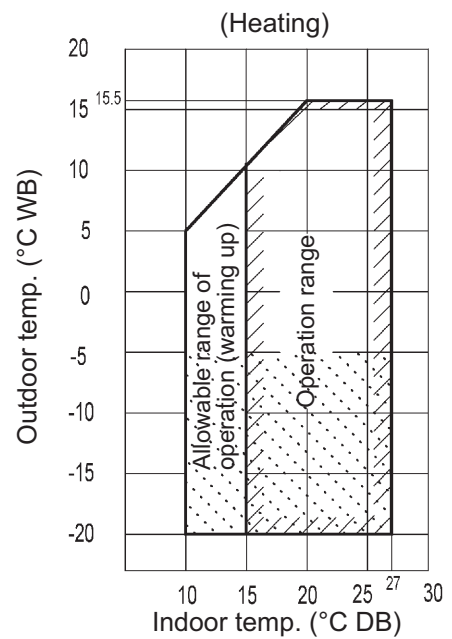
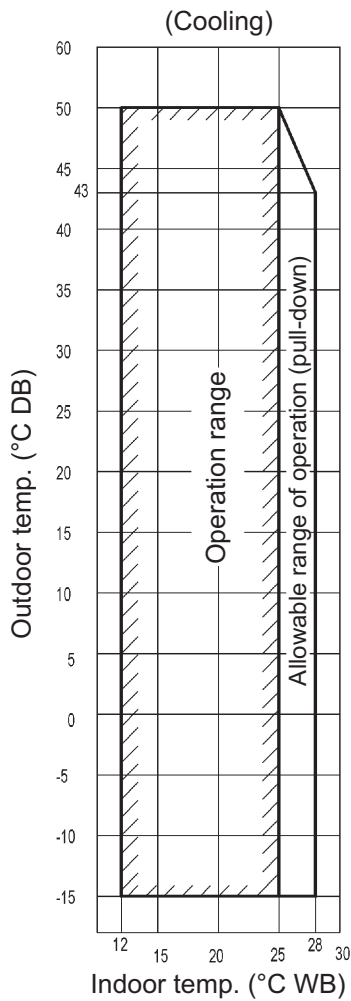

Notes:

1. Depending on operation and installation conditions, the indoor unit can change over to freeze-up operation (indoor de-icing).
2. To reduce the freeze-up operation (indoor de-icing) frequency it is recommended to install the outdoor unit in a location not exposed to wind.
3. If the unit has to operate for 5 days in this  operation range with 100% humidity, it is advisable to install the optional bottom plate heater.

3.2 Classic

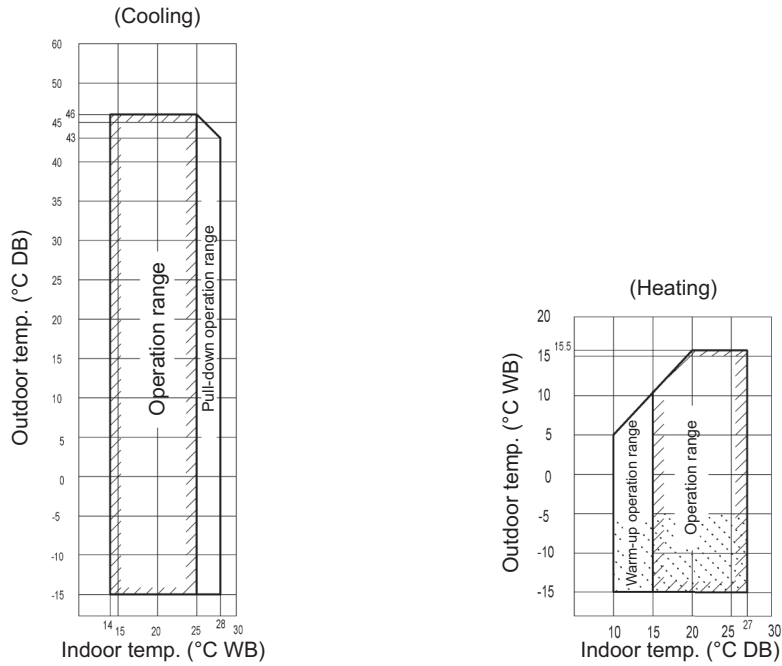

Notes:

1. Depending on operation and installation conditions, the outdoor unit can change over to defrost operation (anti freeze-up).
2. To reduce the defrost operation (anti freeze-up) frequency it is recommended to install the outdoor unit in a location not exposed to wind.
3. In case of high humidity conditions (>92%) in this  operation area, a RZQG model should be used instead of a RZQSG model. This to avoid freeze-up of the outdoor unit.

3.3 EDP

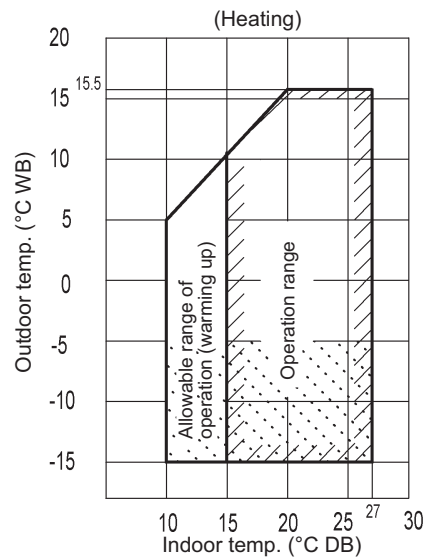
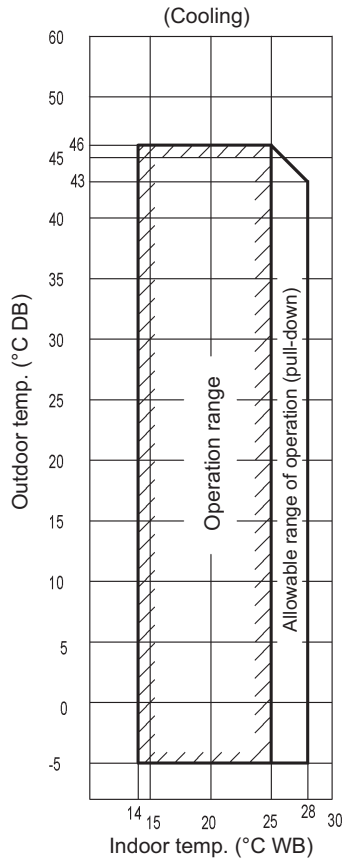

Notes:

1. Depending on operation and installation conditions, the indoor unit can change over to freeze-up operation (indoor de-icing).
2. To reduce the freeze-up operation (indoor de-icing) frequency it is recommended to install the outdoor unit in a location not exposed to wind.
3. In case of high humidity conditions (>92%) in this  operation area, a RZQG model should be used instead of a RZQSG model. This to avoid freeze-up of the outdoor unit.

Part 2

Remote Controller

1. Wired Remote Controller.....	10
1.1 Applicable Models	10
1.2 Names and Functions	10
1.3 MAIN/SUB Setting when Using 2 Remote Controllers	14
1.4 Centralized Control Group No. Setting.....	15
2. Wireless Remote Controller	17
2.1 Applicable Models	17
2.2 Names and Functions	17
2.3 MAIN/SUB Setting.....	19
3. Service Mode	20
3.1 BRC1D528	20
3.2 BRC1E52/53	22
4. Inspection Mode.....	25
4.1 BRC1D528	25
4.2 BRC1E52/53	26

1. Wired Remote Controller

1.1 Applicable Models

Model Series	FCQHG-F	FCQG-F	FFQ-C	FDXS-F	FDBQ-B	FBQ-D	FDQ-C	FDQ-B	FAQ-C	FHQ-C	FUQ-C	FNQ-A	FVQ-C
Remote Controller	BRC1D52/BRC1E52A/BRC1E52B/BRC1E53												





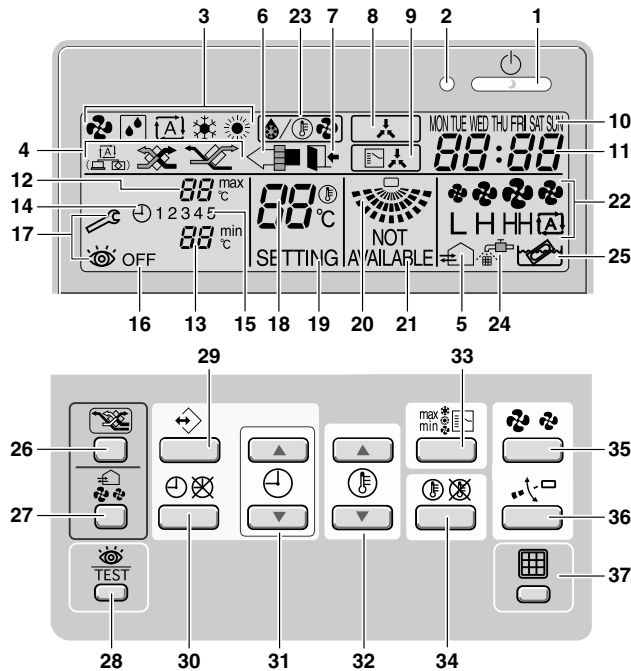











1.2 Names and Functions

1.2.1 BRC1D528



- ON/OFF BUTTON** Press the ON/OFF button to start or stop the system.
- OPERATION LAMP** The operation lamp lights up during operation or blinks if an error occurs.
- OPERATION MODE ICON** These icons indicate the current operation mode (FAN, DRY, AUTOMATIC, COOLING, HEATING).
- VENTILATION MODE ICON** These icons indicate the current ventilation mode (HRV only) (AUTOMATIC, HEAT EXCHANGE, BYPASS).
- VENTILATION ICON** The ventilation icon appears when the ventilation is adjusted with the ventilation amount button (HRV only). Simultaneously, the ventilation amount is indicated by the fan speed icon.
- AIR CLEANING ICON** This icon indicates that the air cleaning unit (option) is operational.
- LEAVE HOME ICON** The leave home icon shows the status of the leave home function.

ON	Leave home is enabled
FLASHING	Leave home is active
OFF	Leave home is disabled
- EXTERNAL CONTROL ICON** This icon indicates that another controller with higher priority is controlling or disabling your installation.
- CHANGE-OVER UNDER CENTRALISED CONTROL ICON** This icon indicates that the change-over of the installation is under centralised control assigned to another indoor unit or optional cool/heat selector connected to the outdoor unit (= Main remote controller).

10. DAY OF THE WEEK INDICATOR MON TUE WED THU FRI SAT SUN
The day of the week indicator shows the current week day (or the set day when reading or programming the schedule timer).
11. CLOCK DISPLAY 88:88
The clock display indicates the current time (or the action time when reading or programming the schedule timer).
12. MAXIMUM SET TEMPERATURE 88^{max} °C
The maximum set temperature indicates the maximum set temperature when in limit operation.
13. MINIMUM SET TEMPERATURE 88^{min} °C
The minimum set temperature indicates the minimum set temperature when in limit operation.
14. SCHEDULE TIMER ICON 
This icon indicates that the schedule timer is enabled.
15. ACTION ICONS 1 2 3 4 5
These icons indicate the actions for each day of the schedule timer.
16. OFF ICON OFF
This icon indicates that the OFF action is selected when programming the schedule timer.
17. INSPECTION REQUIRED  and 
These icons indicate that inspection is required. Consult your installer.
18. SET TEMPERATURE DISPLAY 88 °C
This indicates the current set temperature of the installation (not shown in LIMIT operation or in FAN or DRY mode).
19. SETTING SETTING
Not used, for service purposes only.
20. AIRFLOW DIRECTION ICON 
This icon indicates the airflow direction (only for installations with motorised airflow flaps).
21. NOT AVAILABLE NOT AVAILABLE
NOT AVAILABLE is displayed whenever a non-installed option is addressed or a function is not available.
22. FAN SPEED ICON L H H H H H H H
This icon indicates the set fan speed.
23. DEFROST/HOTSTART MODE ICON 
This icon indicates that the defrost/hotstart mode is active.
24. AIR FILTER CLEANING TIME ICON 
This icon indicates the air filter must be cleaned. Refer to the manual of the indoor unit.
25. ELEMENT CLEANING TIME ICON 
This icon indicates the element must be cleaned (HRV only).
26. VENTILATION MODE BUTTON 
The ventilation mode button operates the HRV; refer to the manual for more details.
27. VENTILATION AMOUNT BUTTON 
This button sets the ventilation amount; refer to the manual for more details.
28. INSPECTION/TEST OPERATION BUTTON 
Not used, for service purposes only.
29. PROGRAMMING BUTTON 
This button is a multi-purpose button.
Depending on the previous manipulations of the user, the programming button can have various functions.
30. SCHEDULE TIMER BUTTON 
This button enables or disables the schedule timer.
31. TIME ADJUST BUTTON 
These buttons are used to adjust the clock or, when in programming mode, to adjust the programmed action time. Both buttons have an auto-repeat function.
32. TEMPERATURE ADJUST BUTTONS 
These buttons are used to adjust the current setpoint or, when in programming mode, to adjust the programmed setpoint temperature (step = 1°C). Both buttons are also used to adjust the day of the week.
33. OPERATION CHANGE/MIN-MAX BUTTON 
This button is a multi-purpose button. Depending on the previous manipulations of the user, it can have following functions:
1 select the operation mode of the installation (FAN, DRY, AUTOMATIC, COOLING, HEATING)
2 toggle between minimum temperature and maximum temperature when in limit operation
34. SETPOINT/LIMIT BUTTON 
This button toggles between setpoint, limit operation or OFF (programming mode only).

35. FAN SPEED BUTTON 

This button toggles between L (Low), H (High), HH (very High),  (Automatic).

36. AIRFLOW DIRECTION ADJUST BUTTON 

This button enables to adjust the airflow direction.

37. AIR FILTER CLEANING TIME ICON RESET BUTTON 

This button is used to reset the air filter cleaning time icon.

1.2.2 BRC1E52/53

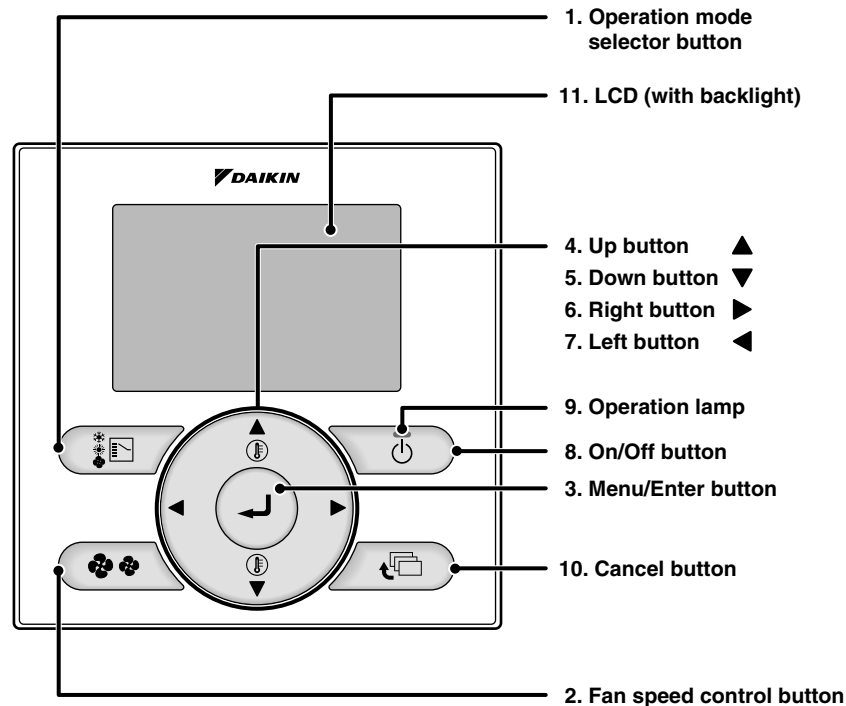

1. Operation mode selector button

- Press this button to select the operation mode of your preference.
*Available modes vary with the connecting model.

2. Fan speed control button

- Press this button to select the fan speed of your preference.
*Available fan speed vary with the connecting model.

3. Menu/Enter button

- Used to indicate the main menu.
- Used to enter the setting item selected.

4. Up button ▲ (Be sure to press the part with the symbol ▲)

- Used to raise the set temperature.
- The next items on the upper side will be highlighted.
(The highlighted items will be scrolled continuously when the button is kept pressed.)
- Used to change the item selected.

5. Down button ▼ (Be sure to press the part with the symbol ▼)

- Used to lower the set temperature.
- The next items on the lower side will be highlighted.
(The highlighted items will be scrolled continuously when the button is kept pressed.)
- Used to change the item selected.

6. Right button ► (Be sure to press the part with the symbol ►)

- Used to highlight the next items on the right-hand side.
- Each screen is scrolled in the right-hand direction.
- Home leave settings are enabled with this button kept pressed for at least four seconds.

7. Left button ◀ (Be sure to press the part with the symbol ◀)

- Used to highlight the next items on the left-hand side.
- Each screen is scrolled in the left-hand direction.
- Home leave settings are enabled with this button kept pressed for at least four seconds.

8. On/Off button

- Press this button and system will start.
- Press this button again and system will stop.

9. Operation lamp (Green)

- This lamp lights up during operation.
- This lamp blinks if an error occurs.

10. Cancel button

- Used to return to the previous screen.

11. LCD (with backlight)

- The backlight will be light for approximately 30 seconds by pressing any operation button. Operate buttons excluding the On/Off button while the backlight is lit.
- If two remote controllers are used to control a single indoor unit, the backlight of the remote controller operated earlier than the other one will be lit.

1.3 MAIN/SUB Setting when Using 2 Remote Controllers

Situation

The MAIN/SUB setting is necessary when 1 indoor unit is controlled by 2 remote controllers. When you use 2 remote controllers (control panel and separate remote controller), set one to MAIN and the other to SUB.

Setting

The remote controllers are factory set to MAIN, so you only have to change 1 remote controller from MAIN to SUB. To change a remote controller from MAIN to SUB, proceed as follows:

1.3.1 BRC1D528

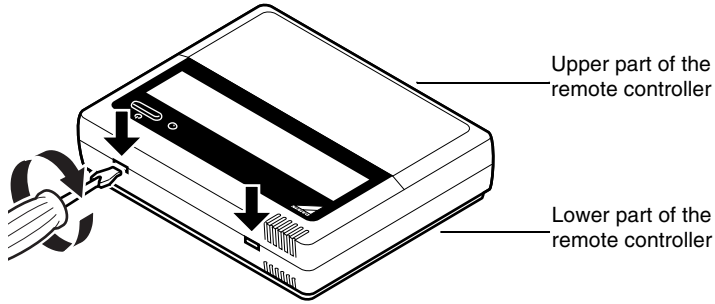
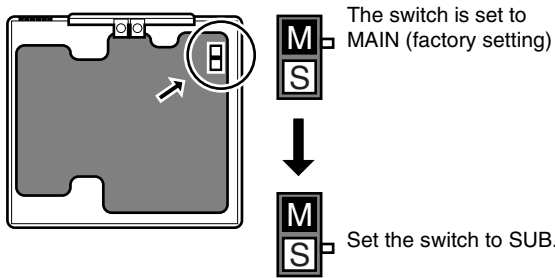
Step	Action
1	<p>Insert a flat-head screwdriver into the recess between the upper and lower part of the remote controller, as shown in the illustration below. Gently pry off the upper part of the controller, working from the 2 possible positions.</p> 
2	<p>Turn the MAIN/SUB changeover switch on the PCB to "S".</p> 

1.3.2 BRC1E52/53

The designation of the main and sub remote controllers can be swapped. Note that this change requires turning the power off and then on again.

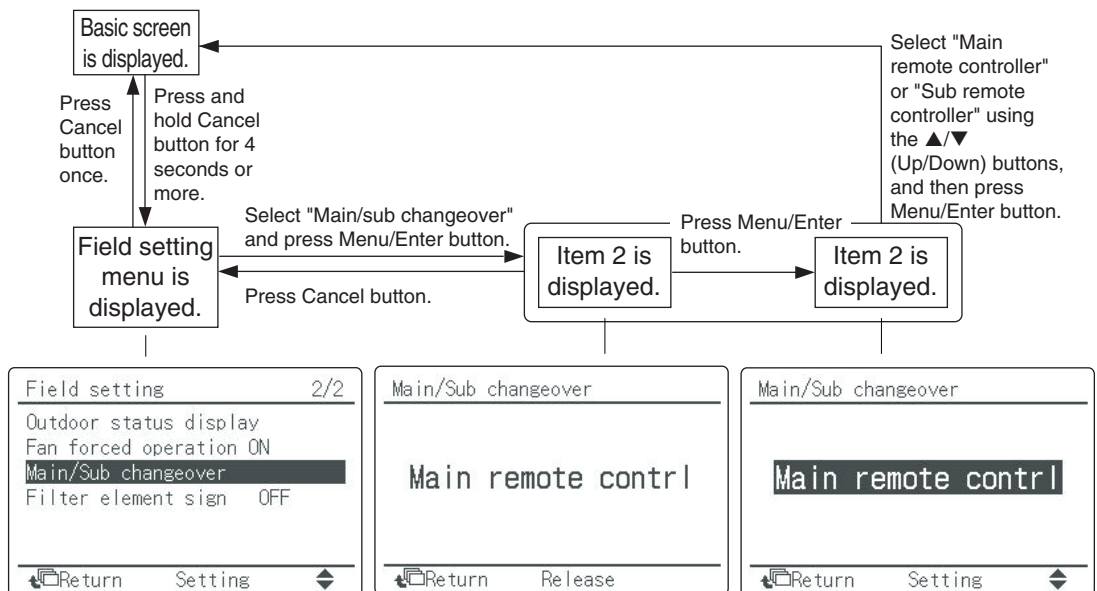







1.4 Centralized Control Group No. Setting

1.4.1 BRC1D528

In order to conduct the central remote control using the central remote controller and the unified ON/OFF controller, Group No. settings should be made by group using the operating remote controller.

Make Group No. settings for central remote control using the operating remote controller.

1. During normal mode, press and hold the “” button for 4 seconds or more to enter the "Field Setting Mode".
2. Select the Mode No. “00” with the “” button.
3. Select the Group No. for each group with the “” button.
(Group numbers increase in the order of 1-00, 1-01, ... 1-15, 2-00, ... 4-15.)
4. Press “” or “” button to set the selected Group No.
5. Press “” button to return to the normal mode.

BRC1D528

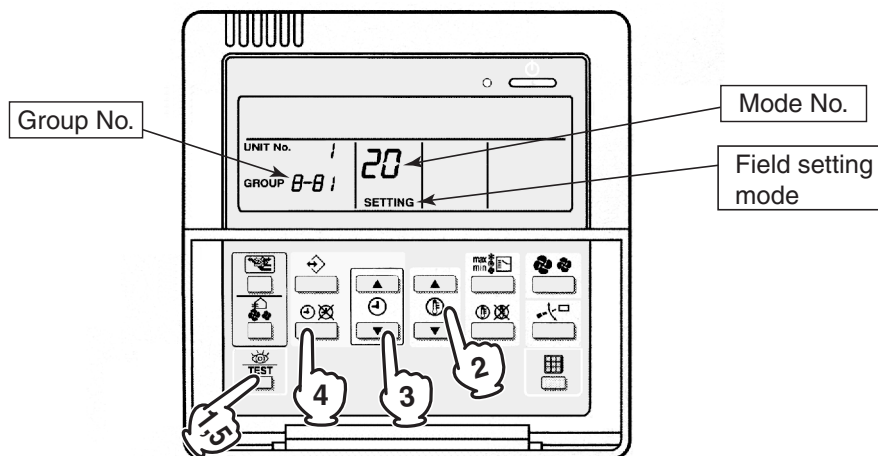

NOTICE

Enter the group No. and installation place of the indoor unit into the installation table. Be sure to keep the installation table with the operation manual for maintenance.

1.4.2 BRC1E52/53

In order to conduct the centralized remote control using the centralized remote controller and the unified ON/OFF controller, Group No. settings should be made by group using the operating remote controller.

Make Group No. settings for centralized remote control using the operating remote controller.

(1) <Basic screen>

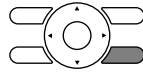
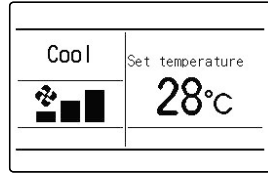

Press and hold Cancel button for 4 seconds or more. Field setting menu is displayed.

(2) <Field setting menu screen>

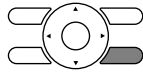
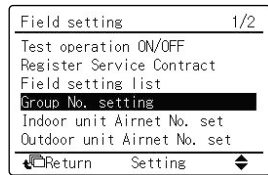

Select **Group No. setting** in the field setting menu, and press Menu/Enter button.

Group No. setting screen is displayed.

(3) <Group No. setting>

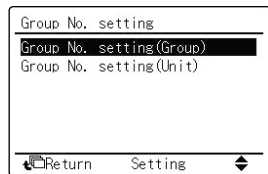

Select Group No. setting (Group), and press Menu/Enter button. Group No. setting (Group) screen is displayed.

(4) <Group No. setting (Group)>

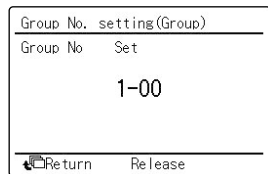

Select the group No. by using ▲▼ (Up/Down) button. Press Menu/Enter button.

NOTICE

Enter the group No. and installation place of the indoor unit into the attached installation table. Be sure to keep the installation table with the operation manual for maintenance.

2. Wireless Remote Controller

2.1 Applicable Models

Model Series	FCQHG-F FCQG-F	FHQ-C
Remote Controller	BRC7FA532F	BRC7G53

2.2 Names and Functions

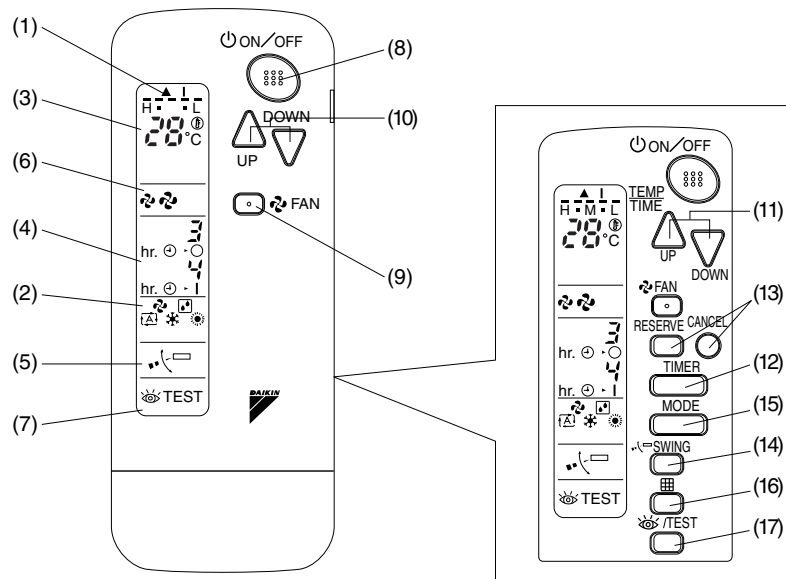





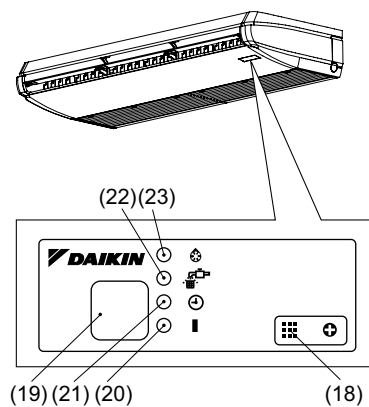











Receiver

FHQ-C



3P107422-31W

1	DISPLAY “▲” (SIGNAL TRANSMISSION)
	This lights up when a signal is being transmitted.
2	DISPLAY “ “ “ “ “” (OPERATION MODE)
	This display shows the current OPERATION MODE.
3	DISPLAY “” (SET TEMPERATURE)
	This display shows the set temperature.
4	DISPLAY “” (PROGRAMMED TIME)
	This display shows PROGRAMMED TIME of the system start or stop.
5	DISPLAY “” (AIR FLOW FLAP) Refer to page 9.
6	DISPLAY “ “ “” (FAN SPEED) The display shows the set fan speed.
7	DISPLAY “ TEST” (INSPECTION/ TEST OPERATION)
	When the INSPECTION/TEST OPERATION BUTTON is pressed, the display shows the system mode is in. Do not operate this button during normal use.
8	ON/OFF BUTTON
	Press the button and the system will start. Press the button again and the system will stop.
9	FAN SPEED CONTROL BUTTON
	Press this button to select the fan speed, Low or Middle or High, of your choice.
10	TEMPERATURE SETTING BUTTON
	Use this button for SETTING TEMPERATURE.
11	TEMPERATURE ADJUSTMENT/ PROGRAMMING TIMER BUTTON
	Use this button for temperature setting and programming “START and/or STOP” time. (Operates with the front cover of the remote controller opened.)

12	TIMER MODE START/STOP BUTTON
	Refer to page 10.
13	TIMER RESERVE/CANCEL BUTTON
	Refer to page 11.
14	AIR FLOW DIRECTION ADJUST BUTTON
	Refer to page 9.
15	OPERATION MODE SELECTOR BUTTON
	Press this button to select OPERATION MODE. “  ” (COOL), “  ” (HEAT), “  ” (AUTO), “  ” (FAN), “  ” (DRY).
16	FILTER SIGN RESET BUTTON
	Refer to the section of MAINTENANCE in the operation manual attached to the indoor unit.
17	INSPECTION/TEST OPERATION BUTTON
	This button is used only by qualified service persons for maintenance purposes.
18	EMERGENCY OPERATION SWITCH
	This switch is readily used if the remote controller does not work.
19	RECEIVER
	This receives the signals from the remote controller.
20	OPERATING INDICATOR LAMP (Red)
	This lamp stays lit while the air conditioner runs. It flashes when the unit is in trouble.
21	TIMER INDICATOR LAMP (Green)
	This lamp stays lit while the timer is set.
22	AIR FILTER CLEANING TIME INDICATOR LAMP (Red)
	Lights up when it is time to clean the air filter.
23	DEFROST LAMP (Orange)
	Lights up when the defrosting operation has started.

2.3 MAIN/SUB Setting



Introduction

To set the wireless remote controller, you have to set the address for:

- The receiver of the wireless remote controller
- The wireless remote controller.

Setting the Address for the Receiver

When using both a wired and a wireless remote controller for 1 indoor unit, the wired controller should be set to MAIN. Therefore, set the MAIN/SUB switch (SS1) of the receiver to SUB.

MAIN/SUB	MAIN	SUB
MAIN/SUB switch (SS1)		

3. Service Mode

3.1 BRC1D528

3.1.1 Display Service Data

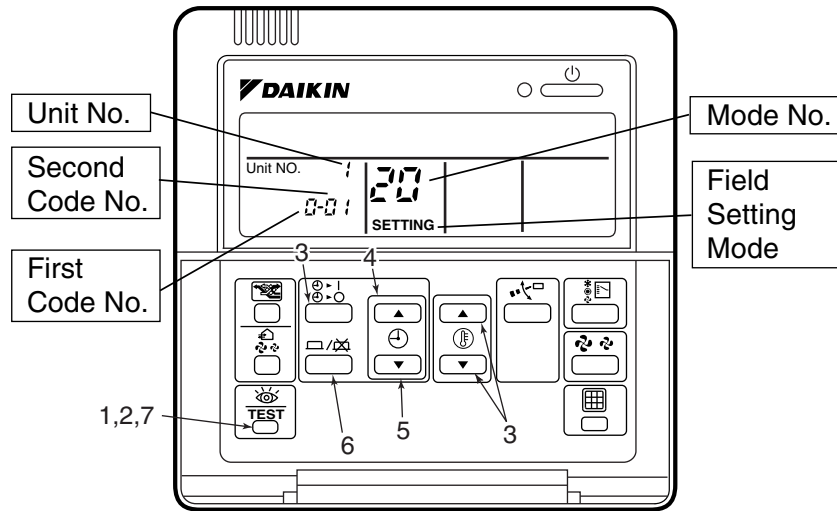



1. Enter the field setting mode.
Press the inspection / test operation button for 4 seconds or more.
2. Enter the service mode.
After having entered the field setting mode, press the inspection / test operation button for 4 seconds or more.
3. Select the mode No.
Set the desired mode No. with the up/down temperature setting button.
4. Select the unit No.
Select the indoor unit No. set with the time mode START/STOP button.
5. Select the desired error history No. or sensor data No. with or .
6. Each data displays (Refer to the table below display)
7. Return to the normal operation mode.
Press the inspection / test operation button once.

Mode No.	Function	Content and Operation Method	Example of Remote Controller Display
40	Error History	You can change the history with the programming time up-down button.	
41	Sensor Data Display	Select the display thermistor with the programming time up-down button Display thermistor 00: Remote controller thermistor 01: Suction air thermistor 02: Heat exchanger thermistor	

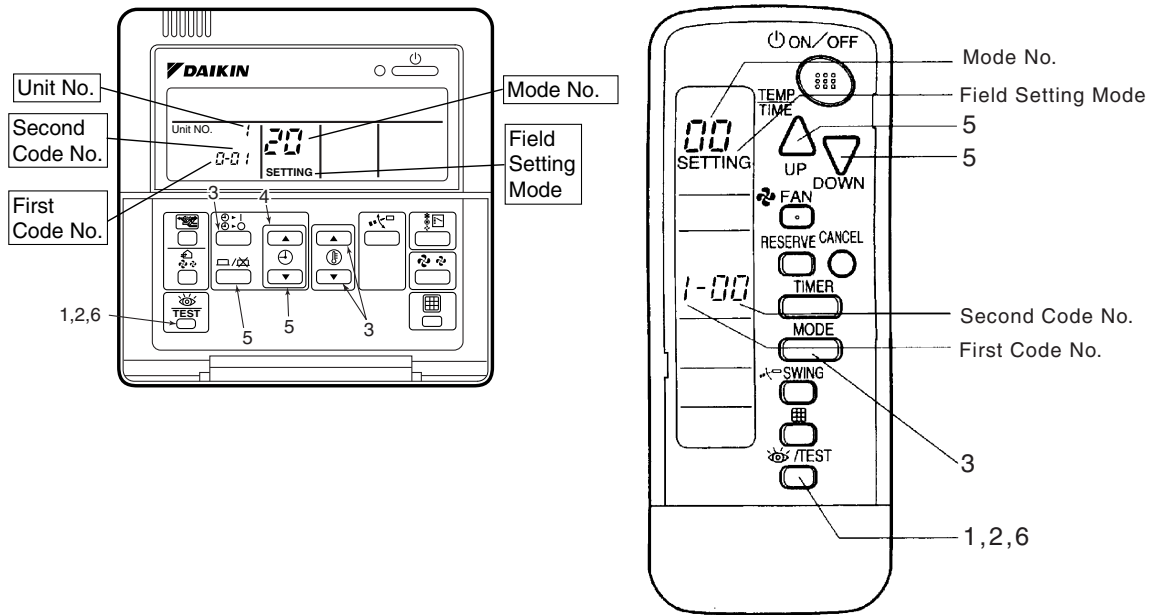
3.1.2 Service Setting

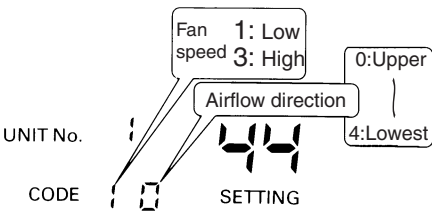
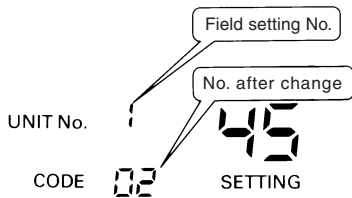

1. Enter the field setting mode.
Press the inspection / test operation button for 4 seconds or more.
2. Enter the maintenance mode.
After having entered the field setting mode, press the inspection / test operation button for a minimum of 4 seconds.
3. Select the mode No.
Set the desired mode No. with the up/down temperature setting button.
4. Select the unit No.
Select the indoor unit No. set with the time mode START/STOP button.
5. Carry out the necessary settings for each mode. (Mode 43 only possible for wireless remote controller)
 - In case of Mode 43
Press timer ON / OFF button to decide the forced Fan ON.
 - In case of Mode 44
Set "Fan speed" with fan speed control button and "Air flow direction" with air flow direction adjusting button, then press timer ON / OFF button to decide.
 - In case of Mode 45
Select the changed unit No. with  or  button, then press timer ON / OFF button to decide.
6. Return to the normal operation mode.
Press the inspection / test operation button 1 time.

Mode No.	Function	Content and Operation Method	Example of Remote Controller Display
43	Forced Fan ON	Turns the fan ON for each unit individually.	
44	Individual Setting	Sets fan speed and air flow direction for each unit individually when using group control. Settings are made using the "air flow direction adjust" and "fan speed adjust" buttons.	
45	Unit No. Change	Changes unit No. Set the unit No. after changing with the programming time up-down button.	

3.2 BRC1E52/53

3.2.1 Display service data

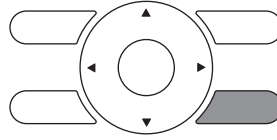

Press and hold Cancel button for 4 seconds or longer during backlight lit.



Select "Field setting list"

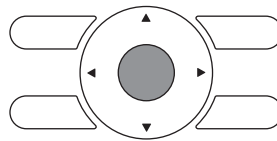
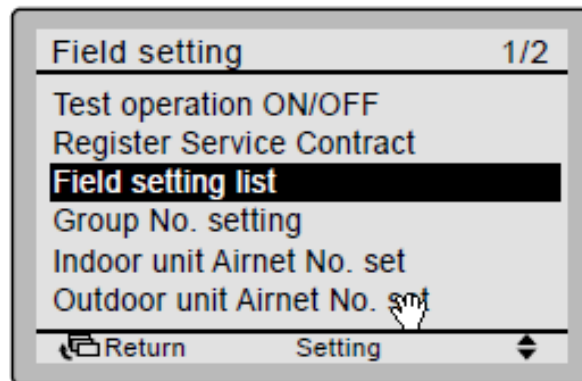

Press Menu/Enter button.



In the case of setting per indoor unit during group control (When Mode No. such as 20, 21, 22, 23, 25 are selected), highlight the unit No. and select "Indoor unit No." to be set by using ▲▼ (Up/Down) button. (In the case of group total setting, this operation is not needed.)

**In the case of individual
setting per indoor unit**

Field setting list			
Unit No	Mode		
0	20		
0-01	1-00	2-00	3-00
4—	5—	6—	7—
8—	9—	a—	b—
Return		Setting	

[In the case of individual setting per indoor unit, current settings are displayed. And, SECOND CODE NO. “-” means no function.]

Highlight SECOND CODE NO. of the FIRST CODE NO. to be changed, and select desired “SECOND CODE NO.” by using the ▲▼ (Up/Down) button. Multiple identical mode number settings are available.

In the case of group total setting

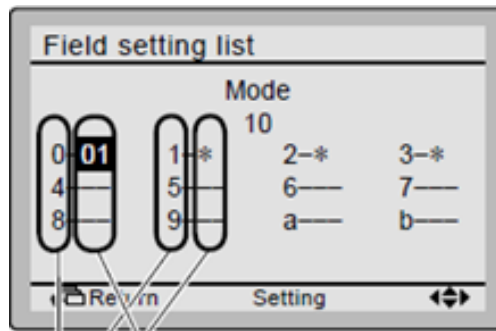

SECOND CODE NO.

FIRST CODE (SW) NO.

[In the case of group total setting, all of SECOND CODE NO. which may be set are displayed as “*”. “*” is changed to SECOND CODE NO. to be set. And, SECOND CODE NO. “-” means no function.]

Press Menu/Enter button. Setting confirmation screen is displayed.

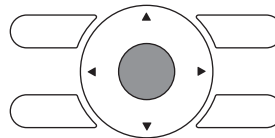

Press Menu/Enter button.

Select Yes and press Menu/Enter button. Setting details are determined and field setting list screen returns.

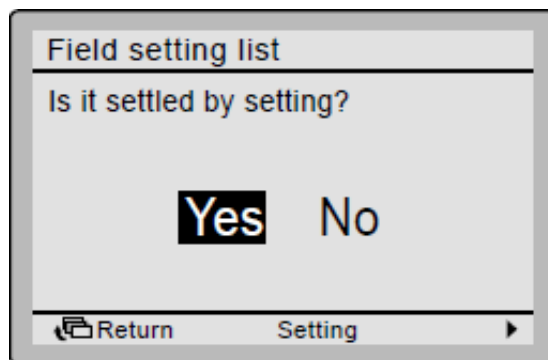

After all setting changes are completed, press Cancel button twice.

4. Inspection Mode

4.1 BRC1D528

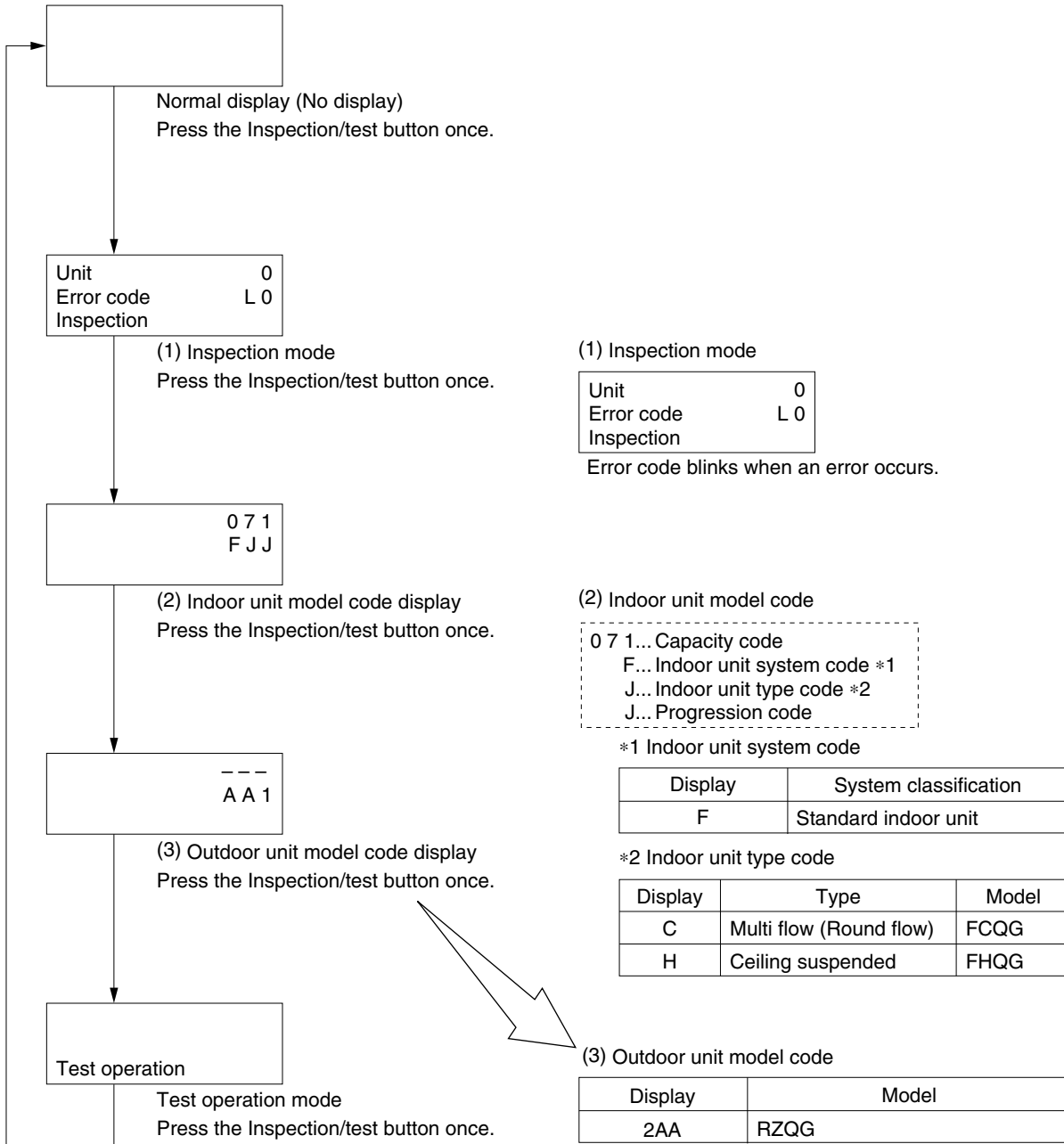

Note:
Inspection mode is not available for BRC1E51A7

4.2 BRC1E52/53

If an error occurs, either one of the following items will blink in the basic screen.

“Error: Press Menu Button.”

* The operation indicator will blink.

“Warning: Press Menu Button.”

* The operation indicator will not blink.

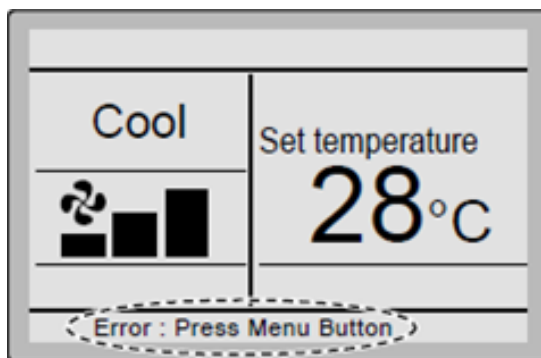

Press Menu/Enter button.

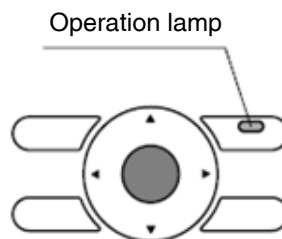

The error code blinks and the contact address and model name will appear.

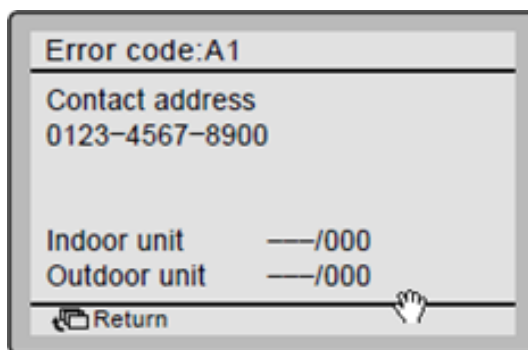

Part 3

Function and Control

- 1. Function of Main Components and Thermistors28
- 2. Operation Flow Chart30
 - 2.1 Cooling / Dry Operation30
 - 2.2 Heating Operation31
- 3. Function Details32
 - 3.1 Indoor Unit32
 - 3.2 Outdoor Unit36

1. Function of Main Components and Thermistors

RZQG-L9V1

Pair application

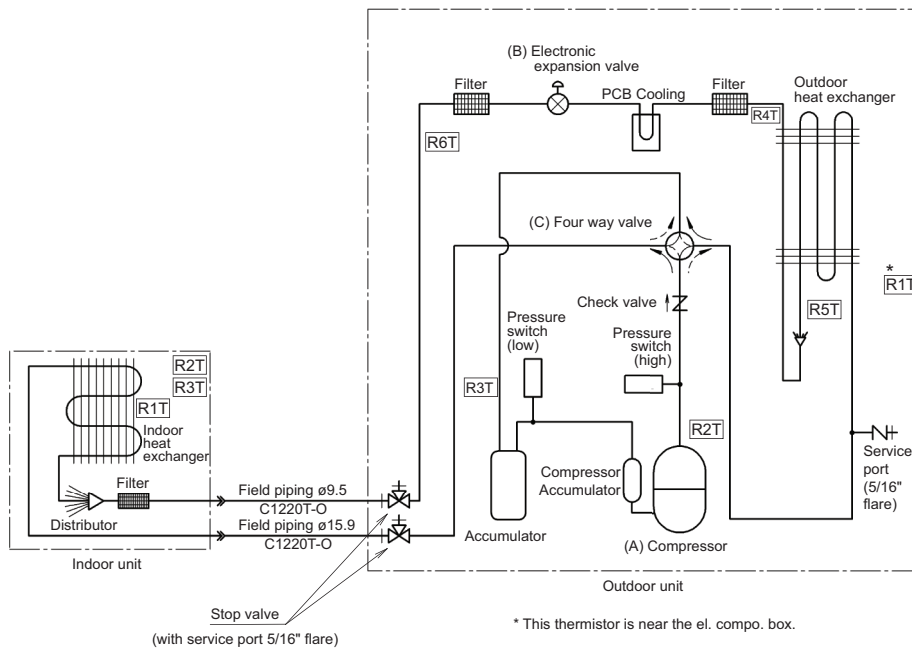

Notes:

1. The pipes between the branch and the indoor units should have the same size as the indoor connections.
2. The check valve is only present in following models: RZQG71L, RZQSG100L and RZQSG125L.

■ **Outdoor Unit**

(A) Compressor (M1C)

Inverter drive unit varies compressor operating frequency to control capacity and other factors.

(B) Electronic Expansion Valve (Y1E)

Provides control to maintain optimum operating condition for high efficiency.

(C) Four Way Valve (Y1S)

Changes operation of cooling / heating.

- * Coil energized: heating
- Coil not energized: cooling

Outdoor Air Thermistor (R1T)

Used for startup condition control and defrost control.

Discharge Pipe Thermistor (R2T)

Used for discharge temperature protection during compression operation.

Suction Pipe Thermistor (R3T)

Used for suction super heat control by electronic expansion valve.

Heat Exchanger Distributor Pipe Thermistor (R4T)

- Used for calculation of outdoor heat exchanger subcooling during cooling operation.
- Used for judgement of the defrost IN and OUT condition.

Intermediate Heat Exchanger Thermistor (R5T)

Used for calculation of high pressure during cooling operation. (Calculate Pc by detected temperature and R-410A refrigerant characteristics)

Liquid Pipe Thermistor (R6T)

Used for calculation of indoor unit heat exchanger subcooling during heating operation.

Radiation Fin Thermistor (R10T)

- Used for outdoor fan speed control.
- Used for inverter radiation fin temperature control.
- Used for pressure difference control.

■ **Indoor Unit**

R1T	Suction air thermistor
R2T R3T	Heat exchanger thermistor

Indoor Suction Air Thermistor

- Cooling:
- Thermostat control
 - PMV control
 - General frequency control
- Heating:
- Thermostat control
 - PMV control
 - General frequency control

Indoor Heat Exchanger Thermistor

- Cooling:
- Compressor frequency control (target Te)
 - Inverter current protection control
 - Freeze-up control
- Heating:
- Compressor frequency control (target Tc)
 - Inverter current protection control
 - Hot start control
 - Peak cut-off

2. Operation Flow Chart

2.1 Cooling / Dry Operation

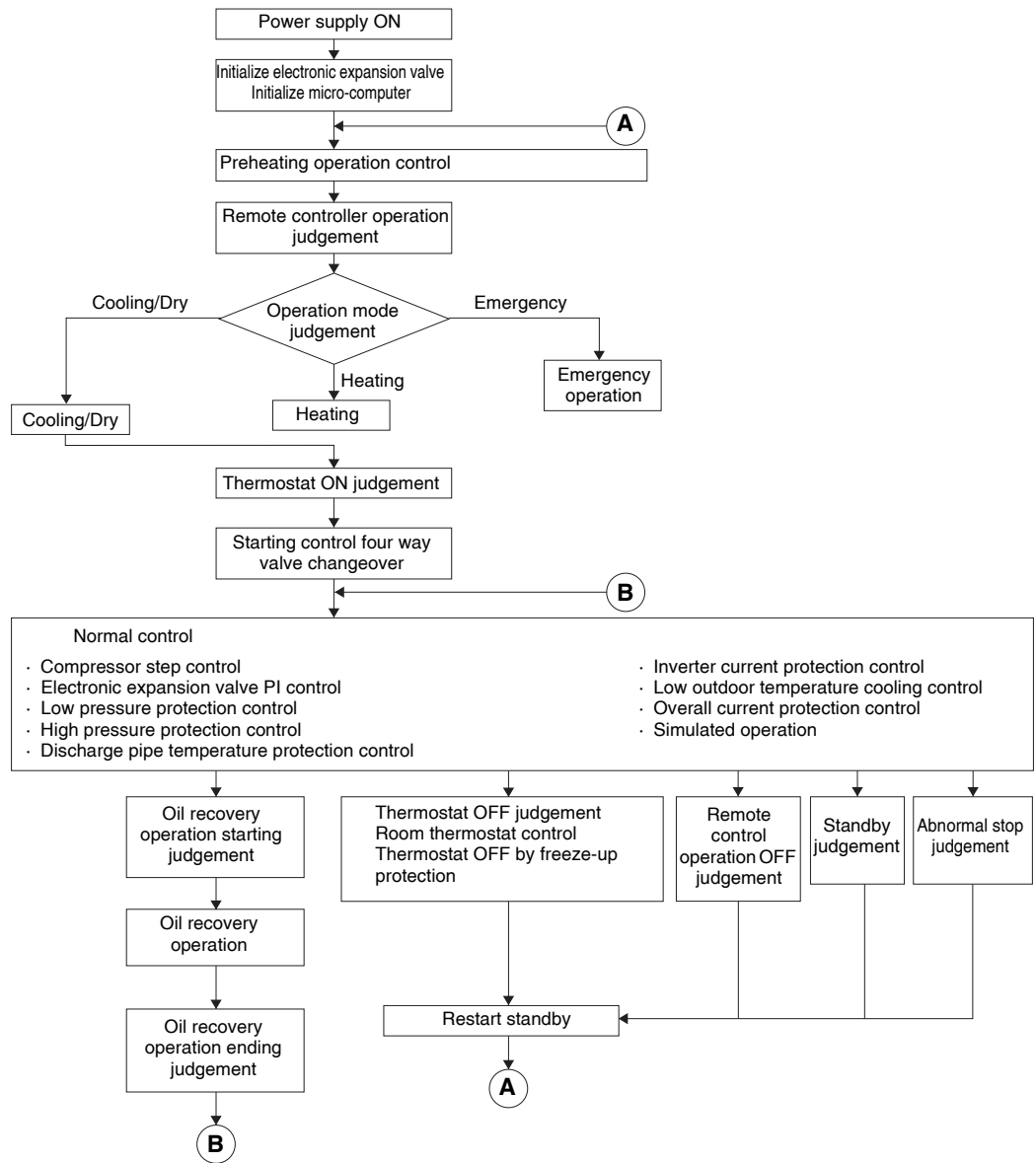

2.2 Heating Operation

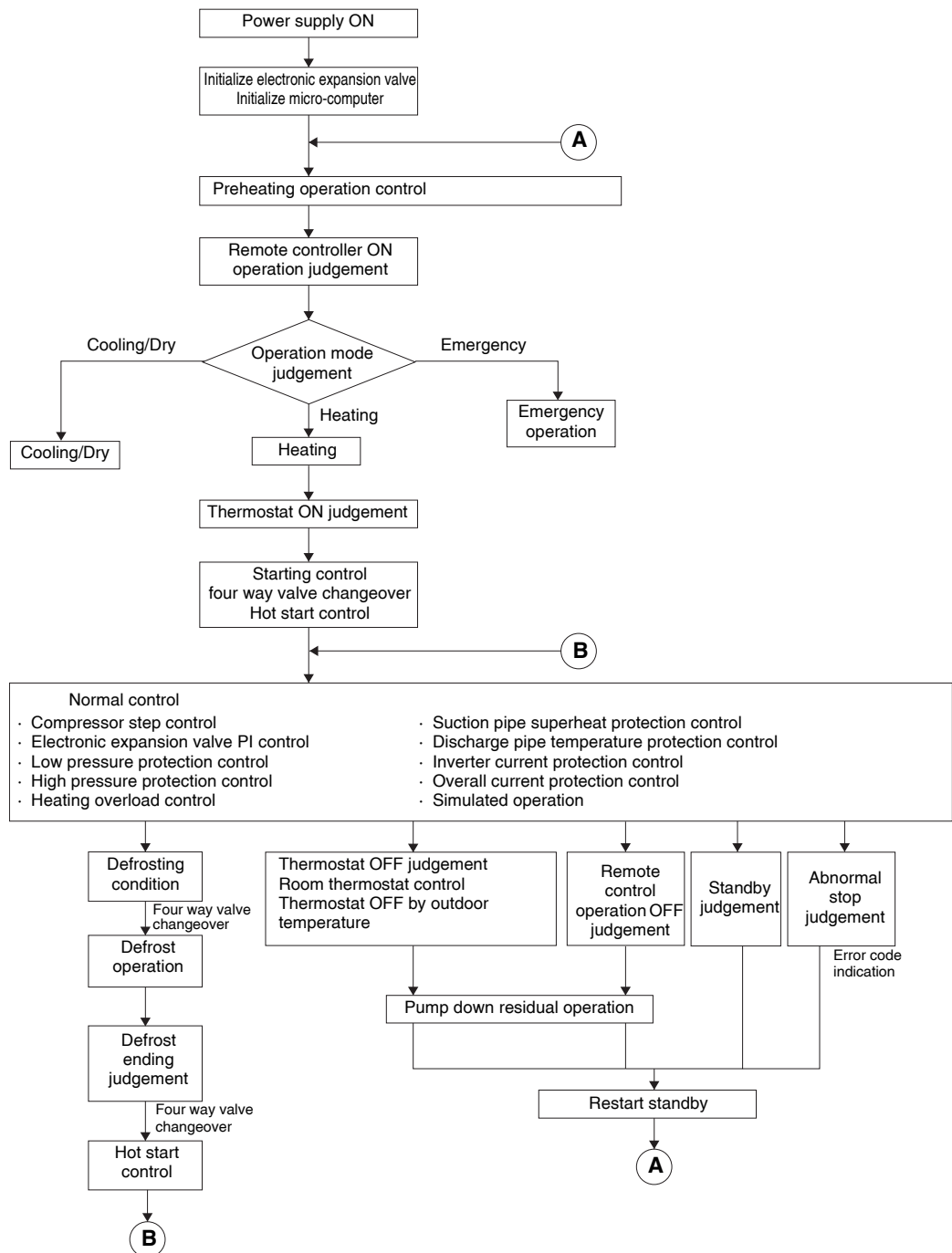

3. Function Details

3.1 Indoor Unit

3.1.1 Set Temperature and Control Temperature

The relationship between "Set temperature by remote controller" and "Control target temperature" is as shown below.

		14	15	16	17	18	19	20	21	22	23	24	25	26	27	28	29	30	31	32	33	34	35°C
Cooling	Set temperature by remote controller											●			●								
	Control target temperature											●			●								
Heating	Set temperature by remote controller										●	●											
	Control target temperature											●											

The ● mark indicates the "Control target temperature" (°C) as an example when the "Set temperature by remote controller" is set there.

3.1.2 Thermostat Control

According to a difference between the temperature set by the remote controller and the actually detected room temperature (*1), the thermostat is turned ON or OFF.

- ΔT: Detected room temperature - Temperature set by remote controller
- Tro: Room temperature detected when dry operation is started
- Tr: Room temperature detected by thermistor

● **In normal operation**
In cooling

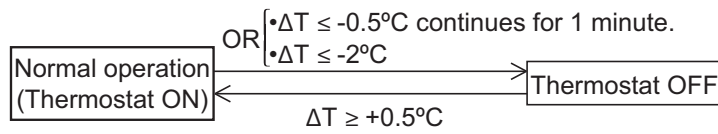

In heating

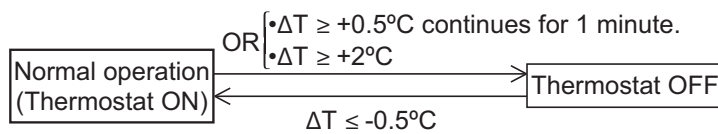

● In dry operation

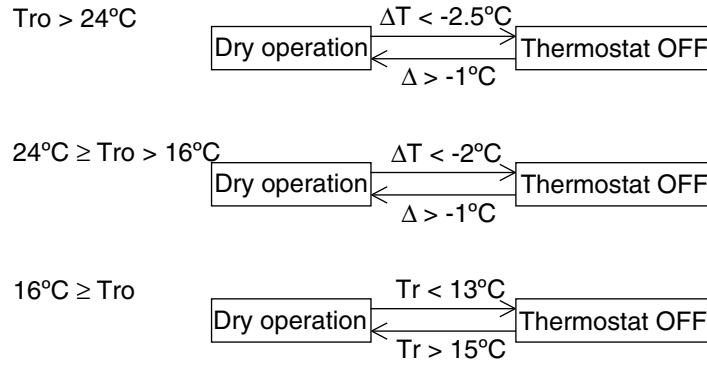

Note: *1: The thermistor to detect room temperature is as follows according to field setting.
 · Factory setting: Indoor unit suction air thermistor
 · When set to remote controller thermistor: Indoor air thermistor in the remote controller

3.1.3 Switchable Fan Speed

The setting airflow rate when the thermo. is turned on and off by operation mode is as shown below. The airflow rate when the thermo. is turned off can be changed in field setting. The table below shows the factory setting.

		Fan
Cooling	Thermostat ON	Set
	Thermostat OFF	Set
Program Dry	Thermostat ON	L
	Thermostat OFF	OFF
Heating	Thermostat ON	Set
	Thermostat OFF	LL
Fan		Set
Stop		OFF

3.1.4 Swing Pattern Selection

Swing flaps operate as shown in the table below.

			Fan
Cooling	Flap Set	Thermostat ON	Set
		Thermostat OFF	Set
	Swing Set	Thermostat ON	Swing
		Thermostat OFF	Swing
Program Dry	Flap Set	Thermostat ON	Set
		Thermostat OFF	Set
	Swing Set	Thermostat ON	Swing
		Thermostat OFF	Swing
Heating	Flap Set	Thermostat ON	Set
		Thermostat OFF	Horizontal
	Swing Set	Thermostat ON	Swing
		Thermostat OFF	Horizontal
Fan		Flap Set	Set
Stop		Swing Set	Swing

3.1.5 Drain Pump Control (Only for FCQG & FCQHG)

■ Cooling / Dry Operation
 Normally drain pump ON (Thermostat ON/OFF)

■ Heating

When the following condition consists by mounting the adaptor for wiring PCB, the drain pump is turned on.

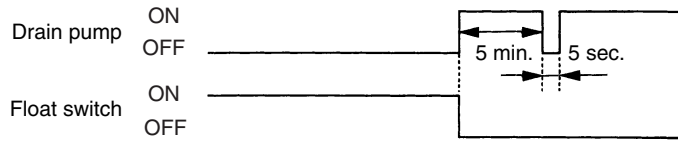

3.1.6 Control when the Operation Mode is Set to “Auto”

Setting the operation mode to “Auto” with the remote controller, the unit is controlled regarding the contents shown below.

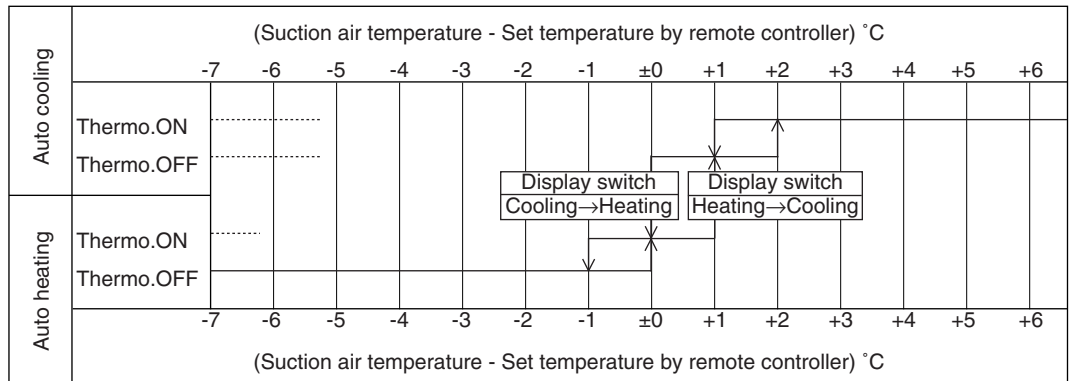

3.1.7 Dew Condensation Prevention Control

■ FCQG & FCQHG

When indoor unit humidity is high during the operation, the moving range of louvers is limited.

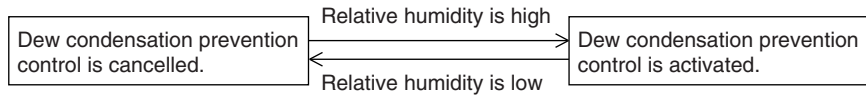

The operation of louvers while this control is activated is as shown below.

Indoor unit	Setting of louvers	Dew Condensation Prevention Control	
		Cancelled	Activated
<p>Position of louvers (when viewed from horizontal direction)</p>	P0	P0	P1
	P1	P1	P1
	P2	P2	P2
	P3	P3	P3
	P4	P4	P4
	Swing	P0~P4	P1~P4

■ FHQG

In cooling and dry operation, the following control is carried out in order to prevent dew condensation when the horizontal blade blows air downward.

Starting condition

- & (
 - Horizontal blade is set to downward flow (P3 or P4)
 - Cooling operation (compressor operation) continues for 30 minutes.

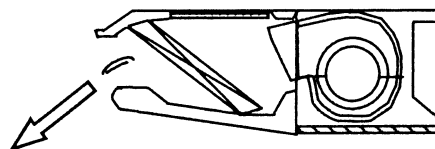

Dew condensation prevention control

Dry operation with horizontal airflow is carried out for 1 hour. (P2)

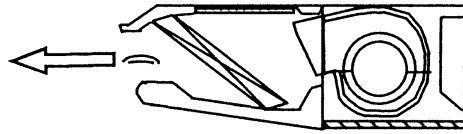

Note: 1. When there is any change to heating/fan modes, airflow direction and operation ON/OFF state during dew condensation prevention control, this control is reset.

3.1.8 Freeze-up Prevention Control

The unit will perform the forced thermostat off function in following conditions:

Thermostat off due to freeze-up prevention.

Based on the judgement to prevent the indoor heat exchanger from freezing, the thermostat is forcibly turned OFF.

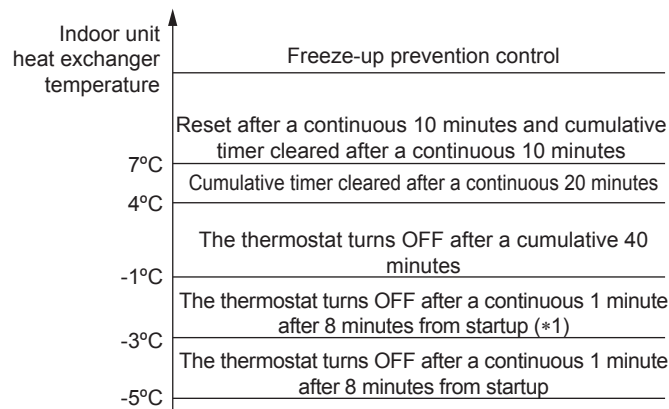

*1 FHQG Only

3.1.9 Monitoring Control

When the indoor unit fan is turned off while the thermo. for cooling, heating and drying is off, even if the indoor unit temperature recovers afterwards and becomes the one that turns the thermo. on, the thermistor cannot detect indoor unit temperature because the suction air thermistor of indoor unit is installed inside the machine.

In order to prevent such a condition, this monitoring control has the function of detecting indoor unit temperature by operating the fan at certain intervals when the fan is turned off while the thermo. is off.

3.1.10 Defrost Control

When the heating operation continues at a low outdoor air temperature, the frost adhered to the surface of outdoor heat exchanger deteriorates heating capacity.

When the amount of adhered frost exceeds a certain level, the operation will automatically switch to the cooling cycle to melt the frost.

When the frost is melted, the normal heating operation will be resumed.

3.1.11 Draft Avoidance Control

In order to prevent cold wind from directly blowing to the user when the indoor heat exchanger temperature is low, such as the timing that heating started and defrost ended, this control has the function of changing the airflow rate to LL tap and fixing the airflow direction to horizontal.

3.2 Outdoor Unit

3.2.1 Abnormal Stop

When the following items show abnormal values, the thermostat turns OFF and error is determined based on the number of retry in order to protect the compressor and other devices.

Item	Criteria	Number of retry
Low pressure	LPS activated or 0.12 MPa or less continues for 5 minutes	6 times in 200 minutes
High pressure	HPS activated or over 3.92 MPa continues for 1 minute	15 times in 300 minutes
Discharge pipe temperature	RZQG71L Temperature over 110°C continues for 15 minutes or temperature exceeds 125°C	10 times in 200 minutes
	RZQG100-140L Temperature over 110°C continues for 10 minutes or temperature exceeds 120°C	
Power supply	Negative-phase-sequence power	None (No retry)

3.2.2 Restart Standby

To prevent compressor from frequent ON/OFF and equalize pressure in refrigerant line, conducts forced thermostat OFF for 3 minutes after compressor stopping. Moreover, outdoor unit fan conducts residual operation for a period of time to expedite equalization and prevent refrigerant from entering in evaporator.

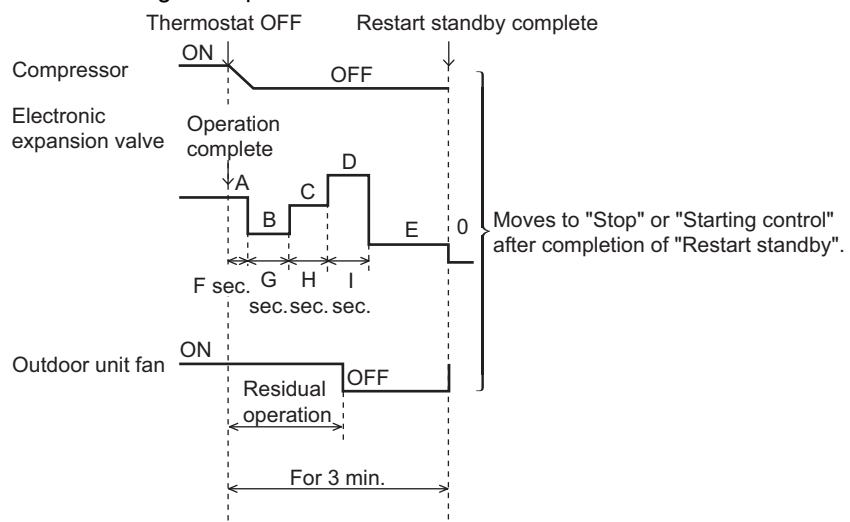

	RZQG71L	RZQG100-140L	
		Cooling	Heating
A	480	480	200
B	480	480	200
C	480	480	200
D	480	480	200
E	480	480	200
F	60	10	10
G	60	30	30
H	30	30	30
I	30	30	30

3.2.3 Preheating Operation Control

After the compressor has been turned OFF, the preheating operation control will be activated in order to avoid refrigerant from dissolving in the compressor oil and quick increase of heating level during the heating operation.

Starting Conditions

- & (
 - Compressor stopping
 - or (
 - 6 hours or less after turning ON the power.
 - & (
 - 1 hour or more after turning OFF the compressor.
 - Outdoor air temperature is not declining.
 - Discharge pipe temperature < 40°C

Ending Conditions

- & (
 - Operation of thermostat is established.
 - or (
 - 6 hours or more after turning ON the power.
 - or (
 - 1 hour or less after turning OFF the compressor.
 - Outside temperature is declining.
 - Discharge pipe temperature > 43°C

3.2.4 Outdoor Unit Fan Control during Heating Thermostat OFF

In order to prevent the false detection of outdoor suction temperature while the heating thermo. is off (excluding the timing when the remote controller is off), the outdoor unit fan is turned on and off at certain intervals.

Starting condition: Outdoor air temperature > 25°C

Ending condition: Outdoor air temperature < 20°C

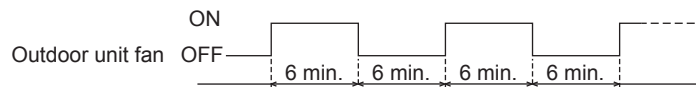

3.2.5 Starting Control

When compressor start up, the starting frequency is fixed for specified period of time at low frequency to prevent returning of refrigerant.

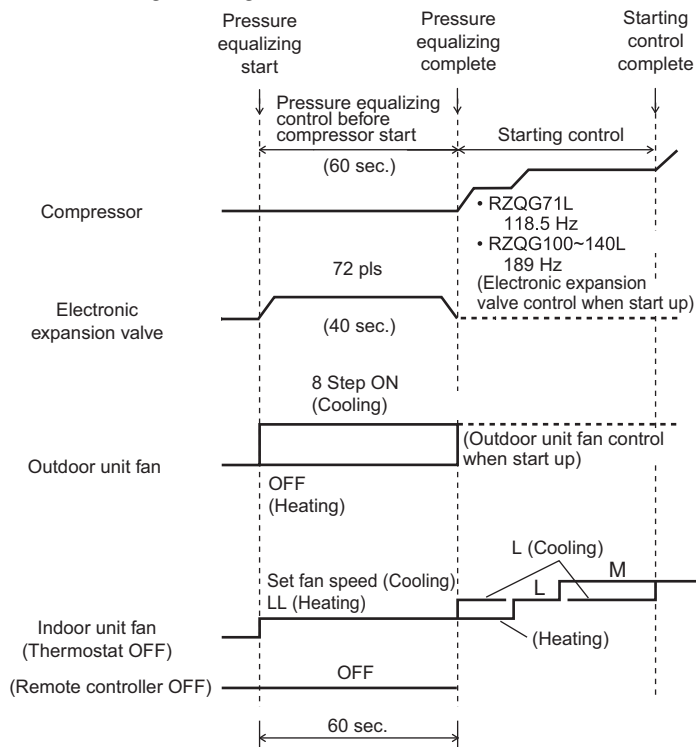

3.2.6 Room Thermostat Control

Based on the difference between the set temperature by remote controller and indoor unit suction air temperature, the thermo. is turned on and off.

$\Delta T = \text{Indoor suction air temperature} - \text{temperature set by remote controller (Cooling)}$

$\Delta T = \text{Temperature set by remote controller} - \text{indoor suction air temperature (Heating)}$

Thermostat ON Condition

$\Delta T > +0.5^\circ\text{C}$

Thermostat OFF Condition

or $\left(\begin{array}{l} \bullet \& \left(\begin{array}{l} \bullet \Delta T \leq -0.5^\circ\text{C} \text{ continues for 1 minute} \\ \bullet 5 \text{ minutes or more after start up} \end{array} \right) \\ \bullet \Delta T \leq -2^\circ\text{C (Cooling)} \\ \bullet \Delta T \leq -2.5^\circ\text{C (Heating)} \end{array} \right.$
When changed suddenly from $\Delta T \geq +1.5^\circ\text{C}$ to $\Delta T \geq -0.5^\circ\text{C}$

3.2.7 Compressor Step

The compressor operation frequency is controlled in order to keep a constant evaporation temperature in cooling and a constant condensing temperature in heating.

Cooling

Δt cool = Remote controller set temperature - Indoor return air temperature.

Depending on Δt cool and the cooling load, the target evaporating temperature will be a value between 2°C and 20°C.

Heating

Δt heat = Indoor return air temperature - Remote controller set temperature.

Depending on Δt heat and the heating load, the target condensing temperature will be a value between 42°C and 54°C. (for RZQG100-140L: 42°C and 50°C)

Compressor frequency						
Motor pole	RZQG71L7V1	RZQG71L7Y1	RZQSG100-125L7V1	RZQSG100-125L7Y1	RZQ100-140L7V1/Y1	RZQSG71L2V1
	2YC63SXD	2YC63PXD	2YC63SXD	2YC63PXD	2YC90AXD/CXD	2YC63DXD
	6 poles	4 poles	6 poles	4 poles	6 poles	6 poles
1	57	38	57	38	54	57
2	61.5	41	63	42	58.5	61.5
3	66	44	69	46	64.5	66
4	72	48	78	52	70.5	72
5	78	52	87	58	78	78
6	85.5	57	97.5	65	85.5	85.5
7	93	62	109.5	73	94.5	93
8	102	68	124.5	83	103.5	100.5
9	109.5	73	139.5	93	111	109.5
10	118.5	79	156	104	118.5	118.5
11	127.5	85	168	112	127.5	127.5
12	136.5	91	183	122	138	136.5
13	145.5	97	192	128	148.5	145.5
14	151.5	101	204	136	162	154.5
15	154.5	103	216	144	174	163.5
16	174	116	228	152	189	174
17	183	122	237	158	204	183
18	192	128	246	164	220.5	192
19	201	134	255	170	234	201
20	211.5	141	265.5	177	249	211.5
21	222	148	282	188	261	222
22	232.5	155	297	198	274.5	232.5
23	243	162	309	206	289.5	—
24	253.5	169	327	218	327	—
25	265.5	177	—	—	—	—
26	277.5	185	—	—	—	—
27	289.5	193	—	—	—	—

: Maximum frequency in cooling

3.2.8 General Electronic Expansion Valve Control

When cooling/heating, PI control of electronic expansion valve is conducted to keep the heat exchanger outlet subcooling degree constant.

- Target heat exchanger outlet subcooling degree > actual heat exchanger outlet subcooling degree
→ The electronic expansion valve will close.
- Target heat exchanger outlet subcooling degree < actual heat exchanger outlet subcooling degree
→ The electronic expansion valve will open.
- * The value of target heat exchanger outlet subcooling degree varies depending on change of discharge pipe superheat degree of inverter compressor, etc.

3.2.9 Hot Start Control (Only in Heating Operation)

In heating, when performing a startup, or after the defrosting cycle has been completed, the indoor fan will be controlled in order to prevent cold air draft and secure the starting performance (quick pressure build-up).

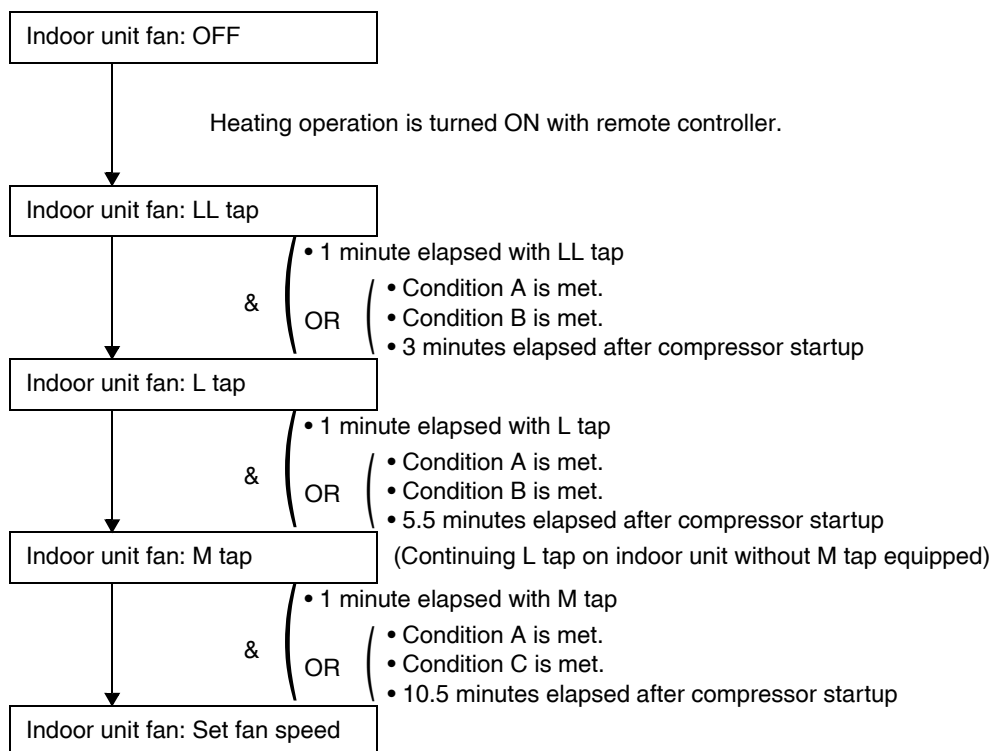

Condition	
A	Indoor unit heat exchanger temperature > 34°C
B	Indoor unit heat exchanger temperature > indoor suction air temperature +17°C (+12°C if outdoor air temperature is < 5°C)
C	Indoor unit heat exchanger temperature > indoor suction air temperature +22°C (+20°C if outdoor air temperature is < 5°C)

3.2.10 Night-time Quiet Operation

A. Setting by Remote Controller

Night-time quiet operation can be set by field setting from the wired remote controller. By estimating current time based on the change of outdoor air temperature, the low noise operation is automatically performed at night (from 22:00 to 8:00) by limiting the number of revolutions of outdoor unit fan and the operation frequency of the compressor. (The time at night is target.)

B. Setting by Demand Operation (Option)

Short circuit between COM-LNOP on terminal of demand adaptor.
Low sound running to be done with limited outdoor fan speed compressor running frequency.



Note: In the case of capacity priority setting
Setting the "Capacity priority setting" from the field setting mode of indoor remote controller, the capacity is prioritized in the operations of both A and B, and when the air conditioning load becomes high, the low noise operation stops and the normal operation starts. If you cancel the capacity priority setting when the low noise setting remains, the low noise setting is prioritized, and even if air conditioning load becomes high, the noise operation continues.

3.2.11 Low Pressure Protection Control

In order to prevent abnormal low pressures in the system, the below control function will be activated.

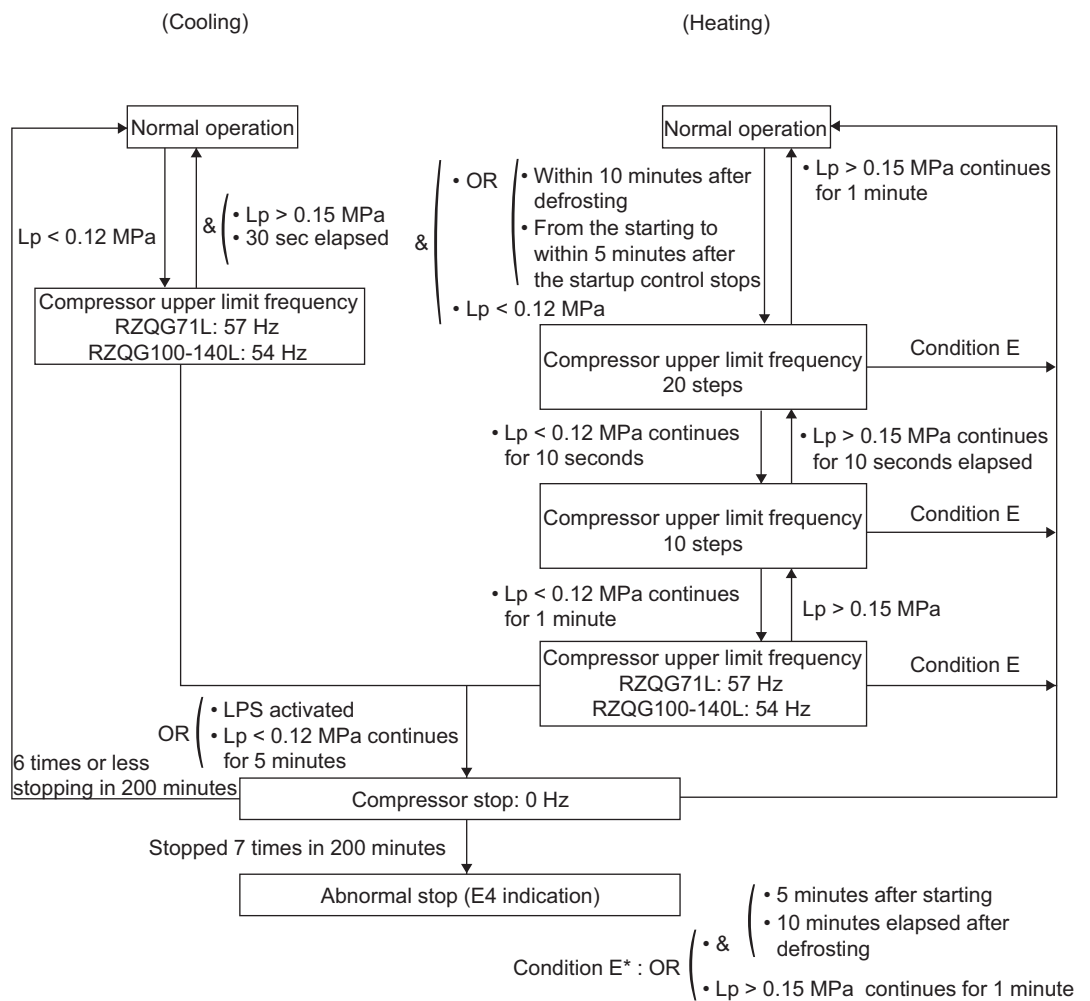

3.2.12 High Pressure Protection Control

In order to prevent abnormal high pressures in the system and hence avoiding activation of the high pressure safety device the below control function will be activated.

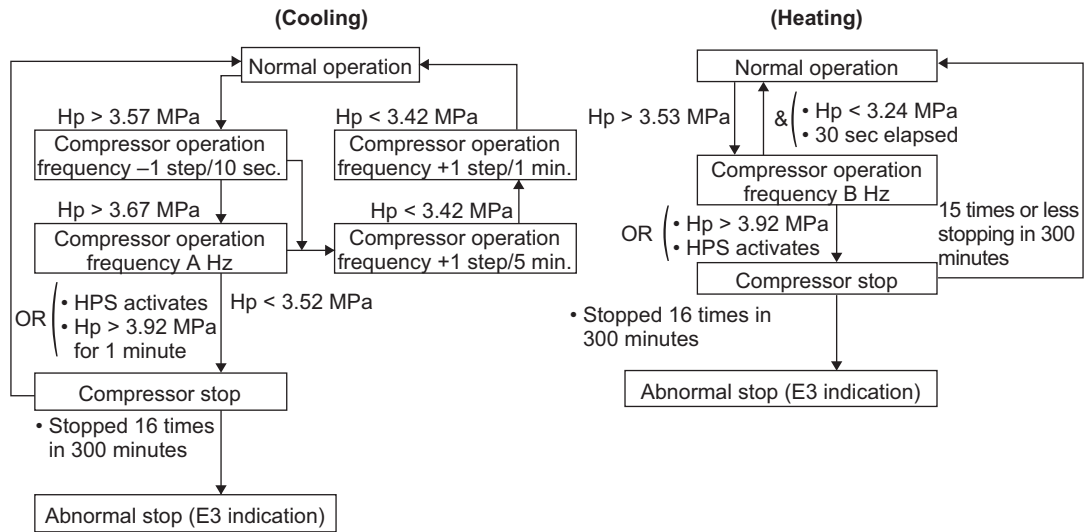

	RZQG71L	RZQG100-140L
A Hz	118.5 Hz	94.5 Hz
B Hz	57 Hz	94.5 Hz

3.2.13 Heating Control at High Outdoor Air Temperature

Under the condition of heating overload, control the outdoor unit fan in order to secure the difference of elevation pressure and the pressure ratio of the compressor.

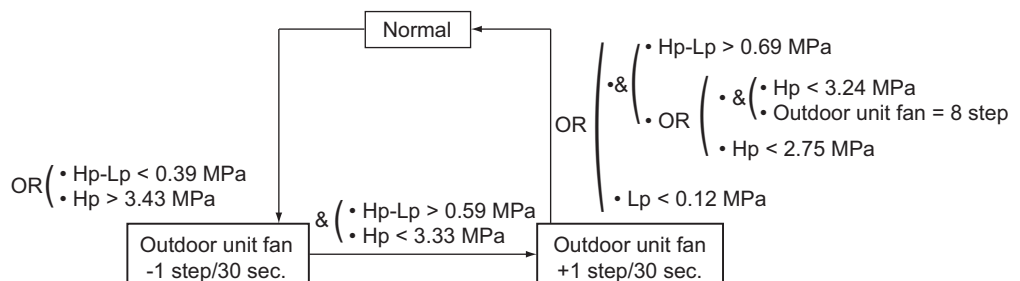

3.2.14 Suction Pipe Superheat Protection Control (Only in Heating Operation)

In case the suction superheat value in heating mode is too high, the oil return to the compressor will be insufficient. In order to avoid that the compressor oil will be accumulated in the outdoor unit heat exchanger, the upper limit frequency will be controlled.

SH: Superheat degree

EV: Electronic expansion valve

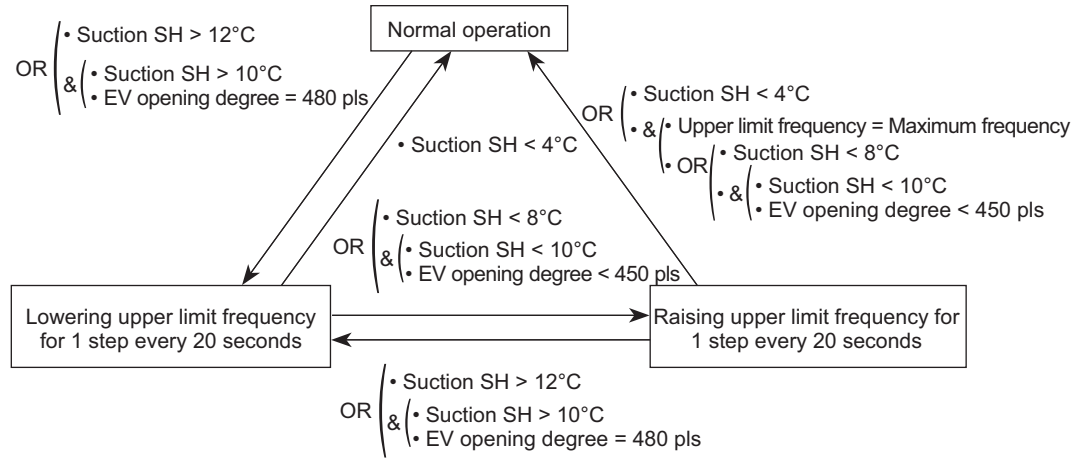

3.2.15 Discharge Pipe Temperature Protection Control

Electronic expansion valve opening degree and the compressor operating frequency will be controlled in order to avoid abnormal high compressor temperatures.

Td: Discharge pipe temperature

Compressor Operating Frequency Control

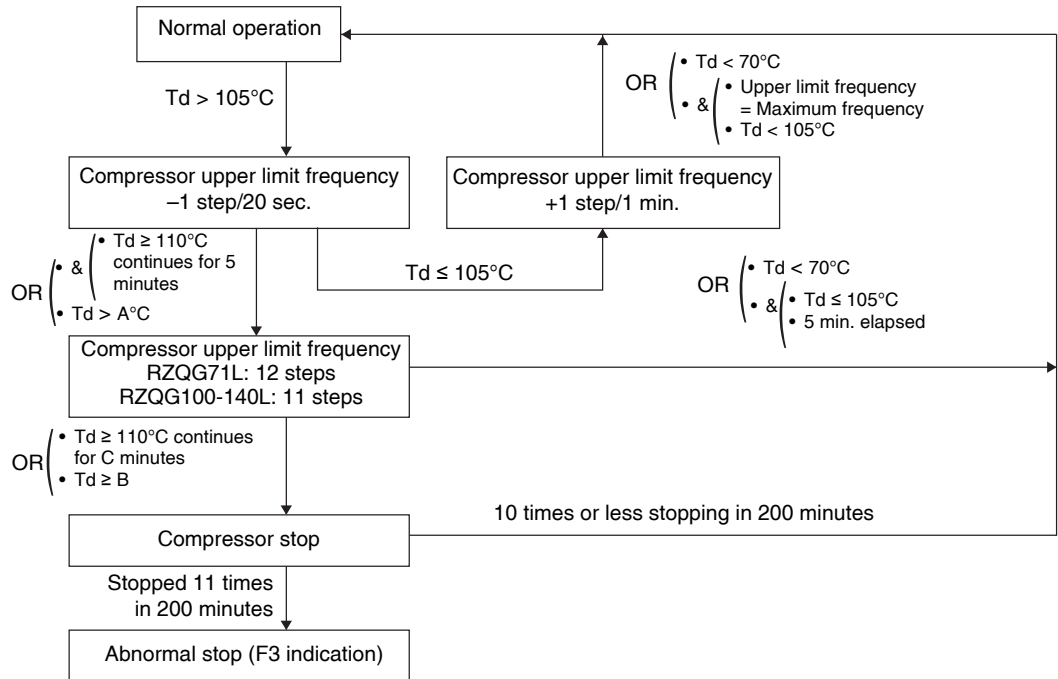

	RZQG71L	RZQG100-140L
A°C	105°C	105°C
B°C	125°C	120°C
C minutes	15 minutes	15 minutes

Electronic Expansion Valve Opening Degree Control

Td: Compressor discharge pipe temperature (°C)

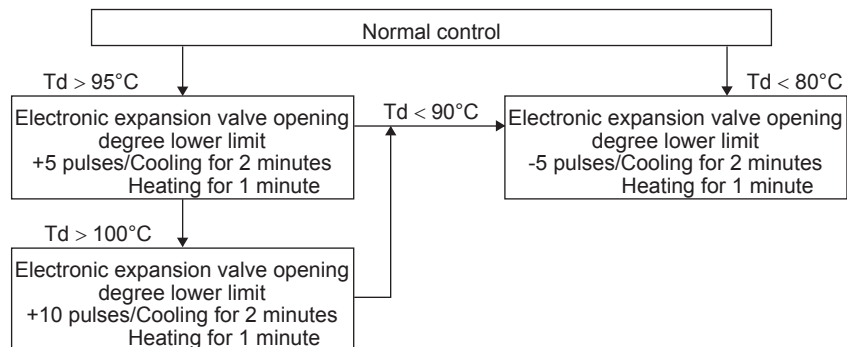

3.2.16 Capacitor Electric Discharge Control

After the operation stopped (the stop caused by the remote controller, an error, and the compressor and outdoor unit fan motor when retry thermo. is off), open phase waveform is output for about one minute for electric discharge of the capacitor.

Afterwards, electric discharge will continue due to discharge resistance until the capacitor voltage becomes 0 V. At this time, operation sound may be heard from the outdoor unit.

3.2.17 Thermostat OFF due to Outdoor Air Temperature (Only in Heating Operation)

If outdoor air temperature is high, the unit conducts forced thermostat OFF at the following temperature to protect the system.

Outdoor air temperature > 32°C

3.2.18 Inverter Current Protection Control

Restricts compressor operation frequency to prevent compressor from tripping due to inverter overcurrent.

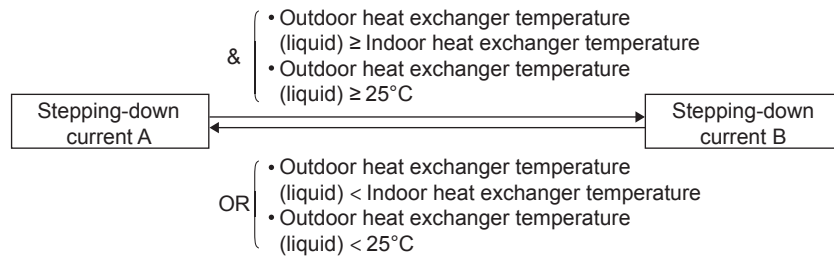
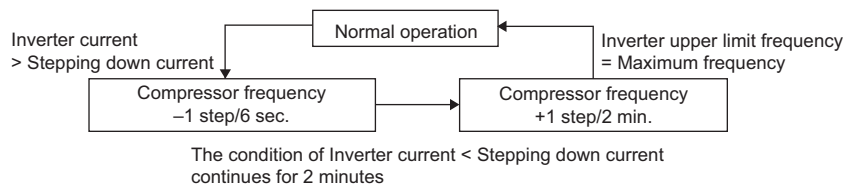

RZQG71L-V		
	71	100~140
A	13.7	20.0
B	11.0	14.0

RZQSG71L-V				
	71	100	125	140
A	13.7	13.7	17.6	20.0
B	11.0	11.8	14.6	14.0

3.2.19 Low Outdoor Air Temperature Control in Cooling Operation

Controls compressor and outdoor unit fan under low outdoor air temperature condition to secure pressure difference between high and low pressure.

Hp: High pressure
 Lp: Low pressure
 Ta: Outdoor air temperature
 Tfin: Inverter fin temperature

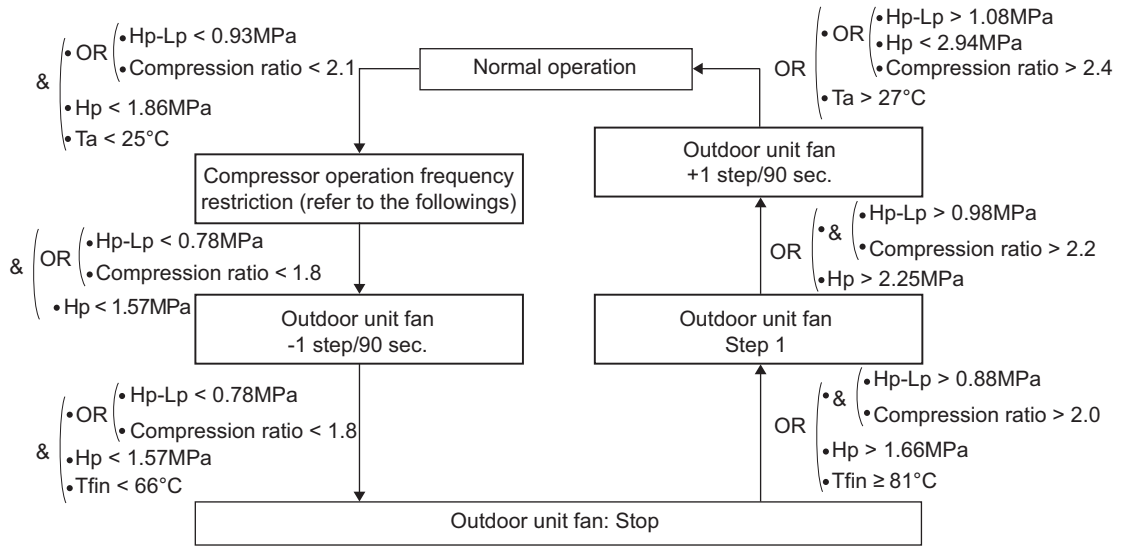

Frequency Restriction

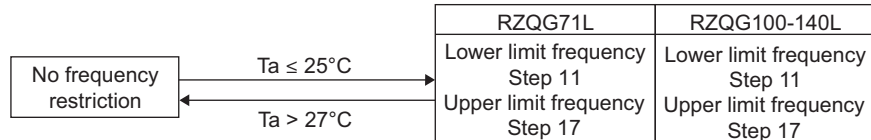

3.2.20 Protection Control by Overall Current

Monitors the overall current and restricts the upper limit compressor operating frequency to prevent circuit breakers from exceeding the rated capacity.

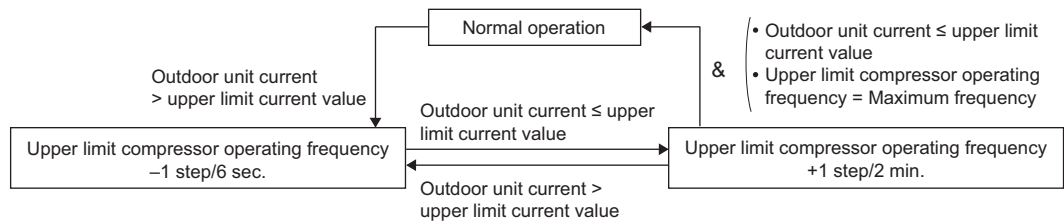

Upper limit current (A)

Takes the following values depending on the outside temperature. Also varies depending on model.

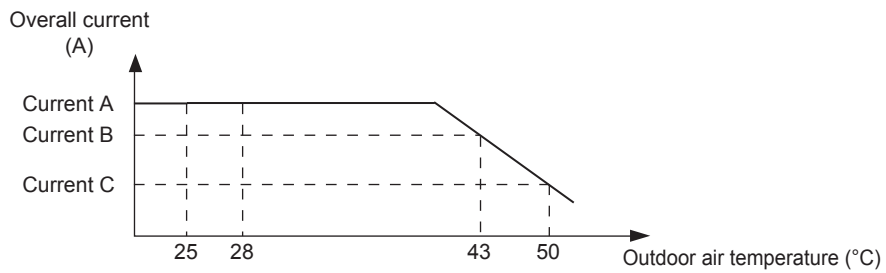

	RZQG71L9V	RZQG100-140L9V
A	16.0 A	25.0 A
B	12 A	22.0 A
C	9 A	20.0 A

3.2.21 Freeze-up Prevention Control

The thermostat turns OFF due to indoor unit heat exchanger temperature in order to avoid formation of ice on the indoor unit heat exchanger. (For details, refer to “Freeze-up Prevention Control”.)

3.2.22 Shortage of Refrigerant Detection Control

When judged that the deficiency in performance has been caused by the shortage of refrigerant, the abnormal stop is activated with the error code “U2” being displayed on the remote controller.

3.2.23 Piping and Wiring Incompatibility Detection Control

When the connecting pipe and the transmission connecting line are connected each to a differing outdoor unit, the abnormal stop is activated with the error code “U3” being displayed on the remote controller.

3.2.24 Oil Recovery Operation

When the compressor runs at low frequency for a long time, the failure of recovering oil may cause the shortage of oil level. Therefore, the oil recovery operation is performed by increasing the compressor operation frequency for five minutes.

* The more the unit operates at low frequency, the higher the frequency of oil recovery operation becomes.

3.2.25 Defrost Operation

When in heating mode, a defrost operation will be conducted in order to avoid ice formation on the outdoor unit heat exchanger.

Starting Conditions

Defrost will start when the following conditions have been realized:

- & (
 - Integrated compressor running time is 25 minutes or more since the completion of the previous defrost operation.
- OR (
 - Defrost upper limit time A is met.
 - Outdoor unit heat exchanger temperature is within the defrost request area.

Defrost conditions

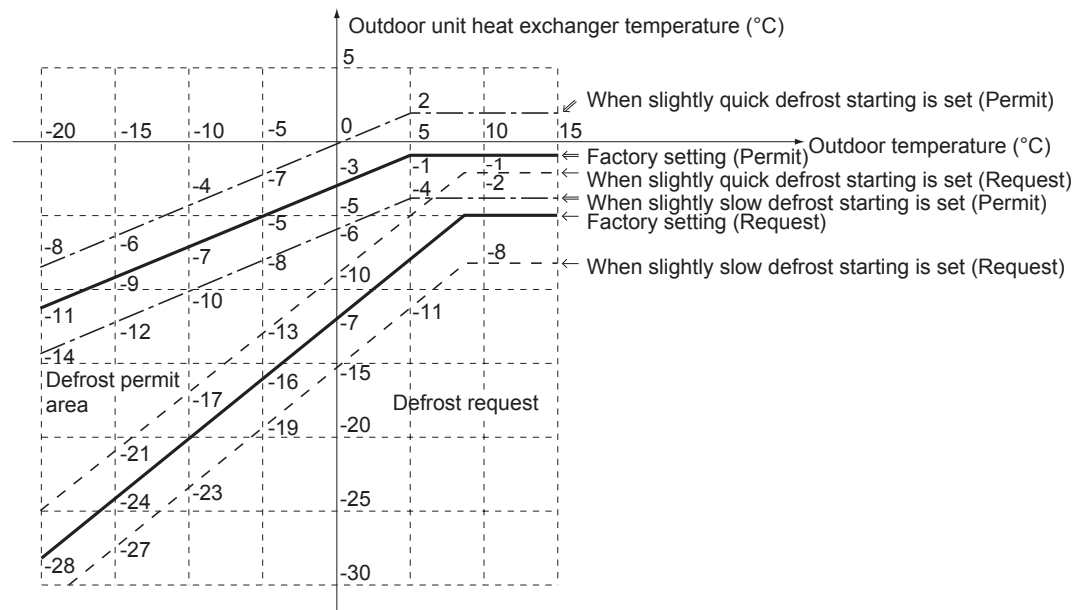

Defrost upper limit A

Depending on the defrost start setting (field setting mode of the indoor unit remote controller), frost upper limit time A becomes as shown in the table below.

	When quick defrost starting is set	Factory setting	When slow defrost starting is set
Outdoor air temperature > -5°C	40 minutes	2 hours	6 hours
Outdoor air temperature ≤ -5°C	40 minutes	6 hours	8 hours

Defrost Control

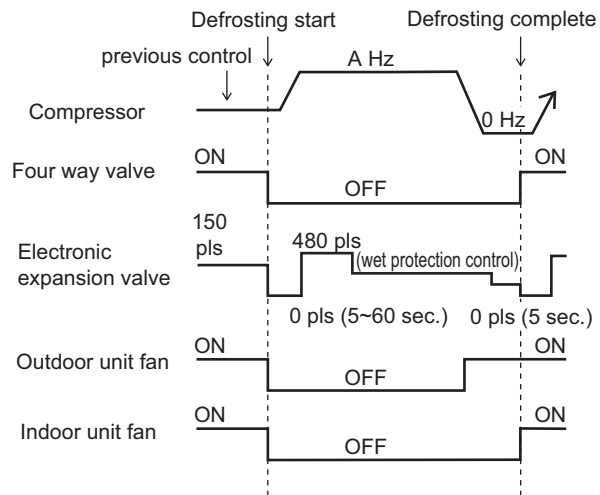

Model	A
RZQG71L	Step 25
RZQG100-140L	Step 22

Defrost Ending Conditions

Defrosting ends when the following conditions have been realized. Note that defrosting can be operated for 10 minutes at longest.

Hp: High pressure

Tb: Heat exchanger distributor pipe temperature

Tm: Intermediate heat exchanger temperature

- OR
 - &
 - Defrost Time > 10 sec.
 - Hp > 2.45 MPa
 - &
 - Defrost Time > 1 min.
 - Tb > 10°C
 - Tm > 12°C
 - &
 - Defrost Time > 9 min.
 - Tb > 8°C
 - Tm > 10°C

3.2.26 Outdoor Unit Fan Control when Frost is Adhered

During heating, when frost has adhered to the outdoor unit heat exchanger and the ventilation flue is blocked, the fan sound increases.

To prevent this fan noise from increasing, the number of revolutions of fan is lowered.

3.2.27 Emergency Operation

- No transmission is performed between indoor and outdoor unit.
- During cooling, the cycle of operation for 20 minutes and stop for 10 minutes is repeated.
- During heating, defrost is performed once every one hour.
- Under other conditions, the same control as the normal control is performed.

3.2.28 Simulated Operation Function

In case of a thermistor error, simulated operation is performed in two different ways as shown below even while the error is detected.

- A. Operation continues while the error code is displayed on the remote controller.
- Applicable thermistors
- Outdoor air temperature thermistor
 - Heat exchanger distribution pipe thermistor (in cooling)
 - Intermediate heat exchanger thermistor (in heating)
 - Liquid pipe thermistor
 - Indoor suction air thermistor
 - Indoor heat exchanger thermistor
- B. Operation continues even the error is detected. The remote controller displays error code only when the "Inspection/Test Run" button is pressed.
- Applicable thermistors
- Remote controller thermistor
 - Radiation fin thermistor



Note: In case of a thermistor error other than A and B above, an abnormal stop is made and no simulated operation is carried out.

- Applicable thermistors
- Suction pipe thermistor
 - Discharge pipe thermistor
 - Heat exchanger distribution pipe thermistor (in heating)
 - Intermediate heat exchanger thermistor (in cooling)

3.2.29 Test Operation Control

When operating in cooling mode for the first time after installation or operating in cooling mode by pressing the indoor unit inspection button, the unit will perform a test operation for about 3 minutes.

- * Make sure that the initial operation after installation is performed by the cooling operation.
(Until the test run is complete, the heating operation cannot be performed.)

Even when the heating operation is performed by pressing the test run button of the indoor unit remote controller, "Test run mode" cannot be entered.
(The heating operation is performed with forced thermo. ON.)

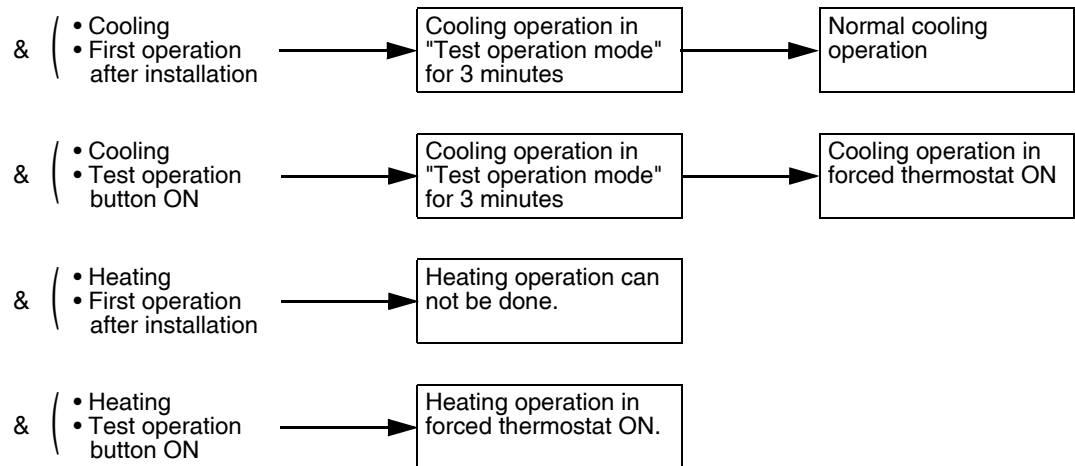

Note:

- In the "Test run mode", errors will be determined all at once in order to detect problems of field setting conditions such as a case that the opening of stop valve has been forgotten.
- During the test run, if the error code shown below is displayed, take measures according to the instructions.
 - (1) When the error code E3, E4 or L8 is displayed on the remote controller, there is possibility that either the stop valve is closed or the airflow outlet is obstructed.
 - (2) When the error code U2 is displayed on the remote controller, check for voltage imbalance.
 - (3) When the error code U4 or UF is displayed on the remote controller, check the inter unit branch wiring connection.
 - (4) When the error code L4 is displayed on the remote controller, there is possibility that the airflow passage is closed.
- When there is no error code display, cooling operation continues.
(However, this control is once again performed after refrigerant is recovered by pump down and at the time of the first * operation after the outdoor unit PCB replacement.)

3.2.30 Improved Comfort in Cooling by Te Control

You can increase the comfort feeling for the customer by limiting the lower Te value.
With higher Te values, the latent capacity will drop (and eventually the sensible capacity).
The EER should increase => Similar as high sensible mode in VRV

Current setting Te lower limit:

Currently it is possible to modify the lower limit of the Te value with field setting (especially used for EDP application).

TeS Lower Limit Value	1	2	3	4
2-11-	0	2	4	6

: Factory setting

However these values are not high enough for high sensible mode.

New higher setting Te lower limit:

Change field setting 33 (in Mode 2) with following values for "TeS Lower Limit value".

TeS Lower Limit Value	1	2	3	4	5	6	7	8
2-33-	0	6	9	11	13	15	17	WHC

The highest value has priority (if 2-33- is activated => most likely these values). However protection control of unit has highest priority.

The highest value between setting 11 and 33 will overrule.

Do not change the value of setting 33 when EDP setting is set.

For WHC: See "Weather Depending Control".

3.2.31 Improved COP in Heating by Tc Control

The COP could be increased (with reduction of capacity) by lowering the "TcS Upper Limit values".

Upper limit Tc control:

Change field setting 34 to change the (TcS Upper Limit value). Now this value is controlled by Pe and no field settings.

TcS Upper Limit Value	1	2	3	4	5	6
2-34-	60	50	47	42	43	WHH

The normal protection control has a higher priority than the new TcS upper limits.

For WHH: See "Weather Depending Control".

3.2.32 Weather Depending Control

When the TeS and TcS values are changed depending on the ambient outdoor temperature the COP and EER can be increased.

In cooling mode: If ambient temperatures are low, the requirement for quick cooling is small.

This way the EER can be improved by increasing the "TeS Lower limit values".

In heating mode: If ambient temperatures are high, the requirement for quick heating is small.

This way the COP can be improved by decreasing the "TcS Upper Limit values".

Cooling

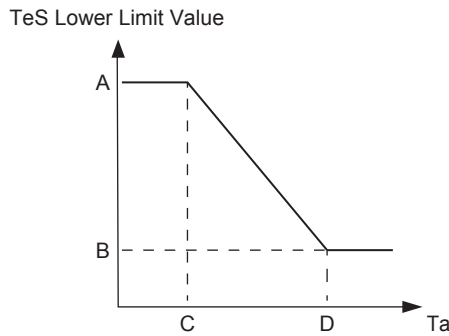

Field setting to control the different value:

Value	Setting	1	2	3	4
A	2-54-	9	11	13	15
B	2-57-	2	4	6	8
C	2-58-	14	17	20	23
D	2-59-	23	27	31	35

Heating

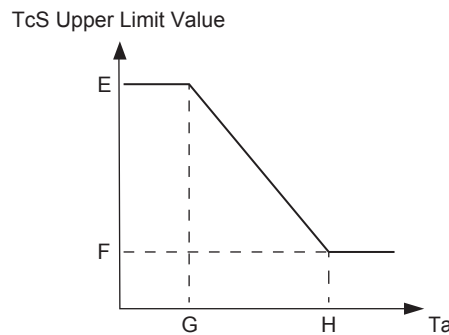

Field setting to control the different value:

Value	Setting	1	2	3	4
E	2-60-	47	48	49	50
F	2-61-	43	44	45	46
G	2-62-	2	5	8	11
H	2-63-	15	18	21	24



Note: If quick cooling/heating function is selected by the customer via remote controller, the unit will go into quick cooling/heating for 20 minutes, neglecting the selected Te/Tc. After 20 minutes, the selected Te/Tc setting will receive priority again.

Example:

The customer has to make a choice:

Fix the Te Lower limit and/or the Tc upper limit on a certain value.

OR

Choose the weather dependent Te Lower limit or Tc Upper limit. In this case the customer can select 2 different outdoor temperatures that will trigger the changeover to a different Te Lower limit and/or Tc Upper limit.

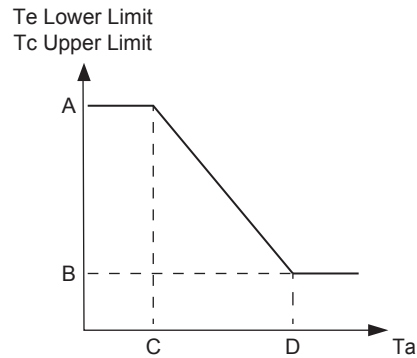

Example cooling:

A= 13°C Te lower limit

B= 6°C Te lower limit

C= 17°C Ta

D= 27°C Ta

Example heating:

A= 49°C Tc upper limit

B= 44°C Tc upper limit

C= 2°C Ta

D= 18°C Ta

3.2.33 Slow start for EDP applications

There is new setting available that will allow the unit to perform a slow start to avoid that the unit would already receive a thermo-off when it is still running in start-up mode. This setting is required when the cooling capacity is oversized.

The merit of this settings is that by lowering the frequency of the compressor (and hereby the capacity) the unit will get a chance to modulate and avoid early thermo off.

- The setting that is required is 26-7-02.
- This setting must always be combined with the EDP setting 26-2-03.

When you make setting 26-7-02 then you will at the same time activate a bigger thermo on/off hysteresis.

- Normal hysteresis is $DT-rs = ((TaIU - Tset) - 0,5) = 2^{\circ}C$.

When setting 26-7-2 is set the slow start will be activated when $DT-rs \leq 4,5^{\circ}C$.

If $DT-rs$ becomes bigger then $5^{\circ}C$ the unit will perform a normal start.

3.2.34 Free cooling

If ambient conditions are low, it would be beneficial to use the fresh air supply to cool the rooms instead of using the actual system.

However at the installation the intake volume + humidity needs to be controlled by external system. The outdoor unit can only give the signal that based on temperatures and demand when free cooling can be used.

Avoid that the fresh outdoor air can short circuit to the indoor unit.

The free cooling 230 V signal will be supplied through the optional PCB KRP58M51 and outdoor unit setting 2-53-xx.

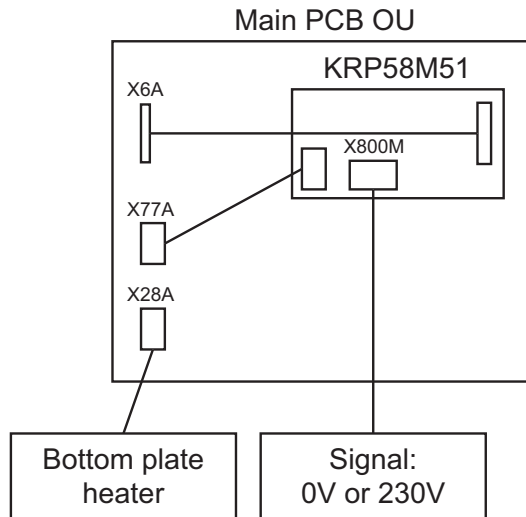

For RZQG71 the bottom plate heater and free cooling cannot be combined as there is no X28A terminal present on the outdoor unit PCB.

Outdoor unit setting 2-53-xx

The customer will have the choice to select 2 parameters to control the activation of the free cooling.

	-01	-02	-03	-04	-05	-06	-07
X	OFF	0	2	4	0	2	4
Y	OFF	5	5	5	10	10	10

Use Mode 2 -53 - (STD: 01: function OFF)

With X and Y to be chosen:

X: Increase free cooling start point above thermo on

Y: Temperature difference between indoor and outdoor ambient temperature to start the free cooling

It is important to make setting 26-7-02 in case of the use of free cooling. This to guarantee that the free cooling will start up before the outdoor unit.

When the cooling capacity of the free cooling should not be enough then the outdoor unit will kick in when thermo on.

Control logic of the compressor with setting 26-2-03/04

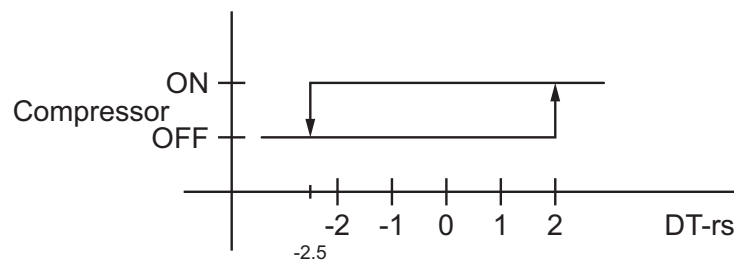

Control logic of the Free Cooling

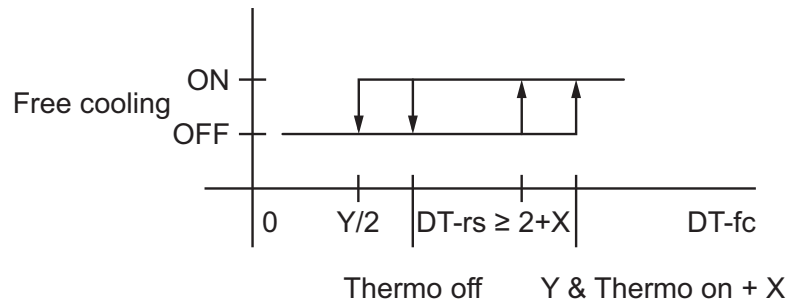

DT-fc: Indoor T - Outdoor T

DT-rs: Room T - Setpoint T

X: To increase the free cooling start temperature

Y: The minimum required DT-fc to start the free cooling

Part 4

Field Setting

1. Test Operation	58
1.1 Pre-run Checks	58
1.2 Remote Controller Confirmation	58
1.3 Test Run.....	59
1.4 Precautions Regarding Test Run	59
1.5 Failure Diagnosis at the Moment of First Installation	60
2. Field Setting from Remote Controller	61
2.1 Wired Remote Controller	61
2.2 Wireless Remote Controller	66
2.3 Settings Contents and Code No. for Indoor Units	67
2.4 Overview of the Field Setting on the Outdoor Units	73
2.5 Quiet (Low Noise) Operation.....	74
2.6 I-Demand Function.....	76
2.7 Setting for Low Humidity Application.....	77
2.8 Defrost Start Setting	80
2.9 Slow start.....	80
3. Field Setting from Outdoor Unit PCB	81
3.1 Location of DIP Switch and BS Button	81
3.2 Field Setting for Outdoor Unit.....	82
4. Emergency Operation	92
4.1 Forced Operation	92

1. Test Operation



WARNING

Live parts can be easily touched by accident.
 Never leave the unit unattended during installation or servicing when the service panel is removed.
 Never perform a test run with the discharge piping thermistor (R2T) and suction piping thermistor (R3T) removed, as this might break the compressor.
 Do not touch the drain pump or fan if the indoor unit is operated without attaching the decoration panel. (Doing so could result in an electric shock or other injury.)



Note:

Note that during the first running period of the unit, required power input may be higher. This phenomenon originates from the compressor that requires a 50-hour run-in period before reaching smooth operation and stable power consumption.

1.1 Pre-run Checks

Items to check	
Electrical wiring Inter-unit wiring Earth wire	<ul style="list-style-type: none"> ● Is the wiring as mentioned on the wiring diagram? Make sure no wiring has been forgotten and that there are no missing phases or reverse phases. ● Is the unit properly grounded? ● Is the wiring between units connected in series correct? ● Are any of the wiring attachment screws loose? ● Is the insulation resistance at least 1 MΩ? <ul style="list-style-type: none"> - Use a 500 V mega-tester when measuring insulation. - Do not use a mega-tester for low-voltage circuits.
Refrigerant piping	<ul style="list-style-type: none"> ● Is the size of the piping appropriate? ● Is the insulation material for the piping attached securely? Are both the liquid and gas pipes insulated? ● Are the stop valves for both the liquid side and the gas side open?
Extra refrigerant	<ul style="list-style-type: none"> ● Did you write down the extra refrigerant and the refrigerant piping length?
Indoor unit	<ul style="list-style-type: none"> ● Is the indoor unit fully installed? <ul style="list-style-type: none"> - When the test run is started, the fan automatically begins turning. If a decoration panel is not attached, make sure that no work is being done on the indoor unit. - If you are using the wireless remote controller, do the test run after attaching the decoration panel to the indoor unit.

- Be sure to perform a test run.
- Be sure to fully open the liquid-side and gas-side stop valves. If you operate the unit with stop valves closed, the compressor will break down.
- Be sure to execute the first test run of the installation in cooling mode operation.
- Never leave the unit unattended with an open front panel during test run.

1.2 Remote Controller Confirmation

- The settings of the remote controller for the BRC1D series should be made in accordance with the following procedure.
- The settings of the remote controller for the BRC1E series should be made in accordance with the attached manual.

1.3 Test Run

1. Make sure the liquid and gas stop valves are open.

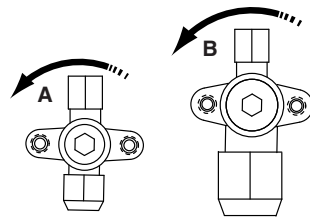

Opening direction

- A Liquid side
- B Gas side

Remove the cap and turn counterclockwise with a hex wrench until it stops

2. Be sure to close the front side panel before operation, as not doing so can cause electric shock.
3. Be sure to turn power on at least 6 hours before starting operation in order to protect the compressor.
4. Be sure to set the unit to cooling operation mode.
5. Press the inspection/test operation button of the remote controller 4 times (2 times in case of a wireless remote controller) to go into the test run mode.
6. Press the ON/OFF button within 10 seconds to start the test run and check the operation status for about 3 minutes. The refrigerant pressure may not rise immediately, even if the stop valve is opened after an air purge is performed using a vacuum pump. This is because the indoor unit refrigerant piping is closed off with electric valves inside. This will not create any problems during operation.
7. Push the air flow direction adjust button and check if the unit is responding to the new air flow direction position.
8. Press the inspection/test operation button of the remote controller 2 times to go into check mode and to make sure that the malfunction code displays "00" (=normal). In case the malfunction code does not display "00", refer to "Failure Diagnosis at the Moment of First Installation" on page 60.
9. If the inspection/test operation button is pressed 4 times during a test run, the unit returns to normal operation.
10. Check all functions according to the operation manual.

1.4 Precautions Regarding Test Run

1. In order to detect stop valves failing to open, operation of the unit is compulsorily performed in cooling for 2-3 minutes during the first test run, even if the remote controller was set to heating operation. In this case, the remote controller will have kept displaying the heating symbol all the time and the unit will switch to heating operation automatically after elapse of that time.
2. In case you cannot operate the unit in test run mode for any unusual reason, refer to "Failure Diagnosis at the Moment of First Installation" on page 60.
3. In case of a wireless remote controller, execute the test run only after having installed the indoor unit decoration panel with infrared receiver first.
4. In case the panels of indoor units are not yet installed to the indoor units, make sure to shut off the power supply after finishing the complete test run.
5. A complete test run surely includes shutting off power after having performed a normal operation stop on the remote controller. Do not stop operation by turning circuit breakers off.

1.5 Failure Diagnosis at the Moment of First Installation

- In case nothing is displayed on the remote controller (the current set temperature does not display), check for any of the following abnormalities before you can diagnose possible malfunction codes.
 - Disconnection or wiring error (between power supply and outdoor unit, between outdoor unit and indoor units, between indoor unit and remote controller).
 - The fuse on the outdoor unit PCB may have run out.
- If the malfunction code “E3”, “E4”, “L8” or “L9” is displayed on the remote controller, there is a possibility that the stop valves are closed.
- If the malfunction code “E3”, “E4”, “L4” or “L8” is displayed on the remote controller, there is a possibility that air inlet or air outlet are blocked.
- If the malfunction code “L2” is displayed on the remote controller, check for voltage imbalance.
- If the malfunction code “L4” or “L5” is displayed on the remote controller, check the inter-unit branch wiring connection.
- If the malfunction code “L8” is displayed on the remote controller, there is a possibility that connection is with incompatible indoor unit.

2. Field Setting from Remote Controller

Individual function of indoor unit can be changed from the remote controller. At the time of installation or after service inspection / repair, make the local setting in accordance with the following description.





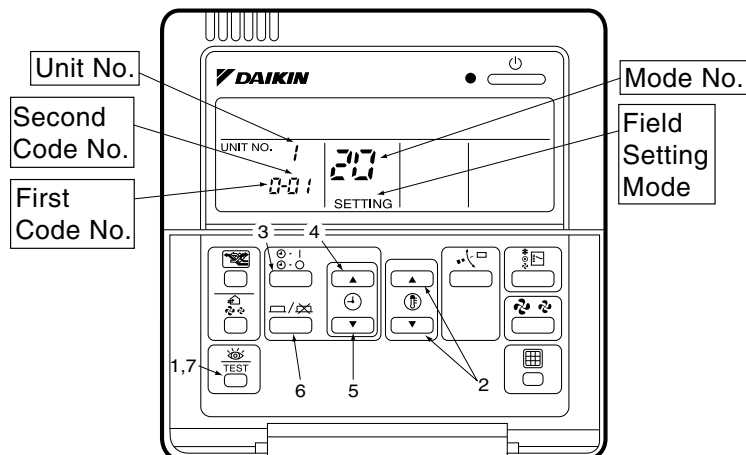

Wrong setting may cause error.

(When optional accessory is mounted on the indoor unit, setting for the indoor unit may be required to change. Refer to information in the option handbook.)

2.1 Wired Remote Controller

2.1.1 BRC1D528



1. When in the normal mode, press the “” button for 4 seconds or more, and the Field Set Mode is entered.
2. Select the desired Mode No. with the “” button (2).
3. During group control, when setting by each indoor unit (mode No. 20, 22 and 23 have been selected), press the “/” button (3) and select the Indoor Unit No to be set. (This operation is unnecessary when setting by group.)
4. Press the “” upper button (4) and select First Code No.
5. Press the “” lower button (5) and select the Second Code No.
6. Press the “/” button (6) once and the present settings are Set.
7. Press the “” button (7) to return to the Normal Mode.

(Example)

If during group setting and the time to clean air filter is set to Filter Contamination, Heavy, Set Mode No. to “10” First Code No. to “0”, and Second Code No. to “02”.

2.1.2 BRC1E52

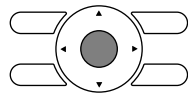
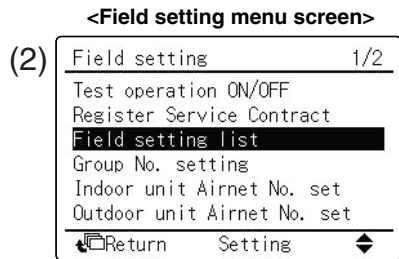
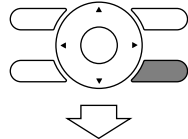
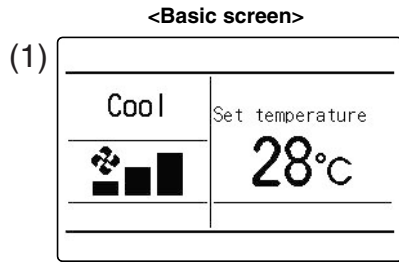

Press Menu/Enter button.

<Field setting screen>

In the case of individual setting per indoor unit

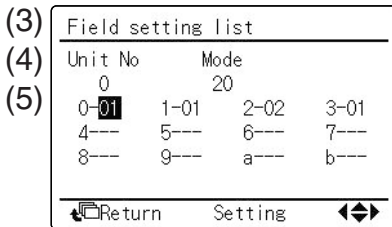

In the case of group total setting

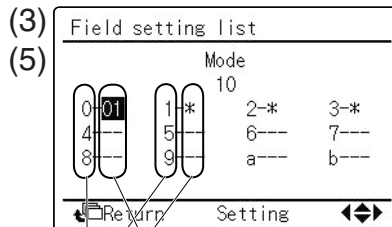

Second Code No.

First Code (SW) No.

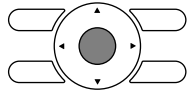

Press Menu/Enter button.

- 1 Press and hold Cancel button for 4 seconds or more. Field setting menu is displayed.
- 2 Select **Field setting list** in the field setting menu, and press Menu/Enter button. Field setting list screen is displayed.
- 3 Highlight the mode, and select desired "Mode No." by using ▲▼ (Up/Down) button.
- 4 In the case of setting per indoor unit during group control (When Mode No. such as **20**, **21**, **22**, **23**, **25** are selected), highlight the unit No. and select "Indoor unit No." to be set by using ▲▼ (Up/Down) button. (In the case of group total setting, this operation is not needed.)
- 5 Highlight Second Code No. of the First Code No. to be changed, and select desired "Second Code No." by using ▲▼ (Up/Down) button. Multiple identical mode number settings are available.

[In the case of individual setting per indoor unit, current settings are displayed. And, Second Code No. " - " means no function.]

[In the case of group total setting, all of Second Code No. which may be set are displayed as " * ". " * " is changed to Second Code No. to be set. And, Second Code No. " - " means no function.]

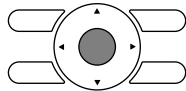
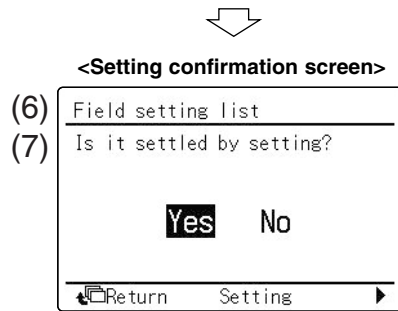

Press Menu/Enter button.



Setting confirmation



- 6** Press Menu/Enter button. Setting confirmation screen is displayed.
- 7** Select **Yes** and press Menu/Enter button. Setting details are determined and field setting list screen returns.
- 8** In the case of multiple setting changes, repeat “(3)” to “(7)”.
- 9** After all setting changes are completed, press Cancel button twice.
- 10** Backlight goes out, and “Connection under check Please wait for a moment” is displayed for initialization. After the initialization, the basic screen returns.

CAUTION

- When an optional accessory is installed on the indoor unit, settings of the indoor unit may be changed. See the manual of the optional accessory.
- For field setting details of the outdoor unit, see installation manual attached to the outdoor unit.

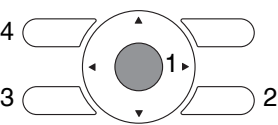
2.1.3 Remote controller settings

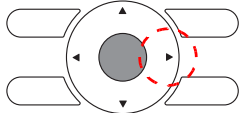
Level	Setting	Code	Function	Adjustment	Description	Info
Remote controller setting (BRC1E)						
Remote controller BRC1E	1b	8	Automatic summer/ wintertime changeover	01	No automatic changeover	
				02	Automatic changeover active	
				03	Setting menu available in Extended functions	
		a	"Away from Home function" can be freely selected in main menu using RETURN. You can select start point for heating between 5°C and 10°C and for cooling between 35°C and 40°C.	01	"Away from Home menu" is not available	You must also activate the "Away from Home function" in the 1e-2 setting 1x RETURN -> Away from Home function
				02	"Away from Home menu" is available in main menu	
		b	Clock display in the remote controller	01	Clock is displayed in remote controller with detail display ON	Available as from software 04.003
	02			Clock is not displayed		
	1c	0	Available selection in the detail display	01	Room temperature not available	You can determine which sensors are displayed using setting 1c-1 1x RETURN -> Extended functions -> Detail display
				02	Room temperature available	
		1	Use remote controller temperature sensor in "Detail display", "Away from Home function" and "Limit operation"	01	Suction air thermistor (R1T)	If the detail display is activated, the suction air thermistor should be used.
				02	Remote controller sensor	
		3	Remote controller keylock	01	Level 2 Free keys: Mode Setpoint On/Off	To activate or deactivate the keylock starting 1x right arrow and then right arrow again, press Back, Mode, Fan simultaneously.  If the keylock is active, the key symbol appears when locked keys are pressed.
				02	Level 3 Free keys: On/Off	
		4	Backlighting	01	Off	Backlight goes out after 20 seconds.
				02	On as soon as a key is pressed	
				03	Permanently On	
		6	Display	01	Display is always available	
	02			Display switches off after 5 minutes and is reactivated by pressing a key		

Level	Setting	Code	Function	Setting	Description	Info
Remote controller setting (BRC1E)						
Remote controller BRC1E	1e	1	Unit of temperature	01	°C	
				02	Optional choice of °C or °F in "Extended functions" menu option	1x RETURN -> Extended functions -> Unit of temperature
	2	"Away from Home function" After being activated below/above the temperature set in the main menu (see setting 1b-a), the "Away from Home function" switches on the interior unit and the system runs without setpoint until the temperature is once again within the safe range. (Heating 5°C - 10°C /cooling 35°C - 40°C) Only for master units in the system (if necessary, consider setting 22-9)	01	Not available	To activate the Away from Home function, press right arrow for 5 seconds.  In the display you will see  To deactivate, press right arrow again for 5 seconds.	
			02	Available for heating mode		
			03	Available for cooling mode		
			04	Available for heating and cooling mode		
	4	Weekly timer	01	Weekly timer is not available	If the sequence timer is also deactivated under 1e-6, the "Timer settings" menu option disappears	
			02	Weekly timer is available	1x RETURN -> Timer adjustment -> Weekly timer	
	5	Clock display options	01	24-hour display		
			02	You can choose between 24-hour or 12-hour display in the "Extended functions" menu option	1x RETURN -> Extended functions -> Time display	
	6	Sequence timer	01	Sequence timer is not available	If the weekly timer is also deactivated under 1e-4, the "Timer settings" menu option disappears	
			02	Sequence timer is available	1x RETURN -> Timer adjustment -> Sequence timer	
	a	Sensor calibration of remote controller sensor in the master remote controller	01	-3 K	As from BRC1E software ver.04.00.03	
			02	-2.5 K		
			03	-2 K		
			04	-1.5 K		
			05	-1 K		
			06	-0.5 K		
			07	±0 K		
			08	+0.5 K		
			09	+1 K		
	b	Sensor calibration of remote controller sensor in the slave remote controller	01	-3 K	As from BRC1E software ver.04.00.03	
			02	-2.5 K		
			03	-2 K		
			04	-1.5 K		
			05	-1 K		
			06	-0.5 K		
			07	±0 K		
08			+0.5 K			
09			+1 K			

2.2 Wireless Remote Controller

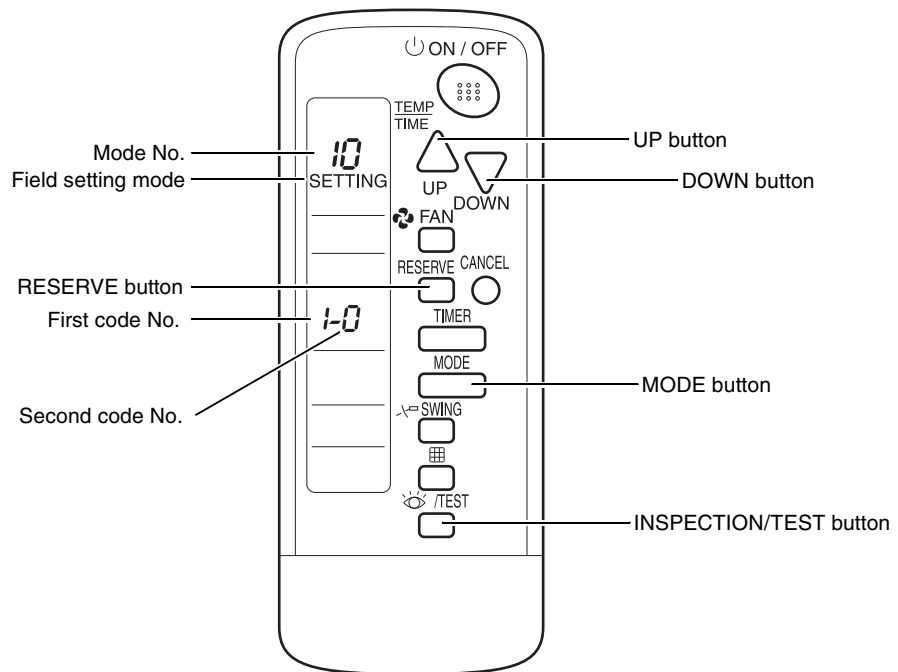

Setting

To set the field settings, you have to change:

- "Mode No."
- "First code No."
- "Second code No."

To change the field settings, proceed as follows:

Step	Action
1	Hold down the INSPECTION/TEST button for at least 4 s during normal mode to enter the "Field setting mode".
2	Press the MODE button to select the desired "Mode No."
3	Press the UP button to select the "First code No."
4	Press the DOWN button to select the "Second code No."
5	Press the RESERVE button to set the present settings.
6	Press the INSPECTION/TEST button to return to the "Normal mode".

2.3 Settings Contents and Code No. for Indoor Units

- You can change the setting of 3 x 3 sensing cassette as mentioned below
- The method of field setting, which can be conducted through remote controller, is established practice, but it is possible only with BRCE52 remote controller.

Mode No.	First Code No.	Description of Setting		Second Code No.				
				01	02	03	04	05
10 (20)	0	Filter cleaning sign interval	Long life filter	2,500 hrs.	1,250 hrs.	—	—	—
	1	Filter type		Long	Super long	—	—	—
	2	Remote controller thermistor		Enabled	Disabled	—	—	—
	3	Filter cleaning sign		Display	No display	—	—	—
	7 (note 4)	Detection time for NOT presence		30 min	60 min	—	—	—
8 (note 5)	Compensation of suction air temperature in heating mode		COMPENSATE (Temperature [A+2] °C which an air conditioner controls when the temperature of a remote controller is A °C)	NO COMPENSATION (Temperature [A] °C which an air conditioner controls when the temperature of a remote controller is A °C)	—	—	—	
11 (21)	2	Fan OFF at Thermostat OFF		Normal	OFF	—	—	—
	3	Airflow rate setting during heating		Standard	Slightly up	Up	—	—
	4	Automatic operation mode control		Available	Prohibition	—	—	—
	6 (note 6)	Sensitivity of presence sensor		High	Low	Standard	Sensor does not work	—
11 (22)	0	Option (KRP1B*) output		Compressor	Option	Operation	Malfunction	—
	7 (note 6)	Compensation of temperature around human body		Floor sensor does not work	Higher priority on the air temperature	Standard	Higher priority on the floor temperature	—
	8 (note 6)	Compensation of floor temperature		-4°C	-2°C	±0°C	+2°C	—
12 (22)	3	Fan speed heating thermostat OFF		LL-speed	Set-speed	—	—	—
	5	Automatic restart after power failure reset		Disabled	Enabled	—	—	—
	6	Fan speed cooling thermostat OFF		LL-speed	Set-speed	—	—	—
13 (23)	0	High air outlet velocity (for high ceiling applications)		Standard	Slightly up	Up	—	—
	1	Selection of airflow direction		4-way flow	3-way flow	—	—	—
	2	Flap moving in the swing mode		All 4 flaps synchronized	—	Two opposite flaps synchronized	—	—
	4 (*2)	Airflow range setting		Upper	Normal	Lower	—	—

14 (24)	2	The largest time interval for Dust Collection Sign Display for "self cleaning decoration panel"	About 1250 hrs (Dusty place)	About 2500 hrs	About 5000 hrs (less dusty place)	—	—
	4	Display or non-display of green lamp on the selfcleaning decoration panel	Display both: - airconditioning operation, -filter auto cleaning	Non display: - airconditioning operation, Display: -filter auto cleaning	Display: - airconditioning operation, Non display: -filter auto cleaning	—	—
	8	Auto control operation for Filter Auto Cleaning	Auto control operation	Not auto control operation	—	—	—
	9	Filter cleaning time for "selfcleaningdecoration panel"	Normal place in terms of dust (Normal office)	In case of dusty place	—	—	—
15 (25)	5	Individual setting of ventilation	Normal	Individual operation	—	—	—
1b (2b)	14	Wind block (note 7) enable / disable setting	Enable	—	—	—	disable



- Note:**
- Settings are made simultaneously for the entire group, however, if you select the mode No. inside parentheses, you can also set by each individual unit. Setting changes however cannot be checked except in the individual mode for those in parentheses. (Even if the setting are made for the entire group, the display always indicates "01".)
 - For FHQG, the second code No. of the "Airflow range setting is set at "03".
 - "88" may be displayed to indicate the remote controller is resetting when returning to the normal mode.
 - This function does not work when "SET BACK Function" is set by remote controller.
 - This is the case when the remote sensor (optional kit) is used.
 - This is the case when the sensor option (optional kit) is used.
 - Wind block: one of 4 flaps can be set a block position. (block position = closed position)
Wind can not be blocked 100% but mostly blocked without additional parts.

2.3.1 Detailed Explanation of Setting Modes

Filter Cleaning Sign Interval

When "Display" is selected in "Filter cleaning sign" after the unit runs for certain time, "Filter cleaning" will be displayed on the remote controller. This setting is used when the display interval of "Filter cleaning" needs to be changed on occasions such as when the filter has been heavily contaminated.

Mode No.	First Code No.	Second Code No.	Long Life Filter	Setting
10 (20)	0	01	2,500 hrs.	Contamination Light
		02	1,250 hrs.	Contamination Heavy

Remote Controller Thermistor

Select the thermistor to control room temperature.

Mode No.	First Code No.	Second Code No.	Thermistor that controls room temperature
10 (20)	2	01	Room temperature thermistor in remote controller and indoor unit suction air thermistor
		02	Indoor unit suction thermistor

The factory setting for the Second Code No. is "02" and room temperature is controlled by the indoor unit suction air thermistor.

When the Second Code No. is set to "01", room temperature is controlled by the indoor unit suction air thermistor and the room temperature thermistor in remote controller as following figures.

When using remote controller

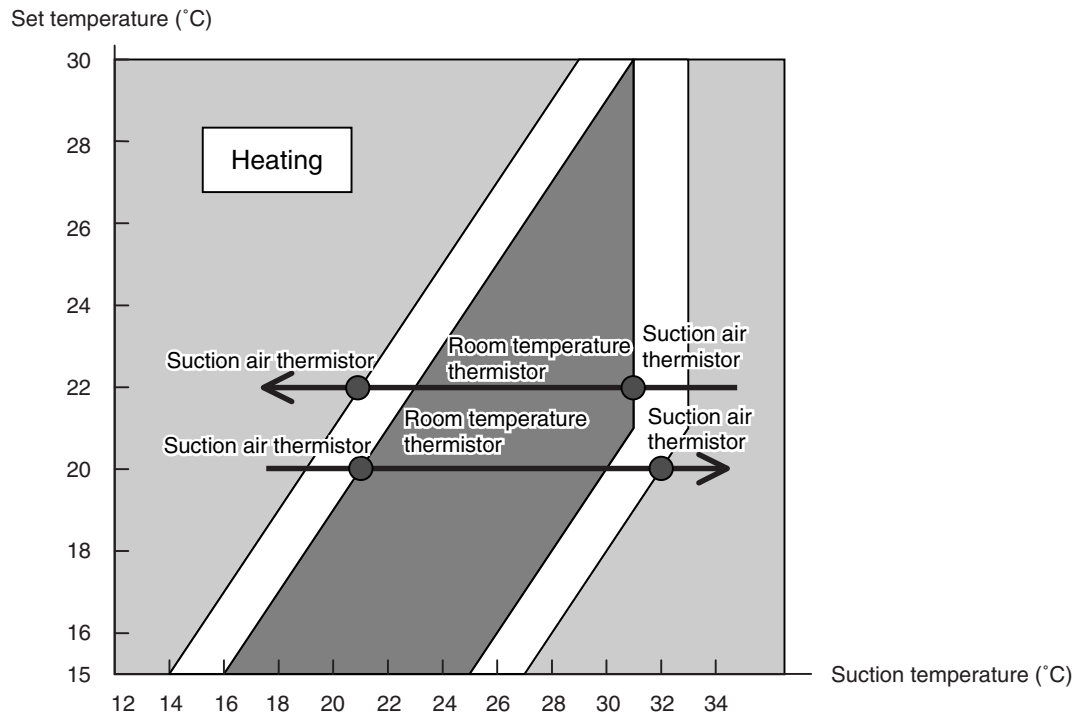
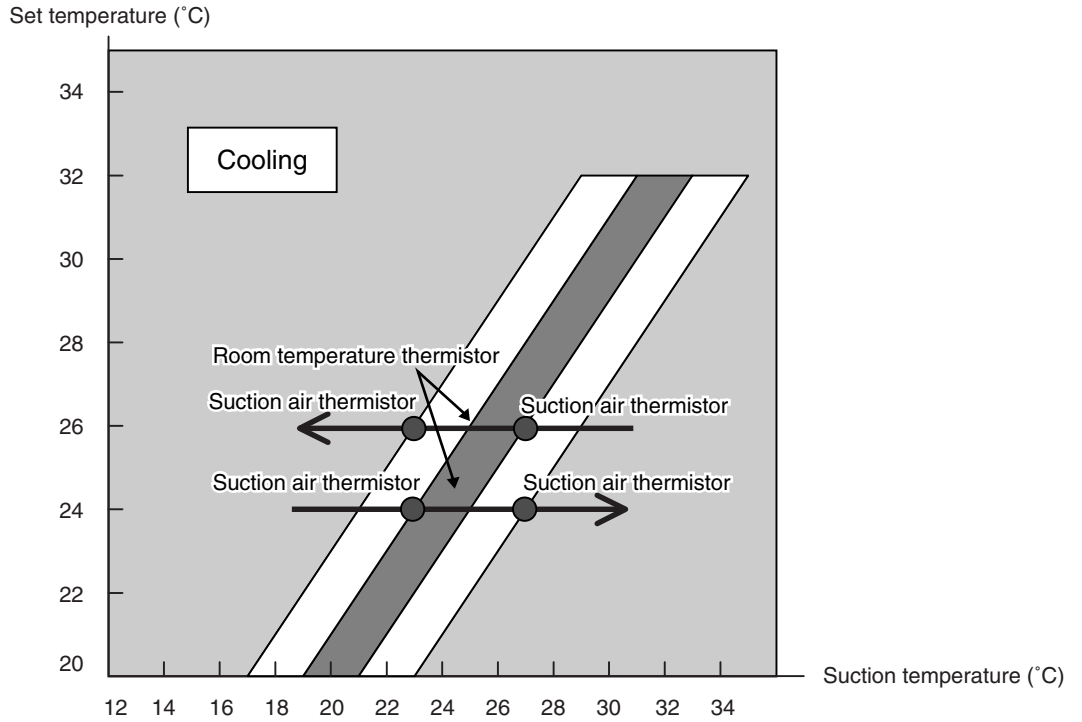

Filter Cleaning Sign

Whether or not to display "Filter Cleaning" after operation of certain duration can be selected.

Mode No.	First Code No.	Second Code No.	"Filter Cleaning" display
10 (20)	3	01	Display
		02	No display

Airflow Rate

Set the airflow when thermostat OFF by the combination of "Fan OFF at Thermostat OFF" 11(21)-2, "Fan speed heating thermostat OFF" 12(22)-3 and "Fan speed cooling thermostat OFF" 12(22)-6.

A : 6 minutes OFF / 1 minute LL

B : 6 minutes OFF / 1 minute setting airflow

C : 6 minutes OFF / 1 minute L

Set the airflow by the combination of 3 modes as below.

Mode No.	First Code No.	Second Code No.							
		Factory setting	Field setting						
11(21)	2	01	01	01	01	02	02	02	02
12(22)	3	01	01	02	02	01	01	02	02
12(22)	6	02	01	01	02	01	02	01	02
		↓	↓	↓	↓	↓	↓	↓	↓
Cooling	When thermostat OFF	Setting	LL	LL	Setting	A	B	A	B
Dry	When thermostat OFF	C	C	C	C	C	C	C	C
Heating	When thermostat OFF	LL	LL	Setting	Setting	A	A	Setting	Setting
	When defrost hot start	OFF	OFF	OFF	OFF	OFF	OFF	OFF	OFF

Airflow Rate Setting during Heating (FCQG Only)

For the purpose of securing airflow range during heating, the number of revolutions of fan during heating can be changed. Make the setting according to installation environment.

Mode No.	First Code No.	Second Code No.		
		01	02	03
11 (21)	3	Standard	Slightly up	Up

Automatic Operation Mode Control

When selecting “Automatic Operation Mode” with the remote controller, conducts the most comfortable operation in which you do not feel too cool or too hot.

- Outdoor air temperature
 - Indoor air temperature
 - Temperature set by remote controller
- } ⇒ Calculates and controls the optimum indoor temperature

Automatic Restart after Power Failure Reset

For the air conditioners with no setting for the function, the units will be left in the stop condition when the power supply is reset automatically after power failure reset or the main power supply is turned on again after once turned off. However, for the air conditioners with the setting (same as factory setting), the units may start automatically after power failure reset or the main power supply turned on again (return to the same operation condition as that of before power failure).

For the above reasons, when the unit is set enabling to utilize “Auto restart function after power failure reset”, utmost care should be paid for the occurrence of the following situation.



- Caution**
1. The air conditioner starts operation suddenly after power failure reset or the main power supply turned on again. Consequently, the user might be surprised (with question for the reason why).
 2. In the service work, for example, turning off the main power switch during the unit is in operation, and turning on the switch again after the work is completed start the unit operation (the fan rotates).

Setting of Normal Airflow

Make the following setting according to the ceiling height. The setting position No. is set to “01” at the factory.

■ FCQG71

Mode No.	First code No.	Second code No.	Ceiling height (m)
13 (23)	0	01	≤ 2.7
		02	2.7 - 3.0
		03	3.0 - 3.5

■ FCQG100-140

Mode No.	First code No.	Second code No.	Ceiling height (m)
13 (23)	0	01	≤ 3.2
		02	3.2 - 3.6
		03	3.6 - 4.2

■ FHQG71

Mode No.	First code No.	Second code No.	Ceiling height (m)
13(23)	0	01	≤ 2.7
		02	2.7 - 3.5

■ FHQG100-140

Mode No.	First code No.	Second code No.	Ceiling height (m)
13(23)	0	01	≤ 3.8
		02	3.8 - 4.3

Airflow Direction Setting

Set the air flow direction of indoor units as below. (Set when optional air outlet blocking pad has been installed.)

Mode No.	First Code No.	Second Code No.	Setting
13 (23)	1	01	F: 4-direction air flow
		02	T: 3-direction air flow

Airflow Range Setting

Make the following air flow direction setting according to the respective purpose.

Mode No.	First Code No.	Second Code No.	FCQG	FHQG
13 (23)	4	01	Draft prevention (Upward)	Draft prevention (Upward)
		02	Standard	Dew condensation prevention (Upward)
		03	Ceiling soiling prevention (Downward)	Standard (Downward)

* Some indoor unit models are not equipped with draft prevention (upward) function.

Individual Setting of Ventilation

This is set to perform individual operation of heat reclaim ventilation using the remote controller/ central unit when heat reclaim ventilation is built in.

(Switch only when heat reclaim ventilation is built in.)

Mode No.	First Code No.	Second Code No.	Setting
15 (25)	5	01	—
		02	Individual operation of ventilation

2.4 Overview of the Field Setting on the Outdoor Units

Remote controller settings

The table below contains the remote controller settings.

Factory set

Mode No.	First Code No.	Description	Second Code No.					Details
			01	02	03	04	05	
16 (26)	0	Night time low noise operation	Disabled (Factory setting)	Automatic low noise activation	Capacity preceding setting (when using KRP58 option)	Automatic low noise + capacity preceding	—	Refer to P74.
	1	Automatic low noise start and stop time	—	—	22h00 ~ 06h00	22h00 ~ 08h00 (Factory)	20h00 ~ 08h00	Refer to P74.
	2	EDP room setting	Disabled (Factory setting)	—	EDP room setting	EDP room setting + no freeze up	—	Refer to P77.
	3	Defrost starting setting	Standard (Factory setting)	Defrost slow starting setting	Defrost quick starting setting	—	—	Refer to P80.
	7	Slow start for EDP applications	Normal start	Slow start	—	—	—	

Factory settings

The table below contains the factory settings of all outdoor units

Mode No.	First Code No.	Second Code No.
26	0	01
	1	04
	2	01
	3	01
	7	01

2.5 Quiet (Low Noise) Operation

Purpose Lower the operation sound of the outdoor unit.

Setting Silent Operation can be activated by:

1. Automatic control (By field setting from remote controller)
2. External activation (from optional PCB KRP58M)

2.5.1 Quiet (Low Noise) Operation by Automatic Control

Table Silent operation can be set by field setting from the wired remote controller:

Description	Mode No.	First Code No.	Second Code No.				
			01	02	03	04	05
Silent Operation	16(26)	0	OFF	Low noise activation	—	Low noise + capacity priority	—
Low noise start & stop time		1	—	—	22h00 ~ 06h00	22h00 ~ 08h00	20h00 ~ 08h00

Method When setting mode 16(26)-0-02, quiet (low noise) operation will be carried out by presuming the current time in accordance with the outside temperature.
Automatic mode will start when the outdoor temperature is = average max of last 10 days -5°C and will be conducted for 10 hours.
The maximum outdoor temperature is supposed to occur at 14:00h.
As the time judgement is made in accordance with the outdoor temperature, the above mentioned timing is an estimation only.

Capacity Priority Setting When setting mode 16(26)-0-04, the low noise operation will be stopped when the heating or cooling load increases. In that case, the operation will return to normal operation. The unit will return to low-noise operation when the heating or cooling load decreases again.

Graph

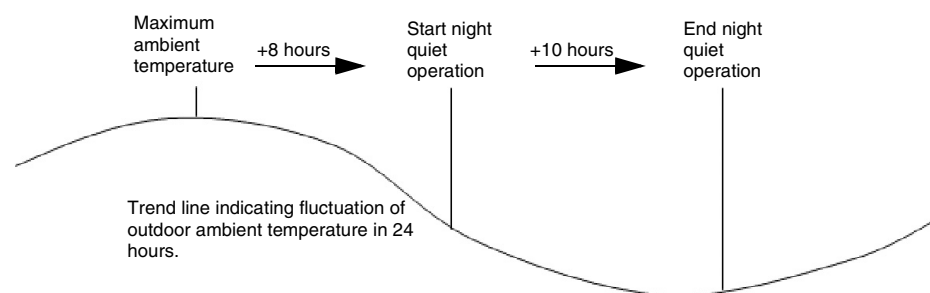

2.5.2 External Activation from Optional PCB

Graph

Quiet (low noise) operation can also be activated from the optional PCB.

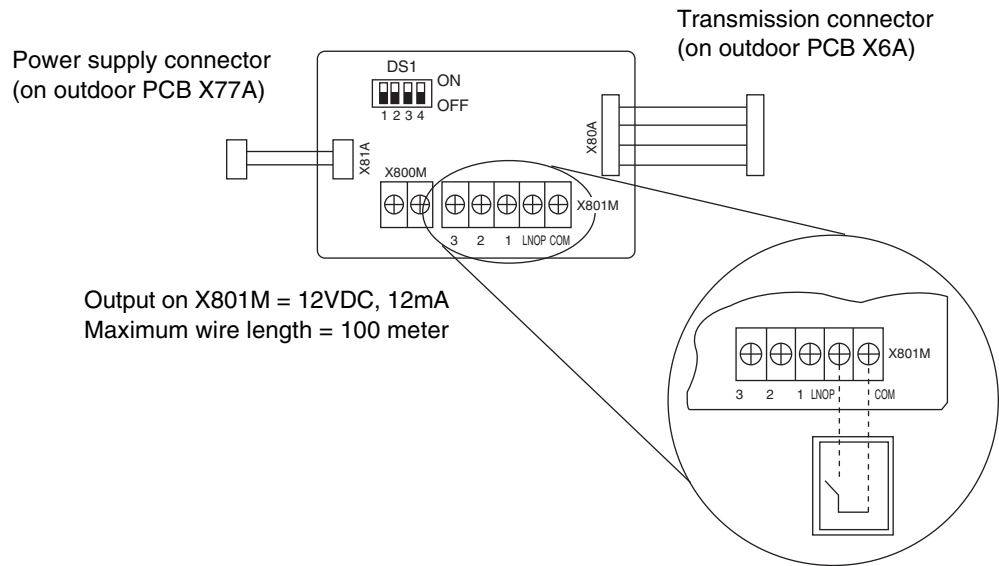

Quiet (low noise) operation will start when the contact on LNOP-COM is closed and will remain active as long as the contact is closed. No field setting on the outdoor unit or by remote controller is required.

Quiet (low noise) operation will be ended when the contact is re-opened.

Use of the KRP58M enables the use of an external time clock.

Capacity priority Setting

Same as with the automatic control, priority for capacity can be set. Priority for capacity will be activated by changing field setting 26-0-03 in combination with the closed contact on KRP58M.

Description	Mode No.	First Code No.	Second Code No.			
			01	02	03	04
Quiet (low noise) operation	16(26)	0	Factory setting	—	Capacity priority setting	—

Exceptions

The Quiet (low noise) operation will be overruled in the following conditions:

- Pump down residual operation
- Startup control
- Defrost operation
- Oil recovery

Sound reduction

Model	RZQG71	RZQG100	RZQG125	RZQG140
Sound reduction	6 dBA	5 dBA	6 dBA	7 dBA

2.6 I-Demand Function

Purpose Set a limitation towards the power consumption from the system (e.g. budget control, limit power consumption during peak moments,..).

Setting 3 different demand setting can be selected by using terminal X801M:

- Demand 1 → Close contact between COM and contact 1
- Demand 2 → Close contact between COM and contact 2
- Demand 3 → Close contact between COM and contact 3

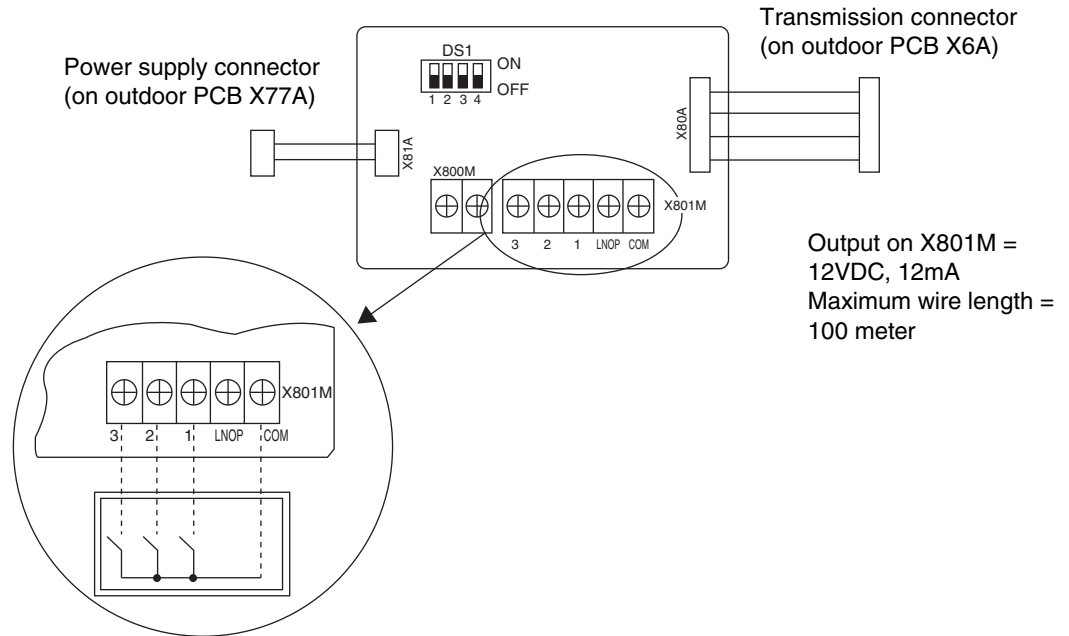

Demand 1

Power consumption limitation in function of setting on DS1:

DS1 Setting		ON OFF	Maximum Power Consumption
1	2		
OFF	OFF		60%
ON	OFF		70%
OFF	ON		80%
ON	ON		100%

Demand 2

Power consumption limitation set to 40%.

Demand 3

Forced thermostat OFF.

2.7 Setting for Low Humidity Application

Purpose Can be set when using the RZQG units for year round cooling in low humidity applications such as computer rooms (EDP rooms), technical rooms, etc...to increase the capacity of the unit.

Definition of Low Humidity Area

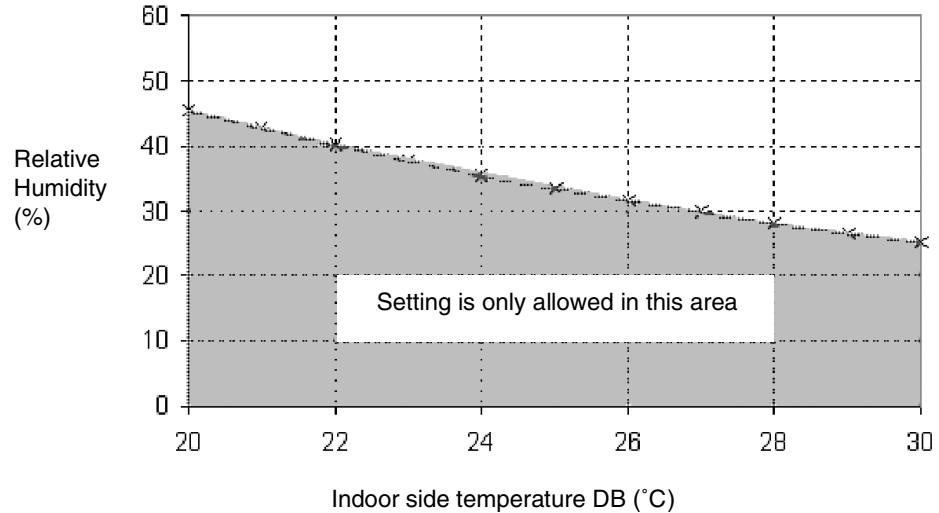

Caution When using the "LH settings" outside the "Low Humidity Area" there is an increased risk of ice accumulation on the indoor coil or water blowing out from the indoor unit.

Function details

		Factory setting	Low humidity application setting	Low humidity application + freeze up operation prevention
Field Setting		16(26)-2-01	16(26)-2-03	16(26)-2-04
Compressor control		<ul style="list-style-type: none"> The compressor frequency is controlled in function of the target evaporating temperature. The target evaporating temperature is controlled in function of the cooling load. 		
		Minimum target Te = 2°C	Minimum target Te = 0°C	Initial minimum target Te = 2°C, but can be changed in function of actual Te, to avoid freeze up activation: <ul style="list-style-type: none"> Te ≤ -1°C for 20 minutes accumulated => Change target Te ≥ 5°C Te ≤ -1°C for 30 minutes accumulated => Change target Te ≥ 8°C
		See graph 1	See graph 2	See graph 3
Freeze protection function	Start	Te ≤ -1°C for 40 minutes accumulated OR Te ≤ A°C for 1 minute continuous (Indoor decision)	Te ≤ -1°C for 40 minutes accumulated OR Te ≤ -3°C for 1 minute continuous (Outdoor decision)	Te ≤ -1°C for 40 minutes accumulated OR Te ≤ A°C for 1 minute continuous (Outdoor decision)
	End	Te > 7°C for 10 minutes continuously. (Indoor decision)	Te > 7°C for 3 minutes continuously OR Te > 4°C for 20 minutes continuously (Outdoor decision)	Te > 7°C for 3 minutes continuously OR Te > 4°C for 20 minutes continuously (Outdoor decision)

Parameters

	FCQG	FHQQ
A	-5°C	-3°C

Graph 1

Target evaporating temperature control in case of factory setting 16(26)-2-01:

Te target acceptable area

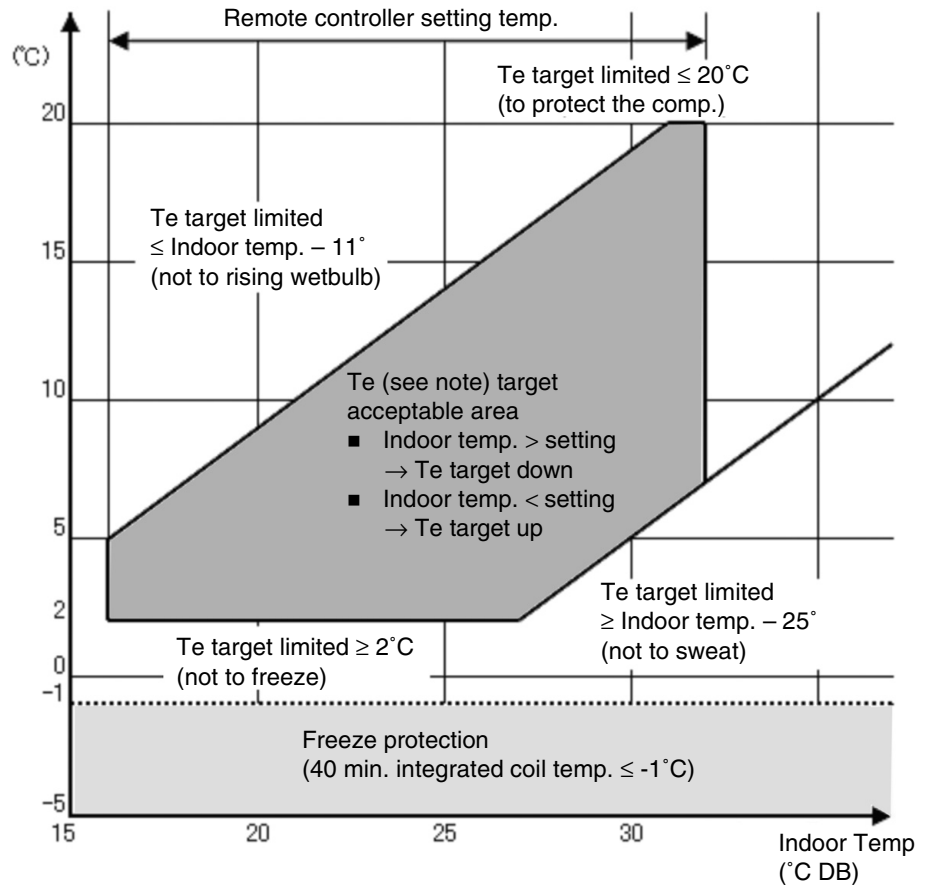

Graph 2

Target evaporating temperature control when "low humidity application" is selected. Field setting 16(26)-2-03:

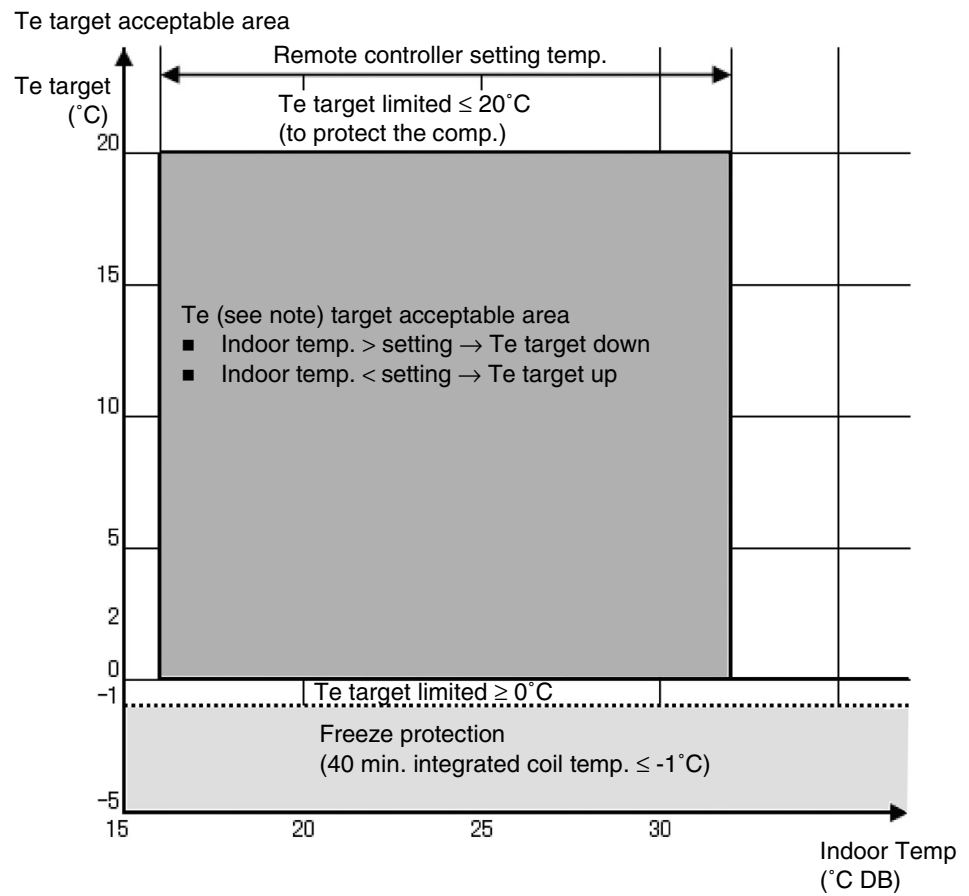

Graph 3

Target evaporating temperature control when "low humidity application + freeze up operation prevention" is selected. Field setting 16(26)-2-04:

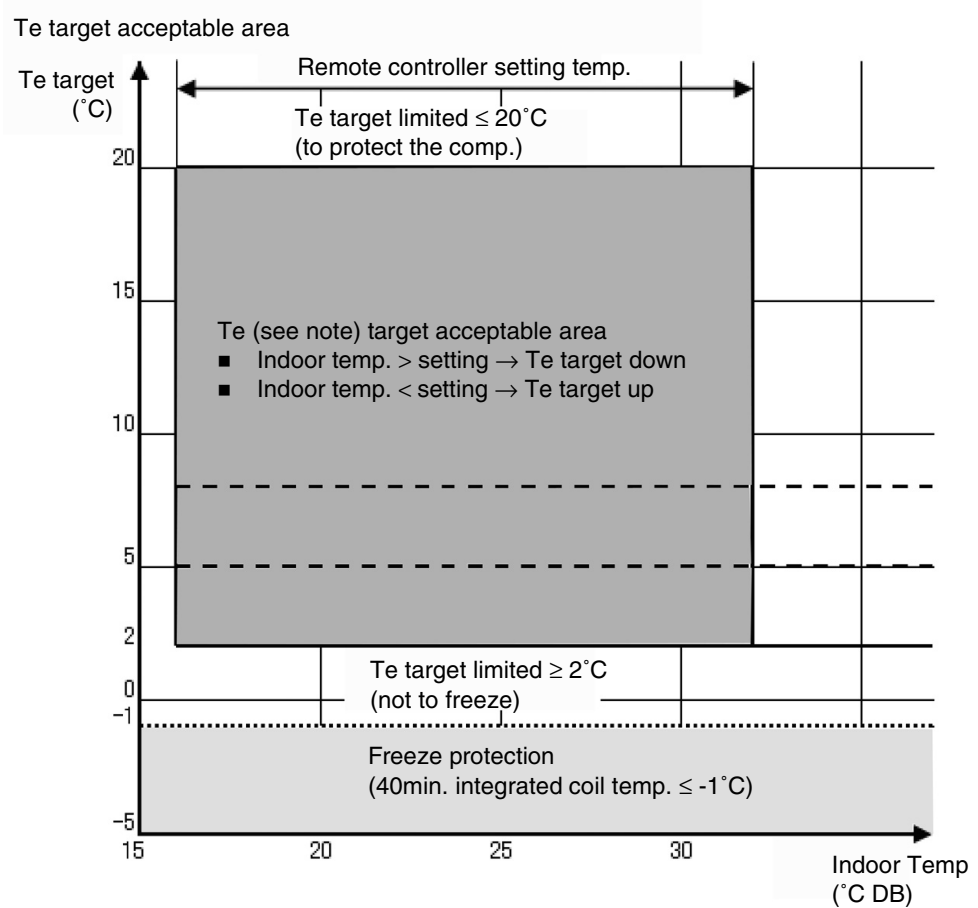

Change thermostat control

In order to increase continuous operation of the unit in low latent heat applications and avoid the rise of temperature after thermostat OFF, the thermostat control will be changed when using field settings 16(26)-2-03 & 16(26)-2-04.

Thermostat ON

- $\Delta Trs \geq 0.5 \text{ }^\circ\text{C}$ (No change from standard setting)

Thermostat OFF

- $\Delta Trs \leq -2.0 \text{ }^\circ\text{C}$ for 5 minutes continuously.
- $\Delta Trs \leq 4.5 \text{ }^\circ\text{C}$

2.8 Defrost Start Setting

Refer to "Defrost Operation" on page 48.

2.9 Slow start

Refer to "Slow start for EDP applications" on page 54.

3. Field Setting from Outdoor Unit PCB

3.1 Location of DIP Switch and BS Button

Various settings are available by using the DIP switches and the BS buttons on the PCB.

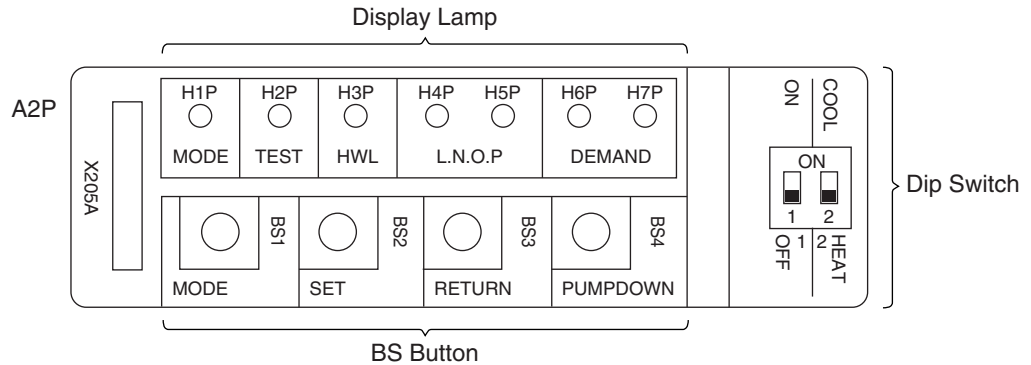

	Display		Function or Operating Procedure		
	Symbol	Name			
Display Lamp	H1P	MODE	During "Setting mode 1," the lamp is OFF (●).	During "Monitor mode," the lamp blinks (●).	
	H2P	TEST	During test operation in "Setting mode 1," the lamp is ON (○).	During "Monitor mode," the lamp is OFF (●).	
	H3P	HWL	When an error occurs during "Setting mode 1," the lamp turns ON (○).		
	H4P	L.N.O.P	During "Setting mode 1," low noise level is displayed.	During "Monitor mode," various combinations of the lamp indicate the following conditions: • Indication of oil return operation • Indication of outdoor unit class • Indication of error code (the latest and up to 2 cycles before) • Indication of causes of stepping-down	
	H5P				
	H6P				
	H7P	DEMAND	During "Setting mode 1," demand level is displayed.		
BS Button	BS1	MODE	Used to change "Setting mode".		
	BS2	SET	Used to change "Setting item" and "Setting condition".		
	BS3	RETURN	Used to decide "Setting item" and "Setting condition".		
	BS4	PUMP DOWN	Used for pump down operation, forced oil return operation and forced defrost operation.		
Dip Switch	DS1-1	ON	EMERGENCY	Switch from "OFF" to "ON" for emergency operation (forced operation).	
		OFF(*1)			
DS1-2	COOL	Maintain "HEAT" in case of heating in emergency operation, and switch to "COOL" in case of cooling in emergency operation.			
	HEAT(*1)				

*1. Factory settings: "OFF" and "HEAT"



Note:

BS button (Pump down / Forced defrosting)

Pressing the BS button forcibly operates the air conditioner in the cooling mode.

1. To conduct a pump-down operation (sending refrigerant to outdoor unit), press the BS button to forcibly operate the equipment in the cooling mode, then operate the unit for about 1 minute to stabilize the system. After stabilizing system, close the liquid pipe stop valve on the outdoor unit, and after the pressure decreases and the low pressure sensor activates, close the gas pipe stop valve.

2. Forced defrost

To activate the defrost operation during the heating operation, press the BS button. This will activate the forced defrost operation (cooling operation).

When the defrost cancel conditions are met, the equipment automatically switches off the defrost operation.

3.2 Field Setting for Outdoor Unit

3.2.1 Setting by BS Buttons

With "Setting mode 1," "Setting mode 2" and "Monitor mode," various settings and data can be checked.

(1) Setting mode 1

The initial status (normal operation) is "Setting mode 1." This mode indicates operating status - "TEST (test operation)," "HWL (error)," "L.N.O.P (night time quiet operation)" or "DEMAND (demand operation)."

(2) Setting mode 2

Each operating status can be modified.

(3) Monitor mode

This mode indicates "oil return operation," "outdoor unit class," "contents of retry," "contents of error," "causes of stepping-down operation," etc.

Using the MODE button, the modes can be changed as follows.

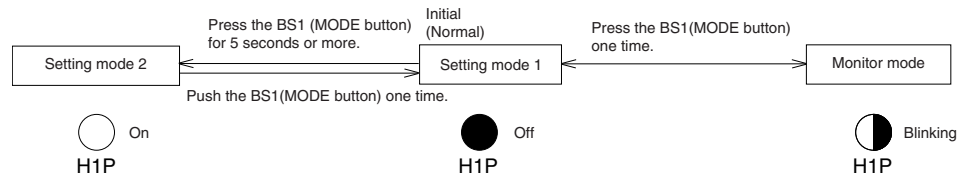

3.2.2 Setting Mode 1

In this mode, the following conditions can be checked:

- Current operating condition (normal/test operation/line inspection and normal/error)
- Night time quiet operation condition (normal/low noise level 1, 2, and)
- Demand operating condition (normal/30% demand/40% demand/50% demand)

These conditions above can be checked by performing the following steps:

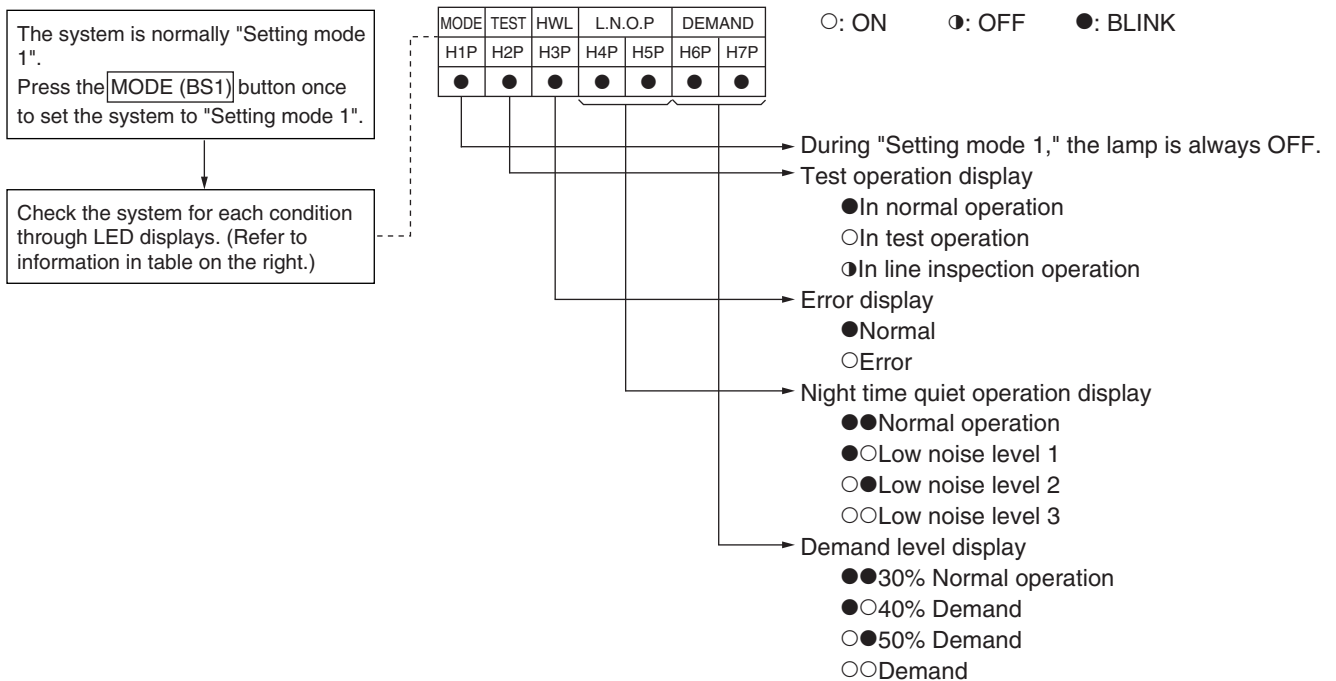

3.2.3 Setting Mode 2

In this mode, settings for the following items can be made.

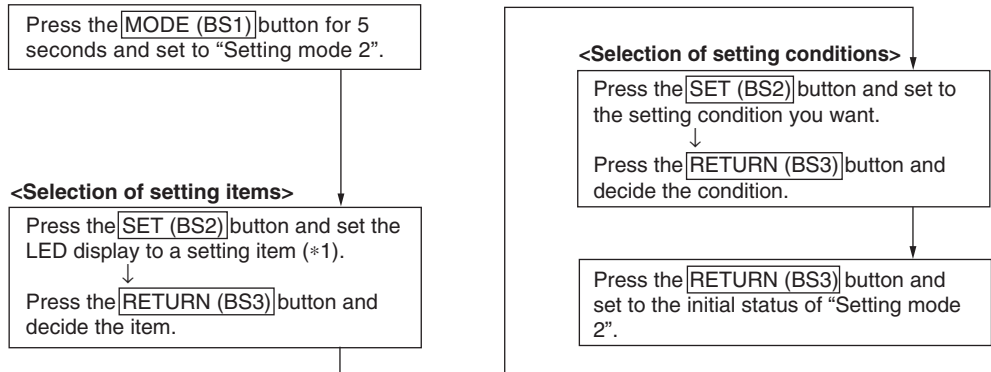

* If you become unsure of how to proceed, push the MODE (BS1) button and return to setting mode 1.

●: OFF ○: ON

No.	Display of setting items							Display of setting conditions								
	Setting items	LED display						Setting condition	LED Display							
		H1P	H2P	H3P	H4P	H5P	H6P		H7P	H1P	H2P	H3P	H4P	H5P	H6P	H7P
3	Demand 2 operation	○	●	●	●	●	○	○	30% Demand	○	●	●	●	○	●	●
									40% Demand (factory set)	○	●	●	●	●	○	●
									50% Demand	○	●	●	●	●	●	○
7	Reduced airflow (set to low noise level 1)	○	●	●	●	○	○	○	OFF	○	●	●	●	●	●	●
									ON	○	●	●	●	●	●	○
11	TeS Lower limit value	○	●	●	○	●	○	○	0°C	○	●	●	●	●	●	○
									2°C (factory set)	○	●	●	●	●	○	●
									4°C	○	●	●	●	●	○	○
									6°C	○	●	●	●	○	●	●
28	Refrigerant recovery mode	○	●	○	○	○	●	●	OFF (factory setting)	○	●	●	●	●	○	
									ON	○	●	●	●	●	○	●
33	TeS Lower limit value	○	○	●	●	●	●	○	0°C (factory set)	○	●	●	●	●	○	
									6°C	○	●	●	●	●	○	●
									9°C	○	●	●	●	●	○	○
									11°C	○	●	●	●	○	●	●
									13°C	○	●	●	●	○	○	○
									15°C	○	●	●	●	○	○	●
									17°C	○	●	●	●	○	○	○
Weather depending control in cooling	○	●	●	○	●	●	●									
34	TcS Upper limit value	○	○	●	●	●	○	●	60°C	○	●	●	●	●	○	
									50°C	○	●	●	●	●	○	●
									47°C	○	●	●	●	●	○	○
									45°C	○	●	●	●	○	●	●
									43°C	○	●	●	●	○	○	○
									Weather depending control in heating	○	●	●	●	○	○	●

●: OFF ○: ON

No.	Display of setting items							Display of setting conditions								
	Setting items	LED display						Setting condition	LED Display							
		H1P	H2P	H3P	H4P	H5P	H6P		H7P	H1P	H2P	H3P	H4P	H5P	H6P	H7P
53	Free cooling	○	○	○	●	○	●	○	X = OFF, Y = OFF (factory set)	○	●	●	●	●	●	○
									X = 0, Y = 5	○	●	●	●	●	○	●
									X = 2, Y = 5	○	●	●	●	●	○	○
									X = 4, Y = 5	○	●	●	●	○	●	●
									X = 0, Y = 10	○	●	●	●	○	●	○
									X = 2, Y = 10	○	●	●	●	○	○	●
									X = 4, Y = 10	○	●	●	●	○	○	○
54	Weather depending control TeS Lower limit value A	○	○	○	●	○	○	●	9°C (factory set)	○	●	●	●	●	●	○
									11°C	○	●	●	●	●	○	●
									13°C	○	●	●	●	●	○	○
									15°C	○	●	●	●	○	●	●
57	Weather depending control TeS Lower limit value B	○	○	○	○	●	●	○	2°C (factory set)	○	●	●	●	●	●	○
									4°C	○	●	●	●	●	○	●
									6°C	○	●	●	●	●	○	○
									8°C	○	●	●	●	○	●	●
58	Weather depending control TeS Lower limit value C	○	○	○	○	●	○	●	14°C (factory set)	○	●	●	●	●	●	○
									17°C	○	●	●	●	●	○	●
									20°C	○	●	●	●	●	○	○
									23°C	○	●	●	●	○	●	●
59	Weather depending control TeS Lower limit value D	○	○	○	○	●	○	○	23°C (factory set)	○	●	●	●	●	●	○
									27°C	○	●	●	●	●	○	●
									31°C	○	●	●	●	●	○	○
									35°C	○	●	●	●	○	●	●
60	Weather depending control TcS Upper limit value E	○	○	○	○	○	●	●	47°C (factory set)	○	●	●	●	●	●	○
									48°C	○	●	●	●	●	○	●
									49°C	○	●	●	●	●	○	○
									50°C	○	●	●	●	○	●	●
61	Weather depending control TcS Upper limit value F	○	○	○	○	○	●	○	43°C (factory set)	○	●	●	●	●	●	○
									44°C	○	●	●	●	●	○	●
									45°C	○	●	●	●	●	○	○
									46°C	○	●	●	●	○	●	●
62	Weather depending control TcS Upper limit value G	○	○	○	○	○	○	●	2°C (factory set)	○	●	●	●	●	●	○
									5°C	○	●	●	●	●	○	●
									8°C	○	●	●	●	●	○	○
									11°C	○	●	●	●	○	●	●
63	Weather depending control TcS Upper limit value H	○	○	○	○	○	○	○	15°C (factory set)	○	●	●	●	●	●	○
									18°C	○	●	●	●	●	○	●
									21°C	○	●	●	●	●	○	○
									24°C	○	●	●	●	○	●	●

↑ The figures in the columns under "No." represent the number of times to push the **SET (BS2)** button.

■ **Setting of Demand 2 operation**

With this setting, compressor operation can be controlled to reduce power consumption. (60% - 80% demand is available when a demand adapter (optional accessory) is used.)

Setting item	Setting condition	Description
Demand 2 operation	30% demand	Operates with 30% of rated power consumption.
	40% demand (factory setting)	Operates with 40% of rated power consumption.
	50% demand	Operates with 50% of rated power consumption.

[Work procedure]

●: OFF ○: BLINK ○: ON

Operating procedure		H1P	H2P	H3P	H4P	H5P	H6P	H7P
Push and hold the MODE (BS1) button of "Setting mode 1" for 5 seconds or more and set to "Setting mode 2."		○	●	●	●	●	●	●
Push the SET (BS2) button three times to set the LED display as shown in the table on the right.		○	●	●	●	●	○	○
Push the RETURN (BS3) button once. (Present settings are displayed.)		○	●	●	●	●	○	●
Push the SET (BS2) button to set the LED display as shown in the table on the right.	30% of rated power consumption	○	●	●	●	○	●	●
	40% of rated power consumption	○	●	●	●	●	○	●
	50% of rated power consumption	○	●	●	●	●	●	○
Push the RETURN (BS3) button once to make a decision.	30% of rated power consumption	○	●	●	●	○	●	●
	40% of rated power consumption	○	●	●	●	●	○	●
	50% of rated power consumption	○	●	●	●	●	●	○
Push the RETURN (BS3) button once again for execution. (The LED display is in the initial status of "Setting mode 2".)		○	●	●	●	●	●	●
Push the MODE (BS1) button once to return to Setting mode 1 (normal operation).		●	●	●	●	●	●	●

■ **Setting of Refrigerant Recovery Mode**

When a refrigerant recovery unit is connected onsite to recover refrigerant, fully open the expansion valve of the outdoor unit to help the recovery.

- (1) Stop operation.
- (2) Turn ON refrigerant recovery mode by performing the following steps.

●: OFF ○: BLINK ○: ON

Operating procedure	H1P	H2P	H3P	H4P	H5P	H6P	H7P
Press the MODE (BS1) button of "Setting mode 1" for 5 seconds or more and set to "Setting mode 2."	○	●	●	●	●	●	●
Press the SET (BS2) button 28 times to set the LED display as shown in the table on the right. (*1)	○	●	○	○	○	●	●
Press the RETURN (BS3) button once. (Present settings are displayed.)	○	●	●	●	●	●	○
Press the SET (BS2) button once to set the LED display as shown in the table on the right.	○	●	●	●	●	○	●
Press the RETURN (BS3) button once to make a decision.	○	●	●	●	●	○	●
When the RETURN (BS3) button is pressed once again, the electronic expansion valve opens fully.	○	●	●	●	●	●	●

- (3) Connect a refrigerant recovery unit to perform refrigerant recovery.
- (4) Upon completion of refrigerant recovery, turn OFF refrigerant recovery mode by taking the following steps or turning OFF the power of outdoor unit.

Operating procedure	H1P	H2P	H3P	H4P	H5P	H6P	H7P
Press the SET (BS2) button 28 times to set the LED display as shown in the table on the right. (*1)	○	●	○	○	○	●	●
Press the RETURN (BS3) button once. (Present settings are displayed.)	○	●	●	●	●	○	●
Press the SET (BS2) button once to set the LED display as shown in the table on the right.	○	●	●	●	●	●	○
Press the RETURN (BS3) button once to make a decision.	○	●	●	●	●	●	○
When the RETURN (BS3) button is pressed once again, the electronic expansion valve fully opens.	○	●	●	●	●	●	●



Note:

*1: If you become unsure how many times you have pushed the button, push the MODE (BS1) button once to return to "Setting mode 1" and start the operating procedure all over again.

3.2.4 Monitor Mode

In this mode, the following items can be checked by using the BS buttons.

To enter the monitor mode, press the **MODE (BS1)** button when in "Setting mode 1".

<Selection of setting item>

Press the **SET (BS2)** button and set the LED display to a setting item.

<Confirmation on setting contents>

Press the **RETURN (BS3)** button to display different data of set items.

Press the **RETURN (BS3)** button and switches to the initial status of "Monitor mode".

* Press the **MODE (BS1)** button and returns to "Setting mode 1".

No.	Setting item	LED display							Data display
		H1P	H2P	H3P	H4P	H5P	H6P	H7P	
0	Indication of oil return operation	●	●	●	●	●	●	●	See Data display (1).
1	Indication of outdoor unit class	●	●	●	●	●	●	○	See Data display (2).
2	Contents of retry (the latest)	●	●	●	●	●	○	●	See "Malfunction code display" on the next page.
3	Contents of retry (1 cycle before)	●	●	●	●	○	○		
4	Contents of retry (2 cycle before)	●	●	●	●	○	●	●	
5	Contents of malfunction (the latest)	●	●	●	●	○	●	○	
6	Contents of malfunction (1 cycle before)	●	●	●	●	○	○	●	
7	Contents of malfunction (2 cycle before)	●	●	●	●	○	○	○	
10	Indication of causes of stepping-down operation	●	●	●	○	●	○	●	See Data display (3).

The numbers in the "No." column represent the number of times to press the **SET (BS2)** button .

Data display (1)

Display contents	LED display						
	H1P	H2P	H3P	H4P	H5P	H6P	H7P
In normal operation	●	●	●	●	●	●	●
In oil return operation	●	●	●	●	●	●	○

Data display (2)

Display contents	LED display						
	H1P	H2P	H3P	H4P	H5P	H6P	H7P
No setting	●	●	●	●	●	●	○
RZQG71L	●	●	●	●	○	○	○
RZQG100L	●	●	●	○	●	●	●
RZQG125L	●	●	●	○	●	●	○
RZQG140L	●	●	●	○	●	○	●

Data display (3)

Display contents	LED display						
	H1P	H2P	H3P	H4P	H5P	H6P	H7P
Normal (not in stepping-down operation)	●	●	●	●	●	●	○
Low pressure stepping-down	●	●	●	●	●	○	●
High pressure stepping-down	●	●	●	●	●	○	○
Inverter discharge pipe stepping-down	●	●	●	●	○	●	●
Inverter current stepping-down	●	●	●	●	○	●	○
Radiation fin temperature stepping-down	●	●	●	●	○	○	●
Inverter stepping-down	●	●	●	●	○	○	○
Overall current stepping-down	●	●	●	○	●	●	●
Other stepping-down	●	●	●	○	●	●	○

3.2.5 List of Contents of Retry and Error

Take the following steps to check contents of retry and error.

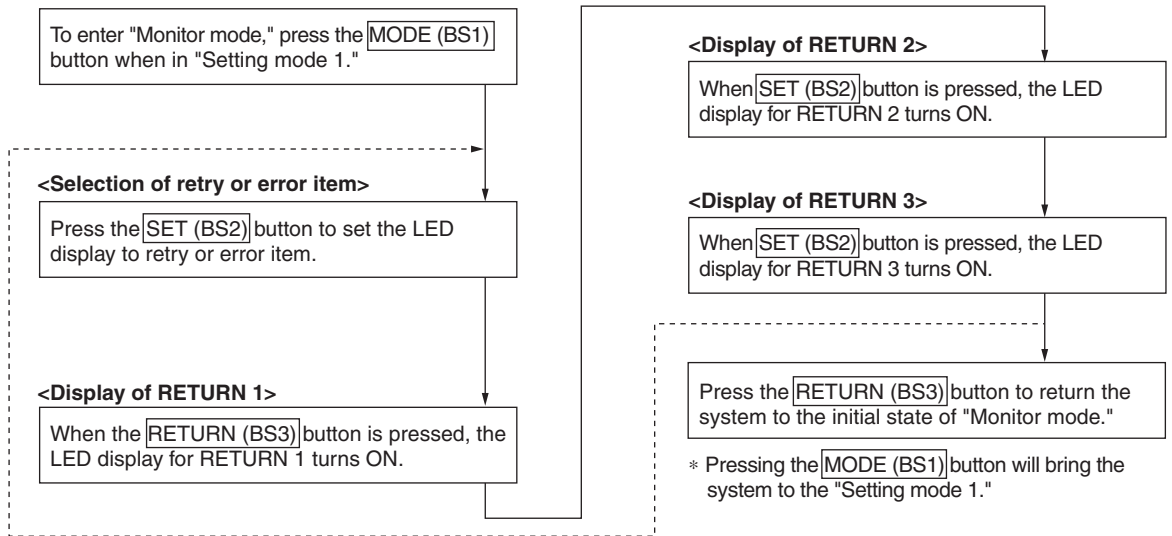

○: ON ●: OFF ◐: BLINK

Error code	Contents of retry or malfunction	Confirmation 1							Confirmation 2							Confirmation 3								
		H4P	H1P	H2P	H3P	H4P	H5P	H6P	H7P	H4P	H1P	H2P	H3P	H4P	H5P	H6P	H7P	H4P	H1P	H2P	H3P	H4P	H5P	H6P
C4	Indoor heat exchanger thermistor	◐	◐	○	●	●	●	◐	◐	◐	○	●	●	◐	◐	◐	◐	◐	○	○	●	●	●	●
E1	Faulty outdoor unit PCB	◐	◐	●	○	●	●	◐	◐	◐	○	●	●	◐	◐	◐	◐	◐	○	○	●	●	●	●
E3	Abnormal high pressure		◐	◐	○	●	●	◐	◐	◐	○	●	●	◐	◐	◐	◐	◐	○	○	●	●	●	●
E4	Abnormal low pressure		◐	◐	○	●	●	◐	◐	◐	○	●	●	◐	◐	◐	◐	◐	○	○	●	●	●	●
E5	Compressor motor lock		◐	◐	○	●	●	◐	◐	◐	○	●	●	◐	◐	◐	◐	◐	○	○	●	●	●	●
E7	Abnormal outdoor fan motor		◐	◐	○	●	●	◐	◐	◐	○	●	●	◐	◐	◐	◐	◐	○	○	●	●	●	●
	DC motor 1 lock																		◐	◐	○	○	●	●
	DC motor 2 lock																		◐	◐	○	○	●	●
E9	Abnormal electronic expansion valve																		◐	◐	○	○	●	●
	Abnormal inverter transmission																		◐	◐	○	○	●	●
	Disconnected electronic expansion valve connector																		◐	◐	○	○	●	●
F3	Abnormal discharge pipe temperature	◐	◐	●	○	●	●	◐	◐	◐	○	●	●	◐	◐	◐	◐	◐	○	○	●	●	●	●
	Disconnected discharge pipe thermistor																		◐	◐	○	○	●	●
H3	Abnormal high pressure switch	◐	◐	●	○	●	●	◐	◐	◐	○	●	●	◐	◐	◐	◐	◐	○	○	●	●	●	●
H9	Abnormal outdoor air thermistor		◐	◐	○	●	●	◐	◐	◐	○	●	●	◐	◐	◐	◐	◐	○	○	●	●	●	●
J1	Abnormal pressure sensor	◐	◐	●	○	●	●	◐	◐	◐	○	●	●	◐	◐	◐	◐	◐	○	○	●	●	●	●
J3	Abnormal discharge pipe thermistor		◐	◐	○	●	●	◐	◐	◐	○	●	●	◐	◐	◐	◐	◐	○	○	●	●	●	●
J5	Abnormal suction pipe thermistor		◐	◐	○	●	●	◐	◐	◐	○	●	●	◐	◐	◐	◐	◐	○	○	●	●	●	●
J6	Abnormal heat exchanger distributor pipe thermistor		◐	◐	○	●	●	◐	◐	◐	○	●	●	◐	◐	◐	◐	◐	○	○	●	●	●	●
J7	Abnormal intermediate heat exchanger thermistor		◐	◐	○	●	●	◐	◐	◐	○	●	●	◐	◐	◐	◐	◐	○	○	●	●	●	●
J8	Abnormal liquid pipe thermistor		◐	◐	○	●	●	◐	◐	◐	○	●	●	◐	◐	◐	◐	◐	○	○	●	●	●	●
L1	PCB failure	◐	◐	●	○	●	●	◐	◐	◐	○	●	●	◐	◐	◐	◐	◐	○	○	●	●	●	●
L4	Elevated radiation fin temperature		◐	◐	○	●	●	◐	◐	◐	○	●	●	◐	◐	◐	◐	◐	○	○	●	●	●	●
L5	Compressor instantaneous overcurrent		◐	◐	○	●	●	◐	◐	◐	○	●	●	◐	◐	◐	◐	◐	○	○	●	●	●	●
L8	Compressor overload		◐	◐	○	●	●	◐	◐	◐	○	●	●	◐	◐	◐	◐	◐	○	○	●	●	●	●
L9	Compressor lock		◐	◐	○	●	●	◐	◐	◐	○	●	●	◐	◐	◐	◐	◐	○	○	●	●	●	●
LC	Abnormal transmission (between the control and the inverter)		◐	◐	○	●	●	◐	◐	◐	○	●	●	◐	◐	◐	◐	◐	○	○	●	●	●	●
P1	Unbalanced power supply voltage	◐	◐	●	○	●	●	◐	◐	◐	○	●	●	◐	◐	◐	◐	◐	○	○	●	●	●	●
P4	Abnormal radiation fin thermistor		◐	◐	○	●	●	◐	◐	◐	○	●	●	◐	◐	◐	◐	◐	○	○	●	●	●	●
PJ	Faulty capacity setting		◐	◐	○	●	●	◐	◐	◐	○	●	●	◐	◐	◐	◐	◐	○	○	●	●	●	●
U0	Abnormal refrigerant shortage	◐	◐	●	○	●	●	◐	◐	◐	○	●	●	◐	◐	◐	◐	◐	○	○	●	●	●	●
	Refrigerant shortage warning																		◐	◐	○	○	●	●
U2	Abnormal power supply voltage		◐	◐	○	●	●	◐	◐	◐	○	●	●	◐	◐	◐	◐	◐	○	○	●	●	●	●
	Inverter undervoltage and overvoltage																		◐	◐	○	○	●	●
U4	SP-PAM overvoltage																		◐	◐	○	○	●	●
UA	Abnormal transmission (between indoor and outdoor units)		◐	◐	○	●	●	◐	◐	◐	○	●	●	◐	◐	◐	◐	◐	○	○	●	●	●	●
UF	Faulty field setting switch		◐	◐	○	●	●	◐	◐	◐	○	●	●	◐	◐	◐	◐	◐	○	○	●	●	●	●
UF	Improper piping and improper communication wiring																		◐	◐	○	○	●	●

3.2.6 List of Detailed Error Codes (SkyAir)

Indoor unit

Error code	Troubleshooting	
	Description of error	Description of diagnosis
R6 - 01	Fan motor locked	A locked fan motor current has been detected. Turn the fan by hand to check for the connection of connectors.
R6 - 10	Fan overcurrent error	A fan motor overcurrent has been detected. Check for the connection of the connector between the fan motor and the PC board for the fan. If the connection is normal, replace the fan motor. If this still cannot solve the error, replace the PC board for the fan.
R6 - 11	Fan position detection error	An error in the detection of position of the fan motor. Check for the connection of the connector between the fan motor and the PC board for the fan. If the connection is normal, replace the fan motor. If this still cannot solve the error, replace the PC board for the fan.
R4 - 03	Transmission error (between the self-cleaning decoration panel and the indoor unit) [when the self-cleaning decoration panel is mounted]	Check for the connection of the harness connector between the panel PC board and the indoor unit PC board.
R4 - 04	Dust detection sensor error [when the self-cleaning decoration panel is mounted]	Check for the connections of the connector X12A on the panel PC board and the connectors X18A and X19A on the sensor PC board.
R4 - 05	Dust collection sign error [when the self-cleaning decoration panel is mounted]	Check for clogging with dust at the dust collection port as well as in the brush unit, S-shaped pipe, and dust box. Furthermore, check for any stains of the light, receiving and emitting parts of the infrared unit.
R4 - 06	Air filter rotation error [when the self-cleaning decoration panel is mounted]	Check for anything getting in the way of rotating the filter (e.g. the filter comes off or the drive gear is clogged with foreign matters).
R4 - 07	Damper rotation error [when the self-cleaning decoration panel is mounted]	The damper does not rotate normally. Check for any foreign matters around the damper and for the operation of the gear and limit switch.
R4 - 08	Filter self-cleaning operation error [when the self-cleaning decoration panel is mounted]	The unit has not yet completed the filter self-cleaning operation even after the lapse of specified period of time. Check for any external noise, etc.
E6 - 01	Faulty combination of indoor unit PC board and fan PC board	A combination of indoor unit PC board and fan PC board is faulty. Check whether the capacity setting adapter is correct and the type of the fan PC board is correct.

Outdoor unit

Error code	Troubleshooting	
	Description of error	Description of diagnosis
E7 - 01	Fan motor lock	The fan motor has caused abnormal rotation. Check for the connection of the connector between the fan motor and the outdoor unit PC board. If the connection is normal, replace the fan motor. If this still cannot solve the error, replace the outdoor unit PC board.
L1 - 01	Instantaneous overcurrent error (while in startup operation)	Refer to the “L” flow chart of each manual and make a diagnosis of the relevant unit based on the Error code shown to the left.
L1 - 02	Current sensor error in PC board	
L1 - 03	Current offset error	
L1 - 04	IGBT error	
L1 - 05	Jumper setting error	
L1 - 06	SP/MP-PAM overvoltage error	
L1 - 54	Interleave error	There is a possibility of failure on circuits inside Inverter PCB. Refer to the “L” Troubleshooting flow chart and make a diagnosis for the PCB.
L8 - 01	Electronic thermal 1 error	Overload current continues for a period of 280 seconds or more. This error is supposed to have resulted from excessive charging of refrigerant, damage caused to the compressor bearing, too high-pressure, etc. Check and probe the cause.
L8 - 02	Electronic thermal 2 error	Overload current close to the locked current flowed in the thermal for a period of five seconds. This error is supposed to have resulted from closed stop valve, disconnected wire in the compressor motor, etc. Check and probe the cause.
L8 - 03	Drop in compressor revolutions	Compressor load has been increased after startup. This error is supposed to have resulted from instantaneous power failure, liquid back, etc. Check and probe the cause.
L8 - 04	Thunder detection error	Surges caused by thunder.
L8 - 05	Inverter limiting current	Excessive limiting current is flowing in the inverter. This error is supposed to have resulted from failure to open the stop valve, excessive charging of refrigerant, clogging in the indoor unit filter stain in the indoor/outdoor unit heat exchanger etc. Check and probe the cause.
L9 - 01	Stall prevention (current increase)	Overload current has been applied to start up the compressor. This error is supposed to have resulted from high startup differential pressure, liquid back, excessive compressor oil, abnormal compressor coil, seizure of the compressor shaft, etc. Check and probe the cause.
L9 - 02	Stall prevention (startup error)	The compressor has not completed startup operation. This error is supposed to have resulted from high startup differential pressure, liquid back, excessive compressor oil, abnormal compressor coil, seizure of the compressor shaft, faulty position detection circuit, etc. Check and probe the cause.
LC - 01	Faulty wiring	Faulty transmission including that caused when the power supply turns ON. This error is supposed to have resulted from ①defective wire connections around the PC board, ②faulty outdoor unit PC board, or ③faulty fan motor. Check and probe the cause.
LC - 02	Faulty transmission between compressor and micro controller	There is an error in transmission between the compressor and the outdoor unit PC board. If the wire connections of the compressor are normal, check for the same of the outdoor unit PC board.
PJ - 01	Capacity setting not made	This is an outdoor unit PC board for repair, but has no capacity setting adapter connected. Connect a correct capacity setting adapter to the PC board.
PJ - 04	Faulty capacity setting	This error results from a mismatch of signals between the controller in the PC board and the inverter. Check whether the type of the PC board is correct and correct capacity setting adapter is connected.

3.2.7 Troubleshooting

Error code	Troubleshooting	
	Description of error	Description of diagnosis
U0 - 02	Gas shortage - Outdoor unit (Factor 0)	This error results from a shortage of refrigerant. Refer to the "U0" Troubleshooting flow chart and make a diagnosis, and then take countermeasures.
U0 - 03	Gas shortage - Outdoor unit (Factor 1)	This error results from a shortage of refrigerant cause by gas leakage. Charge refrigerant up to the normal refrigerant amount.
U0 - 04	Gas shortage - Outdoor unit (Factor 2)	This error results from clogging caused somewhere in the refrigerant piping system. Check for a failure to open the stop valve and clogging in the refrigerant system.
U2 - 01	Power supply voltage error	This error is supposed to have resulted from under- or over-voltage of the power supply, or faulty voltage sensor in the PC board.
U2 - 02	Open phase of power supply	Check for any open phase of the power supply.
U2 - 03	Main circuit capacitor charge error	There is abnormal circuit current flowing in the PC board. If wire connections related to the PC board are normal, replace the outdoor unit PC board.
U2 - 04	SP/MP-PAM overvoltage error	There is overvoltage between SP/MP and PAM (single phase). If wire connections related to the PC board are normal, replace the outdoor unit PC board.
U2 - 35	AC voltage sensor error	A failure of the power supply sensors was detected in the circuit board. Refer to the "U2" Troubleshooting flow chart and make a diagnosis for the PCB.
UR - 01	Incorrect number of indoor units connected	This error will be displayed if the locally-set number of indoor units is different from the detected number of indoor unit.
UR - 02	Multiple master units detected	There are a number of indoor units with a remote controller connected. Connect the remote controller to only one indoor unit.
UR - 03	Excess indoor units connected	This error will be displayed if five or more indoor units are connected.
UR - 05	Indoor-Outdoor transmission error between slave 1 and outdoor unit	There is an error in transmission between the outdoor unit and slave indoor unit 1. Check for the connection of the jumper between the slave indoor unit (with no remote controller connected) and the outdoor unit.
UR - 07	Indoor-Outdoor transmission error between slave 2 and outdoor unit	There is an error in transmission between the outdoor unit and slave indoor unit 2. Check for the connection of the jumper between the slave indoor unit (with no remote controller connected) and the outdoor unit.
UR - 09	Indoor-Outdoor transmission error between slave 3 and outdoor unit	There is an error in transmission between the outdoor unit and slave indoor unit 3. Check for the connection of the jumper between the slave indoor unit (with no remote controller connected) and the outdoor unit.
UF - 01	Incorrect wiring	There is an error in wire connections for transmission between indoor and outdoor units (judged with the indoor unit). Check for the connections of jumpers 1, 2 and 3 between the indoor and outdoor units.
UF - 02	Piping connected the other way round	There is an error in operation mode and refrigerant piping detection temperature. Check for any refrigerant piping connected the other way round, shortage of refrigerant, etc.

4. Emergency Operation

4.1 Forced Operation

As emergency operational methods, there are three methods as shown below. Choose the best method that is suitable for each purpose of use.

	Name	Application	Setting method	Operation				Remark
				Thermistor detection	Activation of protection device	Fan	Drain Pump	
(1)	Emergency operation (Forced operation)	Forced operation in service	By SS1 switch of indoor unit PCB	×	×	○	○	No temperature control
			By DS switch of outdoor unit PCB	×	×	○	—	
(2)	Test Operation	When checking the operation after installation	By Inspection / Test Operation button of the remote controller	×	○	○	○	No temperature control
			By Test Operation button of outdoor PCB					
(3)	Emergency operation	When the wireless remote controller is lost	Press the "Emergency operation" switch of the indoor unit panel.	○	○	○	○	Remote controller transmission stop, actuators such as fan and pump are ON

Emergency Operation (Forced operation)

1. Turn off the power supply.
2. Changeover the switch of indoor unit PCB (SS1) from NORM (Normal) to EMG (Emergency).

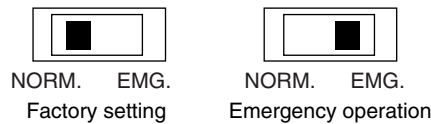

3. Changeover the switches of outdoor unit PCB (DS1) as shown below.

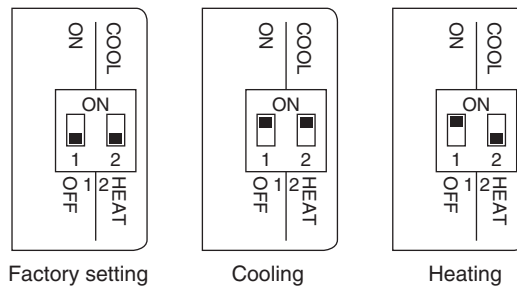

4. When the power is turned ON, the operation will be forcibly activated.

(Precautions)

1. Make sure that the power is turned off before changing the switch.
2. When returning to the normal operation, make sure that the power is turned off before returning each switch to the original position.
3. When the protection device is activated during the emergency operation, the unit stops the operation once and restarts three minutes later.
4. When there is an error on PCB, the emergency operation cannot be used.

Operation by the Test Operation Mode

As test run by the test operation mode, there are two methods as shown below.

<Test Operation by Wireless Remote Controller>

1. Press the Inspection / Test Operation button 4 times.

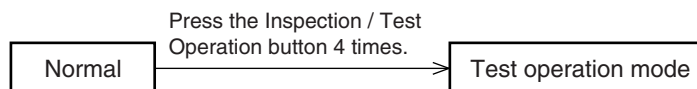

2. When you press the [ON / OFF] button after setting the test run mode, the test run starts.

<Test Operation by Outdoor Unit PCB>

1. Press the Test Operation (BS4) button on outdoor unit PCB for 5 seconds. After a while, the test operation starts.

(Reference)

- For the initial operation after installation of the unit, forced cooling operation continues for three minutes.
- For the second operation and afterwards after installation, the unit forcibly operates for 30 minutes in the set mode.

Part 5

Service Diagnosis

1. Maintenance Inspection	97
1.1 Overview	97
2. Symptom-based Troubleshooting	99
2.1 Overview	99
2.2 Equipment does not Operate	100
2.3 Indoor Unit Fan Operates, but Compressor does not Operate	102
2.4 Cooling / Heating Operation Starts but Stops Immediately	104
2.5 After Unit Shuts Down, It cannot be Restarted for a While	105
2.6 Equipment Operates but does not Provide Cooling	107
2.7 Equipment Operates but does not Provide Heating	109
2.8 Equipment Discharges White Mist	111
2.9 Equipment Produces Loud Noise or Vibration	112
2.10 Equipment Discharges Dust	113
2.11 Remote Controller LCD Displays "88"	114
2.12 Swing Flap does not Operate	115
3. Troubleshooting by LED Indications	117
3.1 Troubleshooting by LED on the Indoor Unit	117
3.2 Troubleshooting by LED on Outdoor Unit PCB	117
4. Troubleshooting by Remote Controller	118
4.1 Procedure of Self-diagnosis by Remote Controller	118
4.2 Error Codes and Description	122
4.3 Safety Devices	123
4.4 Indoor Unit PCB Abnormality	124
4.5 Drain Water Level System Abnormality	125
4.6 Indoor Unit Fan Motor Abnormality	127
4.7 Capacity Setting Abnormality	128
4.8 Transmission Error (between Indoor Unit PCB and Adaptor PCB)	129
4.9 Thermistor Abnormality	131
4.10 Humidity Sensor System Abnormality	132
4.11 Malfunction of Motion Sensor / Floor Temperature Sensor	133
4.12 Remote Controller Thermistor Abnormality	138
4.13 Outdoor Unit PCB Abnormality	139
4.14 High Pressure Abnormality (Detected by the High Pressure Switch) ..	140
4.15 Actuation of Pressure Sensor	142
4.16 Compressor Motor Lock	144
4.17 Outdoor Unit Fan Motor Abnormality	145
4.18 Electronic Expansion Valve Abnormality	147
4.19 Discharge Pipe Temperature Control	150
4.20 High Pressure Switch System Abnormality	152
4.21 Low Pressure Switch System Abnormality	153
4.22 Thermistor System Abnormality	154
4.23 Outdoor Unit PCB Abnormality	155
4.24 Radiation Fin Temperature Rise	157
4.25 Output Overcurrent Detection	159
4.26 Electronic Thermal (Time Lag)	161

4.27 Stall Prevention (Time Lag)	163
4.28 Transmission System Abnormality (between Control and Inverter PCB)	165
4.29 Open Phase or Power Supply Voltage Imbalance	166
4.30 Defective Capacity Setting	167
4.31 Refrigerant Shortage (Alert)	168
4.32 Refrigerant Shortage (Error)	169
4.33 Power Supply Voltage Abnormality	171
4.34 Transmission Error between Indoor and Outdoor Unit	173
4.35 Transmission Error Between Remote Controller and Indoor Unit	176
4.36 Transmission Error between MAIN Remote Controller and SUB Remote Controller	177
4.37 Field Setting Switch Abnormality	178
4.38 “L” Address Duplication of Centralized Controller	180
4.39 Transmission Error Between Centralized Controller and Indoor Unit ..	181
4.40 Transmission Error between Indoor and Outdoor Unit / Piping and Wiring Mismatch / Refrigerant Shortage	183
4.41 Check	185

1. Maintenance Inspection

1.1 Overview

When performing maintenance, you should at least perform the following inspections:

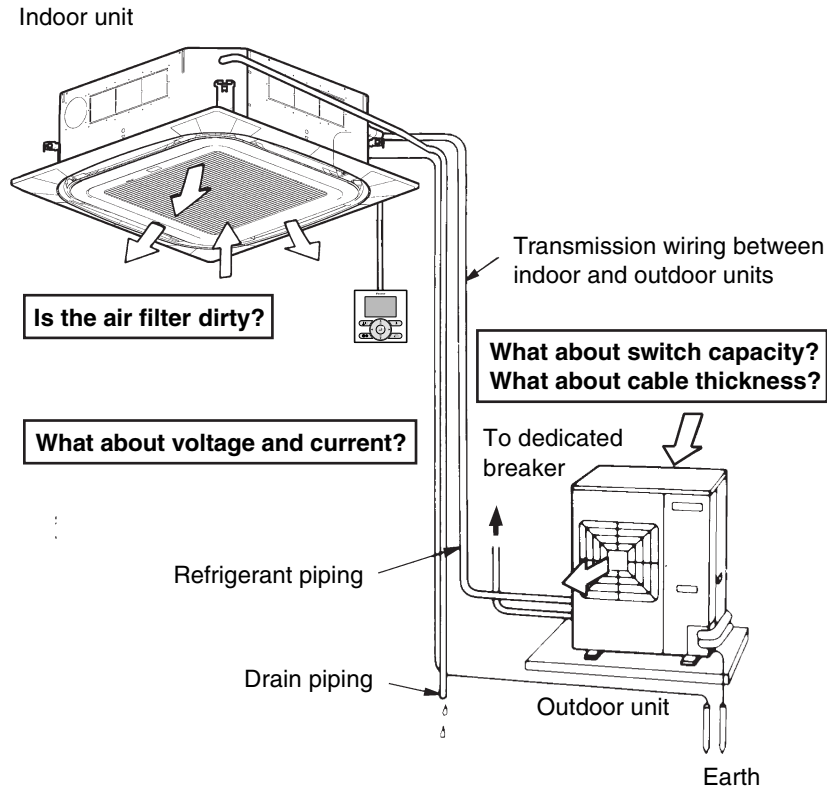

Guide Lines for Optimal Operation Condition

The operation value guide lines when operating under standard conditions by pushing the test operation button on the remote controller are as given in the table below.

Indoor unit fan: H tap

	High Pressure	Low Pressure	Discharge Pipe Temperature	Suction Temperature	Indoor Unit: Temperature Differential between Suction Air and Discharge Air	Outdoor Unit: Temperature Differential between Suction Air and Discharge Air
Cooling	2.62 MPa ~ 3.39 MPa	0.60 MPa ~ 0.98 MPa	60°C~100°C	-2°C~10°C	8°C~18°C	7°C~12°C
Heating	2.53 MPa ~ 3.27 MPa	0.53 MPa ~ 0.75 MPa	60°C~100°C	-6°C~2°C	14°C~30°C	2°C~6°C

Standard Conditions

	Indoor	Outdoor
Cooling Operation	27°CDB/19°CWB	35°CDB
Heating Operation	20°CDB	7°CDB/6°CWB

During or after maintenance, when the power supply is turned back on, operation restarts automatically by the “auto restart function.” Please exercise the proper caution.

Correlation of Air-Conditioner's Operation Status and Pressure / Running Current

What happens in comparison to normal values is summarized in the table below.
(Measured for 15 ~ 20 minutes or more after operation starts.)

Cooling

Air-Conditioner Status	Low Pressure	High Pressure	Running Current
Air Filter Fouling	Lower	Lower	Lower
Short Circuit of Indoor Unit Inlet/Outlet Air	Lower	Lower	Lower
Outdoor Unit Fin Fouling	Higher	Higher	Higher
Short Circuit of Outdoor Unit Inlet/Outlet Air	Higher	Higher	Higher
Air Mixed in Refrigerant	Higher	Higher	Higher
Water Mixed in Refrigerant	Lower *1	Lower	Lower
Dirt Mixed in Refrigerant	Lower *2	Lower	Lower
Refrigerant Shortage	Lower	Lower	Lower
Unsatisfactory Compression	Higher *3	Lower	Lower

Heating

Air-Conditioner Status	Low Pressure	High Pressure	Running Current
Air Filter Fouling	Higher	Higher	Higher
Short Circuit of Indoor Unit Inlet/Outlet Air	Higher	Higher	Higher
Outdoor Unit Fin Fouling	Lower	Lower	Lower
Short Circuit of Outdoor Unit Inlet/Outlet Air	Lower	Lower	Lower
Air Mixed in Refrigerant	Higher	Higher	Higher
Water Mixed in Refrigerant	Lower *1	Lower	Lower
Dirt Mixed in Refrigerant	Lower *2	Lower	Lower
Refrigerant Shortage	Lower	Lower	Lower
Unsatisfactory Compression	Higher *3	Lower	Lower



Note:

- *1. Water in the refrigerant freezes inside the capillary tube or electronic expansion valve, and is basically the same phenomenon as pump down.
- *2. Dirt in the refrigerant clogs filters inside the piping, and is basically the same phenomenon as pump down.
- *3. Pressure differential between high and low pressure becomes low.

2. Symptom-based Troubleshooting

2.1 Overview

	Symptom	Details of Measures
1	Equipment does not operate.	Refer to P.100
2	Indoor fan operates, but compressor does not operate.	Refer to P.102
3	Cooling/heating operation starts but stops immediately.	Refer to P.104
4	After unit shuts down, it cannot be restarted for a while.	Refer to P.105
5	Equipment operates but does not provide cooling.	Refer to P.107
6	Equipment operates but does not provide heating.	Refer to P.109
7	Equipment discharges white mist.	Refer to P.111
8	Equipment produces loud noise or vibration.	Refer to P.112
9	Equipment discharges dust.	Refer to P.113
10	Remote controller LCD displays "88".	Refer to P.114
11	Indoor swing flap does not operate.	Refer to P.115
12	Equipment emits odor.	Room smell and cigarette odors accumulated inside the indoor unit are discharged with air. Inside of the indoor unit must be cleaned.
13	Flap operates when power is turned on.	It is normal. The flap initializes for accurate positioning.
14	Change of operation mode causes flap to move.	It is normal. There is a control function that moves the flap when operation mode is changed.
15	Fan operates in "M" tap during heating even if remote controller is set to "L" tap.	It is normal. It is caused by the activation of the overload control (airflow shift control).
16	Flap automatically moves during cooling.	It is normal. It is caused by the activation of the dew condensation prevention function or ceiling soiling prevention function.
17	Indoor unit fan operates in "L" tap for 1 minute in "program dry" mode even if compressor is not operating.	It is normal. The monitoring function forcibly operates the fan for 1 minute.
18	Indoor unit fan operates after heating operation stops.	It is normal. The fan operates in the "LL" tap for 60 to 100 seconds to dissipate the residual heat in the heater.
19	Drain pump operates when equipment is not operating.	It is normal. The drain pump continues to operate for several minutes after equipment is turned off.
20	Horizontal swing sends air to different directions in cooling and heating even if it is set to the same position.	It is normal. The airflow direction in cooling/dry operation is different from that in heating/fan operation.
21	Flap remains horizontal even if it is set to swing mode.	It is normal. The flap does not swing in the thermostat OFF mode.
22	When operating in remote control thermostat, the thermostat turns off before temperature of remote control reaches the set temperature.	Normal operation. The thermostat may be controlled with the suction temperature (body thermostat), concurrently with the set temperature.

2.2 Equipment does not Operate

Applicable Model All models of SkyAir series

Supposed Causes

- Fuse blown or disorder of contact in operation circuit
- Defective operation switch or contact point
- Defective high pressure switch
- Defective magnetic switch for fan motor
- Activation or fault of overcurrent relay for fan motor
- Defective overcurrent relay for compressor
- Defective compressor protection thermostat
- Insufficient insulation in electric system
- Defective contact point of magnetic switch for compressor
- Defective compressor
- Defective remote controller or low batteries (wireless)
- Incorrect address setting of wireless remote controller

Troubleshooting



Caution Be sure to turn off power switch before connect or disconnect connector, or parts damage may be occurred.

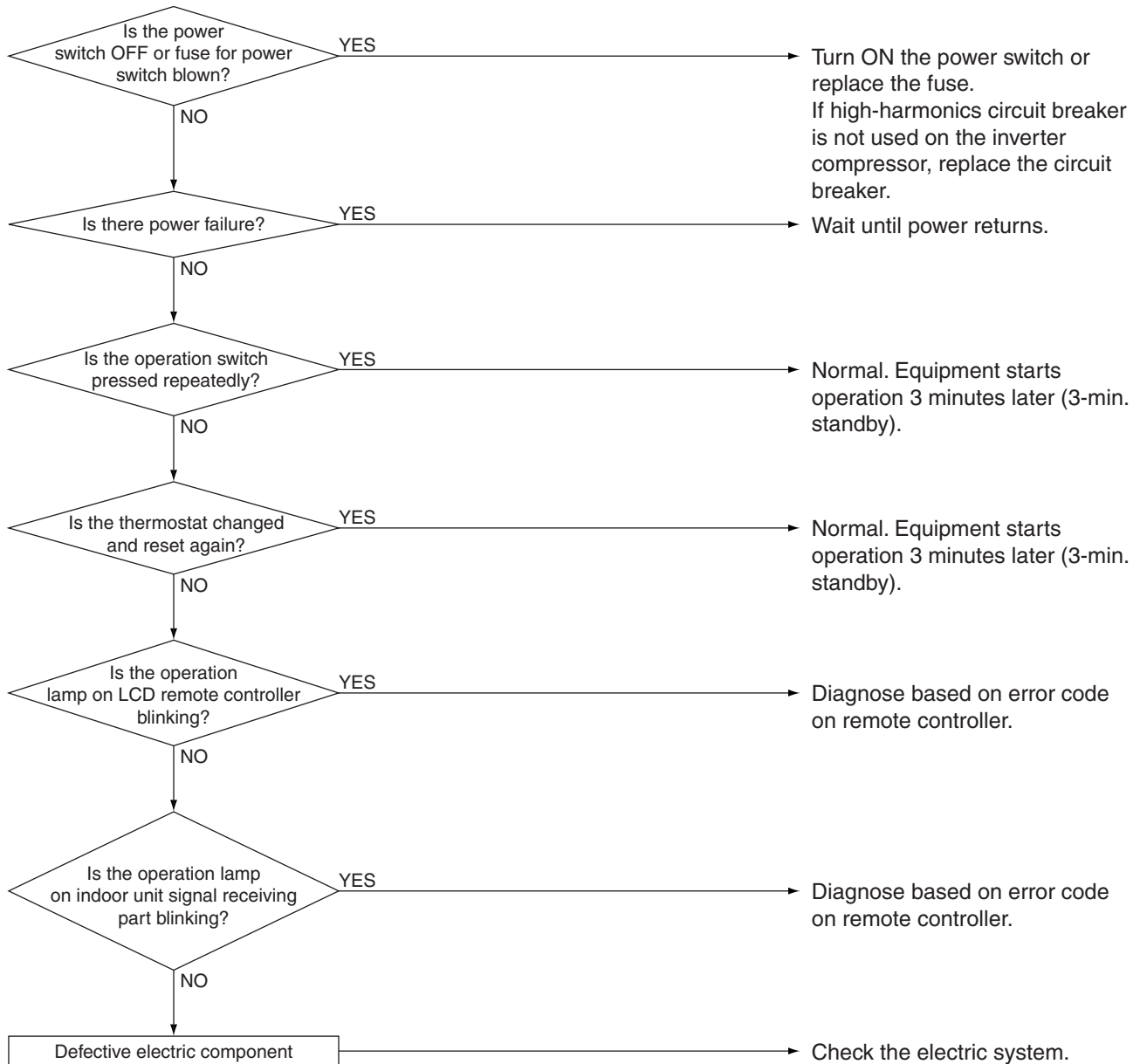

2.3 Indoor Unit Fan Operates, but Compressor does not Operate

Applicable Model All models of SkyAir series

Supposed Causes

- Fuse blown or disorder of contact in operation circuit
- Defective thermistor
- Defective indoor/outdoor unit PCB
- Defective magnetic switch
- Defective power transistor
- Defective compressor

Troubleshooting



Caution Be sure to turn off power switch before connect or disconnect connector, or parts damage may be occurred.

- Indoor unit fan runs at set airflow rate.
- (In cooling operation)
When suction air thermistor temperature is higher than set temperature
- (In heating operation)
When suction air thermistor temperature is lower than set temperature

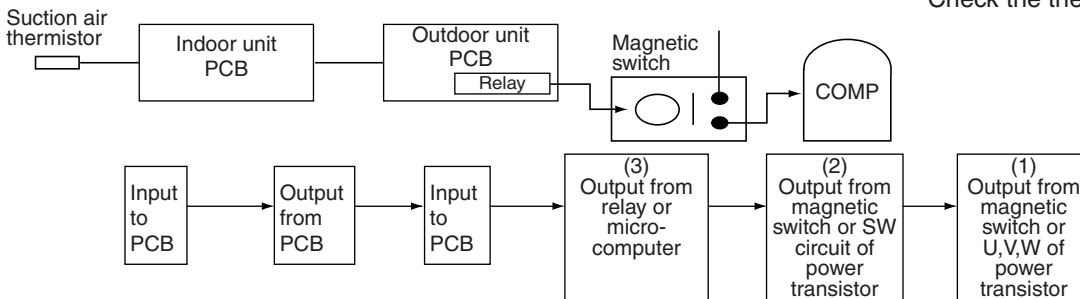
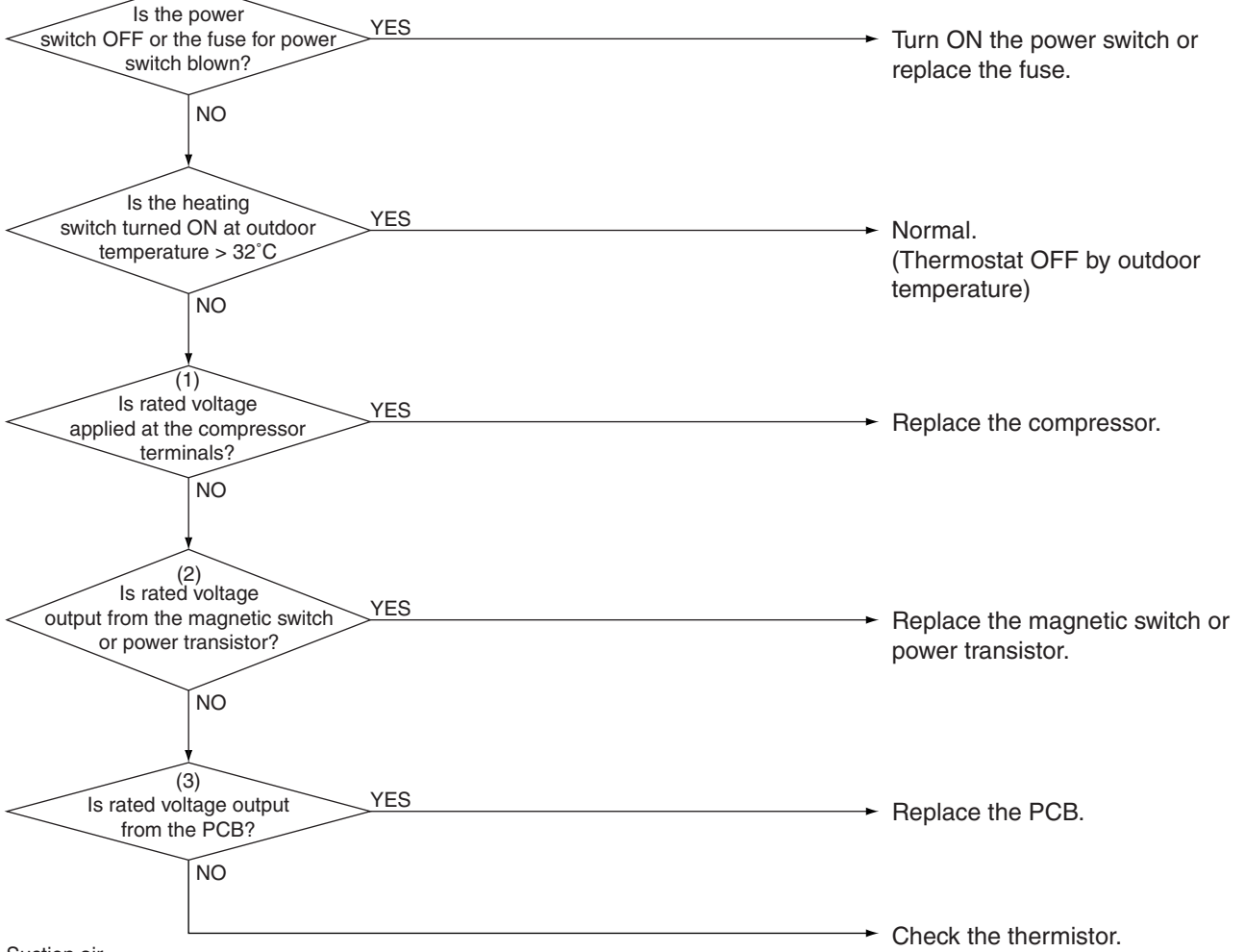

2.4 Cooling / Heating Operation Starts but Stops Immediately

Applicable Model All models of SkyAir series

- Supposed Causes**
- Overcharge of refrigerant
 - Air mixed in refrigerant system
 - Defective pressure switch
 - Defective magnetic switch for outdoor unit fan motor
 - Defective aux. relay for outdoor unit fan motor
 - Soiled heat exchanger of outdoor unit
 - There is an interfering item in airflow of outdoor unit.
 - Defective outdoor unit fan
 - Soiled air filter of indoor unit
 - Soiled heat exchanger of indoor unit
 - There is some interfering item in airflow of indoor unit.
 - Defective indoor unit fan

Troubleshooting



Caution Be sure to turn off power switch before connect or disconnect connector, or parts damage may be occurred.

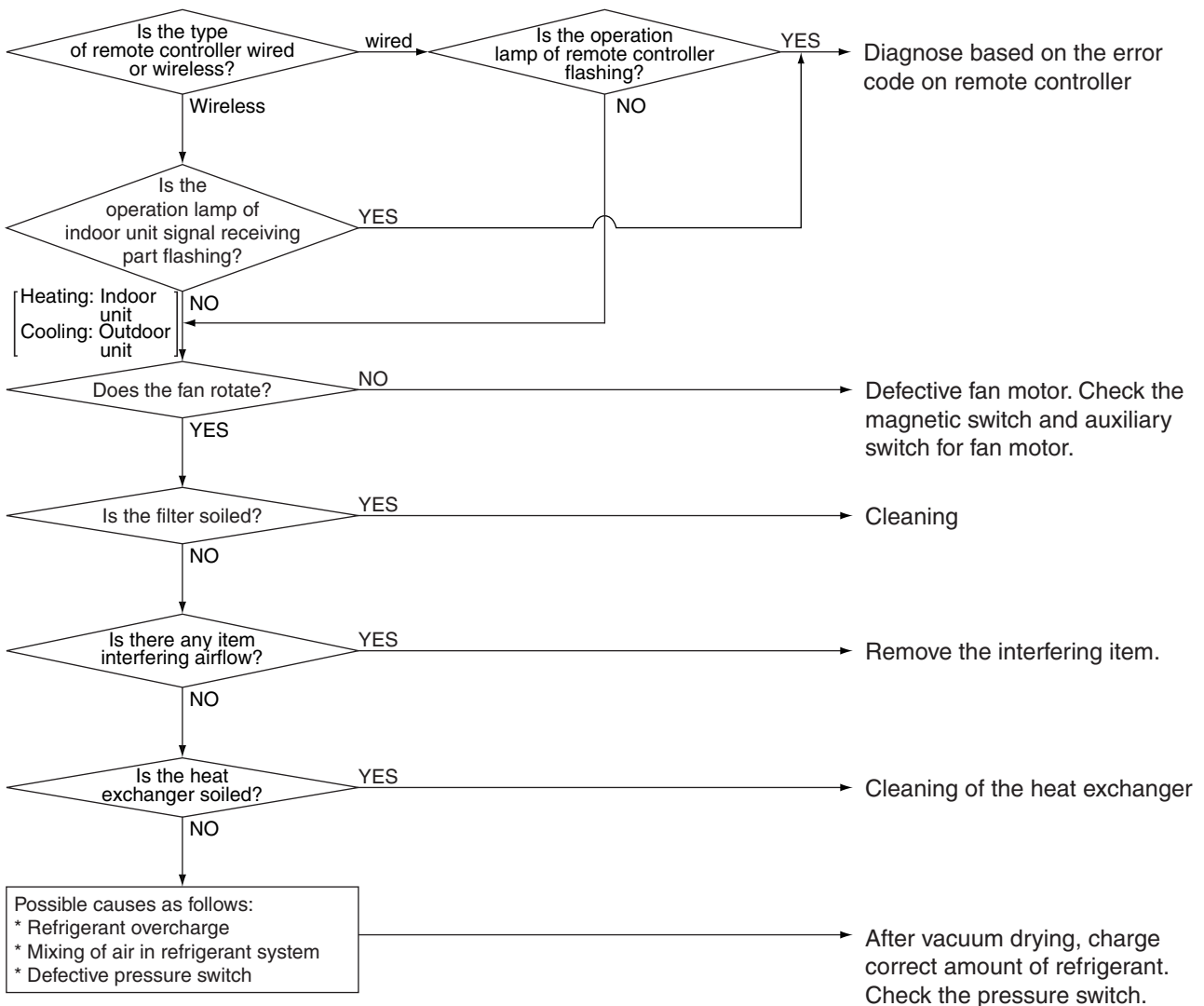

2.5 After Unit Shuts Down, It cannot be Restarted for a While

Applicable Model All models of SkyAir series

Supposed Causes

- Overcurrent relay (for compressor)
Overcurrent relay may act due to the following reasons
 - Lower voltage of power supply
 - Excess level of high pressure
 - Insufficient size of power cable
 - Defective compressor
- Compressor protection thermostat
Compressor protection thermostat may act due to the following reasons
 - Internal leakage of four way valve (There is no difference between suction and discharge temperature)
 - Insufficient compression of compressor
 - Incorrect refrigerant
 - Defective electronic expansion valve
 - Insufficient circulation of refrigerant

Troubleshooting



Caution Be sure to turn off power switch before connect or disconnect connector, or parts damage may be occurred.

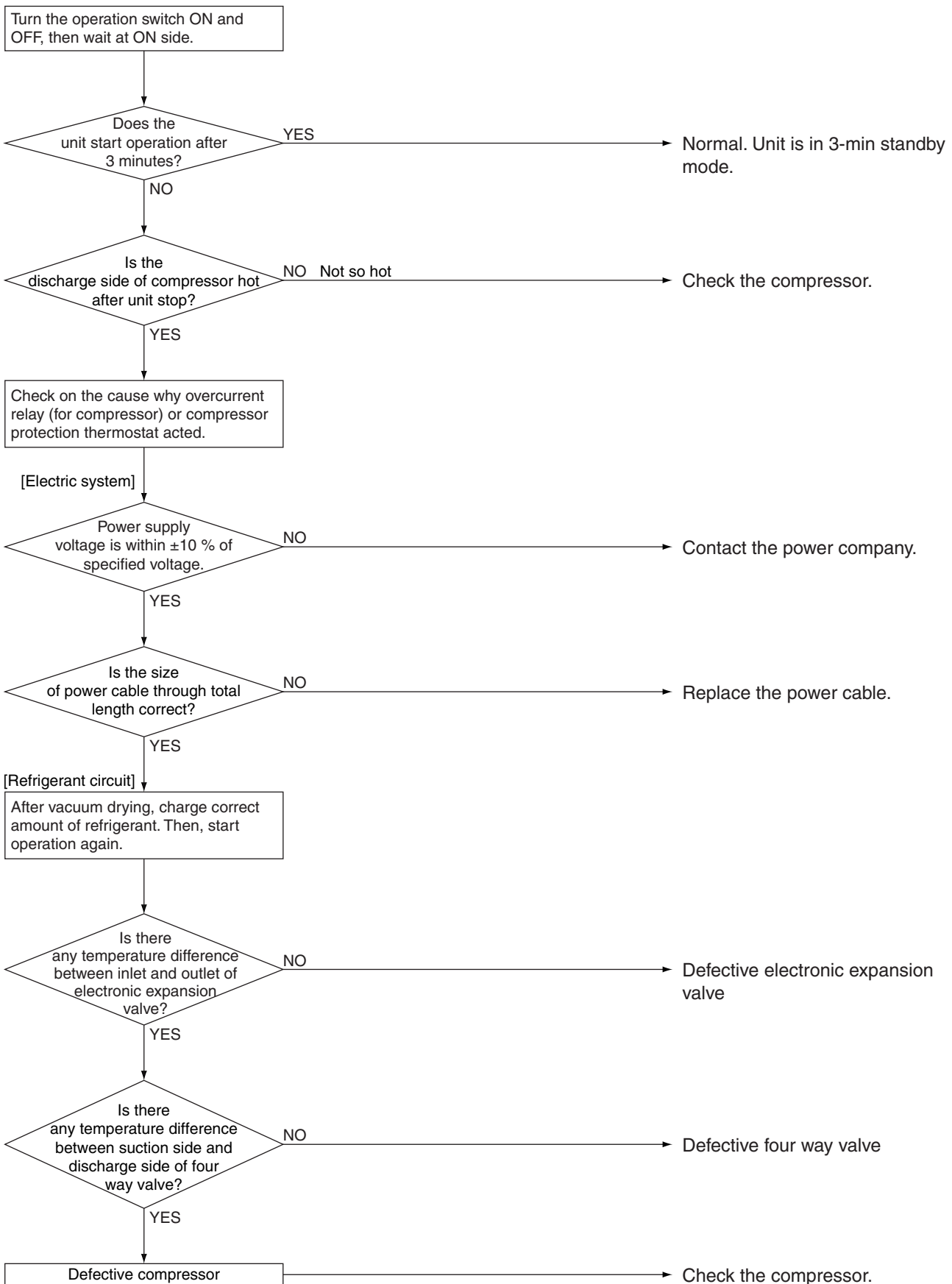

2.6 Equipment Operates but does not Provide Cooling

Applicable Model All models of SkyAir series

Supposed Causes

- Overcurrent relay (for compressor)
Overcurrent relay may act due to the following reasons
 - Lower voltage of power supply
 - Excess level of high pressure
 - Insufficient size of power cable
 - Defective compressor
- Compressor protection thermostat
Compressor protection thermostat may act due to the following reasons
 - Internal leakage of four way valve (There is no difference between suction and discharge temperature)
 - Insufficient compression of compressor
 - Incorrect refrigerant charge/leak
 - Defective electronic expansion valve
 - Insufficient circulation of refrigerant
- Defective thermistors or thermistor out of position

Troubleshooting



Caution Be sure to turn off power switch before connect or disconnect connector, or parts damage may be occurred.

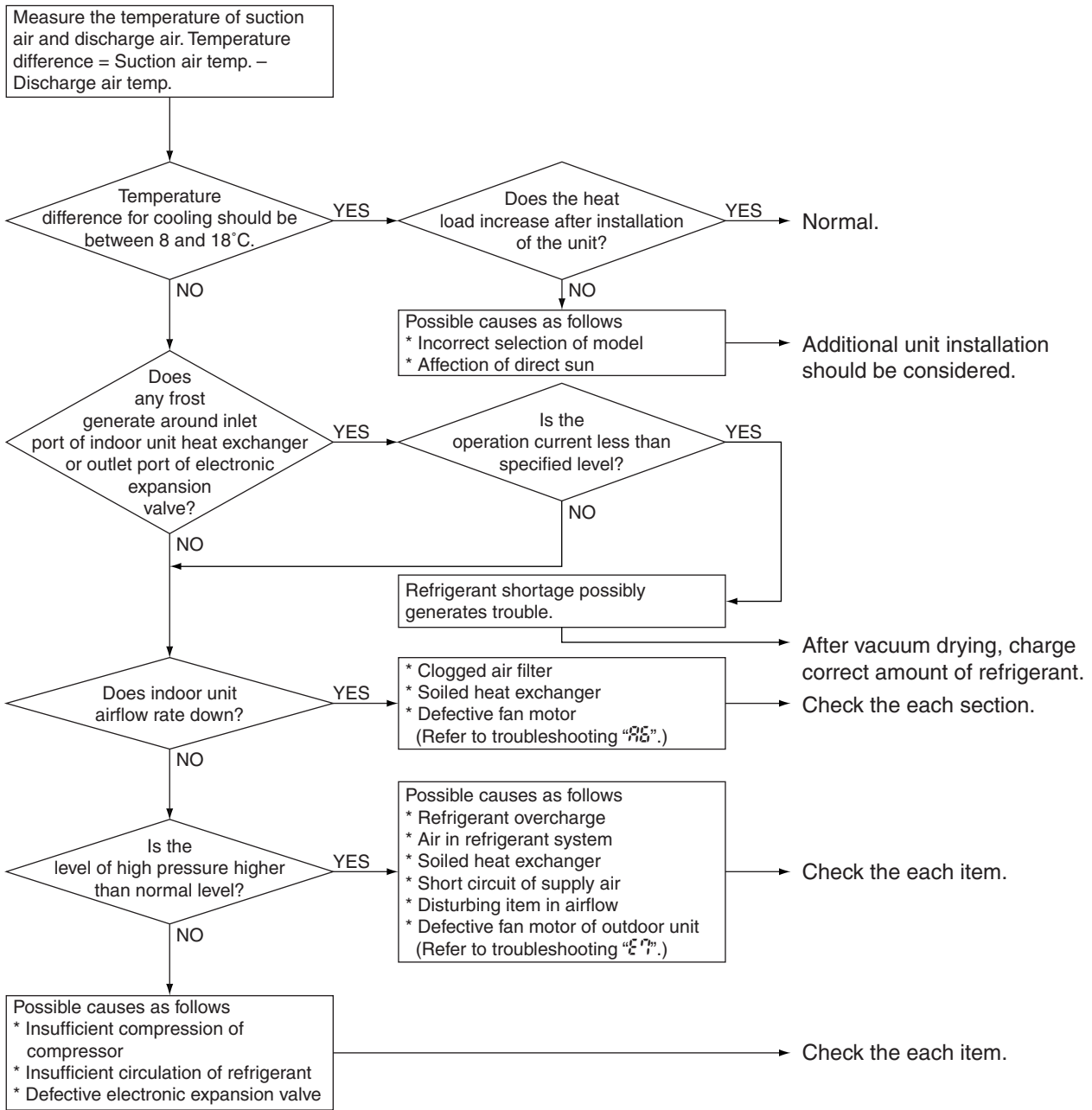

2.7 Equipment Operates but does not Provide Heating

Applicable Model All models of SkyAir series

Supposed Causes

- Overcharge of refrigerant
- Air mixed in refrigerant system
- Defective pressure switch
- Defective magnetic switch for outdoor unit fan motor
- Defective aux. relay for outdoor unit fan motor
- Soiled heat exchanger of outdoor unit
- There is an interfering item in airflow of outdoor unit.
- Defective outdoor unit fan
- Soiled air filter of indoor unit
- Soiled heat exchanger of indoor unit
- There is an interfering item in airflow of indoor unit.
- Defective indoor unit fan

Troubleshooting



Caution Be sure to turn off power switch before connect or disconnect connector, or parts damage may be occurred.

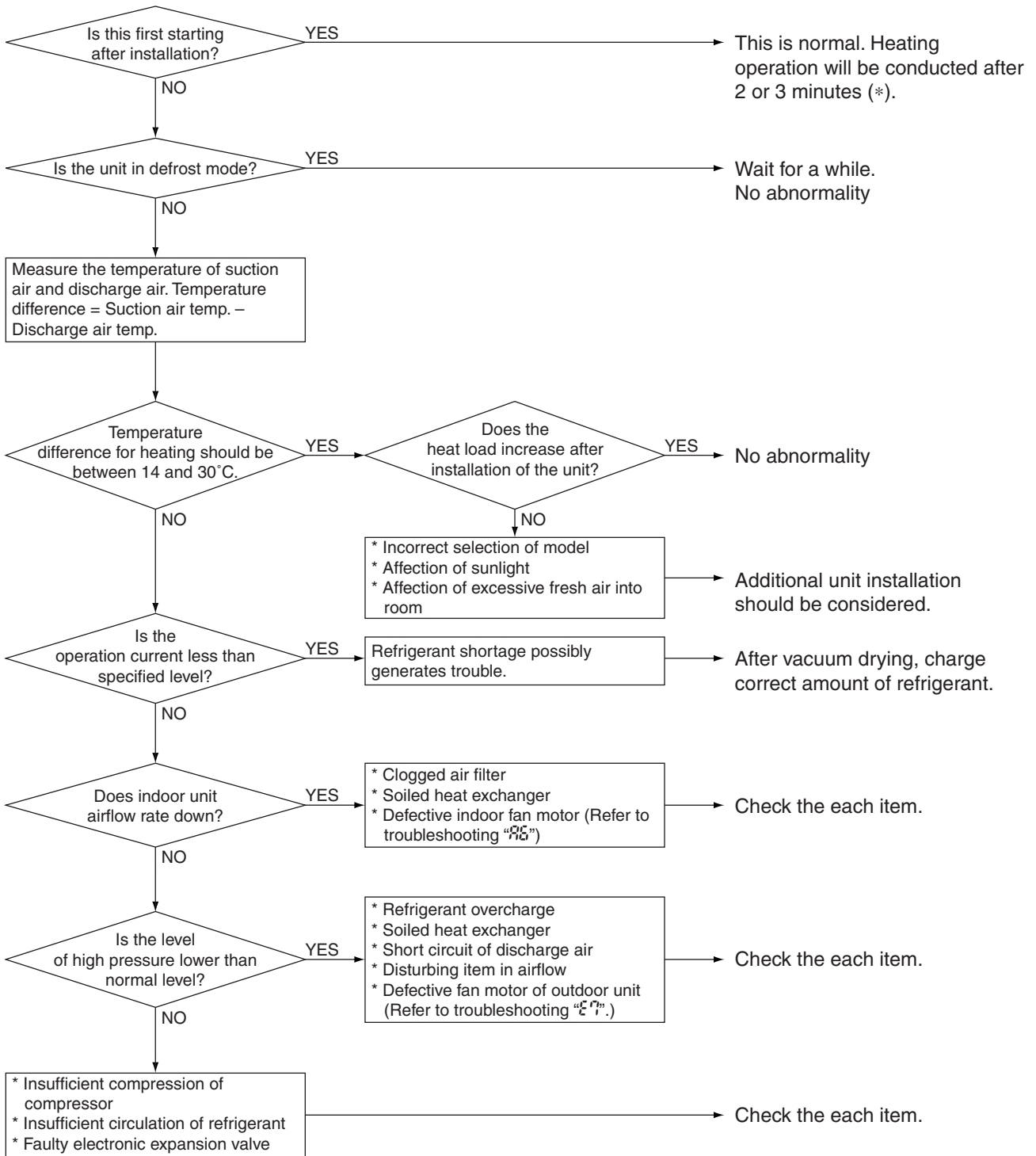

*: Refer to “Test Operation” on P.58.

2.8 Equipment Discharges White Mist

Applicable Model All models of SkyAir series

- Supposed Causes**
- Humid installation site
 - Installation site is dirty and with dense oil mists.
 - Soiled heat exchanger
 - Clogged air filter
 - Defective fan motor

Troubleshooting



Caution Be sure to turn off power switch before connect or disconnect connector, or parts damage may be occurred.

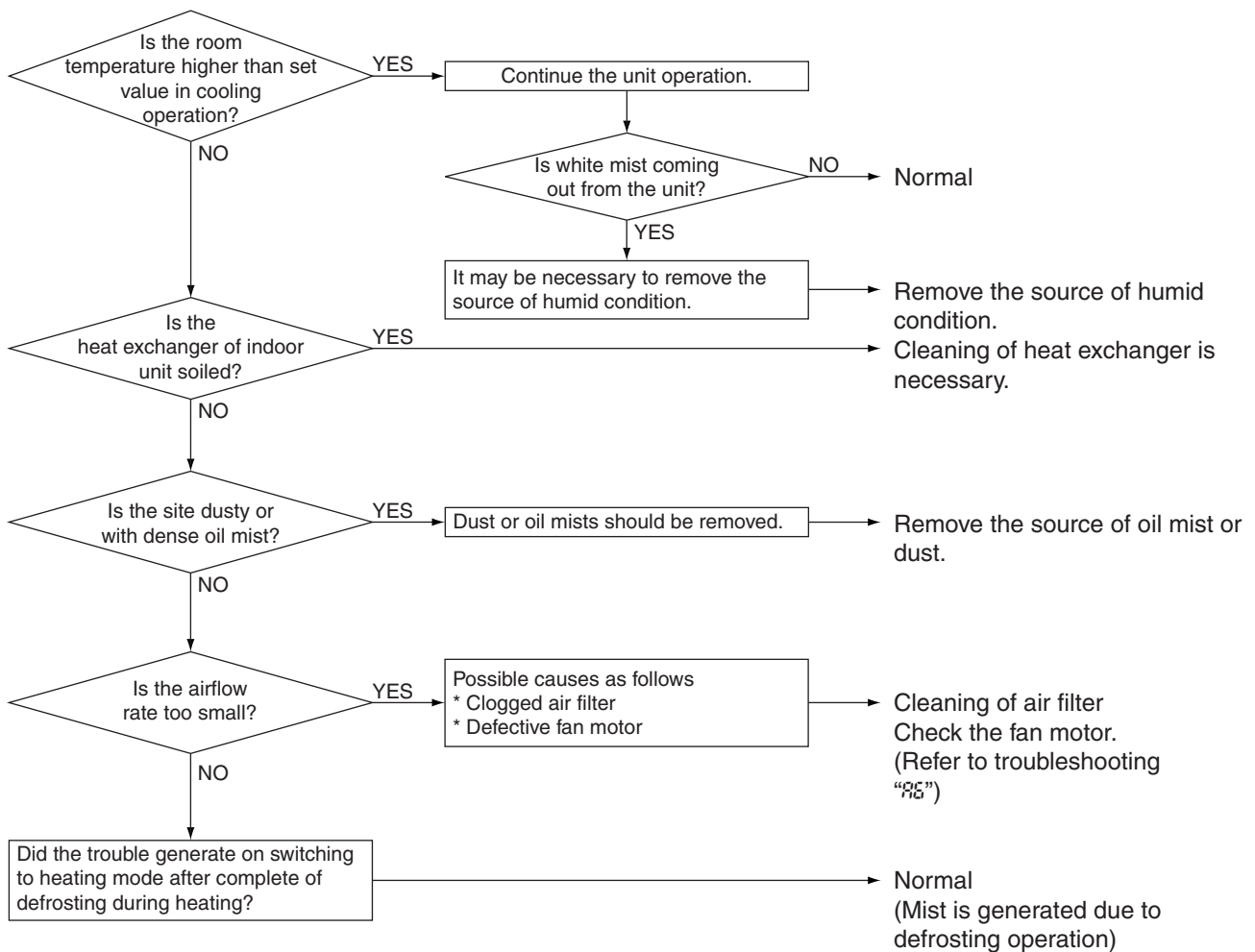

2.9 Equipment Produces Loud Noise or Vibration

Applicable Model All models of SkyAir series

- Supposed Causes**
- Defective installation
 - Overcharge of refrigerant
 - Air mixed in refrigerant system
 - Flushing noise due to refrigerant shortage. (Sound of shoo...)

Troubleshooting



Caution Be sure to turn off power switch before connect or disconnect connector, or parts damage may be occurred.

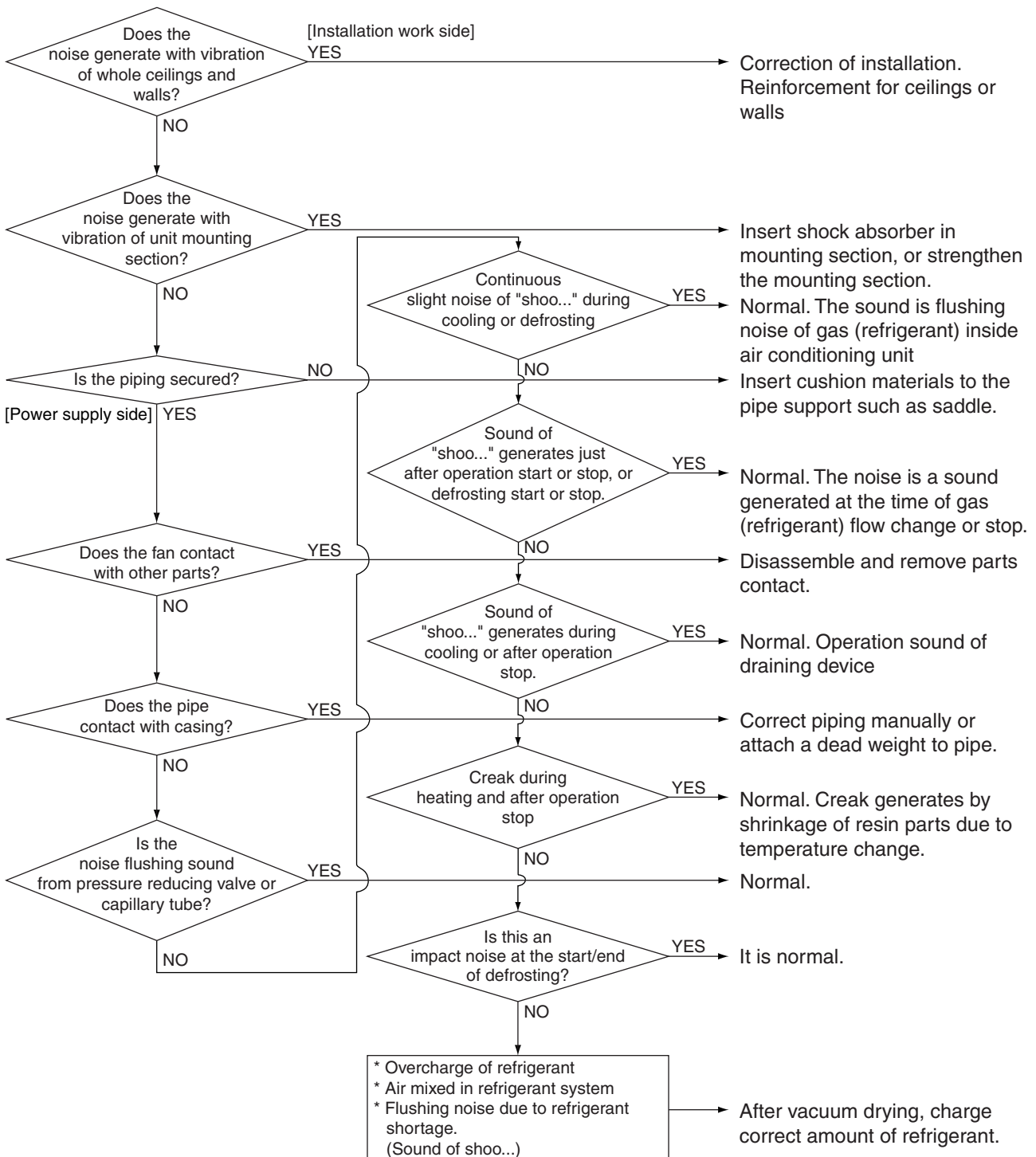

2.10 Equipment Discharges Dust

Applicable Model All models of SkyAir series

- Supposed Causes**
- Carpet
 - Animal hair
 - Application (cloth shop,...)

Troubleshooting



Caution Be sure to turn off power switch before connect or disconnect connector, or parts damage may be occurred.



2.11 Remote Controller LCD Displays "88"

Applicable Model All models of SkyAir series

Supposed Causes

Troubleshooting



Caution Be sure to turn off power switch before connect or disconnect connector, or parts damage may be occurred.

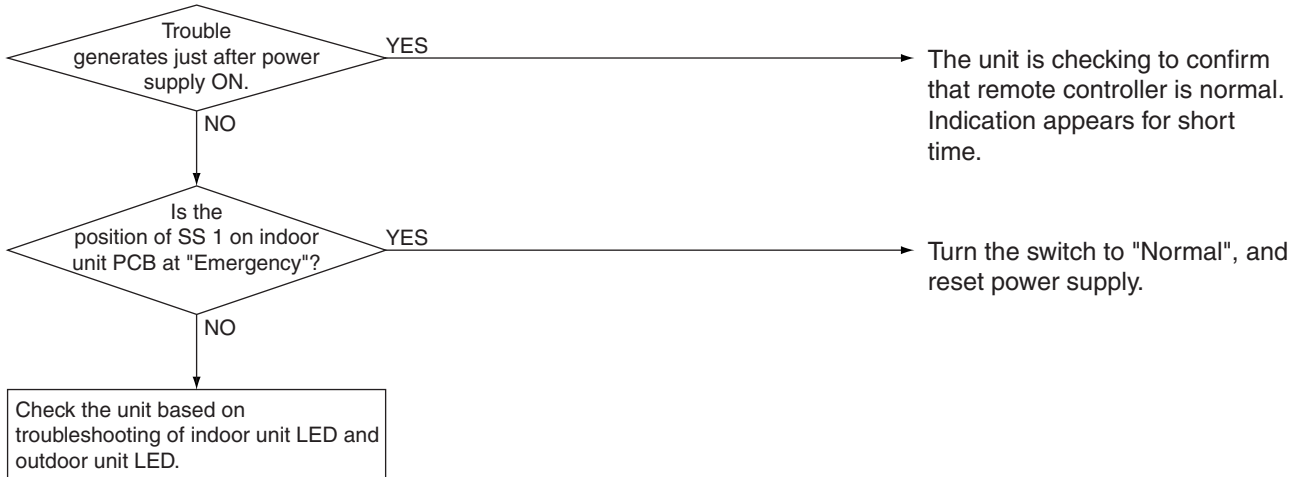

2.12 Swing Flap does not Operate

Applicable Models	All models of SkyAir series
Method of Error Detection	Visual check
Error Decision Conditions	When ON/OFF of the micro-switch for positioning cannot be reversed even through the swing flap motor for a specified amount of time (about 30 seconds).
Remark	<p>Some functions can force the swing flap into a fixed position, although swing mode is selected on the remote controller. This is not a unit error, but a control function to prevent draft to the customer.</p> <p>Before starting the troubleshooting, make sure the swing flap is not forced into such a fixed position. (e.g. Hot start, defrost operation, thermostat OFF in heating operation or freeze prevention in cooling operation. For details refer to "Swing Pattern Selection" on P.33.)</p>
Supposed Causes	<ul style="list-style-type: none"> ■ Faulty swing motor ■ Faulty micro-switch ■ Faulty connector connection ■ Faulty indoor unit PCB

Troubleshooting

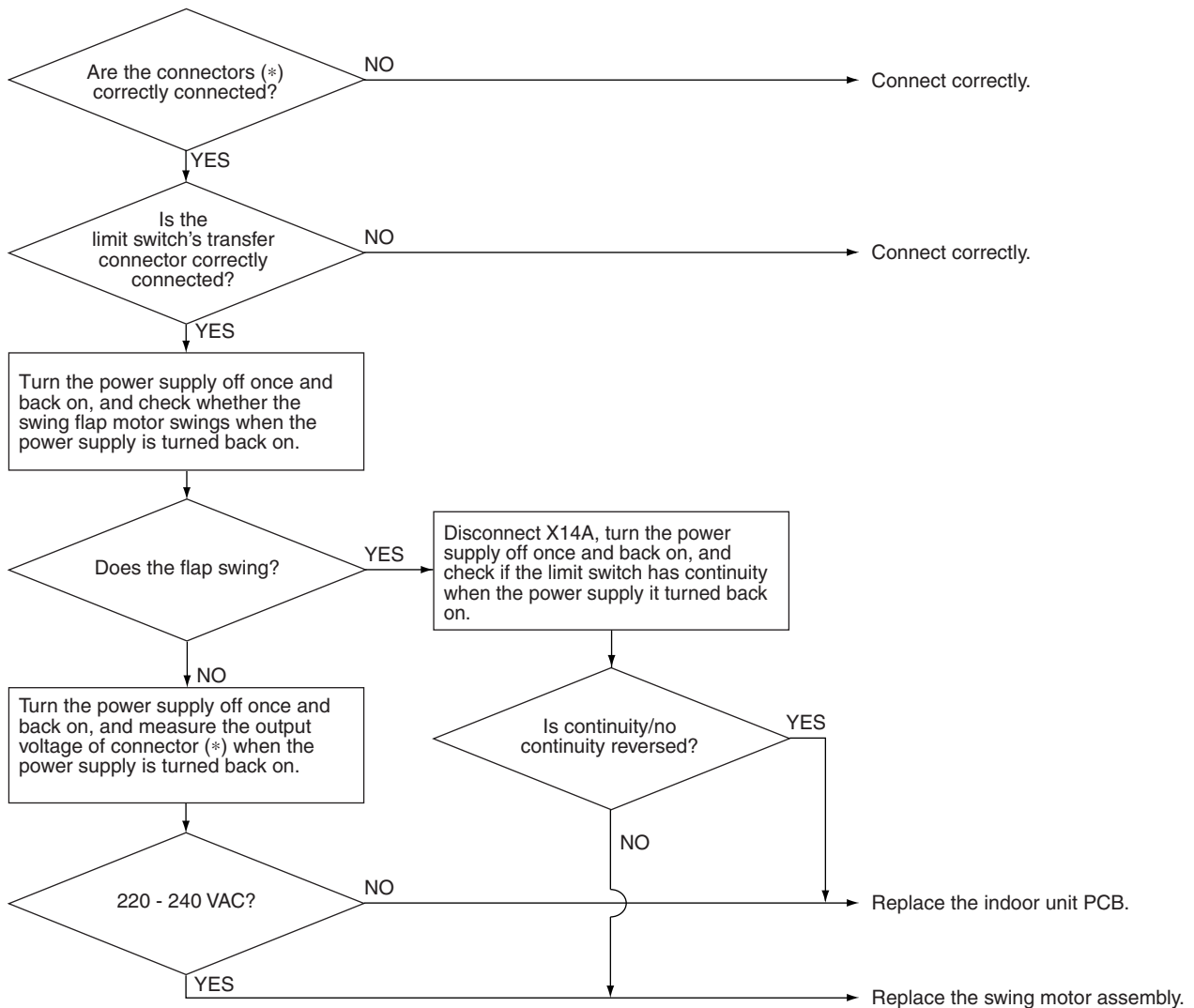

Caution Be sure to turn off power switch before connect or disconnect connector, or parts damage may be occurred.

**Note:**

*

Model	Connector for swing flap motor	PCB
FCQG	X9A	A2P
FHQG	X36A	A1P

3. Troubleshooting by LED Indications

3.1 Troubleshooting by LED on the Indoor Unit

Foreword

Troubleshooting can be carried out by service monitor LED (green). (Blinks when normal)

○ : LED on / ● : LED off / ◐ : LED blinks

Micro-computer Normal Monitor	Contents/Processing
HAP (LED-A)	
◐	Indoor unit normal → Outdoor unit troubleshooting
◐	Incorrect transmission wiring between indoor and outdoor unit If outdoor unit's LED-A is OFF, proceed outdoor unit's troubleshooting. If outdoor unit's LED-A blinks, defective wiring or indoor or outdoor unit PCB assy.
○	Defective indoor unit PCB assy
●	Defective power supply or defective PCB assy or broken transmission wire between indoor and outdoor unit.



Note:

- When the INSPECTION/TEST button of remote controller is pushed, **INSPECTION** display blinks entering **INSPECTION** mode.
- In the **INSPECTION** mode, when the ON/OFF button is pushed and held for 5 seconds or more, the aforementioned error history display is OFF. In this case, after the error code blinks 2 times, the code display turns to "00" (=Normal) and the unit No. turns to "0". The INSPECTION mode automatically switches to the normal mode (set temperature display).
- Operation halts due to error depending on the model or condition.
- Troubleshoot by turning OFF the power supply for a minimum of 5 seconds, turning it back ON, and then rechecking the LED display.

3.2 Troubleshooting by LED on Outdoor Unit PCB

The following diagnosis can be conducted by turning ON the power switch and checking the LED indication on PCB (A1P) of the outdoor unit.

○ : LED on / ● : LED off / ◐ : LED blinks

LED detection		Description
HAP	H1P	
(Green)	(Red)	
◐	●	Normal
○	—	Defective outdoor unit PCB (Note 1)
●	—	Power supply abnormality, or defective outdoor unit PCB (Note 2)
◐	○	Activation of protection device (Note 3)



Note:

- Turn OFF the power supply, and turn it ON again after 5 seconds or more. Check the error condition, and diagnose the problem.
- Turn OFF the power supply. After 5 seconds or more, disconnect the connection wire (2). Then turn ON the power supply. If the HAP on the outdoor unit PCB flashes after about 10 seconds, the indoor unit PCB is faulty.
- Also check for open phase.

Remark:

The error detection monitor continues to indication the previously generated error until the power supply is turned OFF.

Be sure to turn OFF the power supply after inspection.

4. Troubleshooting by Remote Controller

4.1 Procedure of Self-diagnosis by Remote Controller

4.1.1 Wired Remote Controller — BRC1D528

If operation stops due to error, the remote controller's operation LED blinks, and error code is displayed. (Even if stop operation is carried out, error contents are displayed when the inspection mode is entered.) The error code enables you to tell what kind of error caused operation to stop. Refer to P.122 for error code and error contents.

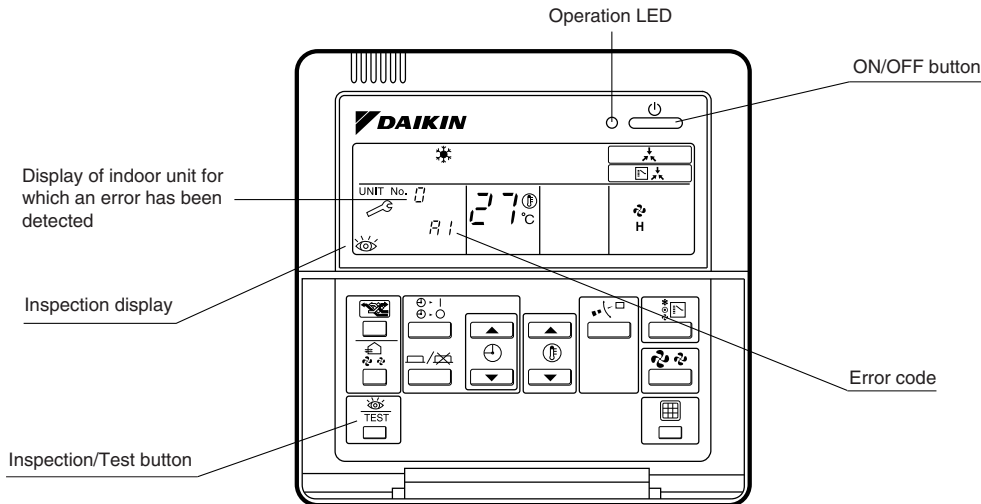

Note:

1. Pressing the INSPECTION/TEST button will blink the check indication.
2. While in service mode, holding down the ON/OFF button for a period of 5 seconds or more will clear the failure history indication shown above. In this case, on the codes display, the error code will blink twice and then change to "00" (=Normal), the Unit No. will change to "0", and the operation mode will automatically switch from service mode to normal mode (displaying the set temperature).

4.1.2 Wired Remote Controller — BRC1E51/52A7

The following will be displayed on the screen when a malfunction (or a warning) occurs during operation. Check the malfunction code and take the corrective action specified for the particular model.

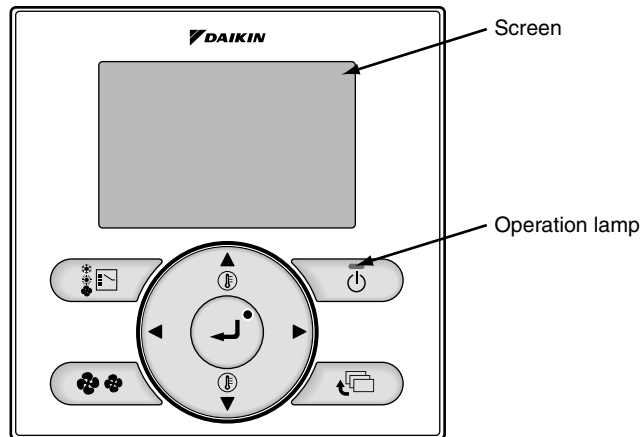

(1) Checking a malfunction or warning

	Operation Status	Display	
Abnormal shutdown	The system stops operating.	The operation lamp (green) starts to blink. The message "Error: Press Menu button" will appear and blink at the bottom of the screen.	
Warning	The system continues its operation.	The operation lamp (green) remains on. The message "Warning: Press Menu button" will appear and blink at the bottom of the screen.	

(2) Taking corrective action

- Press the Menu/Enter button to check the error code.



- Take the corrective action specific to the model.

Error code:A1

Contact address
0123-456-789

Indoor Unit FXMQ40PVE
Outdoor Unit RWIEYQ10PY1

Return

— Error code

| Applicable model names

4.1.3 Wireless Remote Controller

If unit stops due to an error, the operation indicating LED on the signal receiving part of indoor unit flashes. The error code can be determined by following the procedure described below. (The error code is displayed when an operation error has occurred. In normal condition, the error code of the last problem is displayed.)

<p>1</p>	<p>Press the INSPECTION/TEST button to select "inspection". The equipment enters the inspection mode. The "Unit" indication is displayed and the Unit No. display shows flashing "0" indication.</p>	
<p>2</p>	<p>Set the Unit No. Press the UP or DOWN button and change the Unit No. display until the buzzer (*1) is generated from the indoor unit. *1 Number of beeps 3 short beeps : Conduct all of the following operations. 1 short beep : Conduct steps 3 and 4. Continue the operation in step 4 until a buzzer remains ON. The continuous buzzer indicates that the error code is confirmed. Continuous beep : No abnormality.</p>	
<p>3</p>	<p>Press the MODE selector button. The left "0" (upper digit) indication of the error code flashes.</p>	
<p>4</p>	<p>Error code upper digit diagnosis Press the UP or DOWN button and change the error code upper digit until the error code matching buzzer (*2) is generated. ■ The upper digit of the code changes as shown below when the UP and DOWN buttons are pressed.</p> <div style="text-align: center;"> <p>⇨ "UP" button ⇩ "DOWN" button</p> </div> <p>*2 Number of beeps Continuous beep : Both upper and lower digits matched. (Error code confirmed) 2 short beeps : Upper digit matched. 1 short beep : Lower digit matched.</p>	
<p>5</p>	<p>Press the MODE selector button. The right "0" (lower digit) indication of the error code flashes.</p>	
<p>6</p>	<p>Error code lower digit diagnosis Press the UP or DOWN button and change the error code lower digit until the continuous error code matching buzzer (*2) is generated. ■ The lower digit of the code changes as shown below when the UP and DOWN buttons are pressed.</p> <div style="text-align: center;"> <p>⇨ "UP" button ⇩ "DOWN" button</p> </div>	

Normal status
 Enters inspection mode from normal status when the INSPECTION/ TEST button is pressed.

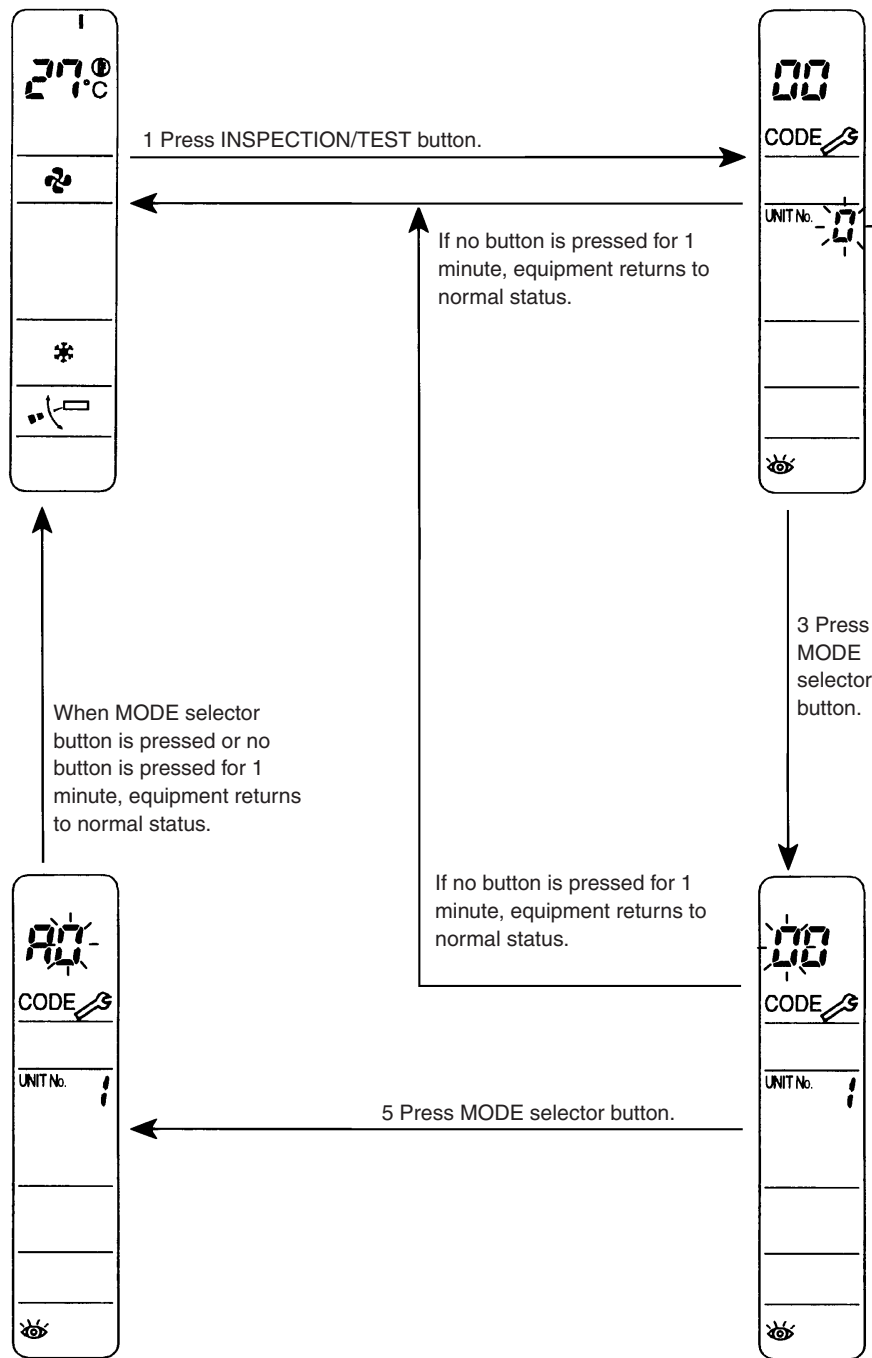

4.2 Error Codes and Description

	Remote Controller Display	Contents of Error	Reference Page
Indoor Unit	P1	Indoor unit PCB abnormality	124
	P3	Drain water level system abnormality	125
	P6	Indoor unit fan motor abnormality	127
	PJ	Capacity setting abnormality	128
	C1	Transmission Error (between indoor unit PCB and adaptor PCB)	129
	C4	Heat exchanger thermistor system abnormality	131
	C5	Intermediate heat exchanger thermistor system abnormality	131
	C9	Suction air thermistor system abnormality	131
	CC	Humidity sensor system abnormality	132
	CE	Malfunction of Motion Sensor / Floor Temperature Sensor	133
	CU	Remote controller thermistor abnormality	138
Outdoor Unit	E1	Outdoor unit PCB abnormality	139
	E3	High pressure abnormality (detected by the high pressure switch)	140
	E4	Actuation of pressure sensor	142
	E5	Compressor motor lock	144
	E7	Outdoor unit fan motor abnormality	145
	E9	Electronic expansion valve abnormality	147
	F3	Discharge pipe temperature control	150
	H3	High pressure switch system abnormality	152
	H4	Abnormal low pressure sensor	153
	H9	Outdoor air thermistor system abnormality	154
	J3	Discharge pipe thermistor system abnormality	154
	J5	Suction pipe thermistor system abnormality	154
	J6	Heat exchanger thermistor system abnormality	154
	J7	Intermediate heat exchanger thermistor system abnormality	154
	J8	Liquid pipe thermistor system abnormality	154
	L1	Outdoor unit PCB abnormality	155
	L4	Radiation fin temperature rise	157
	L5	Output overcurrent detection	159
	L8	Electronic thermal (time lag)	161
	L9	Stall prevention (time lag)	163
	LC	Transmission system abnormality (between control and inverter PCB)	165
	P1	Open phase or power supply voltage imbalance	166
	PJ	Defective capacity setting	167
	U0	Refrigerant shortage	168
	U2	Power supply voltage abnormality	171
	System	U4	Transmission error between indoor and outdoor unit
U5		Transmission error between remote controller and indoor unit	176
U8		Transmission error between MAIN remote controller and SUB remote controller	177
UR		Field setting switch abnormality	178
UC		Address duplication of centralized controller	180
UE		Transmission error between centralized controller and indoor unit	181
UF		Transmission error between indoor and outdoor unit / piping and wiring mismatch / refrigerant shortage	183

4.3 Safety Devices

4.3.1 Outdoor Unit

Model	High pressure switch		Fuse
	Open	Close	
RZQG71L	4.0 MPa +0/- 0.15	3.0 MPa ± 0.15	6.3A/250V (F1U), 3.15A/250V (F6U)
RZQG100L			6.3A/250V (F1U, F2U, F3U), 5A/250V (F6U)
RZQG125L			
RZQG140L			

4.3.2 Indoor Unit

Model	Thermal protector		Fuse
	Abnormal	Reset (automatic)	
FCQG	—	—	N.A.
FHQG			3.15A/250V (F1U)

4.4 Indoor Unit PCB Abnormality

Remote Controller Display	
Applicable Models	All models of indoor unit
Method of Error Detection	Check data from E ² PROM.
Error Decision Conditions	<p>The error is generated when the data from the E²PROM is not received correctly.</p> <p>E²PROM (Electrically Erasable Programmable Read Only Memory): A memory chip that holds its content without power. It can be erased, either within the computer or externally and usually requires more voltage for erasure than the common +5 volts used in logic circuits. It functions like non-volatile RAM, but writing to E²PROM is slower than writing to RAM.</p>
Supposed Causes	<ul style="list-style-type: none"> ■ Defective indoor unit PCB ■ External factor (Noise, etc.)

Troubleshooting



Caution Be sure to turn off power switch before connect or disconnect connector, or parts damage may be occurred.



4.5 Drain Water Level System Abnormality

Remote Controller Display	83
Applicable Models	All models of indoor unit
Method of Error Detection	By float switch OFF detection
Error Decision Conditions	The error is generated when the water level reaches its upper limit and when the float switch turns OFF.
Supposed Causes	<ul style="list-style-type: none">■ Defective drain pump■ Improper drain piping work■ Drain piping clogging■ Defective float switch■ Defective indoor unit PCB■ Defective short circuit connector X15A on PCB

Troubleshooting



Caution Be sure to turn off power switch before connect or disconnect connector, or parts damage may be occurred.

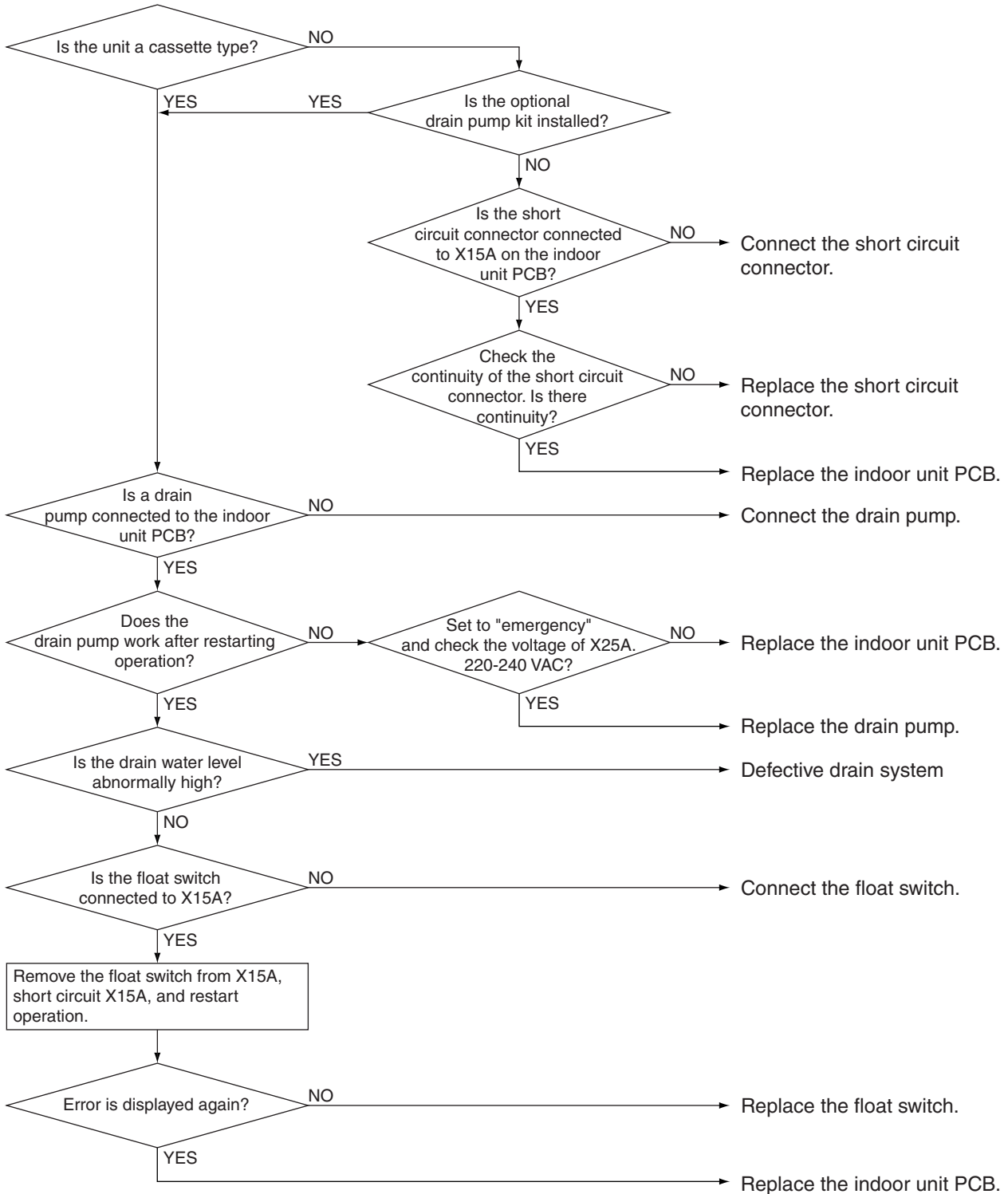

Note:

If "R3" is detected by a PCB without X15A, the PCB is defective.

4.6 Indoor Unit Fan Motor Abnormality

Remote Controller Display	
Applicable Models	All models of indoor unit
Method of Error Detection	Detection of abnormal rotation speed of fan motor by signal from the fan motor
Error Decision Conditions	The error is generated when the rotation speed of the fan motor are not detected while the output voltage to the fan is at its maximum.
Supposed Causes	<ul style="list-style-type: none"> ■ Defective indoor unit fan motor ■ Breaking or disconnection of wire ■ Defective contact ■ Defective indoor unit PCB

Troubleshooting



Caution Be sure to turn off power switch before connect or disconnect connector, or parts damage may be occurred.

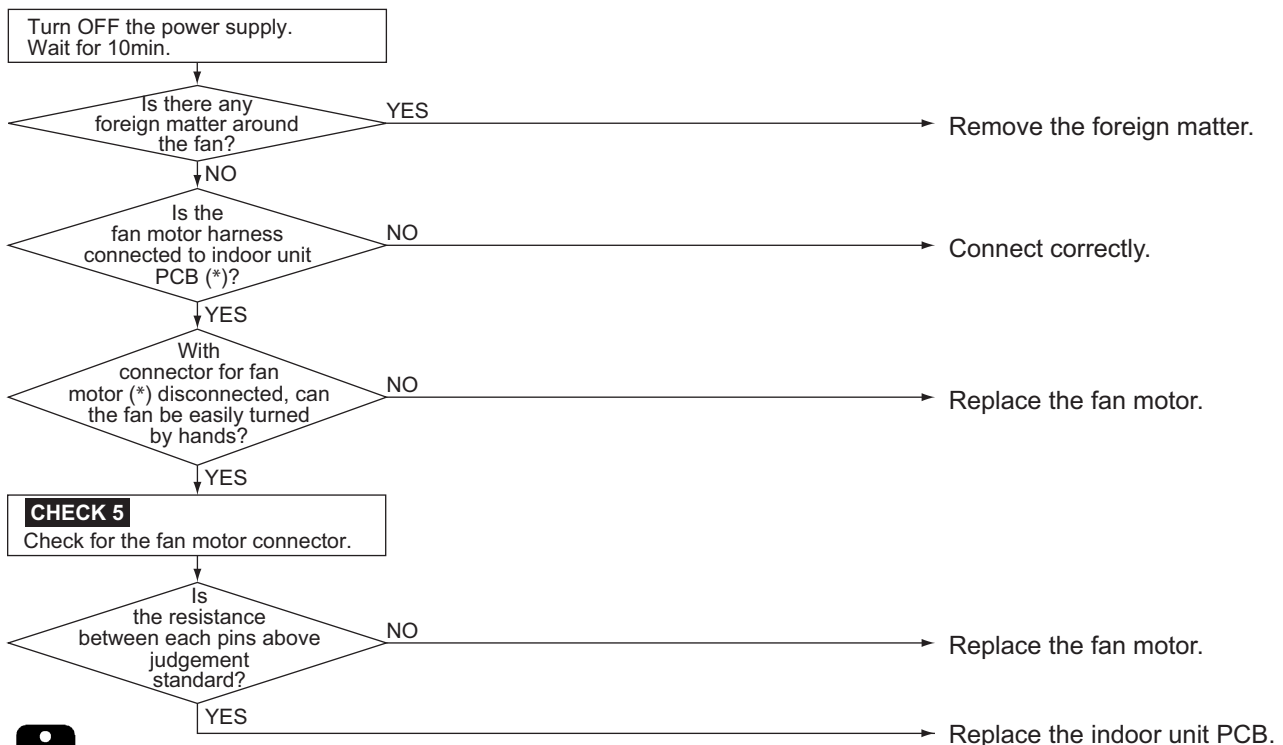

Note:

* Connector and indoor unit PCB

Model	Connector for fan motor	PCB
FCQG	X20A	A1P
FHQG	X20A	A1P



CHECK 5 Refer to P.191.

4.7 Capacity Setting Abnormality

Remote Controller Display							
Applicable Models	All models of indoor unit						
Method of Error Detection	Capacity is determined according to resistance of the capacity setting adaptor and the memory inside the IC memory on the indoor unit PCB, and whether the value is normal or abnormal is determined.						
Error Decision Conditions	<p>The error is generated when the following conditions are fulfilled:</p> <table border="1"> <thead> <tr> <th>Condition</th> <th>Description</th> </tr> </thead> <tbody> <tr> <td>1</td> <td> <ul style="list-style-type: none"> ● The unit is in operation. ● The PCB's memory IC does not contain the capacity code. ● The capacity setting adaptor is not connected. </td> </tr> <tr> <td>2</td> <td> <ul style="list-style-type: none"> ● The unit is in operation. ● The capacity that is set, does not exist for that unit. </td> </tr> </tbody> </table>	Condition	Description	1	<ul style="list-style-type: none"> ● The unit is in operation. ● The PCB's memory IC does not contain the capacity code. ● The capacity setting adaptor is not connected. 	2	<ul style="list-style-type: none"> ● The unit is in operation. ● The capacity that is set, does not exist for that unit.
Condition	Description						
1	<ul style="list-style-type: none"> ● The unit is in operation. ● The PCB's memory IC does not contain the capacity code. ● The capacity setting adaptor is not connected. 						
2	<ul style="list-style-type: none"> ● The unit is in operation. ● The capacity that is set, does not exist for that unit. 						
Supposed Causes	<ul style="list-style-type: none"> ■ Defective capacity setting adaptor connection ■ Defective indoor unit PCB 						
Capacity setting adaptor	<p>The capacity is set in the PCB's memory IC. A capacity setting adaptor that matches the capacity of the unit is required in the following case:</p> <p>In case the indoor PCB installed at the factory is for some reason changed at the installation site, the capacity will not be contained in the replacement PCB. To set the correct capacity for the PCB you have to connect a capacity setting adaptor with the correct capacity setting to the PCB. The capacity setting for the PCB will become the capacity setting of the adaptor because the capacity setting adaptor has priority.</p>						

Troubleshooting



Caution Be sure to turn off power switch before connect or disconnect connector, or parts damage may be occurred.

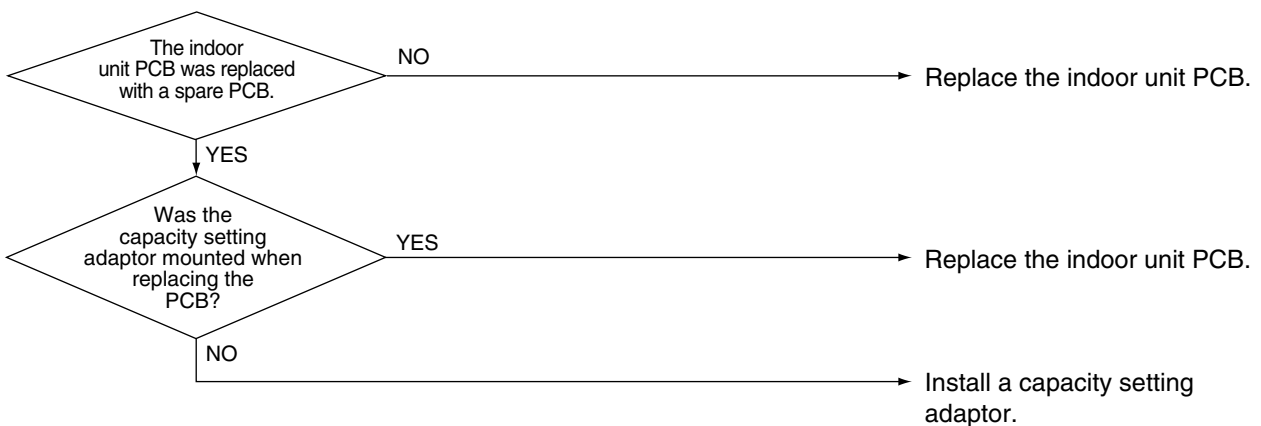

4.8 Transmission Error (between Indoor Unit PCB and Adaptor PCB)

Remote Controller Display	
Applicable Models	FCQG
Method of Error Detection	Check the condition of transmission between indoor unit PCB (A1P) and adaptor PCB using micro-computer.
Error Decision Conditions	When normal transmission is not conducted for certain duration (15 seconds or more). After 60 seconds, error is display on the remote controller.
Supposed Causes	<ul style="list-style-type: none"> ■ Connection defect of the connector indoor unit PCB (A1P) and adaptor PCB ■ Defective indoor unit PCB (A1P) ■ Defective adaptor PCB ■ External factor (Noise, etc.)

Troubleshooting



Caution Be sure to turn off power switch before connect or disconnect connector, or parts damage may be occurred.

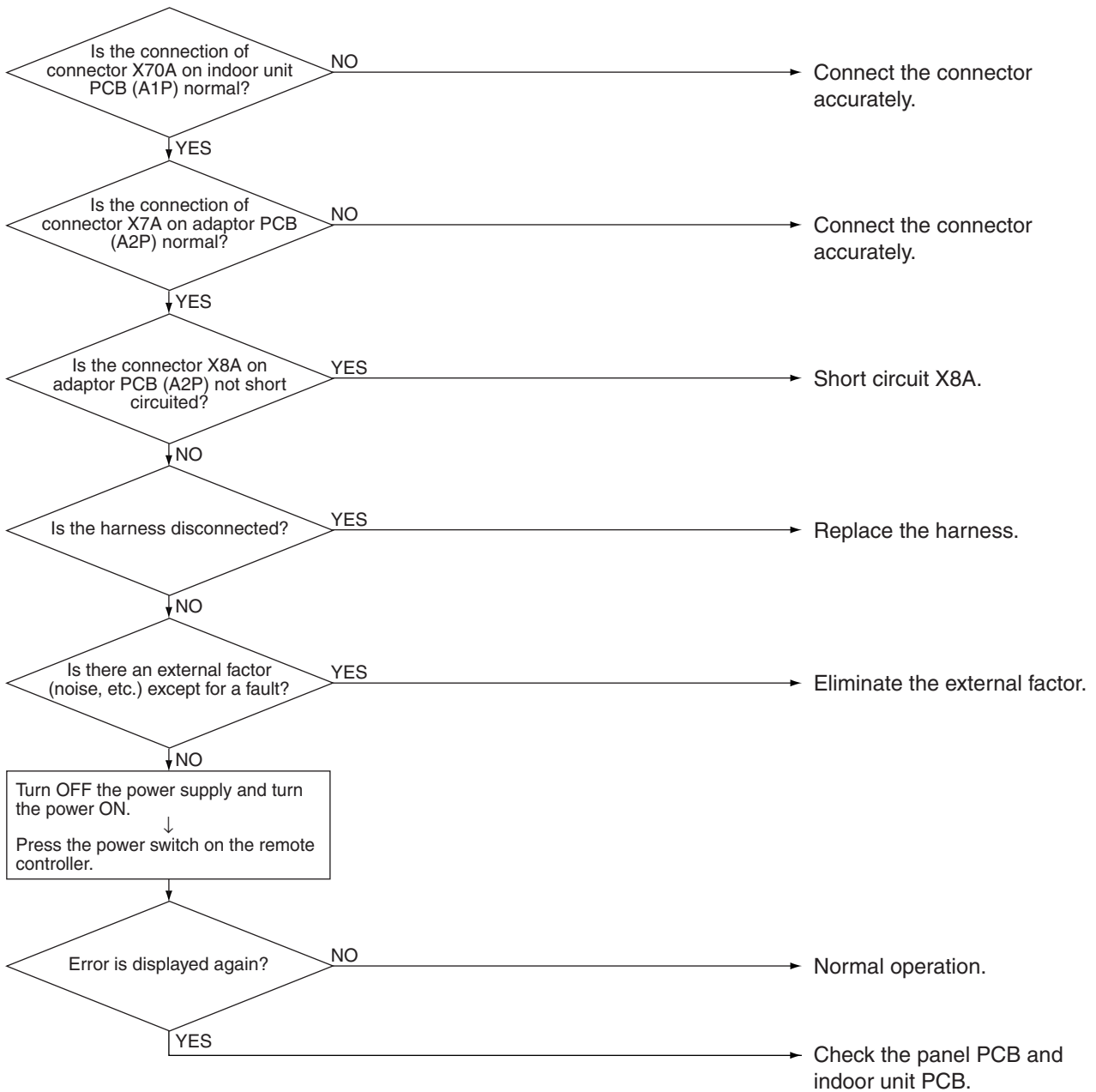

4.9 Thermistor Abnormality

Remote Controller Display	⓪4, ⓪5, ⓪9
Applicable Models	All models of indoor unit
Method of Error Detection	The error is detected by temperature detected by thermistor.
Error Decision Conditions	When the thermistor becomes disconnected or shorted while the unit is running.
Supposed Causes	<ul style="list-style-type: none"> ■ Defective connector connection ■ Defective thermistor ■ Defective indoor unit PCB ■ Broken or disconnected wire

Troubleshooting



Caution Be sure to turn off power switch before connect or disconnect connector, or parts damage may be occurred.

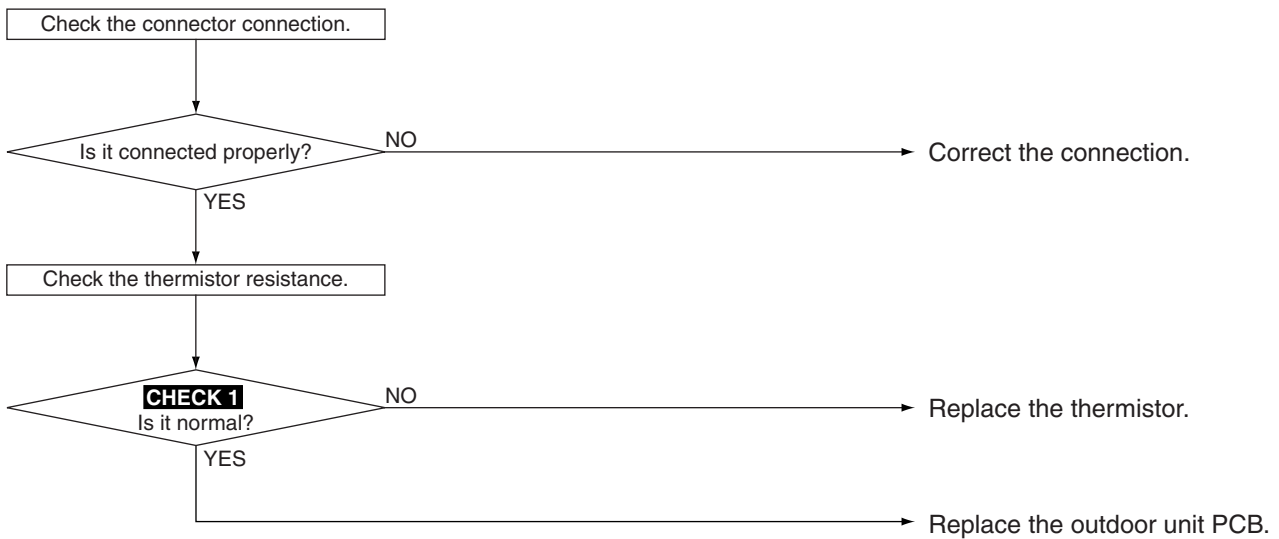

Error Code	Defective Thermistor	Symbol
⓪4	Heat exchanger thermistor	R2T
⓪5	Intermediate heat exchanger thermistor	R3T
⓪9	Suction air thermistor	R1T



CHECK 1 Refer to P.185.

4.10 Humidity Sensor System Abnormality

Remote Controller Display	
Applicable Models	FCQG
Method of Error Detection	Even if error occurs, operation still continue. The error is detected by humidity (output voltage) detected by humidity sensor.
Error Decision Conditions	The error is generated when the humidity sensor becomes disconnected or shorted when the unit is running.
Supposed Causes	<ul style="list-style-type: none"> ■ Defective sensor ■ Broken wire ■ External factor (Noise, etc.)

Troubleshooting



Caution Be sure to turn off power switch before connect or disconnect connector, or parts damage may be occurred.

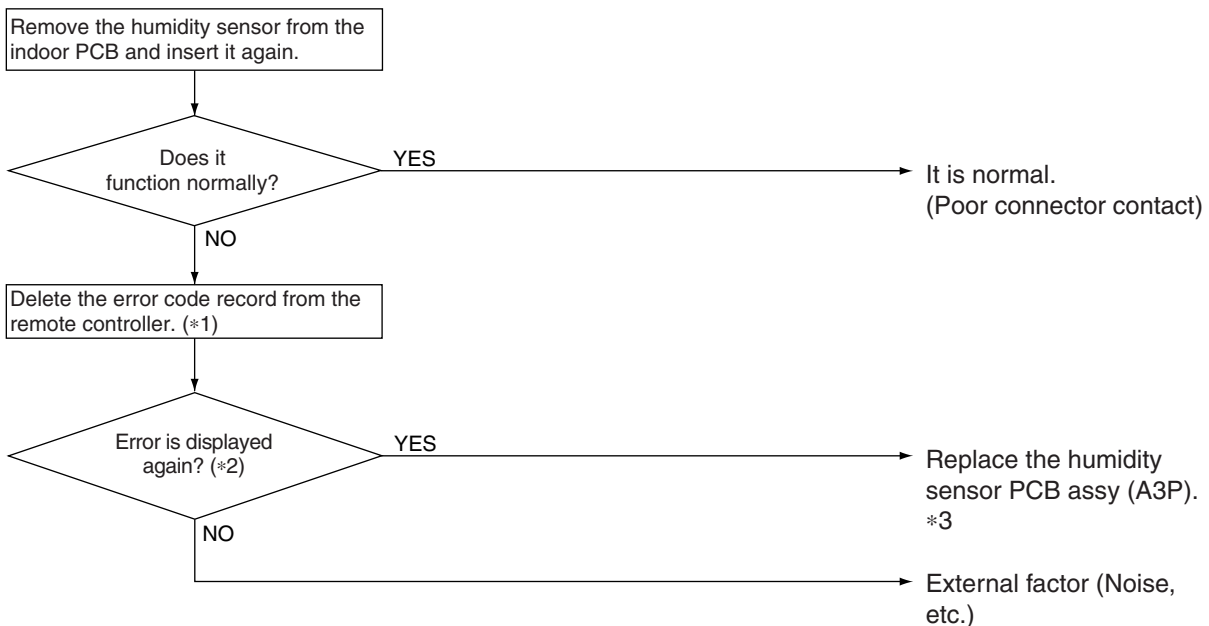

Note:

- *1 To delete the record, the ON/OFF button of the remote controller must be pushed and held for 5 seconds in the check mode.
- *2 To display the code, the Inspection/Test Operation button of the remote controller must be pushed and held in the normal mode.
- *3 If "" is displayed even after replacing the humidity sensor PCB Assy (A3P) and taking the steps *1 and 2, replace the indoor PCB Assy (A1P).

4.11 Malfunction of Motion Sensor / Floor Temperature Sensor

Remote Controller Display



Applicable Models

Indoor unit: FXYFP-B

Method of Error Detection

Detect by a signal outputted from the sensor.

Error Decision Conditions

When malfunction is detected by a signal outputted from the sensor.

Supposed Causes

- Disconnection of connector from or failure of motion sensor [CE-01]
- Failure of floor temperature sensor (wiring disconnection in temperature compensation circuit) [CE-02]
- Failure of floor temperature sensor (wiring disconnection in temperature compensation circuit) [CE-03]
- Failure of floor temperature sensor element [CE-04]

Troubleshooting

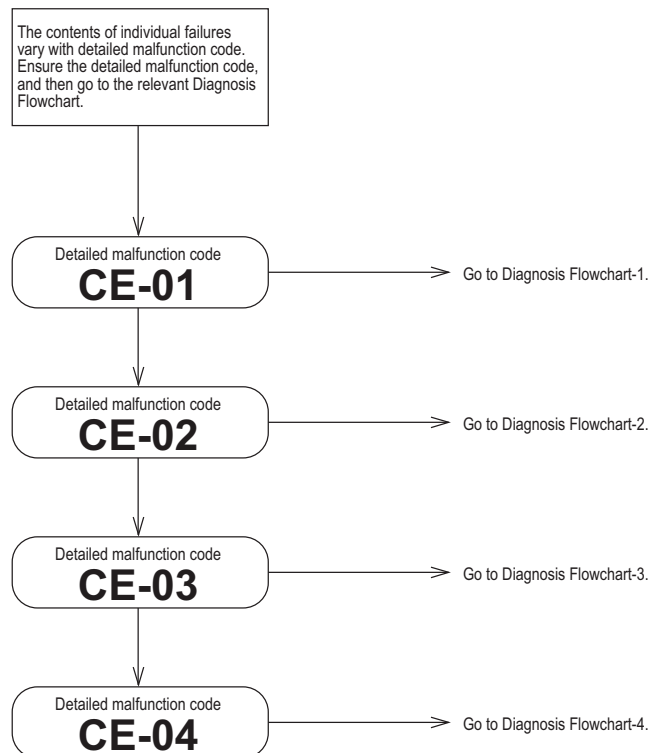

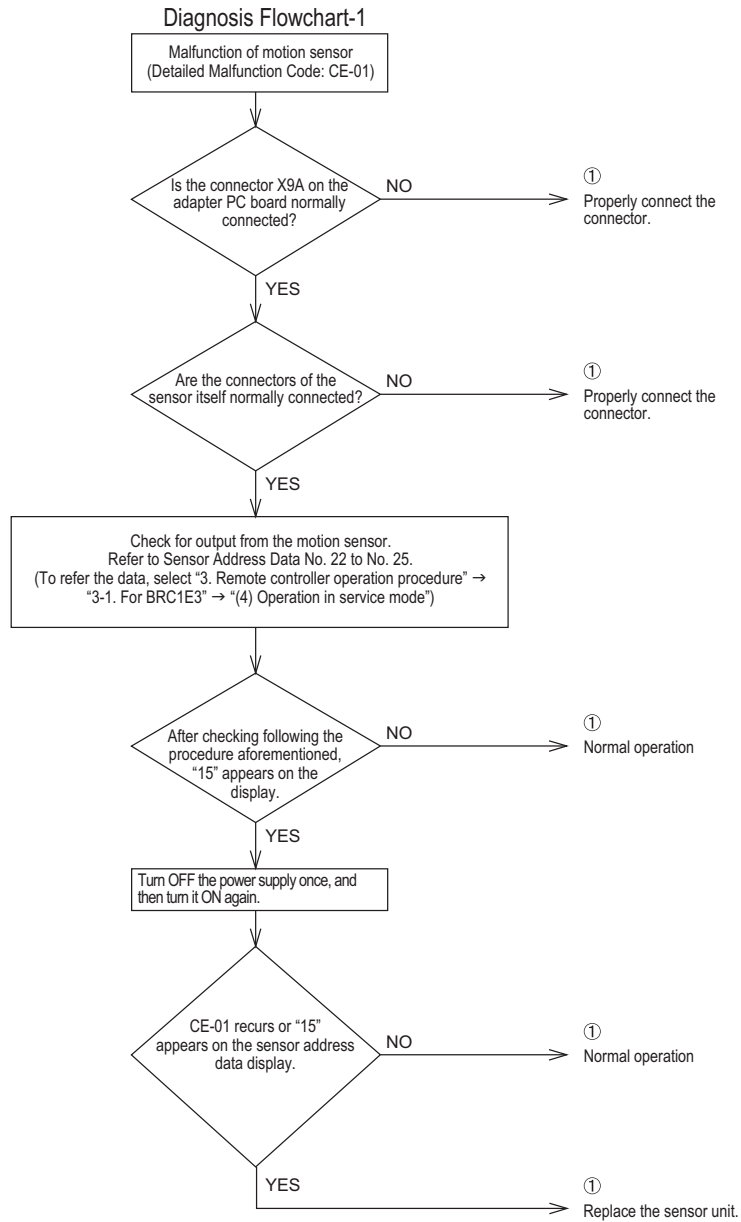

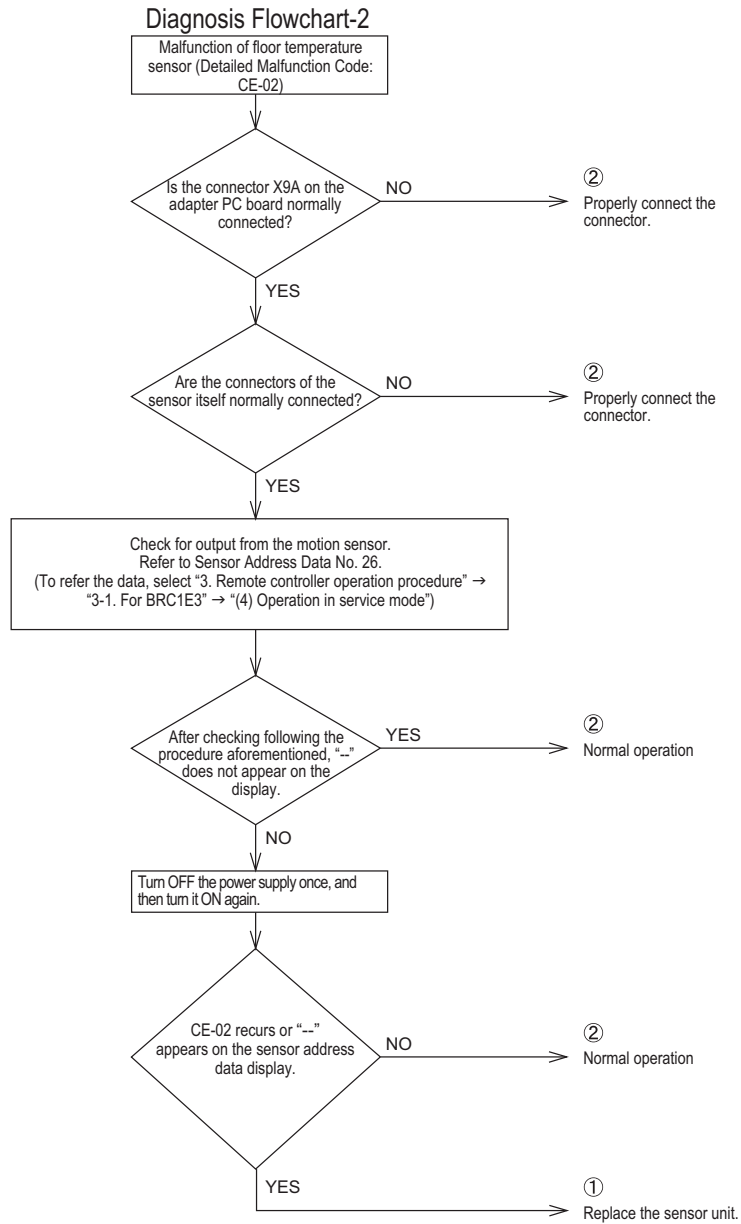

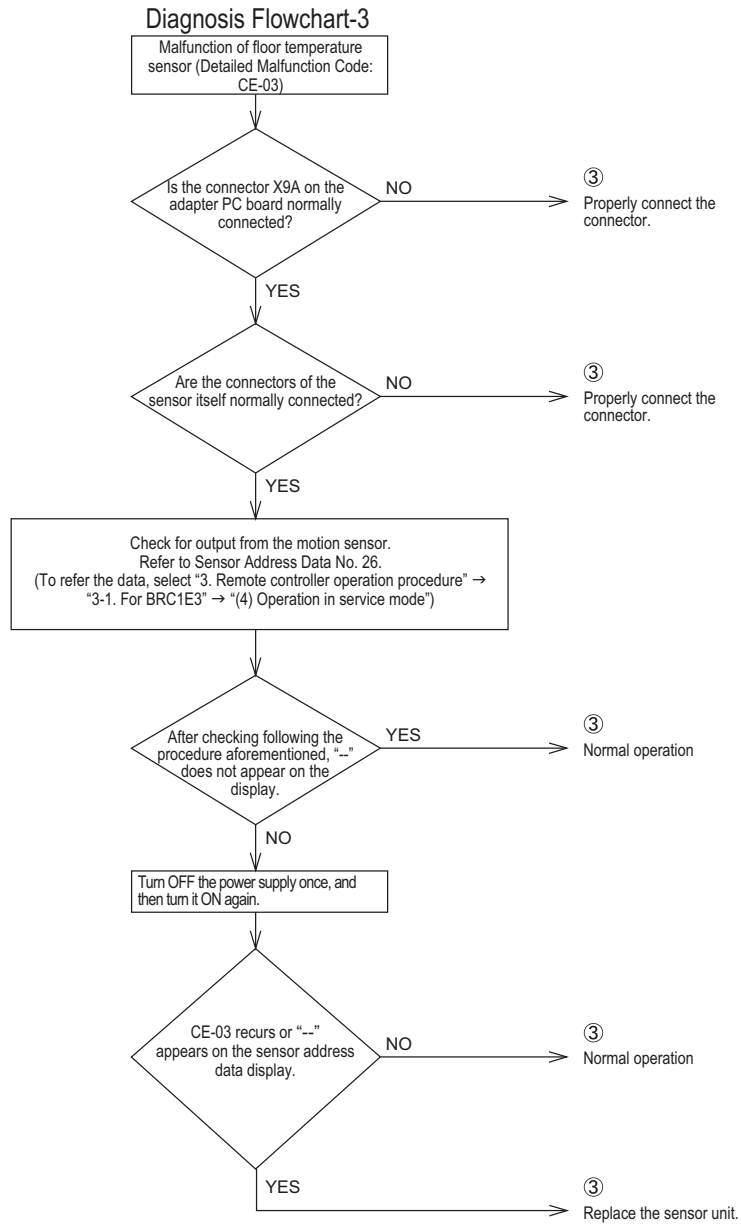

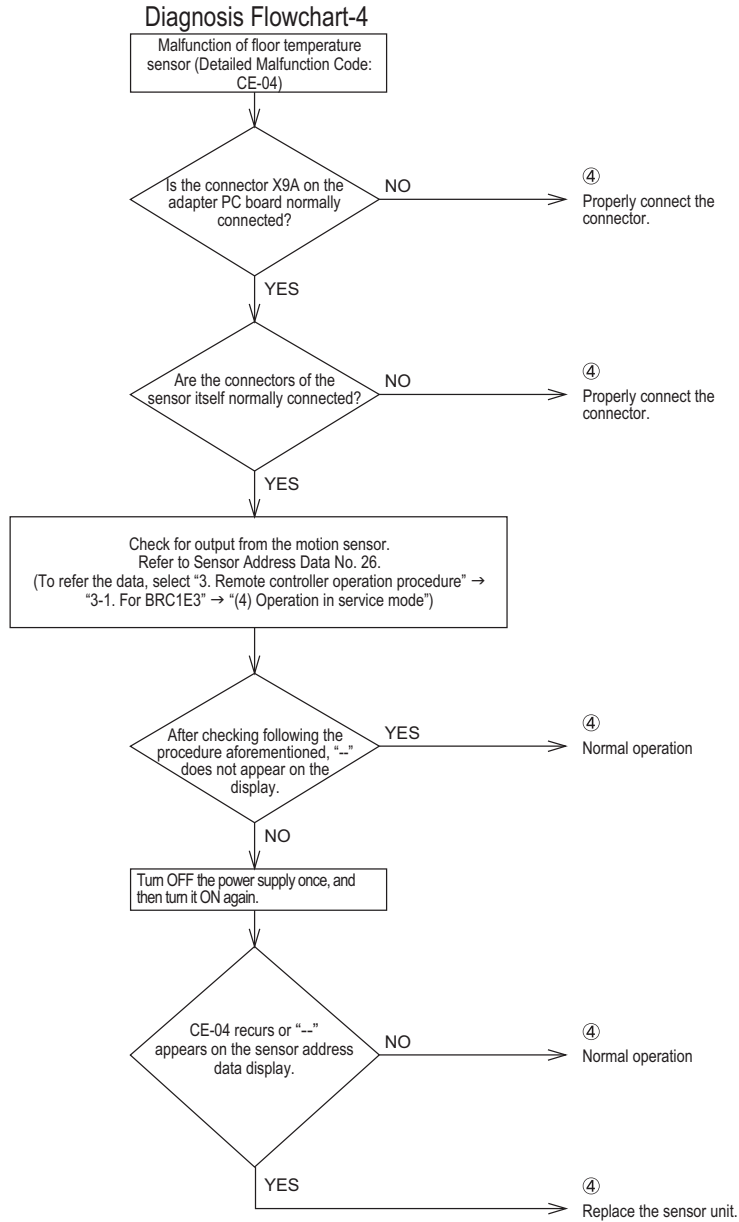

4.12 Remote Controller Thermistor Abnormality

Remote Controller Display	
Applicable Models	All models of indoor unit
Method of Error Detection	Even if remote controller thermistor is faulty, system is possible to operate by indoor unit suction air thermistor. The error is detected by temperature of remote controller thermistor.
Error Decision Conditions	The error is generated when the remote controller thermistor becomes disconnected or shorted when the unit is running. Even if the remote controller thermistor is error, the system can operate with the system thermistor.
Supposed Causes	<ul style="list-style-type: none"> ■ Defective thermistor ■ Broken wire ■ External factor (Noise, etc.)

Troubleshooting



Caution Be sure to turn off power switch before connect or disconnect connector, or parts damage may be occurred.

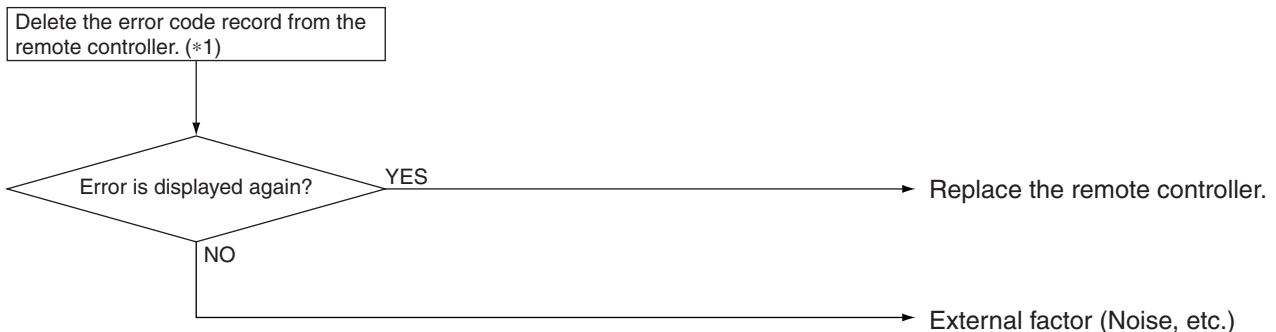

Note:

*1: To delete the record, the ON/OFF button of the remote controller must be pressed for 5 seconds in the check mode.

4.13 Outdoor Unit PCB Abnormality

Remote Controller Display	E1
Applicable Models	RZQG
Method of Error Detection	Micro-computer checks whether E ² PROM is normal.
Error Decision Conditions	When E ² PROM error when turning the power supply ON
Supposed Causes	<ul style="list-style-type: none"> ■ Defective outdoor unit PCB (A1P) ■ Defective fan motor ■ External factor (Noise, etc.)

Troubleshooting



Caution Be sure to turn off power switch before connect or disconnect connector, or parts damage may be occurred.

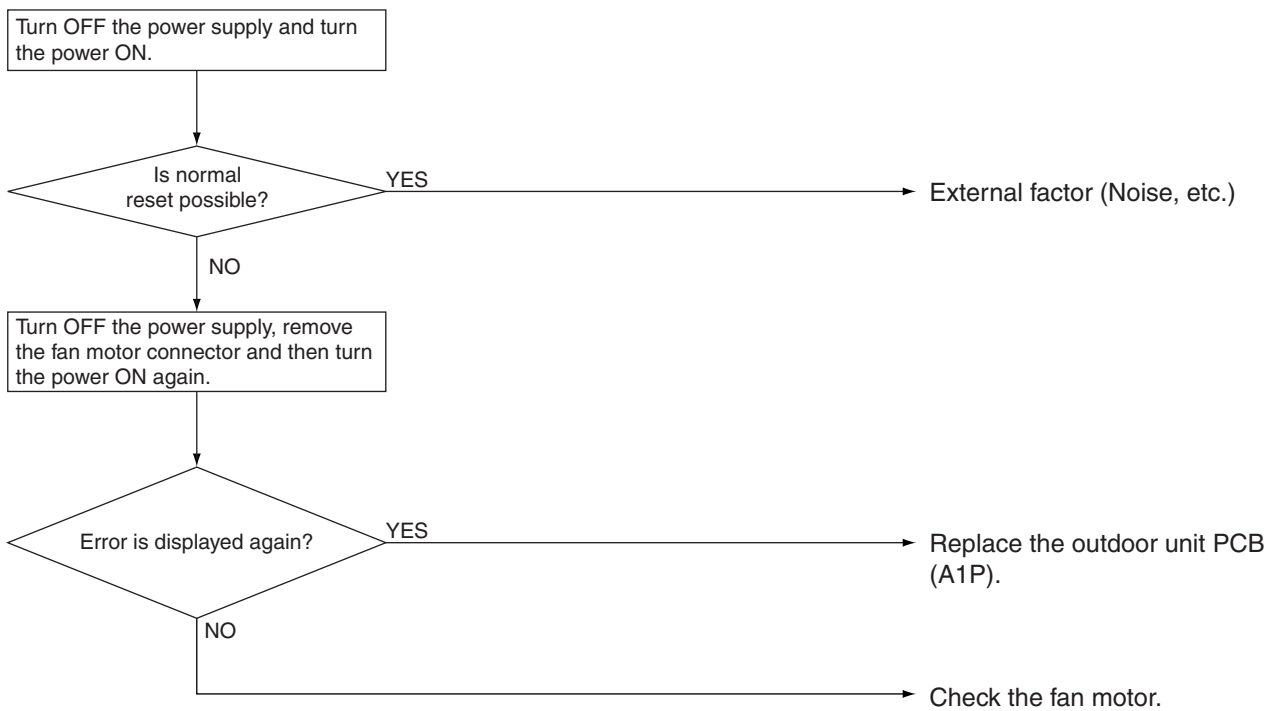

4.14 High Pressure Abnormality (Detected by the High Pressure Switch)

Remote Controller Display	
Applicable Models	RZQG71~140
Method of Error Detection	<p>[In cooling]</p> <ul style="list-style-type: none"> ■ Detect the continuity of high pressure switch (S1PH) with the protection device circuit. ■ The error is detected by the outdoor unit intermediate heat exchanger thermistor (R5T). <p>[In heating]</p> <ul style="list-style-type: none"> ■ Detect the continuity of high pressure switch (S1PH) with the protection device circuit. ■ The error is detected by the indoor unit intermediate heat exchanger thermistor (R3T).
Error Decision Conditions	<ul style="list-style-type: none"> ■ When the high pressure switch is activated (4.0 MPa) ■ When the outdoor unit intermediate thermistor (R5T) detects the pressure shown below. 3.92 MPa or more continuously for one minute (Reference: equivalent saturation temperature 62°C) ■ When the indoor unit intermediate thermistor (R3T) detects the pressure shown below. 3.92 MPa or more continuously for one minute (Reference: equivalent saturation temperature 62°C)
Supposed Causes	<ul style="list-style-type: none"> ■ Stop valve is not opened ■ Harness breaking or poor connector connection of the high pressure switch ■ Defective high pressure switch ■ Indoor unit suction filter is blocked (In heating) ■ Defective high pressure switch ■ Defective indoor unit fan (In heating) ■ Outdoor heat exchanger is dirt (In cooling) ■ Defective outdoor unit fan (In cooling) ■ Overcharge of refrigerant ■ Defective outdoor unit PCB (A1P)

Troubleshooting



Caution Be sure to turn off power switch before connect or disconnect connector, or parts damage may be occurred.

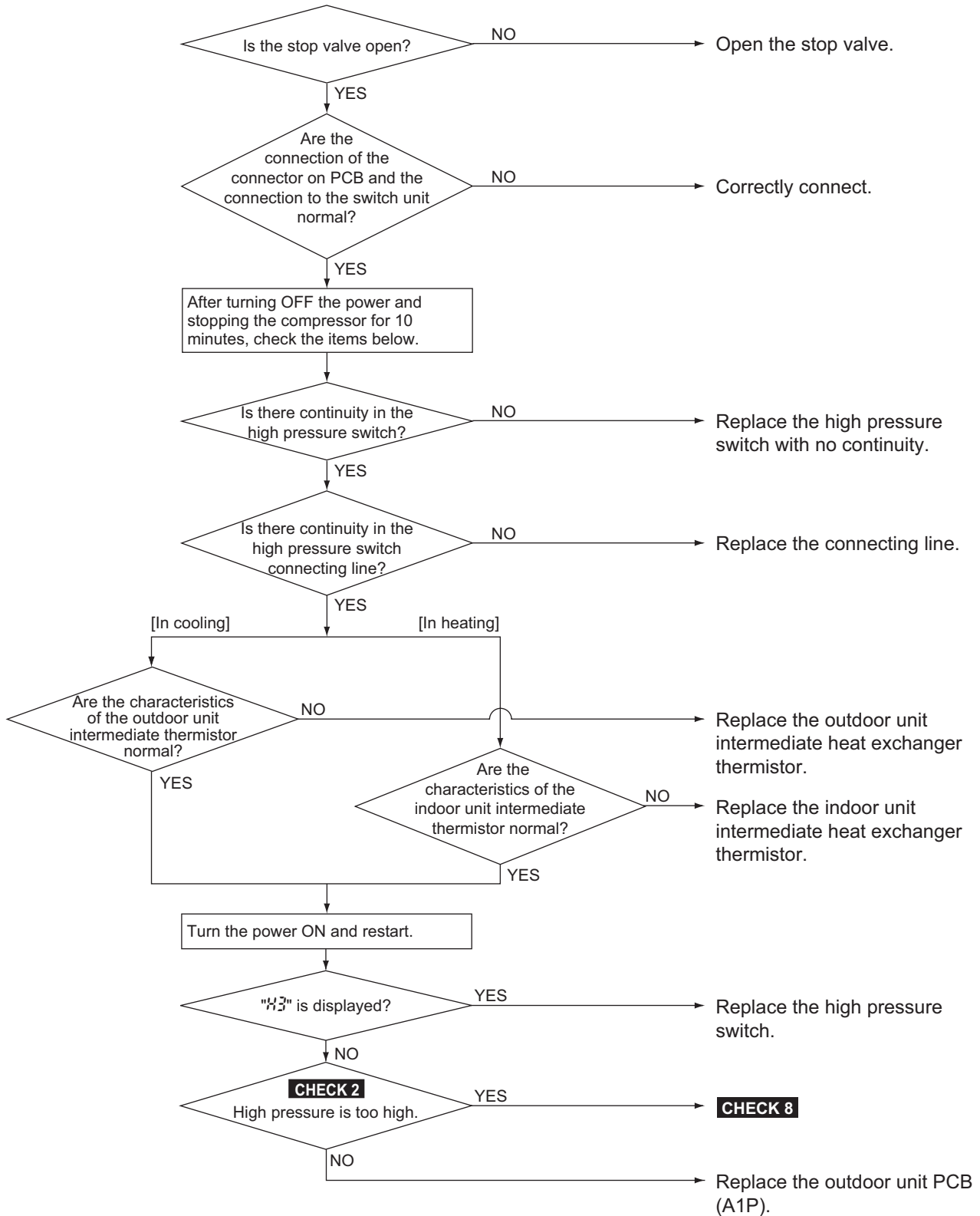

CHECK 2 Refer to P.188.

CHECK 8 Refer to P.193.

4.15 Actuation of Pressure Sensor

Remote Controller Display	
Applicable Models	RZQG
Method of Error Detection	<ul style="list-style-type: none"> ■ Detect the continuity of low pressure switch (S2PL) with the protection device circuit. [In cooling] ■ Detect error by the indoor unit intermediate thermistor (R3T). [In heating] ■ Detect error by the intermediate heat exchanger thermistor (R5T).
Error Decision Conditions	<ul style="list-style-type: none"> ■ When the low pressure switch is activated. ■ When the detection pressure is the following value 0.12MPa or less continues for 5 minutes (When the saturated pressure equivalent temperature is -34°C). This is explain for "0.12MPa".
Supposed Causes	<ul style="list-style-type: none"> ■ The stop valve is not opened ■ Disconnection of outdoor unit intermediate thermistor ■ Disconnection of indoor unit intermediate thermistor ■ Defective thermistor ■ Defective outdoor unit PCB (A1P) ■ Abnormal drop of low pressure ■ Refrigerant shortage

Troubleshooting



Caution Be sure to turn off power switch before connect or disconnect connector, or parts damage may be occurred.

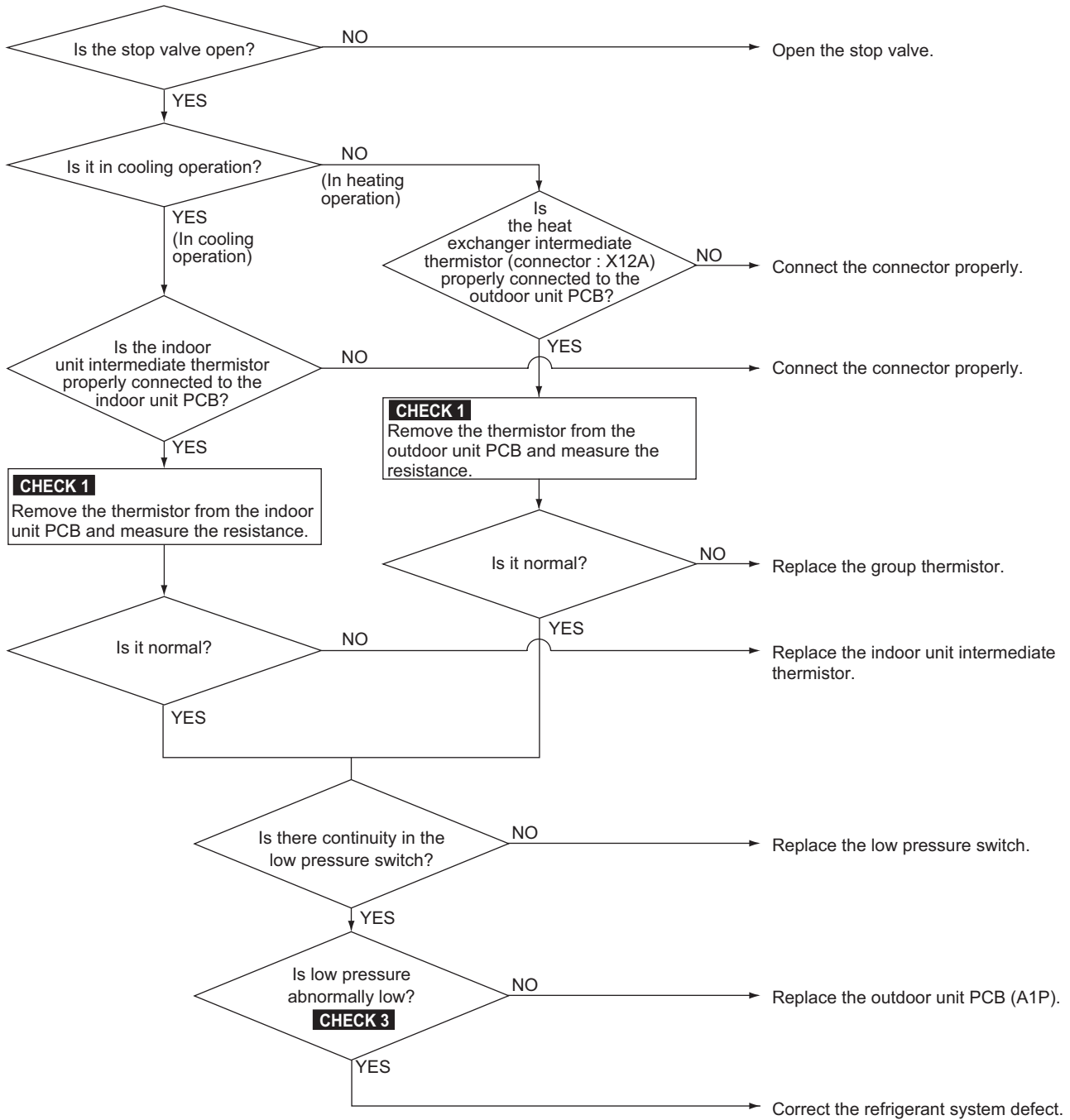

CHECK 1 Refer to P.185.

CHECK 3 Refer to P.189.

4.16 Compressor Motor Lock

Remote Controller Display	ES
Applicable Models	RZQG
Method of Error Detection	Detect the motor lock when the compressor is energized.
Error Decision Conditions	If the motor rotor does not rotate when the compressor is energized.
Supposed Causes	<ul style="list-style-type: none"> ■ Compressor lock ■ High differential pressure (2.6 MPa or more) starting ■ Stop valve is not opened

Troubleshooting



Caution Be sure to turn off power switch before connect or disconnect connector, or parts damage may be occurred.

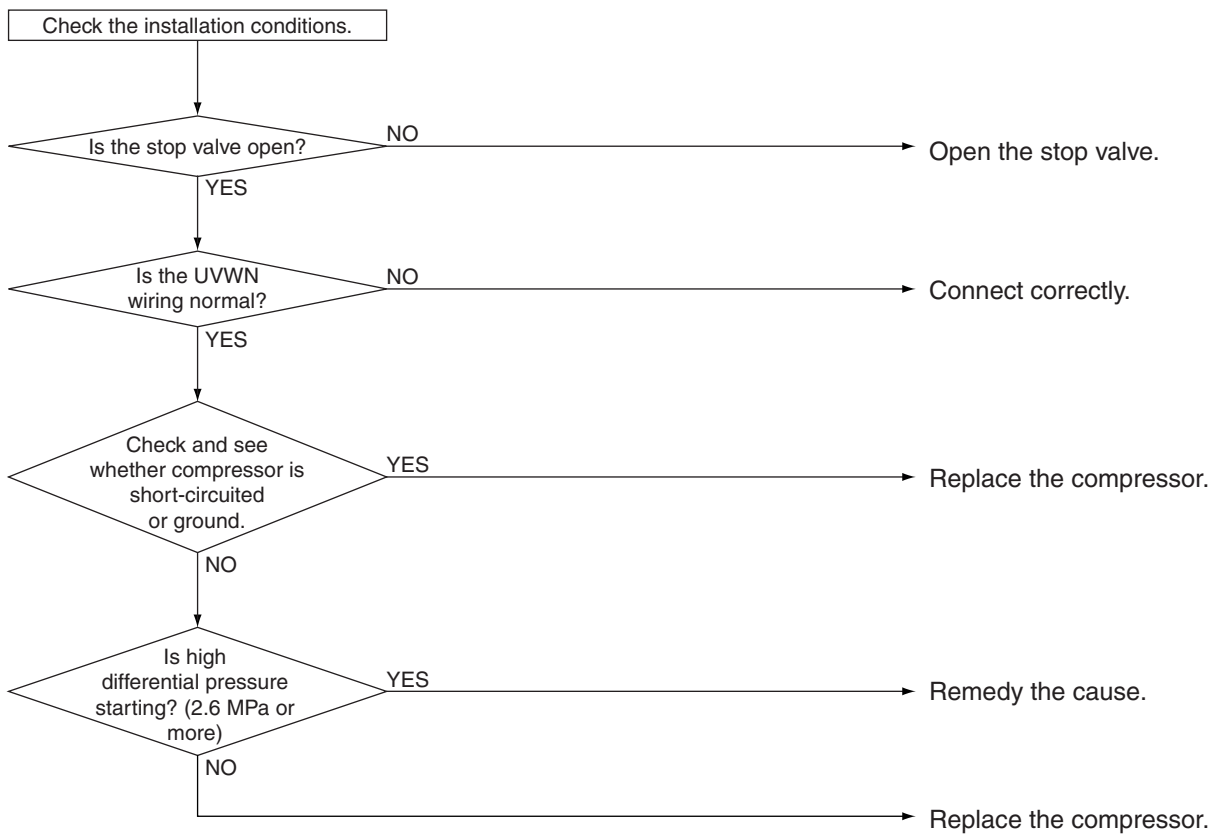

4.17 Outdoor Unit Fan Motor Abnormality

Remote Controller Display	E7
Applicable Models	RZQG
Method of Error Detection	Abnormality of fan motor system is detected according to the fan speed detected by hall IC when the fan motor runs.
Error Decision Conditions	<ul style="list-style-type: none"> ■ When the fan runs with speed less than a specified one for 15 seconds or more when the fan motor running conditions are met ■ When connector detecting fan speed is disconnected ■ When the error is generated 4 times, the system shuts down.
Supposed Causes	<ul style="list-style-type: none"> ■ Defective fan motor ■ The harness connector between fan motor and PCB is left in disconnected, or faulty connector ■ Fan does not run due to foreign matters tangled ■ Defective the outdoor PCB ■ Blowout of fuse ■ External factor (Noise, etc.)

Troubleshooting



Caution Be sure to turn off power switch before connect or disconnect connector, or parts damage may be occurred.



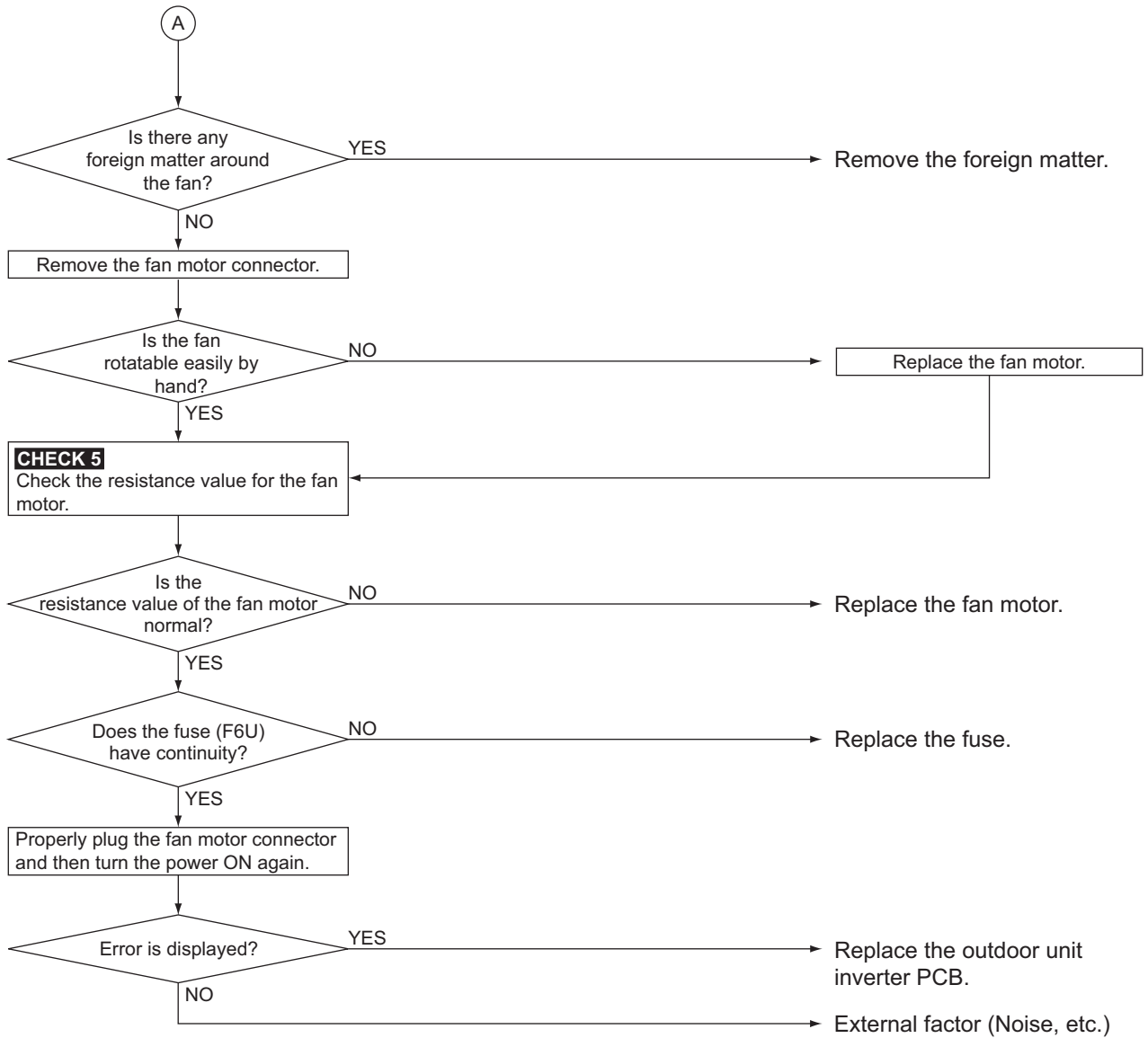

CHECK 5 Refer to P.191.

4.18 Electronic Expansion Valve Abnormality

Remote Controller Display	E9
Applicable Models	RZQG
Method of Error Detection	<ul style="list-style-type: none"> ■ The error is detected whether the continuity of electronic expansion valve exist or not. ■ The error is detected by the suction pipe superheat degree, discharge pipe superheat degree and electronic expansion valve opening degree.
Error Decision Conditions	<ul style="list-style-type: none"> ■ No common power supply when the power is ON. ■ When the following conditions are met <ul style="list-style-type: none"> · Suction pipe superheat degree < 4°C · Minimum electronic expansion valve opening degree · Discharge pipe superheat degree < 5°C
Supposed Causes	<ul style="list-style-type: none"> ■ Defective electronic expansion valve ■ Disconnection of electronic expansion valve harness ■ Defective connection of electronic expansion valve connector ■ Defective each thermistor and mounting thermistor ■ Defective pressure sensor ■ Defective outdoor unit PCB ■ Abnormal wet operation

Troubleshooting



Caution Be sure to turn off power switch before connect or disconnect connector, or parts damage may be occurred.

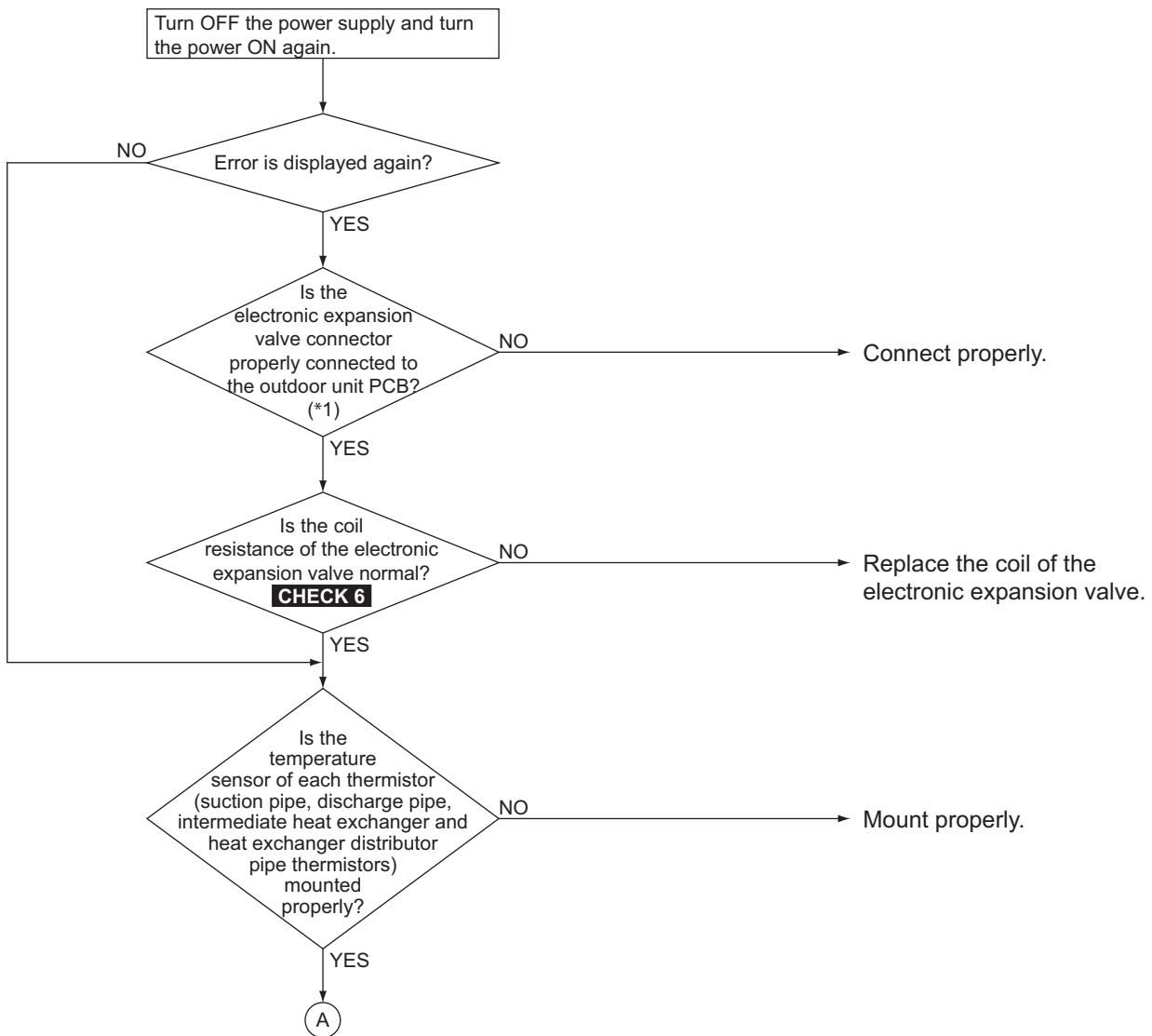

Note:

*1 Connector and indoor unit PCB

Model	Connector for electronic expansion valve	PCB
RZQG	X21A	A1P



CHECK 6 Refer to P.191.

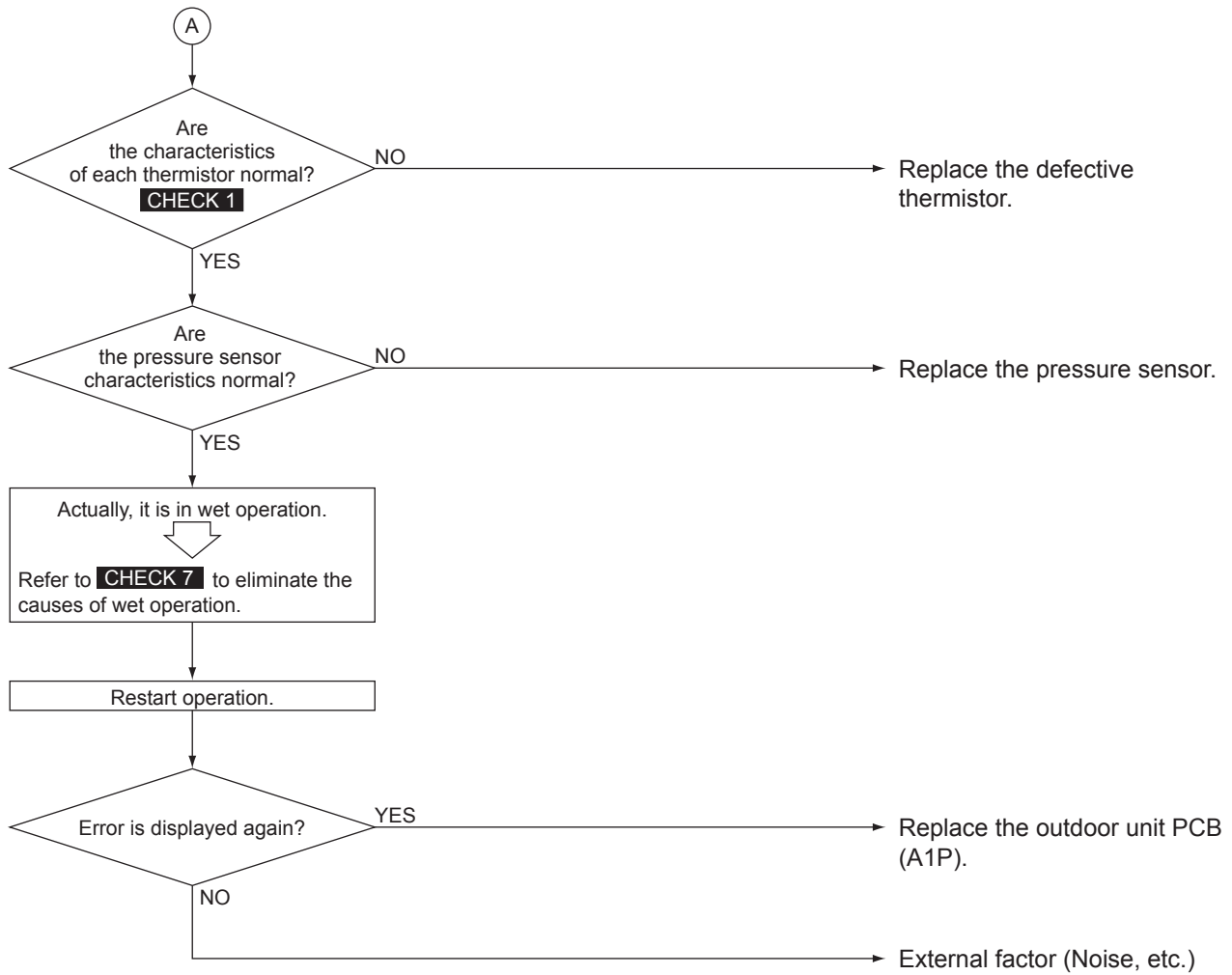

CHECK 1 Refer to P.185.

CHECK 7 Refer to P.192.

4.19 Discharge Pipe Temperature Control

<p>Remote Controller Display</p>	
<p>Applicable Models</p>	<p>RZQG</p>
<p>Method of Error Detection</p>	<p>The error is detected according to the temperature detected by the discharge pipe temperature sensor.</p>
<p>Error Decision Conditions</p>	<ul style="list-style-type: none"> ■ When the discharge pipe temperature rises to an abnormally high level ■ When the discharge pipe temperature rises suddenly ■ When the discharge pipe temperature does not rise after operation start
<p>Supposed Causes</p>	<ul style="list-style-type: none"> ■ Defective discharge pipe thermistor ■ Defective connection of discharge pipe thermistor ■ Refrigerant shortage ■ Defective compressor ■ Disconnection of discharge pipe thermistor ■ Defective outdoor unit PCB

Troubleshooting



Caution Be sure to turn off power switch before connect or disconnect connector, or parts damage may be occurred.

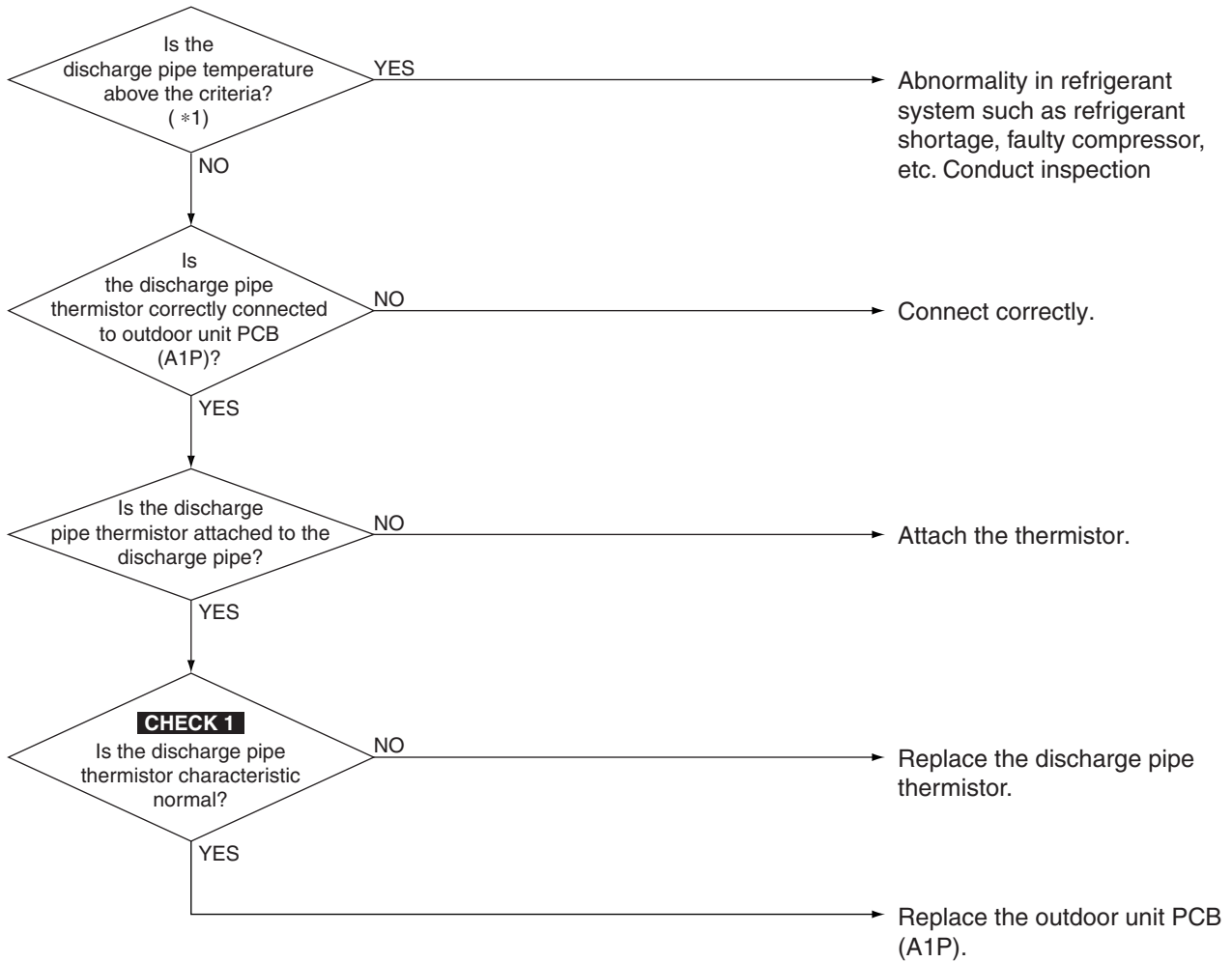

Note:

*1 Temperature varies depending on model type.

Model	Temperature
RZQG71	110 °C
RZQG100-140	115 °C



CHECK 1 Refer to P.185.

4.20 High Pressure Switch System Abnormality

Remote Controller Display	
Applicable Models	RZQG125, 140
Method of Error Detection	The protection device circuit checks continuity in the high pressure switch (S1PH).
Error Decision Conditions	When there is no continuity in the high pressure switch during compressor stops operating.
Supposed Causes	<ul style="list-style-type: none"> ■ Incomplete high pressure switch ■ Defective connection of high pressure switch connector ■ Defective outdoor unit PCB ■ Disconnected lead wire

Troubleshooting



Caution Be sure to turn off power switch before connect or disconnect connector, or parts damage may be occurred.

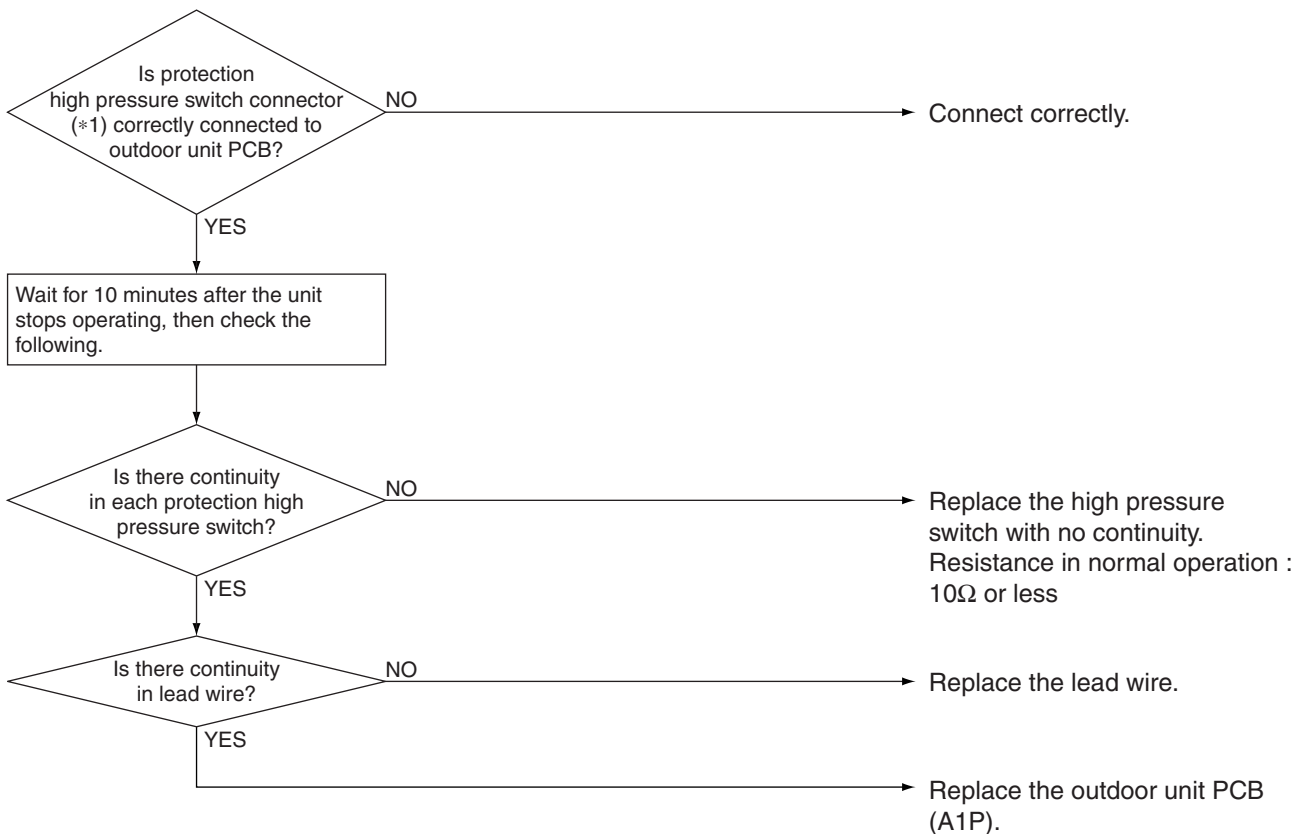

Note:

*1 Connector and indoor unit PCB

Model	Connector for high pressure switch	PCB
RZQG	X32A	A1P

4.21 Low Pressure Switch System Abnormality

Remote Controller Display	
Applicable Models	RZQG71~140
Method of Error Detection	Check the continuity of LPS.
Error Decision Conditions	When there is no continuity in the LPS during compressor start operating.
Supposed Causes	<ul style="list-style-type: none"> ■ Faulty LPS ■ Disconnection in LPS harness ■ Faulty connection of LPS connector ■ Defect of outdoor unit PC board ■ Refrigerant shortage ■ Stop valve is not opened ■ Defective expansion valve

Troubleshooting



Caution Be sure to turn off power switch before connect or disconnect connector, or parts damage may be occurred.

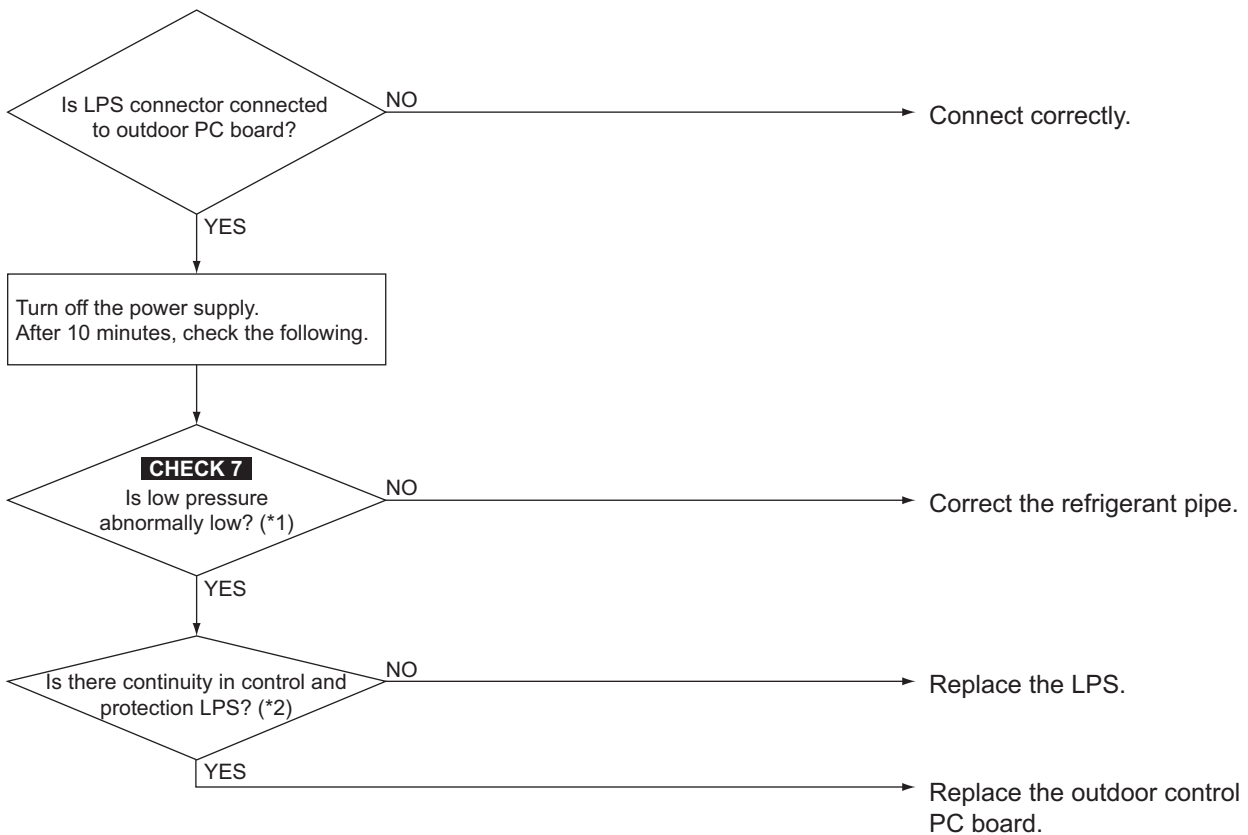

Note:

- *1 Verify why pressure in the unit is abnormally low
- *2 LPS resistance (closed contact) should be < 10Ω

4.22 Thermistor System Abnormality

Remote Controller Display	H9, U3, U5, U6, U7, U8
Applicable Models	RZQG
Method of Error Detection	The error is detected according to the temperature detected by each individual thermistor.
Error Decision Conditions	When thermistor is disconnected or short circuited during operation
Supposed Causes	<ul style="list-style-type: none"> ■ Defective thermistor ■ Defective connection of connector ■ Defective outdoor unit PCB (A1P)

Troubleshooting



Caution Be sure to turn off power switch before connect or disconnect connector, or parts damage may be occurred.

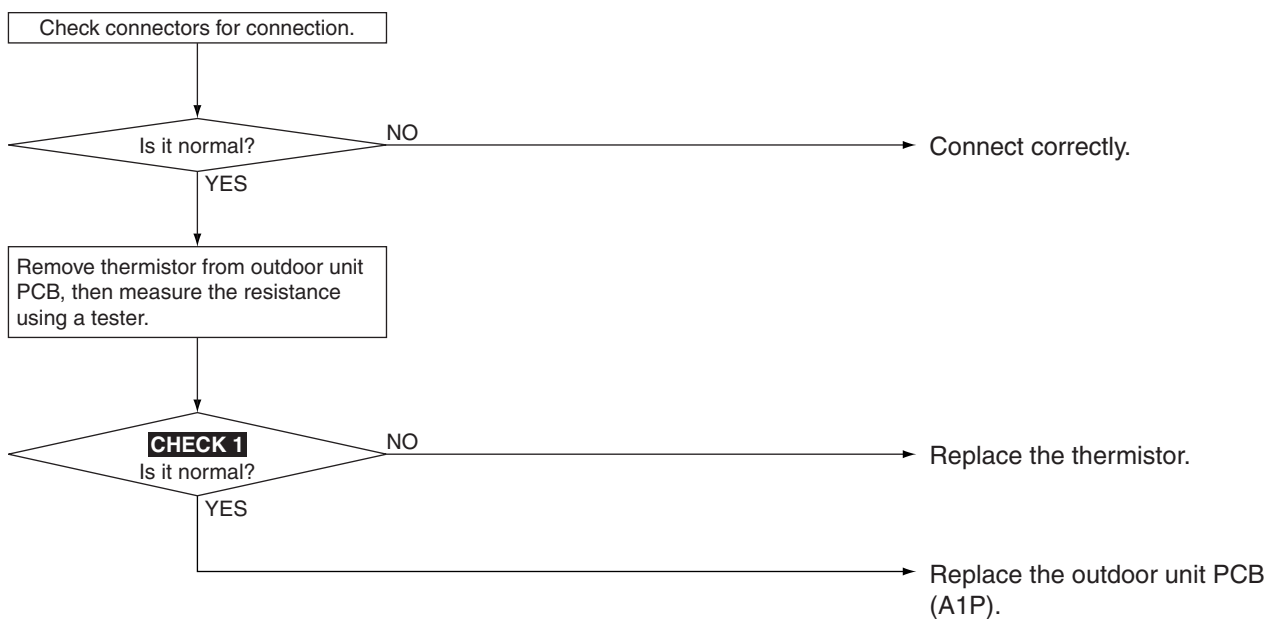

Error Code	Defective Thermistor	Symbol
H9	Outdoor air thermistor	R1T
U3	Discharge pipe thermistor	R2T
U5	Suction pipe thermistor	R3T
U6	Heat exchanger thermistor	R4T
U7	Intermediate heat exchanger thermistor	R5T
U8	Liquid pipe thermistor	R6T



CHECK 1 Refer to P.185.

4.23 Outdoor Unit PCB Abnormality

Remote Controller Display	L I
Applicable Models	RZQG
Method of Error Detection	<ul style="list-style-type: none"> ■ Detect error by current value during waveform output before compressor startup. ■ Detect error by current sensor value during synchronized operation at the time of startup. ■ Detect error using an MP-PAM series capacitor overvoltage sensor.
Error Decision Conditions	<ul style="list-style-type: none"> ■ When over-current is detected at the time of waveform output during operating the compressor ■ When the current sensor error during synchronized operation ■ When overvoltage occurs in MP-PAM ■ In case of IGBT error ■ In case of faulty in E²PROM
Supposed Causes	<ul style="list-style-type: none"> ■ External factor (Noise, etc.) ■ Defective outdoor unit fan motor ■ Broken fuse ■ Disconnection of compressor ■ Defective outdoor unit PCB (A1P) <ul style="list-style-type: none"> · IPM failure · Current sensor failure · MP-PAM failure · Defective IGBT or drive circuit · Defective inverter E²PROM

Troubleshooting



Caution Be sure to turn off power switch before connect or disconnect connector, or parts damage may be occurred.

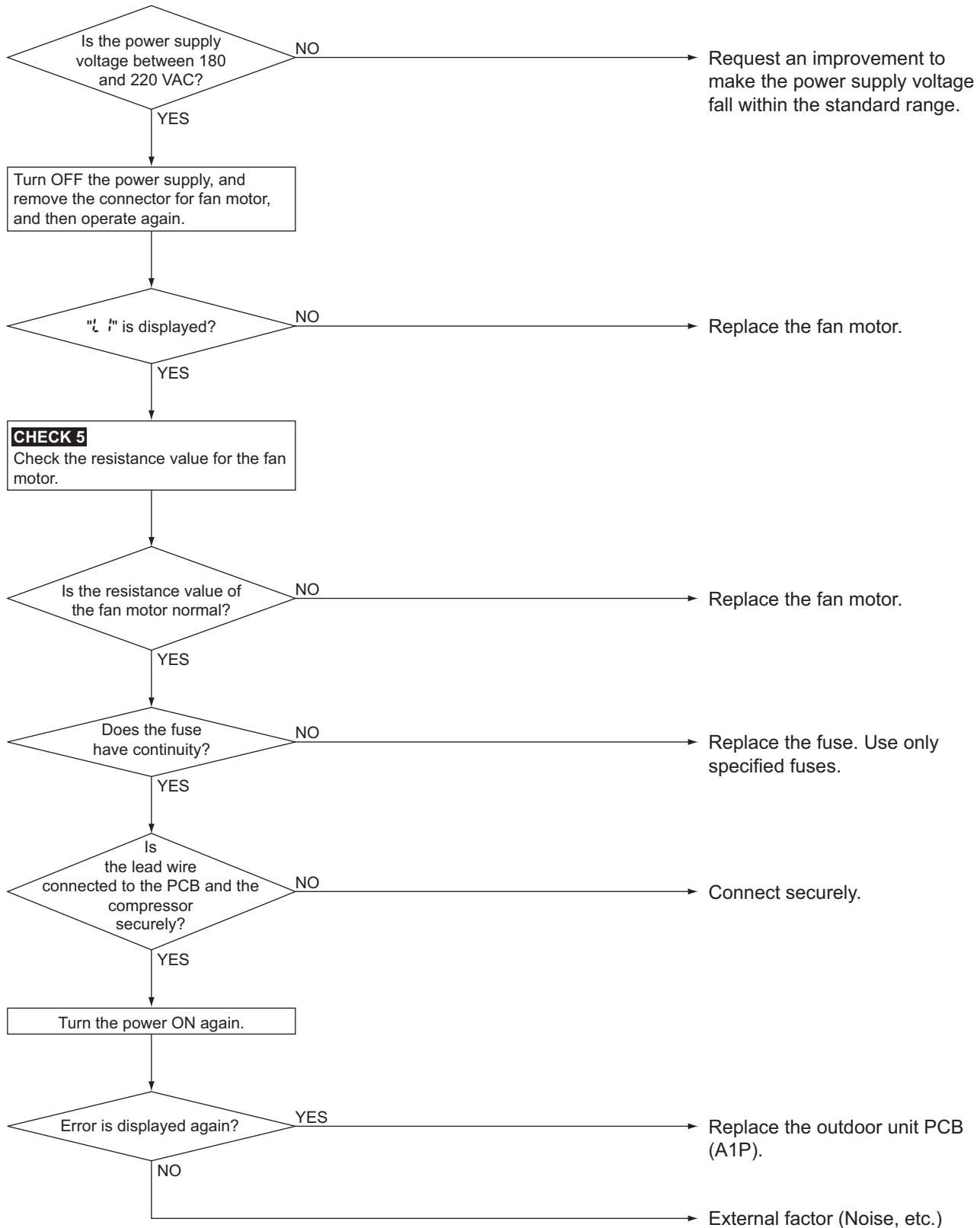

CHECK 5 Refer to P.191.

4.24 Radiation Fin Temperature Rise

Remote Controller Display	L4
Applicable Models	RZQG
Method of Error Detection	Radiation fin temperature is detected by the radiation fin thermistor.
Error Decision Conditions	When the temperature of the inverter radiation fin rises abnormally due to faulty heat dissipation.
Supposed Causes	<ul style="list-style-type: none"> ■ Actuation of fin thermal switch ■ Insufficient cooling of inverter radiation fin ■ High outdoor air temperature ■ Blocked suction inlet ■ Blocked discharge outlet ■ Dirty radiation fin ■ Disconnection of connector ■ Defective radiation fin thermistor ■ Defective outdoor unit inverter PCB

Troubleshooting



Caution Be sure to turn off power switch before connect or disconnect connector, or parts damage may be occurred.

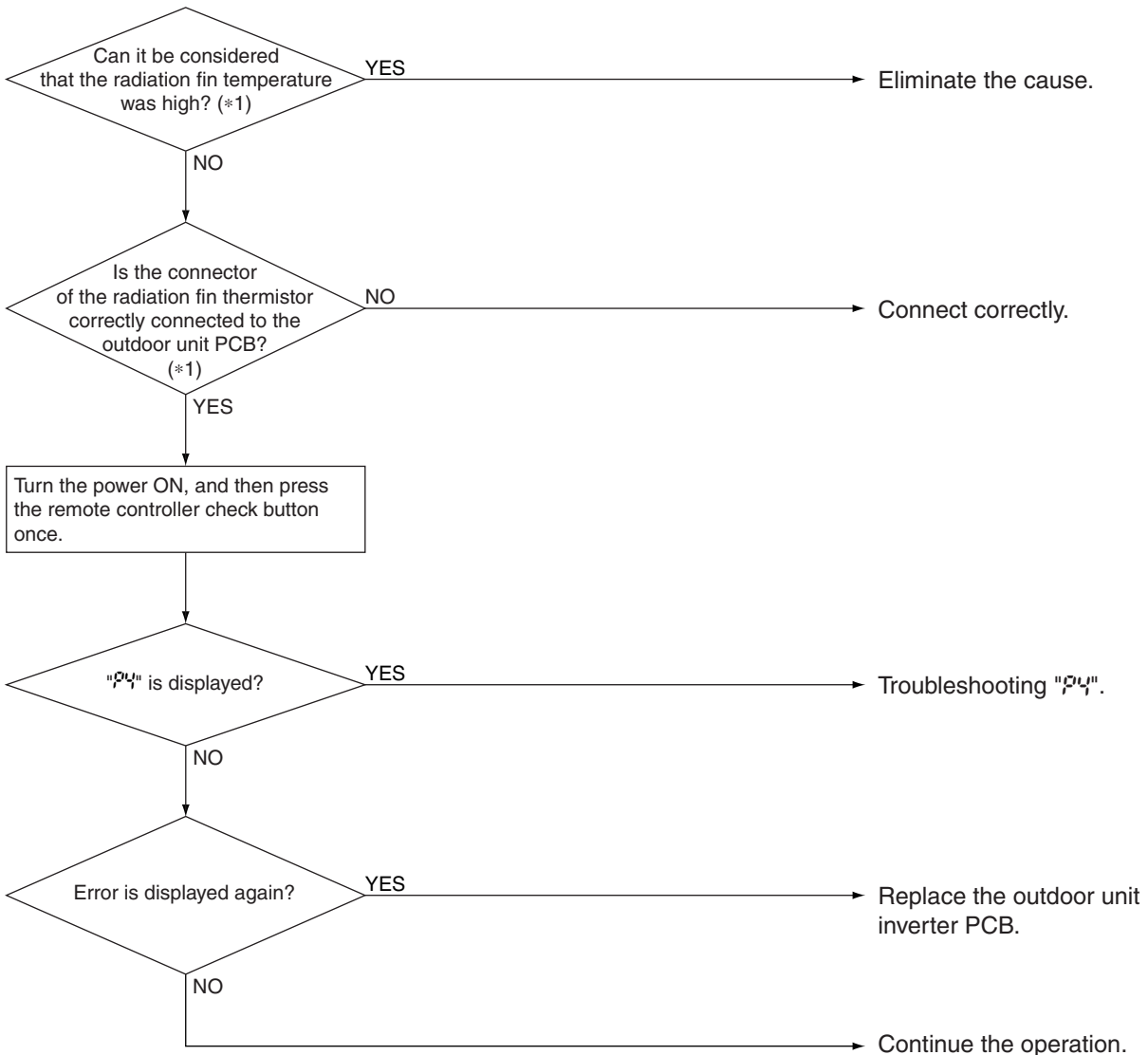

Note:

*1 Radiation fin temperature detection value

Model	Detection	Reset
RZQG71	91°C	81°C
RZQG100-140	68°C	58°C

4.25 Output Overcurrent Detection

Remote Controller Display	LS
Applicable Models	RZQG
Method of Error Detection	The error is detected by converting the current flowing to power transistor into voltage with CT1 (DC current sensor).
Error Decision Conditions	When overcurrent has run to power transistor. (Actuated even by instantaneous overcurrent)
Supposed Causes	<ul style="list-style-type: none"> ■ Defective compressor (mechanical lock, poor insulation) ■ Defective inverter PCB ■ Instantaneous fluctuation of power supply voltage ■ Defective compressor (if bearing is scratched) ■ Stop valve is not opened.

Troubleshooting



Caution Be sure to turn off power switch before connect or disconnect connector, or parts damage may be occurred.

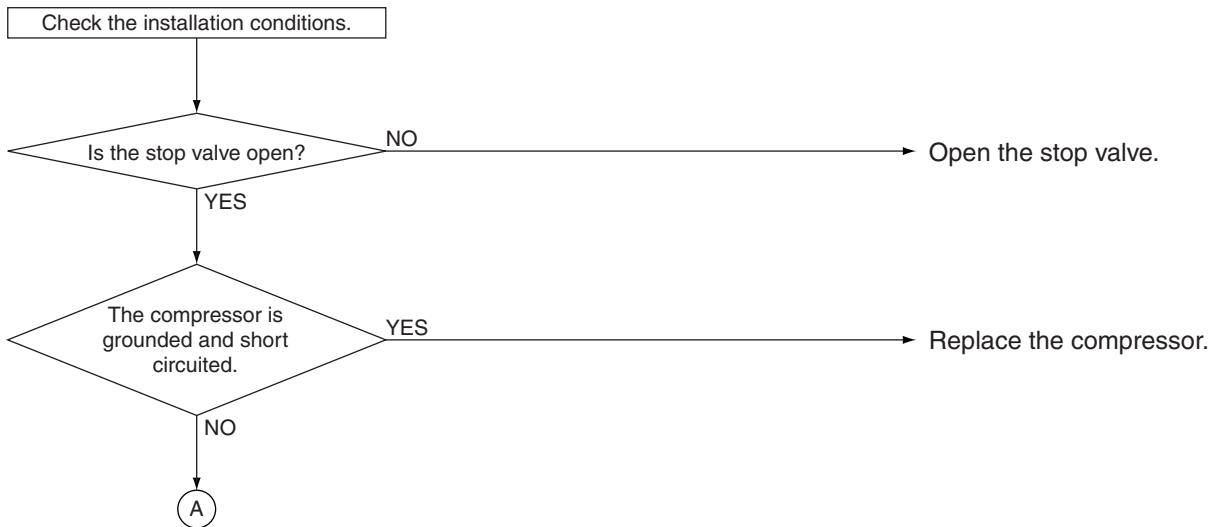

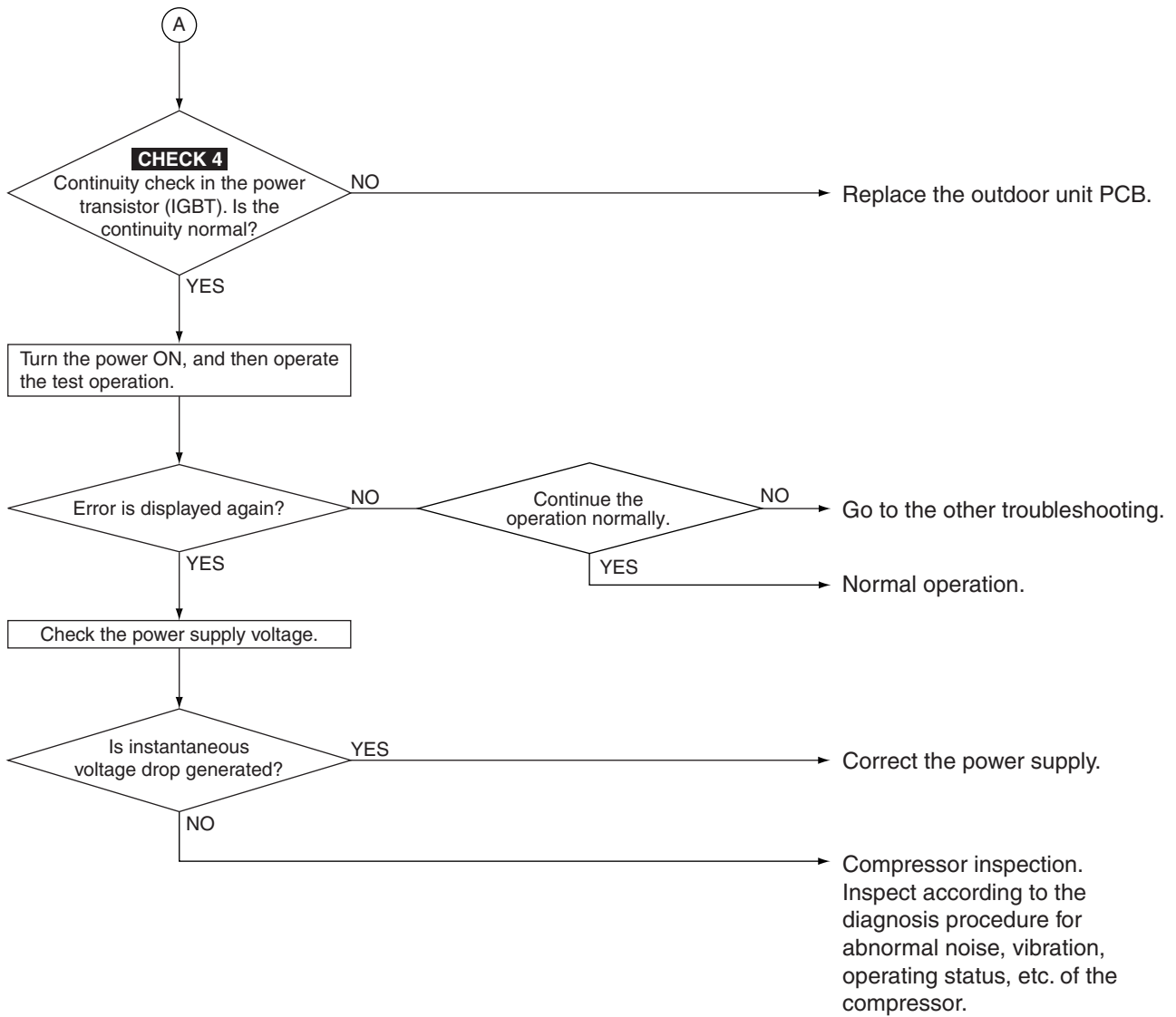

CHECK 4 Refer to P.190.

4.26 Electronic Thermal (Time Lag)

Remote Controller Display	L8
Applicable Models	RZQG
Method of Error Detection	The error is detected from the current flowing to power transistor into voltage with CT1 (DC current sensor).
Error Decision Conditions	When compressor overload (except for when startup) is detected.
Supposed Causes	<ul style="list-style-type: none"> ■ Disconnected compressor coil ■ High pressure is abnormal high ■ Defective compressor (if bearing is scratched) ■ Defective outdoor unit PCB ■ Stop valve is not opened

Troubleshooting



Caution Be sure to turn off power switch before connect or disconnect connector, or parts damage may be occurred.

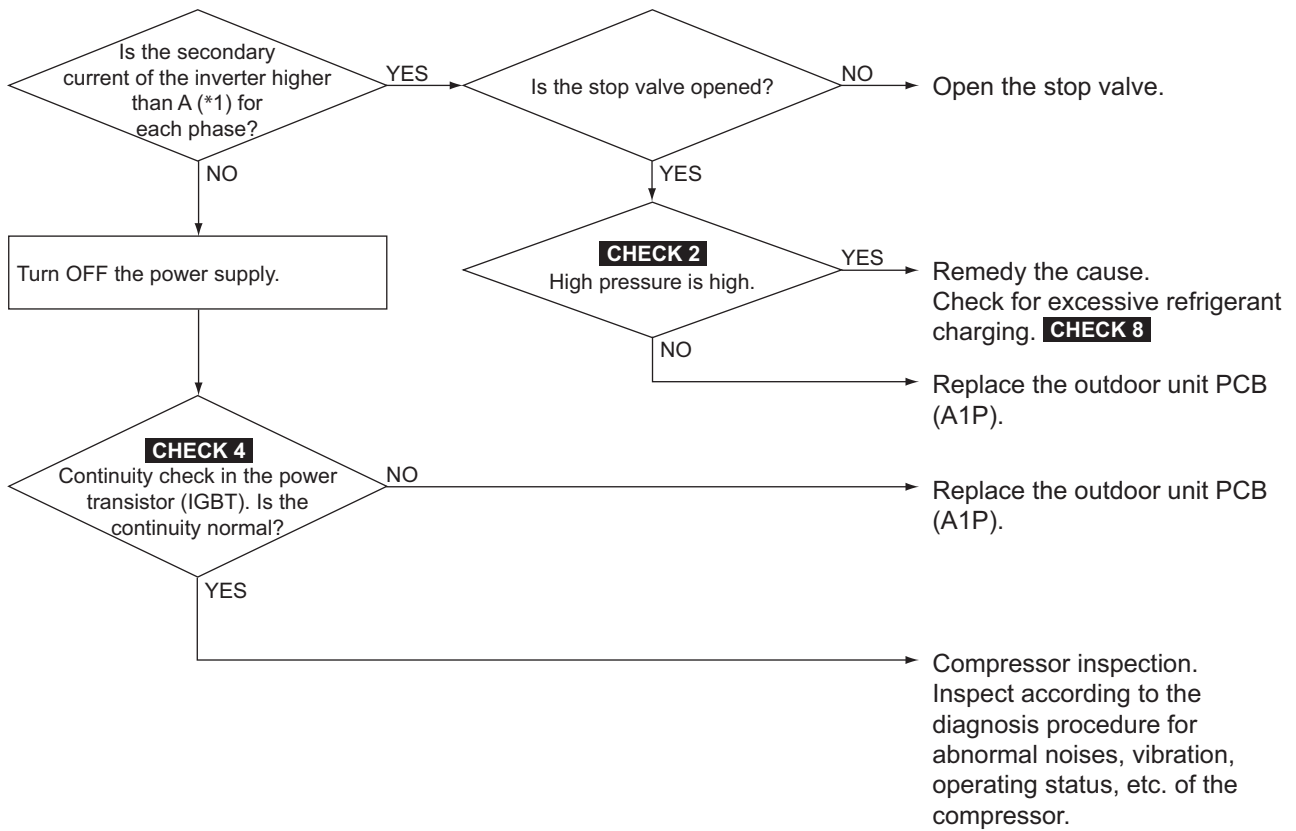

Note:

*1 Secondary electronic thermal detection value

Model		Detection value
RZQG71	Cooling	12.6 or 12.2A × 260 seconds
	Heating	14.8A × 260 seconds
RZQG100-140	Cooling	16.1A × 260 seconds
	Heating	22.1A × 260 seconds



CHECK 2 Refer to P.188.

CHECK 4 Refer to P.190.

CHECK 8 Refer to P.193.

4.27 Stall Prevention (Time Lag)

Remote Controller Display	L9
Applicable Models	RZQG
Method of Error Detection	The error is detected by converting the current flowing to power transistor into voltage with CT1 (DC current sensor). Inverter PCB detects the disorder of position signal.
Error Decision Conditions	When compressor overload and change of load are detected when startup
Supposed Causes	<ul style="list-style-type: none"> ■ Stop valve is not opened. ■ Pressure differential startup ■ Defective outdoor unit inverter PCB ■ Defective compressor (lock)

Troubleshooting



Caution Be sure to turn off power switch before connect or disconnect connector, or parts damage may be occurred.

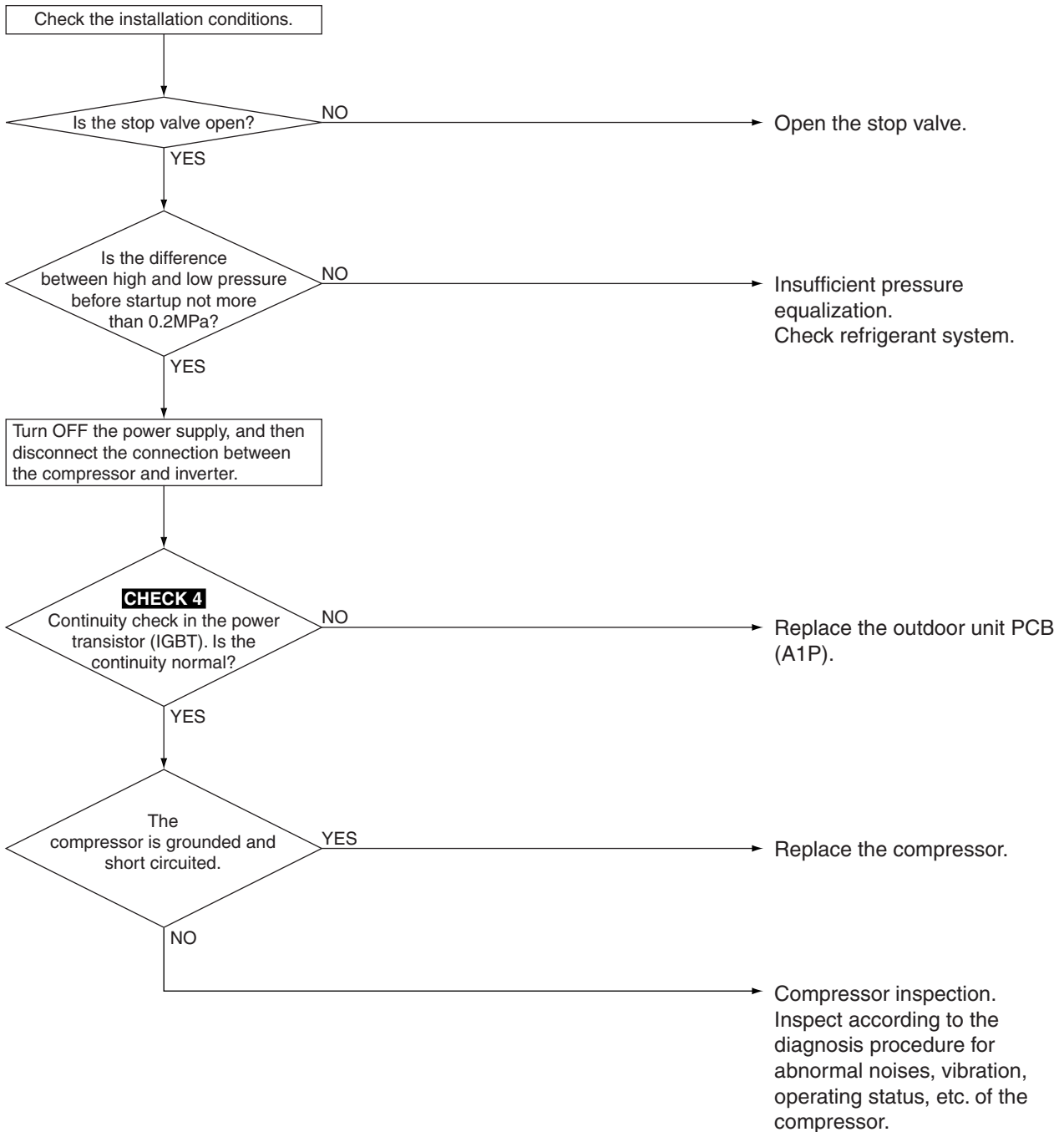

CHECK 4 Refer to P.190.

4.28 Transmission System Abnormality (between Control and Inverter PCB)

Remote Controller Display



Applicable Models

RZQG

Method of Error Detection

Check whether transmission between control and inverter PCB is carried out normally.

Error Decision Conditions

When the transmission is not carried out in a specified period of time or longer

Supposed Causes

- Defective outdoor fan motor
- Defective of fan motor connector contact
- Defective control and inverter PCB
- External factor (Noise, etc.)

Troubleshooting



Caution Be sure to turn off power switch before connect or disconnect connector, or parts damage may be occurred.

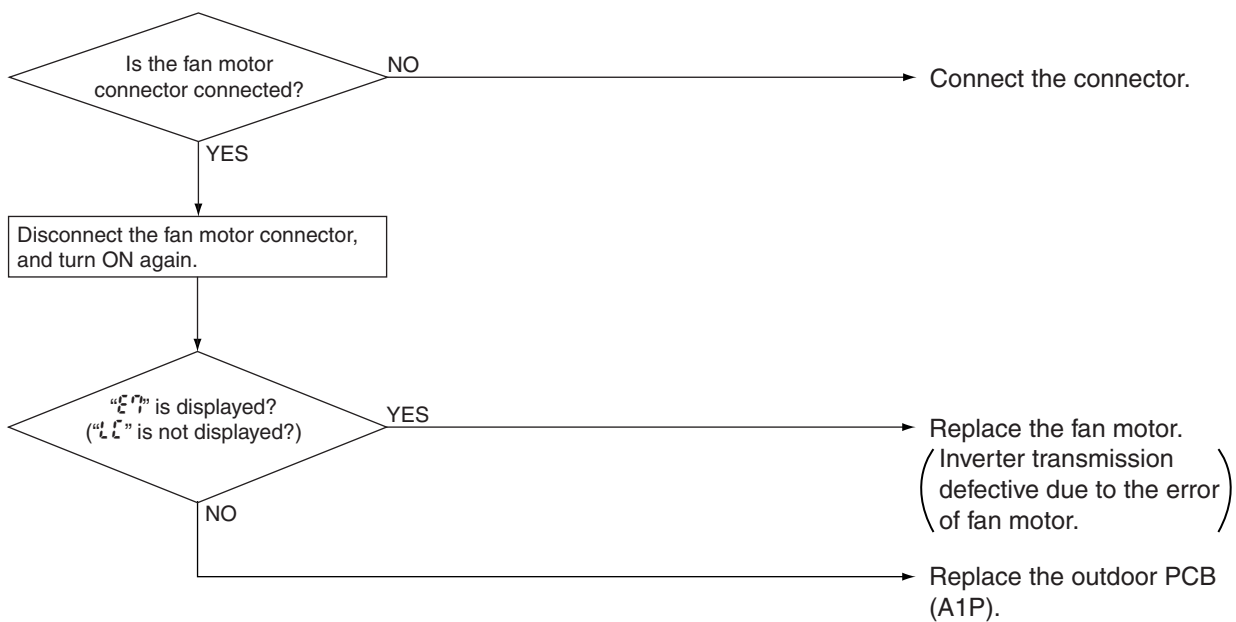

4.29 Open Phase or Power Supply Voltage Imbalance

Remote Controller Display	P1
Applicable Models	RZQG
Method of Error Detection	The error is detected according to the voltage waveform of main circuit capacitor built in inverter.
Error Decision Conditions	When the aforementioned voltage waveform becomes identical with the waveform of the power supply open phase.
Supposed Causes	<ul style="list-style-type: none"> ■ Open phase ■ Voltage imbalance between phases ■ Defective outdoor unit PCB <ul style="list-style-type: none"> · Defective main circuit capacitor · Power unit (Disconnection in diode module) · Defective magnetic relay (K1R, K10R) · Improper main circuit wiring

Troubleshooting



Caution Be sure to turn off power switch before connect or disconnect connector, or parts damage may be occurred.

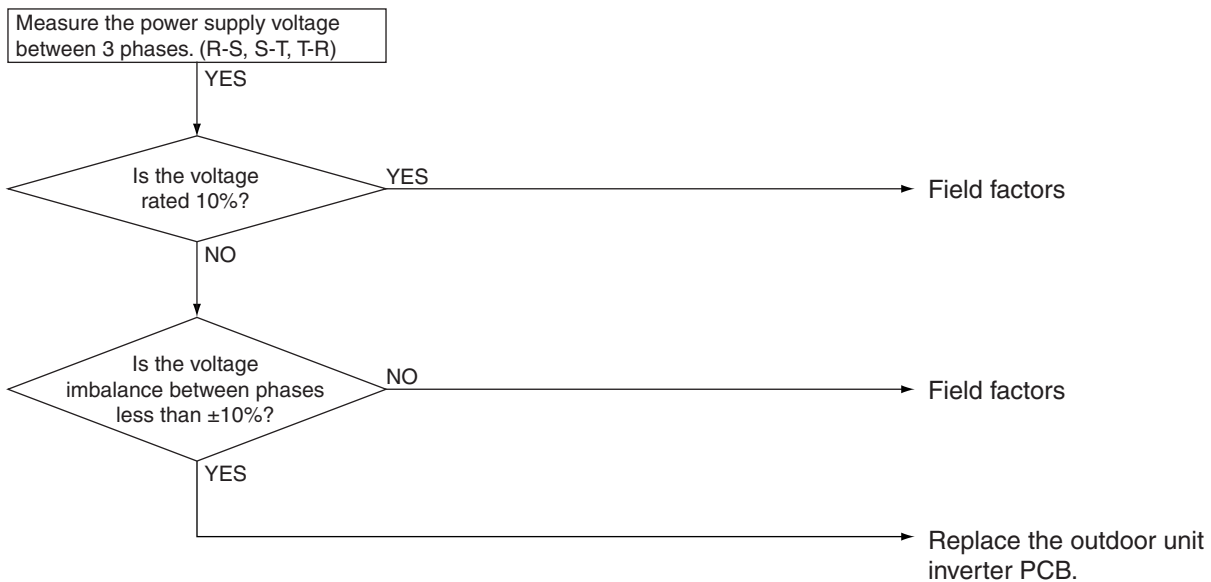

4.30 Defective Capacity Setting

Remote Controller Display	
Applicable Models	RZQG
Method of Error Detection	Check whether set value written in E ² PROM (at factory) or set value of capacity setting adaptor (for spare) is the same as outdoor unit capacity.
Error Decision Conditions	When the set value on E ² PROM differs from the outdoor unit capacity or a capacity setting adaptor except for PCB applicable models is installed. (Error decision is made only when turning the power supply ON.)
Supposed Causes	<ul style="list-style-type: none"> ■ Improper set value of E²PROM ■ Improper capacity setting adaptor ■ Mismatching of type of PCB

Troubleshooting



Caution Be sure to turn off power switch before connect or disconnect connector, or parts damage may be occurred.

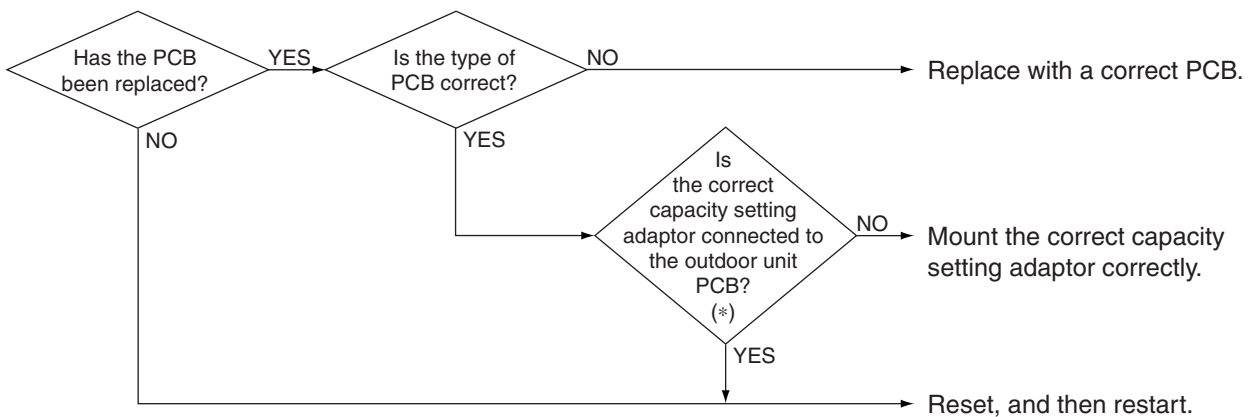

Note:

* Capacity setting adaptor is not connected at factory. (Capacity is written in E²PROM.) Capacity setting adaptor is required only when the PCB was replaced with a spare PCB.

4.31 Refrigerant Shortage (Alert)

Remote Controller Display	
Applicable Models	RZQG
Method of Error Detection	Refrigerant shortage is detected according to the electronic expansion valve opening degree and measured temperatures and pressures.
Error Decision Conditions	<p>(In cooling operation) When the electronic expansion valve opens fully and low pressure is below 0.25 MPa continuously for 30 seconds.</p> <p>(In heating operation) When the electronic expansion valve opens fully and the suction superheat is large (more than 20°C) continuously for 60 seconds.</p> <p>* Even if error occurs, operation will continue.</p>
Supposed Causes	<ul style="list-style-type: none"> ■ Stop valve is not opened ■ Insufficient refrigerant amount ■ Clogged refrigerant piping system

Troubleshooting



Caution Be sure to turn off power switch before connect or disconnect connector, or parts damage may be occurred.

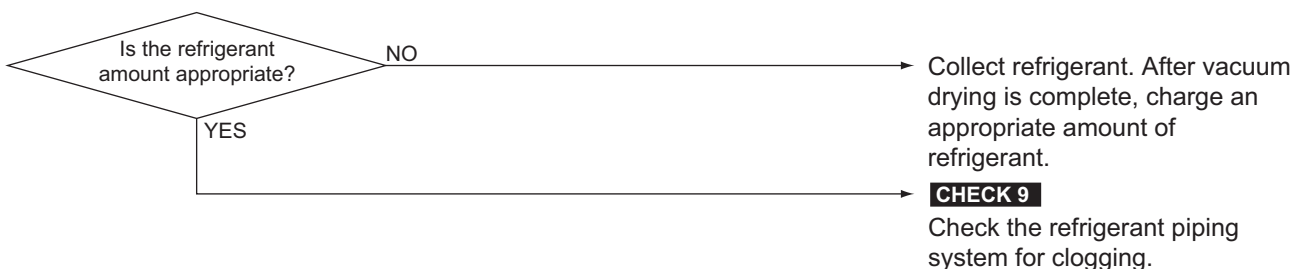

Note:

* Refrigerant shortage alarm is indicated but operation continues.



CHECK 9 Refer to P.194.

4.32 Refrigerant Shortage (Error)

Remote Controller Display	
Applicable Models	RZQG
Method of Error Detection	<p>(In cooling) Detection based on difference in temperature between temperature set by remote controller and indoor suction air temperature, electronic expansion valve opening degree, compressor frequency and low pressure.</p> <p>(In heating) Detection based on difference in temperature between temperature set by remote controller and indoor suction air temperature, electronic expansion valve opening degree during the control of suction air superheating, high pressure, indoor heat exchanger temperature and indoor suction air temperature.</p>
Error Decision Conditions	<p>(In cooling) When compressor frequency does not increase even though the load is heavy because the electronic expansion valve is opened to the fullest extent</p> <p>(In heating) When suction gas superheat degree is large, compressor frequency is low and the electronic expansion valve is opened to the fullest extent even though heating load is heavy [If high pressure is lower than saturated pressure for indoor heat exchanger temperature (or indoor suction air temperature), error is confirmed.]</p>
Supposed Causes	<ul style="list-style-type: none"> ■ Refrigerant shortage ■ Clogged refrigerant piping system ■ Mismatching of wiring and piping ■ Stop valve is not opened

Troubleshooting



Caution Be sure to turn off power switch before connect or disconnect connector, or parts damage may be occurred.

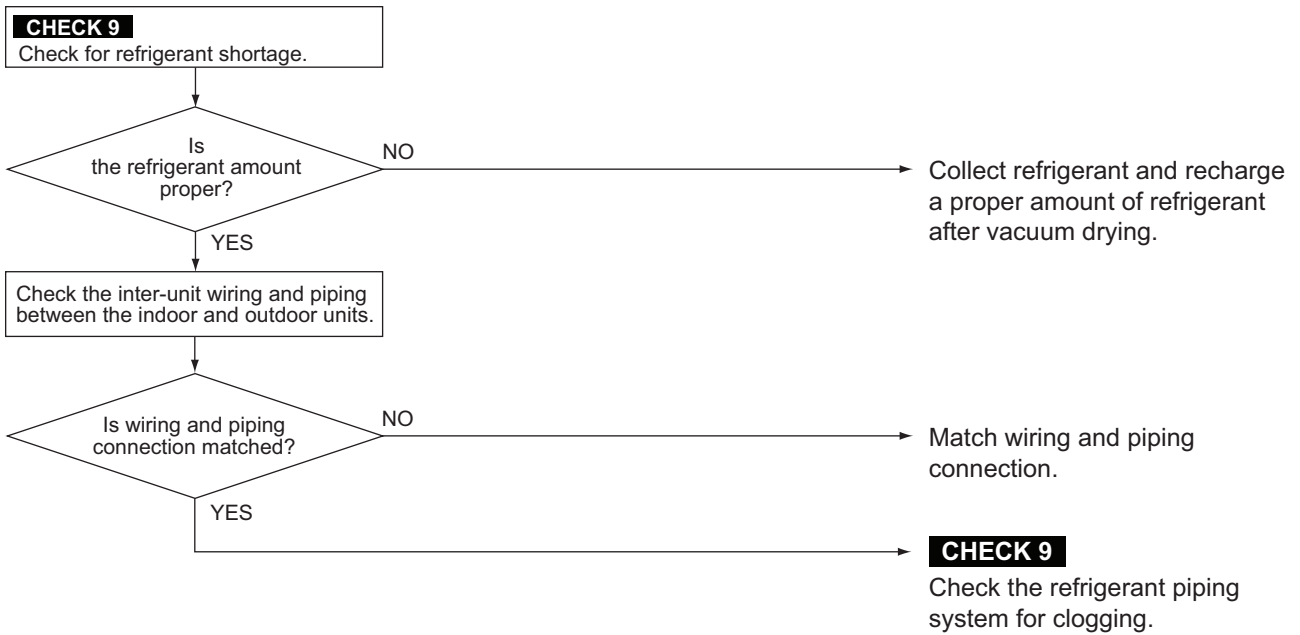

CHECK 9 Refer to P.194.

4.33 Power Supply Voltage Abnormality

Remote Controller Display	U2
Applicable Models	RZQG
Method of Error Detection	The error is detected according to the voltage of main circuit capacitor built in the inverter and power supply voltage.
Error Decision Conditions	When the voltage of main circuit capacitor built in the inverter and power supply voltage drop or when the power failure of several tens of ms or more is generated.
Supposed Causes	<ul style="list-style-type: none"> ■ Drop in power supply voltage ■ Defective outdoor fan motor ■ Instantaneous power failure ■ Defective outdoor unit inverter PCB ■ Main circuit parts damaged

Troubleshooting



Caution Be sure to turn off power switch before connect or disconnect connector, or parts damage may be occurred.

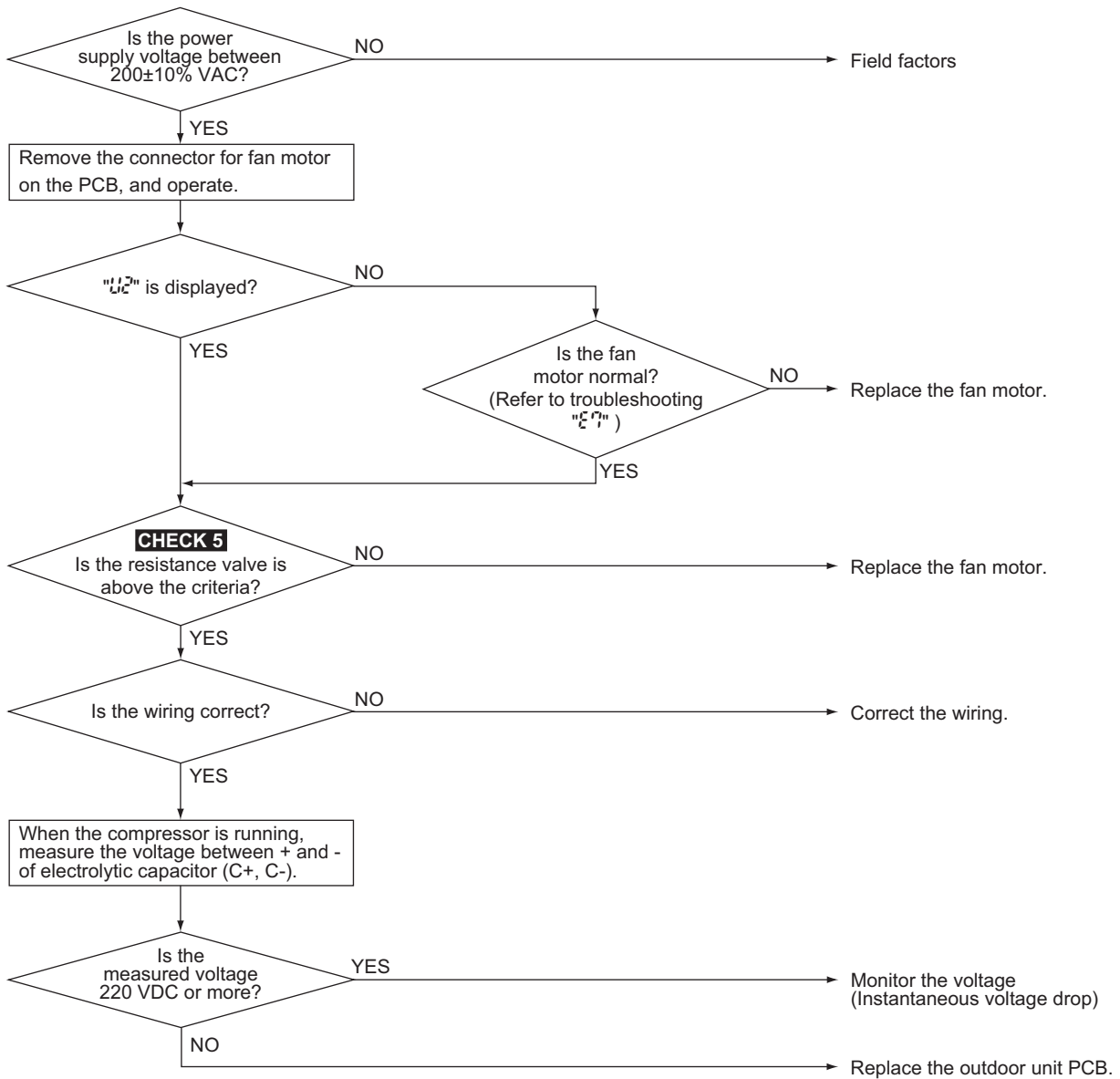

CHECK 5 Refer to P.191.

4.34 Transmission Error between Indoor and Outdoor Unit

Remote Controller Display	U4
Applicable Models	RZQG
Method of Error Detection	The error is generated when the micro-processor detects that the transmission between the indoor and the outdoor unit is not normal over a certain amount of time.
Error Decision Conditions	When the transmission is not carried out normally over a certain amount of time.
Supposed Causes	<ul style="list-style-type: none"> ■ Wiring indoor-outdoor transmission wire is incorrect ■ Defective indoor unit PCB ■ Defective outdoor unit PCB ■ Burning out fuse ■ Defective outdoor fan motor ■ External factor (Noise, etc.) ■ Defective power supply ■ Disconnection of optional equipments ■ Connector is defective (X806A)

Troubleshooting



Caution Be sure to turn off power switch before connect or disconnect connector, or parts damage may be occurred.

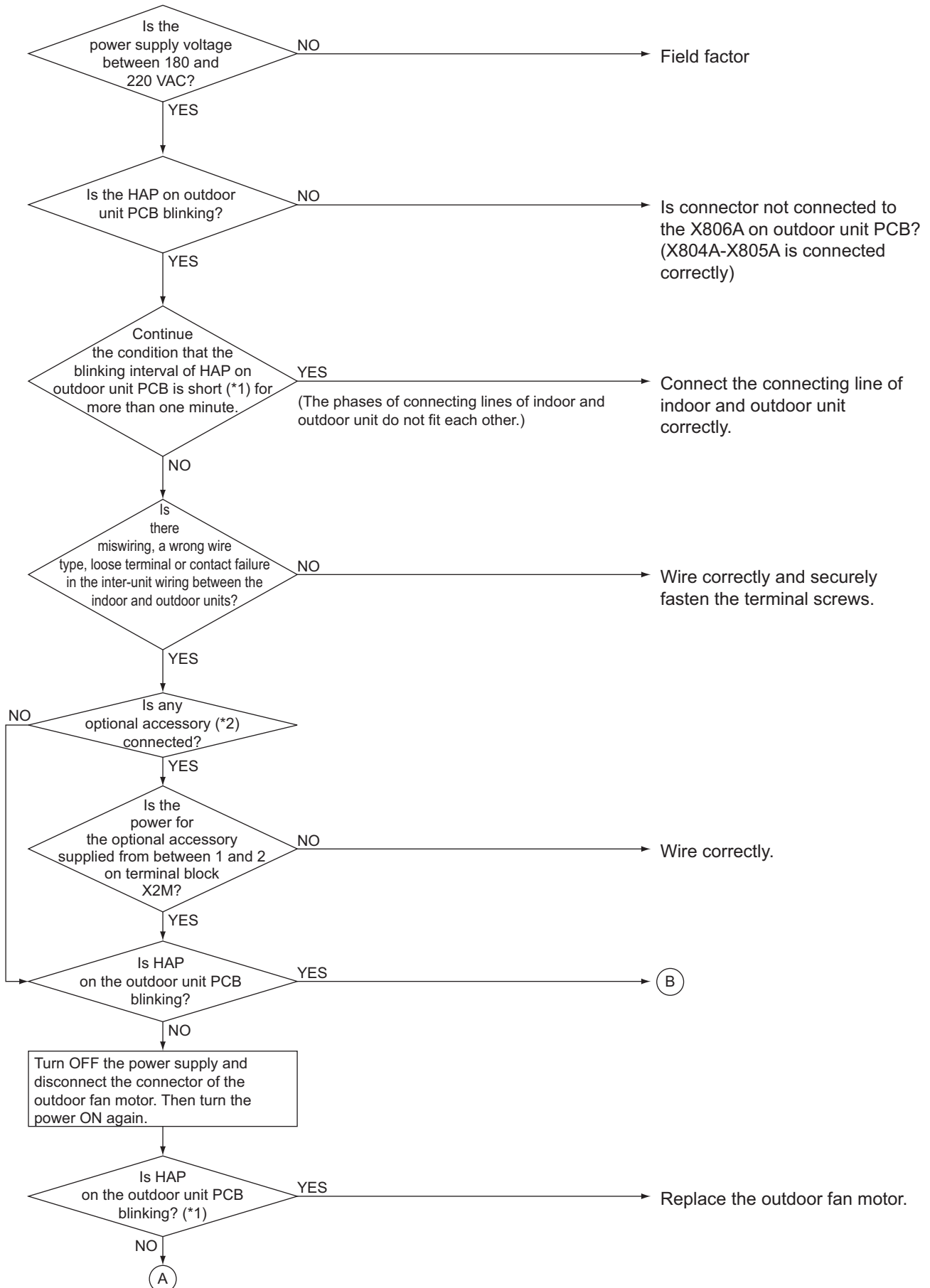

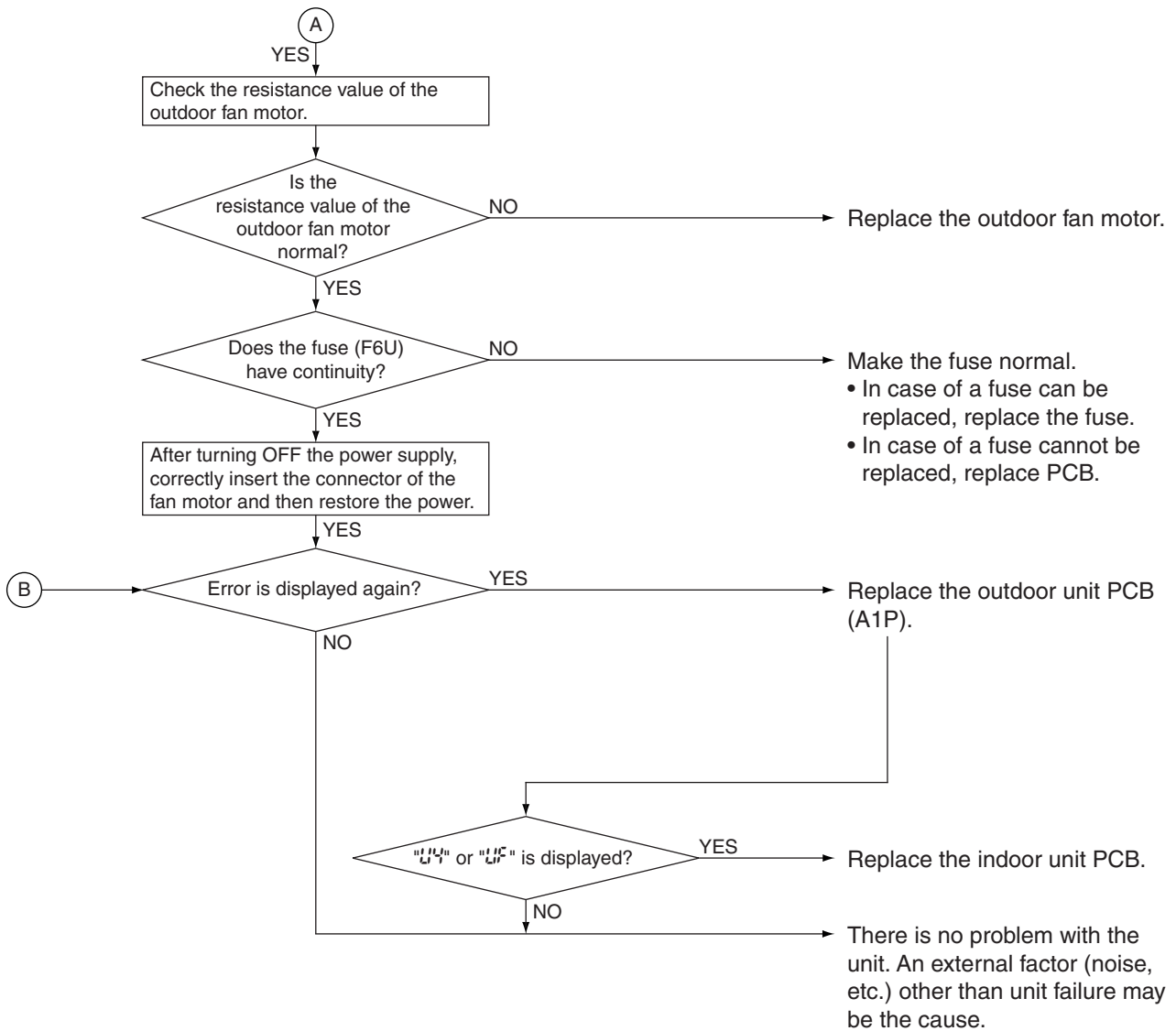

Note:

- *1 ON for 0.2 second and OFF for 0.2 second (Blink about 25 times for 10 seconds)
(Normally, ON for 0.4 second and OFF for 0.4 second (Blink about 12 times for 10 seconds))
- *2 Optional accessories refer to adaptor for wiring, auto grill and other accessories.

4.35 Transmission Error Between Remote Controller and Indoor Unit

Remote Controller Display	05
Applicable Models	All models of indoor unit
Method of Error Detection	The error is generated when the micro-computer detects that the transmission between the indoor and the outdoor unit is not normal over a certain amount of time.
Error Decision Conditions	Normal transmission does not continue for specified period.
Supposed Causes	<ul style="list-style-type: none"> ■ Connection of two main remote controllers (when using 2 remote controllers) ■ Defective remote controller ■ Defective of indoor unit PCB ■ External factor (Noise, etc.)

Troubleshooting



Caution Be sure to turn off power switch before connect or disconnect connector, or parts damage may be occurred.

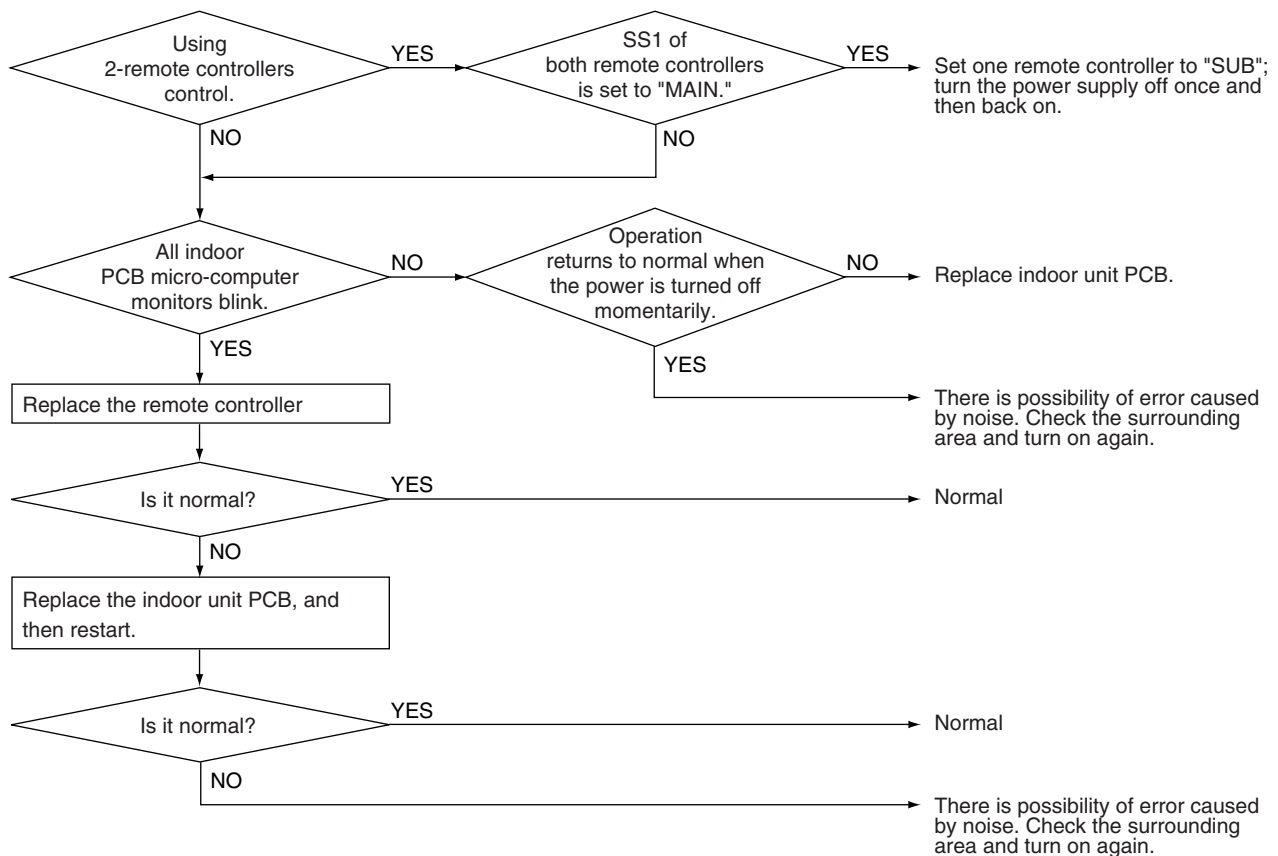

4.36 Transmission Error between MAIN Remote Controller and SUB Remote Controller

Remote Controller Display	00
Applicable Models	All models of indoor units
Method of Error Detection	In case of controlling with 2- remote controller, check the system using micro-computer if signal transmission between indoor unit and remote controller (main and sub) is normal.
Error Decision Conditions	The error is generated when, in case of controlling with 2 remote controllers, the micro-processor detects that the transmission between the indoor unit and the remote controllers (MAIN and SUB) is not normal over a certain amount of time.
Supposed Causes	<ul style="list-style-type: none"> ■ Setting failure with remote controller ■ Connection among SUB remote controllers ■ Defective remote controller PCB ■ Disconnection of remote controller wiring

Troubleshooting



Caution Be sure to turn off power switch before connect or disconnect connector, or parts damage may be occurred.

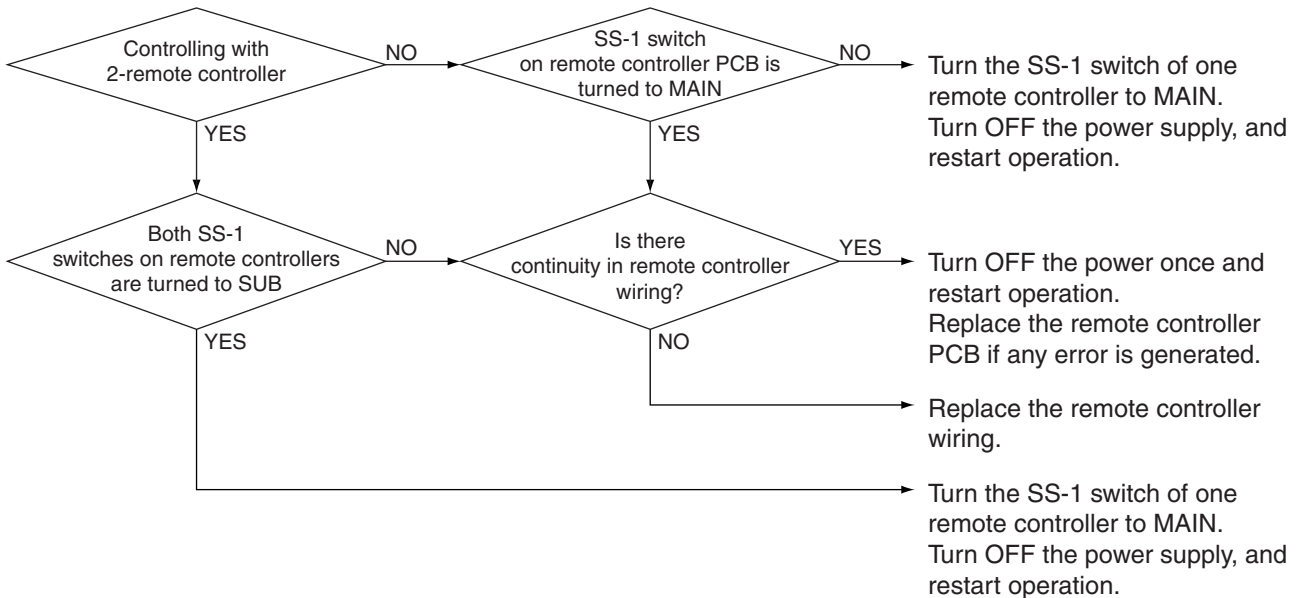

4.37 Field Setting Switch Abnormality

Remote Controller Display	
Applicable Models	All models of indoor unit
Method of Error Detection	
Error Decision Conditions	Incorrect combination indoor unit and outdoor unit Improper field setting
Supposed Causes	<ul style="list-style-type: none"> ■ Defective indoor unit PCB and wrong wiring ■ Defective power supply PCB connection ■ Indoor-outdoor, indoor-indoor unit transmission wiring ■ Defective remote controller wiring ■ Defective indoor unit PCB ■ Failure for setting the number of simultaneous multi-units ■ Wrong wiring of crossing transition wire ■ Defective multi remote controller connection ■ Faulty connection of optional equipment

Troubleshooting



Caution Be sure to turn off power switch before connect or disconnect connector, or parts damage may be occurred.

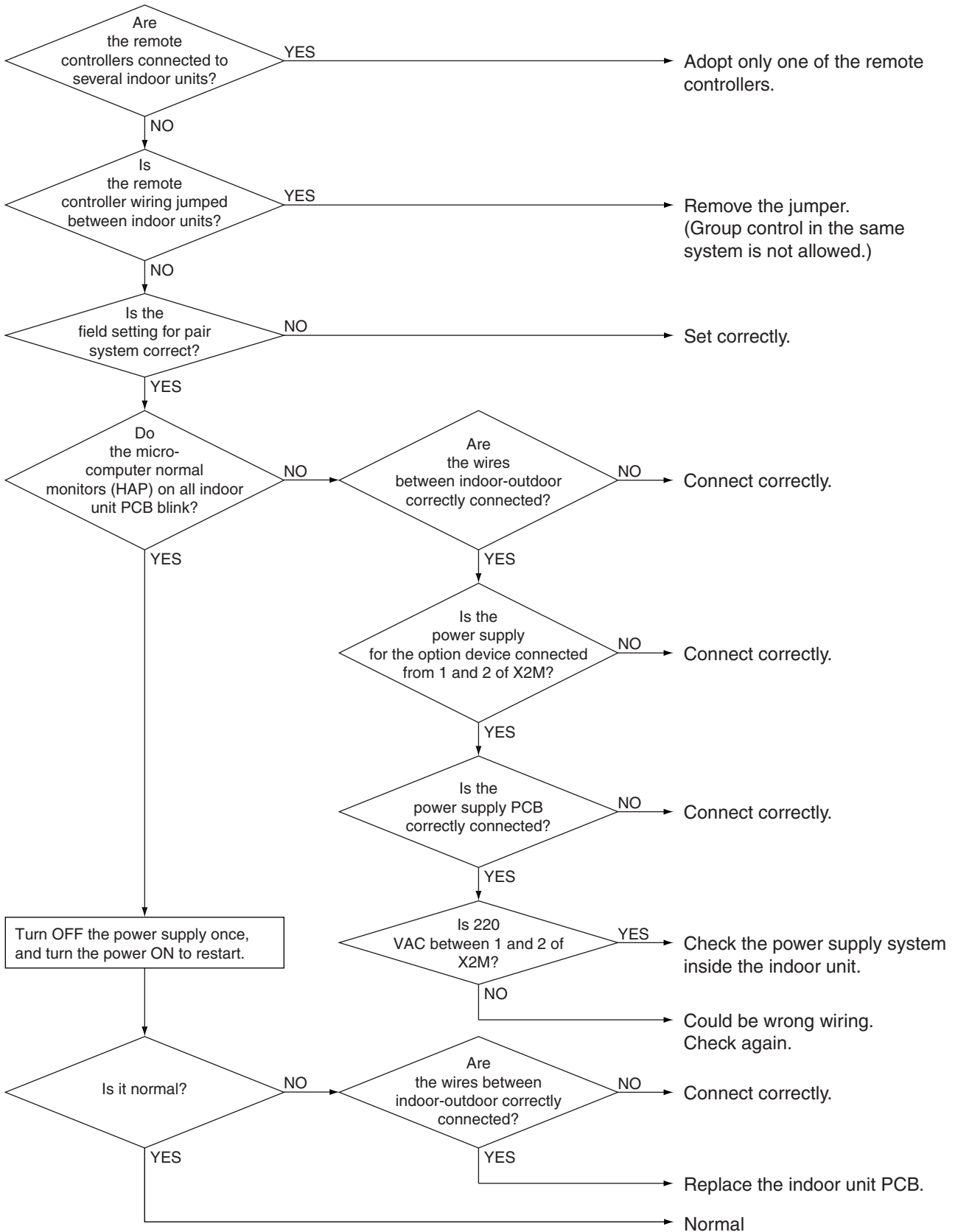

4.38 “U^U” Address Duplication of Centralized Controller

Remote Controller Display	U ^U
Applicable Models	All models of indoor unit Centralized controller
Method of Error Detection	The principal indoor unit detects the same address as that of its own on any other indoor unit.
Error Decision Conditions	The error decision is made as soon as the abnormality aforementioned is detected.
Supposed Causes	<ul style="list-style-type: none"> ■ Address duplication of centralized controller

Troubleshooting



Caution Be sure to turn off power switch before connect or disconnect connector, or parts damage may be occurred.

The centralized address is duplicated.

Make setting change so that the centralized address will not be duplicated.

4.39 Transmission Error Between Centralized Controller and Indoor Unit

Remote Controller Display	UE
Applicable Models	All models of indoor units Centralized controller Schedule timer
Method of Error Detection	Micro-computer checks if transmission between indoor unit and centralized controller is normal.
Error Decision Conditions	When transmission is not carried out normally for a certain amount of time
Supposed Causes	<ul style="list-style-type: none"> ■ Transmission error between centralized control and indoor unit ■ Defective PCB for central remote controller ■ Defect of indoor unit PCB ■ Breaking and wrong wiring of connecting wire ■ Failure of the setting of group No. and address

Troubleshooting



Caution Be sure to turn off power switch before connect or disconnect connector, or parts damage may be occurred.

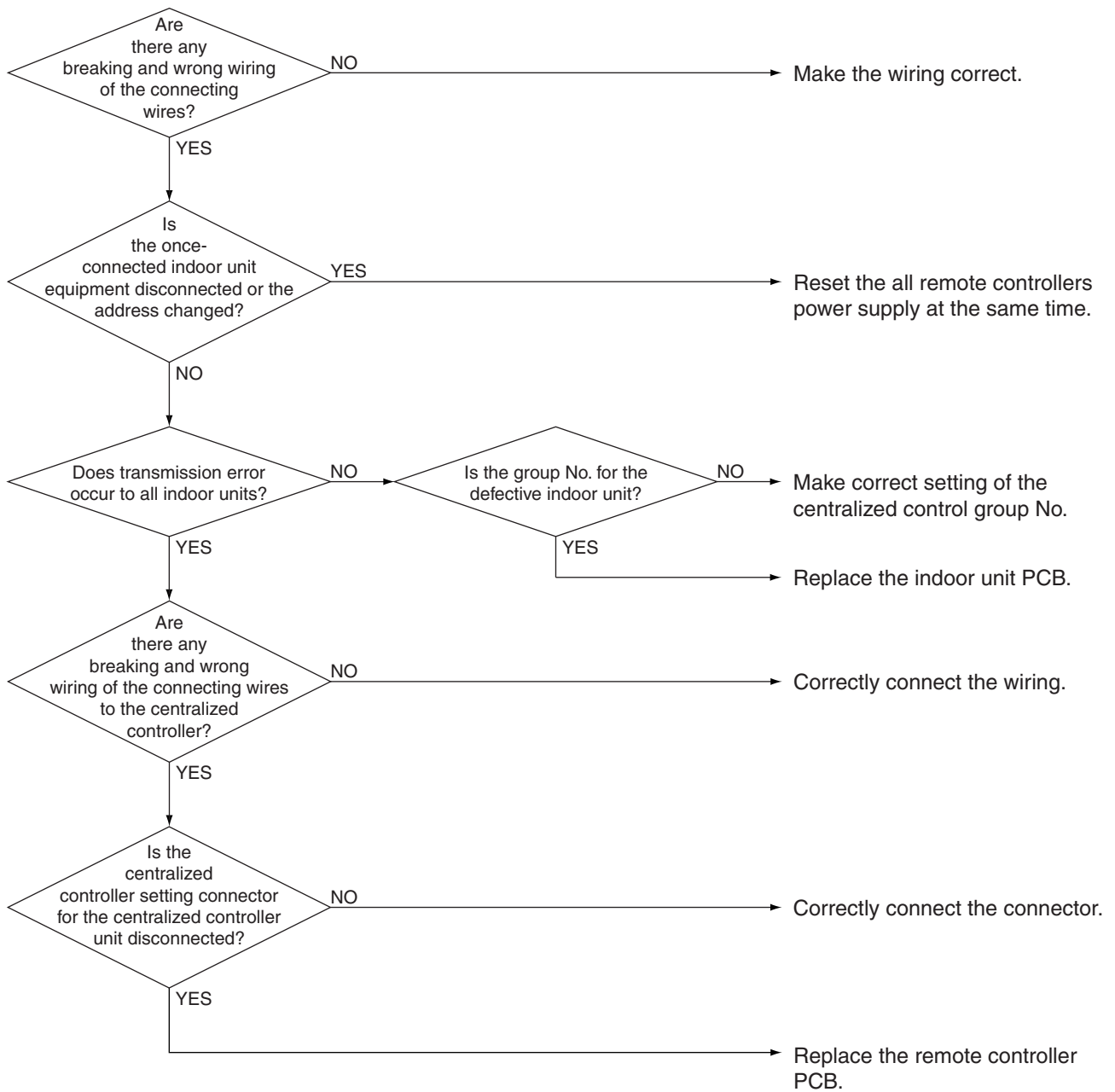

4.40 Transmission Error between Indoor and Outdoor Unit / Piping and Wiring Mismatch / Refrigerant Shortage

Remote
Controller
Display



Applicable
Models

RZQG

Method of Error
Detection

Check the transmission between the indoor and outdoor units with a micro-computer when the power turned ON.

Detect by checking the following temperature differences during compressor operation.

A: Difference in temperature detected by the indoor heat exchanger thermistor (R2T) and the indoor suction air thermistor (R1T)

B: Difference in evaporation temperature (Te) (or condensation temperature (Tc) during heating operation) detected by the indoor heat exchanger thermistor (R2T) and the compressor sensor

Error Decision
Conditions

When the inter-unit wiring between the indoor and outdoor units is incorrect

When the following conditions continue for 20 minutes during compressor operation

A: $R2T - R1T < 4^{\circ}\text{C}$, and

B: $R2T - T_e$ (or T_c during heating operation) $> 14^{\circ}\text{C}$ (24°C during heating operation)

Supposed
Causes

- Defective inter-unit wiring between the indoor and outdoor units
- Mismatching of wiring and piping
- Refrigerant shortage (shortage of gas)
- Clogged refrigerant piping system

Troubleshooting



Caution Be sure to turn off power switch before connect or disconnect connector, or parts damage may be occurred.

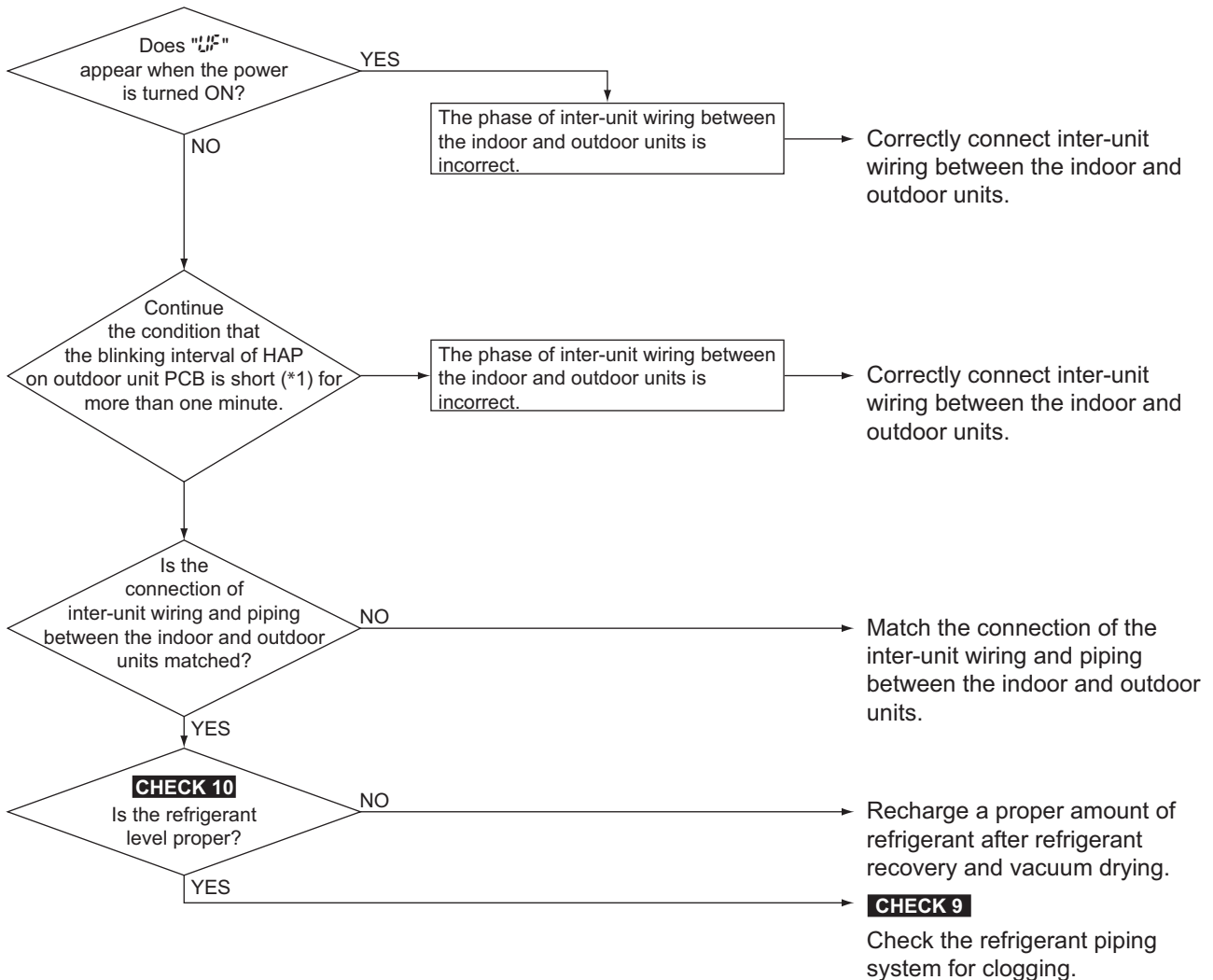

Note:

*1 ON for 0.2 second and OFF for 0.2 second (Blink about 25 times for 10 seconds)
 (Normally, ON for 0.4 second and OFF for 0.4 second (Blink about 12 times for 10 seconds))



CHECK 9 Refer to P.194.

CHECK 10 Refer to P.195.

4.41 Check

CHECK 1 Check the Thermistors

Thermistors

If the cause of the problem is related to the thermistors, then the thermistors should be checked prior to changing the PCB.

For more information about these thermistors, see:

- “Wiring Diagrams” on P.199
- “Functions of Main Components and Thermistors” on P.28

Overview of Thermistors

The table below contains an overview of the thermistors:

Indoor

FCQG, FHQG	Thermistor
R1T	Suction air thermistor
R2T	Heat exchanger thermistor
R3T	Intermediate heat exchanger thermistor

Outdoor

RZQG	Thermistor
R1T	Outdoor air thermistor
R2T	Discharge pipe thermistor
R3T	Suction pipe thermistor
R4T	Heat exchanger distributor pipe thermistor
R5T	Intermediate heat exchanger thermistor
R6T	Liquid pipe thermistor
R10T	Radiation fin thermistor

Checking

To check the thermistors, proceed as follows:

Step	Action
1	Disconnect the thermistor from the PCB
2	Read the temperature and the resistor value.
3	Check if the measured values correspond with the values in the table on the next pages.

Thermistor Resistance / Temperature Characteristics

Indoor unit	Thermistor	
	R1T	Suction air thermistor
	R2T	Heat exchanger thermistor
	R3T	Intermediate heat exchanger thermistor

Outdoor unit	RZQG	Thermistor	
	R1T	Outdoor air thermistor	
	R3T	Suction pipe thermistor	
	R4T	Heat exchanger distributor pipe	
	R5T	Intermediate heat exchanger thermistor	
	R6T	Liquid pipe thermistor	
	R10T	Radiation fin thermistor	

T°C	kΩ
-10	-
-8	-
-6	88.0
-4	79.1
-2	71.1
0	64.1
2	57.8
4	52.3
6	47.3
8	42.9
10	38.9
12	35.3
14	32.1
16	29.2
18	26.6
20	24.3
22	22.2
24	20.3
26	18.5
28	17.0
30	15.6
32	14.2
34	13.1
36	12.0
38	11.1
40	10.3
42	9.5
44	8.8
46	8.2
48	7.6
50	7.0
52	6.7
54	6.0
56	5.5
58	5.2
60	4.79
62	4.46
64	4.15
66	3.87
68	3.61
70	3.37
72	3.15
74	2.94
76	2.75
78	2.51
80	2.41
82	2.26
84	2.12
86	1.99
88	1.87
90	1.76
92	1.65
94	1.55
96	1.46
98	1.38

T°C	kΩ	T°C	kΩ
-20	197.81	-19.5	192.08
-19	186.53	-18.5	181.16
-18	175.97	-17.5	170.94
-17	166.07	-16.5	161.36
-16	156.80	-15.5	152.38
-15	148.10	-14.5	143.96
-14	139.94	-13.5	136.05
-13	132.28	-12.5	128.63
-12	125.09	-11.5	121.66
-11	118.34	-10.5	115.12
-10	111.99	-9.5	108.96
-9	106.03	-8.5	103.18
-8	100.41	-7.5	97.73
-7	95.14	-6.5	92.61
-6	90.17	-5.5	87.79
-5	85.49	-4.5	83.25
-4	81.08	-3.5	78.97
-3	76.93	-2.5	74.94
-2	73.01	-1.5	71.14
-1	69.32	-0.5	67.56
0	65.84	0.5	64.17
1	62.54	1.5	60.96
2	59.43	2.5	57.94
3	56.49	3.5	55.08
4	53.71	4.5	52.38
5	51.09	5.5	49.83
6	48.61	6.5	47.42
7	46.26	7.5	45.14
8	44.05	8.5	42.98
9	41.95	9.5	40.94
10	39.96	10.5	39.01
11	38.08	11.5	37.18
12	36.30	12.5	35.45
13	34.62	13.5	33.81
14	33.02	14.5	32.25
15	31.50	15.5	30.77
16	30.06	16.5	29.37
17	28.70	17.5	28.05
18	27.41	18.5	26.78
19	26.18	19.5	25.59
20	25.01	20.5	24.45
21	23.91	21.5	23.37
22	22.85	22.5	22.35
23	21.85	23.5	21.37
24	20.90	24.5	20.45
25	20.00	25.5	19.56
26	19.14	26.5	18.73
27	18.32	27.5	17.93
28	17.54	28.5	17.17
29	16.80	29.5	16.45
30	16.10	30.5	15.76

T°C	kΩ	T°C	kΩ
30	16.10	30.5	15.76
31	15.43	31.5	15.10
32	14.79	32.5	14.48
33	14.18	33.5	13.88
34	13.59	34.5	13.31
35	13.04	35.5	12.77
36	12.51	36.5	12.25
37	12.01	37.5	11.76
38	11.52	38.5	11.29
39	11.06	39.5	10.84
40	10.63	40.5	10.41
41	10.21	41.5	10.00
42	9.81	42.5	9.61
43	9.42	43.5	9.24
44	9.06	44.5	8.88
45	8.71	45.5	8.54
46	8.37	46.5	8.21
47	8.05	47.5	7.90
48	7.75	48.5	7.60
49	7.46	49.5	7.31
50	7.18	50.5	7.04
51	6.91	51.5	6.78
52	6.65	52.5	6.53
53	6.41	53.5	6.53
54	6.65	54.5	6.53
55	6.41	55.5	6.53
56	6.18	56.5	6.06
57	5.95	57.5	5.84
58	5.74	58.5	5.43
59	5.14	59.5	5.05
60	4.96	60.5	4.87
61	4.79	61.5	4.70
62	4.62	62.5	4.54
63	4.46	63.5	4.38
64	4.30	64.5	4.23
65	4.16	65.5	4.08
66	4.01	66.5	3.94
67	3.88	67.5	3.81
68	3.75	68.5	3.68
69	3.62	69.5	3.56
70	3.50	70.5	3.44
71	3.38	71.5	3.32
72	3.27	72.5	3.21
73	3.16	73.5	3.11
74	3.06	74.5	3.01
75	2.96	75.5	2.91
76	2.86	76.5	2.82
77	2.77	77.5	2.72
78	2.68	78.5	2.64
79	2.60	79.5	2.55
80	2.51	80.5	2.47

Outdoor unit	RZQG	Thermistor
	R2T	Discharge pipe thermistor

T°C	kΩ	T°C	kΩ	T°C	kΩ	T°C	kΩ	T°C	kΩ	T°C	kΩ
0	640.44	0.5	624.65	50	72.32	50.5	70.96	100	13.35	100.5	13.15
1	609.31	1.5	594.43	51	69.64	51.5	68.34	101	12.95	101.5	12.76
2	579.96	2.5	565.78	52	67.06	52.5	65.82	102	12.57	102.5	12.38
3	552.00	3.5	538.63	53	64.60	53.5	63.41	103	12.20	103.5	12.01
4	525.63	4.5	512.97	54	62.24	54.5	61.09	104	11.84	104.5	11.66
5	500.66	5.5	488.67	55	59.97	55.5	58.87	105	11.49	105.5	11.32
6	477.01	6.5	465.65	56	57.80	56.5	56.75	106	11.15	106.5	10.99
7	454.60	7.5	443.84	57	55.72	57.5	54.70	107	10.83	107.5	10.67
8	433.37	8.5	423.17	58	53.72	58.5	52.84	108	10.52	108.5	10.36
9	413.24	9.5	403.57	59	51.98	59.5	50.96	109	10.21	109.5	10.06
10	394.16	10.5	384.98	60	49.96	60.5	49.06	110	9.92	110.5	9.78
11	376.05	11.5	367.35	61	48.19	61.5	47.33	111	9.64	111.5	9.50
12	358.88	12.5	350.62	62	46.49	62.5	45.67	112	9.36	112.5	9.23
13	342.58	13.5	334.74	63	44.86	63.5	44.07	113	9.10	113.5	8.97
14	327.10	14.5	319.66	64	43.30	64.5	42.54	114	8.84	114.5	8.71
15	312.41	15.5	305.33	65	41.79	65.5	41.06	115	8.59	115.5	8.47
16	298.45	16.5	291.73	66	40.35	66.5	39.65	116	8.35	116.5	8.23
17	285.18	17.5	278.80	67	38.96	67.5	38.29	117	8.12	117.5	8.01
18	272.58	18.5	266.51	68	37.63	68.5	36.98	118	7.89	118.5	7.78
19	260.60	19.5	254.72	69	36.34	69.5	35.72	119	7.68	119.5	7.57
20	249.00	20.5	243.61	70	35.11	70.5	34.51	120	7.47	120.5	7.36
21	238.36	21.5	233.14	71	33.92	71.5	33.35	121	7.26	121.5	7.16
22	228.05	22.5	223.08	72	32.78	72.5	32.23	122	7.06	122.5	6.97
23	218.24	23.5	213.51	73	31.69	73.5	31.15	123	6.87	123.5	6.78
24	208.90	24.5	204.39	74	30.63	74.5	30.12	124	6.69	124.5	6.59
25	200.00	25.5	195.71	75	29.61	75.5	29.12	125	6.51	125.5	6.42
26	191.53	26.5	187.44	76	28.64	76.5	28.16	126	6.33	126.5	6.25
27	183.46	27.5	179.57	77	27.69	77.5	27.24	127	6.16	127.5	6.08
28	175.77	28.5	172.06	78	26.79	78.5	26.35	128	6.00	128.5	5.92
29	168.44	29.5	164.90	79	25.91	79.5	25.49	129	5.84	129.5	5.76
30	161.45	30.5	158.08	80	25.07	80.5	24.66	130	5.69	130.5	5.61
31	154.79	31.5	151.57	81	24.26	81.5	23.87	131	5.54	131.5	5.46
32	148.43	32.5	145.37	82	23.48	82.5	23.10	132	5.39	132.5	5.32
33	142.37	33.5	139.44	83	22.73	83.5	22.36	133	5.25	133.5	5.18
34	136.59	34.5	133.79	84	22.01	84.5	21.65	134	5.12	134.5	5.05
35	131.06	35.5	128.39	85	21.31	85.5	20.97	135	4.98	135.5	4.92
36	125.79	36.5	123.24	86	20.63	86.5	20.31	136	4.86	136.5	4.79
37	120.76	37.5	118.32	87	19.98	87.5	19.67	137	4.73	137.5	4.67
38	115.95	38.5	113.62	88	19.36	88.5	19.05	138	4.61	138.5	4.55
39	111.35	39.5	109.13	89	18.75	89.5	18.46	139	4.49	139.5	4.44
40	106.96	40.5	104.84	90	18.17	90.5	17.89	140	4.38	140.5	4.32
41	102.76	41.5	100.73	91	17.61	91.5	17.34	141	4.27	141.5	4.22
42	98.75	42.5	96.81	92	17.07	92.5	16.80	142	4.16	142.5	4.11
43	94.92	43.5	93.06	93	16.54	93.5	16.29	143	4.06	143.5	4.01
44	91.25	44.5	89.47	94	16.04	94.5	15.79	144	3.96	144.5	3.91
45	87.74	45.5	86.04	95	15.55	95.5	15.31	145	3.86	145.5	3.81
46	84.38	46.5	82.75	96	15.08	96.5	14.85	146	3.76	146.5	3.72
47	81.16	47.5	79.61	97	14.62	97.5	14.40	147	3.67	147.5	3.62
48	78.09	48.5	76.60	98	14.18	98.5	13.97	148	3.58	148.5	3.54
49	75.14	49.5	73.71	99	13.76	99.5	13.55	149	3.49	149.5	3.45
50	72.32	50.5	70.96	100	13.35	100.5	13.15	150	3.41	150.5	3.37

CHECK 2 Evaluation of Abnormal High Pressure

Abnormally high pressure level is mostly caused by the condenser side. The following contents are provided by service engineer based on their field checks. Further, the number is listed in the order of degree of influence.

In Cooling Operation

Check items (Possible causes)	Judgement
Does the outdoor unit fan run normally?	Visual inspection
Is the outdoor unit heat exchanger clogged?	Visual inspection
Is there clogging before or after the EV (capillary)?	Check if there is a temperature difference before and after EV (capillary). Check if the main valve unit of EV operates (by noise, vibration).
Is the check valve clogged?	Check if there is a temperature difference before and after check valve. → If YES, the check valve is caught.
Is the HPS normal? *	Check continuity by using a tester.
Is the outdoor unit installed under such conditions that short circuit easily occurs?	Visual inspection
Is the piping length 5 meters or less?	Visual inspection
Does air enter the refrigerant system?	Conduct refrigerant collection and vacuum drying, and then add proper amount refrigerant.
Is the refrigerant overcharged?	Conduct refrigerant collection and vacuum drying, and then add proper amount refrigerant.

In Heating Operation

Check items (Possible causes)	Judgement
Does the indoor unit fan run normally?	Visual inspection
Is the indoor unit heat exchanger clogged?	Visual inspection
Is the indoor unit installed under such conditions that short circuit easily occurs?	Visual inspection
Is there clogging before or after the EV (capillary)?	Check if there is a temperature difference before and after EV (capillary). Check if the main valve unit of EV operates (by noise, vibration).
Is the check valve clogged?	Check if there is a temperature difference before and after check valve. → If YES, the check valve is caught.
Is the HPS normal?	Check continuity using a tester.
Is the piping length 5 meters or less?	Visual inspection
Does air enter the refrigerant system?	Conduct refrigerant collection and vacuum drying, and then add proper amount refrigerant.
Is the refrigerant overcharged?	Conduct refrigerant collection and vacuum drying, and then add proper amount refrigerant.

CHECK 3 Evaluation of Abnormal Low Pressure

Abnormally low pressure level is mostly caused by the evaporator side. The following contents are provided based on field checking of service engineer. Further, the number is listed in the order of degree of influence.

In Cooling Operation

Check items (Possible causes)	Judgement
Does the outdoor unit fan run normally?	Visual inspection
Is the indoor unit filter clogged?	Visual inspection
Is there clogging before or after the EV (capillary)?	Check if there is a temperature difference before and after EV (capillary). Check if the main valve unit of EV operates (by noise, vibration).
Is the check valve clogged?	Check if there is a temperature difference before and after check valve. → If YES, the check valve is caught.
Is the indoor unit installed under such conditions that short circuit easily occurs?	Visual inspection
Is the refrigerant gas short?	Conduct refrigerant collection and vacuum drying, and then add proper amount refrigerant.

In Heating Operation

Check items (Possible causes)	Judgement
Does the outdoor unit fan run normally?	Visual inspection
Is the outdoor unit heat exchanger clogged?	Visual inspection
Is the outdoor unit installed under such conditions that short circuit easily occurs?	Visual inspection
Is there clogging before or after the EV (capillary)?	Check if there is a temperature difference before and after EV (capillary). Check if the main valve unit of EV operates (by noise, vibration).
Is the check valve clogged?	Check if there is a temperature difference before and after check valve. → If YES, the check valve is caught.
Is the refrigerant gas short?	Conduct refrigerant collection and vacuum drying, and then add proper amount refrigerant.

CHECK 4 Check for Power Transistor

Judgement according to the continuity check by using an analog tester:

- (1) Do not touch the charged area (high voltage) for 10 minutes after turning the power supply off.
- (2) If you must touch such an area, make sure that the power supply voltage of power transistor is 50 V or less.
- (3) Disconnect the connector of the outdoor unit fan motor.

When the outdoor unit fan is rotating against a strong wind, the condenser is charged and electric shock may result. Therefore, disconnect the connector from the outdoor unit fan motor after confirming that the outdoor unit fan has stopped.

- (4) Before measuring the continuity, disconnect the connection between compressor and power transistor.
- (5) Measure the continuity in the following procedure.

[Judgement] Normal if the continuity check results in the following.

Power transistor (on inverter PCB)

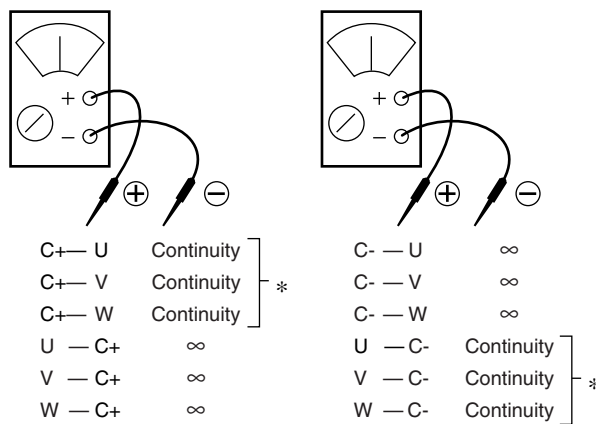

Note:

- * If there is continuity, the resistance should be the same as each phase.
- * If a digital tester is used for the measurement of continuity, ∞ and continuity may be reversed.

CHECK 5 Fan Motor Signal Line

- (1) Turn the power supply off.
- (2) With the fan motor connector disconnected, measure the resistance between each pin, then make sure that the resistance is more than the value mentioned in the following table.

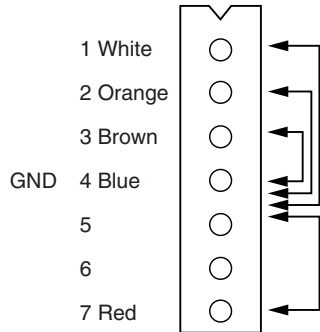

Measurement point	Judgement
1 - 4	∞
2 - 4	AVG 20M Ω
3 - 4	AVG 60k Ω
4 - 7	∞
2 - 7	∞

NIDEC KFD325

CHECK 6 Electronic expansion valve connector and coil resistance criteria

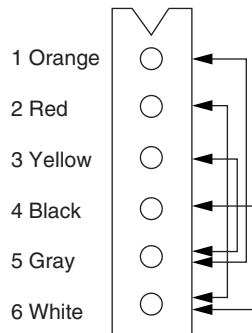

Measurement point	Judgement
1 - 5	40-50 Ω
3 - 5	
2 - 6	
4 - 6	

CHECK 7 Check for Factors Causing Wet Operation

Referring to the Fault Tree Analysis (FTA) shown below, identify the faulty points.

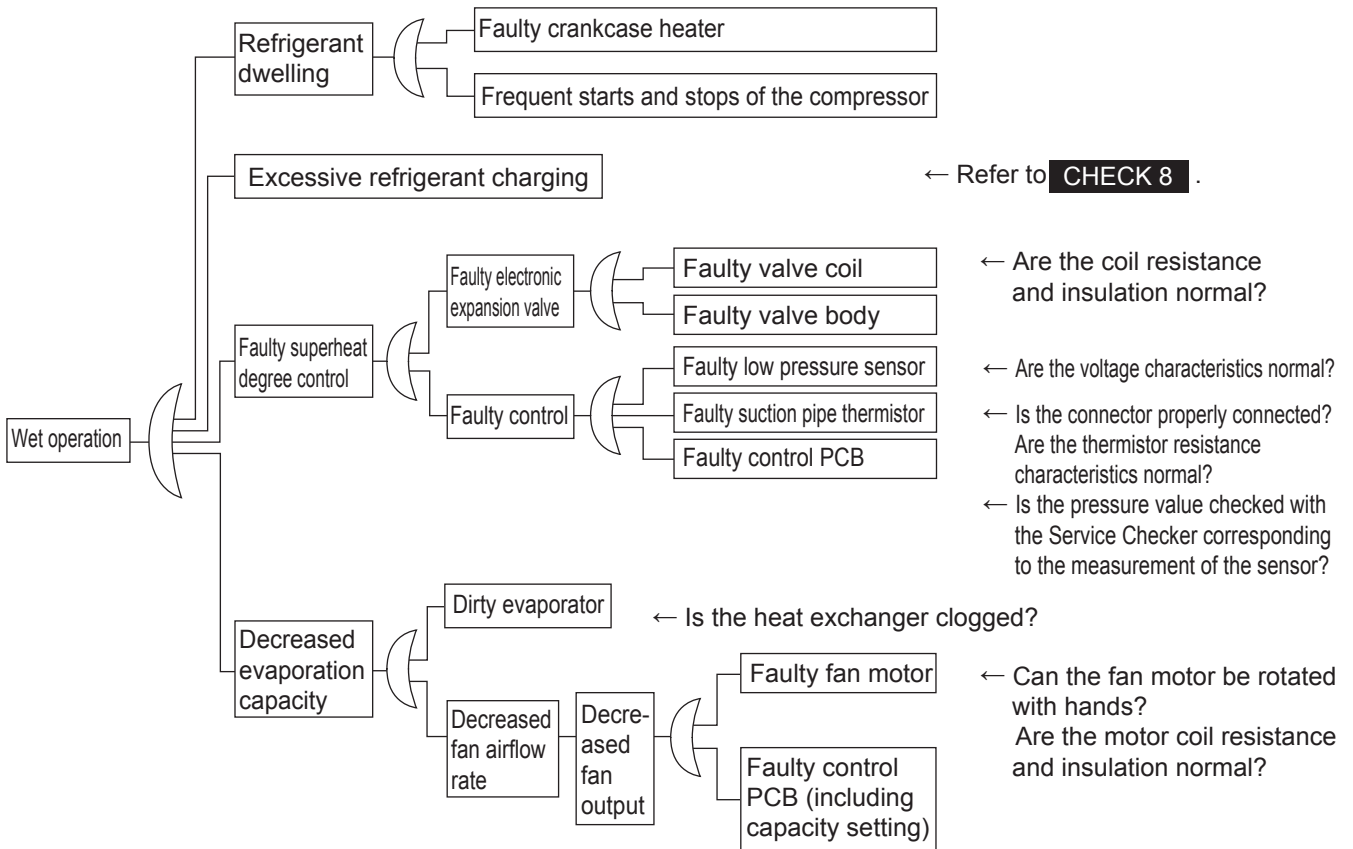

Note:

*: Reference values for superheat degree to be used in the judgement of wet operation
 1 Suction pipe superheat degree: 4°C or more
 2 Discharge pipe superheat degree: 5°C or less
 (The values above must be used only for reference purposes. Even it is operated within the range above, operation may be normal in other conditions.)

CHECK 8 Check for Excessive Refrigerant Charging

As criteria for judging whether refrigerant is excessively charged or not, refer to the following operating conditions.

<Diagnosis of excessive refrigerant charging>

In cooling operation

- (1) Because high pressure rises due to excessive charging, overload control is carried out and capacity tends to run short.
- (2) Considering pressure load, compressor discharge pipe temperature is low.
- (3) Subcooled degree of condensate liquid becomes large. Therefore, temperature of blown air passing through subcooled part decreases in heating operation.

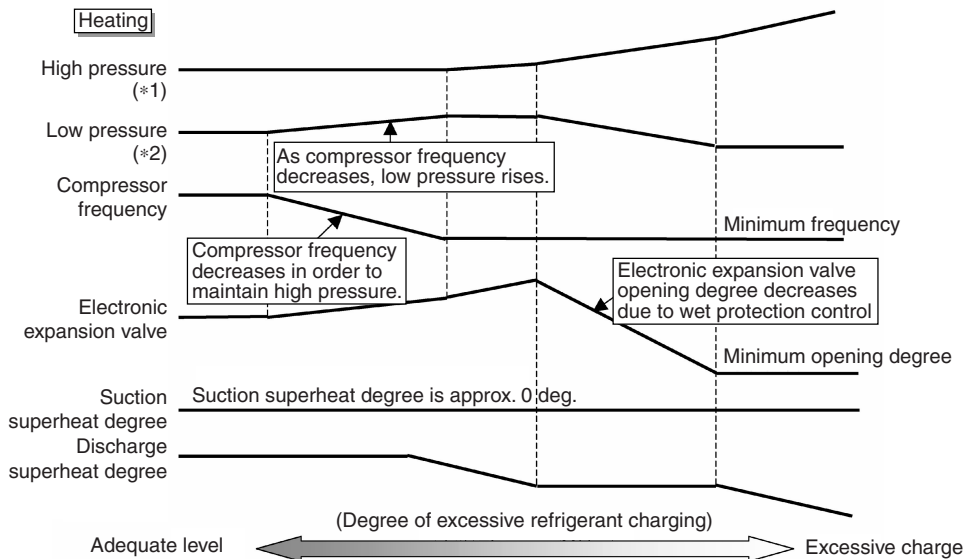
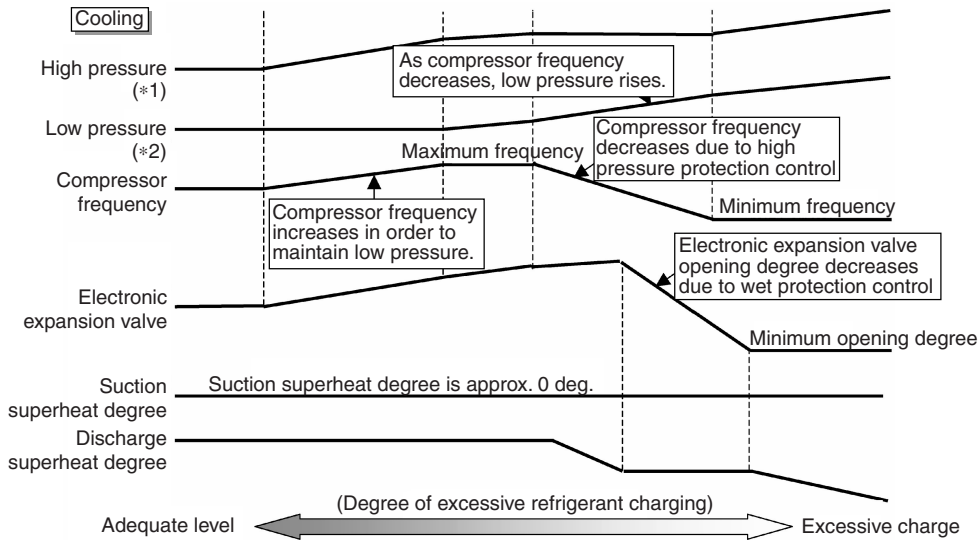

Cooling

*1 High Pressure	Intermediate heat exchanger thermistor (*3)
*2 Low Pressure	Pressure sensor

Heating

*1 High Pressure	Pressure sensor
*2 Low Pressure	Intermediate heat exchanger thermistor (*3)

*3 This measured temperature is used to calculate the equivalent saturation pressure of the refrigerant.
(Refer to P.200.)

CHECK 9 Clogged Points

Temperature differences must occur before or after the clogged points!

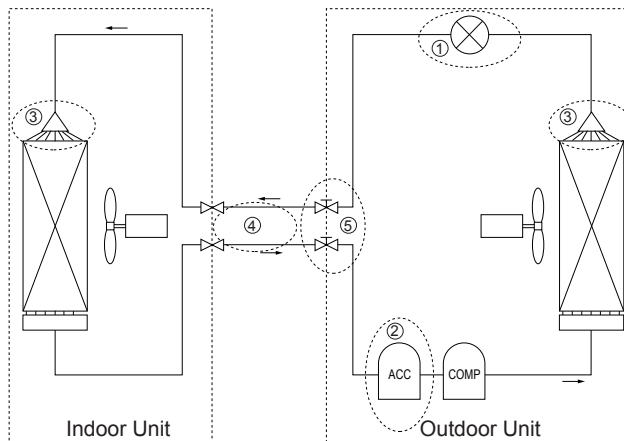

Check points		Check factor	Causes	Remedies
1	Around expansion mechanism	Temperature difference	<ul style="list-style-type: none"> ● Dust ● Choked moisture ● Reduced effective pipe diameter due to adherent contamination, etc. 	Replace the electronic expansion valve.
2	Accumulator	Frosting	<ul style="list-style-type: none"> ● Choked moisture 	Blow a nitrogen gas, and then replace the refrigerant.
3	Distributor	Temperature difference	<ul style="list-style-type: none"> ● Dust ● Choked moisture ● Reduced effective pipe diameter due to adherent contamination, etc. 	Replace the heat exchanger or distributor.
4	Field piping	Temperature difference	<ul style="list-style-type: none"> ● Collapsed pipe 	Replace the pipe.
5	Stop valve	Temperature difference	<ul style="list-style-type: none"> ● The stop valve is not fully open. 	Open the stop valve fully.

CHECK 10 Check for Inadequate Refrigerant

As criteria for judging whether refrigerant is inadequate or not, refer to the following operating conditions.

<Diagnosis of inadequate refrigerant>

In cooling operation

- (1) As suction superheat degree increases due to refrigerant shortage, the electronic expansion valve tends to open (opens fully) in order to avoid overheat operation.
- (2) In response to decreased evaporator capacity caused by refrigerant shortage, capacity is controlled in the inverter in order to maintain low pressure, which results in a decrease in frequency.
- (3) Because of (1) and (2) above, the compressor frequency decreases despite a large difference (large load) between temperature set by the remote controller and indoor suction temperature, resulting that cooling capacity becomes unavailable.
- (4) If refrigerant shortage worsens, the electronic expansion valve remains fully open and suction superheat degree further increases. In addition, because the compressor frequency drops to the level of the lowest frequency (52 Hz) and the refrigerant flow rate decrease, low pressure cannot be maintained.

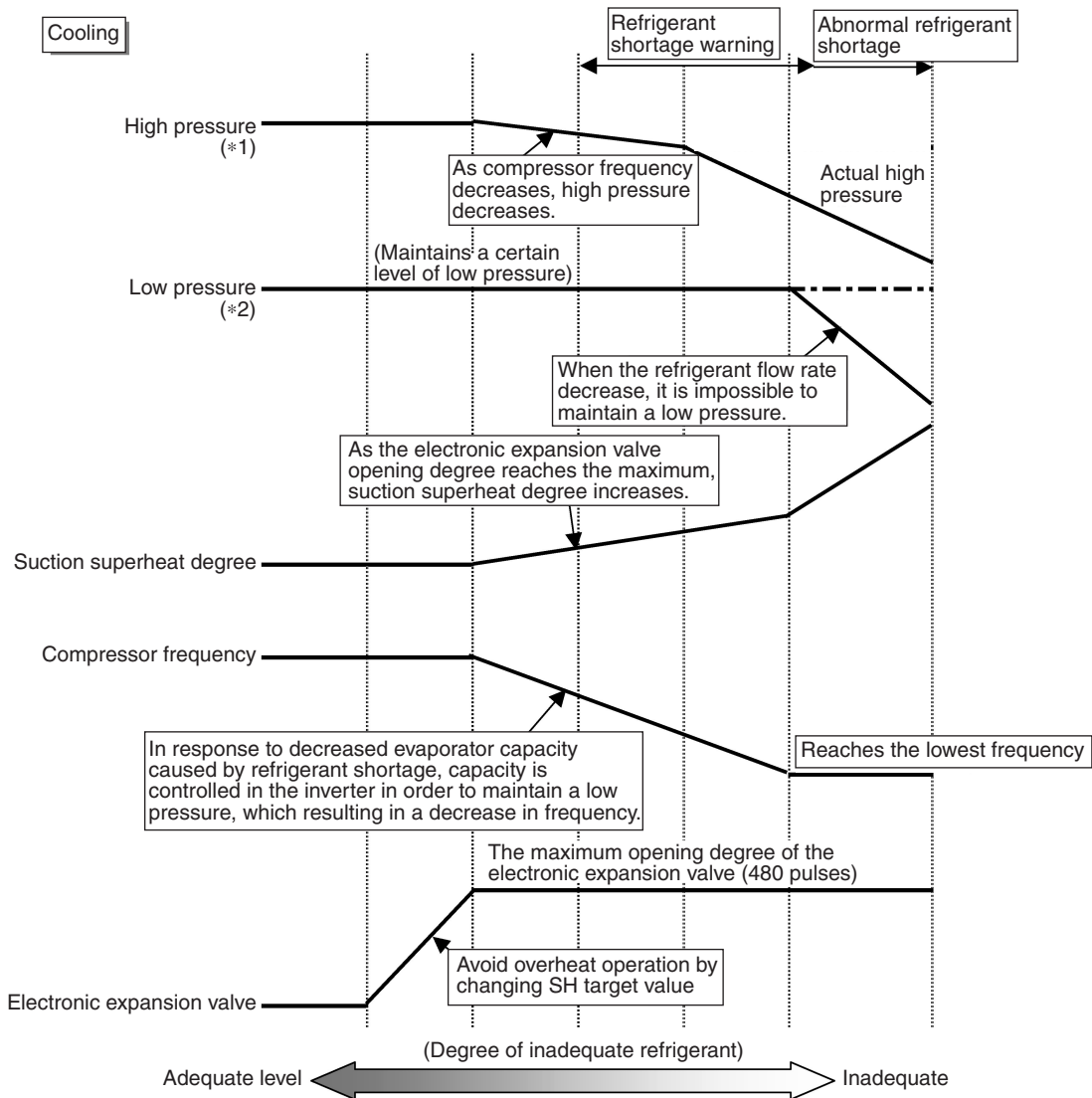

Cooling

*1 High Pressure	Intermediate heat exchanger thermistor (*3)
*2 Low Pressure	Pressure sensor

*3 This measured temperature is used to calculate the equivalent saturation pressure of the refrigerant. (Refer to P.200.)

<Diagnosis of inadequate refrigerant>

In heating operation

- (1) As suction superheat degree increases due to refrigerant shortage, the electronic expansion valve tends to open (opens fully) to avoid overheat operation.
- (2) As suction superheat degree increases due to refrigerant shortage, compressor frequency decreases because suction superheat degree is controlled in order to prevent oil to the outdoor heat exchanger from being retained.
- (3) Because of (1) and (2) above, evaporator capacity and compressor frequency decrease despite a large difference (large load) between temperature set by the remote controller and indoor suction temperature, resulting that high pressure cannot be maintained and heating capacity becomes unavailable. Also a decrease in evaporator capacity frequently puts the system in defrost operation.
- (4) If refrigerant shortage worsens, high pressure becomes smaller than saturated pressure equivalent to indoor heat exchanger temperature (or indoor suction temperature).

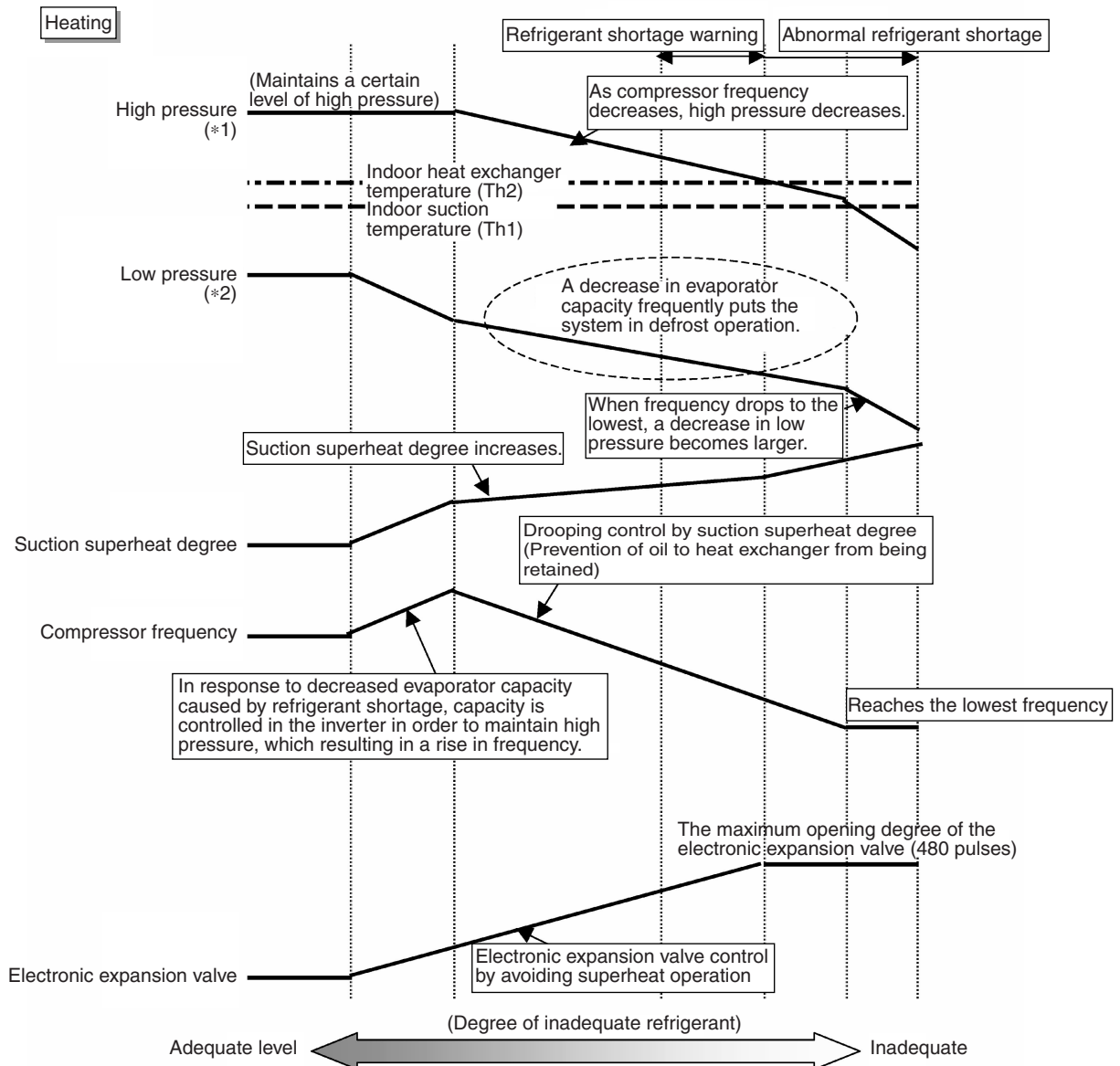

Heating

*1 High Pressure	Pressure sensor
*2 Low Pressure	Intermediate heat exchanger thermistor (*3)

*3 This measured temperature is used to calculate the equivalent saturation pressure of the refrigerant. (Refer to P.200.)

Part 6

Appendix

1. Piping Diagrams.....	198
1.1 RZQG-L9V1	198
2. Wiring Diagrams.....	199
2.1 Outdoor Unit.....	199
3. Thermodynamic characteristic of R-410A.....	200
4. Removing the switchbox	201

1. Piping Diagrams

1.1 RZQG-L9V1

Pair application

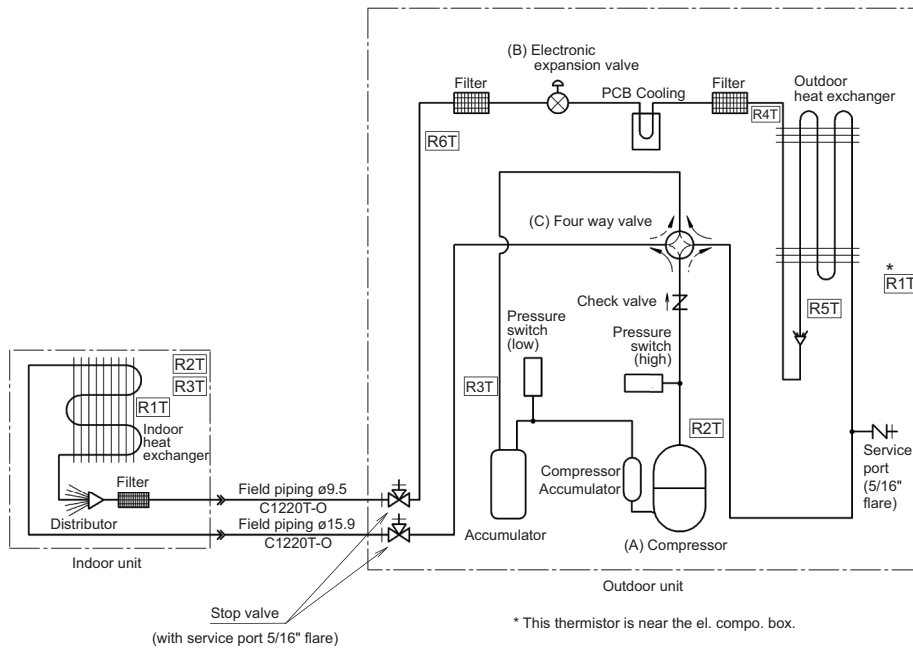

Notes:

1. The pipes between the branch and the indoor units should have the same size as the indoor connections.
2. The check valve is only present in following models: RZQG71L, RZQSG100L and RZQSG125L.

2. Wiring Diagrams

2.1 Outdoor Unit

2.1.1 RZQG71L

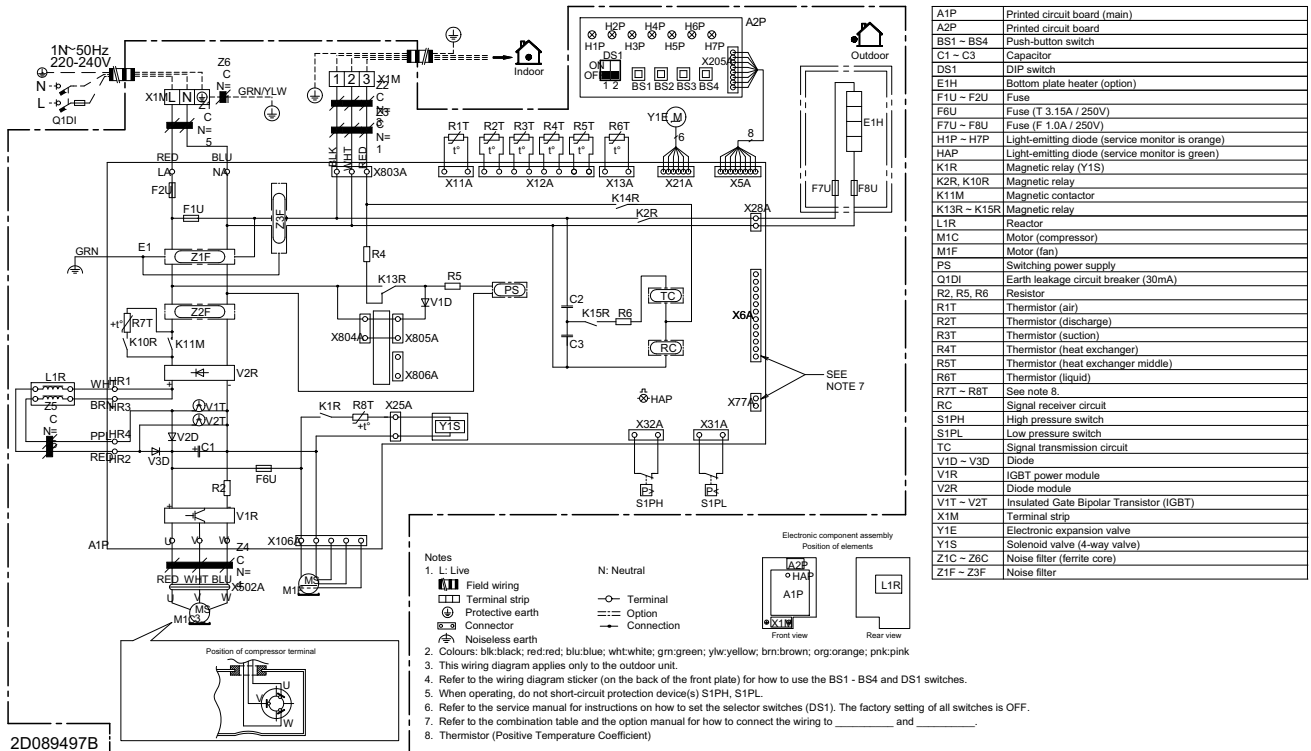

2.1.2 RZQG100-140L

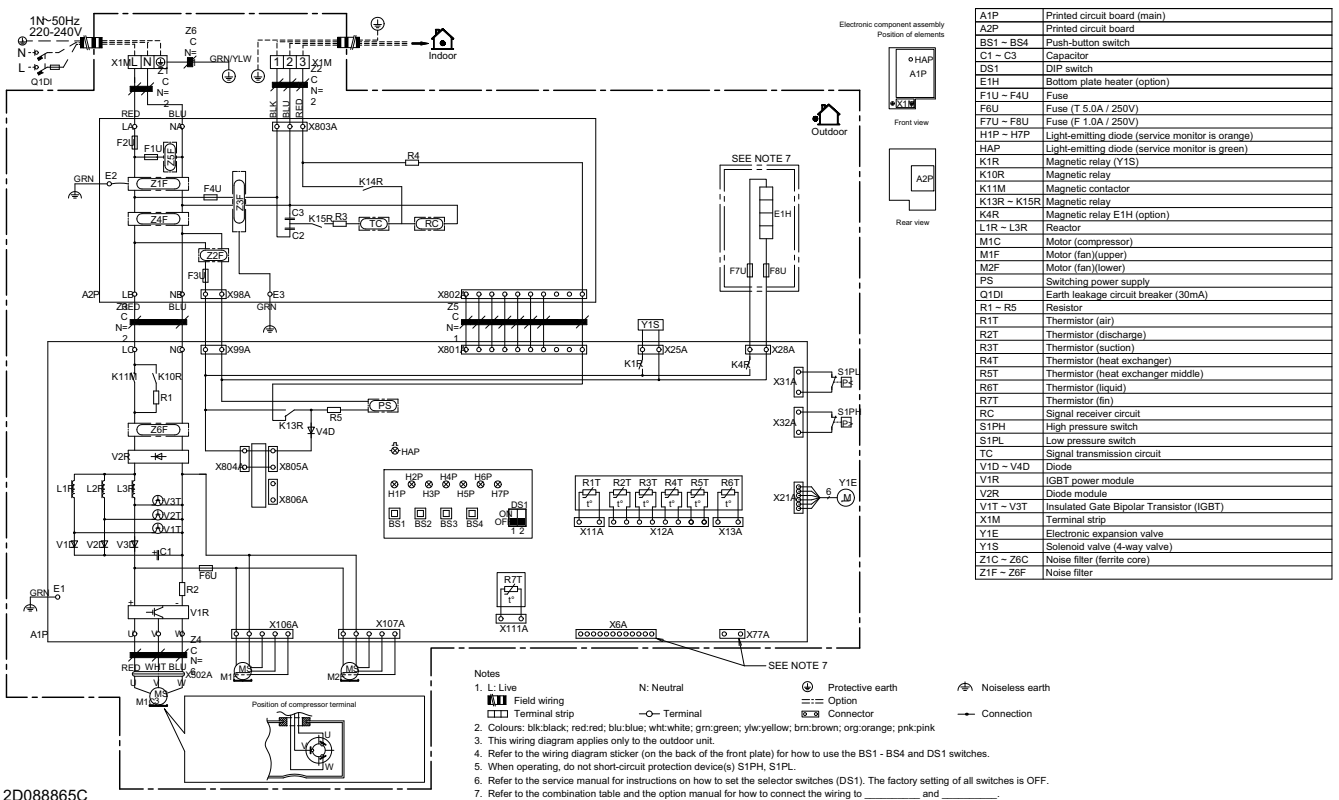

2D08865C

3. Thermodynamic characteristic of R-410A

DAIREP ver2.0

Temperature (°C)	Steam pressure (kPa)		Density (kg/m ³)		Specific heat at constant pressure (kJ/kgK)		Specific enthalpy (kJ/kg)		Specific entropy (kJ/KgK)	
	Liquid	Vapor	Liquid	Vapor	Liquid	Vapor	Liquid	Vapor	Liquid	Vapor
-70	36.13	36.11	1410.7	1.582	1.372	0.695	100.8	390.6	0.649	2.074
-68	40.83	40.80	1404.7	1.774	1.374	0.700	103.6	391.8	0.663	2.066
-66	46.02	45.98	1398.6	1.984	1.375	0.705	106.3	393.0	0.676	2.058
-64	51.73	51.68	1392.5	2.213	1.377	0.710	109.1	394.1	0.689	2.051
-62	58.00	57.94	1386.4	2.463	1.378	0.715	111.9	395.3	0.702	2.044
-60	64.87	64.80	1380.2	2.734	1.379	0.720	114.6	396.4	0.715	2.037
-58	72.38	72.29	1374.0	3.030	1.380	0.726	117.4	397.6	0.728	2.030
-56	80.57	80.46	1367.8	3.350	1.382	0.732	120.1	398.7	0.741	2.023
-54	89.49	89.36	1361.6	3.696	1.384	0.737	122.9	399.8	0.754	2.017
-52	99.18	99.03	1355.3	4.071	1.386	0.744	125.7	400.9	0.766	2.010
-51.58	101.32	101.17	1354.0	4.153	1.386	0.745	126.3	401.1	0.769	2.009
-50	109.69	109.51	1349.0	4.474	1.388	0.750	128.5	402.0	0.779	2.004
-48	121.07	120.85	1342.7	4.909	1.391	0.756	131.2	403.1	0.791	1.998
-46	133.36	133.11	1336.3	5.377	1.394	0.763	134.0	404.1	0.803	1.992
-44	146.61	146.32	1330.0	5.880	1.397	0.770	136.8	405.2	0.816	1.987
-42	160.89	160.55	1323.5	6.419	1.401	0.777	139.6	406.2	0.828	1.981
-40	176.24	175.85	1317.0	6.996	1.405	0.785	142.4	407.3	0.840	1.976
-38	192.71	192.27	1310.5	7.614	1.409	0.792	145.3	408.3	0.852	1.970
-36	210.37	209.86	1304.0	8.275	1.414	0.800	148.1	409.3	0.864	1.965
-34	229.26	228.69	1297.3	8.980	1.419	0.809	150.9	410.2	0.875	1.960
-32	249.46	248.81	1290.6	9.732	1.424	0.817	153.8	411.2	0.887	1.955
-30	271.01	270.28	1283.9	10.53	1.430	0.826	156.6	412.1	0.899	1.950
-28	293.99	293.16	1277.1	11.39	1.436	0.835	159.5	413.1	0.911	1.946
-26	318.44	317.52	1270.2	12.29	1.442	0.844	162.4	414.0	0.922	1.941
-24	344.44	343.41	1263.3	13.26	1.448	0.854	165.3	414.9	0.934	1.936
-22	372.05	370.90	1256.3	14.28	1.455	0.864	168.2	415.7	0.945	1.932
-20	401.34	400.06	1249.2	15.37	1.461	0.875	171.1	416.6	0.957	1.927
-18	432.36	430.95	1242.0	16.52	1.468	0.886	174.1	417.4	0.968	1.923
-16	465.20	463.64	1234.8	17.74	1.476	0.897	177.0	418.2	0.980	1.919
-14	499.91	498.20	1227.5	19.04	1.483	0.909	180.0	419.0	0.991	1.914
-12	536.58	534.69	1220.0	20.41	1.491	0.921	182.9	419.8	1.003	1.910
-10	575.26	573.20	1212.5	21.86	1.499	0.933	185.9	420.5	1.014	1.906
-8	616.03	613.78	1204.9	23.39	1.507	0.947	189.0	421.2	1.025	1.902
-6	658.97	656.52	1197.2	25.01	1.516	0.960	192.0	421.9	1.036	1.898
-4	704.15	701.49	1189.4	26.72	1.524	0.975	195.0	422.6	1.048	1.894
-2	751.64	748.76	1181.4	28.53	1.533	0.990	198.1	423.2	1.059	1.890
0	801.52	798.41	1173.4	30.44	1.543	1.005	201.2	423.8	1.070	1.886
2	853.87	850.52	1165.3	32.46	1.552	1.022	204.3	424.4	1.081	1.882
4	908.77	905.16	1157.0	34.59	1.563	1.039	207.4	424.9	1.092	1.878
6	966.29	962.42	1148.6	36.83	1.573	1.057	210.5	425.5	1.103	1.874
8	1026.5	1022.4	1140.0	39.21	1.584	1.076	213.7	425.9	1.114	1.870
10	1089.5	1085.1	1131.3	41.71	1.596	1.096	216.8	426.4	1.125	1.866
12	1155.4	1150.7	1122.5	44.35	1.608	1.117	220.0	426.8	1.136	1.862
14	1224.3	1219.2	1113.5	47.14	1.621	1.139	223.2	427.2	1.147	1.859
16	1296.2	1290.8	1104.4	50.09	1.635	1.163	226.5	427.5	1.158	1.855
18	1371.2	1365.5	1095.1	53.20	1.650	1.188	229.7	427.8	1.169	1.851
20	1449.4	1443.4	1085.6	56.48	1.666	1.215	233.0	428.1	1.180	1.847
22	1530.9	1524.6	1075.9	59.96	1.683	1.243	236.4	428.3	1.191	1.843
24	1615.8	1609.2	1066.0	63.63	1.701	1.273	239.7	428.4	1.202	1.839
26	1704.2	1697.2	1055.9	67.51	1.721	1.306	243.1	428.6	1.214	1.834
28	1796.2	1788.9	1045.5	71.62	1.743	1.341	246.5	428.6	1.225	1.830
30	1891.9	1884.2	1034.9	75.97	1.767	1.379	249.9	428.6	1.236	1.826
32	1991.3	1983.2	1024.1	80.58	1.793	1.420	253.4	428.6	1.247	1.822
34	2094.5	2086.2	1012.9	85.48	1.822	1.465	256.9	428.4	1.258	1.817
36	2201.7	2193.1	1001.4	90.68	1.855	1.514	260.5	428.3	1.269	1.813
38	2313.0	2304.0	989.5	96.22	1.891	1.569	264.1	428.0	1.281	1.808
40	2428.4	2419.2	977.3	102.1	1.932	1.629	267.8	427.7	1.292	1.803
42	2548.1	2538.6	964.6	108.4	1.979	1.696	271.5	427.2	1.303	1.798
44	2672.2	2662.4	951.4	115.2	2.033	1.771	275.3	426.7	1.315	1.793
46	2800.7	2790.7	937.7	122.4	2.095	1.857	279.2	426.1	1.327	1.788
48	2933.7	2923.6	923.3	130.2	2.168	1.955	283.2	425.4	1.339	1.782
50	3071.5	3061.2	908.2	138.6	2.256	2.069	287.3	424.5	1.351	1.776
52	3214.0	3203.6	892.2	147.7	2.362	2.203	291.5	423.5	1.363	1.770
54	3361.4	3351.0	875.1	157.6	2.493	2.363	295.8	422.4	1.376	1.764
56	3513.8	3503.5	856.8	168.4	2.661	2.557	300.3	421.0	1.389	1.757
58	3671.3	3661.2	836.9	180.4	2.883	2.799	305.0	419.4	1.403	1.749
60	3834.1	3824.2	814.9	193.7	3.191	3.106	310.0	417.6	1.417	1.741
62	4002.1	3992.7	790.1	208.6	3.650	3.511	315.3	415.5	1.433	1.732
64	4175.7	4166.8	761.0	225.6	4.415	4.064	321.2	413.0	1.450	1.722

4. Removing the switchbox

Caution

- Removing electrical components
 - Remove the cover screws before removing an electrical component. Not doing so may damage the refrigerant pipe.
 - Replace the grease on the heat sink with new grease. Not doing so may cause the PCB to fail due to insufficient cooling.

Removal

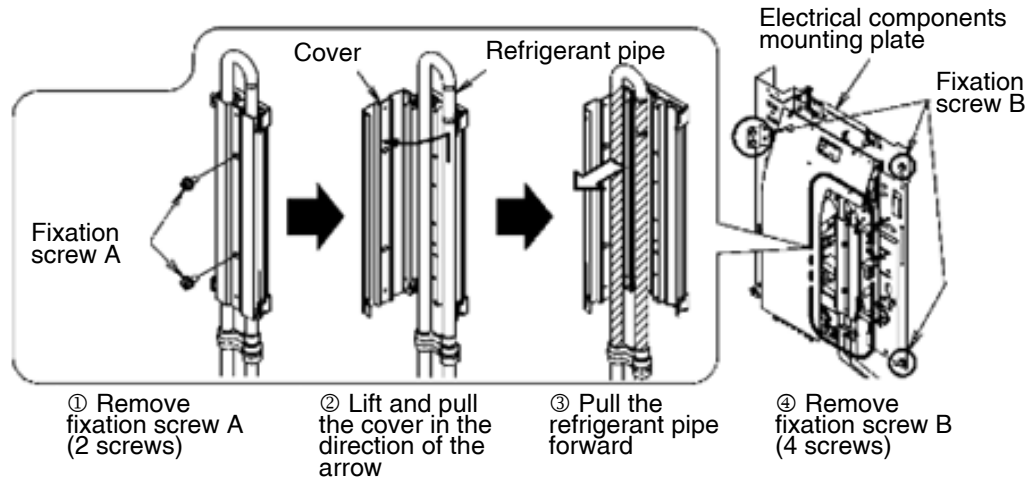

Caution

Do not touch the hatched area.
Always replace the grease after removing an electrical component.

Mounting

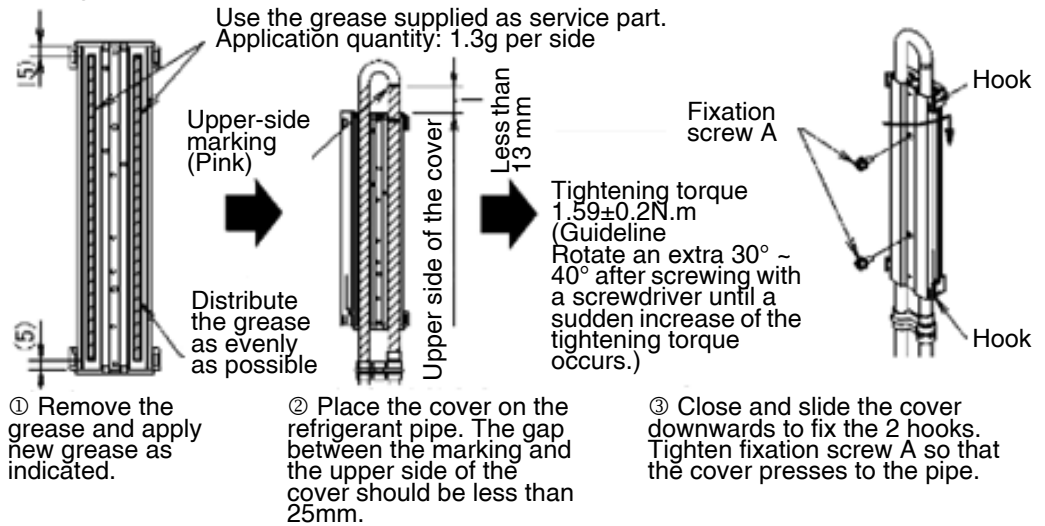

Caution

Do not touch the hatched area when mounting the refrigerant pipe.

- Service port
 - When using the service port, do not let the electrical components come into contact with refrigerant or oil.
- Electrical work
 - Install an earth leakage breaker resistant to high-frequency electrical noise. (Since this product contains an inverter device, this is necessary in order to prevent a malfunction of the breaker itself.)
 - Make sure to establish an earth connection.



Warning Turn off the power before working on the electrical wiring.