

Service Manual

Inverter Pair Wall Mounted Type E-Series



[Applied Models]

● Inverter Pair : Heat Pump

Inverter Pair E-Series

●Heat Pump

Indoor Units

FTXR28EV1B

FTXR42EV1B

FTXR50EV1B

Outdoor Units

RXR28EV1B

RXR42EV1B

RXR50EV1B

1. Introduction	vi
1.1 Safety Cautions	vi
Part 1 List of Functions	1
1. Functions.....	2
Part 2 Specifications	3
1. Specifications	4
Part 3 Printed Circuit Board Connector Wiring Diagram	7
1. Printed Circuit Board Connector Wiring Diagram.....	8
1.1 Indoor Unit.....	8
1.2 Outdoor Unit.....	10
Part 4 Function and Control.....	13
1. Description of Operation	15
1.1 Indoor Unit.....	15
1.2 Outdoor Unit.....	16
2. Main Functions.....	17
2.1 “URURU” Humidifying / Humid Heating Operation.....	17
2.2 “SARARA” Drying Operation	26
2.3 Comfort Sleep Operation.....	28
2.4 MOISTURIZING Operation	30
2.5 Automatic Operation.....	31
2.6 Comfort Airflow Mode.....	32
2.7 Cooling Breeze Operation	34
2.8 Power-airflow Dual Flaps	35
2.9 Wide-angle Louvers	36
2.10 3-D Airflow.....	37
2.11 POWERFUL Operation	38
2.12 Indoor Unit Quiet Operation	39
2.13 Multi-colored Indicator Lamp	39
2.14 Monitor Brightness Setting	40
2.15 Information Display.....	40
2.16 MOLD PROOF Operation	41
2.17 Mold Proof Stick	43
2.18 MOLD SHOCK Operation	44
2.19 HOME LEAVE Ventilation	47
2.20 FLASH STREAMER AIR PURIFYING Operation	48
2.21 Fresh Air Supply Ventilation	51
2.22 Wipe-clean Flat Panel	53
2.23 Filter Cleaning Indicator (Remote Control).....	53
2.24 TIMER Operation	54
2.25 Night Set Mode.....	55
2.26 Table for Special Modes.....	56
2.27 Thermostat Control.....	58
2.28 Fan Speed Control for Indoor Units.....	59
2.29 Draft Prevention (HOT Start).....	61

3.	Control Specification	62
3.1	Frequency Control.....	62
3.2	Preheating Operation (Quick Warming Function)	63
3.3	Four-way Valve Operation.....	64
3.4	Compressor Start up Protection	65
3.5	Fan Speed Control for Outdoor Unit.....	66
3.6	Fin Thermistor Control.....	66
3.7	Input Current Control.....	67
3.8	Peak-cut Control.....	68
3.9	Indoor Coil Freeze-up Protection	69
3.10	Dew Prevention	70
3.11	Liquid Compression Protection 2	71
3.12	Discharge Pipe Temperature Control.....	72
3.13	Automatic Defrosting	73
3.14	Electronic Expansion Valve Control	75
Part 5 System Configuration.....		81
1.	Installation Manual	82
1.1	Indoor Units	82
1.2	Outdoor Units	96
2.	System Configuration.....	106
3.	Instruction.....	107
3.1	Safety Precautions	107
3.2	Names and Functions of Parts	108
3.3	Preparation before Operation.....	110
3.4	Cooling · “SARARA” DRYING Operation	112
3.5	Heating · “URURU” HUMIDIFYING Operation	113
3.6	AUTO / MOISTURIZING Operation	114
3.7	Adjusting Airflow Direction · Comfort Airflow Mode · Cooling Breeze · Airflow Rate	115
3.8	FLASH STREAMER AIR PURIFYING · FRESH AIR SUPPLY VENTILATION Operation / HOME LEAVE VENTILATION	116
3.9	TIMER Operation	117
3.10	COMFORT SLEEP / POWERFUL Operation	118
3.11	SET UP	119
3.12	MOLD PROOF Operation	120
3.13	MOLD SHOCK Operation / INFORMATION DISPLAY	121
3.14	Care and Cleaning	122
3.15	Troubleshooting.....	130
Part 6 Service Diagnosis.....		135
1.	Convenient Service Check Function	137
2.	Troubleshooting	139
2.1	Error Code Indication by Remote Control	139
2.2	Air conditioner does not run.	141
2.3	Air conditioner runs but does not get cooling (heating).	143
2.4	When operation starts, safety breaker works.	145
2.5	Air conditioner makes big noise and vibration.	147
2.6	Air does not humidified enough.....	148
2.7	Indoor Unit PCB Fault	150
2.8	Peak-cut Control or Freeze-up Protection.....	151

2.9	Fan Motor System (DC Motor) Fault	153
2.10	Streamer Unit Fault	155
2.11	Thermistor System Fault	157
2.12	Front Panel Open / Close Fault.....	158
2.13	Humidity Sensor Fault	159
2.14	Signal Transmission Error (Indoor Unit - Outdoor Unit)	160
2.15	Incompatible Power Supply between Indoor Unit and Outdoor Unit	162
2.16	Incomplete Setting for Hose Length	163
2.17	Outdoor Unit PCB Fault.....	164
2.18	OL Activation (Compressor Overload)	165
2.19	Compressor Lock	166
2.20	DC Fan Lock	167
2.21	Input Over Current Detection	168
2.22	Four Way Valve Fault.....	170
2.23	Discharge Pipe Temperature Control.....	172
2.24	High Pressure Control in Cooling	173
2.25	Compressor Sensor System Fault	175
2.26	Damper Fault.....	176
2.27	Position Sensor Fault	177
2.28	DC Voltage / DC Current Sensor Fault	179
2.29	Thermistor System Fault	180
2.30	Abnormal Temperature in Electrical Box.....	182
2.31	Temperature Rise in Radiation Fin.....	184
2.32	Output Overcurrent.....	186
2.33	Insufficient Gas.....	188
2.34	Over Voltage Protection / Low Voltage Protection	190
2.35	Outdoor Unit PCB Fault or Communication Circuit Fault	191
2.36	Signal Transmission Error on Outdoor Unit PCB	194
2.37	Fan Motor System Fault / Fan Lock	196
2.38	Heater Wire Fault	197
2.39	Humidification Fan Outlet Thermistor Fault / Abnormal Heater Temperature.....	199
2.40	Lights-out of Microcomputer Status Lamp.....	201
3.	Check	202
3.1	Thermistor Resistance Check	202
3.2	Installation Condition Check.....	203
3.3	Outdoor Fan System Check (DC Motor)	203
3.4	Power Supply Waveform Check.....	204
3.5	Capacitor Voltage Check.....	204
3.6	Main Circuit Electrolytic Capacitor Check	205
3.7	Refrigerant System Check	205
3.8	“Inverter Checker” Check	206
3.9	Power Transistor Check	207
3.10	Discharge Pressure Check.....	208
3.11	Electronic Expansion Valve Check.....	209
3.12	Indoor Unit PCB Output Check	210
3.13	Rotating Pulse Input on Outdoor Unit PCB Check	211
3.14	Humidity Sensor Check.....	212
3.15	Main Circuit Short Check.....	212
3.16	Four-way Valve Performance Check.....	213
3.17	Solenoid Valve for Dehumidification Check	214

Part 7	Removal Procedure	215
1.	Indoor Unit.....	216
1.1	Removal of the Air Filters / Front panel.....	216
1.2	Removal of the Upper Panel	222
1.3	Removal of the Front Grille	225
1.4	Removal of the Assembly of the Open/Close Mechanism	228
1.5	Removal of the Assembly of the Reduction Motor	230
1.6	Removal of the Electrical Box	233
1.7	Removal of the PCB.....	238
1.8	Removal of the Dehumidifying Solenoid Valve Coil	244
1.9	Removal of the Connecting Duct.....	245
1.10	Removal of the Drain Hose	247
1.11	Removal of the Swing Motor	249
1.12	Removal of the Heat Exchanger	251
1.13	Removal of the Propeller Fan / Fan Motor	254
1.14	Removal of Horizontal Blades / Vertical Blades	257
1.15	Removal of the Streamer Unit.....	259
2.	Outdoor Unit.....	263
2.1	Removal of the Humidify Unit.....	263
2.2	Removal of the Heater Assembly / Humidifying Rotor (Moisture Absorption Element) / Humidifying Rotor Motor	266
2.3	Removal of the Humidifying Assembly.....	270
2.4	Removal of the Moisture Absorption Fan Motor.....	273
2.5	Removal of the Propeller Fan / Fan Motor	274
2.6	Removal of the Duct in Humidifier.....	279
2.7	Removal of the Electrical Box	280
2.8	Removal of the PCB.....	284
2.9	Removal of the Sound Blanket.....	287
2.10	Remove the Thermistor Assembly	289
2.11	Removal of the Reactor / Partition Plate	291
2.12	Removal of the Four Way Valve.....	292
2.13	Removal of the Expansion Valve	294
2.14	Removal of the Compressor.....	295
Part 8	Others	297
1.	Others	298
1.1	Test Run from the Remote Control	298
1.2	Field Setting	299
Part 9	Appendix.....	301
1.	Piping Diagrams	302
1.1	Indoor Units	302
1.2	Outdoor Units	302
2.	Wiring Diagrams.....	303
2.1	Indoor Units	303
2.2	Outdoor Units	303





Index i

Drawings & Flow Charts vii







1. Introduction







1.1 Safety Cautions

Cautions and Warnings

- Be sure to read the following safety cautions before conducting repair work.
- The caution items are classified into “ **Warning**” and “ **Caution**”. The “ **Warning**” items are especially important since they can lead to death or serious injury if they are not followed closely. The “ **Caution**” items can also lead to serious accidents under some conditions if they are not followed. Therefore, be sure to observe all the safety caution items described below.
- About the pictograms
 - △ This symbol indicates an item for which caution must be exercised.
The pictogram shows the item to which attention must be paid.
 - This symbol indicates a prohibited action.
The prohibited item or action is shown inside or near the symbol.
 - This symbol indicates an action that must be taken, or an instruction.
The instruction is shown inside or near the symbol.
- After the repair work is complete, be sure to conduct a test operation to ensure that the equipment operates normally, and explain the cautions for operating the product to the customer.



1.1.1 Caution in Repair



 Warning	
Be sure to disconnect the power cable plug from the plug socket before disassembling the equipment for a repair. Working on the equipment that is connected to a power supply can cause an electrical shock. If it is necessary to supply power to the equipment to conduct the repair or inspecting the circuits, do not touch any electrically charged sections of the equipment.	
If the refrigerant gas discharges during the repair work, do not touch the discharging refrigerant gas. The refrigerant gas can cause frostbite.	
When disconnecting the suction or discharge pipe of the compressor at the welded section, release the refrigerant gas completely at a well-ventilated place first. If there is a gas remaining inside the compressor, the refrigerant gas or refrigerating machine oil discharges when the pipe is disconnected, and it can cause injury.	
If the refrigerant gas leaks during the repair work, ventilate the area. The refrigerant gas can generate toxic gases when it contacts flames.	
The step-up capacitor supplies high-voltage electricity to the electrical components of the outdoor unit. Be sure to discharge the capacitor completely before conducting repair work. A charged capacitor can cause an electrical shock.	
Do not start or stop the air conditioner operation by plugging or unplugging the power cable plug. Plugging or unplugging the power cable plug to operate the equipment can cause an electrical shock or fire.	

 Caution	
Do not repair the electrical components with wet hands. Working on the equipment with wet hands can cause an electrical shock.	
Do not clean the air conditioner by splashing water. Washing the unit with water can cause an electrical shock.	
Be sure to provide the grounding when repairing the equipment in a humid or wet place, to avoid electrical shocks.	
Be sure to turn off the power switch and unplug the power cable when cleaning the equipment. The internal fan rotates at a high speed, and cause injury.	
Do not tilt the unit when removing it. The water inside the unit can spill and wet the furniture and floor.	
Be sure to check that the refrigerating cycle section has cooled down sufficiently before conducting repair work. Working on the unit when the refrigerating cycle section is hot can cause burns.	
Use the welder in a well-ventilated place. Using the welder in an enclosed room can cause oxygen deficiency.	



1.1.2 Cautions Regarding Products after Repair



 Warning	
Be sure to use parts listed in the service parts list of the applicable model and appropriate tools to conduct repair work. Never attempt to modify the equipment. The use of inappropriate parts or tools can cause an electrical shock, excessive heat generation or fire.	
When relocating the equipment, make sure that the new installation site has sufficient strength to withstand the weight of the equipment. If the installation site does not have sufficient strength and if the installation work is not conducted securely, the equipment can fall and cause injury.	
Be sure to install the product correctly by using the provided standard installation frame. Incorrect use of the installation frame and improper installation can cause the equipment to fall, resulting in injury.	For integral units only
Be sure to install the product securely in the installation frame mounted on a window frame. If the unit is not securely mounted, it can fall and cause injury.	For integral units only



 Warning	
Be sure to use an exclusive power circuit for the equipment, and follow the technical standards related to the electrical equipment, the internal wiring regulations and the instruction manual for installation when conducting electrical work. Insufficient power circuit capacity and improper electrical work can cause an electrical shock or fire.	
Be sure to use the specified cable to connect between the indoor and outdoor units. Make the connections securely and route the cable properly so that there is no force pulling the cable at the connection terminals. Improper connections can cause excessive heat generation or fire.	
When connecting the cable between the indoor and outdoor units, make sure that the terminal cover does not lift off or dismount because of the cable. If the cover is not mounted properly, the terminal connection section can cause an electrical shock, excessive heat generation or fire.	
Do not damage or modify the power cable. Damaged or modified power cable can cause an electrical shock or fire. Placing heavy items on the power cable, and heating or pulling the power cable can damage the cable.	
Do not mix air or gas other than the specified refrigerant (R-410A / R22) in the refrigerant system. If air enters the refrigerating system, an excessively high pressure results, causing equipment damage and injury.	
If the refrigerant gas leaks, be sure to locate the leak and repair it before charging the refrigerant. After charging refrigerant, make sure that there is no refrigerant leak. If the leak cannot be located and the repair work must be stopped, be sure to perform pump-down and close the service valve, to prevent the refrigerant gas from leaking into the room. The refrigerant gas itself is harmless, but it can generate toxic gases when it contacts flames, such as fan and other heaters, stoves and ranges.	
When replacing the coin battery in the remote control, be sure to disposed of the old battery to prevent children from swallowing it. If a child swallows the coin battery, see a doctor immediately.	

 Caution	
Installation of a leakage breaker is necessary in some cases depending on the conditions of the installation site, to prevent electrical shocks.	
Do not install the equipment in a place where there is a possibility of combustible gas leaks. If a combustible gas leaks and remains around the unit, it can cause a fire.	
Be sure to install the packing and seal on the installation frame properly. If the packing and seal are not installed properly, water can enter the room and wet the furniture and floor.	For integral units only

1.1.3 Inspection after Repair

 Warning	
Check to make sure that the power cable plug is not dirty or loose, then insert the plug into a power outlet all the way. If the plug has dust or loose connection, it can cause an electrical shock or fire.	
If the power cable and lead wires have scratches or deteriorated, be sure to replace them. Damaged cable and wires can cause an electrical shock, excessive heat generation or fire.	





 Warning	
Do not use a joined power cable or extension cable, or share the same power outlet with other electrical appliances, since it can cause an electrical shock, excessive heat generation or fire.	

 Caution	
Check to see if the parts and wires are mounted and connected properly, and if the connections at the soldered or crimped terminals are secure. Improper installation and connections can cause excessive heat generation, fire or an electrical shock.	
If the installation platform or frame has corroded, replace it. Corroded installation platform or frame can cause the unit to fall, resulting in injury.	
Check the grounding, and repair it if the equipment is not properly grounded. Improper grounding can cause an electrical shock.	
Be sure to measure the insulation resistance after the repair, and make sure that the resistance is 1 Mohm or higher. Faulty insulation can cause an electrical shock.	
Be sure to check the drainage of the indoor unit after the repair. Faulty drainage can cause the water to enter the room and wet the furniture and floor.	

1.1.4 Using Icons

Icons are used to attract the attention of the reader to specific information. The meaning of each icon is described in the table below:

1.1.5 Using Icons List

Icon	Type of Information	Description
 Note:	Note	A “note” provides information that is not indispensable, but may nevertheless be valuable to the reader, such as tips and tricks.
 Caution	Caution	A “caution” is used when there is danger that the reader, through incorrect manipulation, may damage equipment, lose data, get an unexpected result or has to restart (part of) a procedure.
 Warning	Warning	A “warning” is used when there is danger of personal injury.
	Reference	A “reference” guides the reader to other places in this binder or in this manual, where he/she will find additional information on a specific topic.

Part 1

List of Functions

1. Functions.....2

1. Functions

Category	Functions	FTXR28/42/50EV1B RXR28/42/50EV1B	Category	Functions	FTXR28/42/50EV1B RXR28/42/50EV1B	
Basic Function	Inverter (with Inverter Power Control)	○		Air Purifying Filter with Bacteriostatic, Virustatic Functions	—	
	Operation Limit for Cooling (°CDB)	21 ~43		Photocatalytic Deodorizing Filter	—	
	Operation Limit for Heating (°CWB)	-20 ~24		Air Purifying Filter with Photocatalytic Deodorizing Function	—	
	PAM Control	○		Titanium Apatite Photocatalytic Air Purifying Filter	○	
Compressor	Oval Scroll Compressor	—		Air Intake Filter	○	
	Swing Compressor	○		Flash Streamer Air Purifying	○	
	Rotary Compressor	—		Mold Proof Air Filter	○	
	Reluctance DC Motor	○		Wipe-clean Flat Panel	○	
Comfortable Airflow	Power-Airflow Flap	—	Health & Clean	Washable Upper Grille	○	
	Power-Airflow Dual Flaps	○		Filter Cleaning Indicator (remote control)	○	
	Power-Airflow Diffuser	—		Mold Proof Operation	○	
	Wide-Angle Louvers	○		Mold Shock Operation	○	
	Vertical Auto-Swing (Up and Down)	○		Mold Proof Stick	○	
	Horizontal Auto-Swing (Right and Left)	○		Comfort Sleep Operation	○	
	3-D Airflow	○		Fresh Air Supply Ventilation	○	
	Comfort Airflow Mode	○		Home Leave Ventilation	○	
	Cooling Breeze Operation	○		Heating Dry Operation	—	
	3-Step Airflow (H/P Only)	—		Good-Sleep Cooling Operation	—	
Comfort Control	Auto Fan Speed	○	Timer	24-Hour ON/OFF Timer	○	
	Indoor Unit Quiet Operation	○		Count Up-down ON/OFF Timer	OFF only	
	Night Quiet Mode (Automatic)	—		Night Set Mode	○	
	Outdoor Unit Quiet Operation (Manual)	—		Quiet Control	○	
	Intelligent Eye	—		Auto-Restart (after Power Failure)	○	
	Quick Warming Function	○		Self-Diagnosis (remote control) Display	○	
Operation	Hot-Start Function	○	Worry Free "Reliability & Durability"	Wiring Error Check	—	
	Automatic Defrosting	○		Anticorrosion Treatment of Outdoor Heat Exchanger	○	
	Automatic Operation	○		Flexibility	Multi-Split / Split Compatible Indoor Unit	—
	URURU Humidifying Operation	○			Flexible Voltage Correspondence	—
	Moisturizing Operation	○			High Ceiling Application	—
	SARARA Drying Operation	○			Chargeless	○
	Dry Cooling Operation	○			Either Side Drain (Right or Left)	○
	Programme Dry Function	—			Power Selection	—
Fan Only	—	Remote Control	5-Rooms Centralized Controller (Option)		○	
Air Purifying Operation	○		Remote Control adapter (Normal Open-Pulse Contact) (Option)		○	
Lifestyle Convenience	New Powerful Operation (Non-Inverter)		—	remote control	Remote Control adapter (Normal Open Contact) (Option)	○
	Inverter Powerful Operation		○		DIII-NET Compatible (adapter) (Option)	○
	Dry Keep		JP set		Wireless	○
	Priority-Room Setting		—		Wired	—
	Cooling / Heating Mode Lock		—			
	Home Leave Operation		—			
	ECONO Mode	—				
	Indoor Unit ON/OFF Switch	○				
	Multi-colored Indicator	○				
	Monitor Brightness Setting	○				
	Signal Reception Indicator	○				
	Temperature & Humidity Level Information Display (remote control)	○				
	Childproof Lock	○				
	Temperature Display	—				
Another Room Operation	—					

Note: ○ : Holding Functions
— : No Functions

Part 2 Specifications

1. Specifications 4

1. Specifications

50Hz 220-230-240V

Model	Indoor Units		FTXR28EV1B		FTXR42EV1B	
	Outdoor Units		RXR28EV1B		RXR42EV1B	
			Cooling	Heating	Cooling	Heating
Capacity Rated (Min.~Max.)	kW		2.8 (1.55~3.60)	3.6 (1.30~5.00)	4.2 (1.55~4.60)	5.1 (1.30~5.60)
	Btu/h		9,600 (5,300~12,300)	12,300 (4,400~16,400)	14,300 (5,300~15,700)	17,400 (4,400~19,100)
	kcal/h		2,410 (1,330~3,100)	3,100 (1,120~4,130)	3,610 (1,330~3,960)	4,390 (1,120~4,820)
Moisture Removal	L/h		1.6	—	2.3	—
Running Current (Rated)	A		3.2-3.1-3.0	3.9-3.8-3.7	5.3-5.2-5.1	5.9-5.8-5.7
Power Consumption Rated (Min.~Max.)	W		560 (250~800)	700 (200~1,410)	1,050 (260~1,320)	1,180 (220~1,600)
Power Factor	%		79.5-78.5-77.8	81.6-80.1-78.8	90.1-87.8-85.8	90.9-88.5-86.3
COP Rated (Min.~Max.)	W/W		5.00 (6.20~4.50)	5.14 (5.91~3.55)	4.00 (5.96~3.48)	4.32 (5.91~3.50)
Piping Connections	Liquid	mm	φ 6.4		φ 6.4	
	Gas	mm	φ 9.5		φ 9.5	
	Drain	mm	φ18.0		φ18.0	
Heat Insulation			Both Liquid and Gas Pipes		Both Liquid and Gas Pipes	
Max. Interunit Piping Length	m		10		10	
Max. Interunit Height Difference	m		8		8	
Amount of Additional Charge of Refrigerant	g/m		Chargeless		Chargeless	
Indoor Unit			FTXR28EV1B		FTXR42EV1B	
Front Panel Color			White		White	
Air Flow Rate	ml/min (cfm)	H	11.1 (392)	12.4 (438)	12.4 (438)	12.9 (456)
		M	8.8 (311)	9.8 (346)	9.6 (339)	10.2 (360)
		L	6.5 (230)	7.3 (258)	6.8 (240)	7.7 (272)
		SL	5.7 (201)	6.5 (230)	6.0 (212)	6.8 (240)
Fan	Type		Cross Flow Fan (With Saw Edge)		Cross Flow Fan (With Saw Edge)	
	Motor Output	W	57		57	
	Speed	Steps	5 Steps, Quiet, Auto		5 Steps, Quiet, Auto	
Air Direction Control			Right, Left, Horizontal, Downward		Right, Left, Horizontal, Downward	
Air Filter			Removable / Washable / Mildew Proof		Removable / Washable / Mildew Proof	
Running Current (Rated)	A		0.15-0.14-0.13	0.15-0.14-0.13	0.17-0.16-0.15	0.17-0.16-0.15
Power Consumption (Rated)	W		30-30-30	30-30-30	35-35-35	35-35-35
Power Factor	%		90.9-93.2-96.2	90.9-93.2-96.2	93.6-95.1-97.2	93.6-95.1-97.2
Temperature Control			Microcomputer Control		Microcomputer Control	
Dimensions (H×W×D)	mm		305×890×209		305×890×209	
Packaged Dimensions (H×W×D)	mm		280×956×378		280×956×378	
Weight	kg		14		14	
Gross Weight	kg		20		20	
Operation Sound	H/M/L/SL	dBA	39/33/26/23	41/35/28/25	42/35/27/24	42/36/29/26
Sound Power	H	dBA	55	57	58	58
Outdoor Unit			RXR28EV1B		RXR42EV1B	
Casing Color			Ivory White		Ivory White	
Compressor	Type		Hermetically Sealed Swing Type		Hermetically Sealed Swing Type	
	Model		2YC36CXD		2YC36CXD	
	Motor Output	W	1,100		1,100	
Refrigerant Oil	Model		FVC50K		FVC50K	
	Charge	L	0.4		0.4	
Refrigerant	Model		R-410A		R-410A	
	Charge	kg	1.4		1.4	
Air Flow Rate (HH)	ml/min		33.8	31.4	36.2	31.9
	cfm		800	750	850	760
Fan	Type		Propeller		Propeller	
	Motor Output	W	60		60	
Running Current (Rated)	A		3.05-2.96-2.87	3.75-3.66-3.57	5.13-5.04-4.95	5.73-5.64-5.55
Power Consumption (Rated)	W		530-530-530	670-670-670	1,015-1,015-1,015	1,145-1,145-1,145
Power Factor	%		79.0-77.8-76.9	81.2-79.6-78.2	89.9-87.6-85.4	90.8-88.3-86.0
Starting Current	A		3.9		5.9	
Dimensions (H×W×D)	mm		693×795×285		693×795×285	
Packaged Dimensions (H×W×D)	mm		736×935×410		736×935×410	
Weight	kg		48		48	
Gross Weight	kg		55		55	
Operation Sound	H	dBA	46	46	48	48
Sound Power	H	dBA	60	60	62	62
Drawing No.			3D054159A		3D054160A	

Note: ■ The data are based on the conditions shown in the table below.

Cooling	Heating	Piping Length
Indoor ; 27°CDB/19°CWB Outdoor ; 35°CDB/24°CWB	Indoor ; 20°CDB Outdoor ; 7°CDB/6°CWB	7.5m

Conversion Formulae
kcal/h=kW×860 Btu/h=kW×3414 cfm=ml/min×35.3

50Hz 220-230-240V

Model	Indoor Units		FTXR50EV1B	
	Outdoor Units		RXR50EV1B	
			Cooling	Heating
Capacity Rated (Min.~Max.)	kW		5.0 (1.55~5.50)	6.0 (1.30~6.20)
	Btu/h		17,100 (5,300~18,800)	20,500 (4,400~21,200)
	kcal/h		4,300 (1,330~47,300)	5,160 (1,120~5,330)
Moisture Removal	L/h		2.8	—
Running Current (Rated)	A		7.2-7.1-7.0	7.4-7.3-7.2
Power Consumption Rated (Min.~Max.)	W		1,460 (260~1,800)	1,510 (230~1,770)
Power Factor	%		92.2-89.4-86.9	92.8-89.9-87.4
COP Rated (Min.~Max.)	W/W		3.42 (5.96~3.06)	3.97 (5.65~3.50)
Piping Connections	Liquid	mm	φ 6.4	
	Gas	mm	φ 9.5	
	Drain	mm	φ18.0	
Heat Insulation			Both Liquid and Gas Pipes	
Max. Interunit Piping Length	m		10	
Max. Interunit Height Difference	m		8	
Amount of Additional Charge of Refrigerant	g/m		Chargeless	
Indoor Unit			FTXR50EV1B	
Front Panel Color			White	
Air Flow Rate	ml/min (cfm)	H	13.3 (470)	14.0 (494)
		M	10.3 (364)	11.1 (392)
		L	7.3 (258)	8.3 (293)
		SL	6.5 (230)	7.3 (258)
Fan	Type		Cross Flow Fan (With Saw Edge)	
	Motor Output	W	57	
	Speed	Steps	5 Steps, Quiet, Auto	
Air Direction Control			Right, Left, Horizontal, Downward	
Air Filter			Removable / Washable / Mildew Proof	
Running Current (Rated)	A		0.20-0.19-0.18	0.20-0.19-0.18
Power Consumption (Rated)	W		40-40-40	40-40-40
Power Factor	%		90.9-91.5-92.6	90.9-91.5-92.6
Temperature Control			Microcomputer Control	
Dimensions (H×W×D)	mm		305×890×209	
Packaged Dimensions (H×W×D)	mm		280×956×378	
Weight	kg		14	
Gross Weight	kg		20	
Operation Sound	H/M/L/SL	dBA	44/37/29/26	44/38/31/28
Sound Power	H	dBA	60	60
Outdoor Unit			RXR50EV1B	
Casing Color			Ivory White	
Compressor	Type		Hermetically Sealed Swing Type	
	Model		2YC36CXD	
	Motor Output	W	1,100	
Refrigerant Oil	Model		FVC50K	
	Charge	L	0.4	
Refrigerant	Model		R-410A	
	Charge	kg	1.4	
Air Flow Rate (HH)	ml/min		36.2	34.3
	cfm		850	810
Fan	Type		Propeller	
	Motor Output	W	60	
Running Current (Rated)	A		7.0-6.91-6.82	7.2-7.11-7.02
Power Consumption (Rated)	W		1,420-1,420-1,420	1,470-1,470-1,470
Power Factor	%		92.2-89.3-86.8	92.8-89.9-87.3
Starting Current	A		7.4	
Dimensions (H×W×D)	mm		693×795×285	
Packaged Dimensions (H×W×D)	mm		736×935×410	
Weight	kg		48	
Gross Weight	kg		55	
Operation Sound	H	dBA	48	50
Sound Power	H	dBA	62	64
Drawing No.			3D054161A	

Note: ■ The data are based on the conditions shown in the table below.

Cooling	Heating	Piping Length
Indoor ; 27°CDB/19°CWB Outdoor ; 35°CDB/24°CWB	Indoor ; 20°CDB Outdoor ; 7°CDB/6°CWB	7.5m

Conversion Formulae
kcal/h=kW×860 Btu/h=kW×3414 cfm=ml/min×35.3

Part 3 Printed Circuit Board Connector Wiring Diagram

1. Printed Circuit Board Connector Wiring Diagram.....	8
1.1 Indoor Unit.....	8
1.2 Outdoor Unit.....	10

1. Printed Circuit Board Connector Wiring Diagram

1.1 Indoor Unit

Connectors

A1P (Control PCB)

- | | |
|--------|-----------------------------------------------------------|
| 1) S1 | Connector for fan motor |
| 2) S21 | Connector for centralized control (HA) |
| 3) S32 | Connector for heat exchanger thermistor (R1T) |
| 4) S41 | Connector for swing motor (horizontal, vertical) |
| 5) S43 | Connector for solenoid valve |
| 6) S46 | Connector for display PCB |
| 7) S48 | Connector for humidity sensor PCB |
| 8) S51 | Connector for reduction motor, limit switch (front panel) |
| 9) S52 | Connector for streamer unit |

A2P (Display PCB)

- | | |
|--------------|-------------------------------------------------|
| 1) S56 | Connector for control PCB |
| 2) S57 | Connector for signal receiver / transmitter PCB |
| 3) S63 (H1P) | Connector for LED PCB (multi monitor) |

A3P (Signal Receiver/Transmitter PCB)

- | | |
|--------|---------------------------|
| 1) S58 | Connector for display PCB |
|--------|---------------------------|

A4P (Humidity Sensor PCB)

- | | |
|--------|---------------------------|
| 1) CN1 | Connector for control PCB |
|--------|---------------------------|

A5P (Streamer Unit PCB)

- | | |
|---------|-----------------------------------------|
| 1) S401 | Connector for control PCB |
| 2) S402 | Connector for limit switch for streamer |
| 3) S403 | Connector for streamer |



Note:

Other designations

A1P (Control PCB)

- | | |
|----------|--------------------------------------------------------|
| 1) V1 | Varistor |
| 2) FU1 | Fuse (3.15A) |
| 3) LED A | LED for service monitor (green) |
| 4) JB | Fan speed setting when compressor is OFF on thermostat |
| JC | Power failure recovery function (auto-restart) |
- *Refer to page 302 for detail.

A2P (Display PCB)

- | | |
|---------|------------------------------------|
| 1) JA | Address setting jumper |
| 2) SW1 | Forced operation ON / OFF switch |
| 3) LED2 | LED for timer (yellow) |
| 4) LED3 | LED for moisture operation (green) |

A4P (Humidity Sensor PCB)

- | | |
|--------|-----------------------------|
| 1) R2T | Room temperature thermistor |
|--------|-----------------------------|

PCB Detail

PCB(1): Control PCB

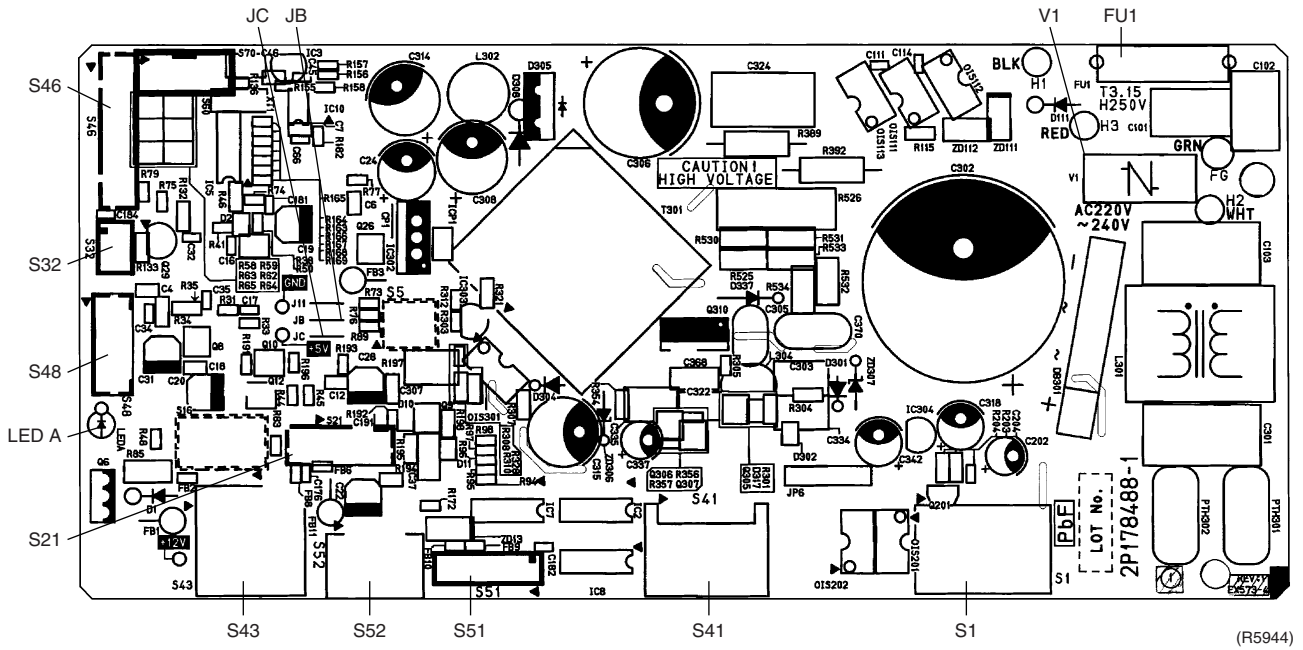

PCB(2): Display PCB

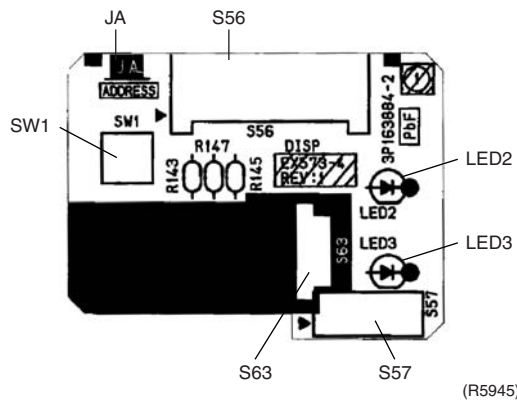

PCB(3): Signal Receiver / Transmitter PCB

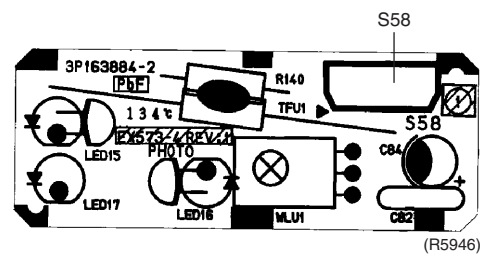

PCB(4): Humidity sensor PCB

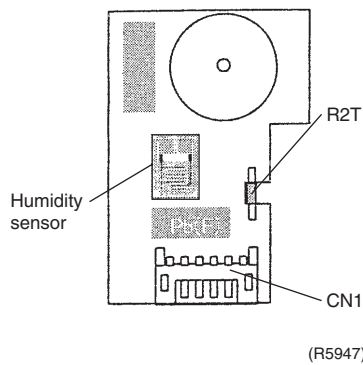

PCB(5): Streamer Unit PCB

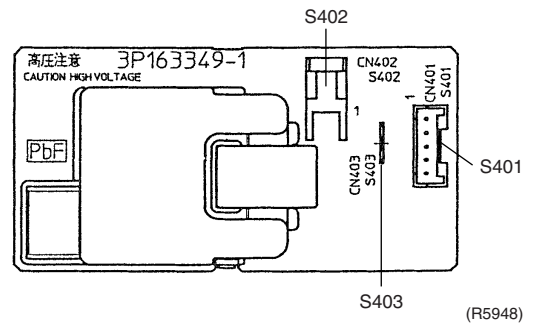

1.2 Outdoor Unit

Connectors

1) S20	Connector for electronic expansion valve coil
2) S21	Connector for rotor motor
3) S22	Connector for damper motor
4) S45	Connector for thermal fuse
5) S70	Connector for DC fan motor
6) S72	Connector for humidification fan motor
7) S80	Connector for four way valve coil
8) S90	Connector for thermistor (outdoor, heat exchanger, discharge pipe)
9) S91	Connector for humidifying thermistor
10)S501	Connector for limit switch
11)HR1, HR2	Connector for reactor
12)HK1, HK2, HK3	Connector for fan motor
13)HH1, HH2	Connector for heater



Note: Other designations

1) FU1, FU2	Fuse (3.15A)
2) FU3	Fuse (30A)
3) V2, V3	Varistor
4) LED A, LED5	LED for service monitor (green)

PCB Detail

PCB(1): Control PCB

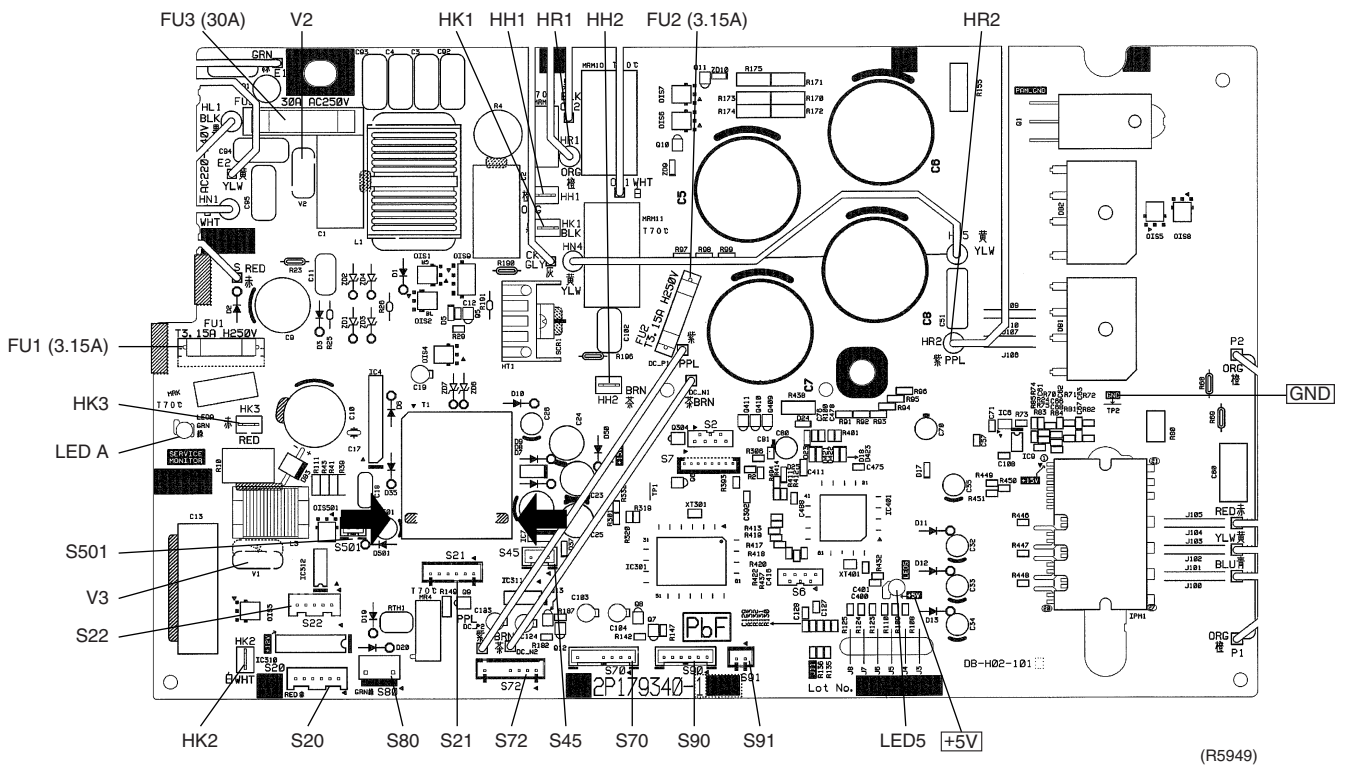

Part 4

Function and Control

1. Description of Operation	15
1.1 Indoor Unit.....	15
1.2 Outdoor Unit.....	16
2. Main Functions.....	17
2.1 “URURU” Humidifying / Humid Heating Operation.....	17
2.2 “SARARA” Drying Operation	26
2.3 Comfort Sleep Operation.....	28
2.4 MOISTURIZING Operation	30
2.5 Automatic Operation.....	31
2.6 Comfort Airflow Mode.....	32
2.7 Cooling Breeze Operation	34
2.8 Power-airflow Dual Flaps	35
2.9 Wide-angle Louvers	36
2.10 3-D Airflow.....	37
2.11 POWERFUL Operation	38
2.12 Indoor Unit Quiet Operation	39
2.13 Multi-colored Indicator Lamp.....	39
2.14 Monitor Brightness Setting	40
2.15 Information Display.....	40
2.16 MOLD PROOF Operation	41
2.17 Mold Proof Stick	43
2.18 MOLD SHOCK Operation	44
2.19 HOME LEAVE Ventilation	47
2.20 FLASH STREAMER AIR PURIFYING Operation	48
2.21 Fresh Air Supply Ventilation	51
2.22 Wipe-clean Flat Panel	53
2.23 Filter Cleaning Indicator (Remote Control).....	53
2.24 TIMER Operation	54
2.25 Night Set Mode.....	55
2.26 Table for Special Modes.....	56
2.27 Thermostat Control.....	58
2.28 Fan Speed Control for Indoor Units.....	59
2.29 Draft Prevention (HOT Start).....	61
3. Control Specification	62
3.1 Frequency Control.....	62
3.2 Preheating Operation (Quick Warming Function)	63
3.3 Four-way Valve Operation.....	64
3.4 Compressor Start up Protection	65
3.5 Fan Speed Control for Outdoor Unit.....	66
3.6 Fin Thermistor Control.....	66
3.7 Input Current Control.....	67
3.8 Peak-cut Control.....	68
3.9 Indoor Coil Freeze up Protection.....	69
3.10 Dew Prevention	70
3.11 Liquid Compression Protection 2	71

3.12 Discharge Pipe Temperature Control.....	72
3.13 Automatic Defrosting	73
3.14 Electronic Expansion Valve Control	75

1. .Description of Operation

1.1 Indoor Unit

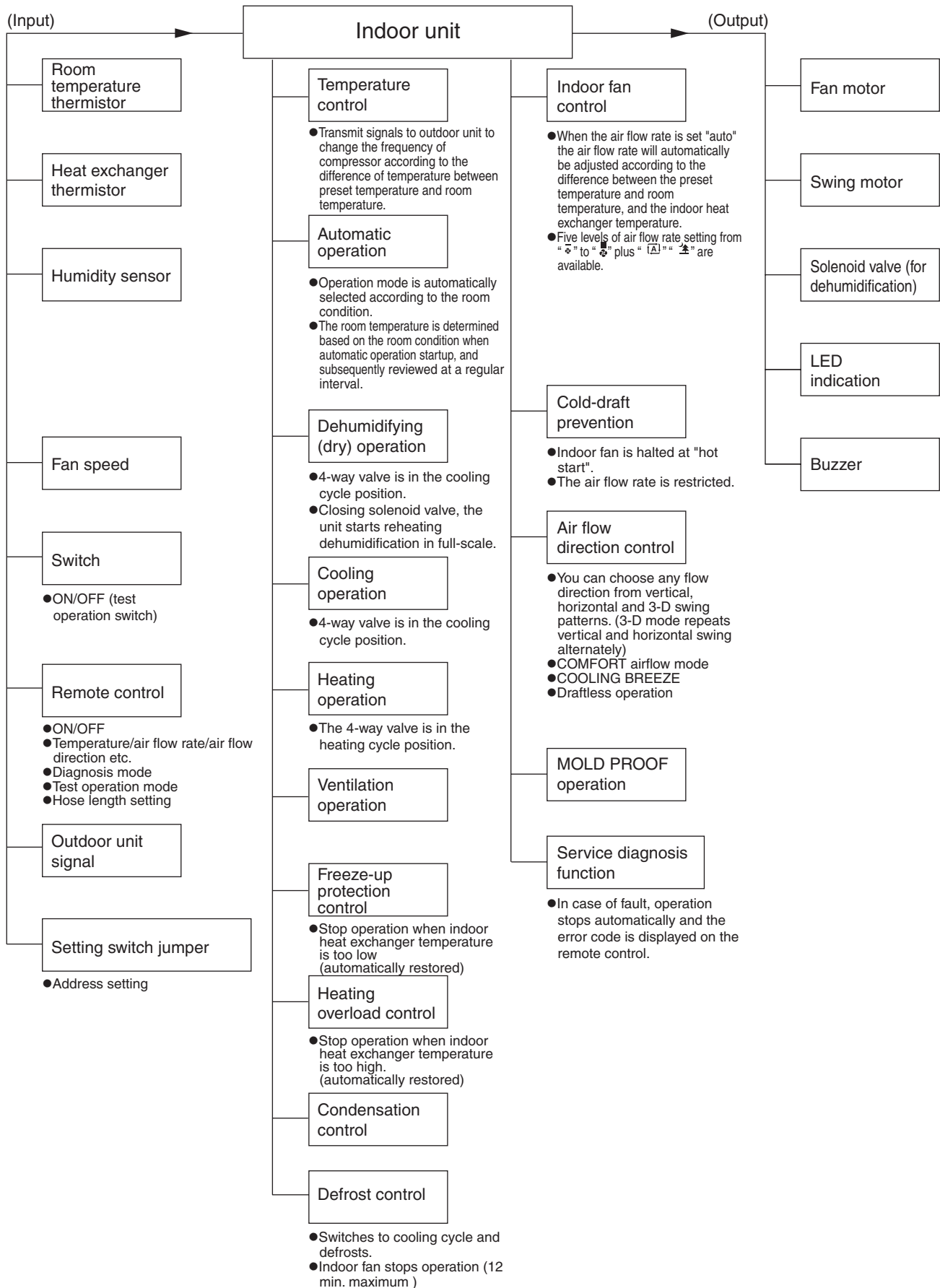

1.2 Outdoor Unit

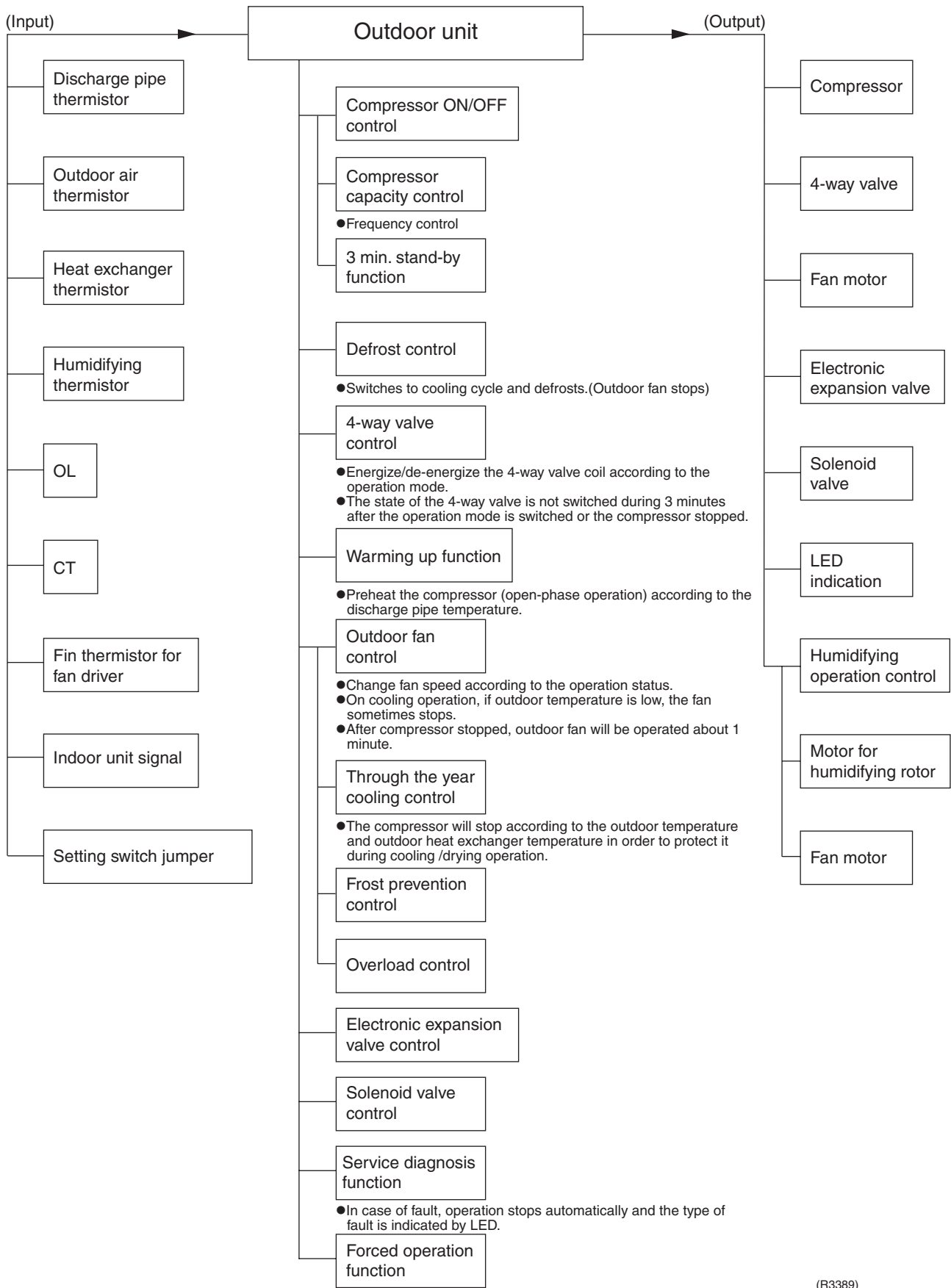

(R3389)

2. Main Functions

2.1 “URURU” Humidifying / Humid Heating Operation

Operation

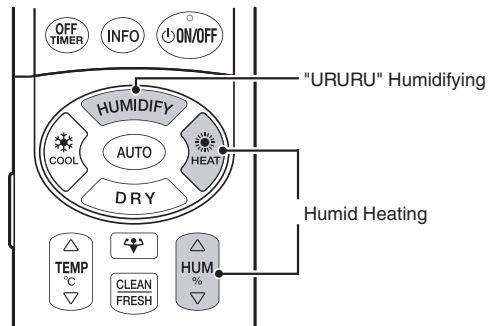

(R5951)

* Refer to the operation manual for details.

Features

■ A world first new humidifying method has adopted

What is new in this method is to intake vapor in the outdoor air with the hygroscopic element mounted in outdoor unit, and send indoors. This has enabled powerful and speedy humidification apart from other company's methods which just absorb moisture in the indoor air.



(R3324)

■ The room is uniformly humidified.

- Humidifier + heating operation by air conditioner
Moisture gathers around the ceiling, as it is lighter than the air even if the humidifier is operated. The air on the floor is kept dry.



When using humidifier, moisture gathers around the ceiling.

(R3325)

- “Humid heating” by URURU / SARARA
This air conditioner enables uniformly humidifying the room by circulating vapor with warm air.

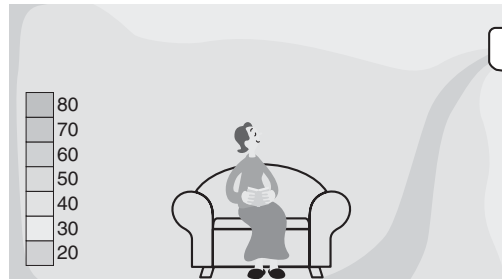

The room is uniformly humidified.

(R3326)

■ Powerful humidifying ability

The humidifying capacity is 450 ml/h (5.0 kW class) and equivalent to that of a normal humidifier.

Model	FTXR28E	FTXR42E	FTXR50E
Humidifying Capacity	400ml/h	425ml/h	450ml/h

The values above are measured at 7°C DB / 6°C WB of outdoor air and with 7.5 m of humidifying hose length.

■ No need for water supply nor cleaning

Water supply and cleaning are unnecessary as it does not have water tank, unlike humidifiers, and there is no proliferations of bacteria.

■ Humidity control

The FTXR-E series model performs the humidifying operation, targeting the humidity level of 40 to 50%.

(You can select the remote control setting from Low, Standard, High and Continue. The target humidity (%) cannot be set.)

i Note

- When the outdoor temperature and humidity are low, the humidifying capacity is decreased. In addition, the moisture in the room may not attain sufficient humidity when the ventilation volume is high, the preset temperature is high, or the preset humidity is HIGH.
- After the “humid heating” operation starts, the relative humidity in the room lowers temporarily. This phenomenon is caused by the increase of the saturation water vapor. Therefore, the humidity raises gradually after the temperature reaches the preset temperature.
- In the humidifying operation, the operation sound increases by about 2 dB both in the indoor and outdoor units. (When the air flow rate is in L or SL, the operation sound increases by about 3 dB in the indoor unit.)
- This system does not suppose the storage of musical instruments or the like.

Conditions for Humidifying Operation

While heating mode, humidifying operation can be available when the following conditions 1~5 are met at the same time.

1. Indoor heat exchanger temperature is 12°C or more.
2. Outdoor temperature is from -10°C to 24°C (meanwhile, in test operation, up to 34°C is possible). Humidifying operation does not work under -10°C.
3. Approx. 1 minute has already passed after heating operation startup. (See Note.)
4. Heating operation does not work to its full capacity. (Meanwhile, the “continuous” humidification is selected, humidifying operation has the priority.)
5. Room humidity is under 70%RH.

i Note

- Exclude the case when it is recovered from thermostat-off or when the defrosting operation finished.

How to Check the Motion of Humidifying Operation

You can check whether the humidifying unit is in good working order. If you set “the humidifying only test operation” (refer to the installation manual for details), you can check even beyond the range of the conditions for humidifying operation mentioned above.

1. Hygroscopic fan Air is exhaled from the front exhaust outlet of outdoor unit.
2. Humidifying fan/heater/damper ... Warm air is blown from the duct of outdoor unit.
3. Humidification rotor The rotor is rotating with top panel off.

As for the performance, estimate from psychrometric chart with the measured temperature and humidity of the outdoor air and of the humidified air (in front of the indoor outlet) using thermal hygrometer.

Performance class	Air flow rate (m ³ /min)
2.8kW	0.40
4.2, 5.0kW	0.44

Humidity Fluctuation by Temperature Settings

At Humidifying Heating Operation, as room temperature rises, relative humidity is temporarily lowered. This is because as room temperature rises, relative humidity is lowered even if the moisture content is the same.

e.g.) The rise in the room temperature from 15°C to 25°C will result in the fall in humidity from 40%RH to about 22%RH.

As humidifying operation starts concurrently with heating, humidity rises gradually as shown in the figure below.

Some room conditions (floor space, ventilation frequency, number of residents, etc.) and temperature settings (mostly higher settings) may result in unsatisfactory humidity settings.

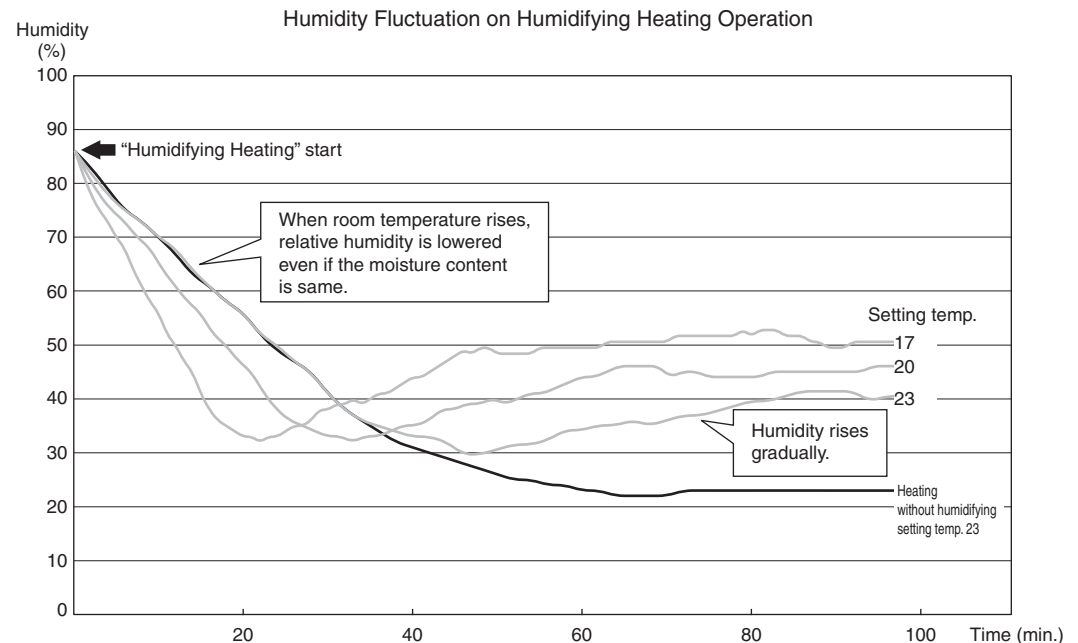

Measurement Conditions
 Outdoor temp.: 7
 Humidify heating operation setting:
 Temp.; each setting as below, Humidify; “CONT” (Continue)
 Airflow rate setting: H tap
 Area of the room: 26.4 m²
 Humidifying hose length: 7.5 m
 Ventilation: 0.75 times/hour
 0.5 times of natural ventilation
 0.25 times of humidity absorption by a carpet, a curtain, etc.

(R5952)

Time chart for humidifying operation control

Approx. 1min. after heating operation start up, it repeats humidifying and drying alternately (to protect condensation for inside the hose).

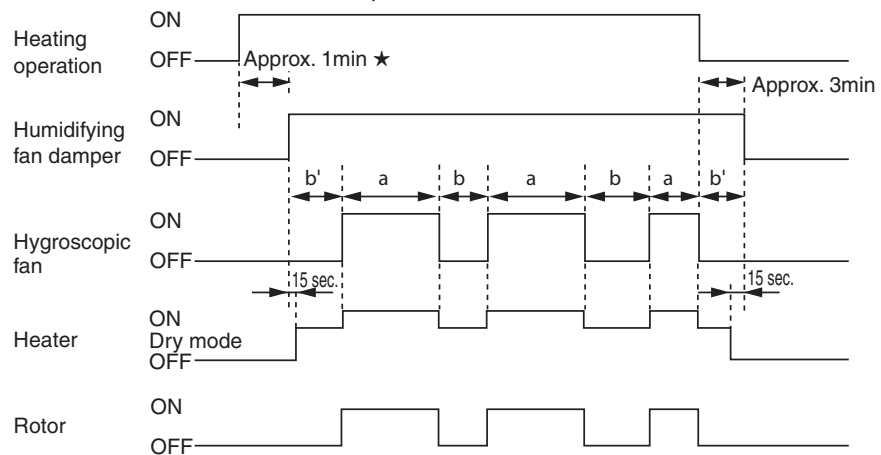

(R3329)

Ⓐ. Humidifying time	Approx. 70min.	Decide time according to the outdoor temperature and hose length set by remote control.
Ⓑ. Drying time	Approx. 2~10min.	Decide time according to the hose length set by remote control.
Ⓑ'. Drying time	Approx. 2~10min.	

★ “Humidifying only operation” has no 1min-delay, it immediately starts up from Ⓑ', and works in the same sequence as others .

■ Time chart for “humidifying only test operation”

“Humidifying only test operation” on trial mode works in the same sequence as humidifying operation, but about 30 min. later it automatically stops.

■ Remarks

1. When a room is spacious such as loft style or partitioned by accordion style curtain, the ventilation volume is large and may not sometimes reach the set humidity.
2. When room temperature falls (12°C or lower), though “humidifying only test operation” is functionally possible, humidifying heating operation continues to keep room temperature.

Humidification performance by outdoor temperature

The humidifying of this system is different from that of the normal humidifier. Therefore, the humidifying performance varies with the outdoor temperature or installation condition. Sufficient humidifying capacity may not be attained depending on the weather condition in operation.

When the outdoor temperature lowers by 5°C, the humidifying capacity is decreased by about 15%.

When the outdoor humidity lowers by 20%, the humidifying capacity is decreased by about 20%.

28 class (rated : 400ml/h)

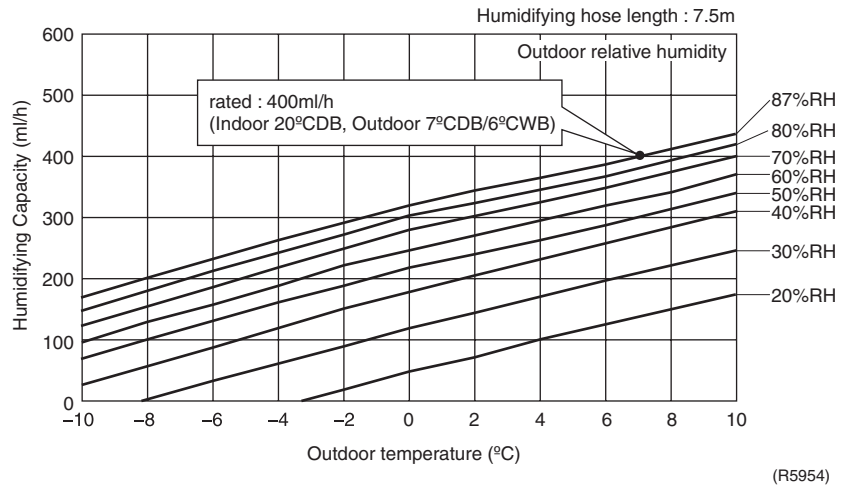

42 class (rated : 425ml/h)

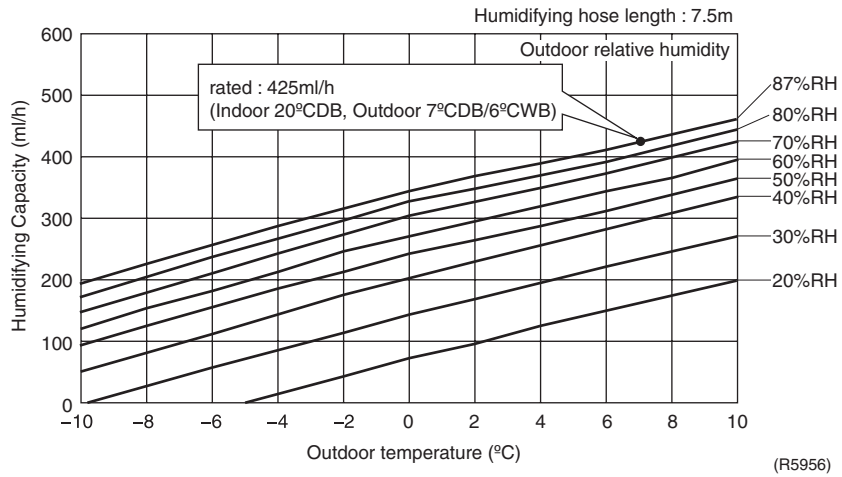

50 class (rated : 450ml/h)

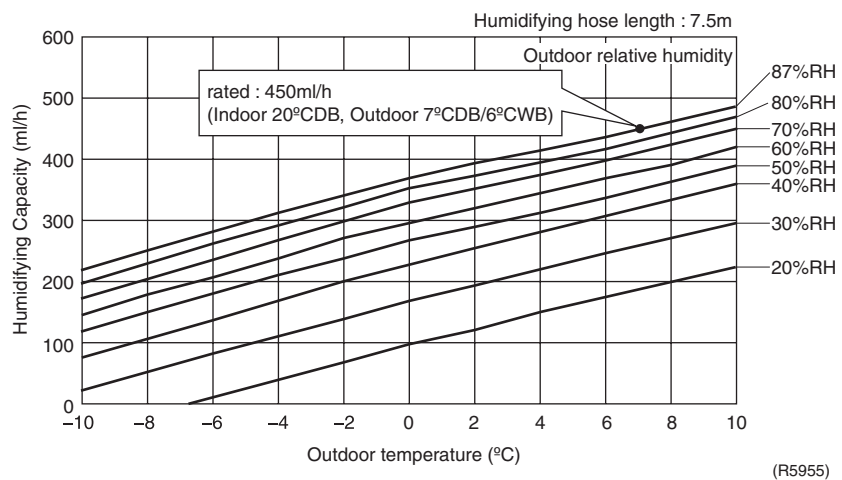

Reachable humidity by outdoor condition

- The ability of humidification drops when the outdoor temperature and humidity are low.

28 class

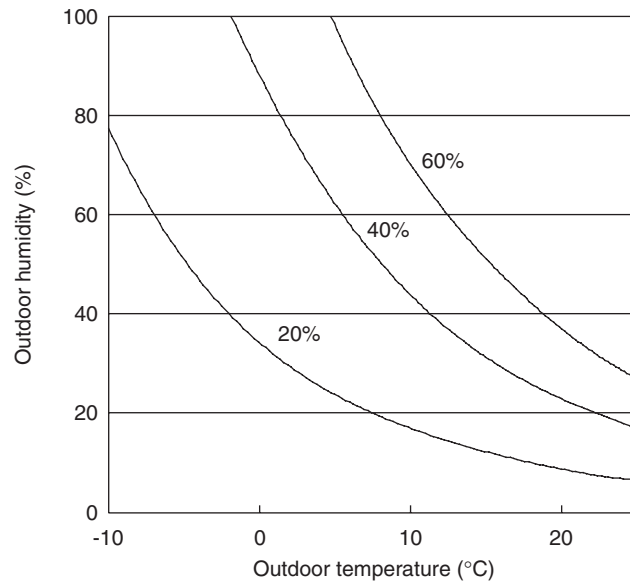

Condition;
 Model:FTXR28EV1B
 Indoor temperature setting:20°C
 Airflow rate:Max
 Room volume:70m³
 Air change rate:0.5/hour
 humidifying hose length:7.5m

(R5957)

42 class

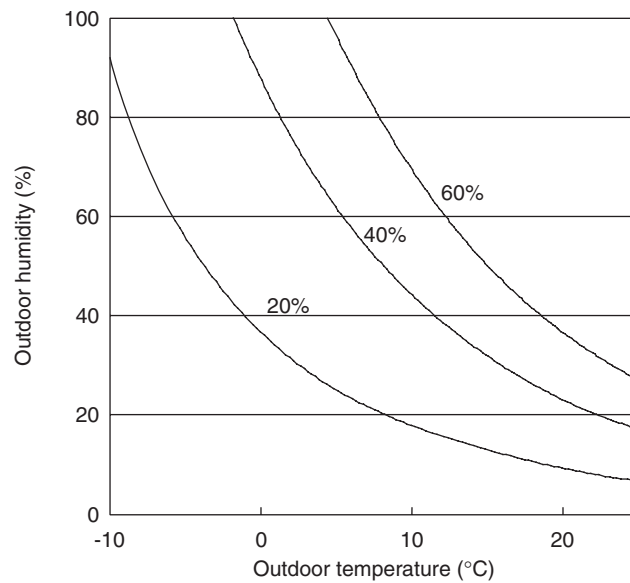

Condition;
 Model:FTXR42EV1B
 Indoor temperature setting:20°C
 Airflow rate:Max
 Room volume:100m³
 Air change rate:0.5/hour
 humidifying hose length:7.5m

(R5958)

50 class

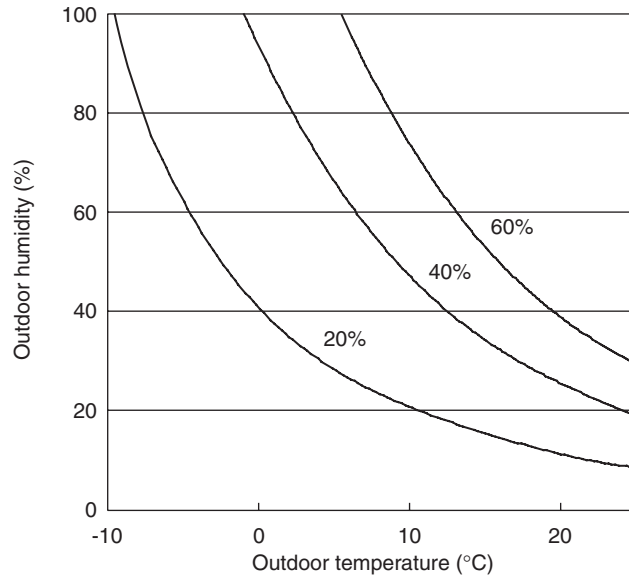

Condition;
 Model:FTXR50EV1B
 Indoor temperature setting:20°C
 Airflow rate:Max
 Room volume:120m³
 Air change rate:0.5/hour
 humidifying hose length:7.5m

(R5959)

Performance compensation by hose length

The max. piping length is set to 10 m, but the humidifying performance varies with the length of the humidifying hose.

When the hose length increases by 2 m, the humidifying capacity decreases by about 10%.

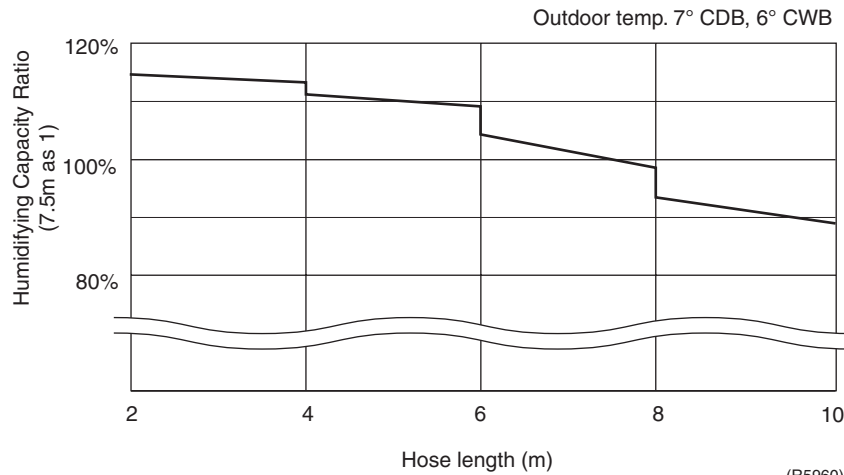

Outdoor temp. 7° CDB, 6° CWB

(R5960)

Reference

■ Room humidity (discharged air humidity) by ventilation cycle
(16m², hose length: 4m, 28 class)

1. Outdoor temp. 0°CDB, 50% RH

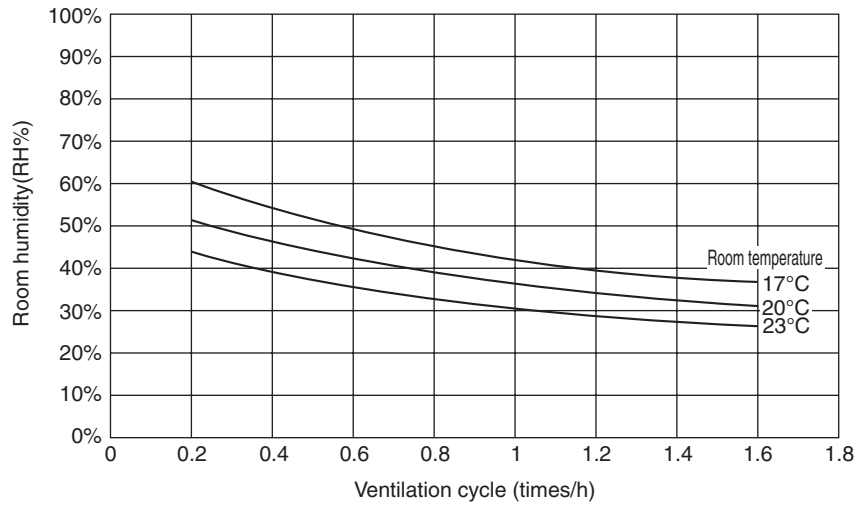

(R3335)

2. Outdoor temp. 7°CDB, 87% RH

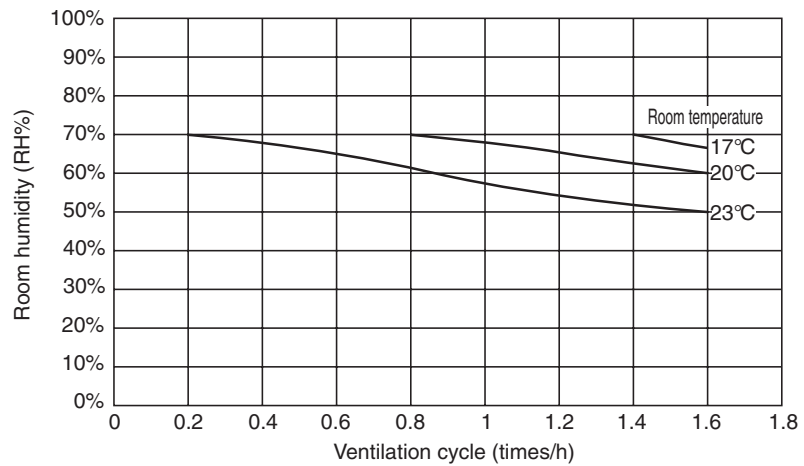

(R5088)

■ Room humidity (discharged air humidity) by outdoor temperature
(16m², hose length: 4m, ventilation cycle: 0.75 times/h, 28 class)

1. Room temp. 17°CDB

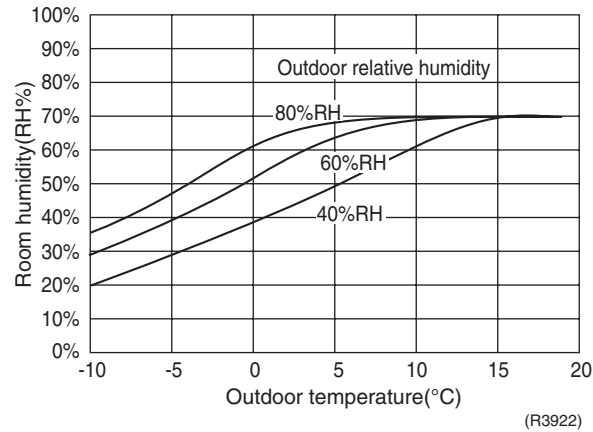

2. Room temp. 20°CDB

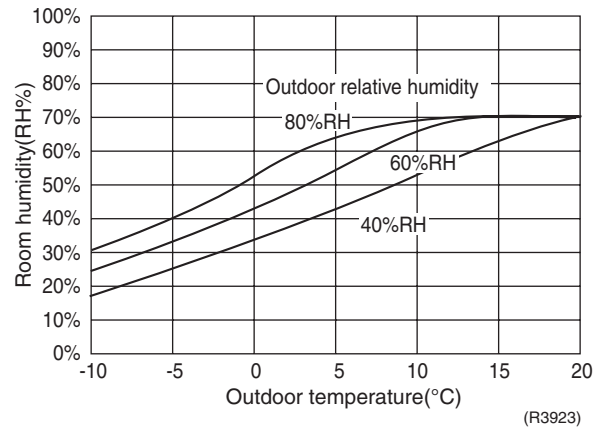

3. Room temp. 23°CDB

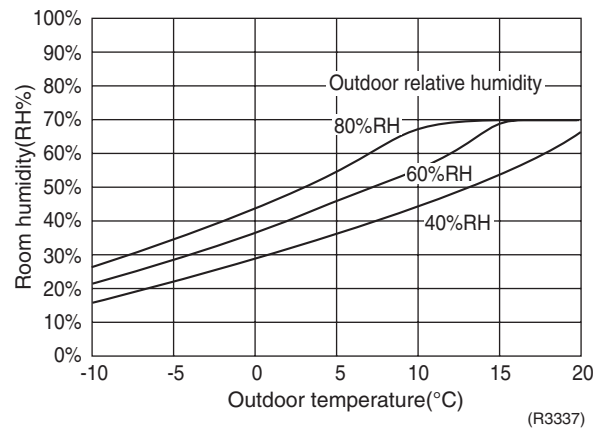

2.2 “SARARA” Drying Operation

Operation

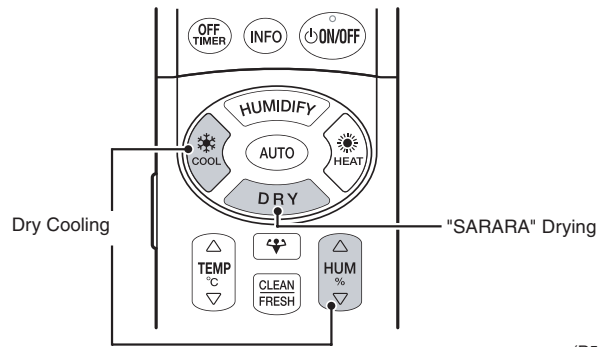

(R5961)

* Refer to the operation manual for details.

Features

■ **Reheating dehumidifying method is applied.**

Powerful evaporator eliminates the humidity in your room exclusively. Dry cool air is mixed with warm air from the reheater, thereby blowing in optimal and comfortable dry air.

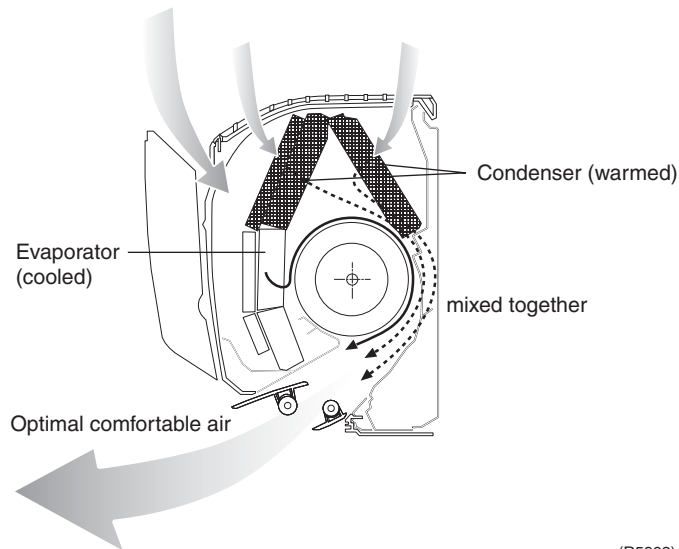

■ **Adjustable at your preferred humidity even on cooling**

You can get comfortable coolness even with the moderate cooling because you can adjust the indoor humidity as you like. By decreasing temperature difference to outdoors, it enabled to avoid a heat shock. It is recommended for ladies and elders who are sensitive to cooling and for families with a baby as well as energy saving.

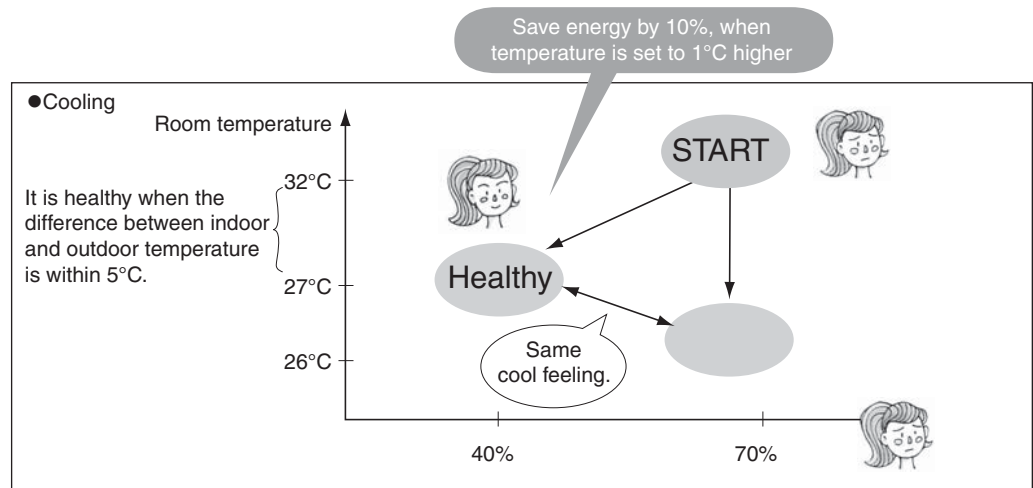

(R3340)

■ Differences on "SARARA drying" and "dry cooling" operation

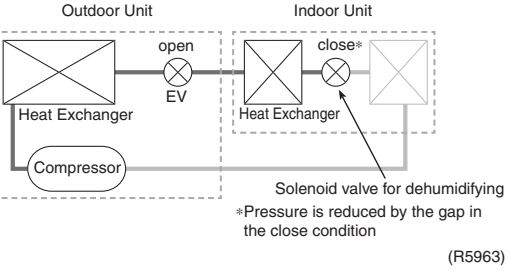
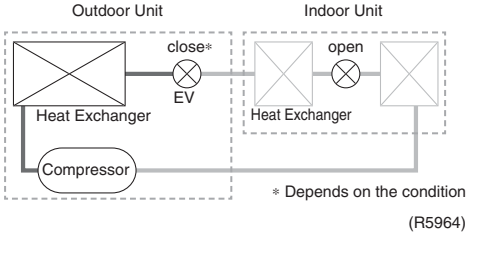
	"SARARA" Drying	Dry Cooling
Method	<p>Puts a pressure reducing device (solenoid valve) in the center of the heat exchanger of indoor unit to separate it into upper and lower side. The upper side acts as a condenser to heat the air.</p> <p>The heat exchanger in the lower perform the usual Dry Cooling Operation to make low-temperature and low-humidity air.</p> <p>The both types of air are mixed to make moderate-temperature and low-humidity air for blowing.</p>	<p>As is the cooling mechanism, the Dry Cooling Operation raises latent heat capacity with controlling sensible heat capacity by adjusting the compressor frequency and indoor air flow rate.</p>
Case by case use for dehumidification and cooling dehumidification	<p>As this is a reheating method, it is recommended in such a case to eliminate humidity without lowering room temperature as possible (this is recommended when cooling load is small).</p>	<p>The dry cooling does not use reheating method. In order to eliminate humidity, it is recommended to use at the set temperature lowered by several °C from the room temperature at operation starting up (this is recommended when cooling load is large).</p>
Mechanism	 <p style="text-align: right;">(R5963)</p>	 <p style="text-align: right;">(R5964)</p>
Humidity adjusting method	<p>Adjust by operation frequency of the compressor.</p> <p>When operation frequency increases, humidity falls, and when the frequency decreases, humidity fall is suppressed.</p>	<p>Adjust by operation frequency of the compressor and indoor air flow rate.</p> <p>When operation frequency increases and indoor air flow rate decreases, the humidity falls. When operation frequency decreases and the air flow rate increases, humidity fall is suppressed.</p>
Room temperature adjusting method	<p>Adjust by outdoor air flow rate.</p> <p>When outdoor air flow rate increases, room temperature falls, and when it decreases, room temperature fall is suppressed.</p>	<p>Adjust by operation frequency of the compressor.</p> <p>When operation frequency increases, the room temperature falls, and when operation frequency decreases, the room temperature fall is suppressed.</p>
Thermostat OFF condition	<p>When room temperature falls.</p> <ul style="list-style-type: none"> • Room temp. \leq preset temp.-2.5 or • Room temp. \approx preset temp. and the humidity is lower than target humidity (lower by more than 5%). 	<p>When room temperature falls.</p> <ul style="list-style-type: none"> • Room temp. \leq preset temp.-2.0 or • Preset temp.-1.5 < room temp. \leq preset temp.-1.0 continues for 10 min.
Thermostat OFF → ON condition	<p>When thermostat OFF condition is not satisfied</p>	<ul style="list-style-type: none"> • Room temp. \geq preset temp.-0.5 or • Preset temp.-1.5 < room temp. \leq preset temp.-1.0 continues for 10 min.
Time to reach the target humidity	<p>Approx. 1hour consecutive as a standard (depending on the conditions)</p>	<p>Approx. 1hour consecutive as a standard (depending on the conditions)</p>
Remarks (FAQ)	<p>The humidity does not decrease.</p> <p>According to the load conditions of your room, the temperature sometimes falls and thermostat ON/OFF repeats. As a result, the room may not be dehumidified enough. Set the temperature lower.</p>	<p>The humidity does not decrease. (Thermostat ON/OFF are repeated.)</p> <p>As the reheating method is not used, if you set the temperature close to the room temperature, thermostat ON/OFF are repeated according the load conditions of the room. As a result, the room may not be dehumidified enough. In cooling dehumidification mode, set the temperature lower than the room temperature by several degrees. If you do not want to lower the room temperature too much, reheating dehumidification operation method is recommended.</p>

2.3 Comfort Sleep Operation

Operation

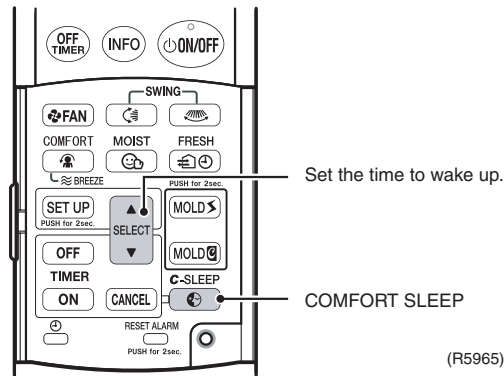

- Effective mode for COMFORT SLEEP operation
 - Cooling
 - Dry cooling
 - Moisture cooling
 - Heating
 - Humid heating
 - Moisture heating

* Refer to the operation manual for details.

Features

- Outline of function

The temperature is controlled in unique V-shape pattern within the range of about 2°C upper and lower. First the room temperature is gradually lowered at the beginning of sleep to induce the lowering of body temperature in sleeping.

Then, the room temperature is kept constant, and when the preset wake-up time approaches, the room temperature is gradually raised to induce the raising of body temperature before waking.
- V-shape pattern temperature control system
 - The air conditioner controls the room temperature showing V-shape pattern.

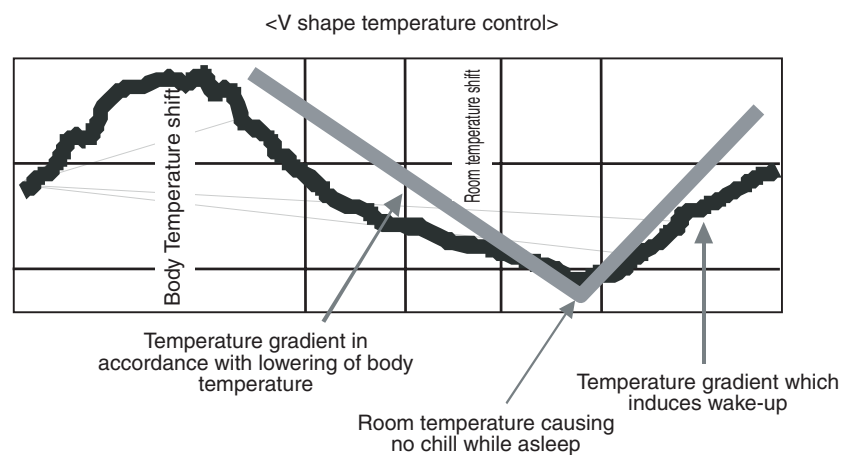

(R5089)

Change in body temperature in human sleep is controlled in ideal V-shape pattern by air-conditioner's temperature control.

(Reference: Control system adopted for JAL First Class flight)

- Human sleep
 - Sleep cycle and change in body temperature

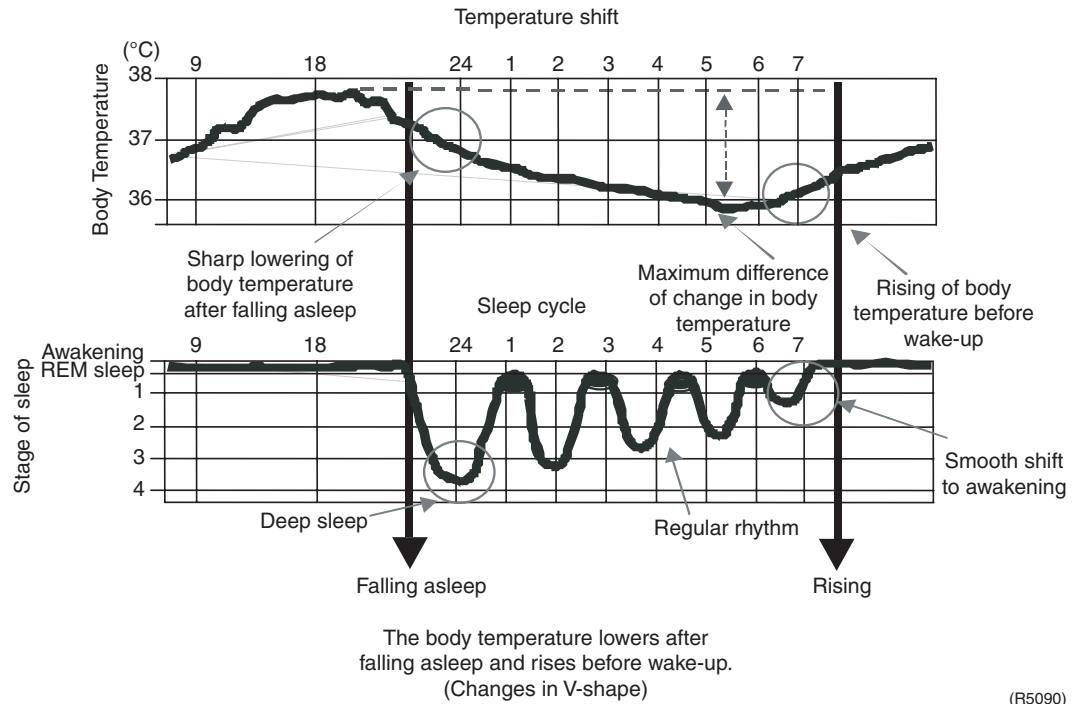

(R5090)

- Time chart of the V-shape comfort sleep control

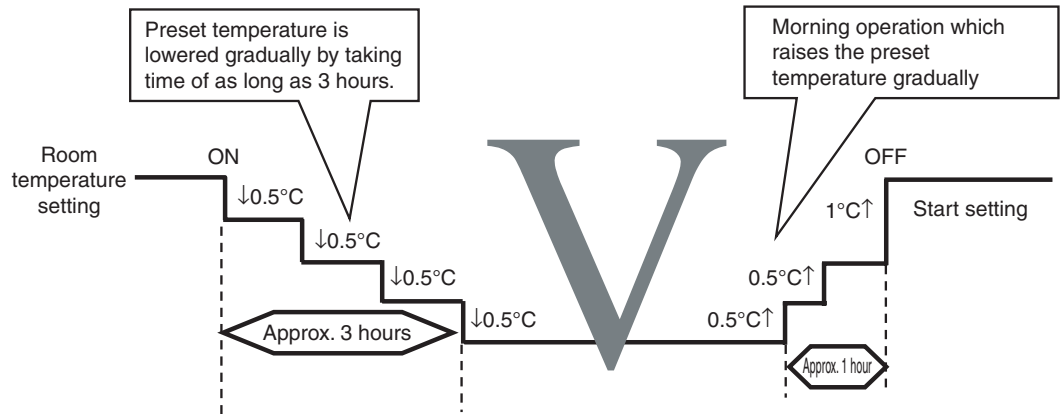

(R5091)

Reference

- Effect

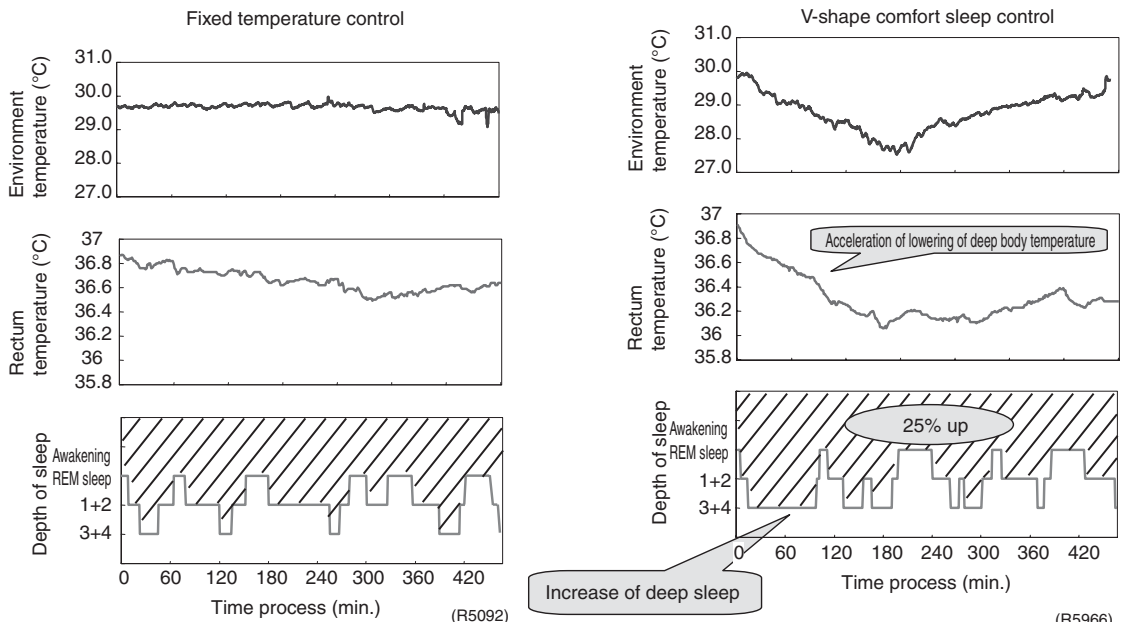

(R5966)

2.4 MOISTURIZING Operation

Operation

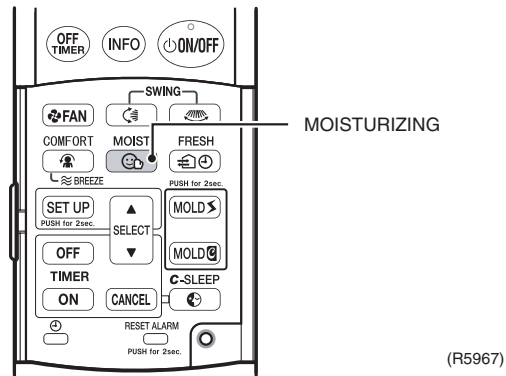

(R5967)

- Effective mode for MOISTURE COOLING
 - Cooling
 - Dry cooling
- Effective mode for MOISTURE HEATING
 - Heating
 - Humid heating

* Refer to the operation manual for details.

Features

- “Relatively high humidity” setting, “Comfort Airflow Mode” giving no airflow to the body, and “emission of vitamins and hyaluronic acid” --- These 3 types of operations are performed simultaneously to create skin-friendly environment.
- MOISTURIZING operation is to make the room condition friendly to your skin. It is not for beauty and beautiful skin treatment, and prevention of skin roughness.
- Details of operation

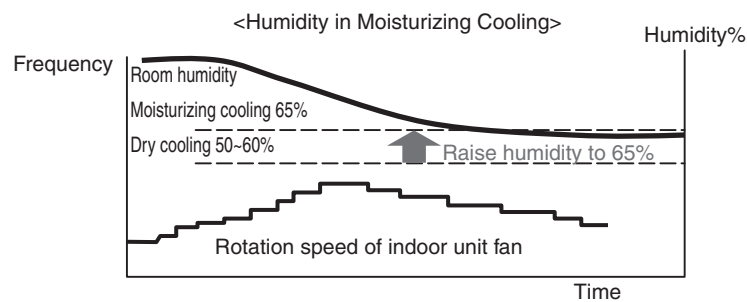

- Operation to keep the humidity 65%
- Being unlike ordinary dry cooling, it prevents the room from drying.

(R5093)

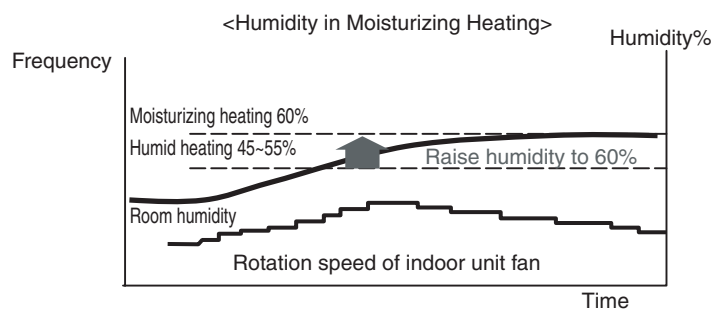

- Operation to keep the humidity 60%
- It creates a space more moisturized than by ordinary humid heating.

(R5094)

2.5 Automatic Operation

Operation

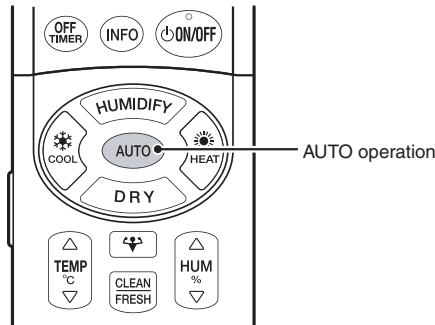

(R5985)

* Refer to the operation manual for details.

Features

When the AUTO mode is selected with the remote control, the microcomputer automatically determines the operation mode from cooling and heating according to the room temperature and setting temperature at the time of the operation startup, and automatically operates in that mode.

The unit automatically switches the operation mode to cooling or heating to maintain the room temperature at the main unit setting temperature.

Details

1. Remote control setting temperature is set as automatic cooling / heating setting temperature (18 to 30°C).
2. Main unit setting temperature equals remote control setting temperature plus correction value (correction value: 0 deg).
3. Operation ON / OFF point and mode switching point are as follows.
 - ① Heating → Cooling switching point:
Room temperature \geq Main unit setting temperature +2.5 deg.
 - ② Cooling → Heating switching point:
Room temperature $<$ Main unit setting temperature -2.5 deg.
 - ③ Thermostat ON / OFF point is the same as the ON / OFF point of cooling or heating operation.
4. During initial operation
 Room temperature \geq remote control setting temperature: Cooling operation
 Room temperature $<$ remote control setting temperature: Heating operation

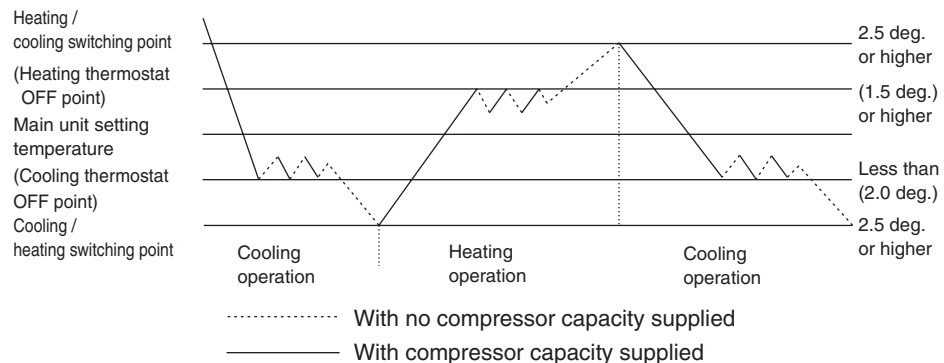

(R3302)

2.6 Comfort Airflow Mode

Operation

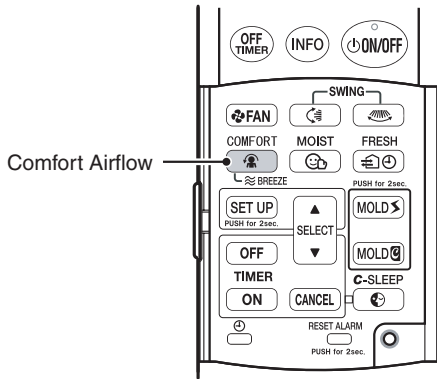

The indication will change every time “” is pressed.



(R5968)

- Effective mode for comfort airflow mode
 - Heating
 - Humid heating
 - Cooling
 - “SARARA” drying
 - Dry cooling
 - Moisturizing
- Flap motion
 - Upper and lower flaps halt at the fixed position of the upper side or lower side of the swing.
 - Left and right flaps move according to the settings of remote control.
- Airflow rate
 - Airflow rate is at “automatic”.

* Refer to the operation manual for details.

Features

- **Draftless operation prevents direct blow to human**
 Draftless operation sustains direct blow to skins. Cool air is blown up in the room and changed into slow downward flow, circulating into entire room. Meanwhile the warm air is blown down vertically to our foot, warming the room from the floor.
 - Feel cold on cooling operation
 - When comfort airflow mode is carried out in cooling . . .

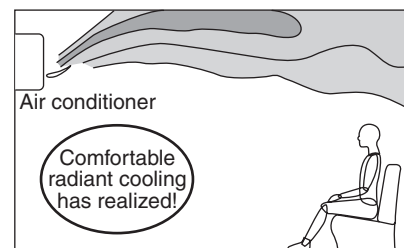
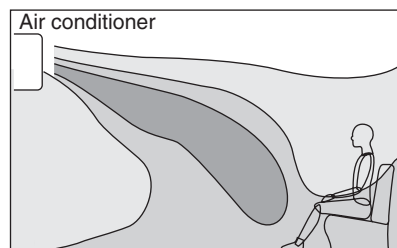

(R3355)

■ Feel air on heating

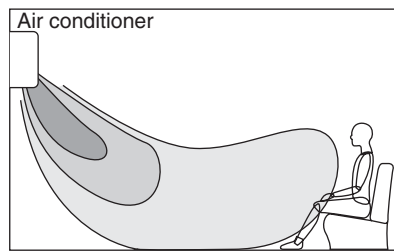

■ When comfort airflow mode is carried out in heating . . .

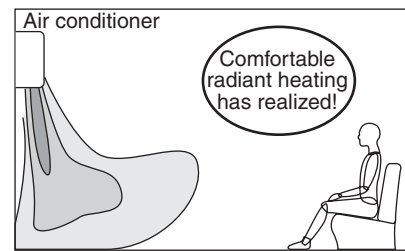

(R3356)

**Note**

In heating operation, it takes time to transmit heat to a distant place because the airflow direction is controlled not to blow direct on human. It is recommended that this operation mode is used after the room has been warmed up.

2.7 Cooling Breeze Operation

Operation

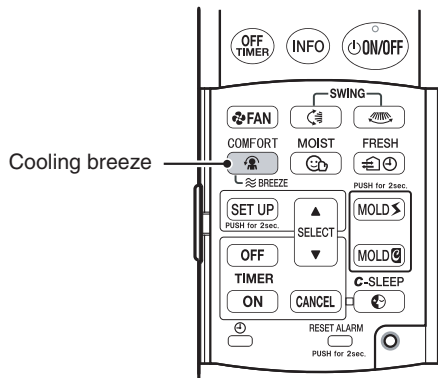

The indication will change every time “” is pressed.



(R5969)

- Effective mode for cooling breeze airflow
 - Cooling
 - “SARARA” drying
 - Dry cooling
 - Flash streamer air purifying



Note

On automatic mode, when actual operation mode is heating, this cool air fluctuation operation does not work. (Indication on remote control is shown.)

- Flap operation

As shown in the graph above, the standard point is the upper limit of the swing so that the air do not touch directly.

Depending on the room temperature or the thermostat on/off state, swing interval is changed.

(The lower the temperature, the longer the swing interval, thereby comfort is maintained.)

Left and right flaps move as set at the settings of remote control.
- Airflow rate

Airflow rate is controlled automatically.

* Refer to the operation manual for details.

Features

■ 1/f fluctuation rhythms switches air flow direction

By fluctuating air flow direction you can feel cool even the room temperature is set rather high.

By 1/f fluctuation rhythm, upper and lower flaps move up and down unlike the conventional up and down swing, and this movement brings you a comfortable air like a breeze in nature.

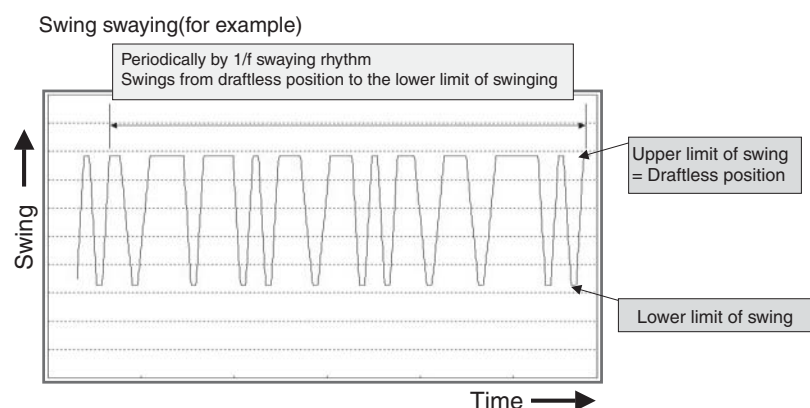

(R3357)

2.8 Power-airflow Dual Flaps

- Triple air flow by the combination with wide-angle louvers

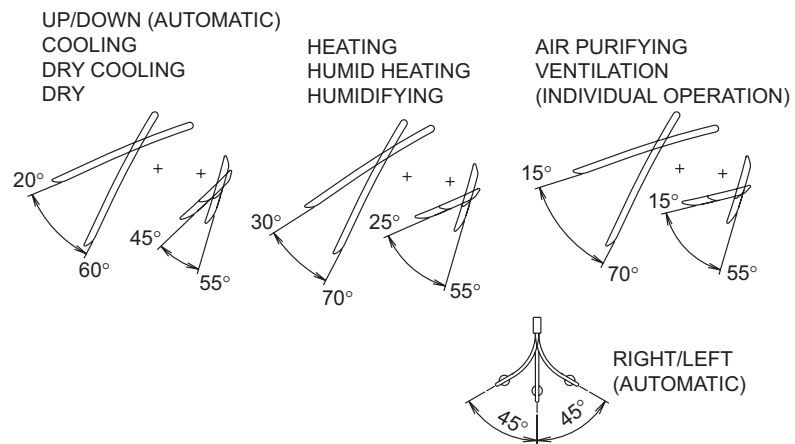

(R5970)

2.9 Wide-angle Louvers

Wider airflow eliminates disagreeable irregular temperature distribution.

For the right and left flaps, the wide-angle louver which produces wider airflow is adopted. Since it veers flexibly and swings horizontally at a wide angle, comfortable airflow spreads to every corner of the room.

■ Wide-angle Louvers

Direction of airflow changes greatly along the shape of curved vane.

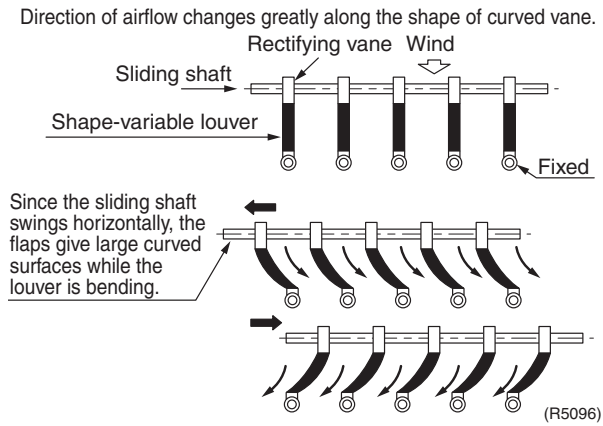

■ Flap angle

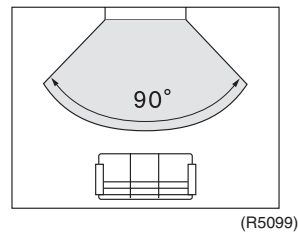

- It can send the airflow to the center of the room even when the air-conditioner is installed at a corner of the room.

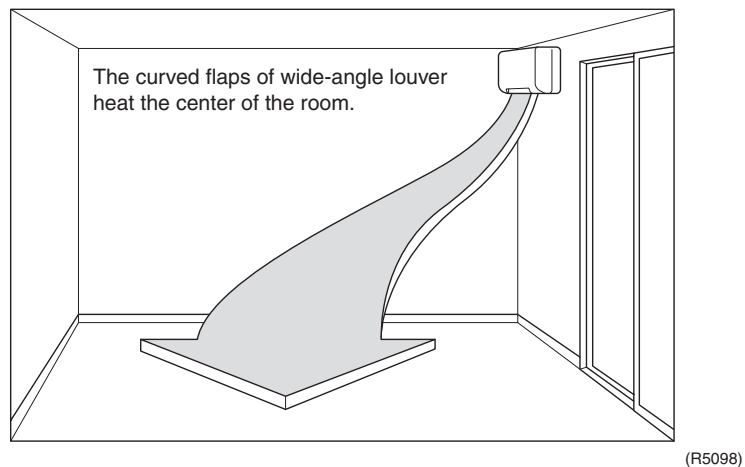

2.10 3-D Airflow

Alternative swing of flaps in vertical and horizontal directions circulates the airflow to every corner of the room and prevents uneven temperature distribution.

Use of the 3-D airflow control prevents uneven temperature distribution in the whole room. Particularly, the comfortable zone 10 cm above the floor is widened 1.5 times of the conventional zone.

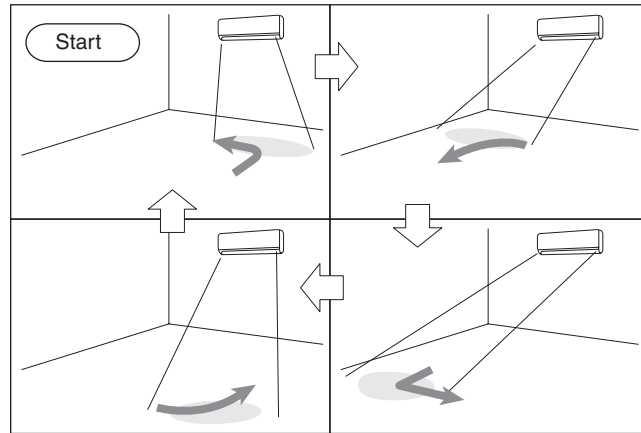

(R5102)

- If it is used at the start of operation, a flow of draft may feel you chilly.
- It is recommended to use it after the room temperature is stabilized.

2.11 POWERFUL Operation

Operation

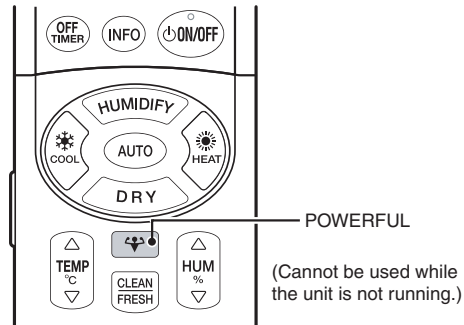

(R5971)

- Effective mode for POWERFUL COOLING
 - Cooling
 - Dry cooling
 - Moisture cooling
- Effective mode for POWERFUL HEATING
 - Heating
 - Humid heating
 - Moisture heating

* Refer to the operation manual for details.



Note

- Operating sound becomes slightly loud.
- It is impossible to change the airflow rate, temperature, and humidity.

Features

The airflow rate and the compressor rotating speed are increased from the normal operation for 20 min. This operation is convenient when you just come back home. (Normal operation will be resumed automatically in 20 min.)

2.12 Indoor Unit Quiet Operation

Features

Forced dropping of the fan tap decreases the airflow rate and reduces airflow noise. (Noise is reduced by about 3 dB as compared to that in L tap.)



Note

- Airflow rate can not be set.
- Since the performance is somewhat lowered as compared to that in normal operation (70% under rated conditions), the room may not be cooled (or heated) when this operation is used for a long time.
- The indoor unit quiet operation is kept in memory even when the power supply is turned OFF.
The indication remains on the display of the infrared remote control and the indoor unit quiet operation works when the power is turned ON again.

2.13 Multi-colored Indicator Lamp

Features

Current operation mode is displayed in color of the lamp of the indoor unit which changes in 8 colors. Operating status can be monitored even in automatic operation in accordance with the content of actual operation.

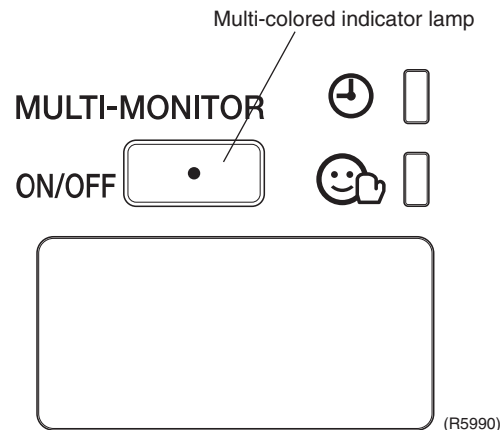

- The lamp color changes according to the operation.
 - HEATINGRed
 - "URURU" HUMIDIFYING / HUMID HEATINGOrange
 - COOLINGGreen
 - "SARARA" DRYING / DRY COOLINGYellow
- The lamp color also changes according to the optional function.
 - FLASH STREAMER AIR PURIFYING/ FRESH AIR SUPPLY VENTILATIONWhite
(Only for the first 2 seconds during operation of the air conditioner.)
 - MOLD PROOFPurple & blue → Blue & light blue → Light blue & white → White
 - MOLD SHOCKBlue & light blue & white

2.14 Monitor Brightness Setting

The brightness of the multi-colored indicator lamp can be adjusted HIGH, LOW, or OFF. It is convenient when it is excessively bright while asleep.

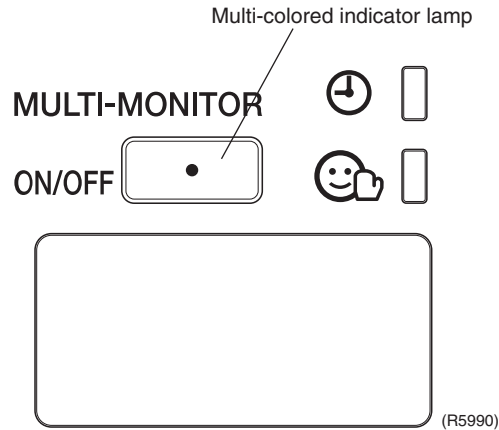

* Refer to the operation manual for details.

2.15 Information Display

Operation

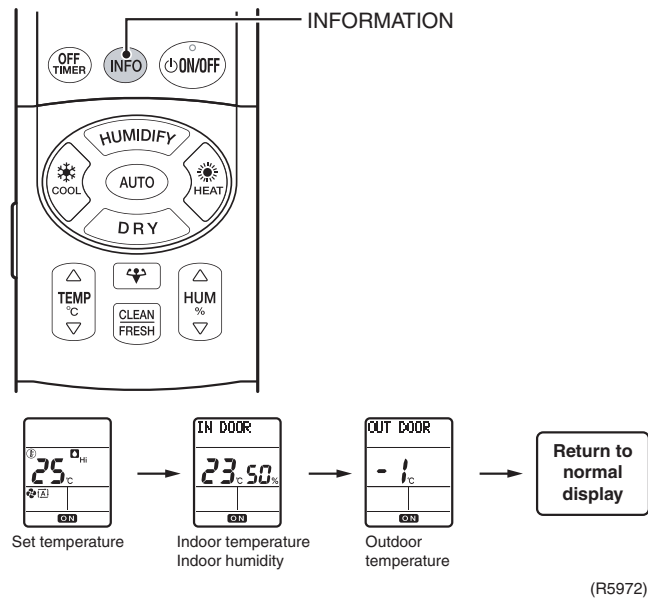

* Refer to the operation manual for details.

Features

- Room temperature, indoor humidity, and outdoor temperature are displayed.
- Point the remote control at the indoor unit for 2 seconds.



Note

- Outdoor temperature during operation may be displayed relatively high in cooling or “SARARA” drying, and relatively low in heating (particularly when the outdoor unit is frosted) by influence of air blown out from the outdoor unit and temperature of the heat exchanger.
- Lowest displayable outdoor temperature is -9°C. Even if the outdoor temperature is lower than this, “-9” is displayed. Highest displayable outdoor temperature is 39°C. Even if the outdoor temperature is higher than this, “39” is displayed.
- Displayed temperature and humidity are those near the sensor.
- Displayed temperature or humidity may be different from the actual temperature or humidity depending on the conditions of indoor unit and outdoor unit installation (due to obstacle near the sensor or influence of direct sunlight). Take it as a rough standard.

2.16 MOLD PROOF Operation

This is an integrated naming of functions such as inside drying, moist air exhaustion, mold-prevention stick. Drying inside the air conditioner prevents mold or odors to be generated.

Operation

Operation can be selected from automatic / manual.

- Auto operation
(approximately once every 2 weeks)
If the unit is set to "MOLD PROOF ON", the MOLD PROOF operation will start automatically after the unit has been run in "SARARA" DRYING or COOLING mode, depending on the amount of time the unit has been run (approximately once every 2 weeks.)
The default is set to "MOLD PROOF OFF".
- Manual operation

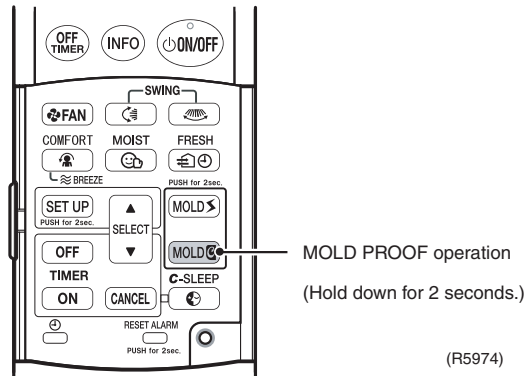

(R5974)

* Refer to the operation manual for details.

Features

■ Time chart

Operation runs about for 3 hours while changing colors of the multi-colored indicator lamp.

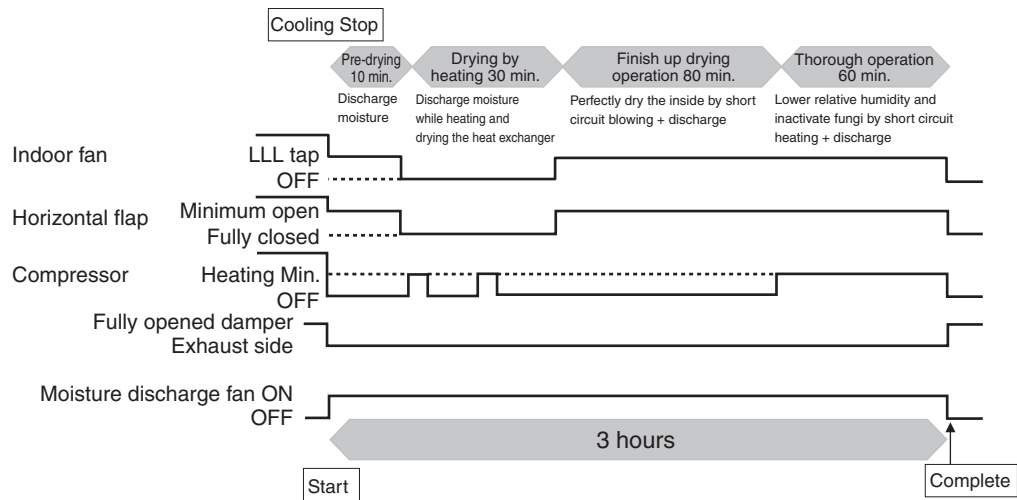

(R5973)

Inside Drying

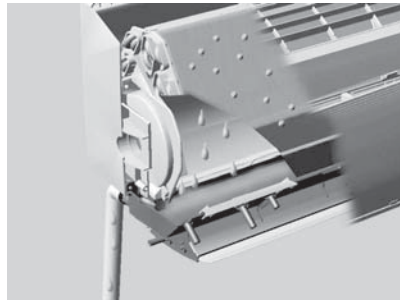

1. Drained water discharge
Drained water in drain pan is discharged.



2. Inside drying operation
After the drained water discharged, the moisture etc. which are left on drain pan or heat exchanger are dried by evaporation.

Exhausting Moisture

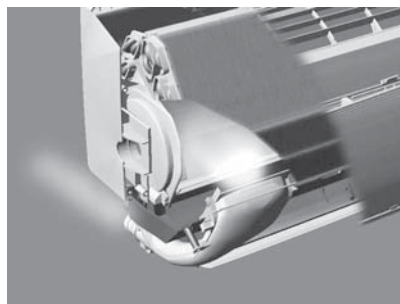

3. Moisture exhaustion
Exhaust moisture to outdoors using the humidification hose.

■ Switching air supply / exhausting

We have developed this function on a damper inside the humidification unit, by leaving conventional air intake fan in place that supplies air from outdoor to indoor as it is.

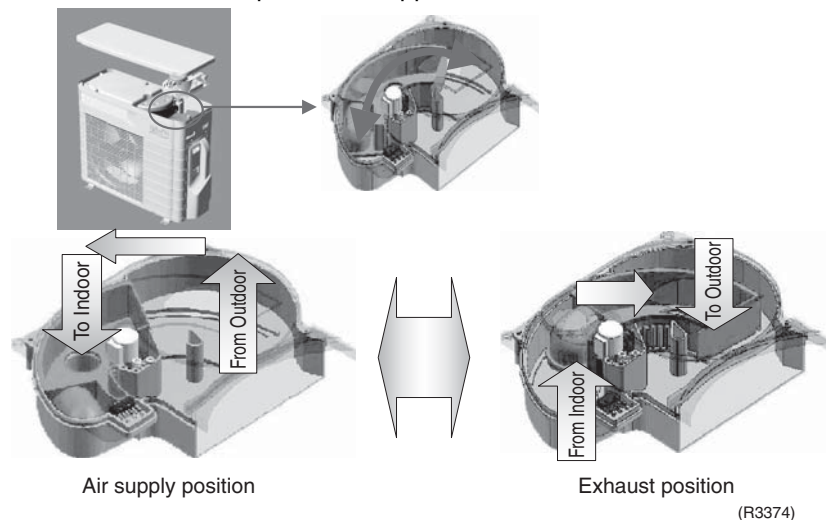

■ Condition for operation

1. Accumulated operation time: 21,600 min. (approx.15 days)
 2. Accumulated cooling/dehumidifying operation time: 5,400 min. (approx.15 days x 6 hours)
- This function starts when both conditions are met.

i Note

- This is not the function for eliminating dust or mold attached inside the air conditioner.
- During operation, smells may occur.
- This function sometimes does not begin when outdoor temperature or indoor humidity is extremely high.
- Depending on the temperature conditions, moisture exhaustion function is not carried out.

2.17 Mold Proof Stick

Features

- Drain pan which prevents mold proliferation

The drain pan of the main unit which easily goes moldy is equipped with a “Stick” having mildew-proof, antibacterial and antivirus effect.

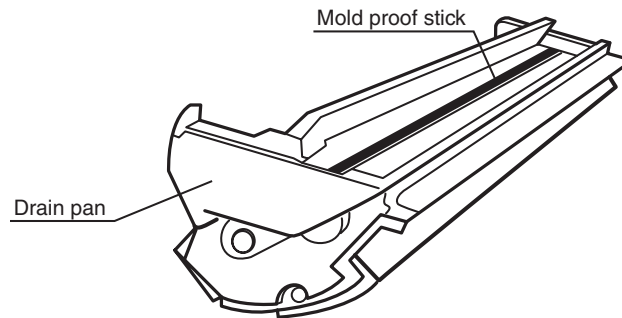

(R5104)

Since mildew-proof, antibacterial and antivirus agent of silver group which is the compound of highly safe titanium oxide and silver is used as a single agent, drain water is not affected by this agent.

The mildew-proof, antibacterial and antivirus agent is applied to a stick which is covered further with extremely thin resin skin of several microns (resin section without mildew-proof agent on the surface of the resin). The active ingredient is dissolved gradually for about 10 years by immersion and penetration of stick and drain water. Thus, the stick continues working.

- Image

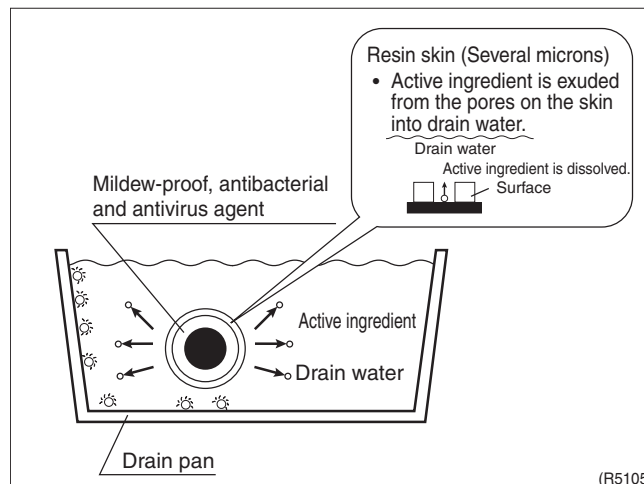

(R5105)

- * The efficacy of the stick has been proved by Hallo's Method test conducted at Kyoto Microbiological Research Center.

2.18 MOLD SHOCK Operation

The room is kept clean by removing excessive moisture by rapidly lowering the humidity in the room for 1 hour, and keeping operation for 2 hours (total 3 hours).

Operation

It is not self-starting operation.

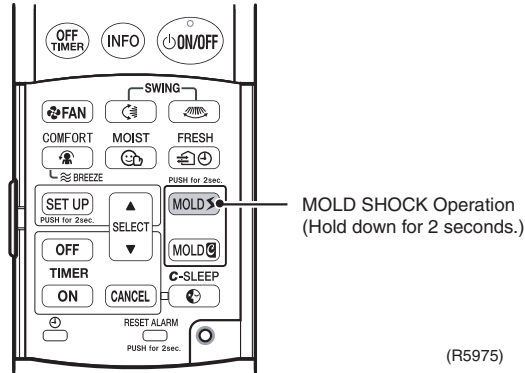

(R5975)

* Refer to the operation manual for details.

Features

■ Dry shock method (Mold Shock Operation)

Method to prevent the generation of mold by suddenly drying the humid environment. It is generally said that the growth of mold can be prevented by lowering the humidity to half and continuing the operation for 3 hours.

Mold before mold shock operation

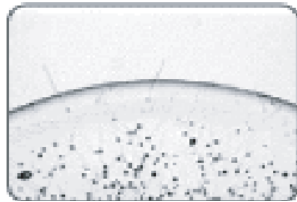

Without mold shock operation

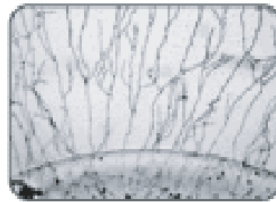

With mold shock operation

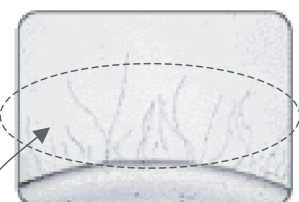

The test was conducted at DAIKIN's lab with use of the mold sensor of Environmental Biological Research Institute.

Fewer molds grow as compared with in the case without Mold Shock Operation.

(R5107)

■ Time chart

- Operation runs about for 3 hours in total while changing colors of the multi-colored indicator lamp.
- Reheating dehumidifying which dehumidifies continuously.

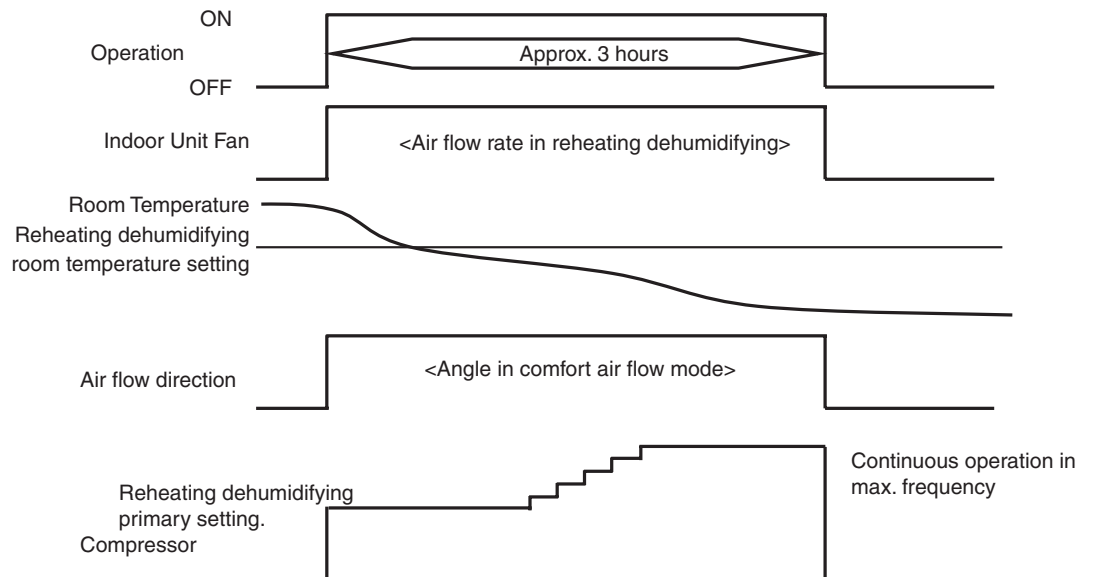

<Note> The room temperature becomes about 5°C lower than the temperature at the start of operation.

(R5108)

■ Comparison with cooling operation and mold shock operation

Normal cooling operation
The humidity in the room returns to original level when cooling operation is stopped.

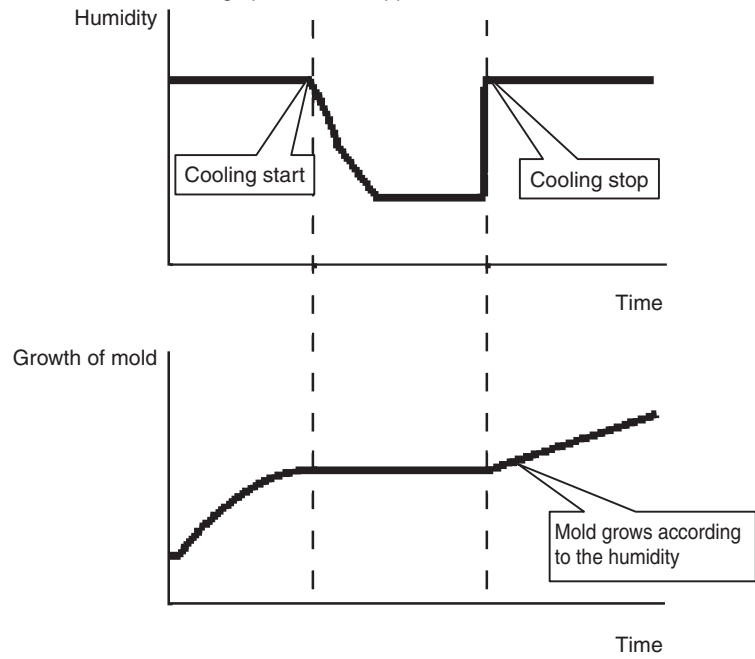

(R5109)

Mold shock operation after cooling
The humidity in the room is lowered suddenly by Mold Shock Operation.

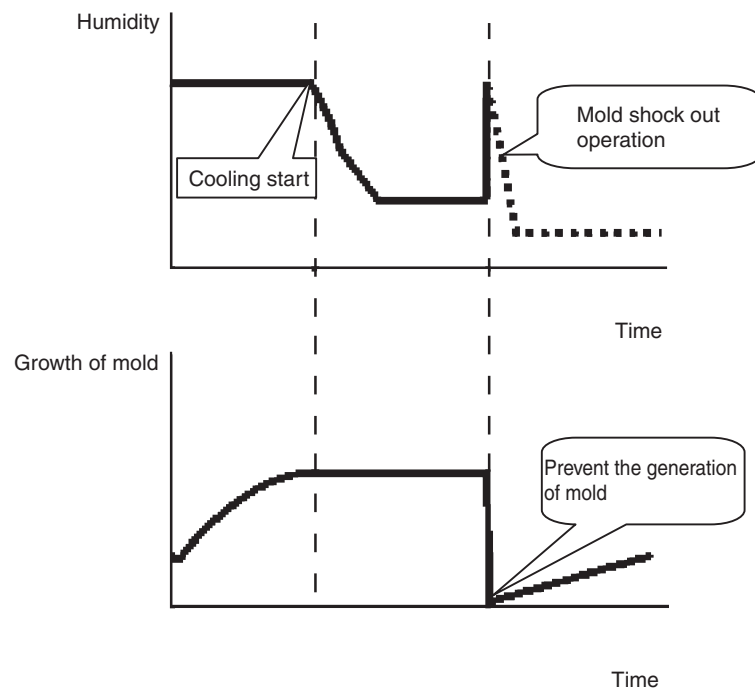

(R5110)

Reference

■ Effect

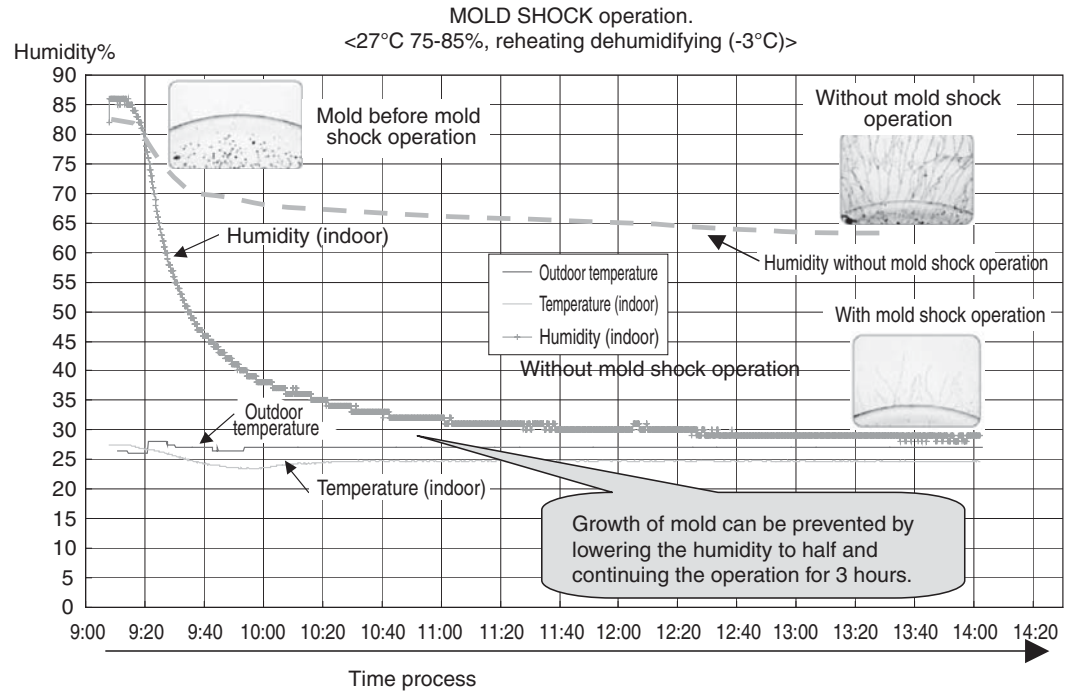

(R5112)

2.19 HOME LEAVE Ventilation

Operation

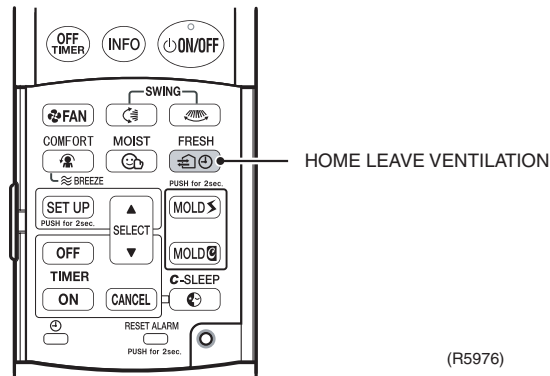

* Refer to the operation manual for details.

■ Ventilate your room while you are out

This function refreshes your room by ventilating while you are out.

■ Operation

- To take a fresh air from outdoors via outdoor unit, air is heated with a heater on humidification unit contained in the outdoor unit to decompose exhaust gas components (NO_x) and the like, and passed through air intake filter to eliminate pollens and mold.
- OFF timer allows to set operation time ranging from 1 to 9 hours (Factory set: 4 hours).



Note

1. Outdoor sound may be heard or air may have a smell, as the air is taken from outdoors. Compared with the other operations, operating sound is rather high.
2. According to the outdoor temperature/humidity operating sound sometimes changes.

2.20 FLASH STREAMER AIR PURIFYING Operation

Operation

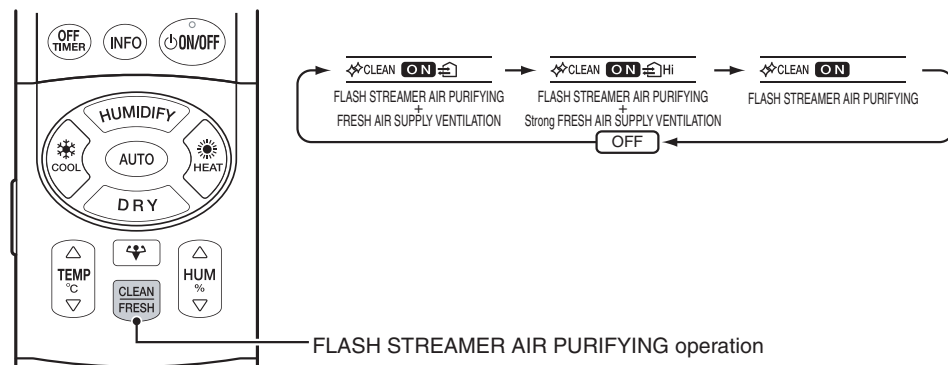

(R5980)

* Refer to the operation manual for details.

■ Flash Streamer Air-Purifying

The technology for the real air purifier is adopted for the air conditioner. Our original technology “Flash Streamer” system used for our Daikin’s air purifiers is incorporated. This technology realizes the air purifying exceeding far from the air purifying performance of the normal air conditioner.

Powerfully analyses and removes the diesel dust, NOx, mold, virus, etc.

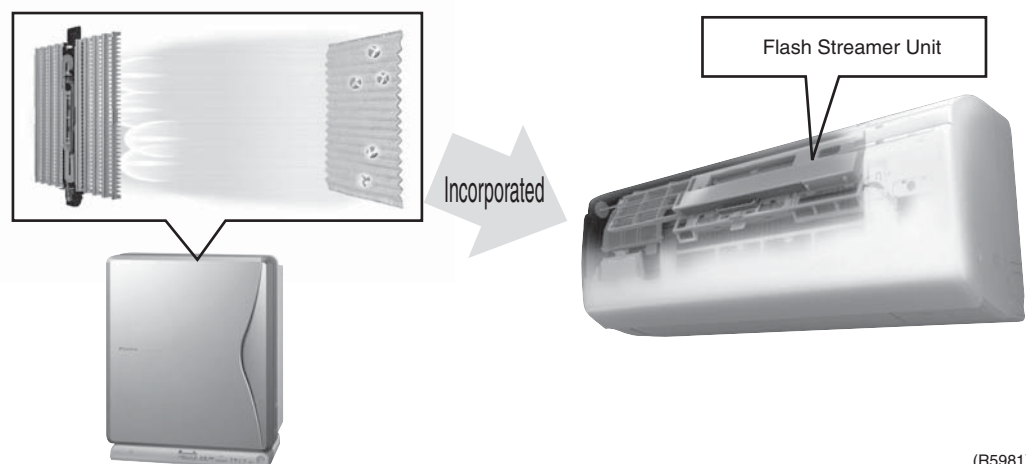

(R5981)

■ Mechanism of Flash Streamer Air-Purifying

The streamer discharging high energy electron analyzes and removes powerfully odor, unwanted bacteria and hazardous chemical materials at the oxidative distraction speed of 1000 times higher than the generally used glow discharge.

Air purification flow

New air purification system incorporating the streamer (Image)

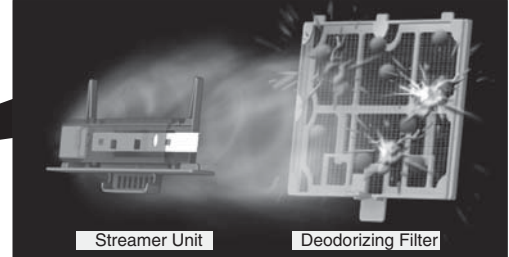
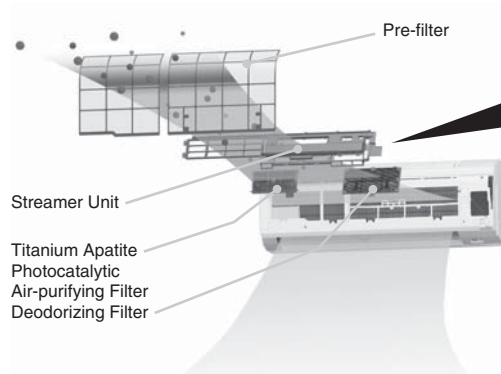

Powerfully decompose and remove molecules of allergens or odors by collision with high-speed electrons discharged from streamer unit.

(R5982)

■ Removing Formaldehyde

Analyzing and removing the building material odor powerfully

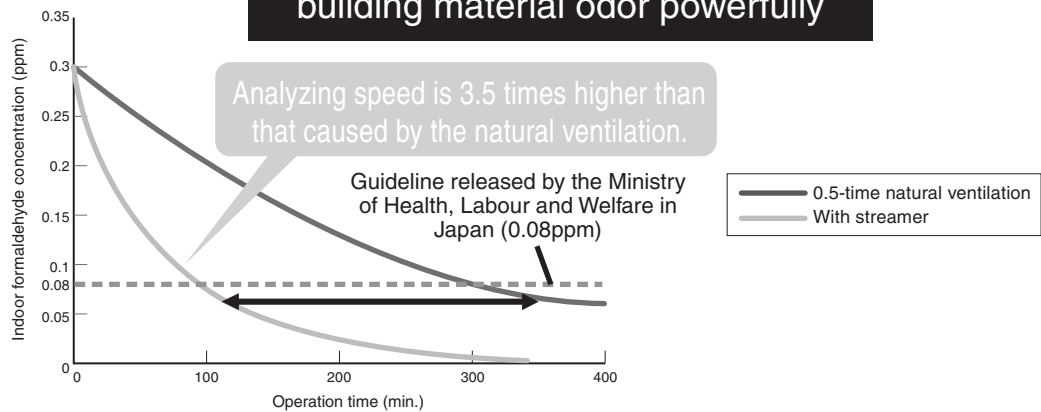

The formaldehyde concentration in the laboratory (10 m²) at 0.5-time ventilation and the initial concentration setting of 0.3 ppm (Observed by Daikin using the FTXR28E) (Nozaki laboratory, Graduate Course of Health and Society System, Tohoku Bunka Gakuen University)

(R5983)

■ **Deodorizing Performance of Flash Streamer and Titanium Apatite Photocatalyst**

Unpleasant odor daily generating in the room such as pet odor or garbage odor is powerfully removed. Speedy deodorization: 90% or more odor has been removed in 10 minutes. Cigarette odor of 80% or more has been removed.

Daily odor removal performance by streamer air purifying (%)

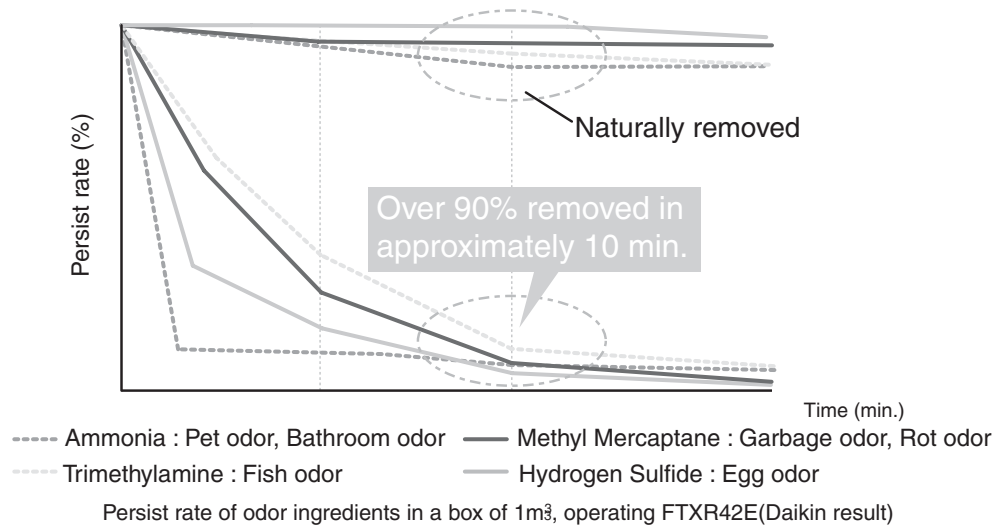

(R5984)

	Ammonia	Acetaldehyde	Acetic Acid	Cigarette Odor
Removal	90.6%	76.5%	87.2%	82.7%

2.21 Fresh Air Supply Ventilation

Operation

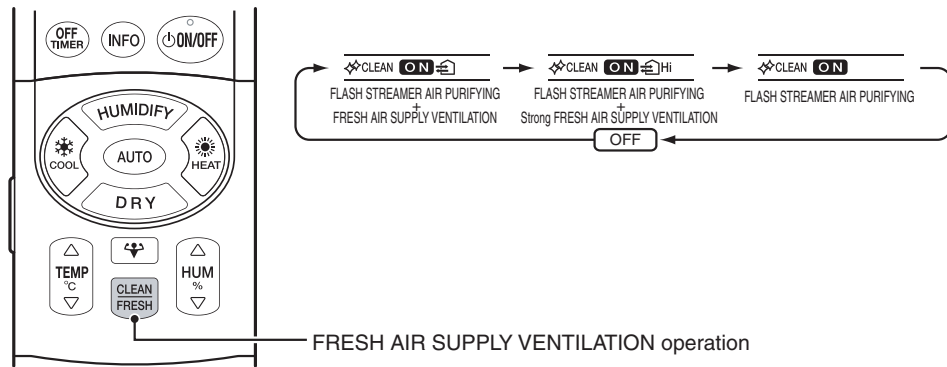

(R5977)

* Refer to the operation manual for details.

Features

■ Air Supply Ventilation

The air supply ventilation system using only fresh air.

Any contaminated outdoor air is purified in two stages of indoor unit and outdoor unit. Fresh air from which bacteria were removed is supplied into the room.

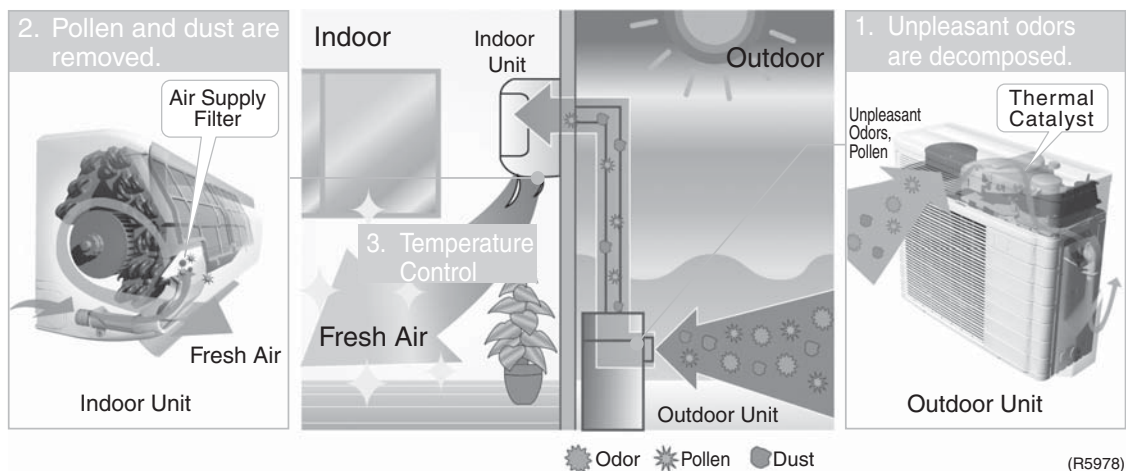

(R5978)

1. Purifying air in the outdoor unit

Thermal catalyst containing in the humidifying rotor analyzes unpleasant odor and also removes exhaust gases (NO_x, SO_x).

Manganese catalyst used to treat the automotive exhaust gas is adopted for the thermal catalyst.

2. Purifying air in the indoor unit

The air supply filter is placed at the humidifying hose outlet of the indoor unit side. The air supply filter removes about 97% pollen and dust.

3. Controlling temperature

The fresh air passed through the air supply filter is cooled (or heated) in the indoor unit and supplied into the room.

You can keep comfortable temperature and also replace air because the ventilation is performed while temperature is controlled.

Pollen, exhaust gas and odor that could not be removed by the thermal catalyst and air supply filter will be analysed by the flash streamer and photocatalyst.

■ Ventilation System

The ventilation type is mainly divided into two. The convenient system is supply ventilation.

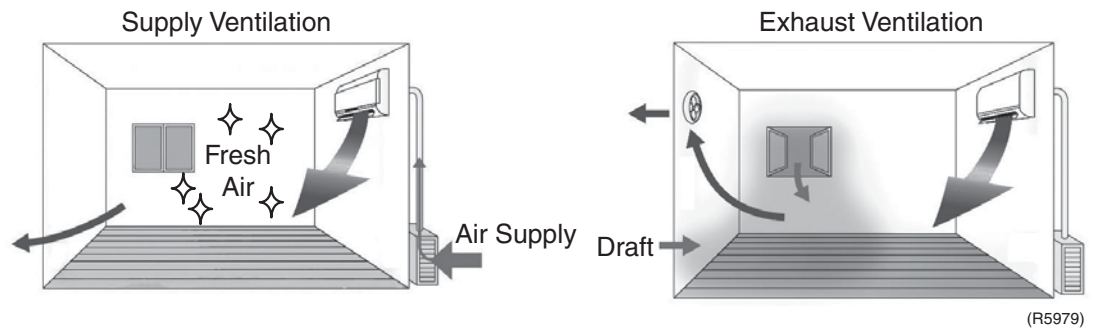

- | | |
|--------------------------------------------------------------------|--------------------------------------------------------------------------------|
| - Quiet because the ventilation fan is located in the outdoor unit | - Operation noise is heard because the ventilation fan is located in the room. |
| - Energy saving system due to low heat loss | - Electricity charges are high because heat loss is high. |
| - The room temperature changes little because no wind enters | - Draft enters easily to prevent comfortable temperature from being kept. |

2.22 Wipe-clean Flat Panel

It wipes off dirt in an instant. The grill-less panel is easy to clean and can be dismantled easily for washing.

Dismount the panel in the procedure as mentioned below, wipe it lightly with soft cloth impregnated with lukewarm water or cold neutral detergent solution and dry it in the shade.

Note: If it is washed with use of polishing powder or scrubber, or in the water hotter than 40°C, it may be scratched, discolored or deformed.

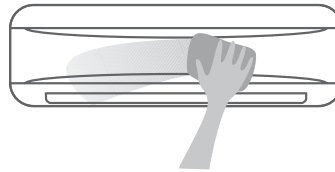

(R5115)

- Caution
 - When mounting or dismantling the front panel, use a robust and stable stand and watch out your step.
 - Proceed to work while supporting the front panel securely by hand.
 - Do not use the water hotter than 40°C, benzine, gasoline, thinner or other volatiles, polishing powder or scrubber.
 - Make sure that the front panel is mounted securely.

2.23 Filter Cleaning Indicator (remote control)

When the unit is operated for about 2 weeks (about 340 hours), the filter cleaning indication appears to inform you that the time of maintenance comes.

If the filter is left dirty, the power consumption increases by about 10%. It is recommended to maintain it periodically for energy-saving operation.

- How to reset the filter cleaning indicator

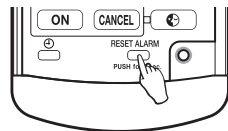

When the "RESET ALARM" button of the remote control is kept pressed for about 2 sec. toward the air-conditioner main unit after maintenance of the filter, the filter cleaning indication disappears.

(R5118)

2.24 TIMER Operation

2.24.1 24-hour ON/OFF Timer

Operation

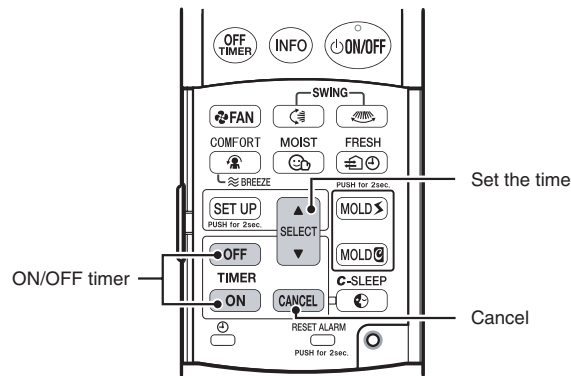

(R5986)

* Refer to the operation manual for details.

Features

- Time can be set in the unit of 10 min.
- When the 24-hour ON/OFF is set, the indication of present time disappears.
- Time is kept in memory in the next operation unless it is cancelled.
- The clock error is ± 30 sec. per month.

ON Timer

The microcomputer monitors the indoor temperature and outdoor temperature before preset time and the operation is started automatically 1 hour before at maximum so that the room temperature becomes optimum at the preset time.

2.24.2 COUNTDOWN OFF Timer

Operation

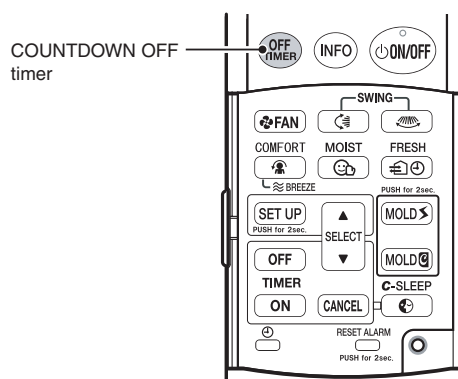

(R5987)

* Refer to the operation manual for details.

Features

- The COUNTDOWN OFF timer sets the time by simple button pressing. The operation is stopped when the set time comes. The time can be set in the unit of 0.5 hour for maximum 9.5 hours. It can be used in combination with the ON timer.

2.24.3 Combination of ON Timer and OFF Timer

- ON timer and OFF timer, or ON timer and COUNTDOWN OFF timer can be used in combination.
Refer to the operation manual for details.

2.25 Night Set Mode

- When you set the COUNTDOWN OFF TIMER or OFF TIMER, the unit is operated automatically in night set mode.

Cooling / Dry cooling

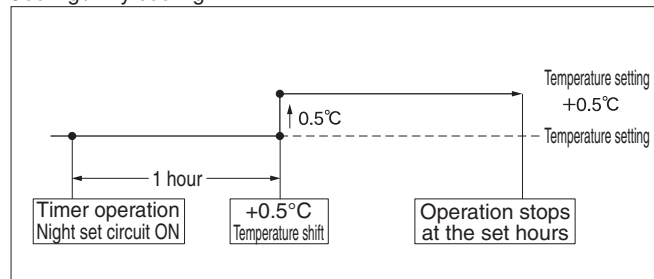

(R5123)

Heating / Humid heating

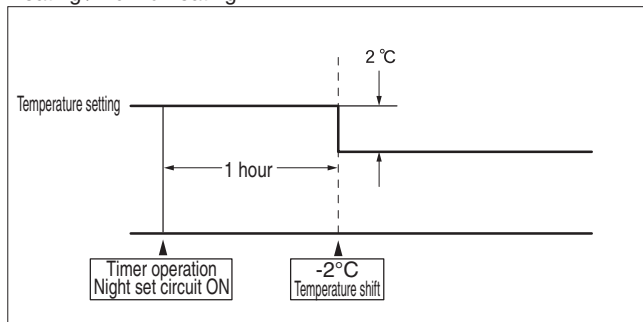

(R5124)

2.26 Table for Special Modes

■ Operation of indoor unit ON/OFF button and buttons of remote control

To enter a specific mode, press one of the buttons below for more than 5 sec.

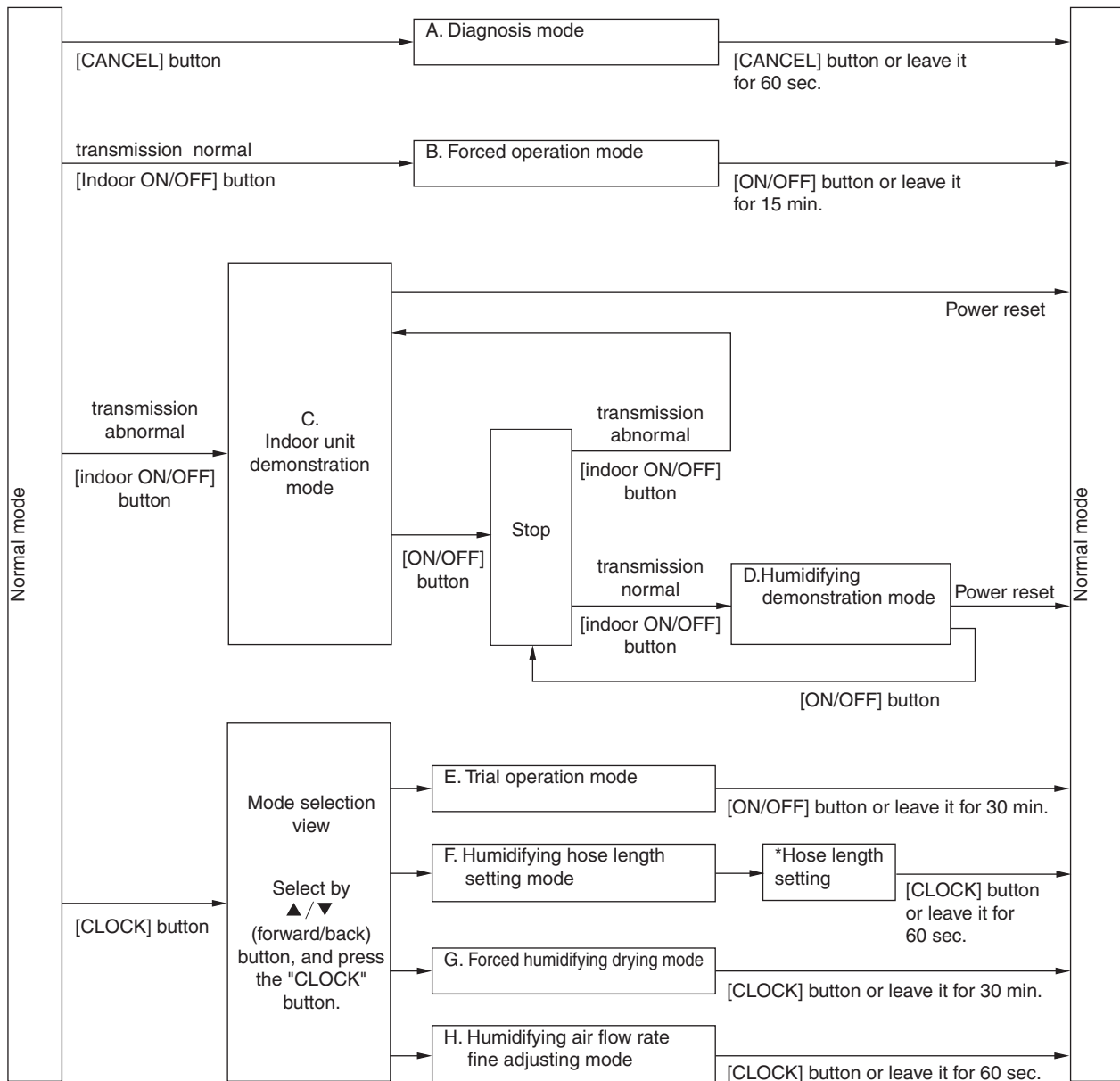

(R6029)

- A. Diagnosis mode is improved to enable one-touch indication by applying two-way communication.
- B. Forced operation mode is the same as the conventional one. (But buzzer beeps, timer and multi-monitor illuminate)
- C. In indoor unit demonstration mode, the color of multi monitor changes regularly and the sequence of events (front panel open → flaps swing → front panel close) repeats. It takes about 10 minutes for 1 period.
- D. In humidifying demonstration mode, the color of the multi-colored indicator changes regularly.
Select "URURU" HUMIDIFYING or HUMID HEATING for demonstration.
(This mode can be used for demonstration of humidification operation at shops.)
- E. Trial operation mode is improved in such a way that the conventional 3 buttons to be pressed simultaneously are integrated into one button.
The time to start compressor can be set by "▲ (forward)" button by 0 min., 1 min. or 3 min. later.
Select the desired operation mode to start operation.

- F. For humidifying hose length setting(*)
- G. In forced humidifying drying mode, drying operation continues for approx. 30 min. for service.
 - ◆ Start this operation after removing all moisture inside the hose.
 - ◆ During forced drying operation, cooling, heating or dehumidifying operation is unavailable.
- H. Humidifying air flow rate fine adjusting mode allows to fine-tune the speed of the humidification fan around $\pm 10\%$ relative to AUTO. If you want to increase the air flow rate, set to [H], and to decrease the air flow rate, set to [L].

2.27 Thermostat Control

Outline

When COOLING or HEATING mode is selected with the remote control, the micro computer prevents the unit from turning OFF until the requested room temperature could be obtained.

Detail

In the table below you can find the thermostat ON and OFF conditions for a set point of 21°C.

		OFF	ON	Monitoring	
Cooling	Set point temperature 21°C --> shift 0.5°C	19.5°C	21°C	20~20.5°C	10min
Heating	Set point temperature 21°C --> shift 2.0°C	24.5°C	23°C	23.5~24°C	10sec

Cooling operation:

The unit will turn OFF by thermostat when the room temperature reaches 19.5°C. When the room temperature rises above 21°C, the thermostat turns back ON and the unit resumes its operation. When the room temperature is between 20 <=> 20.5°C, it is in the monitoring zone. If for cooling, the room temperature stays in the monitoring zone for more then 10 min, the thermostat will also turn back ON and the unit will resumes its operation.

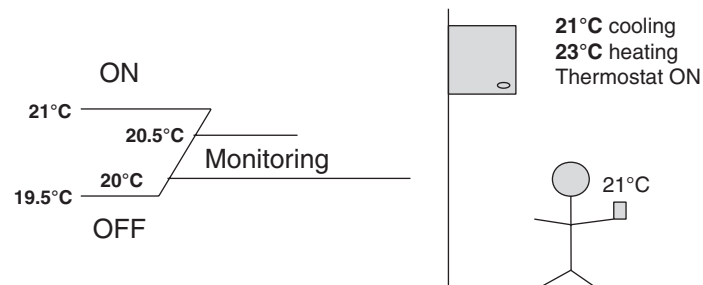

Between the indoor unit and the position of the end user, there is taken into calculation a temperature shift of 0.5°C. This means that at thermostat OFF, the temperature at the end user is e.g. 20°C.



Heating operation:

The unit will turn ON by thermostat when the room temperature reaches its set value + a shift of 2.0°C (e.g. room temperature = 21°C => thermostat ON temperature = 23°C). When the room temperature rises above 24.5°C, the thermostat turns back OFF. When the room temperature is between 24 <=> 23.5°C, it is in the monitoring zone. If for heating, the room temperature stays in the monitoring zone for more then 10 sec, the thermostat will also turn back ON and the unit will resumes its operation.

2.28 Fan Speed Control for Indoor Units

Control mode The airflow can be automatically controlled depending on the difference between the set temperature and the room temperature. This is done through speed control and Hall IC control.

Phase steps Speed control and fan speed control contains different steps:

Step	Cooling	Heating	Dry mode
LLL	 (R4085)	 (R4085)	28 · 42 · 50kW class : 1000 rpm No powerful
LL			
SL (Silent)			
L			
ML			
M			
MH			
H			
HH (Powerful)			

 = Within this range the airflow rate is automatically controlled when the FAN setting button is set to automatic.

1. During powerful operation, fan rotates at H tap + 80 rpm.
2. Fan stops during defrost operation.
3. In time of thermostat OFF, the fan rotates at the following speed.
 - Cooling: The fan keeps rotating at the set tap.
 - Heating: The fan stops.

28 class	LLL	LL	SL	L	ML	M	HM	H	HH
Cooling	---	590	720	790	890	990	1090	1190	1270
Heating	350	590	790	860	970	1080	1190	1300	1380

42 class	LLL	LL	SL	L	ML	M	HM	H	HH
Cooling	---	590	750	820	940	1060	1180	1300	1380
Heating	350	590	820	890	1000	1110	1220	1340	1420

50 class	LLL	LL	SL	L	ML	M	HM	H	HH
Cooling	---	590	790	860	990	1120	1250	1380	1460
Heating	350	590	860	950	1070	1190	1310	1440	1520

In the above table you can see all the different fan speeds of the indoor units fan motor.

When selecting AUTOMATIC air flow control on the remote control, the indoor fan speed will be regulated according to the difference between the room temperature and the required set point on cooling mode. On heating mode, the indoor fan speed will be regulated according to the indoor heat exchanger temperature and the difference between the room temperature and the required set point.

Cooling

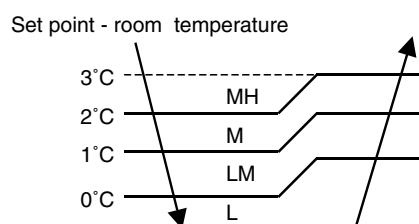

(R5925)

Heating

Room temp.area	Indoor heat exchanger temperature area						
	G	F	E	D	C	B	A
A	OFF	OFF	OFF	OFF	OFF	OFF	OFF
B	MH	LM	LM	L	L	L	2L
C	MH	LM	LM	L	L	L	2L
D	MH	M	LM	LM	L	L	2L
E	MH	M	M	LM	LM	L	2L
F	MH	MH	M	M	LM	L	2L
G	MH	MH	MH	M	LM	L	2L
H	MH	MH	MH	MH	M	L	2L
I	MH	MH	MH	MH	M	L	2L
J	MH	MH	MH	MH	MH	L	2L
K	MH	MH	MH	MH	MH	L	2L
L	MH	MH	MH	MH	MH	L	2L

Room temperature area

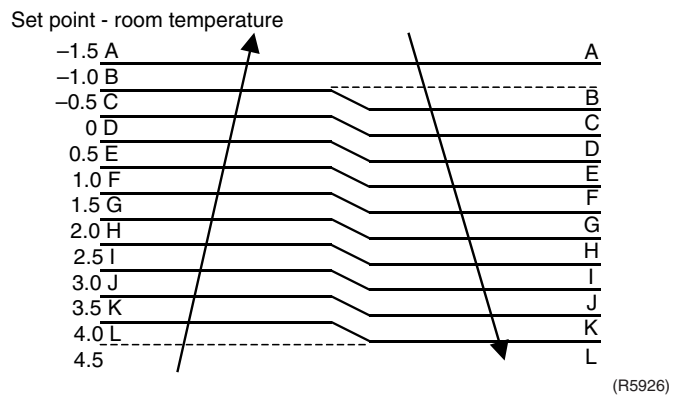

The value will increase when the operation starts.

Indoor heat exchanger temperature area

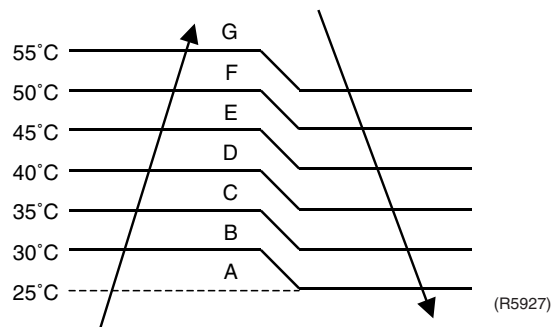

2.29 Draft Prevention (HOT Start)

Outline

Draft prevention control is done to prevent a cold draft feeling when the unit is started up in heating operation. This will happen if the indoor coil temperature drops.

Detail

The outdoor unit will prevent a cold draft by monitoring the indoor heat-exchanger thermistor. It will increase the minimum compressor frequency if the indoor heat exchanger drops below 33°C. If the coil is not hot enough, the indoor fan will not be started at the set speed.

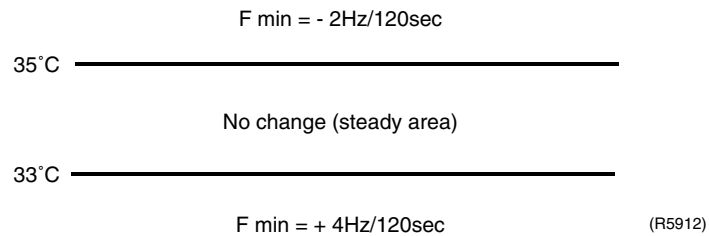

The fan speed will be released step by step. The limitation of the fan speed will be lifted when the indoor heat exchanger temperature rises above F°C.

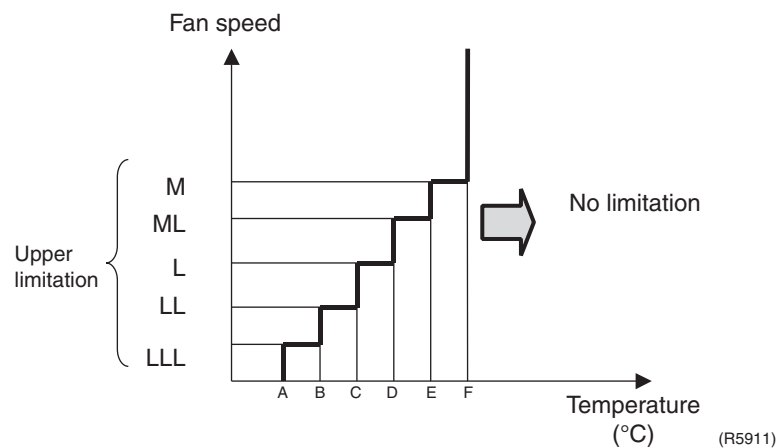

	A	B	C	D	E	F
28 class	10	25	33	34	35	36
42 class	10	25	35	37	38	39
50 class	10	25	35	37	38	39

3. Control Specification

3.1 Frequency Control

Outline

Once the timers of the compressor start-up have elapsed, the unit will determine its compressor frequency out of the following parameters;

1. ΔD : The difference between the room temperature and the set-point.
2. T_d : The discharge temperature.

Indoor frequency command

The indoor command frequency is determined by the difference between the room temperature, and the temperature set by the remote control. Out of this difference a ΔD value (D from difference) is calculated which is then send to the outdoor unit.

Underneath you'll find a table, which relates the different ΔD values to the temperature differences.

Temperature difference	ΔD signal	Temperature difference	ΔD signal	Temperature difference	ΔD signal	Temperature difference	ΔD signal
0	*Th OFF	2.0	4	4.0	8	6.0	C
0.5	1	2.5	5	4.5	9	6.5	D
1.0	2	3.0	6	5.0	A	7.0	E
1.5	3	3.5	7	5.5	B	7.5	F

*Th OFF = Thermostat OFF

Table: ΔD value summary table

Initial frequency setting

When starting the compressor, the frequency must be (re-) initialized in accordance to the ΔD value. Out of this parameters, the micro-controller will determine the initial compressor frequency.

The frequency changes because of the decreasing ΔD values of the indoor units. The frequency will also be changed through limiting functions, which are protecting the unit. Some of these directly control the operating frequency.

Other functions will change the upper or lower frequency limit, preventing the unit from going into a certain operation frequency that will damage it.

PI Control

The PI control will ensure a fast and efficient way of determining the compressor frequency build up.

Detail

I control

This regulator will look at the temperature difference between the room temperature and the set point (ΔD).

- $\Delta D > 4$ then the compressor frequency will rise with ΔD Hz per 120 sec.
- $\Delta D = 4$ then there is no change.
- $\Delta D < 4$ then the compressor frequency will drop with 4 Hz per 120 sec.

P control

This regulator will look at the differences between the room temperatures and the set points (ΔD) in time.

Compare the current ΔD and the last ΔD (20 seconds before). If any change is observed, correct the value calculated by the following formula.

- $(\Delta D_{\text{currently}} - \Delta D_{\text{last measurement}}) \times 4$

3.2 Preheating Operation (Quick Warming Function)

Outline Operate the inverter in the open phase operation with the conditions including the preheating command from the discharge pipe temperature.

Detail **On condition**
The preheating operation starts when the discharge pipe temperature drops below 10°C. At that time, the inverter in open phase operation starts. This means that a small current is sent through one of the compressor windings in order to heat up the inside of the compressor. This is done in order to prevent liquid compression at start up of the compressor when the outdoor temperature is low.

OFF condition

When the discharge temperature is higher than 12°C, the inverter in open phase operation stops.

This function is applicable for cooling only as for heat pump units.
The inverter in open phase control consumes approximately 25~40W.

Note When the preheating operation is active, there is the possibility that a frequency noise can be noticed at the outdoor unit site due to the open phase control.
outdoor temperature $\geq 7^{\circ}\text{C}$

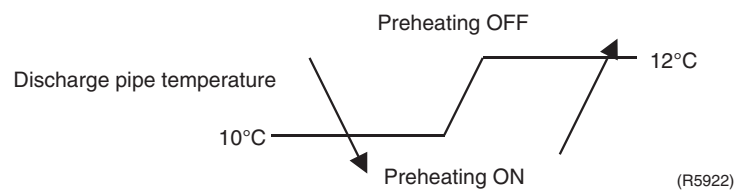

outdoor temperature $< 7^{\circ}\text{C}$

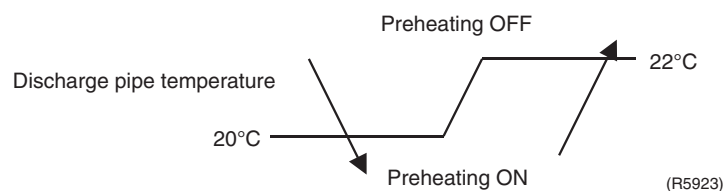

3.3 Four-way Valve Operation

Outline

Because the four-way valve only operates properly when there is an adequate pressure difference, the four-way valve compensation function has been implemented to insure this minimal pressure difference.

Detail

The four-way valve compensation function insures a good four-way valve operation by demanding a certain minimal operation frequency for a certain time. By doing this, the unit is ensuring the switching of the four-way valve.
When this function is enabled, the unit will not look at the other safeties (with the exception of input current control).

The four-way valve compensation function is engaged in four cases

- When starting the compressor for heating.
- When the operation mode is changed.
- When starting the compressor for defrosting.
- When starting the compressor after a power failure (auto-restart).

No power to the valve --> cooling.

Power to the valve --> heating.

		Frequency [Hz]	Time [sec]
Cooling		52	60
Heating	outdoor temperature < 16°C	52	
	outdoor temperature ≥ 16°C	- 0.9 x outdoor temperature + 68	

3.4 Compressor Start up Protection

Detail

The gradual build-up of the upper operation frequency is illustrated in the graph below.

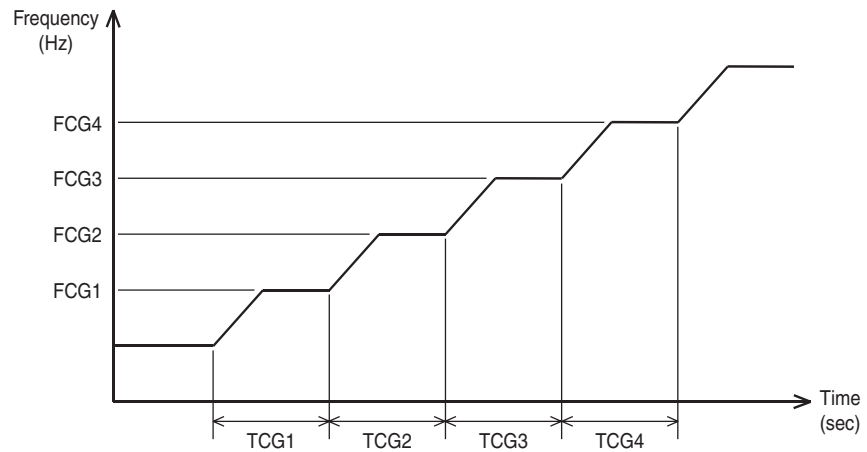

(R5908)

Fig. : Compressor protection function graph.

Timers and frequencies for the compressor protection function

	RXR(28-50)	
	Cooling	Heating
FCG1	52	48
FCG2	54	58
FCG3	78	80
FCG4	98	98
TCG1	220	220
TCG2	140	140
TCG3	60	60
TCG4	60	60

3.5 Fan Speed Control for Outdoor Unit

Outline The fan speed control regulates the speed of the outdoor fan.

Detail Fan control is carried out according to the following conditions.

1. Fan ON control for electric component cooling fan
2. Fan control when defrosting
3. Fan OFF delay when stopped
4. ON/OFF control when cooling operation
5. Fan control during heating operation

Cooling

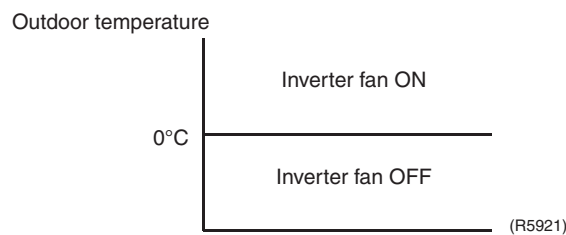

Class	Cooling
28	800rpm
42	850rpm
50	850rpm

The fan speed is fixed.

Heating

Class	Heating
28	750rpm
42	760rpm
50	810rpm

The fan speed is fixed.

3.6 Fin Thermistor Control

Outline This function is only applicable for inverters. The temperature sensor is located on the top of the radiation fins connected to the power elements of the electronic inverter circuit (PAM & PWM).

Detail

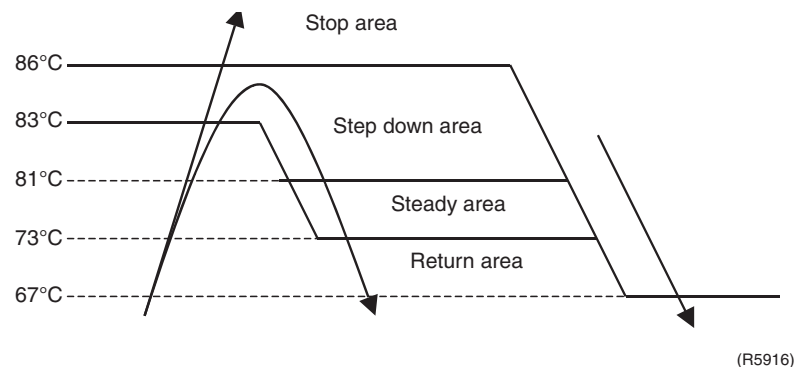

Step down area :

- The frequency decreases with 2 Hz every 15 seconds.

3.7 Input Current Control

Detail

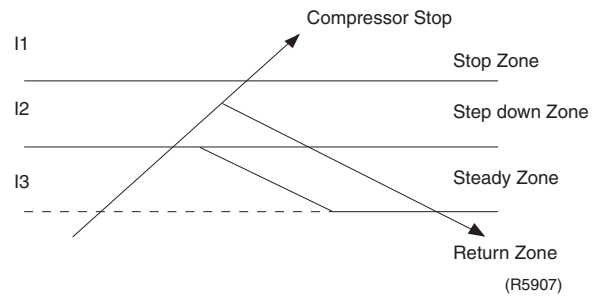

Class	Cooling			Heating		
	28	42	50	28	42	50
I1 (A)	14	14	14	14	14	14
I2 (A)	5.5	7.5	10.0	10.5	10.5	10.5
I3	4.5	6.5	9.0	9.5	9.5	9.5

Stop zone

- After 5 seconds in this zone the compressor is stopped

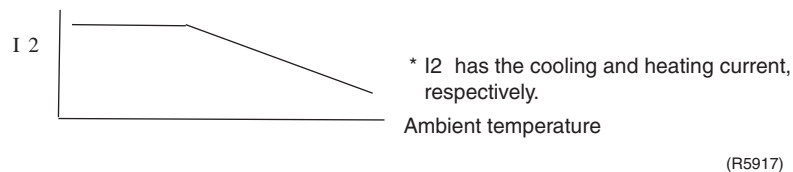

Step down zone

- The maximum limit of the compressor frequency in this control is defined as operation frequency - 2 Hz.
- After this, the output frequency is pulled down by 2 Hz every second until it reaches the steady zone.

Steady zone

- Keeping the present maximum frequency.

Return zone

- Limit of the frequency is cancelled.

3.8 Peak-cut Control

Outline

In heating operation, malfunctioning of the unit (for example dirty filters) can cause the discharge pressure to rise excessively and reach unacceptable levels. To avoid this, peak-cut control will monitor the condensing temperature and when necessary decrease the operating frequency in an attempt to lower the discharge pressure at an early stage.

Detail

In a similar way as with the freeze protection function, the peak-cut control function regulates the maximum operation frequency as indicated in the picture underneath.

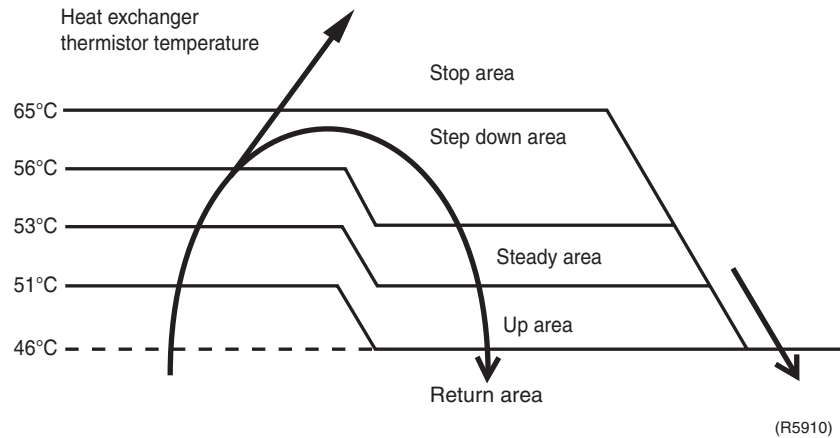

Fig. : Peak-cut control function graph

When recovering from a total stop (return area) :

- Frequency settings remain unchanged.

Up-area:

- The maximum frequency increases with approximately 2Hz every 2 minute.

Steady area:

- The maximum frequency remains constant.

Step down area:

- The maximum frequency decreases with approximately 4Hz every 20sec.

Stop area:

- The compressor, indoor fan and outdoor fan will stop.

3.9 Indoor Coil Freeze-up Protection

Outline

During cooling or dry operation, a malfunction of the unit may cause the indoor heat exchanger's temperature to drop excessively. To prevent the indoor heat exchanger from freezing up, the freeze protection function will reduce the compressor's maximum operation frequency.

Detail

The freeze protection function regulates the maximum operation frequency as indicated in the picture underneath.

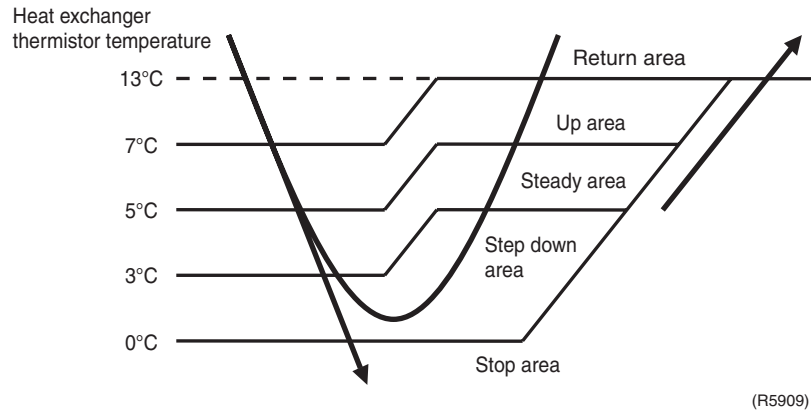

When recovering from a total stop (return area) :

- Frequency settings remain unchanged.

Up-area:

- The maximum frequency increases with approximately 2Hz every 90 seconds.

Steady area:

- The maximum frequency remains constant.

Step down area:

- The maximum frequency decreases with approximately 2Hz every minute.

Stop area:

- The compressor stops completely and the outdoor unit fan will stop. The indoor unit fan operates at 590 rpm. The system will stay OFF until the indoor heat exchanger temperature goes to the reset zone. (13°C)

3.10 Dew Prevention

Outline

Cooling the air around us means that the air is dehumidified (condensation of water on the coil). But because the air is cooled down, less water can be absorbed by the air and as a consequence the relative humidity of the air rises. When the relative humidity of the outlet air nears 100%, you will have water being blown in. To prevent this from happening, the unit will, under certain circumstances, change its target evaporating temperature and the frequency of the compressor. Normally speaking, even under these conditions (dew prevention safety active), the room should still be cooled down, only slower. Of course, if the indoor unit is rather on the small size in comparison to the heat load, this will not be the case and capacity shortage complaints will follow.

Detail

1. Conditions for initiating the dew prevention function.

- ① Operation mode is in cooling/dry.
- ② Compressor is running.
- When the temperature of indoor heat exchanger is lower than the target temperature of heat exchanger, the compressor frequency will be pulled down by 2 Hz in every minute.
- The target temperature of heat exchanger is calculated by the following formula with using the room temperature and indoor humidity.

Target temp. of heat exchanger = $0.94 \times \text{room temp.} + 0.27 \times \text{indoor humidity} - 32.5$

2. Conditions for ending the dew prevention function

- ① Operation mode is not in cooling/dry.
- ② Compressor is not running.

3.11 Liquid Compression Protection 2

Outline

The function will ensure a pressure differential between the high pressure and the low pressure. This is required when cooling with low outdoor ambient temperature because HP gets weak and you will have small capacity and a high power input. The compressor stops according to the conditions of the outdoor ambient temperature and the outdoor heat exchanger temperature.

Details

Outdoor ambient temperature and outdoor heat exchanger temperature

- ◆ Cooling or Dry mode
- ◆ Compressor on
- ◆ Outdoor ambient < 10°C
- ◆ Outdoor heat exchanger < 17°C

If all of these are fulfilled for 11 minutes, the compressor is stopped, the system is reset and restarted after 3 minutes.

Outdoor ambient temperature only

- ◆ Cooling or Dry mode
- ◆ Not in forced cooling mode
- ◆ Outdoor ambient < 0°C

If all of these are fulfilled , the compressor is stopped, the system resumes operation when the outdoor ambient temperature rises above 0°C.

3.12 Discharge Pipe Temperature Control

Outline Overheating has a negative influence on the operating lifetime of a compressor. That's why this function will limit the maximum operating frequency of the compressor if deemed necessary.

Detail Discharge pipe temperature (°C)

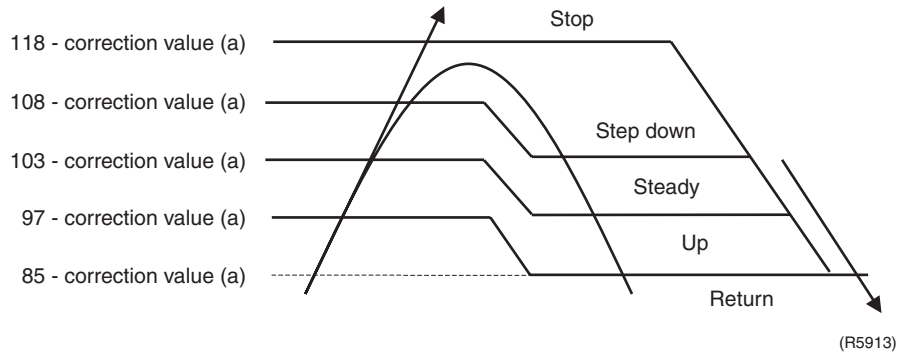

Correction value (a) = correction value by operation frequency (b)
+ correction value by outdoor temperature (c)

Correction value by operation frequency (b)

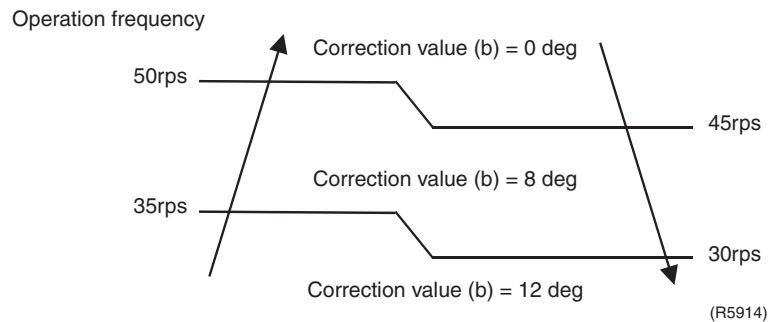

Correction value by outdoor temperature (c)

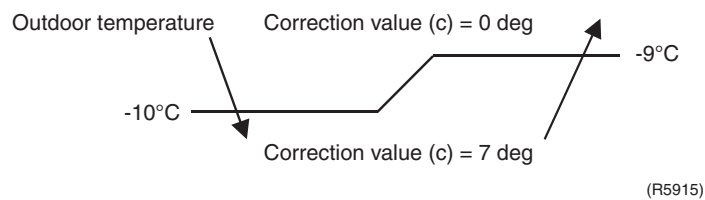

When recovering from a total stop (return area) :

- Frequency settings remain unchanged.

Up-area:

- The maximum frequency increases with 2Hz / 60 seconds

Steady area:

- Present frequency is maximum frequency.

Step down area:

- The maximum frequency decreases with 4Hz per 30 seconds.

Stop area:

- The compressor stops and will only restart when the sensor senses a temperature below set point.

3.13 Automatic Defrosting

Defrost Control Start Condition

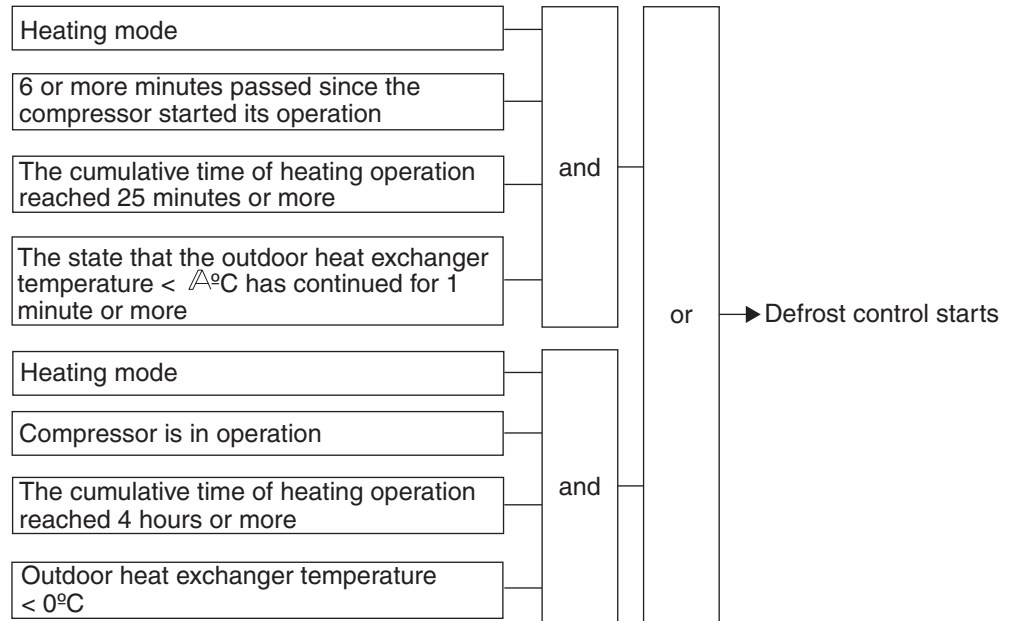

Δ is calculated by the following formula:

$$\Delta = -17/256 \times \text{compressor operation frequency} + 43/64 \times \text{outside air temperature} - 6$$

However, when the calculated value is less than the lower limit indicated in the table below, the lower limit is adopted as Δ .

Outside air temperature condition	Lower limit
$-4\text{°C} \leq \text{outdoor air temp}$	-15°C
$-10\text{°C} \leq \text{outdoor air temp.} < -4\text{°C}$	-20°C
outdoor air temp. $< -10\text{°C}$	-22°C

Operation during Defrosting and Termination Condition

- Operation should be conducted at 64Hz during defrosting.
- Defrosting operation must be conducted for 2 minutes, and after that, defrosting operation is conducted until the outdoor heat exchanger temperature reaches the defrost cancellation temperature at B°C .
- After the temperature has reached the defrost cancellation temperature, the defrosting should be terminated.

B is calculated by the following formula:

$$\text{B} = 18 - 22/64 \times \text{outside air temperature}$$

However, when the calculated value is outside the range between 6°C and 22°C , if it is less than 6°C , 6 should be adopted and if it is more than 22°C , 22 is adopted, as the defrost cancellation temperature.

Defrosting Time Chart

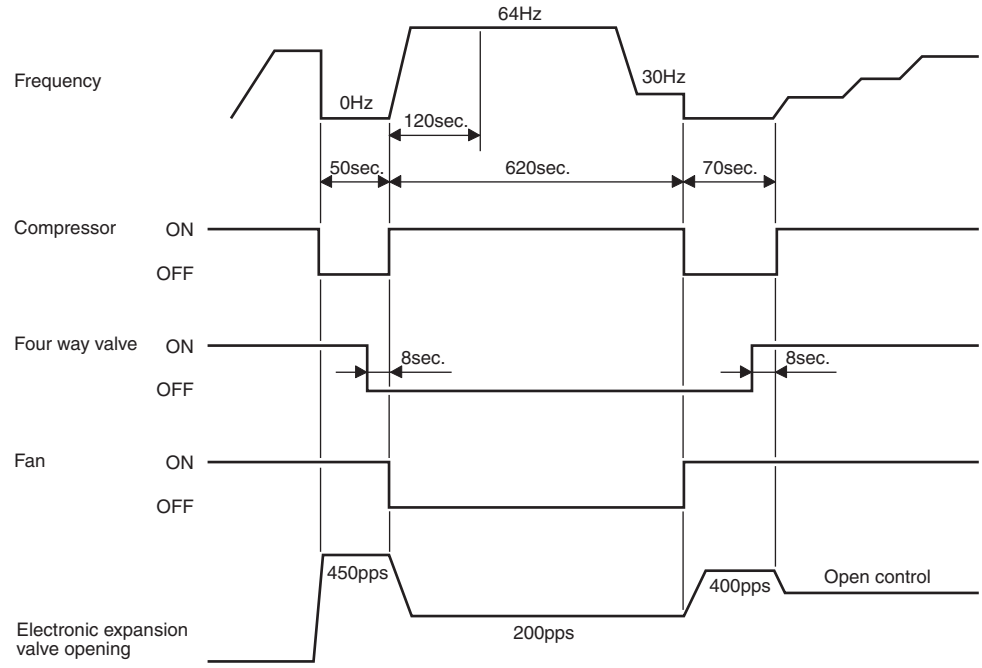

(R6030)

3.14 Electronic Expansion Valve Control

Outline

The following items are included in the electronic expansion valve control.

Electronic expansion valve is fully closed

- ◆ Electronic expansion valve is fully closed when turning on the power.
- ◆ Pressure equalizing control

Open Control

- ◆ Electronic expansion valve control when starting operation
- ◆ Control when frequency changed
- ◆ Control for defrosting (only for heat pump model)
- ◆ Control when a discharge pipe temperature is abnormally high
- ◆ Control when the discharge pipe thermistor is disconnected

Feedback Control

- ◆ Discharge pipe temperature control
- Maximum electronic expansion valve opening : 470 pulses
- Minimum electronic expansion valve opening : 52 pulses

Detail

The gray squares indicate which secondary functions are active or can be activated.

Operation pattern	Main operation control	Control when frequency is changed	Control for abnormally high discharge temperature
Power ON	Power initialization control	×	×
Cooling 1 room operation	Control when starting	×	○
	Control of target discharge temp.	○	○
Stop	Pressure equalization control	×	×
Heating 1 room operation	Control when starting	×	○
	Control of target discharge temp.	○	○
Stop	Pressure equalization control	×	×
Heating operation discharge sensor disconnected	Control when starting	×	○
	Control of target discharge temp.	×	×
Stop	pressure equalization control	×	×

3.14.1 Power Initialization Control

Outline

When turning on the power to the unit, the expansion valve is initialized to a certain starting position.

Detail

At initialization the following steps are executed.

- ◆ The electronic expansion valve is closed by 700 pulses (to make sure it is closed shut).
- ◆ After closing the valve, it is opened again by 400 pulses.

3.14.2 Control when Starting

Outline

Obviously when the unit is switched on, some adjustments to the expansion valve opening have to be made in order to prevent excessive heating or moisture.

Cooling

$$EV = K_{evopf} \times \Delta F_{com} + K_{evopdce} \times D_A + K_{evopdoa} \times D_{OA} + P_5$$

Heating

In 2 min. from the operation starts.

$$EV = K_{evopf} \times \Delta F_{com} + P_5$$

After 2 min. from the operation starts.

$D_{OA} \leq d_{oaopf}$	$EV = K_{evopf} \times \Delta F_{com} + P_5$
$d_{oaopf} < D_{OA} \leq d_{oaopf} + dd_{oaopf}$	$EV = K_{evopf} \times \Delta F_{com} + P_5 + K_{evopdoa} \times (D_{OA} - d_{oaopf})$
$d_{oaopf} + dd_{oaopf} < D_{OA}$	$EV = K_{evopf} \times \Delta F_{com} + P_5 + K_{evopdoa} \times dd_{oaopf}$

Ending Condition

After 6 minutes from the time compressor starts.

or

Discharge temperature +6 > condensation temperature > 36°C

K_{evopf}	: A constant depending on the outdoor unit type
P_5	: A constant depending on the outdoor unit type
$K_{evopdce}$: A constant depending on the outdoor unit type.
$K_{evopdoa}$: A constant depending on the outdoor unit type.
d_{oaopf}	: A constant
dd_{oaopf}	: A constant
D_A	: The room temperature.
D_{OA}	: The outdoor temperature.
ΔF_{com}	: Compressor frequency change.

3.14.3 Control when Frequency is Changed

Outline

Because the operation frequency is one of the variables in the calculation of the original opening of the expansion valve, the opening will have to be recalculated when the operation frequency is changed. During this recalculation, the target discharge temperature control will be deactivated.

Detail

This control will engage when the operation frequency is changed during the target discharge temperature control. When this happens, a 10 seconds timer is set. Once this timer expires, the expansion valve opening is recalculated using the formulas below:

$$PHNHZ = PHNHZZ + KEVOPF \times (FMK - FMKZ)$$

Where:

$PHNHZZ$	= expansion valve opening before change
$PHNHZ$	= expansion valve opening after change
$KEVOPF$	= constant value (cooling:2.7, heating:2.0)
FMK	= operation frequency after change
$FMKZ$	= operation frequency before change

The expansion valve opening is only changed when $FMK - FMKZ > 4$.

3.14.4 Target Discharge Pipe Temperature Control

Outline

Superheat (SH) is required to insure that only gas and not liquid is sucked up by the compressor. Because of the direct link between the SH and the discharge temperature (see Fig. target discharge temperature), a control on the discharge temperature was made to be one of the main control systems of Daikin air-conditioners. The discharge temperature and SH are regulated by the expansion valve.

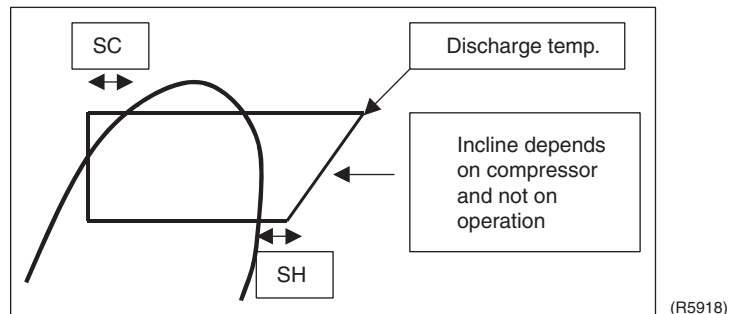

Fig.: Target discharge pipe temperature control graph

Detail

The adjustment to the expansion valve opening is determined by the difference between the actual discharge temperature and the target discharge temperature.

Starting conditions for this operation are:

- ◆ The starting control and the 'operation room change' control (only for multi system) are inactive.
- ◆ The frequency changing control, high discharge temperature control and disconnected discharge thermistor control are inactive
- ◆ The defrost operation is inactive
- ◆ The compressor is active

$$\text{Target discharge temperature} = \alpha \text{ cond. temp.} - \beta \text{ evap. temp.} + \gamma$$

α, β, γ ; predetermined constants related to different model types.

Discharge temp > target discharge temp, exp. valve will open.

Discharge temp < target discharge temp, exp. valve will close.

The target superheat (SH) will be 5°C ~ 7°C in cooling operation and 0°C in heating operation. The discharge superheat always have to be larger then 10°C. Otherwise the unit will have liquid compression. (depends on compressor type)

3.14.5 Pressure Equalization Control

Outline

The pressure difference between the condenser and evaporator works as an extra load when restarting the compressor. To limit the load on the compressor when restarting it and consequently limit the starting current, a pressure-equalization is performed after deactivating the compressor. Pressure equalization is achieved by opening the expansion valve to a certain level and then closing it again.

Detail

As soon as the compressor is stopped due to an OFF command, the motorized valve is controlled as follows.

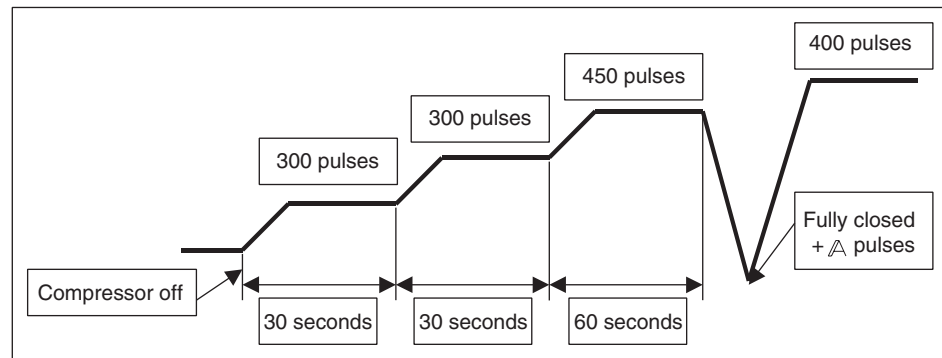

(R5919)

Fig.: Pressure equalization control graph in cooling mode

	Δ
OFF command by remote control, mode change	24
Thermostat OFF	0

3.14.6 Control for Abnormally High Discharge Temperature

Outline

An abnormally high discharge temperature is an indication for a too high suction temperature or super-heat. Making adjustments to the expansion valve opening can solve this problem.

Detail

Increasing the expansion valve opening will increase the refrigerant flow through the evaporator and decrease the superheat and the discharge temperature.

The unit is operating in the 'dropping zone' when all the following conditions are met:

- ♦ The compressor is operating
- ♦ the discharge temperature exceeds A°C

The unit is operating in the 'reset zone' when one of the following conditions are met:

- ♦ The compressor has stopped
- ♦ the discharge temperature is below B°C

A = 104 - correction value (a)

B = 100 - correction value (a)

For the correction value (a), refer to the Page72 "High Discharge Pipe Temperature Control".

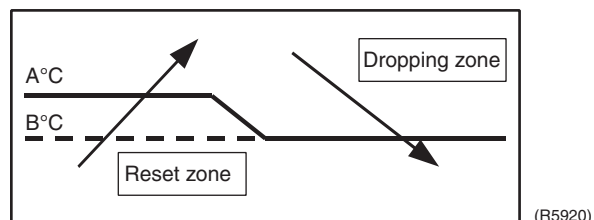

Fig.: Abnormal high discharge temperature control graph

In the dropping zone the unit will react as follows:

- ♦ Prohibit the discharge pipe temperature control
- ♦ When entering the dropping zone from the reset zone, it will add 20 pulses the expansion valve opening and set a 30 seconds 'opening adjustment timer'.
- ♦ Each time the opening adjustment timer reaches zero without leaving the dropping zone, 20 pulses will be added to the expansion valve opening and the opening adjustment timer will be reset.

Part 5

System Configuration

1. Installation Manual	82
1.1 Indoor Units	82
1.2 Outdoor Units	96
2. System Configuration.....	106
3. Instruction.....	107
3.1 Safety Precautions	107
3.2 Names and Functions of Parts	108
3.3 Preparation before Operation.....	110
3.4 Cooling · “SARARA” DRYING Operation	112
3.5 Heating · “URURU” HUMIDIFYING Operation	113
3.6 AUTO / MOISTURIZING Operation	114
3.7 Adjusting Airflow Direction · Comfort Airflow Mode · Cooling Breeze · Airflow Rate	115
3.8 FLASH STREAMER AIR PURIFYING · FRESH AIR SUPPLY VENTILATION Operation / HOME LEAVE VENTILATION	116
3.9 TIMER Operation	117
3.10 COMFORT SLEEP / POWERFUL Operation	118
3.11 SET UP	119
3.12 MOLD PROOF Operation	120
3.13 MOLD SHOCK Operation / INFORMATION DISPLAY	121
3.14 Care and Cleaning	122
3.15 Troubleshooting.....	130

1. Installation Manual



1.1 Indoor Units

1.1.1 Safety Precautions





- Read these Safety Precautions carefully to ensure correct installation.
- This manual classifies the precautions into WARNING and CAUTION.
Be sure to follow all the precautions below: they are all important for ensuring safety.



 **WARNING**.....**Failure to follow any of WARNING is likely to result in such grave consequences as death or serious injury.**

 **CAUTION**.....**Failure to follow any of CAUTION may result in grave consequences in some cases.**

 Be sure to observe this instruction.	 Be sure to establish an earth connection.	 Never attempt.
------------------------------------------------------------------------------------------------------------------------	-----------------------------------------------------------------------------------------------------------------------------	----------------------------------------------------------------------------------------------------

- After completing installation, test the unit to check for installation errors. Give the user adequate instructions concerning the use and cleaning of the unit according to the Operation Manual.

 WARNING	
• Installation should be left to the dealer or another professional. Improper installation may cause water leakage, electrical shock, or fire.	
• Install the air conditioner according to the instructions given in this manual. Incomplete installation may cause water leakage, electrical shock, or fire.	
• Be sure to use the supplied or specified installation parts. Use of other parts may cause the unit to come to lose, water leakage, electrical shock, or fire.	
• Install the air conditioner on a solid base that can support the weight of the unit. An inadequate base or incomplete installation may cause injury in the event the unit falls off the base.	
• Electrical work should be carried out in accordance with the installation manual and the national electrical wiring rules or code of practice. Insufficient capacity or incomplete electrical work may cause electrical shock or fire.	
• Be sure to use a dedicated power circuit. Never use a power supply shared by another appliance.	
• For wiring, use a cable length enough to cover the entire distance with no connection. Do not use an extension cord. Do not put other loads on the power supply, use a dedicated power circuit. (Failure to do so may cause abnormal heat, electric shock or fire.)	
• Use the specified types of wires for electrical connections between the indoor and outdoor units. Firmly clamp the interconnecting wires so their terminals receive no external stresses. Incomplete connections or clamping may cause terminal overheating or fire.	
• After connecting interconnecting and supply wiring be sure to shape the cables so that they do not put undue force on the electrical covers or panels. Install covers over the wires. Incomplete cover installation may cause terminal overheating, electrical shock, or fire.	
• If any refrigerant has leaked out during the installation work, ventilate the room. (The refrigerant produces a toxic gas if exposed to flames.)	
• After all installation is complete, check to make sure that no refrigerant is leaking out. (The refrigerant produces a toxic gas if exposed to flames.)	
• When installing or relocating the system, be sure to keep the refrigerant circuit free from substances other than the specified refrigerant (R410A), such as air. (Any presence of air or other foreign substance in the refrigerant circuit causes an abnormal pressure rise or rupture, resulting in injury.)	
• During pump-down, stop the compressor before removing the refrigerant piping. If the compressor is still running and the shut-off valve is open during pump-down, air will be sucked in when the refrigerant piping is removed, causing abnormal pressure in the freezer cycle which will lead to breakage and even injury.	
• During installation, attach the refrigerant piping securely before running the compressor. If the compressor is not attached and the shut-off valve is open during pump-down, air will be sucked in when the compressor is run, causing abnormal pressure in the freezer cycle which will lead to breakage and even injury.	
• Be sure to establish an earth. Do not earth the unit to a utility pipe, arrester, or telephone earth. Incomplete earth may cause electrical shock, or fire. A high surge current from lightning or other sources may cause damage to the air conditioner.	
• Be sure to install an earth leakage breaker. Failure to install an earth leakage breaker may result in electric shocks, or fire.	

 CAUTION	
• Do not install the air conditioner in a place where there is danger of exposure to inflammable gas leakage. If the gas leaks and builds up around the unit, it may catch fire.	
• Establish drain piping according to the instructions of this manual. Inadequate piping may cause flooding.	
• Note for installing the outdoor unit. (For heat pump model only.) In cold area where the outside air temperature keep below or around freezing-point for a few days, the outdoor unit's drain may freeze. If so, it is recommended to install an electric heater in order to protect drain from freezing.	
• Tighten the flare nut according to the specified method such as with a torque wrench. If the flare nut is tightened too hard, the flare nut may crack after a long time and cause refrigerant leakage.	

1.1.2 Accessories

Ⓐ Mounting plate	1	Ⓔ Air supply filter frame	1	Ⓜ AAA dry-cell batteries	2
Ⓑ Deodorizing filter for streamer	1	Ⓕ Indoor unit fixing screws (M4 × 12L)	3	Ⓨ Operation manual	1
Ⓒ Titanium apatite photocatalytic air-purifying filter	1	Ⓖ Wireless remote control	1	Ⓦ Installation manual	1
Ⓓ Air supply filter	1	Ⓗ Remote control holder	1		

1.1.3 Choosing an Installation Site

- Before choosing the installation site, obtain user approval.

1 Indoor unit

- The indoor unit should be sited in a place where:
 - 1) the restrictions on installation specified in the indoor unit installation drawings are met,
 - 2) both air intake and exhaust have clear paths met,
 - 3) the unit is not in the path of direct sunlight,
 - 4) the unit is away from the source of heat or steam,
 - 5) there is no source of machine oil vapour (this may shorten indoor unit life),
 - 6) cool (warm) air is circulated throughout the room,
 - 7) the unit is away from electronic ignition type fluorescent lamps (inverter or rapid start type) as they may shorten the remote control range,
 - 8) the unit is at least 1 metre away from any television or radio set (unit may cause interference with the picture or sound),
 - 9) install at the recommended height (1.8m).

2 Infrared remote control.

- 1) Turn on all the fluorescent lamps in the room, if any, and find the site where remote control signals are properly received by the indoor unit (within 7 metres).

1.1.4 Indoor Unit Installation Drawings

1 Precautions for humidifying hose installation work.

- When embedding humidifying hose:
 - 1) Cannot be installed to the existing embedded piping. Embedding work is separately necessary.
- The length of the humidifying hose is marked on the hose packing material.
 - 1) Use an extension hose (sold separately) when extending the humidifying hose.
 - 2) The length of the humidifying hose needs to be set to ensure humidifying capacity. Cut off any excess hose. Use the remote control to set the hose length. (Refer to page 118.)
- If the humidifying hose needs to be cut to be laid, cut it, lay it, and connect it using the joint or elbow included with the outdoor unit. When doing this, wrap it to prevent air leaks with the binding band included with the outdoor unit. (Refer to page 104.)
- When laying the humidifying hose inside the wall, block the ends of the humidifying hose with tape or the like to prevent water or anything else from entering it until it is connected to the indoor unit and outdoor unit ducts.
- Do not bend the humidifying hose more than 90°.

2 Removing and installing indoor unit.

• Installation method

- 1) Using the marks (3 locations) on top of the indoor unit, attach the mounting plate hooks onto the indoor unit.
- 2) Attach the tabs on the bottom frame onto the mounting plate. If the tabs are not hooked onto the plate, remove the front grille to hook them. (Check to see if the tabs are hooked securely.)

• Removal method

Push up the mark part on the bottom of the front grille, discharge the tabs, and then remove the unit while lifting it up.

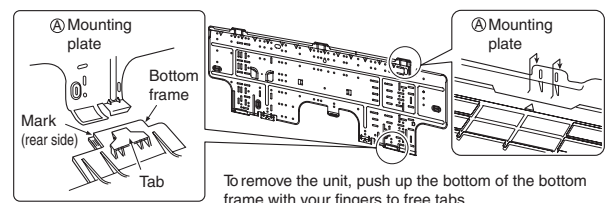

To remove the unit, push up the bottom of the bottom frame with your fingers to free tabs. (Mark parts (2 locations) on the bottom of the front grille.)

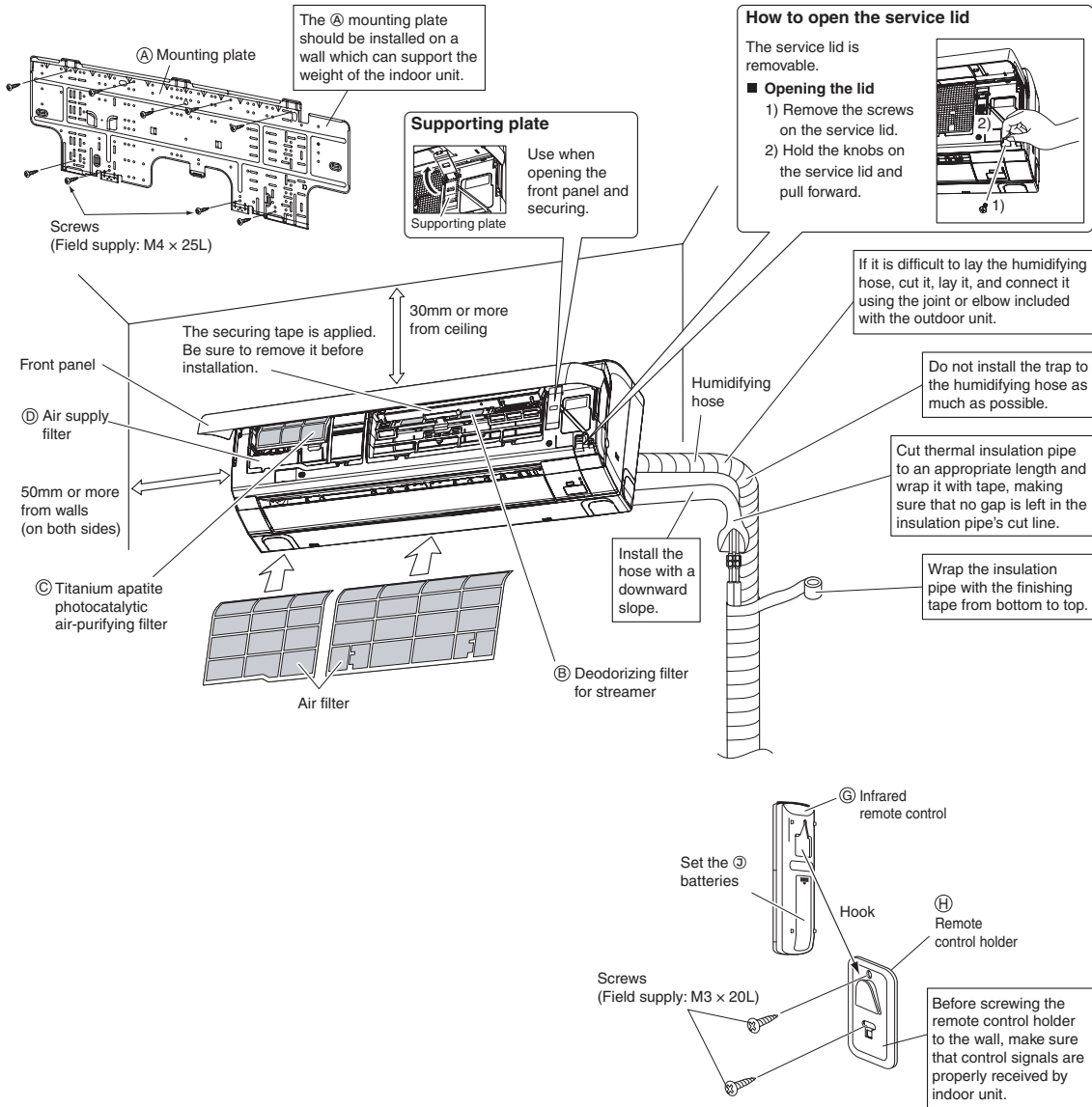

1.1.5 Installation Tips

1 Removing and installing front panel.

- **Removal method**

- 1) Open the front panel.
- 2) Spread out the shaft hole on the left side and remove the rotating shaft. Spread out the shaft hole on the right side as well and remove the rotating shaft.

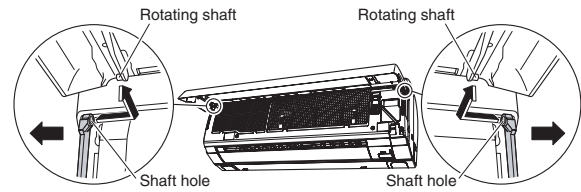

- **Installation method**

Insert the right and left rotating shafts on the front panel into the shaft holes one at a time and slowly close the panel.

(Press on both sides of the front panel.)

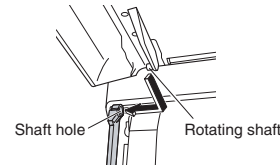

2 Removing and installing the upper panel.

- **Removal method**

- 1) Remove the front panel and air filter.
- 2) Hold and pull forward 2 tabs on both sides to discharge them, discharge the center tab, and then lift up the upper panel.

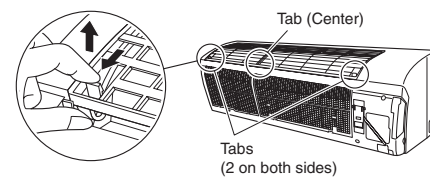

- **Installation method**

- 1) Push in the upper panel along the guide on the top of the front grille and insert the 3 tabs into the slots on the front grille.
- 2) Push the upper panel down until it clicks.
- 3) Attach the air filter and front panel.

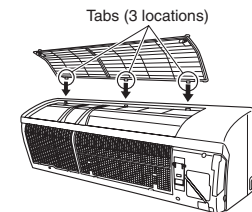

3 Removing and installing the front grille.

- **Removal method**
 - 1) Remove the front panel, air filter and upper panel.
 - 2) Fully open the top and bottom horizontal louvers. (See Fig. 1)
 - 3) Remove the 3 screws in the front grille.
 - 4) Lift the hooks (3 locations) on the front grille with a flathead screwdriver to discharge the tab. (Look for the ○○○ mark.) (See Fig. 2)
 - 5) Pull forward the front grille to remove.
- **Installation method**
 - 1) Open the top louver fully and close the bottom louver fully.
 - 2) Store the gear case arm in the front grille. (See Fig. 3)
 - 3) Attach the front grille to the lower part of the unit. (Use caution not to pinch the horizontal louver.)
 - 4) Make sure to firmly latch the top hooks (3 locations).
 - 5) Tighten with the 3 front grille screws.
 - 6) Attach the upper panel, air filter and front panel.

Fig. 1 Horizontal louver

When removing or attaching the front grille, pay attention to open or close of each horizontal louver.

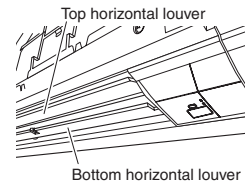

Fig. 2 Hooks on the front grille

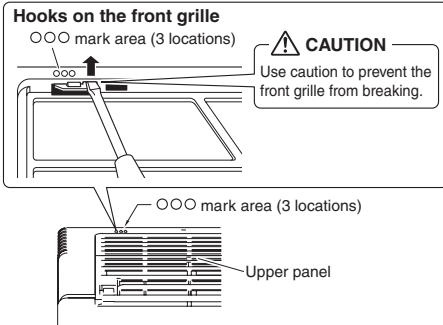
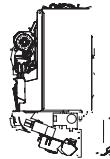

Fig. 3 Gear case arm



Be sure to store the gear case arm before attaching the front grille.

4 Installing the air supply filter.

- 1) Open the front panel to remove the left air filter.
- 2) Set the ㉓ air supply filter to the ㉔ air supply filter frame.
- 3) Attach the ㉔ air supply filter frame.
- 4) Replace the left air filter to its original position and close the front panel.

<Air supply filter installation drawing>

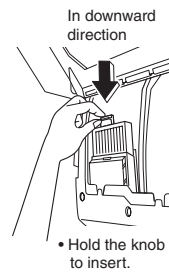

<How to set the filter>

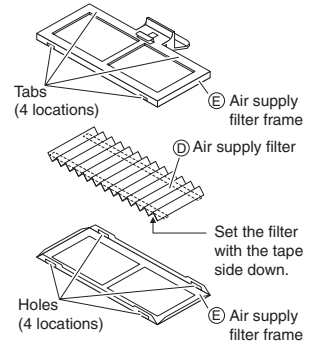

5 Installing the titanium apatite photocatalytic air-purifying filter and deodorizing filter for streamer.

- 1) Open the front panel to pull out the air filter.
- 2) Attach the ㉓ titanium apatite photocatalytic air-purifying filter.
- 3) Attach the ㉔ deodorizing filter for streamer.
- 4) Replace the air filter to its original position and close the front panel.

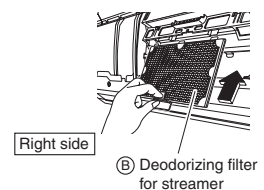
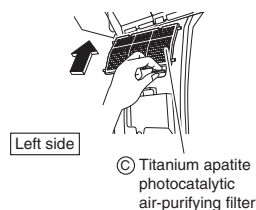

6 How to replace the drain plug and drain hose.

- **Replacing onto the left side**
 - 1) Remove the insulation fixing screws on the right to remove the drain hose.
 - 2) Reattach the insulation fixing screw on the right as it was.*
(Forgetting to attach this may cause water leakages.)
 - 3) Remove the drain plug on the left side and attach it to the right side.
 - 4) Insert the drain hose and tighten with included ⑥ indoor unit fixing screw.

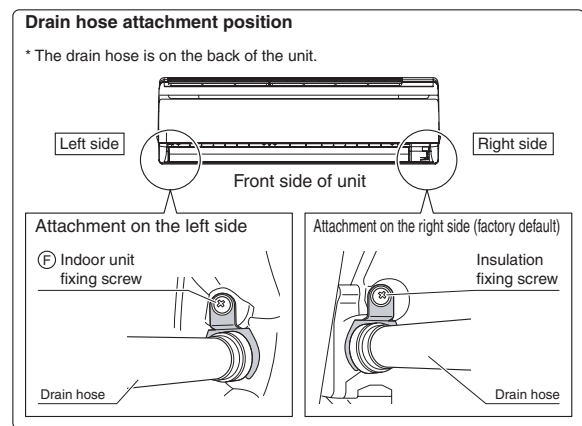

How to set drain plug.

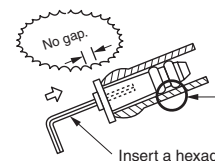

Do not apply lubricating oil (refrigerant oil) when inserting. Application of causes deterioration and drain leakage of the plug.

7 How to set the different addresses.

- **When 2 indoor units are installed in one room, the 2 infrared remote controls can be set for different addresses.**
 - 1) Remove the front grille. (3 screws)
 - 2) Cut the address jumper "JA". (See Fig. 1)
- 3) Remove the remote control lid and cut the address jumper "J4". (See Fig. 2) F

Fig. 1

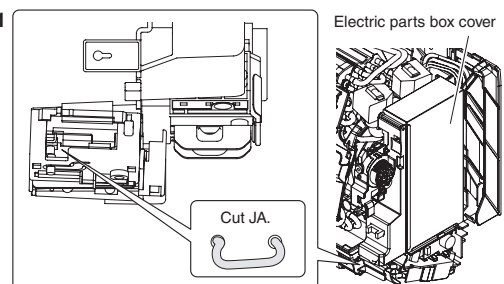
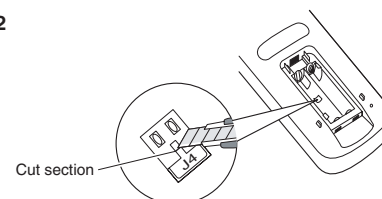

Fig. 2



1.1.6 Indoor Unit Installation

1 Installing the mounting plate.

- The (A) mounting plate should be installed on a wall which can support the weight of the indoor unit.
 - 1) Temporarily secure the (A) mounting plate to the wall, make sure that the panel is completely level, and mark the boring points on the wall.
 - 2) Secure the (A) mounting plate to the wall with screws.

Recommended mounting plate retention spots and Dimensions

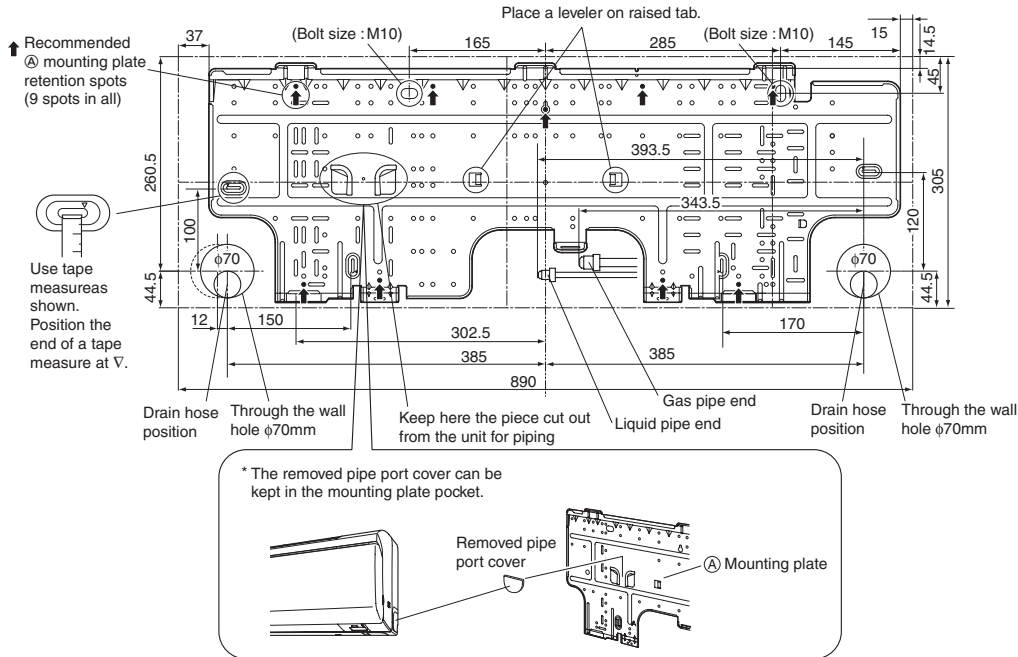

2 Boring a wall hole and installing wall embedded pipe.

- For walls containing metal frame or metal board, be sure to use a wall embedded pipe and wall cover in the feed-through hole to prevent possible heat, electrical shock, or fire.
- Be sure to caulk the gaps around the pipes with caulking material to prevent water leakage.
 - 1) Bore a feed-through hole of 70mm in the wall so it has a down slope toward the outside.
 - 2) Insert a wall pipe into the hole.
 - 3) Insert a wall cover into wall pipe.
 - 4) After completing refrigerant piping, wiring, and drain piping, caulk pipe hole gap with putty.

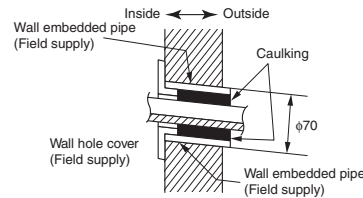

3 Installing inter-unit wiring.

- 1) Open the front panel and remove the service lid.
- 2) Pull out the inter-unit wiring from the back of the indoor unit to the front. It is easier to pull out if bending up the wire edge in advance.
- 3) To connect the inter-unit wiring after hooking the unit onto the (A) mounting plate, connect the inter-unit wiring as shown in the figure at right.

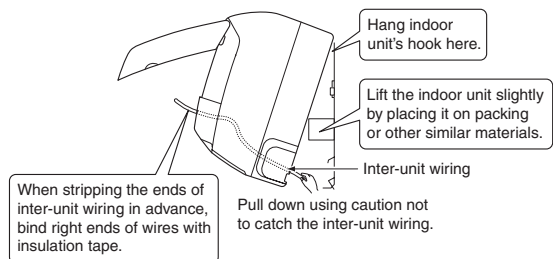

4 Laying piping, hoses, and wiring.

- Connect the humidifying hose to the indoor unit duct. See 5. **Humidifying hose installation work** for details.
- Lay the piping, drain hose and humidifying hose according to the orientation of the piping coming out of the unit, as shown below.
- Make sure the drain hose is sloped downward.
- Wrap the piping, drain hose and humidifying hose together using insulation tape.

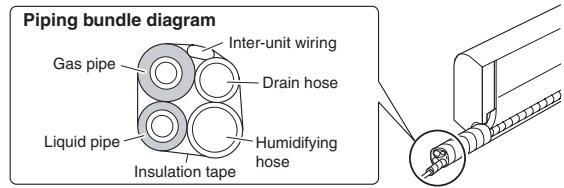

4-1. Right-side, right-back, or right-bottom piping

• Right-side piping

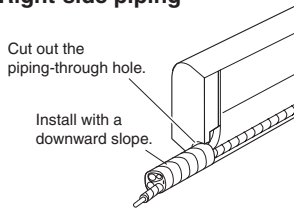

• Right-back piping

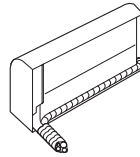

• Right-bottom piping

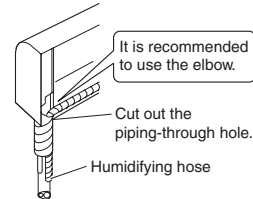

- 1) Wrap the piping, hose and inter-unit wiring using insulation tape as shown in the piping bundle diagram.
- 2) Put all the pipes through the through-hole in the wall and hook the indoor unit onto the (A) mounting plate.
- 3) Connect the pipes.

4-2. Left-side, left-back, or left-bottom piping

• Left-side piping

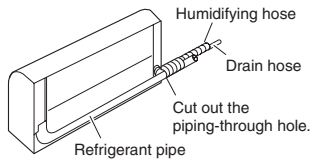

• Left-back piping

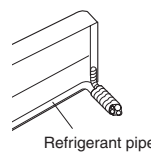

• Left-bottom piping

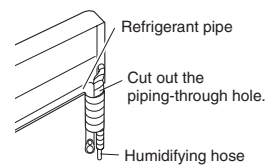

- 1) Replace the drain plug and drain hose. (**How to replace the drain plug and drain hose.**)
- 2) Pull in the refrigerant piping and lay it so that it matches the liquid and gas piping marked on the (A) mounting plate.
- 3) Hook the indoor unit onto the (A) mounting plate.
- 4) Connect the pipes. If it is difficult to do, remove the front panel first.
- 5) Wrap the insulation on the piping with insulation tape. If you are not replacing the drain hose, store it in the location shown below.

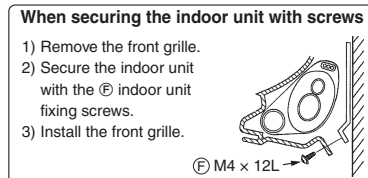

4-3. Left-back piping.

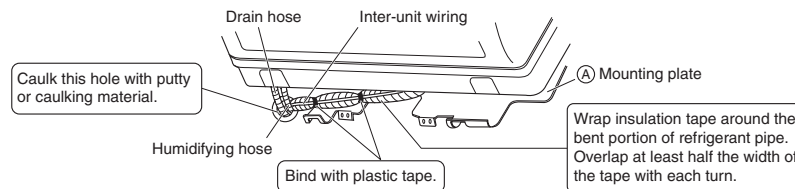

4-4. Wall embedded piping.

Follow the instructions given under.

Left-side, left-back, or left-bottom piping

- 1) Insert the drain hose to this depth so it won't be pulled out of the drain pipe.

Insert drain hose to this depth so it won't be pulled out of drain pipe.

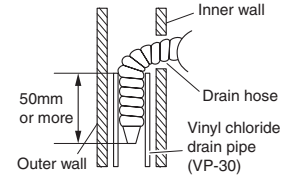

! WARNING

Do not bundle the power code with a bidding band, a twist tie or other method. This may cause heat, electric shock or fire.

5 Humidifying hose installation work.

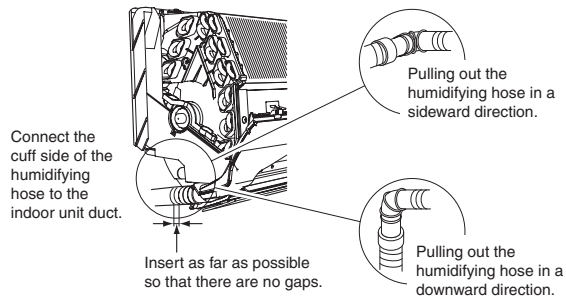
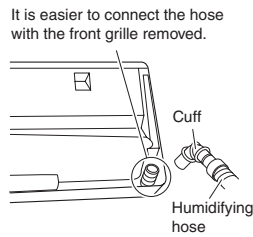

5-1. Connecting to the indoor unit.

- Connect the cuff side of the humidifying hose to the indoor unit duct.

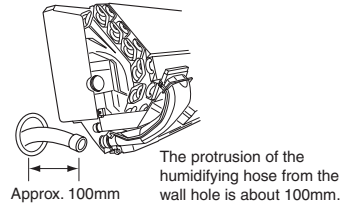
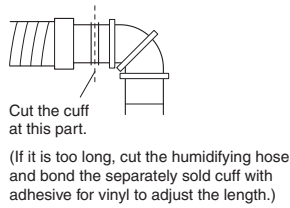

- **Left-back piping**

! CAUTION

Use caution not to deform the cuff while installing the humidifying hose.

5-2. Connecting to cut humidifying hoses.

- When install the cut humidifying hoses, follow the instructions below.

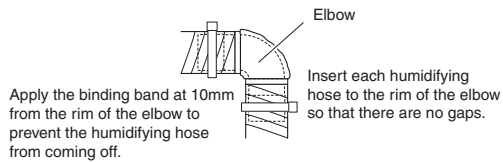
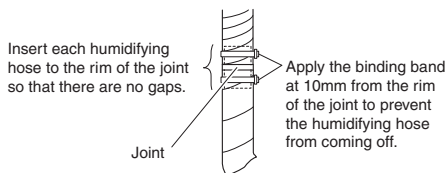

- Use not more than two elbows to ensure humidifying capacity.

6 Wiring.

- 1) Strip wire ends (15mm).
- 2) Match wire colours with terminal numbers on indoor and outdoor unit's terminal blocks and firmly screw wires to the corresponding terminals.
- 3) Connect the earth wires to the corresponding terminals.
- 4) Pull wires to make sure that they are securely latched up, then retain wires with wire retainer.
- 5) In case of connecting to an adapter system. Run the remote control cable and attach the S21. **(Refer to 7. Connecting to the HA system.)**
- 6) Shape the wires so that the service lid fits securely, then close service lid.

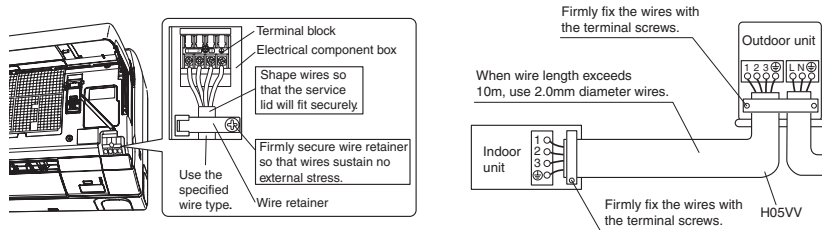

WARNING

- 1) Do not use tapped wires, strand wires, extensioncords, or starburst connections, as they may cause overheating, electrical shock, or fire.
- 2) Do not use locally purchased electrical parts inside the product. (Do not branch the power for the drain pump, etc., from the terminal block.) Doing so may cause electric shock or fire.

7 Connecting to the HA system.

- 1) Remove the front grille. (3 screws)
- 2) Remove the decelerator assembly parts. (1 screw)
 - 2-1) Remove the decelerator assembly part screws. (See Fig. 1)
 - 2-2) Remove the decelerator assembly part connector. Remove by pressing on the tabs on the bottom of the connector. (See the tab position diagram 1)
- 3) Remove the electric parts box. (1 screw, 2 tabs)
 - 3-1) Remove the electric parts box fixing screw.
 - 3-2) Pull the electric parts box toward you and discharge the tab 2.

Fig. 1

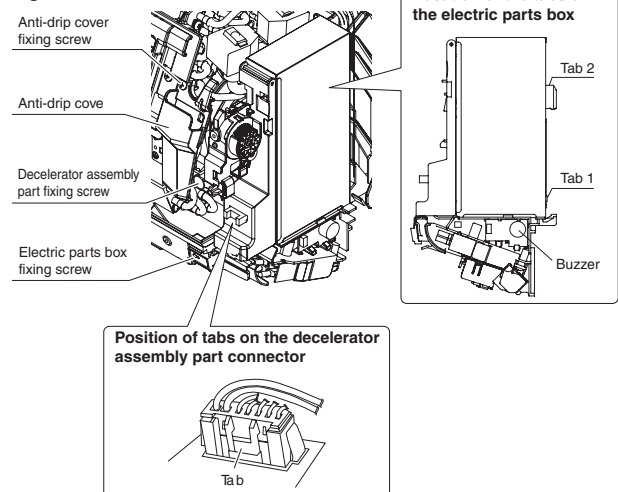

- 4) Remove the electric parts box cover. (3 tabs) (Refer to Fig. 2)
 - 4-1) Discharge the tab 3.
 - 4-2) Pull up the electric parts box cover slowly, discharge the tab 4, slide up, and discharge the tab 5.
- 5) Insert the connection cord into the HA connector "S21".
- 6) Lay the connection cord as shown in "Fig. 3".
- 7) Replace the electric parts box cover and electric parts box as they were.
- 8) Attach the decelerator assembly part along with the guide rail. (Refer to Fig. 2)
- 9) Install the front grille.

Fig. 2

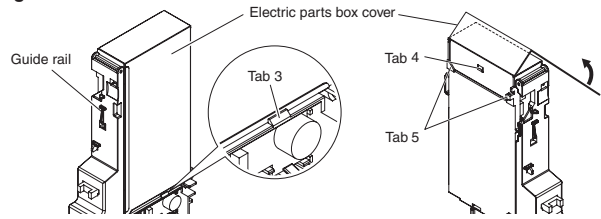
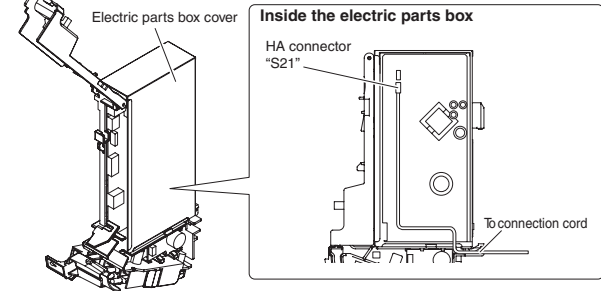
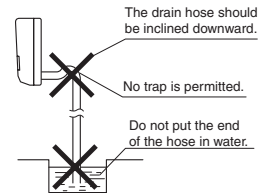

Fig. 3



8 Drain piping.

- 1) Connect the drain hose, as described right.



- 2) Remove the air filters and pour some water into the drain pan to check the water flows smoothly.

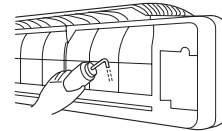

- 3) When drain hose requires extension, obtain an extension hose commercially available. Be sure to thermally insulate the indoor section of the extension hose.

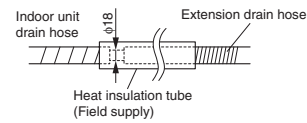

- 4) When connecting a rigid polyvinyl chloride pipe (nominal diameter 13mm) directly to the drain hose attached to the indoor unit as with embedded piping work, use any commercially available drain socket (nominal diameter 13mm) as a joint.

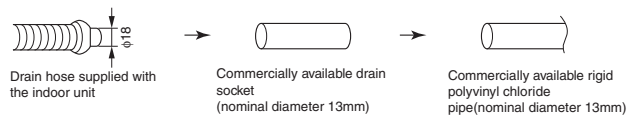

9 Improving installation strength.

- We recommend screwing the indoor unit onto a ㉞ mounting plate in order to improve the installation strength.

- 1) Remove the front grille.
- 2) Screw in the indoor unit with ㉞ fixing screws.
- 3) Attach the front grille.

Screw position
Front diagram

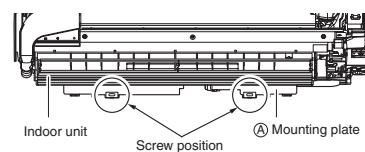

Enlarged diagram

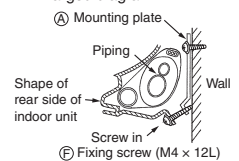

1.1.7 Setting the Humidifying Hose Length

1 Setting the humidifying hose length.

- Set the humidifying hose length to ensure humidifying capacity.
Use the remote control to set the humidifying hose length. When doing this, power on the unit as communication is established between the unit and the remote control.
(The humidifying hose length includes the rear of the indoor unit.)

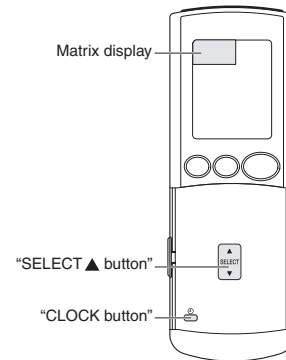

- Hold "CLOCK button" for more than 5 seconds. (To cancel, do not operate the button for 10 seconds. The display will return to normal.)

Matrix display

```
SETTING
1. TEST
```

- Press "SELECT ▲ button". Select "".

```
SETTING
2. PIPE
```

- Press "CLOCK button" to activate the hose length setting mode. (Be sure to direct the remote control toward the main unit while operating it.) The display will show the currently set hose length. (Default is no setting.)

```
PIPE LEN
UNDEF
```

- Press "SELECT ▲ button" to set the humidifying hose length. Pressing "SELECT ▲ button" changes the hose length. You may set the hose length to 5 levels, ~3M, 3.1~4M, 4.1~6M, 6.1~8M, 8.1~10M.

```
PIPE LEN
~3M
```

```
PIPE LEN
3.1~4M
```

```
PIPE SET
RESET
```

- Press "CLOCK button" after selecting the hose length. (Direct the remote control toward the main unit while operating it.)

```
PIPE LEN
4.1~6M
```

(Setting 4.1 to 6m)

- Hold "CLOCK button" for more than 5 seconds. The humidifying hose length setting is complete.

```
🕒 10:00
```

(10:00 a.m.)

If you set the wrong humidifying hose length, cancel the setting displaying "PIPE SET RESET" with the step 4) operation and reset it.

```
PIPE SET
RESET
```

2 When the unit cannot be powered on.

- When setting the humidifying hose length without powering on the unit, the display shows "PIPE LEN UNDEF" with the step 5) operation shown above but the remote control remembers the set hose length.
(When the customer uses the unit, the humidifying hose length information is sent to the indoor unit to be set.)

1.1.8 Refrigerant Piping Work

1 Flaring the pipe end.

- 1) Cut the pipe end with a pipe cutter.
- 2) Remove burrs with the cut surface facing downward so that the chips do not enter the pipe.
- 3) Put the flare nut on the pipe.
- 4) Flare the pipe.
- 5) Check that the flaring is properly made.

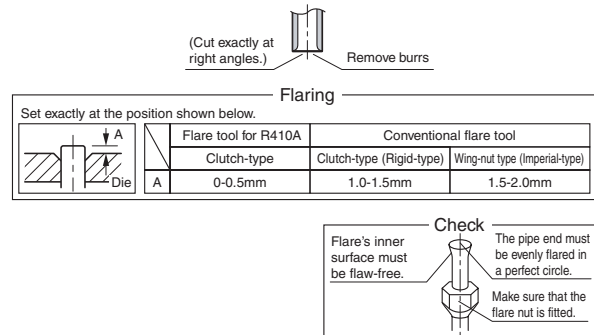

! WARNING

- 1) Do not use mineral oil on flared part.
- 2) Prevent mineral oil from getting into the system as this would reduce the lifetime of the units.
- 3) Never use piping which has been used for previous installations. Only use parts which are delivered with the unit.
- 4) Do never install a drier to this R410A unit in order to guarantee its lifetime.
- 5) The drying material may dissolve and damage the system.
- 6) Incomplete flaring may cause refrigerant gas leakage.

2 Refrigerant piping.

- 1) Align the centres of both flares and tighten the flare nuts 3 or 4 turns by hand. Then tighten them fully with the torque wrenches.
 - Use torque wrenches when tightening the flare nuts to prevent damage to the flare nuts and escaping gas.
- 2) To prevent gas leakage, apply refrigeration oil on both inner and outer surfaces of the flare. (Use refrigeration oil for R410A.)

Flare nut tightening torque	
Gas side	Liquid side
3/8 inch	1/4 inch
32.7-39.9N • m (330-407kgf • cm)	14.2-17.2N • m (144-175kgf • cm)

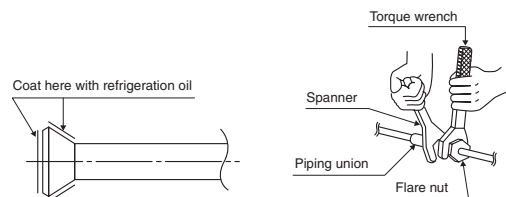

2-1. Caution on piping handling.

- 1) Protect the open end of the pipe against dust and moisture.
- 2) All pipe bends should be as gentle as possible. Use a pipe bender for bending. (Bending radius should be 30 to 40mm or larger.)

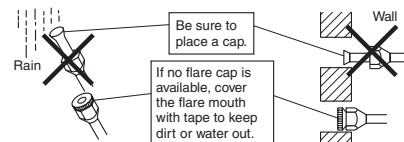

2-2. Selection of copper and heat insulation materials.

- When using commercial copper pipes and fittings, observe the following:
 - 1) Insulation material: Polyethylene foam
Heat transfer rate: 0.041 to 0.052W/mK (0.035 to 0.045 kcal/(mh•°C))
Refrigerant gas pipe's surface temperature reaches 110°C max.
Choose heat insulation materials that will withstand this temperature.
 - 2) Be sure to insulate both the gas and liquid piping and to provide insulation dimensions as below.

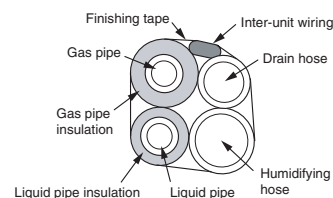

Gas side	Liquid side	Gas pipe thermal insulation	Liquid pipe thermal insulation
O.D. 9.5mm	O.D. 6.4mm	I.D. 12-15mm	I.D. 8-10mm
Thickness 0.8mm		Thickness 10mm Min.	

- 3) Use separate thermal insulation pipes for gas and liquid refrigerant pipes.

1.1.9 Trial Operation and Testing

1 Trial operation and testing.

- 1-1. Measure the supply voltage and make sure that it falls in the specified range.**
- 1-2. Trial operation should be carried out in either cooling or heating mode.**
- In cooling mode, select the lowest programmable temperature; in heating mode, select the highest programmable temperature.
 - 1) Trial operation may be disabled in either mode depending on the room temperature. Use the remote control for trial operation as described below.
 - 2) After trial operation is complete, set the temperature to a normal level (26°C to 28°C in cooling mode, 20°C to 24°C in heating mode).
 - 3) For protection, the system disables restart operation for 3 minutes after it is turned off.
- 1-3. To perform a test run for humidifying operation, activate test run mode from the remote control following the instructions below and press the “HUMIDIFY” button.**
- 1-4. Operate the unit in accordance with the operation manual to check that it operates normally.**
- Even when the air conditioner is not operating, it consumes some electric power. If the customer is not going to use the unit soon after it is installed, turn off the breaker to avoid wasting electricity.

Trial operation from remote control

- 1) Hold the “CLOCK” button for 5 seconds. (The matrix display will appear on the remote control.)
- 2) Display “” on the matrix display of the remote control and press the “CLOCK” button.
- 3) “ 7 ” will be displayed and the unit will enter test run mode.
- 4) Press the button for test run mode.
 - Test run mode will stop automatically after around 30 minutes.
Press the ON/OFF button to force the test-run to stop.

2 Test items.

Test items	Symptom (diagnostic display on RC)	Check
Indoor and outdoor units are installed properly on solid bases.	Fall, vibration, noise	
Did you install the air supply filter?	Noise, water leakage	
Did you install the deodorizing filter for the streamer and the titanium apatite photocatalytic air-purifying filter?	Noise, water leakage	
Have you performed a gas leak test?	Incomplete cooling/heating function	
No refrigerant gas leaks.	Incomplete cooling/heating function	
Refrigerant gas and liquid pipes and indoor drain hose extension are thermally insulated.	Water leakage	
Draining line is properly installed.	Water leakage	
Does the drain hose produce abnormal noise (perking sound) when using the ventilation fan or others?	Use of separately sold air cut drain plug.	
System is properly earthed.	Electrical leakage	
The specified wires are used for inter-unit wiring connections.	Inoperative or burn damage	
Indoor or outdoor unit's air intake or exhaust has clear path of air. Shut-off valves are opened.	Incomplete cooling/heating function	
Indoor unit properly receives remote control commands.	Inoperative	
Did you check the address setting?	Inoperative	
Did you set the humidifying hose length?	<ul style="list-style-type: none"> • LED lamp blinks at power on. • The buzzer sounds during a test run. • Poor performance and noise 	

1.2 Outdoor Units

1.2.1 Safety Precautions

- Read these Safety Precautions carefully to ensure correct installation.
- This manual classifies the precautions into WARNING and CAUTION.
Be sure to follow all the precautions below: they are all important for ensuring safety.



WARNING.....Failure to follow any of WARNING is likely to result in such grave consequences as death or serious injury.



CAUTION.....Failure to follow any of CAUTION may result in grave consequences in some cases.

Be sure to observe this instruction.	Be sure to establish an earth connection.	Never attempt.
--------------------------------------	-------------------------------------------	----------------





- After completing installation, test the unit to check for installation errors. Give the user adequate instructions concerning the use and cleaning of the unit according to the Operation Manual.

WARNING	
• Installation should be left to the dealer or another professional. Improper installation may cause water leakage, electrical shock, or fire.	
• Install the air conditioner according to the instructions given in this manual. Incomplete installation may cause water leakage, electrical shock, or fire.	
• Be sure to use the supplied or specified installation parts. Use of other parts may cause the unit to come to lose, water leakage, electrical shock, or fire.	
• Install the air conditioner on a solid base that can support the weight of the unit. An inadequate base or incomplete installation may cause injury in the event the unit falls off the base.	
• Electrical work should be carried out in accordance with the installation manual and the national electrical wiring rules or code of practice. Insufficient capacity or incomplete electrical work may cause electrical shock or fire.	
• Be sure to use a dedicated power circuit. Never use a power supply shared by another appliance.	
• For wiring, use a cable length enough to cover the entire distance with no connection. Do not use an extension cord. Do not put other loads on the power supply, use a dedicated power circuit. (Failure to do so may cause abnormal heat, electric shock or fire.)	
• Use the specified types of wires for electrical connections between the indoor and outdoor units. Firmly clamp the interconnecting wires so their terminals receive no external stresses. Incomplete connections or clamping may cause terminal overheating or fire.	
• After connecting interconnecting and supply wiring be sure to shape the cables so that they do not put undue force on the electrical covers or panels. Install covers over the wires. Incomplete cover installation may cause terminal overheating, electrical shock, or fire.	
• If any refrigerant has leaked out during the installation work, ventilate the room. (The refrigerant produces a toxic gas if exposed to flames.)	
• After all installation is complete, check to make sure that no refrigerant is leaking out. (The refrigerant produces a toxic gas if exposed to flames.)	
• When installing or relocating the system, be sure to keep the refrigerant circuit free from substances other than the specified refrigerant (R410A), such as air. (Any presence of air or other foreign substance in the refrigerant circuit causes an abnormal pressure rise or rupture, resulting in injury.)	
• During pump-down, stop the compressor before removing the refrigerant piping. If the compressor is still running and the stop valve is open during pump-down, air will be sucked in when the refrigerant piping is removed, causing abnormal pressure in the freezer cycle which will lead to breakage and even injury.	
• During installation, attach the refrigerant piping securely before running the compressor. If the compressor is not attached and the stop valve is open during pump-down, air will be sucked in when the compressor is run, causing abnormal pressure in the freezer cycle which will lead to breakage and even injury.	
• Be sure to establish an earth. Do not earth the unit to a utility pipe, arrester, or telephone earth. Incomplete earth may cause electrical shock, or fire. A high surge current from lightning or other sources may cause damage to the air conditioner.	
• Be sure to install an earth leakage breaker. Failure to install an earth leakage breaker may result in electric shocks, or fire.	

CAUTION	
• Do not install the air conditioner in a place where there is danger of exposure to inflammable gas leakage. If the gas leaks and builds up around the unit, it may catch fire.	
• Establish drain piping according to the instructions of this manual. Inadequate piping may cause flooding.	
• Note for installing the outdoor unit. (For heat pump model only.) In cold area where the outside air temperature keep below or around freezing-point for a few days, the outdoor unit's drain may freeze. If so, it is recommended to install an electric heater in order to protect drain from freezing.	
• Tighten the flare nut according to the specified method such as with a torque wrench. If the flare nut is tightened too hard, the flare nut may crack after a long time and cause refrigerant leakage.	
• Make sure to provide for adequate measures in order to prevent that the outdoor unit be used as a shelter by small animals. Small animals making contact with electrical parts can cause malfunctions, smoke or fire. Please instruct the customer to keep the area around the unit clean.	
• Do not squeeze the top plate of the outdoor unit while removing it. Sharp metal plates may cause injury.	

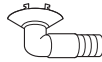
1.2.2 Accessories

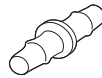
Accessories supplied with the outdoor unit:

Ⓐ Installation Manual 	1	Ⓑ Drain plug 	1
Ⓒ Humidifying hose 	1	Ⓓ Joint 	1
Ⓔ Elbow 	1	Ⓕ Binding band 	5

1.2.3 Precautions for Selecting the Location

- 1) Choose a place solid enough to bear the weight and vibration of the unit, where the operation noise will not be amplified.
- 2) Choose a location where the hot air discharged from the unit or the operation noise will not cause a nuisance to the neighbors of the user.
- 3) Avoid places near a bedroom or similar, so that the operation noise will cause no trouble.
- 4) There must be sufficient spaces for carrying the unit into and out of the site.
- 5) There must be sufficient space for air passage and no obstructions around the air inlet and the air outlet.
- 6) The site must be free from the possibility of flammable gas leakage in a nearby place.
- 7) Install units, power cords and inter-unit cables at least 3 meter away from television and radio sets. This is to prevent interference to images and sounds. (Noises may be heard even if they are more than 3 meter away depending on radio wave conditions.)
- 8) In coastal areas or other places with salty atmosphere of sulfate gas, corrosion may shorten the life of the air conditioner.
- 9) Since drain flows out of the outdoor unit, do not place under the unit anything which must be kept away from moisture.

NOTE

Cannot be installed hanging from ceiling or stacked.

CAUTION

When operating the air conditioner in a low outdoor ambient temperature, be sure to follow the instructions described below.

- 1) To prevent exposure to wind, install the outdoor unit with its suction side facing the wall.
- 2) Never install the outdoor unit at a site where the suction side may be exposed directly to wind.
- 3) To prevent exposure to wind, it is recommended to install a baffle plate on the air discharge side of the outdoor unit.
- 4) In heavy snowfall areas, select an installation site where the snow will not affect the unit.

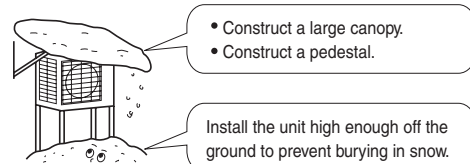

1.2.4 Outdoor Unit Installation Drawings

1 Precautions for humidifying hose installation work

- Moisture on the outdoor unit is brought to the indoor unit together with air around the outdoor unit during humidifying operation. Install the outdoor unit in a clean and calm location.
- When embedding © humidifying hose:
 - 1) Cannot be installed to the existing embedded piping. Embedding work is separately necessary.
- The length of the © humidifying hose is marked on the hose packing material.
 2. Use an extension hose (sold separately) when extending the humidifying hose.
 3. The length of the © humidifying hose needs to be set to ensure humidifying capacity. Cut off any excess hose. Use the remote control to set the hose length.
- When it is difficult to install without cutting the © humidifying hose, cut the hose and join it with included © joint or © elbow after the installation. When doing this, bind the hose using included © binding band so that there is no air leakage. (Refer to Connecting the Humidifying Hose on page 103.)
- When laying the © humidifying hose inside the wall, block the ends of the © humidifying hose with tape or the like to prevent water or anything else from entering it until it is connected to the indoor unit and outdoor unit ducts.
- Do not bend the © humidifying hose more than 90°.

INSTALLATION GUIDELINES

- Where a wall or other obstacle is in the path of outdoor unit's intake or exhaust airflow, follow the installation guidelines below.
- For any of the below installation patterns, the wall height on the exhaust side should be 1200mm or less.

Wall facing one side

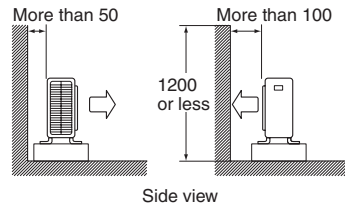

Walls facing two sides

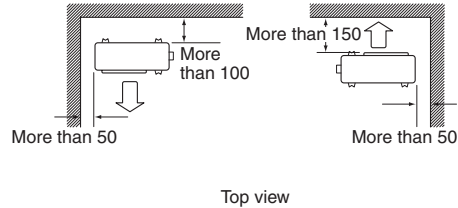

Walls facing three sides

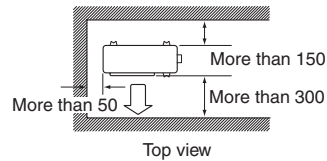

Unit: mm

PRECAUTIONS ON INSTALLATION

- Check the strength and level of the installation ground so that the unit will not cause any operating vibration or noise after installed.
- In accordance with the foundation drawing, fix the unit securely by means of the foundation bolts. (Prepare four sets of M8 or M10 foundation bolts, nuts and washers each which are available on the market.)
- It is best to screw in the foundation bolts until their length are 20mm from the foundation surface.

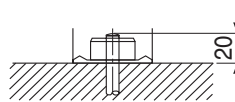

OUTDOOR UNIT INSTALLATION.

1. Installing outdoor unit.

- When installing the outdoor unit, refer to "Precautions for Selecting the Location" and the "Outdoor Unit Installation Drawings".
- If drain work is necessary, follow the procedures below.

2. Drain work (heat pump-models).

- Use ② drain plug for drainage.
- If the drain port is covered by a mounting base or floor surface, place additional foot bases of at least 30mm in height under the outdoor unit's feet.
- In cold areas, do not use a drain hose with the outdoor unit. (Otherwise, drain water may freeze, impairing heating performance.)

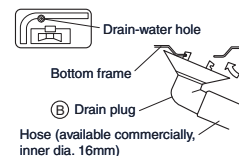

3. Flaring the pipe end.

- 1) Cut the pipe end with a pipe cutter.
- 2) Remove burrs with the cut surface facing downward so that the chips do not enter the pipe.
- 3) Put the flare nut on the pipe.
- 4) Flare the pipe.
- 5) Check that the flaring is properly made.

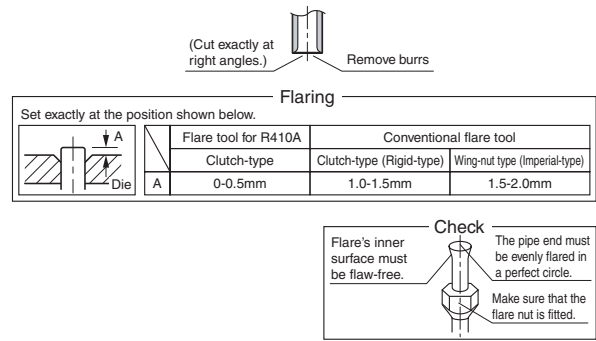

! WARNING

- 1) Do not use mineral oil on flared part.
- 2) Prevent mineral oil from getting into the system as this would reduce the lifetime of the units.
- 3) Never use piping which has been used for previous installations. Only use parts which are delivered with the unit.
- 4) Do never install a drier to this R410A unit in order to guarantee its lifetime.
- 5) The drying material may dissolve and damage the system.
- 6) Incomplete flaring may cause refrigerant gas leakage.

4. Refrigerant piping.

- 1) Align the centres of both flares and tighten the flare nuts 3 or 4 turns by hand. Then tighten them fully with the torque wrenches.
 - Use torque wrenches when tightening the flare nuts to prevent damage to the flare nuts and escaping gas.
- 2) To prevent gas leakage, apply refrigeration oil on both inner and outer surfaces of the flare. (Use refrigeration oil for R410A.)

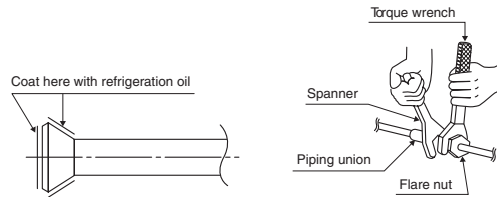

Flare nut tightening torque	
Gas side	Liquid side
3/8 inch	1/4 inch
32.7-39.9N • m (333-407kgf • cm)	14.2-17.2N • m (144-175kgf • cm)

Valve cap tightening torque	
Gas side	Liquid side
3/8 inch	1/4 inch
21.6-27.4N • m (220-280kgf • cm)	21.6-27.4N • m (220-280kgf • cm)
Service port cap tightening torque	10.8-14.7N • m (110-150kgf • cm)

5. Purging air and checking gas leakage.

- When piping work is completed, it is necessary to purge the air and check for gas leakage.

! WARNING

- 1) Do not mix any substance other than the specified refrigerant (R410A) into the refrigeration cycle.
- 2) When refrigerant gas leaks occur, ventilate the room as soon and as much as possible.
- 3) R410A, as well as other refrigerants, should always be recovered and never be released directly into the environment.
- 4) Use a vacuum pump for R410A exclusively. Using the same vacuum pump for different refrigerants may damage the vacuum pump or the unit.

- If using additional refrigerant, perform air purging from the refrigerant pipes and indoor unit using a vacuum pump, then charge additional refrigerant.
- Use a hexagonal wrench (4mm) to operate the stop valve rod.
- All refrigerant pipe joints should be tightened with a torque wrench at the specified tightening torque.

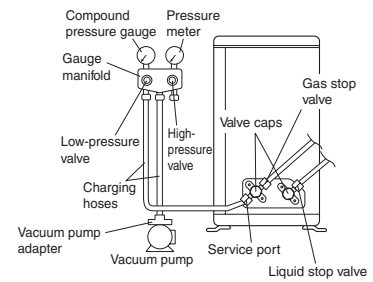

1) Connect projection side of charging hose (which comes from gauge manifold) to gas stop valve's service port.



2) Fully open gauge manifold's low-pressure valve (Lo) and completely close its high-pressure valve (Hi).
(High-pressure valve subsequently requires no operation.)



3) Do vacuum pumping and make sure that the compound pressure gauge reads -0.1MPa (-76cmHg).
(The vacuum pump should run for at least 10 min.)



4) Close gauge manifold's low-pressure valve (Lo) and stop vacuum pump.
(Keep this state for a few minutes to make sure that the compound pressure gauge pointer does not swing back.)*1.



5) Remove covers from liquid stop valve and gas stop valve.



6) Turn the liquid stop valve's rod 90 degrees counterclockwise with a hexagonal wrench to open valve.
Close it after 5 seconds, and check for gas leakage.
Using soapy water, check for gas leakage from indoor unit's flare and outdoor unit's flare and valve rods.
After the check is complete, wipe all soapy water off.



7) Disconnect charging hose from gas stop valve's service port, then fully open liquid and gas stop valves.
(Do not attempt to turn valve rod beyond its stop.)



8) Tighten valve caps and service port caps for the liquid and gas stop valves with a torque wrench at the specified torques.

*1 If the compound pressure gauge pointer swings back, refrigerant may have water content or a loose pipe joint may exist.
Check all pipe joints and retighten nuts as needed, then repeat steps 2) through 4).

6. Refilling the refrigerant.

Check the type of refrigerant to be used on the machine nameplate.

Precautions when adding R410A

Fill from the liquid pipe in liquid form.

It is a mixed refrigerant, so adding it in gas form may cause the refrigerant composition to change, preventing normal operation.

- 1) Before filling, check whether the cylinder has a siphon attached or not. (It should have something like "liquid filling siphon attached" displayed on it.)

Filling a cylinder with an attached siphon

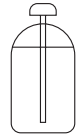

Stand the cylinder upright when filling.

(There is a siphon pipe inside, so the cylinder need not be upside-down to fill with liquid.)

Filling other cylinders



Turn the cylinder upside-down when filling.

- Be sure to use the R410A tools to ensure pressure and to prevent foreign objects entering.

7. Refrigerant piping work.

7-1. Cautions on pipe handling.

- 1) Protect the open end of the pipe against dust and moisture.
- 2) All pipe bends should be as gentle as possible. Use a pipe bender for bending.(Bending radius should be 30 to 40mm or larger.)

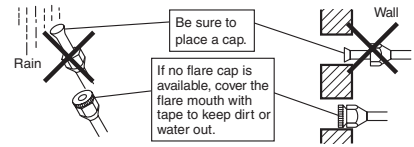

7-2. Selection of copper and heat insulation materials.

When using commercial copper pipes and fittings, observe the following:

- 1) Insulation material: Polyethylene foam
Heat transfer rate: 0.041 to 0.052W/mK (0.035 to 0.045kcal/mh•°C)
Refrigerant gas pipe's surface temperature reaches 110°C max.
Choose heat insulation materials that will withstand this temperature
- 2) Be sure to insulate both the gas and liquid piping and to provide insulation dimensions as below.

Seal the edge of the insulation if there is a possibility that the condensation from the shut-off valve might drip onto the indoor unit through the gap between the insulation and the pipe.

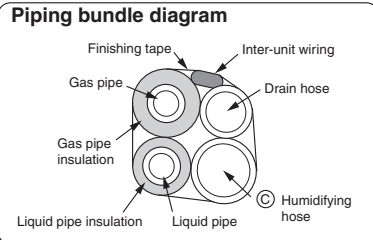
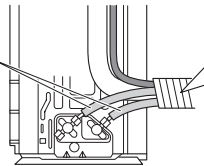

Gas side	Liquid side	Gas pipe thermal insulation	Liquid pipe thermal insulation
O.D. 9.5mm	O.D. 6.4mm	I.D. 12-15mm	I.D. 8-10mm
Thickness 0.8mm		Thickness 10mm Min.	

- 3) Use separate thermal insulation pipes for gas and liquid refrigerant pipes.

PUMP DOWN OPERATION

In order to protect the environment, be sure to pump down when relocating or disposing of the unit.

1. Remove the valve cap from liquid stop valve and gas stop valve.
2. Carry out forced cooling operation.
3. After five to ten minutes, close the liquid stop valve with a hexagonal wrench.
- 4) After two to three minutes, close the gas stop valve and stop forced cooling operation.

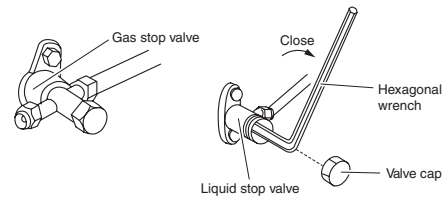

How to force cooling operation mode

■ Using the indoor unit operation/stop button

Press the indoor unit operation/stop button for at least five seconds. (Operation will start.)

- Forced cooling operation will stop automatically after around 15 minutes. To force a test run to stop, press the indoor unit operation/stop button.



CAUTION

After closing the liquid stop valve, close the gas stop valve within three minutes, then stop the forced operation

CONNECTING THE HUMIDIFYING HOSE

1. Connecting the humidifying hose.

- 1) Connect the © humidifying hose to the outdoor humidifying duct.
- 2) Apply a ƒ binding band to prevent the © humidifying hose from coming off.

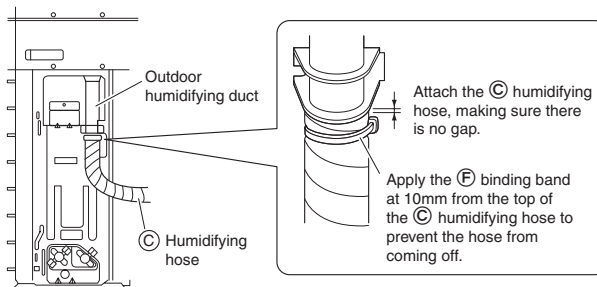

Binding part of binding band

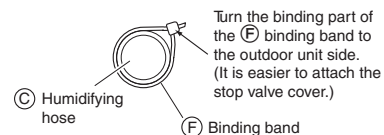

2. Connecting the cut humidifying hoses.

- When installing the cut © humidifying hoses, follow the instructions below

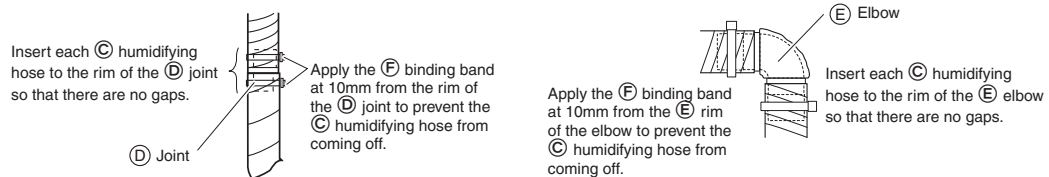

- Use not more than 2 elbows to ensure humidifying capacity.

! WARNING

- 1) Do not use tapped wires, stranded wires (**CAUTION (1)**), extension cords, or starburst connections, as they may cause over-heating, electrical shock, or fire.
- 2) Do not use locally purchased electrical parts inside the product. (Do not branch the power for the drain pump, etc., from the terminal block.) Doing so may cause electric shock or fire.
- 3) Be sure to install an earth leak detector. (One that can handle higher harmonics.) (This unit uses an inverter, which means that it must be used an earth leak detector capable handling harmonics in order to prevent malfunctioning of the earth leak detector itself.)
- 4) Use an all-pole disconnection type breaker with at least 3mm between the contact point gaps.
- 5) The earth leakage circuit breaker must operate at 30mA or lower.

- Do not turn ON the safety breaker until all work is completed.

- 1) Strip the insulation from the wire (20mm).
- 2) Connect the connection wires between the indoor and outdoor units **so that the terminal numbers match**. Tighten the terminal screws securely. We recommend a flathead screwdriver be used to tighten the screws. The screws are packed with the terminal board.

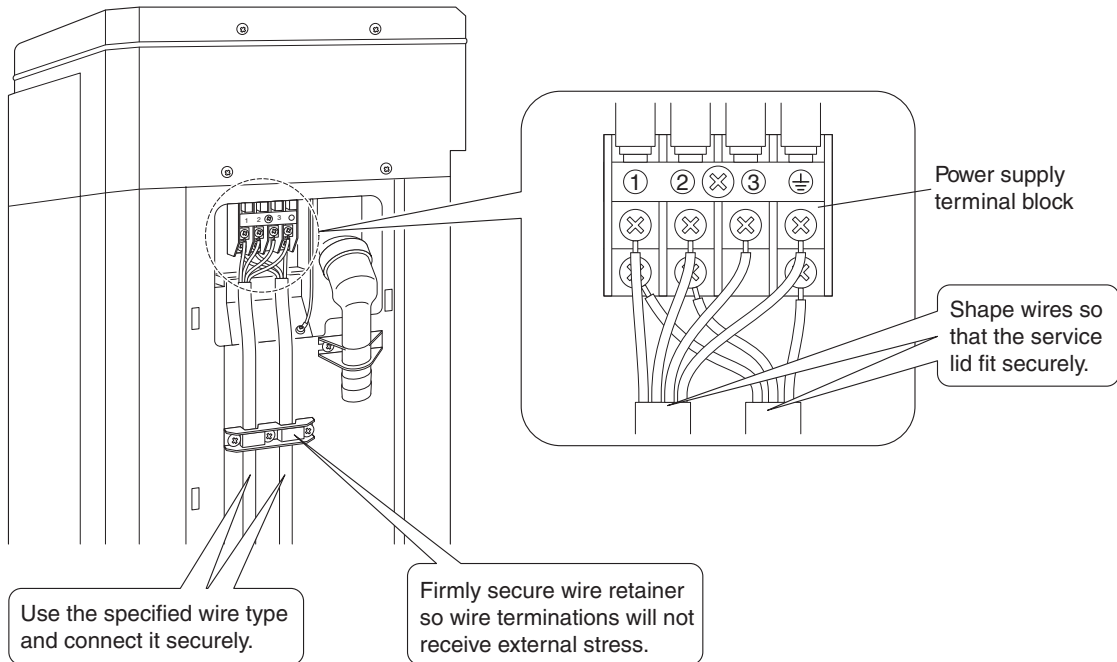
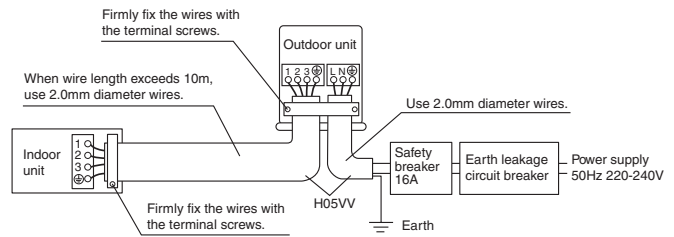

! CAUTION (1)

In case using stranded wires is unavoidable for some reason, make sure to install the round crimp-style terminals on the tip.

Place the round crimp-style terminals on the wires up to the covered part and secure in place.

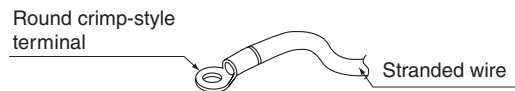

<Ground terminal installation>

1) Use the following method when installing a single core wire.

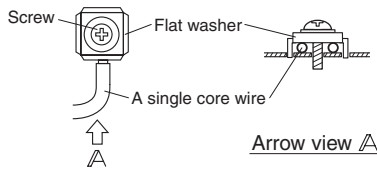

2) Use the following method when installing the round crimp-style terminal.

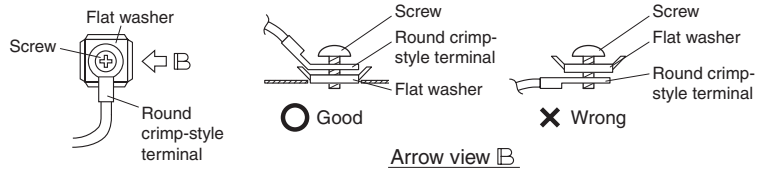

CAUTION(2)

When connecting the connection wires to the terminal board using a single core wire, be sure to perform curling. Problems with the work may cause heat and fires.

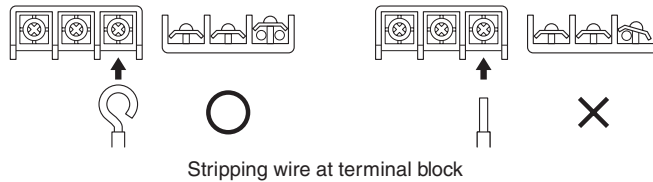

TEST RUN AND FINAL CHECK

1. Trial operation and testing.

- Measure the supply voltage and make sure that it falls in the specified range.
- See “Test Run and Final Check” in the installation manual that came with the indoor unit for details on how to perform the test run and what to check for.

2. Test items.

Test items	Symptom (diagnostic display on RC)	Check
Outdoor unit is installed properly on a solid base.	Fall, vibration, noise	
No refrigerant gas leaks.	Incomplete cooling/heating function	
Refrigerant gas and liquid pipes and indoor drain hose extension are thermally insulated.	Water leakage	
Draining line is properly installed.	Water leakage	
System is properly earthed.	Electrical leakage	
The specified wires are used for interconnecting wire connections.	Inoperative or burn damage	
Outdoor unit's air intake or exhaust has clear path of air. Stop valves are opened.	Incomplete cooling/heating function	

2. System Configuration

After the installation and test operation of the room air conditioner have been completed, it should be operated and handled as described below. Every user would like to know the correct method of operation of the room air conditioner, to check if it is capable of cooling (or heating) well, and to know a clever method of using it.

In order to meet this expectation of the users, giving sufficient explanations taking enough time can be said to reduce about 80% of the requests for servicing. However good the installation work is and however good the functions are, the customer may blame either the room air conditioner or its installation work because of improper handling. The installation work and handing over of the unit can only be considered to have been completed when its handling has been explained to the user without using technical terms but giving full knowledge of the equipment.





3. Instruction



3.1 Safety Precautions







- Keep this manual where the operator can easily find them.
- Read this manual attentively before starting up the unit.
- For safety reason the operator must read the following cautions carefully.
- This manual classifies precautions into WARNING and CAUTION. Be sure to follow all precautions below: they are all important for ensuring safety.

 **WARNING.....If you do not follow thes instructions exactly, the unit may cause property damage, personal injury or loss of life.**

 **CAUTION.....If you do not follow thes instructions exactly, the unit may cause minor or moderate property damage or personal injury.**

 Never do.	 Be sure to follow the instructions..	 Be sure to earth the air conditioner
 Never cause the air conditioner (including the remote control) to get wet.	 Never touch the air conditioner (including the remote control) with a wet hand.	

 WARNING	
<ul style="list-style-type: none"> • In order to avoid fire, explosion or injury, do not operate the unit when harmful, among which flammable or corrosive gases, are detected near the unit.  • It is not good for health to expose your body to the air flow for a long time. • Do not put a finger, a rod or other objects into the air outlet or inlet. As the fan is rotating at a high speed, it will cause injury. • Do not attempt to repair, relocate, modify or reinstall the air conditioner by yourself. Incorrect work will cause electric shocks, fire etc. For repairs and reinstallation, consult your Daikin dealer for advice and information. • Do not insert fingers, poles, or other objects into the moving parts of the front panel or the outlet vent panel. 	<ul style="list-style-type: none"> • The refrigerant used in the air conditioner is safe. Although leaks should not occur, if for some reason any refrigerant hap-pens to leak into the room, make sure it does not come in con-tact with any flame as of gas heaters, kerosene heaters or gas range.  • If the air conditioner is not cooling (heating) properly, the refrigerant may be leaking, so call your dealer.When carrying out repairs accompanying adding refrigerant, check the content of the repairs with our service staff. • Do not attempt to install the air conditioner by your self. Incorrect work will result in water leakage, electric shocks or fire. For installation, consult the dealer or a qualified technician. • In order to avoid electric shock, fire or injury, if you detect any abnormally such as smell of fire, stop the operation and turn off the breaker. And call your dealer for instructions.

 CAUTION	
<ul style="list-style-type: none"> • The air conditioner must be earthed. Incomplete earthing may result in electric shocks. Do not connect the earth line to a gas pipe, water pipe, lightning rod, or a telephone earth line.  • In order to avoid any quality deterioration, do not use the unitfor cooling precision instruments, food, plants, animals or works of art.  • Never expose little children, plants or animals directly to the air flow • Do not place appliances which produce open fire in places exposed to the air flow from the unit or under the indoor unit. It may cause incomplete combustion or deformation of the unit due to the heat • Do not block air inlets nor outlets. Impaired air flow may result in insufficient performance or trouble. • Do not stand or sit on the outdoor unit. Do not place any object on the unit to avoid injury, do not remove the fan guard. • Do not place anything under the indoor or outdoor unit that must be kept away from moisture. In certain conditions, moisture in the air may condense and drip. • After a long use, check the unit stand and fittings for damage • Do not touch the air inlet and aluminum fins of outdoor unit. It may cause injury. • The appliance is not intended for use by young children or infirm sons without supervision. • Young children should be supervised to ensure that they do not with the appliance. 	<ul style="list-style-type: none"> • To avoid oxygen deficiency, ventilate the room sufficiently if equipment with burner is used together with the air conditioner.  • Before cleaning, be sure to stop the operation, turn the breaker off or pull out the supply cord. • Do not connect the air conditioner to a power supply different from the one as specified. It may cause trouble or fire. • Depending on the environment, an earth leakage breaker must be installed. Lack of an earth leakage breaker may result in electric shocks, or fire. • Arrange the drain hose to ensure smooth drainage. Incomplete draining may cause wetting of the building, furniture etc. • Do not place objects in direct proximity of the outdoor unit and do not let leaves and other debris accumulate around the unit.Leaves are a hotbed for small animals which can enter the unit. Once in the unit, such animals can cause malfunctions, smoke or fire when making contact with electrical parts. • Do not operate the air conditioner with wet hands.  • Do not wash the indoor unit with excessive water, only use a slightly wet cloth.  • Do not place things such as vessels containing water or anything else on top of the unit. Water may penetrate into the unit and degrade electrical insulations, resulting in an electric shock.

Installation site	Electrical work
<ul style="list-style-type: none"> ■ To install the air conditioner in the following types of environments, consult the dealer. <ul style="list-style-type: none"> • Places with an oily ambient or where steam or soot occurs. • Salty environment such as coastal areas. • Places where sulfide gas occurs such as hot springs. • Places where snow may block the outdoor unit. <p>The drain from the outdoor unit must be discharged to a place of good drainage.</p>	<ul style="list-style-type: none"> • For power supply, be sure to use a separate power circuit dedicated to the air conditioner.
Consider nuisance to your neighbours from noises	System relocation
<ul style="list-style-type: none"> ■ For installation, choose a place as described below. <ul style="list-style-type: none"> • A place solid enough to bear the weight of the unit which does not amplify the operation noise or vibration. • A place from where the air discharged from the outdoor unit or the operation noise will not annoy your neighbours. 	<ul style="list-style-type: none"> • Relocating the air conditioner requires specialized knowledge and skills. Please consult the dealer if relocation is necessary for moving or remodeling.

3.2 Names of Parts

■ Indoor Unit

- 1. **Streamer unit:** (page 125-127.)
- 2. **Deodorizing filter for streamer (Black)**
- 3. **Air inlet**
- 4. **Front panel**
- 5. **Upper panel**
- 6. **Air filter (Light blue):** (page 124.)
- 7. **Titanium apatite photocatalytic air-purifying filter (Black):** (page 125-127.)
- 8. **Air supply filter (Yellow):** (page 128.)
- 9. **Horizontal louver:** (page 115.)
- 10. **Vertical louver:**
 - In the air outlet. (page 115.)
- 11. **Air outlet**
- 12. **Room humidity sensor:**
 - It senses the air humidity around the indoor unit.
- 13. **Room temperature sensor:**
 - It senses the air temperature around the indoorunit.
- 14. **Display**
- 15. **Indoor unit ON/OFF switch**
 - Push this switch once to start operation. Push once again to stop it.
- 16. **Multi-colored indicator lamp:**
 - The lamp color changes according to the operation.
 - HEATING.....Red
 - “URURU” HUMIDIFYING / HUMID HEATING.....Orange
 - COOLING.....Green
 - “SARARA” DRYING / DRY COOLING.....Yellow
 - The lamp color also changes according to the optional function.
 - FLASH STREAMER AIR PURIFYING / FRESH AIR SUPPLY VENTILATION...White (Only for the first 2 seconds during operation of the air conditioner.)
- 17. **TIMER lamp (Orange):** (page 117.)
- 18. **MOISTURIZING lamp (Green):** (page 114.)
- 19. **Signal receiver:**
 - Receives / sends signals from/to the remote control.
 - The multi-colored indicator lamp blinks with beep sound to indicate signal reception.
 - Operation starttwo beeps
 - Settings changed.....one beep
 - Operation stop.....long beep.

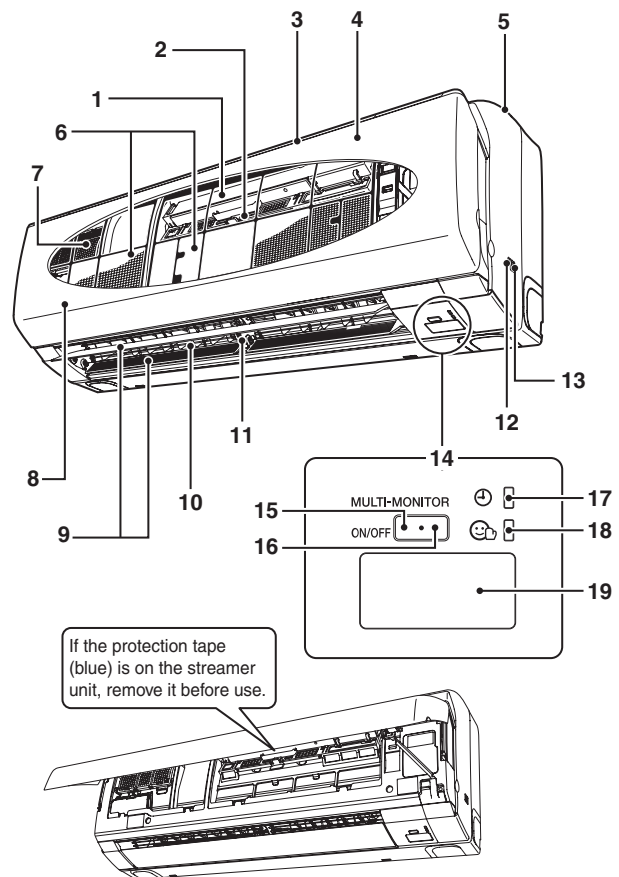

■ Outdoor Unit

- 20. **Humidify unit air outlet:** (Front side)
- 21. **Air inlet:** (Back and left side)
- 22. **Air outlet**
- 23. **Humidify unit air intake:** (Front and back)
- 24. **Outdoor temperature sensor:**
 - It senses the air temperature around the out-door unit. (Back side)
- 25. **Refrigerant piping, humidifying hose and inter-unit cable**
- 26. **Drain hose:**
 - Drains water coming from the indoor unit.
- 27. **Earth terminal:**
 - It is inside of this cover.

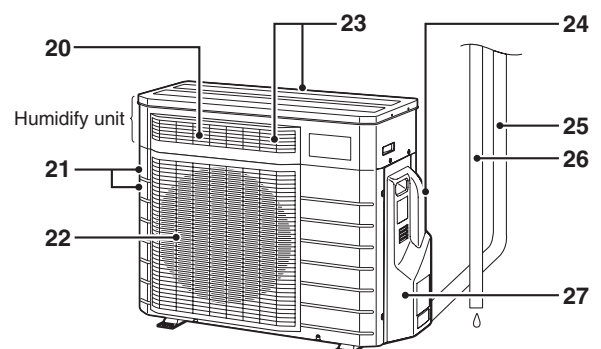

Remote control

1. Transmitter / Receiver

2. Display:

- It displays the current settings. (In this illustration, each section is shown with all its displays ON for the purpose of explanation.)
- * The protection sheet is on the display to protect against scratch. Remove it before use.

3. INFORMATION button:

- Displays the indoor temperature and humidity and the outdoor temperature. (page 121.)

4. COUNTDOWN OFF TIMER button:

- Sets time to stop. (page 117.)

5. ON/OFF button:

- Stops operation selected with the direct operation button. Another press will restart the same operation.

6. Direct operation button:

- AUTO button (page 114.)
- “URURU” HUMIDIFYING button (page 113.)
- HEATING button (page 113.)
- “SARARA” DRYING button (page 112.)
- COOLING button (page 112.)

7. POWERFUL button:

- Makes cooling or heating more powerful. (Canceled in 20 minutes.) (page 118.)

8. TEMPERATURE adjustment buttons:

- It changes the temperature setting.

9. HUMIDITY buttons:

- It changes the humidity setting.

10. FLASH STREAMER AIR PURIFYING / FRESH AIR SUPPLY VENTILATION button:

- Cleans the room air. (page 116.)

11. AIRFLOW DIRECTION / AIRFLOW RATE / COMFORT AIRFLOW / COOLING BREEZE button:

- Adjusts air direction and volume. (page 115.)

12. MOISTURIZING button:

- Keeps humidity high to moisturizes your skin. (page 114.)

13. HOME LEAVE VENTILATION button:

- Ventilates the room during home leaving.

14. SET UP button:

- Sets the unit operation and remote control display according to your preference. (page 119.)

15. TIMER SELECT button

16. TIMER Setting button:

- Sets the time for timer-on or timer-off. (page 117.)

17. CLOCK button:

- Sets the present time. (page 111.)

18. MOLD SHOCK OUT button:

- Continuously runs the dehumidifying operation to keep the room air dry and clean. (page 121.)

19. MOLD PROOF button:

- Dries the inside of the unit to prevent mold and odor growth. (page 120.)

20. COMFORT SLEEP button:

- Controls the room temperature to support comfortable sleep and pleasant wake-up. (page 118.)

21. RESET button:

- Cleaning indicator reset. (page 122.)

22. CANCEL button

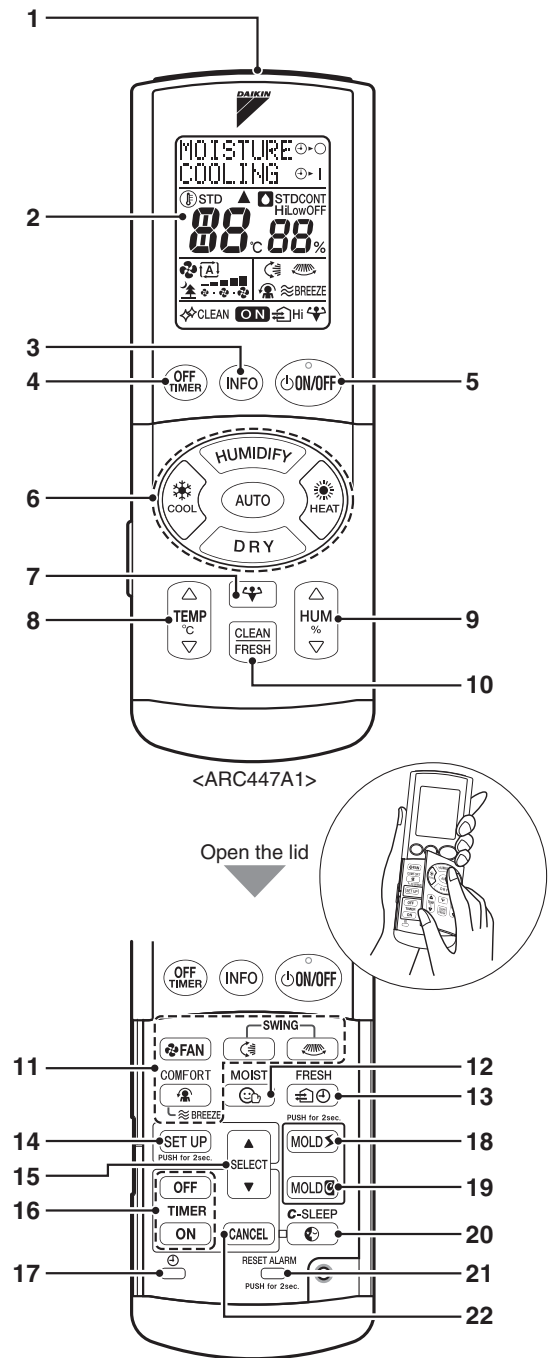

3.3 Preparation before Operation

■ To set the batteries

1. Press “” with a finger and slide the cover to take it off.
2. Set two dry batteries (AAA).
3. Set the cover as before.
 - Characters on the display will blink. Set the present time. (page 111.)

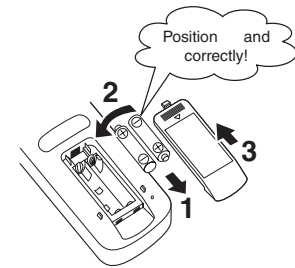

■ How to use

- To use the remote control, aim the transmitter at the indoor unit. If there is anything to block signals between the unit and the remote control, such as a curtain, the unit will not operate.
- The maximum distance for communication is about 7m.
- Do not drop the remote control. Do not get it wet. (Damage to LCD may occur.)

■ To fix the remote control holder on the wall

1. Choose a place from where the signals reach the unit.
2. Fix the remote control holder to a wall or pillar using the included screws.
3. Hook the holes on back of the remote control to the protruding tabs on the remote control holder.

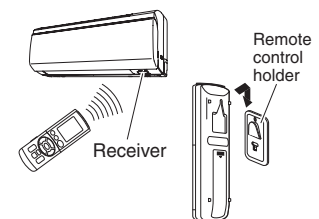

■ Attach the Titanium apatite photocatalytic air-purifying filter, deodorizing filter for streamer, and air supply filter (page 125, 128.)

■ Turn on the power breaker

- Turning on the power breaker will cause the front panel and horizontal louver to open once and then close again. (This is a normal procedure.)

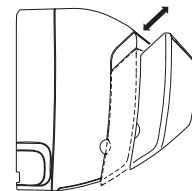

CAUTION

- During operation (i.e. when the panel is open or being opened or closed), do not touch the panel with your hands.

ATTENTION

- Wrap the terminals with tape to insulate them before discarding batteries. Mixing with other metals or batteries may cause heat, explosion or fire.

PRECAUTION

■ About batteries

- The included batteries are provided to be used at first. Depending on when the air conditioner was manufactured, these batteries may run out in less than a year.
- We recommend replacing once a year, although if the remote control display begins to fade or if reception deteriorates, please replace with new alkaline batteries.
- When replacing the batteries, use batteries of the same type, and replace the two old batteries together.
- Batteries close to their expiration dates will have to be replaced sooner.
- To prevent breakage or injury due to leaking or explosion, remove the batteries if the unit is not used for a long period of time.

■ About remote control

- Signal communication may be disabled if an electronic-starter-type fluorescent lamp (such as inverter-type lamps) is in the room. Consult the shop if that is the case.
- If the remote control signals happen to operate another appliance, move that appliance to somewhere else, or consult the shop.
- Direct sunlight on the transmitter/receiver may cause the unit to work harder.

■ To set the clock

* Time cannot be set during unit operation.

1. Press “”.

- Do not hold the button.



2. Press “” to set the clock to the present time.

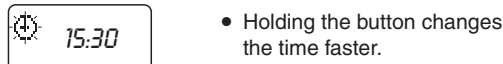

3. Press “”.



- Setting is complete.

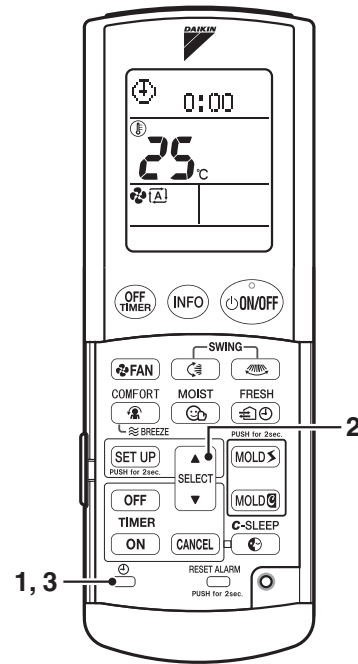

ATTENTION

If other messages than time appear on the display with the step 1 operation, do not operate the button for about 60 seconds. The display will return to normal.

■ Tips for saving energy

- Be careful not to cool (heat) the room too much. Keeping the temperature setting at a moderate level helps save energy.
- Cover windows with a blind or a curtain. Blocking sunlight and air from outdoors increases the cooling (heating) effect.
- Clogged air filters cause inefficient operation and waste energy. Periodically clean the filter.

Recommended temperature setting
For cooling : 26°C – 28°C
For heating : 20°C – 22°C

■ Please note

- The air conditioner consumes power even when it is not operating.
- If you are not going to use the air conditioner for a long period, for example in spring or autumn, turn the breaker OFF.
- When the outdoor temperature is below –15°C, turn on the breaker more than 1 hour before starting the operation. (This is to warm up the compressor.)

■ Operating conditions

- Running the unit under conditions not listed below may cause the safety device to activate, stopping the unit. Also, condensation may form on the indoor unit and drip. (DRY / COOLING operation)

COOLING	Outdoor temperature : 21 to 43°C Indoor temperature : 18 to 32°C Indoor humidity : 80% max.	HEATING	Outdoor temperature : –20 to 24°C Indoor temperature : 10 to 30°C Indoor humidity : 70% max.
DRY	Outdoor temperature : 10 to 42°C Indoor temperature : 18 to 30°C Indoor humidity : 80% max.	HUMIDIFYING	Outdoor temperature : –10 to 24°C Indoor temperature : 12 to 30°C Indoor humidity : 70% max.

■ Reachable Humidity

- The ability of humidification drops when the outdoor temperature and humidity are low. (See Fig. 1 as reference.)

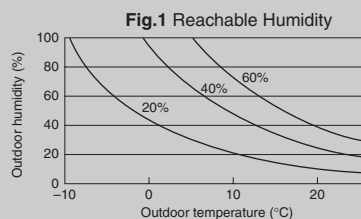

3.4 Cooling. “SARARA” DRYING Operation”

■ COOLING operation

- To lower temperature

1. Press “”.

COOLING



- To lower temperature and humidity

2. Press “”.

DRY COOLING



* It is recommended to switch to COOLING operation if you want to lower temperature preferentially during DRY COOLING operation.

■ “SARARA” DRYING operation

- To lower humidity

3. Press “”.

DRYING





■ To change the airflow direction and airflow rate (page 115.)

- The airflow rate is set to “AUTO” during DRY COOLING or “SARARA” DRYING operation. Airflow rate cannot be changed.

■ To stop operation

4. Press “”.
- The multi-colored indicator of the unit will go off.

■ To change the temperature or humidity setting

	COOLING	DRY COOLING	DRY
		18°C – 32°C	-3°C – STD
	OFF	HIGH ⇄ STD ⇄ LOW ⇄ CONT	HIGH ⇄ STD ⇄ LOW ⇄ CONT
	Green	Yellow	

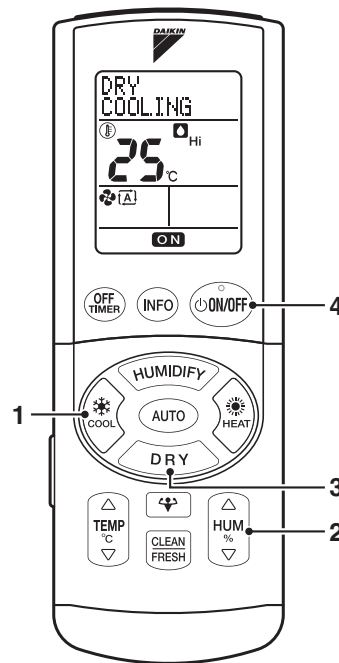

NOTE

- **Note on ON / OFF button**
 - Pressing “” will start the same operation as the last time.
- **Note on COOLING operation**
 - This air conditioner cools the room by blowing the hot air in the room outside, so if the outside temperature is high, performance drops.
- **Note on DRY COOLING**
 - Pressing the humidity button down in COOLING mode set the unit to DRY COOLING.
 - Removes more humidity than the normal COOLING operation. It is recommended, however, to set temperature slightly lower than the room temperature to lower humidity because this operation mode does not heat air supplementary.
- **Note on “SARARA” DRYING operation**
 - Removes humidity with less lowering of the room temperature by heating air supplementary.
 - The operation mode change from COOLING to “SARARA” DRYING may raise humidity temporarily.

3.5 Heating. “URURA” HUMIDIFYING Operation”

■ Heating operation

- To raise temperature



- To raise temperature and humidity



■ “URURU” HUMIDIFYING operation

- To raise humidity

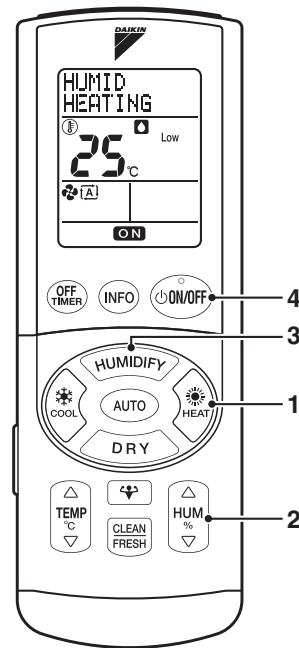



■ To change the airflow direction and airflow rate (page 115.)

■ To stop operation

4. Press “”.
- The multi-colored indicator of the unit will go off.

■ To change the temperature or humidity setting

	HEATING	HUMID HEATING	HUMIDIFYING
		10°C – 30°C	—
		OFF ⇄ LOW ⇄ STD ⇄ HIGH ⇄ CONT	LOW ⇄ STD ⇄ HIGH ⇄ CONT
	Red	Orange	

NOTE

■ Note on HEATING operation

- Since this air conditioner heats the room by taking heat from outdoor air to indoors, the HEATING capacity becomes smaller in lower outdoor temperatures. If the HEATING effect is insufficient, it is recommended to use another HEATING appliance in combination with the air conditioner.
- The heat pump system heats the room by circulating hot air around all parts of the room. After the start of HEATING operation, it takes some time before the room gets warmer.
- In HEATING operation, frost may occur on the outdoor unit and lower the HEATING capacity. In that case, the system switches into defrosting operation to take away the frost.
- During defrosting operation, hot air does not flow out of indoor unit.

■ Note on HUMID HEATING and “URURU” HUMIDIFYING operation

- The ability of the unit to humidify drops when the outdoor temperature and humidity are low, or when the set fan strength is low.
- The operation noise is higher than in normal HEATING.
- The outdoor noise or odor may be captured because the outdoor air is heated with the heater and resultant moisture is taken into the room for humidification.
- The top of the outdoor unit may get warm during operation, but this is not a malfunction.
- The operation noise may change depending on the outdoor temperature and humidity. (Water supply is not necessary because moisture from the outdoor air is taken into the room.)

■ Note on “URURU” HUMIDIFYING operation

- Can adjust the room humidity only according to your preference.
- When the room temperature gets low, slight heating may be on to continue humidification.

3.6 AUTO / MOISTURIZING Operation

AUTO OPERATION

After pressing the AUTO button, the air conditioner will operate according to room conditions in an automatic mode

1. Press “  ”.

- The color of the multi-colored indicator changes according to the actual operations.
- When the AUTO button is pressed, the color according to the operation selected by the air conditioner will light up.

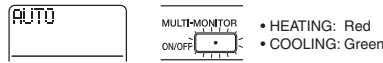

■ To change the airflow direction and airflow rate

(page 115.)

■ To stop operation

2. Press “  ”.

The multi-colored indicator of the unit will go off.

■ To change the temperature setting

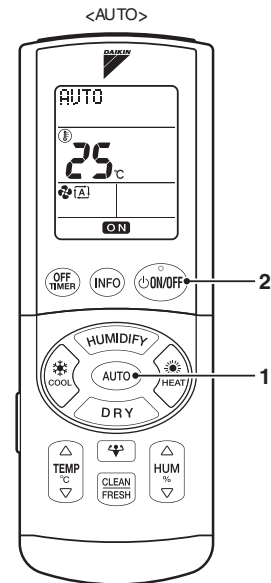

NOTE

■ Note on AUTO operation

- In AUTO operation, the system selects an appropriate operation mode (COOLING or HEATING) based on the room temperature at the start of the operation.
- The system automatically reselects setting at a regular interval to bring the room temperature to user setting level.
- If you do not like AUTO operation, you can manually select the operation mode and setting you like.

MOISTURIZING OPERATION

This mode moisturizes your skin.

1. Press “  ” during operation.

- The airflow rate and airflow direction settings are changed to auto and COMFORAIRFLOW MODE respectively.
- In MOISTURIZING operation, COOLING BREEZE mode cannot be selected.

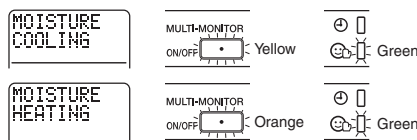

■ To change the temperature setting

- The same changes as COOLING and HEATING are possible. (page 112, 113.)
- Humidity and airflow rate cannot be changed..

■ To change the airflow direction (page 115.)

- The recommended airflow direction is COMFORT AIRFLOW MODE, but it can be changed.

■ To change the MOISTURIZING operation

2. Press “  ” again.

- The operation mode goes back to the previous one. The multi-colored indicator on the unit also goes back to the previous color.
- The MOISTURE lamp on the unit will go off.

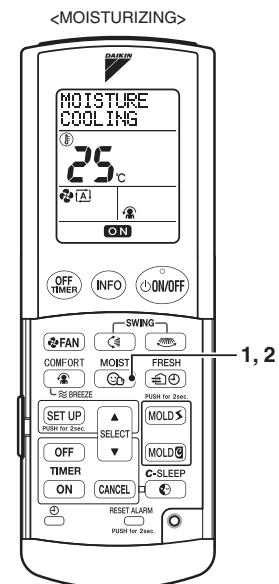

NOTE

■ Note on MOISTURIZING operation

- The relative humidity is higher than in normal operation.
- Can be used for COOLING, DRY COOLING, HEATING and HUMID HEATING.
- The operation noise is slightly louder.

3.7 ADJUSTING AIRFLOW DIRECTION · COMFORT AIR-FLOW MODE · COOLING BREEZE · AIRFLOW RATE

More comfortable airflow is provided with airflow direction and airflow rate adjustment.

■ **To change vertical and horizontal airflow directions**

1. Press “” or “” during operation.
 - The airflow direction indication will display (incase of vertical direction)

The horizontal and vertical louvers respectively move vertically and horizontally automatically.

■ **If you want to fix airflow direction**

2. Press “” or “” again.

■ **To use 3-D AIRFLOW**

3. Press “” and then “” during operation.
 - The vertical and horizontal airflow direction indications will display.

The horizontal and vertical louvers move alternately.

■ **To cancel 3-D AIRFLOW**

4. Press “” or “” again.

■ **COMFORT AIRFLOW MODE and COOLING BREEZE operation**

- 5. The indication will change every time “” is pressed.



■ **COMFORT AIRFLOW MODE operation**

- The airflow direction and airflow rate are adjusted so that the air from the unit does not blow directly on the occupants of the room.
- < COOLING/DRYING> The flap will go up.
- <HEATING/HUMIDIFYING> The flap will go down.
- The airflow rate is set to “AUTO”.

■ **COOLING BREEZE operation**

- COOLING BREEZE operation is for COOLING, “SARARA” DRYING and FLASH STREAMER AIR PURIFYING operation.

■ **To change the airflow rate**

6. Press “” during operation. (Refer to right table)
 - COOLING or HEATING with “” or other weak airflow rate may not cool or heat the room sufficiently.
 - Indoor unit quiet operation. When the air flow is set to “”, the noise from the indoor unit will become quieter

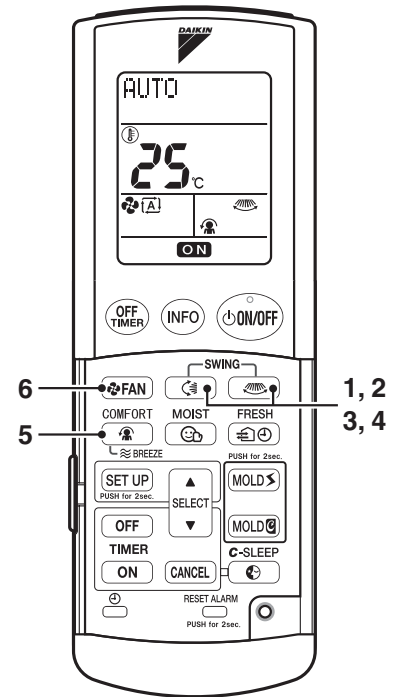

Operating mode	Airflow rate setting		
“SARARA” DRYING		●	●
DRY COOLING		●	●
MOISTURIZING		●	
AUTO / COOLING		●	●
HEATING		●	
HUMID HEATING		●	
“URURU” HUMIDIFYING			
FLASH STREAMER AIR PURIFYING / FRESH AIR SUPPLY VENTILATION			●

: COMFORT AIRFLOW MODE operation is possible.
 : COOLING BREEZE operation is possible.
 Five levels of air flow rate setting from “” to “” plus “” “” are available.

NOTE

- If the unit is operated with the horizontal louvers pointed down and stopped in COOLING, “SARARA” DRYING, or DRY COOLING operation, the louvers will move automatically after about one hour. (This is to prevent condensation from forming on them.)

■ **ATTENTION**

- Be sure to use the remote control to adjust the airflow direction. Manual operation of the louvers may cause it to work improperly.

■ **Note on COMFORT AIRFLOW MODE operation**

- The airflow direction is as fig.1;

■ **Note on COOLING BREEZE operation**

- The vertical movement of the horizontal louvers with “1/ f breeze” rhythm provides comfort air like natural breeze. The room temperature is felt cooler with cooling breeze.

■ **Note on Adjusting the vertical airflow direction**

- The movable area for the horizontal louver is different depending on the operation mode.

■ **Note on 3-D AIRFLOW**

- Using 3-D AIRFLOW circulates cold air, which tends to be collected at the bottom of the room, and hot air, which tends to be collected near the ceiling, throughout the room, preventing areas of cold and hot from developing.

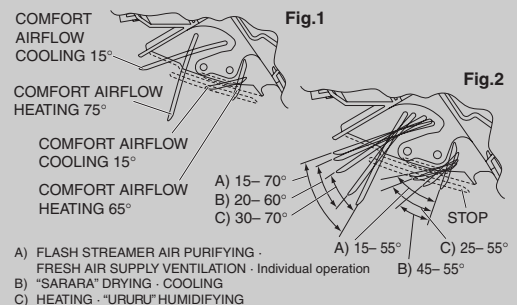

3.8 FLASH STREAMER AIR PURIFYING · FRESH AIR SUPPLY VENTILATION Operation / HOME LEAVE VENTILATION

FLASH STREAMER AIR PURIFYING

The absorption power of the Titanium apatite photocatalytic air-purifying filter and air supply filter and the resolving power of the streamer discharge reduce bad odors and viruses, cleaning the room air.

1. Press “”.

(Can be used together with heating or cooling, or on its own.)

- Changes every time the button is pressed. (Use instead of FAN operation.)

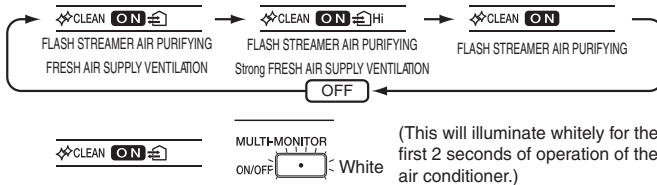

■ To change the airflow direction and airflow rate (page 115.)

FLASH STREAMER AIR PURIFYING / FRESH AIR SUPPLY VENTILATION>

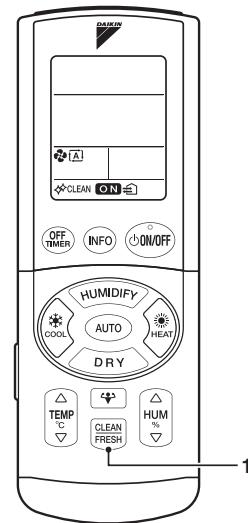

ATTENTION

- Temperature and humidity cannot be changed during FLASH STREAMER AIR PURIFYING or FRESH AIR SUPPLY VENTILATION operation only.

NOTE

- **Note on FLASH STREAMER AIR PURIFYING operation**
 - The streamer discharge energy and Titanium apatite photocatalytic air-purifying filter clean the air in the room.
- **Note on FRESH AIR SUPPLY VENTILATION operation**
 - Fresh air is taken from outdoor through the outdoor unit.
 - The outdoor noise and odor may be captured because the outdoor air is taken into the room. The operation noise is slightly louder.
 - The operation noise may change depending on the outdoor temperature and humidity.
- **What is streamer discharge?**
 - It generates high-speed electron with high oxidizing power in the unit to resolve odor and harmful gas. (It is safe because the high-speed electron is generated and goes away inside the unit.)
 - * The streamer discharge fizzes, but this is not a malfunction.

HOME LEAVE VENTILATION

Ventilates the room during your absence to maintain it comfortable.

1. Press “”.



- Stops automatically after 4 hours.
- The default setting is 4 hours.

■ To change the time to stop

2. Press “”.

- It can be set to between 1 and 9 hours, in 1-hour increments.
- To use both HOME LEAVE VENTILATION and ON TIMER, set the ON TIMER first. (page 117.)

■ To change the airflow direction (page 115.)

- Temperature, humidity and airflow rate cannot be changed.

■ To cancel the HOME LEAVE VENTILATION

3. Press “”.

<HOME LEAVE VENTILATION>

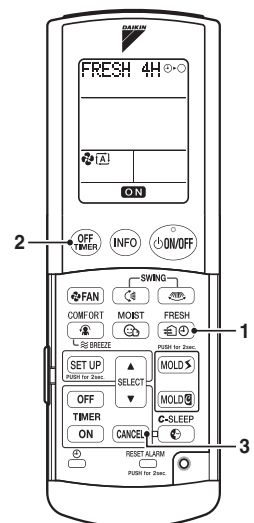

NOTE

- **Note on HOME LEAVE VENTILATION**
 - The FRESH AIR SUPPLY VENTILATION operation and COUNTDOWN OFF TIMER can be set with one button at the same time.

3.9 TIMER Operation

Timer functions are useful for automatically switching the air conditioner on or off at night or in the morning. The timer operates only one time. Set the timer for each use.

■ COUNTDOWN OFF TIMER operation

Set the time to stop.

1. Press “OFF TIMER”.

- The displayed time, which changes in 0.5 hour increments every time the button is pressed, is set. The time from 0.5 to 9.5 hours can be set.



■ ON/OFF TIMER operation

Set time for ON TIMER or OFF TIMER.

- Check that the clock is correct. If not, set the clock to the present time. (page 111.)
 - The present time display disappears when the time ON/OFF TIMER is reserved.
2. Press “OFF” for OFF TIMER and press “ON” for ON TIMER.



3. Press “SELECT” to set the time to be reserved.

- Pressing the button changes the time in 10 minutes. Holding the button makes the time change faster.

4. Press “OFF” for OFF TIMER and press “ON” for ON TIMER. The displayed time is set.

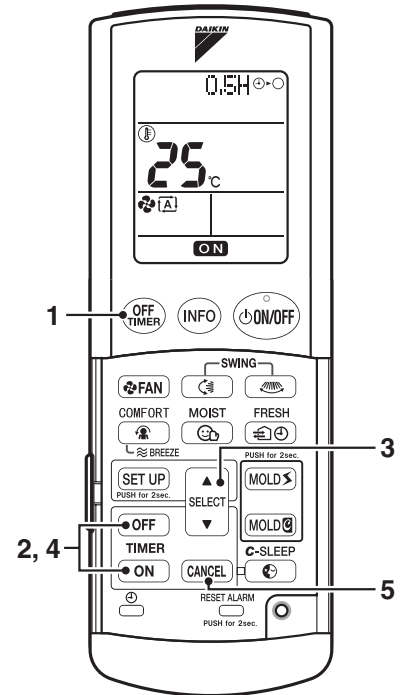
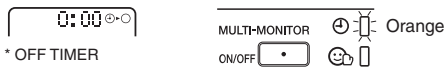

■ To cancel the TIMER operation

5. Press “CANCEL”.

- The TIMER lamp will go off and the TIMER will be canceled.

NOTE

■ In the following cases, set the timer again.

- After a breaker has turned OFF.
- After a power failure.
- After replacing batteries in the remote control.

■ Note on TIMER operation

- Starting COUNTDOWN OFF TIMER and OFF TIMER causes the unit to automatically change the set temperature 1 hour later to prevent the room from becoming too cold or too hot. (Turns up 0.5°C during COOLING or DRY COOLING and turns down 2°C during HEATING or HUMID HEATING.)
- Reserving the ON TIMER will cause the unit to start running up to 1 hour before, in order to make sure the temperature reaches the temperature set on the remote control by the set time.
- When operating the unit via the COUNTDOWN OFF TIMER or OFF TIMER, the actual length of operation may vary from the time entered by the user.
- Once you set ON/OFF TIMER, the time setting is kept in the memory. However, the COUNTDOWN OFF TIMER does not have this memory function. (The memory is canceled when remote control batteries are replaced.)
- Cannot operate with COMFORT SLEEP operation.

■ To combine ON TIMER and OFF TIMER

- See the right example for reserving in combination of COUNTDOWN OFF TIMER and ON TIMER as well as OFF TIMER and ON TIMER.

■ To cancel combined reservation

- Press “ON” and then “CANCEL” to cancel the ON TIMER only.
- Press “OFF” and then “CANCEL” to cancel the OFF TIMER only.
- Press “OFF TIMER” several times to reach 9.5 hours and then press it one more time to cancel the COUNTDOWN OFF TIMER only.

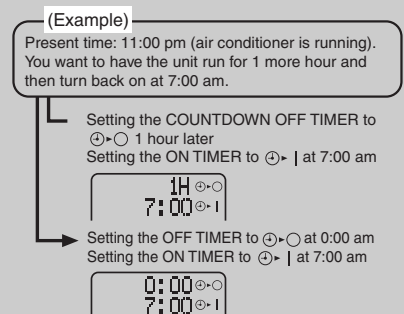

3.10 COMFORT SLEEP / POWERFUL Operation

COMFORT SLEEP OPERATION

Controlling the room temperature supports comfort sleep and pleasant wake-up

- Check that the clock is correct. If not, set the clock to the present time. (page 111.)
- The present time display disappears when the COMFORT SLEEP operation is set.

1. Press “” during operation.

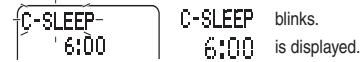

2. Press “” to set the time to wake up.

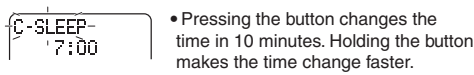

3. Press “”.



- When settings are made while the unit is not running, press “” to start the operation.

■ To cancel the comfort sleep operation

4. Press “”.

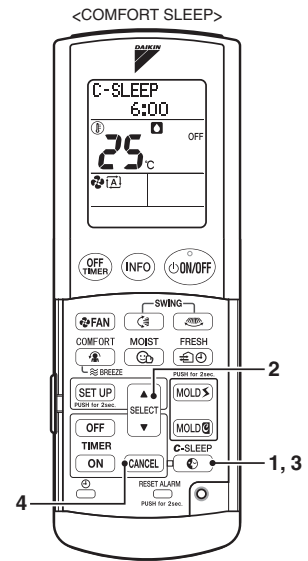

ATTENTION

- Make the room temperature comfortable to some extent before sleep. <Recommended set temperature> COOLING.....26°C – 29°C
HEATING.....20°C – 25°C
- * Too low set temperature may cause you to get chilled while asleep.

NOTE

■ Note on COMFORT SLEEP operation

- Can be used for COOLING, DRY COOLING, MOISTURE COOLING, HEATING, HUMID HEATING and MOISTURE HEATING.
- Cannot be used with TIMER operation.

■ How to use COMFORT SLEEP operation effectively

- Starting COMFORT SLEEP operation lowers the set temperature by 2°C in 3 hours and starts raising it by 1°C 1 hour before the set time, offering V-curve temperature control. (See the right figure.)
- Set the airflow direction so that the air from the unit does not directly blow on the occupants of the room.

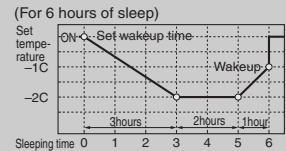

POWERFUL OPERATION

POWERFUL operation quickly maximizes the cooling (heating) effect in any operation mode.

1. Press “” during operation.

- POWERFUL operation ends in 20 minutes..



■ To change the airflow direction (page 115.)

- Temperature, humidity and airflow rate cannot be changed.

■ To cancel POWERFUL operation (page 111.)

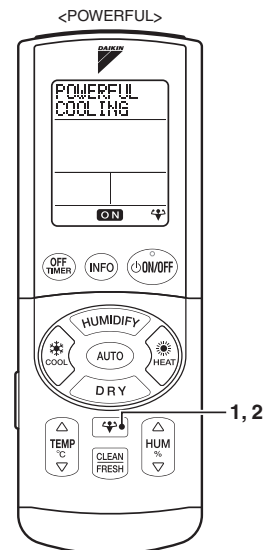

2. Press “” again.

- The operation mode goes back to the previous one. The multi-colored indicator on the unit also goes back to the previous color.



NOTE

■ Note on POWERFUL operation

- Can be used for COOLING, DRY COOLING, HEATING, HUMID HEATING and MOISTURE HEATING. (Cannot be used while the unit is not running.)
Pressing “” during COOLING, DRY COOLING or MOISTURE COOLING changes the operation mode to POWERFUL COOLING.
Pressing “” during HEATING, HUMID HEATING or MOISTURE HEATING changes the operation mode to POWERFUL HEATING.
- The operation noise is slightly louder during POWERFUL operation.

3.11 SET UP

Sets the unit operation and remote control display according to your preference.

1. Hold “**SET UP**” PUSH for 2sec. for about 2 seconds.
 - The setup mode will be activated.
2. The item will change every time “**SET UP**” PUSH for 2sec. is pressed.
3. The settings will change every time “**SELECT**” PUSH for 2sec. is pressed respectively.
 - Direct the remote control toward the main unit to make settings.

□ is default.

Item	Setting	Description
CHILD PROOF LOCK ON/OFF	OFF ◀▶ ON	• Restricts the remote control operations to avoid misuse by children. (See NOTE.)
MOLD PROOF ON/OFF	OFF ◀▶ ON	• If the unit is set to “MOLD PROOF ON”, it may automatically enter MOLD PROOF operation mode after operating in DRYING, DRY COOLING or COOLING operation mode, depending on the amount of time it had been operating. This is to dry out the interior of the air conditioner. (page 15.)
MONITOR BRIGHTNESS	HIGH ◀▶ LOW ◀▶ OFF	• Changes the brightness of the indoor unit display.
BEEP volume	LOW ◀▶ HIGH ◀▶ OFF	• Sets the receiving tone volume.
CONTRAST Setting	1 ◀▶ 6 ◀▶ 16	• Sets the grayscale for the remote control LCD. Selectable from contrast 1 to 16.

Setting complete: The display on the remote control goes back to normal if no setting is made for 10 seconds.

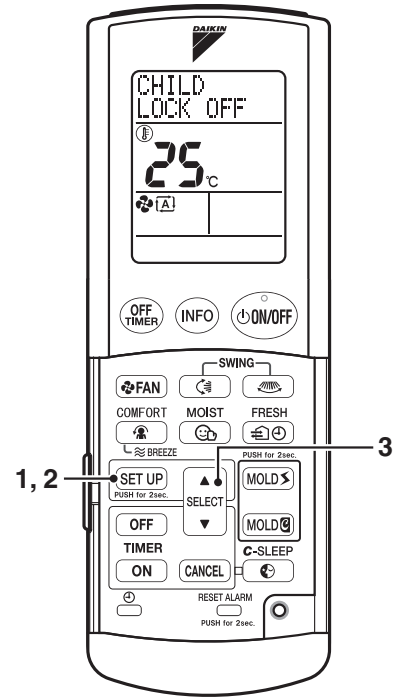

NOTE

- **Note on CHILD PROOF LOCK**
 - Selecting “ON” while CHILD PROOF LOCK setting and then pressing “**SET UP**” PUSH for 2sec. or making no setting for 10 seconds will cause the CHILD PROOF LOCK to be enabled and the display to show “**CHILD LOCK**” ”.
 - The button operations other than “**SET UP**” PUSH for 2sec. are disabled in CHILD PROOF LOCK mode.
 - To cancel the CHILD PROOF LOCK, set to “OFF” following the above steps from 1 to 3.

3.12 MOLD PROOF Operation

Dries the inside of the unit to prevent mold and odors.

■ Auto operation

(approximately once every 2 weeks) If the unit is set to “MOLD PROOF ON”, the MOLD PROOF operation will start automatically after the unit has been run in “SARARA” DRYING or COOLING mode, depending on the amount of time the unit has been run (approximately once every 2 weeks). (page 119.) The default is set to “MOLD PROOF OFF”.

■ Manuel operation

1. Hold “  ” for about 2 seconds while the unit is not running.



The MOLD PROOF operation will start.
The display will return to normal.

- The front panel and horizontal louver will open.
- The MOLD PROOF operation runs for about 3 hours, changing the color of the multi-colored indicator lamp of the unit.

<Color of multi-colored indicator lamp>

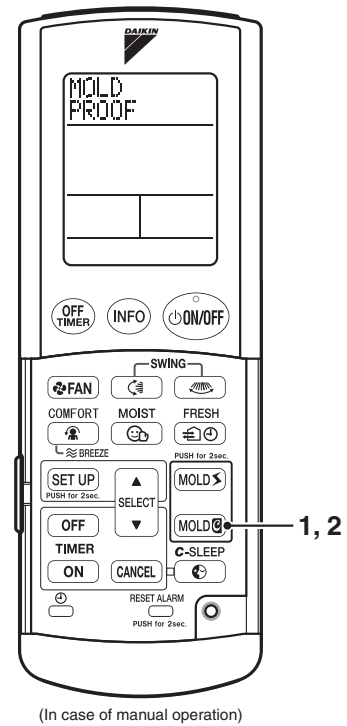
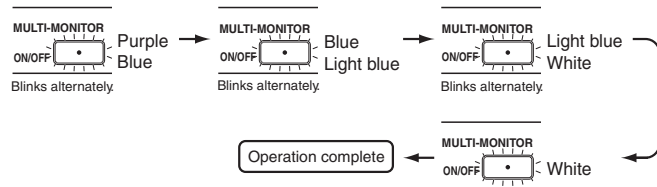

■ If you want to stop MOLD PROOF operation during operation

2. Hold “  ” (again) for about 2 seconds.

- The front panel and horizontal louver will close.
- The multi-colored indicator of the unit will go off.

NOTE

■ Note on MOLD PROOF operation

- Dries out the interior of the air conditioner using FAN and HEATING operation mode to exhaust humidity to the outdoor. This prevents mold and odor growth. This function is not designed to remove existing dust or mold.
- During MOLD PROOF operation, the room temperature may rise and humidity from the machine may be sent into the room. Some odors may be noticed, too.
- The mode may not be used if the outside temperature or humidity is very high.
- The exhausting operation may not be run depending on the outdoor temperature.
- MOLD PROOF operation mode is not available if the unit is shut off using the COUNTDOWN OFF TIMER. MOLD PROOF operation mode only comes on automatically if the unit has been stopped using the operation/stop switch on the remote control or the main unit.
- If MOLD PROOF operation is stopped during AUTO mode, the operation comes on automatically next time, depending on the amount of time the unit had been operating. To cancel the AUTO mode, set to “MOLD PROOF OFF”. (page 119.)

3.13 MOLD SHOCK Operation / INFORMATION DISPLAY

MOLD SHOCK OUT OPERATION

This mode dehumidifies the air in the room and prevents mold growth. Continuous drying operation lowers the room humidity rapidly.

1. Hold “MOLD” for about 2 seconds while the unit is not running.



The MOLD SHOCK OUT operation will start.
The display will return to normal

- The front panel and horizontal louver will open.
- The MOLD SHOCK OUT operation runs for about 3 hours, changing the color of the multi-colored indicator lamp on the unit.

<Color of multi-colored indicator lamp>

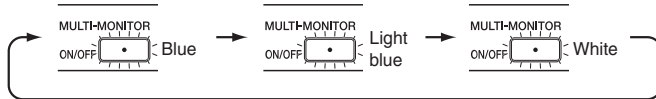

- Blinks in order during the MOLD SHOCK OUT operation.

■ If you want to stop MOLD SHOCK OUT operation during operation

2. Hold “MOLD” (again) for about 2 seconds.
 - The front panel and horizontal louver will close.
 - The multi-colored indicator of the unit will go off.

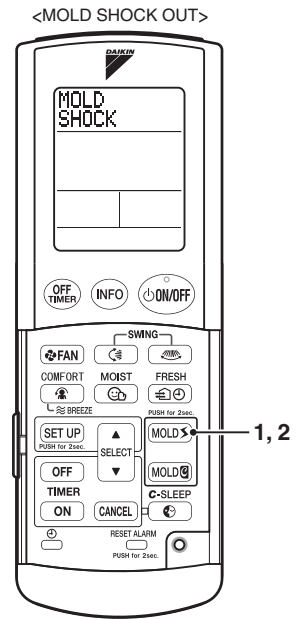

NOTE

- **Note on MOLD SHOCK OUT operation**
 - The mode may not be used depending on the outdoor temperature. <Operating range> Outdoor temperature of from 12 to 40°C
 - Temperature and humidity may not satisfy your preference during MOLD SHOCK OUT operation. Run this operation mode while no one is in the room. It is generally said that mold growth can be reduced when the humidity is below 60%.

INFORMATION DISPLAY

Displays the room temperature and humidity and outdoor temperature.

1. Press “INFO”.
 - After pressing “INFO”, point the remote control at the air conditioner unit for 2 seconds.

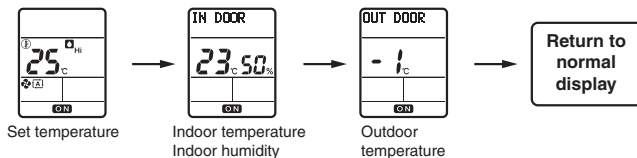

■ The display changes every time “INFO” is pressed.

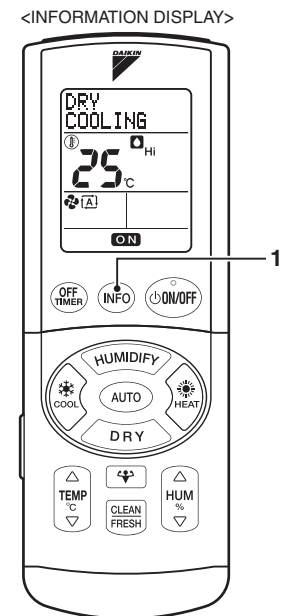

NOTE

- **Note on INFORMATION DISPLAY**
 - The signal from the air conditioner is not being received properly if “Reception Failed” is displayed when you press “”. Repeat, aiming the remote control at the air conditioner.
 - During operation, the outdoor temperature may sometimes be displayed higher than it actually is in COOLING or “SARARA” DRYING mode or lower in HEATING mode (especially if frost has accumulated on the outdoor unit), due to the effects of the air blown from the outdoor unit or the temperature of the heat exchanger.
 - The lowest indoor and outdoor temperature which can be displayed is -9°C. This will be displayed even if the actual temperature is lower. The highest temperature is 39°C. This will be displayed even if the actual temperature is higher.
 - The indoor and outdoor temperatures and the humidity which are displayed are those near the sensors attached to the main air conditioner unit.
 - The displayed temperature and humidity should only be taken as approximations, as they may be affected if there are objects around the sensors or due to direct sunlight, depending on where the air conditioner is installed.

3.14 Care and cleaning

QUICK REFERENCE FOR CLEANING

CAUTION

- Before cleaning, be sure to stop the operation and turn the breaker OFF.
- Do not touch the metal parts in the indoor unit. Doing so may cause injury.

1. Front panel

Wipe off if it gets dirty.
(Cleaning : page 18.)

2. Air filter

Vacuum/Rinse if "CLEAN FILTER" displays (Cleaning : page 19.)

3. Air supply filter (Yellow)

Cannot be washed with water.

Vacuum once in about 3 months.

- **Replace** once in about 1 year.(Cleaning : page 23.)

4. Titanium apatite photocatalytic air-purifying filter (Black)

Soak if "CLEAN STREAMER" displays.

- **Replace** once in about 3 years.(Cleaning : page 21.)

5. Deodorizing filter for streamer (Black)

Soak if "CLEAN FILTER" display.

- **Replace** once in about 3 years.(Cleaning : page 21.)

6. Upper panel

Wipe off if it gets dirty.
(Cleaning : page 18.)

7. Streamer unit

Soak if "CLEAN STREAMER" displays.

- **Replace** once in about 3 years.(Cleaning : page 21.)

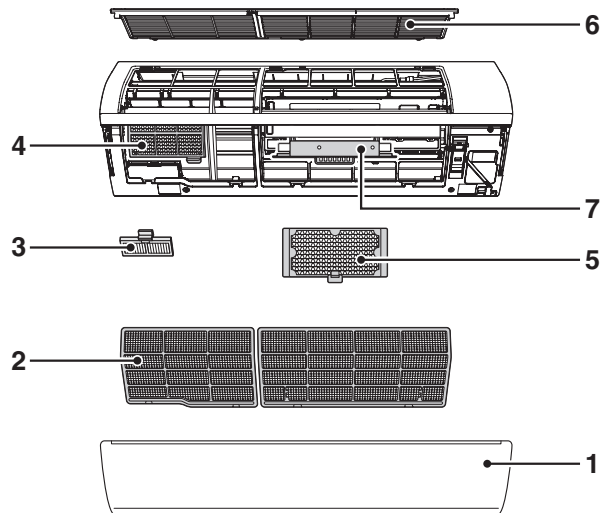

TO RESET THE FILTER CLEANING INDICATOR

While the unit is not operating, the filter cleaning indicator may be displayed on the remote control depending the amount of time the unit had been operating. This sign indicates the cleaning timing for the air filter, Titanium apatite photocatalytic air-purifying filter, deodorizing filter for streamer or streamer unit.



- 1. After cleaning, press "RESET ALARM" for about 2 seconds directing the remote control toward the main unit with powered on.**

- Indication disappears.

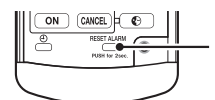

NOTE

- “CLEAN FILTER” sign will appear after about 340 hours of operation.
- “CLEAN STREAMER” sign will appear after about 1800 hours of operation.
- Operating the unit without cleaning with the “CLEAN STREAMER” sign displayed will lower the deodorizing capability.
- Periodical cleaning leads to energy saving.

ATTACHING AND REMOVING THE FRONT PANEL

CAUTION

- **Only open the front panel after turning the unit off.**
Opening the panel during operation may cause the panel to fall off.

1. Open the front panel.

- Placing a finger on the panel tab on either side of the front panel.

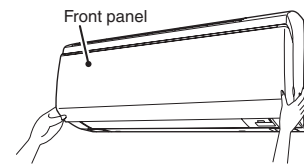

2. Remove the front panel.

- Spread out the shaft hole and remove the rotating shaft. (Both left and right sides.)

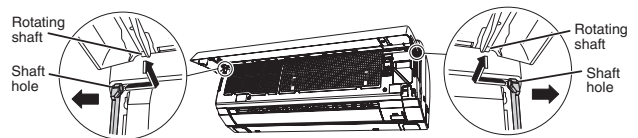

3. Attach the front panel.

- Place the revolving axes on either side of the front panel into the holes and slowly close. (Press either side of the front panel.)

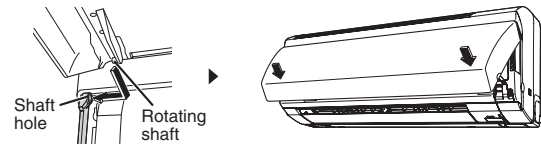

ATTACHING AND REMOVING THE UPPER PANEL

1. Remove the front panel and pull out the air filter. (page 124.)

2. Remove the upper panel.

- 1) Hold the 2 tabs on either side of the upper panel and pull forward to remove.
- 2) Remove the tab in the center and lift.

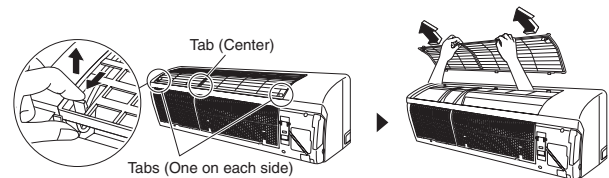

3. Attach the upper panel.

- Insert the 3 tabs on back of the upper panel and then push it down.
- Push the upper panel down until it clicks.

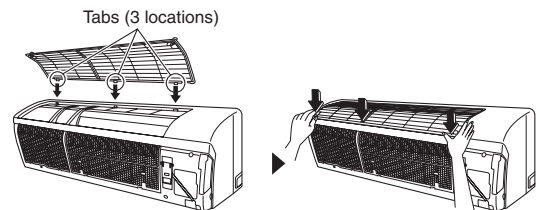

CLEANING FOR EACH CASE

- Wipe it with a soft cloth soaked in water. (Only neutral detergent may be used.)
- In case of washing the front panel with water, dry it with cloth, dry it up in the shade after washing.

CAUTION

- When removing or attaching the front panel, use a robust and stable stool and watch your steps carefully.
- When removing or attaching the front panel, support the front panel securely with hand to prevent it from falling.
- For cleaning, do not use hot water above 40°C, benzene, gasoline, thinner, nor other volatile oils, polishing compound, scrubbing brushes, nor other hand stuff.
- After cleaning, make sure that the front panel is securely fixed.
- Wipe the front panel with a soft cloth. Wiping with a hard cloth may scratch it.

CLEANING THE AIR FILTER

(If “” is displayed on the remote control)

1. Open the front panel.

- Open the front panel by placing a finger on the panel tab on either side of the front panel and then secure it using the supporting plate on the right.

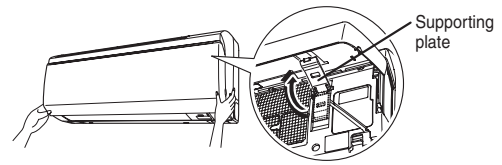

2. Pull out the air filters.

- Push a little upwards the air filter.

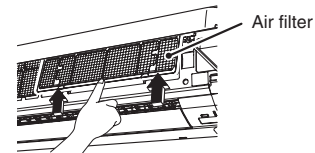

- Pull the air filter down.

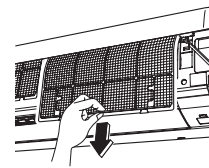

3. Clean the air filter.

- Wash the air filters with water or clean them with vacuum cleaner.
- If the dust does not come off easily, wash them with neutral detergent thinned with lukewarm water, then dry them up in the shade.

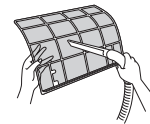

4. Set the air filter as it was and close the front panel.

- Insert the air filter with the “FRONT” marking to the front.
- Be sure to insert the two tabs below.
- Return the supporting plate to its previous position.
- Press either side of the front panel.

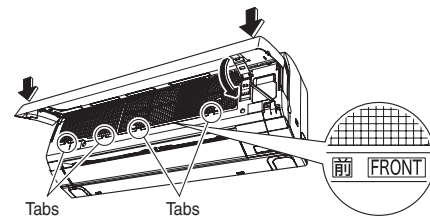

5. Reset the filter cleaning indicator. (page 122.)

ATTENTION

- Using without cleaning will lower the COOLING or HEATING capability, wasting electricity.

ATTACHING AND REMOVING THE DEODORIZING FILTER FOR STREAMER, TITANIUM APATITE PHOTOCATALYTIC AIR-PURIFYING FILTER, STREAMER UNIT

1. Open the front panel and pull out the air filter. (page 124.)

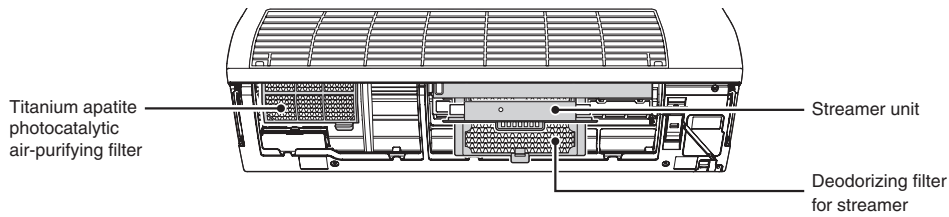

Removing

2. Remove the deodorizing filter for streamer.
 - Discharge the tab and pull out the knob in a downward direction.

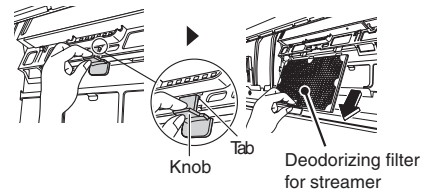

3. Pull out the streamer unit
 - Hold the center of the handle and pull out in a downward direction.

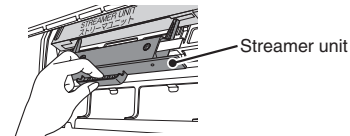

4. Remove the Titanium apatite photocatalytic air-purifying filter.
 - Pull up the filter frame, discharge the tabs on both sides of the Titanium apatite photocatalytic air-purifying filter from the hooks, and pull down the filter in a downward direction.

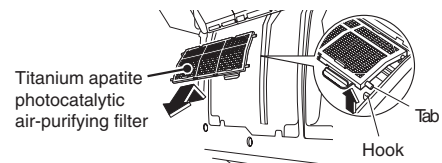

Attaching

5. Replace the streamer unit to its original position.
 - Attach the streamer unit in opposite procedure to removing 3.
6. Attach the deodorizing filter for streamer.
 - Insert the deodorizing filter for streamer until it clicks.

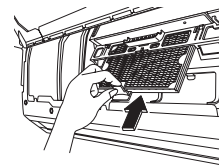

7. Attach the Titanium apatite photocatalytic air-purifying filter.
 - Insert the 2 upper tabs on the Titanium apatite photocatalytic air-purifying filter into the guides on the main unit and then hook up the 2 lower tabs.

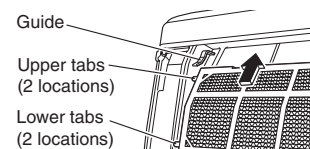

8. Replace the air filter to its original position and close the front panel.

CLEANING THE DEODORIZING FILTER FOR STREAMER, TITANIUM APATITE PHOTO-CATALYTIC AIR-PURIFYING FILTER AND STREAMER UNIT

(If "CLEAN STREAMER" is displayed on the remote control)

- Attaching and removing each part (page 125.)

Deodorizing filter for streamer / Titanium apatite photocatalytic air-purifying filter

Vacuum dusts, and soak in warm water or water for about 10 to 15 minutes if dirt is heavy.

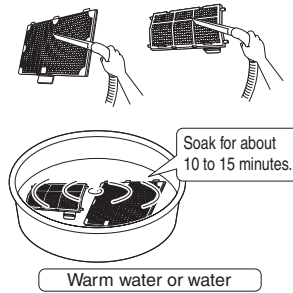

- Do not use cleaning agents. This may lower deodorizing capability.
- Do not scrub the filter while cleaning.
- Do not take the filter out of the frame while soaking.
- After soaking, drain water away and dry well in a shade.
- Do not squeeze the filter to drain away water.

Streamer unit

- 1) Soak in warm water with mild liquid detergent for about 1 hour

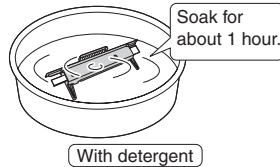

- Observe the volume of mild liquid detergent specified in the instruction.
- Do not use powder or alkaline detergent.
- If very dirty, disassemble the streamer unit and clean with cotton swabs, etc. (Disassembly instructions: page 126.)



- 2) Rinse with running water and soak in warm water or water again.

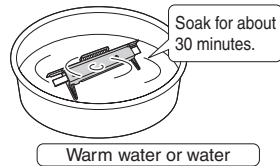

Disassembly

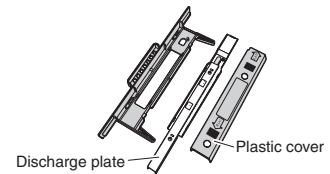

- 3) Rinse with running water.

Discharge plate

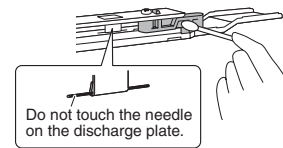

- 4) Drain water away and dry in a breezy shade.

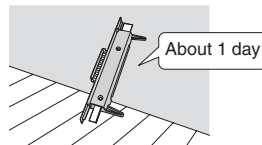

Do not touch the needle on the discharge plate (2 locations). Bending the needle will affect the unit's ability to deodorize.

- Resetting the filter cleaning indicator (page 122.)

ATTENTION

- Using without cleaning lowers the deodorizing capability.

HOW TO REPLACE

- **Deodorizing filter for streamer** (Once in about 3 years)
 - Remove from the filter frame and replace the filter with a new one.

- The deodorizing filter for stream and the titanium apatite photo-catalytic air-purifying filter do not have front and back sides.
- Dispose a used filter as burnable waste. (material: paper)

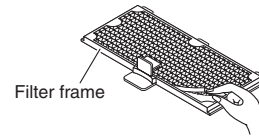

- **Titanium apatite photocatalytic air-purifying filter** (Once in about 3 years)
 - Discharge the 4 tabs of the filter frame and replace the filter with a new one.

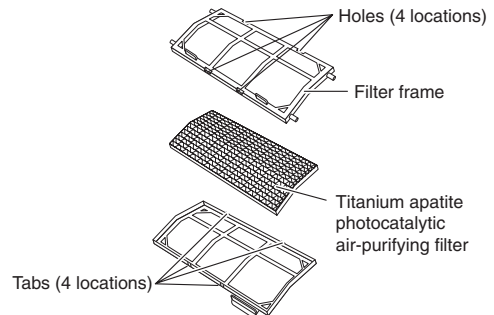

HOW TO DISASSEMBLE AND ASSEMBLE THE STREAMER UNIT

- Before disposing the streamer unit, disassemble it.

How to disassemble

- Use gloves for safety.
- Apply one hand to the part with vertical lines and push the plastic part with another hand.
- Disassemble the streamer unit into the plastic cover and the discharge plate.
- Match up the securing parts of the various parts of the streamer unit and assemble as it was.

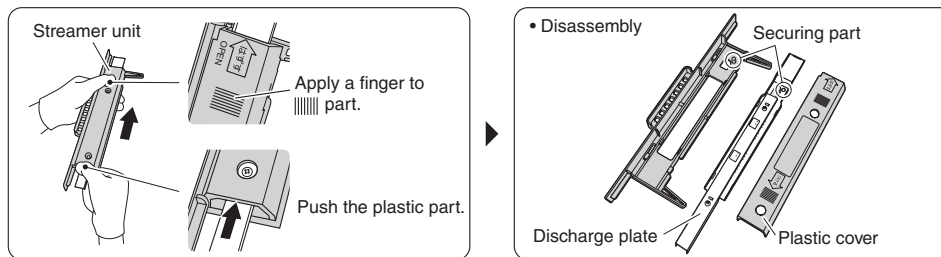

CAUTION

- Be careful not to cut yourself when disassembling and assembling the streamer unit.

ATTACHING, CLEANING AND REPLACING THE AIR SUPPLY FILTER

(Clean once in about 3 months and replace once in about 1 year.)

Cannot be washed with water.

1. Open the front panel to pull out the air filter and Titanium apatite photocatalytic air-purifying filter. (page 124, 125.)
2. Pull out the air supply filter.

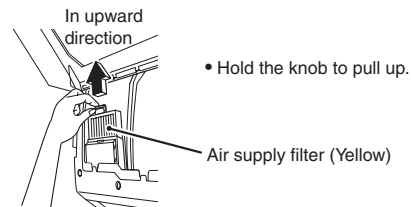

3. Cleaning

- Remove dust with a vacuum cleaner.
- The component of the filter is weak in water. Do not rinse the filter.

Replacing

Discharge the 4 tabs of the filter frame and replace the filter with a new one.

- Dispose a used filter as unburnable waste. (material: polyester)

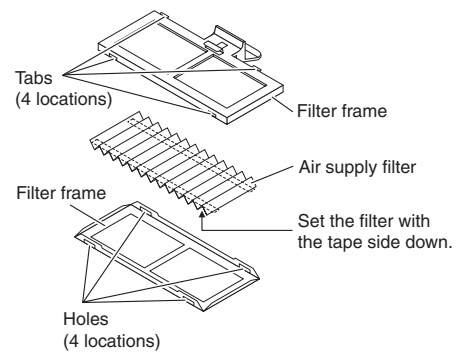

4. Replace the air supply filter to its original position.
5. Set the Titanium apatite photocatalytic air-purifying filter and the air filter as they were and close the front panel. (page 124, 125.)



CAUTION

- Do not forget to replace the filter to its original position after cleaning it. Operating the unit in HUMIDIFYING mode without attaching the filter may cause condensation to form inside the panel or others, causing water to leak.

CLEANING THE INDOOR UNIT AND THE REMOTE CONTROL

- Wipe with a soft dry cloth. For cleaning, do not use hot water above 40°C, benzene, gasoline, thinner, nor other volatile oils, polishing compound, scrubbing brushes, nor other hand stuff.

NOTE

- The deodorizing filter for stream and the titanium apatite photocatalytic air-purifying filter should be cleaned regularly. We recommend replacing the filter in the following situations.
 - If it is damaged during cleaning because it is made of paper.
 - If it is very dirty after long use.

Item	Part No.
Air purifying filter set	KAF974B42S
Air supply filter (with frame)	KAF963A43

- To order Titanium apatite photocatalytic air-purifying filter, deodorizing filter for streamer, air supply filter and streamer unit contact to the service shop there you bought the air conditioner.
- Using the dirty parts will:
 - Prevent proper air purification.
 - Prevent proper deodorizing.
 - Reduce COOLING and HEATING capacity.
 - Cause the unit to produce foul odors.

Check

- Check that the base, stand and other fittings of the outdoor unit are not decayed or corroded.
- Check that nothing blocks the air inlets and the outlets of the indoor unit and the outdoor unit.
- Check that the drain comes smoothly out of the drain hose during COOLING or DRY operation.
 - If no drain water is seen, water may be leaking from the indoor unit. Stop operation and consult the service shop if this is the case.
- Is the earth wire out or disconnected in the middle?
 - An incomplete ground wire may cause electrical shock. Contact the service shop.

■ Before a long idle period

1. Operate the "MOLD PROOF" for several hours on a fine day to dry out the inside.

MOLD PROOF operation

Hold "  " for about 2 seconds while the unit is not running.



The operation will stop in about 3 hours.

2. After operation stops, turn off the breaker for the room air conditioner.
3. Clean the air filters and set them again.
4. Take out batteries from the remote control.

3.15 Troubleshooting

These cases are not troubles

The following cases are not air conditioner troubles but have some reasons. You may just continue using it.

Case	Explanation
Operation does not start soon. <ul style="list-style-type: none"> When ON/OFF button was pressed soon after operation was stopped. When the mode was reselected. 	<ul style="list-style-type: none"> This is to protect the air conditioner. You should wait for about 3 minutes.
Hot air does not flow out soon after the start of heating operation.	<ul style="list-style-type: none"> The air conditioner is warming up. You should wait for 1 to 4 minutes.
Makes a noise	<ul style="list-style-type: none"> ■ Clicking sound can be heard either when the unit is running or stopped <ul style="list-style-type: none"> This is either the sound of the valves regulating the refrigerant or the electrical parts working. ■ Sound of running water <ul style="list-style-type: none"> Refrigerant is flowing through the air conditioner. ■ Blowing sound <ul style="list-style-type: none"> The flow of refrigerant through the air conditioner is switching. ■ Creaking sound <ul style="list-style-type: none"> The air conditioner itself is expanding or shrinking due to a change in the humidity. ■ Clopping sound <ul style="list-style-type: none"> Can be heard coming from inside the air conditioner when the ventilator is on and the room is shut. Open a window or turn off the ventilator. ■ Clicking sound can be heard either when the unit is running or stopped <ul style="list-style-type: none"> This is the sound of the electrical parts working when the front panel opens or closes. ■ Blowing, cracky or burning sound <ul style="list-style-type: none"> This is the sound of streamer discharging.
Fizzes during HUMIDIFYING or VENTILATING operation.	<ul style="list-style-type: none"> This is the sound of streamer discharging. The operation noise may change depending on the outdoor temperature and humidity.
Makes a sound during HUMIDIFYING operation.	<ul style="list-style-type: none"> ■ Operation noise changes <ul style="list-style-type: none"> This is because the fan for humidification moves or stops.
The indoor unit makes a noise even after HUMIDIFYING operation is stopped.	<ul style="list-style-type: none"> The fan for humidification rotates for about 3 minutes after the operation stops for product protection.
Units stops during HEATING and the sound of running water can be heard.	<ul style="list-style-type: none"> The frost on the outdoor unit is being removed. You should wait for about 3 to 10 minutes.
The outdoor unit emits water or steam.	<ul style="list-style-type: none"> ■ In HEATING operation <ul style="list-style-type: none"> The frost on the outdoor unit melts into water or steam when the air conditioner is in defrost operation. ■ In COOLING operation <ul style="list-style-type: none"> Moisture in the air condenses into water on the cool surface of outdoor unit piping and drips.
Mist becomes out of the indoor unit	<ul style="list-style-type: none"> This happens when the air in the room is cooled into mist by the cold air flow during COOLING operation. This is because moisture on the heat exchanger evaporates when "SARARA" DRYING operation is run after COOLING or DRY COOLING operation.
The indoor unit gives out odor	<ul style="list-style-type: none"> This happens when smells of the room, furniture, or cigarettes are absorbed into the unit and discharged with the air flow. (If this happens, we recommend you to have the indoor unit washed by a technician. Consult the service shop where you bought the air conditioner.) The outdoor odor may be captured. Stop the "URURU" HUMIDIFYING operation to eliminate the cause of odor.
Cold air blows at the start of "SARARA" DRYING operation.	<ul style="list-style-type: none"> This is because the air conditioner is not warmed up.
The outdoor fan rotates while the air conditioner is not in operation.	<ul style="list-style-type: none"> ■ After operation is stopped: <ul style="list-style-type: none"> The outdoor fan continues rotating for another 60 seconds for system protection. ■ While the air conditioner is not in operation: <ul style="list-style-type: none"> When the outdoor temperature is very high, the outdoor fan starts rotating for system protection.
The operation stopped suddenly. (Multi-colored indicator lamp is on.)	<ul style="list-style-type: none"> For system protection, the air conditioner may stop operating on a sudden large voltage fluctuation. It automatically resumes operation in about 3 minutes.
Unit stops suddenly (when in ON TIMER mode).	<ul style="list-style-type: none"> Reserving the on timer will cause the unit to start running up 1 hour before, in order to make sure the temperature reaches the temperature set on the remote control by the set time. Using the remote control during this time (other than the operation/stop button) will stop the unit. Restart the unit with the remote control.
Unit operates even though the multi-colored indicator lamp is off.	<ul style="list-style-type: none"> The multi-colored indicator lamp will go off if "Monitor OFF" is set using the remote control.
Unit continues to operate even after "SARARA" DRYING, DRY COOLING or COOLING operation is stopped.	<ul style="list-style-type: none"> The MOLD PROOF operation will start. (If you don't want it, set to "MOLD PROOF OFF" using the remote control. (page 120.))
Room lamp flickers during HUMIDIFYING operation.	<ul style="list-style-type: none"> It might happen the flickers of lighting in the case of insufficient power supply.

Check again

Please check again before calling a repair person.





Case	Check
The air conditioner does not operate. (Multi-colored indicator lamp is off.)	<ul style="list-style-type: none"> • Hasn't a breaker turned OFF or a fuse blown? • Isn't it a power failure? • Are batteries set in the remote control? • Is the timer setting correct?
The air conditioner does not operate. (Multi-colored indicator lamp flashes.)	<ul style="list-style-type: none"> • Turn off the breaker and then start the unit using the remote control. • If the lamp still flashes, consult the service shop where you bought the air conditioner. Turn off the breaker.
Operation stops suddenly. (Multi-colored indicator lamp flashes.)	<ul style="list-style-type: none"> • Are the air filters clean? • Is there anything to block the air inlet or the outlet of the indoor and the outdoor units? Clean the air filters or take all obstacles away and turn the breaker OFF. Then turn it ON again and try operating the air conditioner with the remote control. • If the lamp still flashes, con-sult the service shop where you bought the air conditioner. Turn off the breaker.
Cooling (Heating) effect is poor.	<ul style="list-style-type: none"> • Are the air filters clean? • Is there anything to block the air inlet or the outlet of the indoor and the outdoor units? • Is the temperature setting appropriate? • Are the windows and doors closed? • Are the air flow rate and the air direction set appropriately? • Is the ventilator fan spinning?
An abnormal functioning happens during operation.	<ul style="list-style-type: none"> • Do you put your hand in the main unit while it is operating? (Do you touch inside the unit?) • Putting your hand (or touching) inside the unit may cause malfunctions due to static discharge. Do not put your hand in the main unit. • The air conditioner may malfunction with lightning or radio waves. Turn the breaker OFF, turn it ON again and try operating the air conditioner with the remote control.
Front panel does not open.(Multi-colored indicator lamp flashes.)	<ul style="list-style-type: none"> • Is there something caught in the front panel? Remove the object and attempt operation again using the remote control. If the panel still does not open, contact your dealer if the operation lamp is still flashing.
The multi-colored indicator lamp flashes for a certain amount of time (about 2 min-utes) at the start of or during FLASH STREAMER AIR PURIFYING operation.	<ul style="list-style-type: none"> • Is the streamer unit installed securely? • Turn off the breaker, check to see if the streamer unit is installed securely, turn the power on, and then operate the unit again using the remote control. • If the lamp still flashes, consult the service shop where you bought the air conditioner.

■ Call the service shop immediately.

 **WARNING**

- When an abnormality (such as a burning smell) occurs, stop operation and turn the breaker OFF. Continued operation in an abnormal condition may result in troubles, electric shocks or fire. Consult the service shop where you bought the air conditioner.
- Do not attempt to repair or modify the air conditioner by yourself. Incorrect work may result in electric shocks or fire. Consult the service shop where you bought the air conditioner.
- If the air conditioner does not cool (or heat), leaking refrigerant is a possible cause, so please contact your dealer. Please talk to a service repair-man about any repairs needed when adding refrigerant. Refrigerant used for the air conditioner is safe. Refrigerant does not leak usually, but if it leaks into the room and comes in contact with any kind of flame, including those in fan heaters, gas stoves, gas heaters, etc., toxic gas may be generated.

If one of the following symptoms takes place, call the service shop immediately.

<ul style="list-style-type: none"> ■ The power cord is abnormally hot or damaged. ■ An abnormal sound is heard during operation. ■ An object or water got into the unit. ■ The safety breaker, a fuse, or the earth leakage breaker cuts off the operation frequently. ■ A switch or a button often fails to work properly. ■ There is a burning smell. ■ Water leaks from the indoor unit. 		<p>Turn the breaker OFF and call the service shop. </p>
<ul style="list-style-type: none"> ■ Cool or warm air comes from the unit but the multi-colored indicator lamp blinks for a certain amount of time (about 2 minutes) at the start of or during operation. 		<p>This indicates the malfunction or initial failure of the humidifying unit or some sensors. The unit is operating in COOLING / HEATING mode as a temporary operation. Contact your dealer. </p>

- **After a power failure**
The air conditioner automatically resumes operation in about 3 minutes. You should just wait for a while.
- **Lightning**
If lightning may strike the neighbouring area, stop operation and turn the breaker OFF for system protection.

Disposal requirements



Your air conditioning product is marked with this symbol. This means that electrical and electronic products shall not be mixed with unsorted household waste.

Do not try to dismantle the system yourself: the dismantling of the air conditioning system, treatment of the refrigerant, of oil and of other parts must be done by a qualified installer in accordance with relevant local and national legislation.

Air conditioners must be treated at a specialized treatment facility for re-use, recycling and recovery. By ensuring this product is disposed of correctly, you will help to prevent potential negative consequences for the environment and human health. Please contact the installer or local authority for more information.

Batteries must be removed from the remote control and disposed of separately in accordance with relevant local and national legislation.

We recommend periodical maintenance

In certain operating conditions, the inside of the air conditioner may get foul after several seasons of use, resulting in poor performance. It is recommended to have periodical maintenance by a specialist aside from regular cleaning by the user. For specialist maintenance, contact the service shop where you bought the air conditioner. The maintenance cost must be born by the user.

■ FAULT DIAGNOSIS BY remote control.

In the ARC433A series, the temperature display sections on the main unit indicate corresponding codes.

1. When the **TIMER CANCEL** button is held down for 5 seconds, a “00” indication flashes on the temperature display section.

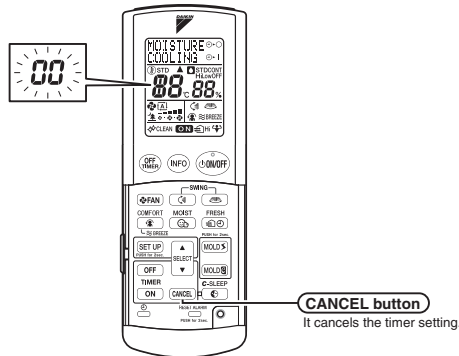

2. Press the **TIMER CANCEL** button repeatedly until a continuous beep is produced.
 - The code indication changes as shown below, and notifies with a long beep.

	CODE	MEANING
SYSTEM	00	NORMAL
	UA	INDOOR-OUTDOOR UNIT COMBINATION FAULT
	U0	REFRIGERANT SHORTAGE
	U2	DROP VOLTAGE OR MAIN CIRCUIT OVERVOLTAGE
	U4	FAILURE OF TRANSMISSION (BETWEEN INDOOR UNIT AND OUTDOOR UNIT)
	U7	CIRCUIT BOARD TRANSMISSION FAULT
INDOOR UNIT	AH	STREAMER FAULT
	A1	INDOOR PCB DEFECTIVENESS
	A5	HIGH PRESSURE CONTROL OR FREEZE-UP PROTECTOR
	A6	FAN MOTOR FAULT
	CC	HUMIDITY SENSOR FAULT
	C4	FAULTY HEAT EXCHANGER TEMPERATURE SENSOR
	C7	FRONT PANEL OPEN/CLOSE FAULT
	C9	FAULTY SUCTION AIR TEMPERATURE SENSOR
	UA	HOSE LENGTH NOT SET
OUTDOOR UNIT	EA	COOLING-HEATING SWITCHING FAULT
	E1	CIRCUIT BOARD FAULT
	E5	OL STARTED
	E6	FAULTY COMPRESSOR START UP
	E7	DC FAN MOTOR FAULT
	E8	OVERCURRENT INPUT
	FA	EJECTION PRESSURE FAULT
	F3	HIGH TEMPERATURE DISCHARGE PIPE CONTROL
	F6	HIGH PRESSURE CONTROL (IN COOLING)
	H0	SENSOR FAULT
	H1	DAMPER FAULT
	H6	OPERATION HALT DUE TO FAULTY POSITION DETECTION SENSOR
	H8	CT ABNORMALITY
	H9	FAULTY SUCTION AIR TEMPERATURE SENSOR
	J3	FAULTY DISCHARGE PIPE TEMPERATURE SENSOR
	J6	FAULTY HEAT EXCHANGER TEMPERATURE SENSOR
	L3	ELECTRICAL PARTS HEAT FAULT
	L4	HIGH TEMPERATURE AT INVERTER CIRCUIT HEATSINK
	L5	OUTPUT OVERCURRENT
	P4	FAULTY INVERTER CIRCUIT HEATSINK TEMPERATURE SENSOR
HUMIDIFY UNIT	PA	HEATER LINE BROKEN FAULT
	PH	HUMIDIFYING FAN OUTLET THERMISTOR FAULT, HEATER TEMPERATURE FAULT
	P9	HUMIDIFYING FAN LOCK

NOTE

- 1) A short beep and two consecutive beeps indicate non-corresponding codes.
- 2) To cancel the code display, hold the **CANCEL** button down for 5 seconds. The code display also cancel itself if the button is not pressed for 1 minute.

Part 6

Service Diagnosis

1. Convenient Service Check Function	137
2. Troubleshooting	139
2.1 Error Code Indication by remote control.....	139
2.2 Air conditioner does not run.	141
2.3 Air conditioner runs but does not get cooling (heating).....	143
2.4 When operation starts, safety breaker works.	145
2.5 Air conditioner makes big noise and vibration.....	147
2.6 Air does not humidified enough.....	148
2.7 Indoor Unit PCB Fault	150
2.8 Peak-cut Control or Freeze-up Protection.....	151
2.9 Fan Motor System (DC Motor) Fault	153
2.10 Streamer Unit Fault	155
2.11 Thermistor System Fault	157
2.12 Front Panel Open / Close Fault.....	158
2.13 Humidity Sensor Fault	159
2.14 Signal Transmission Error (Indoor Unit - Outdoor Unit)	160
2.15 Incompatible Power Supply between Indoor Unit and Outdoor Unit	162
2.16 Incomplete Setting for Hose Length	163
2.17 Outdoor Unit PCB Fault.....	164
2.18 OL Activation (Compressor Overload)	165
2.19 Compressor Lock	166
2.20 DC Fan Lock	167
2.21 Input Over Current Detection	168
2.22 Four Way Valve Fault.....	170
2.23 Discharge Pipe Temperature Control.....	172
2.24 High Pressure Control in Cooling	173
2.25 Compressor Sensor System Fault	175
2.26 Damper Fault.....	176
2.27 Position Sensor Fault	177
2.28 DC Voltage / DC Current Sensor Fault	179
2.29 Thermistor System Fault	180
2.30 Abnormal Temperature in Electrical Box.....	182
2.31 Temperature Rise in Radiation Fin.....	184
2.32 Output Overcurrent.....	186
2.33 Insufficient Gas.....	188
2.34 Over Voltage Protection / Low Voltage Protection	190
2.35 Outdoor Unit PCB Fault or Communication Circuit Fault	191
2.36 Signal Transmission Error on Outdoor Unit PCB	194
2.37 Fan Motor System Fault / Fan Lock	196
2.38 Heater Wire Fault	197
2.39 Humidification Fan Outlet Thermistor Fault / Abnormal Heater Temperature.....	199
2.40 Lights-out of Microcomputer Status Lamp.....	201
3. Check	202
3.1 Thermistor Resistance Check	202

3.2	Installation Condition Check.....	203
3.3	Outdoor Fan System Check (DC Motor)	203
3.4	Power Supply Waveform Check.....	204
3.5	Capacitor Voltage Check.....	204
3.6	Main Circuit Electrolytic Capacitor Check	205
3.7	Refrigerant System Check	205
3.8	“Inverter Checker” Check	206
3.9	Power Transistor Check	207
3.10	Discharge Pressure Check.....	208
3.11	Electronic Expansion Valve Check.....	209
3.12	Indoor Unit PCB Output Check	210
3.13	Rotating Pulse Input on Outdoor Unit PCB Check	211
3.14	Humidity Sensor Check.....	212
3.15	Main Circuit Short Check.....	212
3.16	Four-way Valve Performance Check.....	213
3.17	Solenoid Valve for Dehumidification Check	214

1. Convenient Service Check Function

■ Failure diagnosis with operation lamp

The operation lamp on the display of the indoor unit flashes when any of the following failure is detected.

1. When a protection device of the indoor or outdoor unit is activated or when the thermistor malfunctions and the machine does not work.
2. When a signal transmission error occurs between the indoor and outdoor units.

For detailed troubleshooting, refer to the following pages "Troubleshooting" (139~).

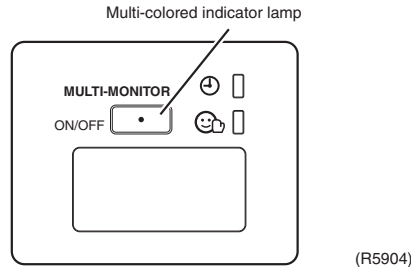

■ Failure diagnosis by remote control

With the infrared remote control supplied with the unit, or sold separately, error codes by failure diagnosis can be confirmed. (Press timer cancel button down for 5 seconds continuously.)

ARC447A series

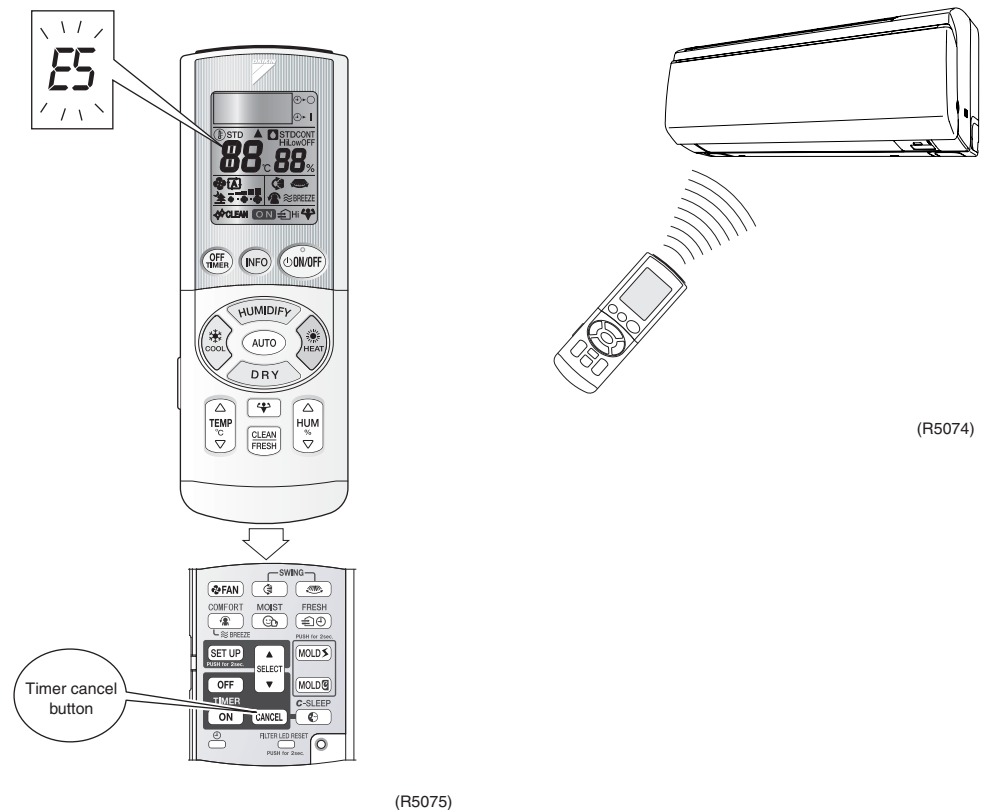

1. Hold the timer cancel button down for 5 seconds, with the remote control set toward the indoor unit.
2. The temperature display on the remote control changes to the error code display and a long beep notifies this indication change.

<Note>

To cancel indication of error code, hold the timer cancel button down for 5 seconds. The code display also cancels itself if the button is not pressed for 1 minute.

■ Failure diagnosis by LED indication

The following failure diagnosis can be done by LED indication on the outdoor unit PCB.

1. The outdoor unit has 2 green LED(LED A, LED5) on the PCB.

The flashing green LED indicates "in order" condition.

The turned ON or OFF LED indicates the failure related to the microcomputer.

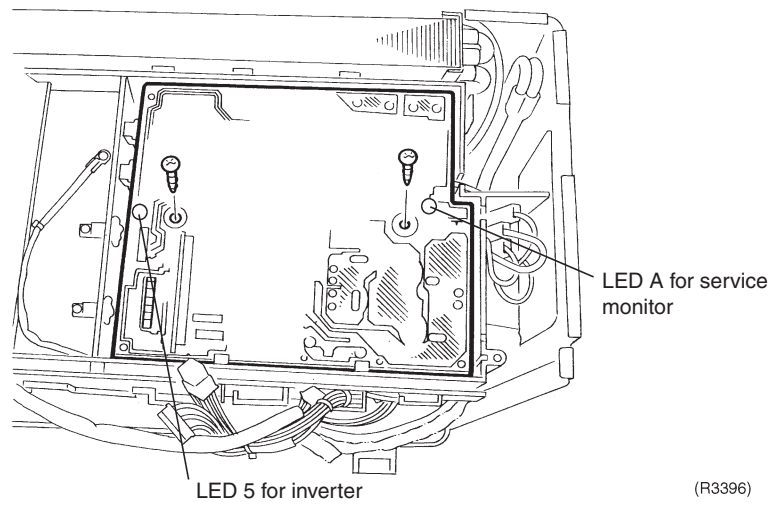

- PCB is set upside down (with backside up) to improve its quality.
- LED can be visually inspected through a inspection slit.

2. Troubleshooting

2.1 Error Code Indication by remote control

* Various cases may be possible.

Code	Unit	Description	Reference page
Basic Failure Diagnosis		Air conditioner does not run.	141
		Air conditioner runs but does not get cooling (heating).	143
		When operation starts, safety breaker works.	145
		Air conditioner makes big noise and vibration.	147
		Air does not humidified enough.	148
<i>R1</i>	Indoor	Indoor unit PCB fault	150
<i>R5</i>		Peak-cut control or freeze-up protection	151
<i>R6</i>		Fan motor system fault	153
<i>RH</i>		Streamer unit fault	155
<i>C4</i>		Indoor heat exchanger thermistor fault	157
<i>C7</i>		Front panel open / close fault	158
<i>C9</i>		Room temperature thermistor fault	157
<i>CC</i>		Humidity sensor fault	159
<i>E1</i>	Outdoor	Outdoor unit PCB fault	164
<i>E5</i>		OL activation (compressor overload)	165
<i>E6</i>		Compressor lock	166
<i>E7</i>		DC fan lock	167
<i>E8</i>		Input overcurrent detection	168
<i>ER</i>		Four way valve fault	170
<i>F3</i>		Discharge pipe temperature control	172
<i>F6</i>		High pressure control in cooling	173
<i>H0</i>		Compressor sensor system fault	175
<i>H1</i>	Humidifying unit	Damper fault	176
<i>H6</i>	Outdoor	Position sensor fault	177
<i>H8</i>		DC voltage / DC current sensor fault	179
<i>H9</i>		Outdoor air thermistor fault	180
<i>J3</i>		Discharge pipe thermistor fault	180
<i>J6</i>		Outdoor heat exchanger thermistor fault	180
<i>L3</i>		Abnormal temperature in electrical box	182
<i>L4</i>		Temperature rise in radiation fin	184
<i>L5</i>		Output overcurrent	186
<i>P4</i>		Radiation fin thermistor fault	180
<i>P9</i>	Humidifying unit	Fan motor system fault / fan lock	196
<i>PR</i>		Heater wire fault	197
<i>PH</i>		Humidification fan outlet thermistor fault / abnormal heater temperature	199
<i>U0</i>	System	Insufficient gas	141
<i>U2</i>		Over voltage protection (OVP) / low voltage protection (LVP)	143
<i>U4</i>			Signal transmission error (indoor unit - outdoor unit)
	Outdoor	Outdoor unit PCB fault or communication circuit fault	191

Code	Unit	Description	Reference page
<i>U7</i>	System	Signal transmission error on outdoor unit PCB	194
<i>UR</i>		Incompatible power supply between indoor unit and outdoor unit	162
	Indoor	Incomplete setting for hose length	163
–	System	Lights-out of microcomputer status lamp	201

2.2 Air conditioner does not run.

**Method of
Malfunction
Detection**

**Malfunction
Decision
Conditions**

**Supposed
Causes**

- Power supply is OFF
- Improper power supply voltage
- Improper connection of wire
- Incorrect combination of indoor unit and outdoor unit
- Battery shortage of remote control
- Invalid address setting
- Protection device works
(dirty air filter, insufficient gas, over filling, mixed air, etc.)
- Transmission error between indoor unit and outdoor unit
(Defective PCB on outdoor unit)

Troubleshooting



Caution Be sure to turn off power switch before connect or disconnect connector, or parts damage may be occurred.

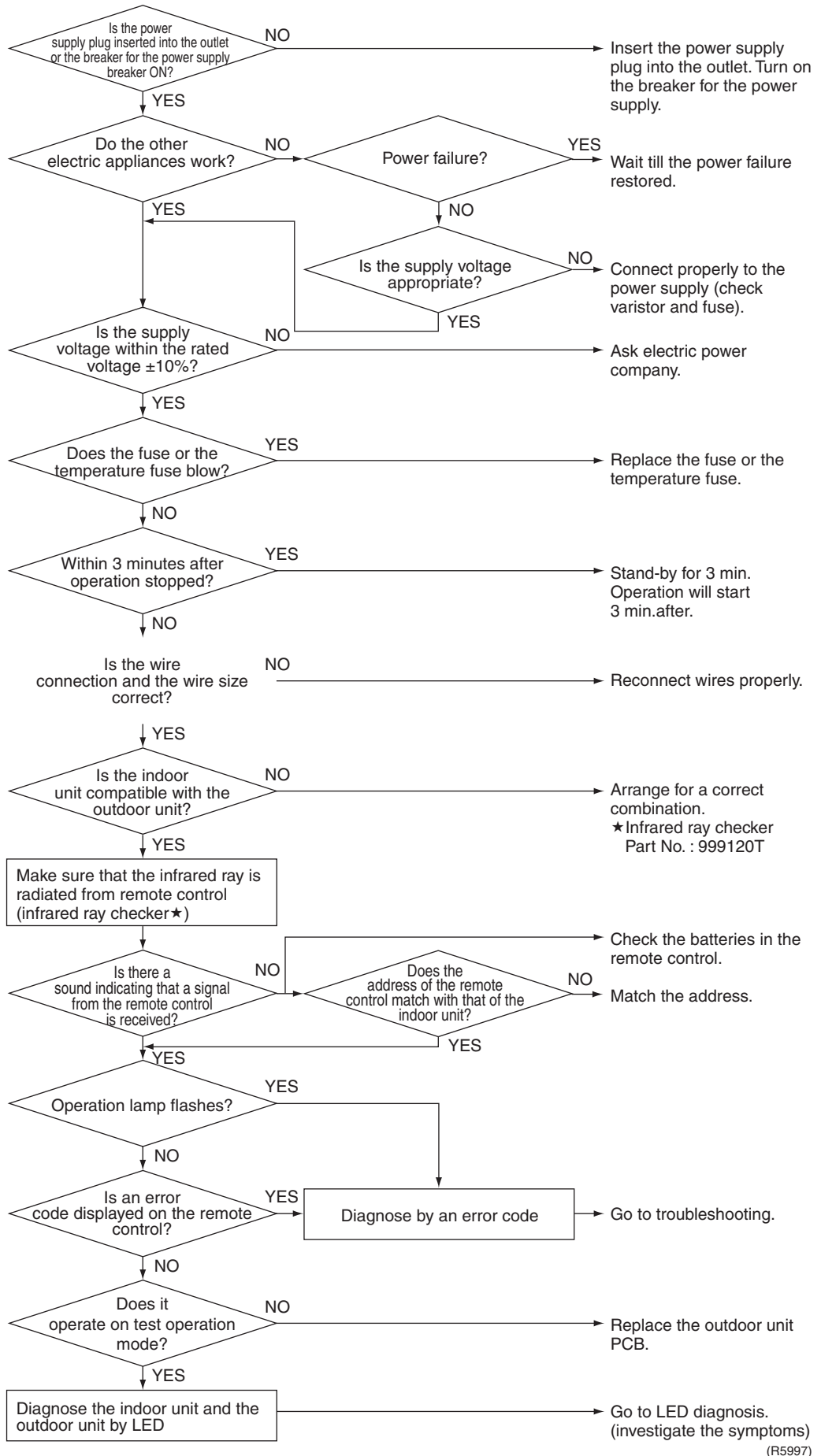

2.3 Air conditioner runs but does not get cooling (heating).

**Method of
Malfunction
Detection**

**Malfunction
Decision
Conditions**

**Supposed
Causes**

- Incorrect temperature setting
- Incorrect combination of indoor unit and outdoor unit
- Blocked air filter
- Insufficient power
- Refrigerant piping is too long
- Improper setting of piping length
- Defective field piping (squeezed, etc.)

Troubleshooting



Check No.2
Refer to P.202



Caution

Be sure to turn off power switch before connect or disconnect connector, or parts damage may be occurred.

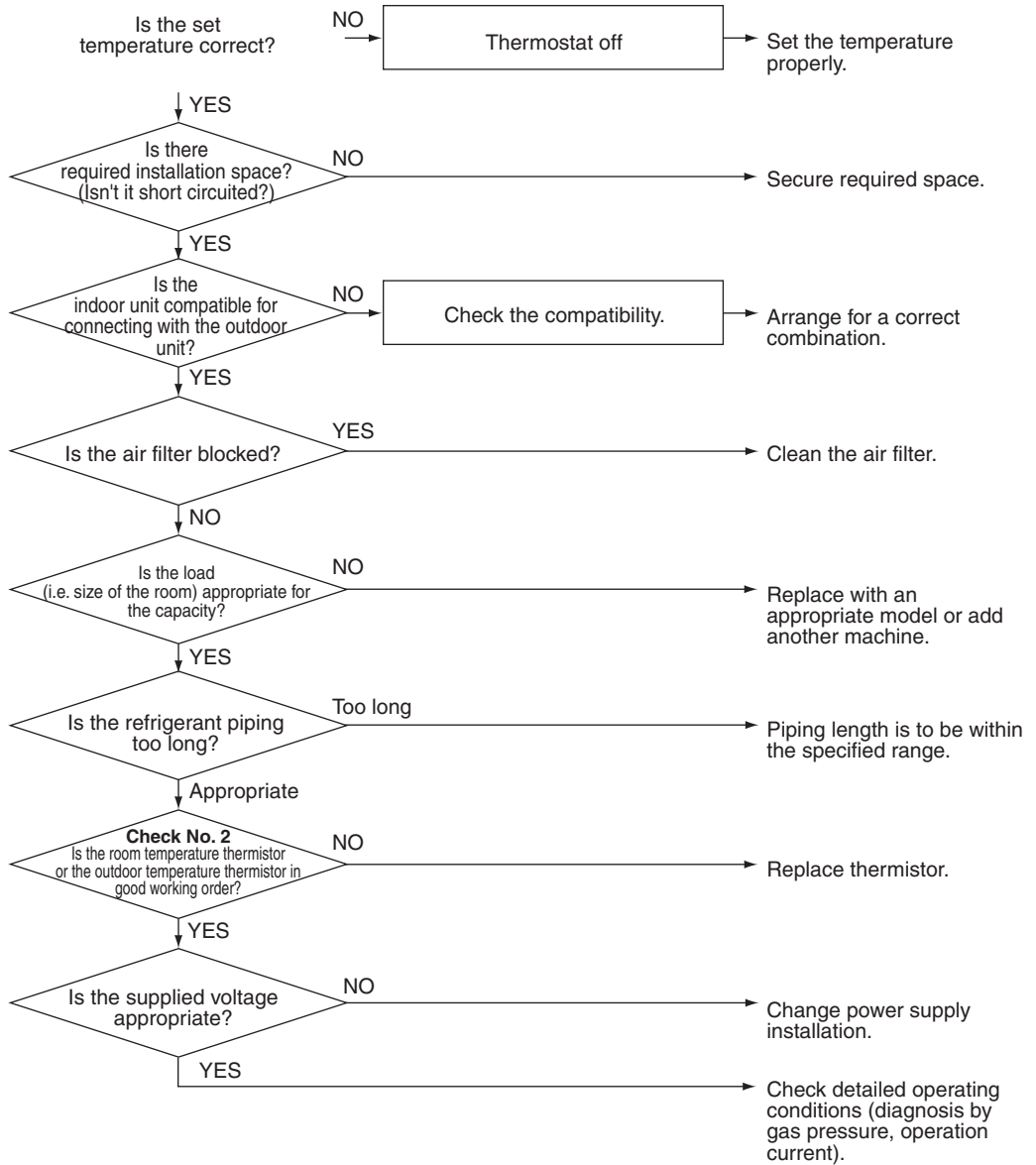

2.4 When operation starts, safety breaker works.

**Method of
Malfunction
Detection**

**Malfunction
Decision
Conditions**

**Supposed
Causes**

- Insufficient capacity of safety breaker
- Earth leakage breaker is too sensitive
- Not exclusive circuit
- The supply voltage is not within rated voltage $\pm 10\%$.
- The size of connecting wire is thin (indoor power supply unit)
- Air is mixed (over filling)
- Damaged outdoor unit PCB (short circuit)

Troubleshooting



Check No.29
Refer to P.212



Caution
[Power supply]

Be sure to turn off power switch before connect or disconnect connector, or parts damage may be occurred.

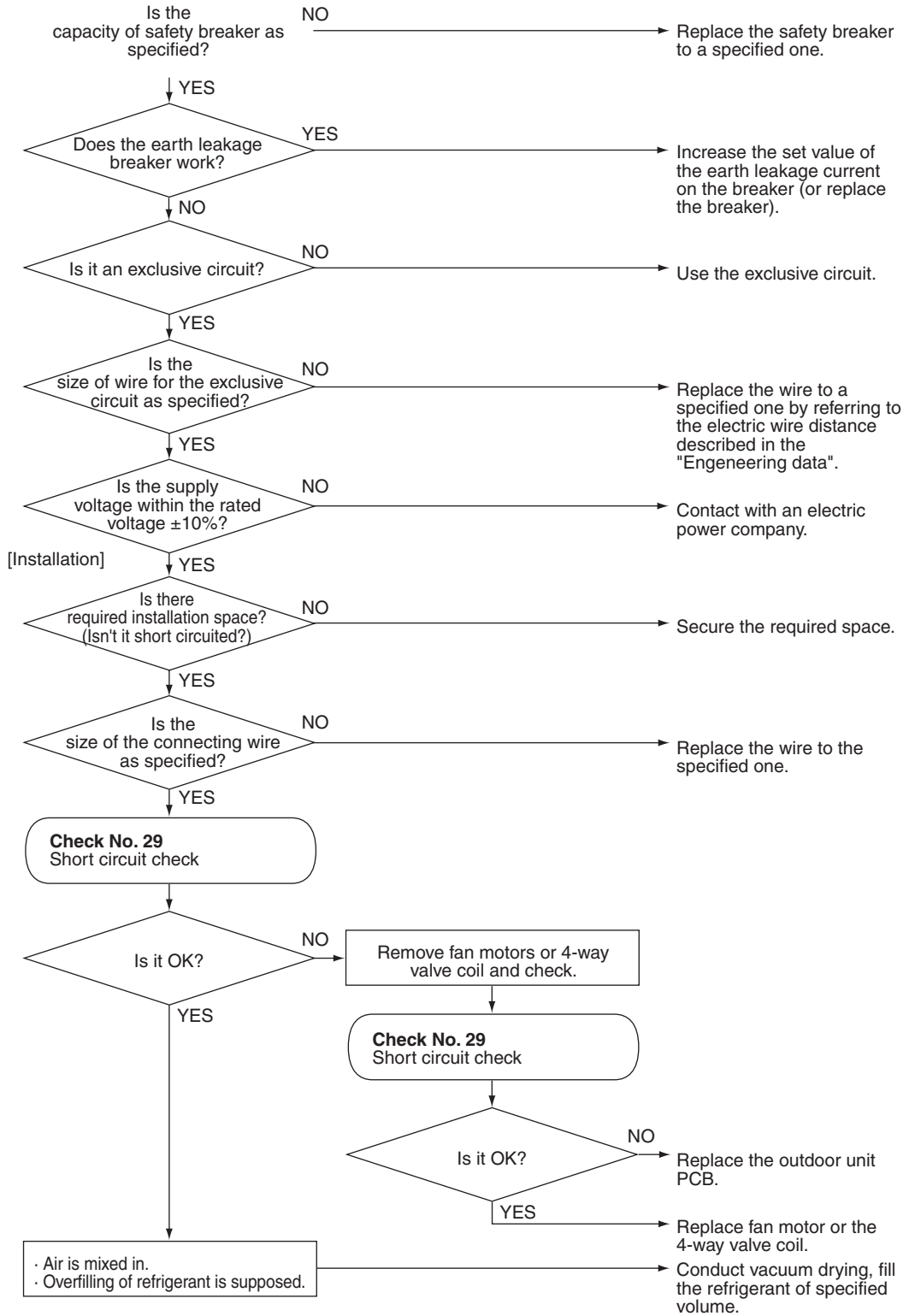

(R5999)

2.5 Air conditioner makes big noise and vibration.

Method of Malfunction Detection

Malfunction Decision Conditions

Supposed Causes

- Piping length is too short
- Mounting wall is too thin
- Insufficient vibration prevention measures
- Deformation of the unit
- Improper quantity of refrigerant

Troubleshooting



Caution

Be sure to turn off power switch before connect or disconnect connector, or parts damage may be occurred.

[Installation]

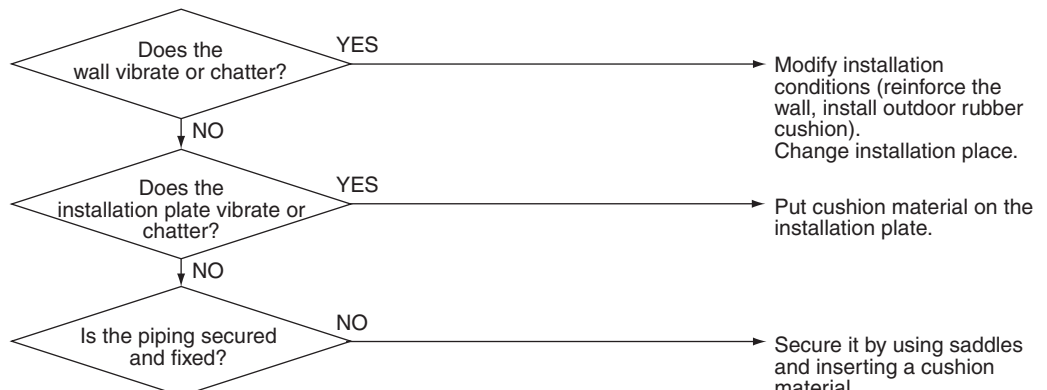

[Unit]

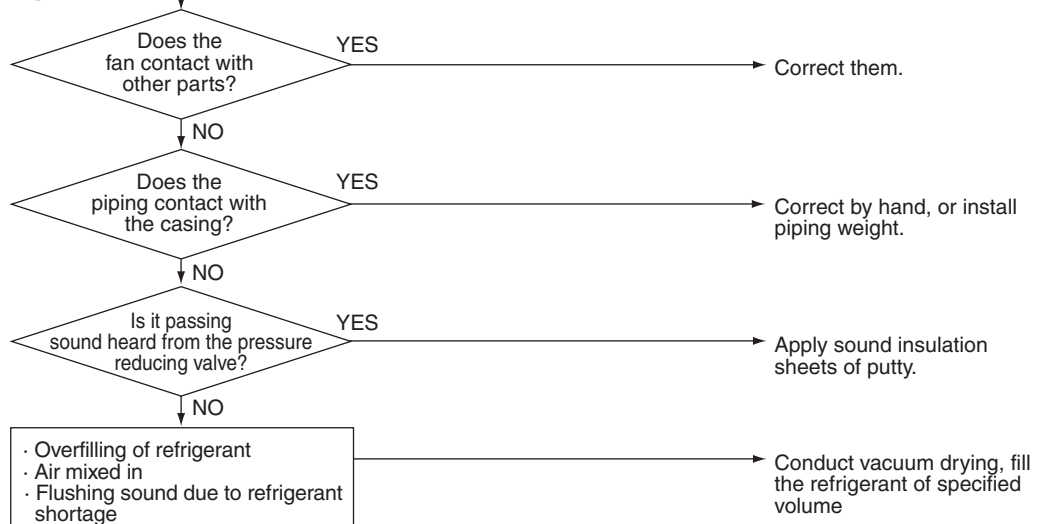

(R3403)

2.6 Air does not humidified enough.

Method of
Malfunction
Detection

Malfunction
Decision
Conditions

Supposed
Causes

- Hose length is not set
- Incorrect setting
- Short circuited at outdoor unit
- Blocked humidification filter
- Insufficient heat insulation of duct
- Indoor ventilation is made too often
- Ceiling is very high.

Troubleshooting



Caution Be sure to turn off power switch before connect or disconnect connector, or parts damage may be occurred.

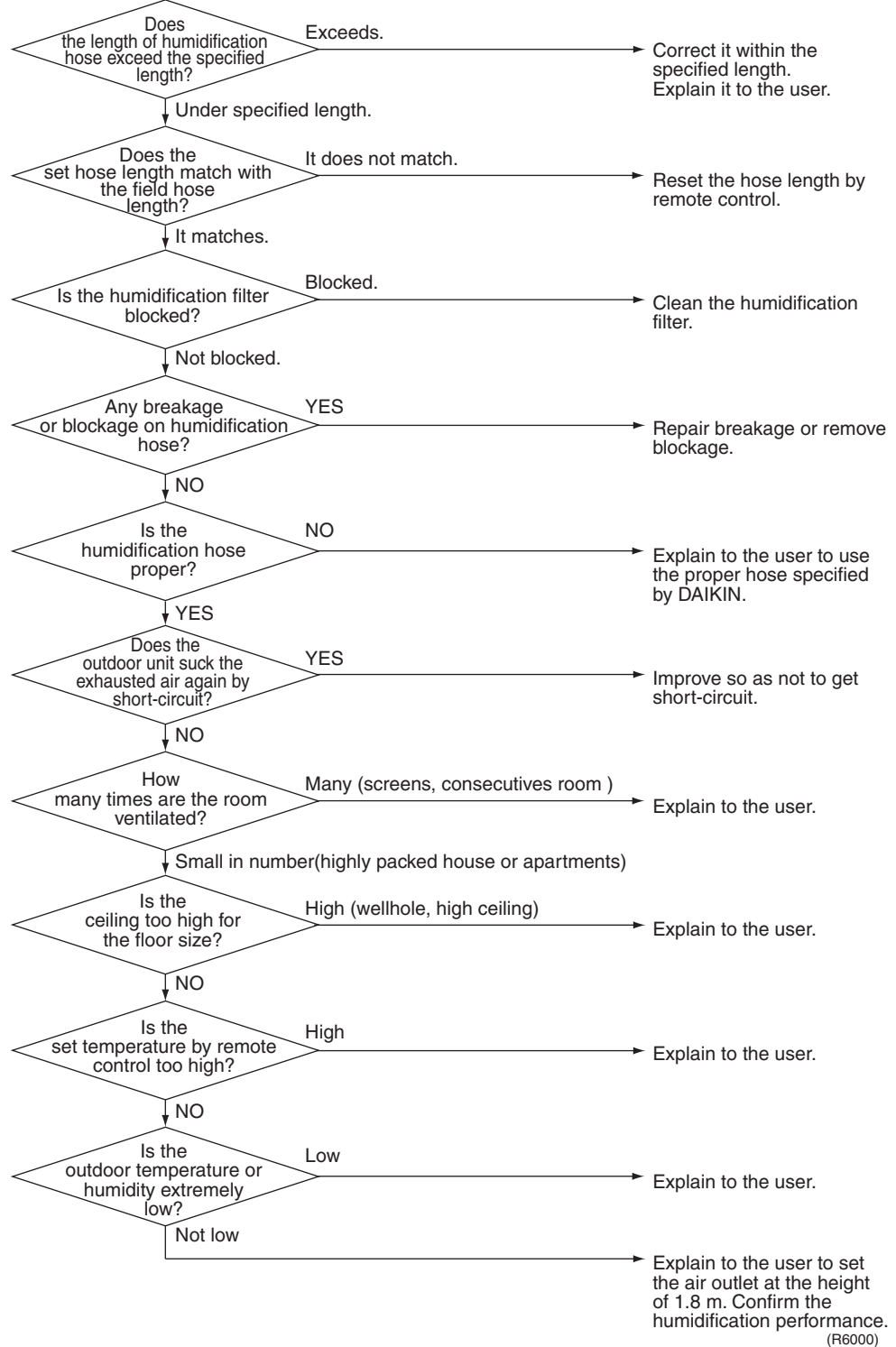

2.7 Indoor Unit PCB Fault

Remote Control Display *A1*

Method of Malfunction Detection

Check zero-cross detection from the power supply of the indoor unit

Malfunction Decision Conditions

When no zero-cross detection is performed in approximately 10 continuous seconds

Supposed Causes

- Defective indoor unit PCB (Faulty EEPROM data)
- Improper connector connection
- Defective indoor terminal board

Troubleshooting



Caution

Be sure to turn off power switch before connect or disconnect connector, or parts damage may be occurred.

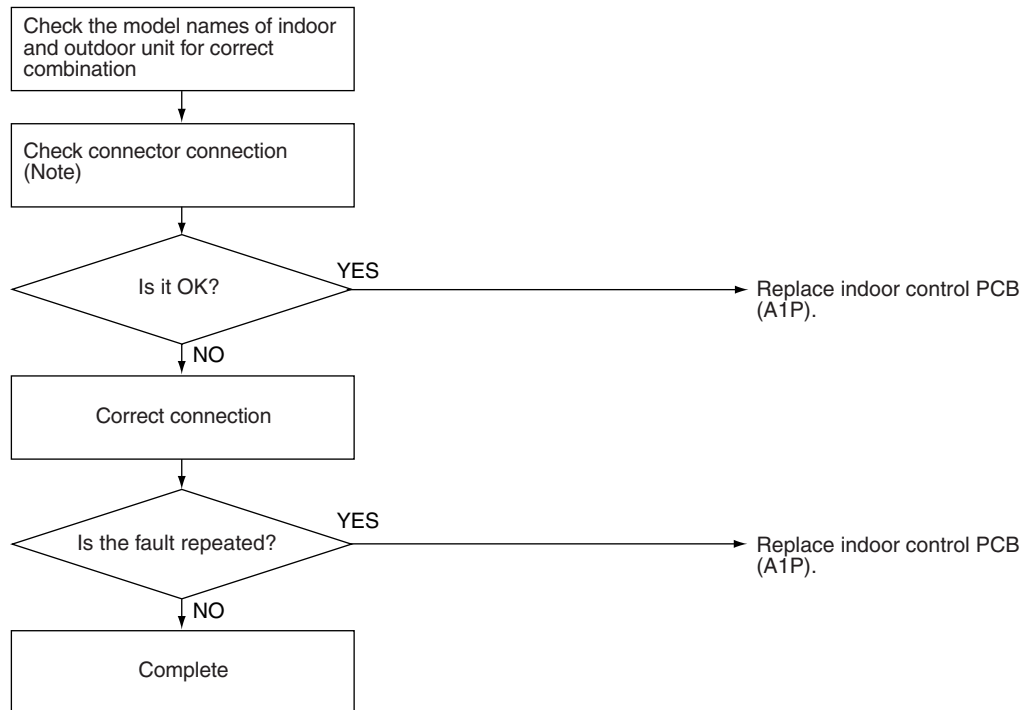

Note:

- Between terminal board and indoor control PCB.

(R6001)

2.8 Peak-cut Control or Freeze-up Protection

Remote Control
Display

AS

**Method of
Malfunction
Detection**

- Peak-cut control (high pressure control)
During heating operation, the temperature detected by the indoor heat exchanger thermistor is used for the high pressure control (stop, outdoor fan stop, etc.).
- Freeze-up protection control (operation halt) is activated during cooling operation according to the temperature detected by the indoor heat exchanger thermistor.

**Malfunction
Decision
Conditions**

- Peak-cut control
On heating operation, when indoor heat exchanger temperature is about 65°C or more
- Freeze-up protection
On cooling operation, indoor heat exchanger temperature is 0°C or less

**Supposed
Causes**

- Halt due to dirty indoor unit filter
- Halt due to dirty indoor heat exchanger
- Halt due to short circuit
- Faulty detection due to defective indoor heat exchanger thermistor
- Reheating dehumidification solenoid valve remains closed (on cooling operation)
- Faulty detection due to defective indoor unit PCB

Troubleshooting



Check No.2
Refer to P.202



Caution

Be sure to turn off power switch before connect or disconnect connector, or parts damage may be occurred.

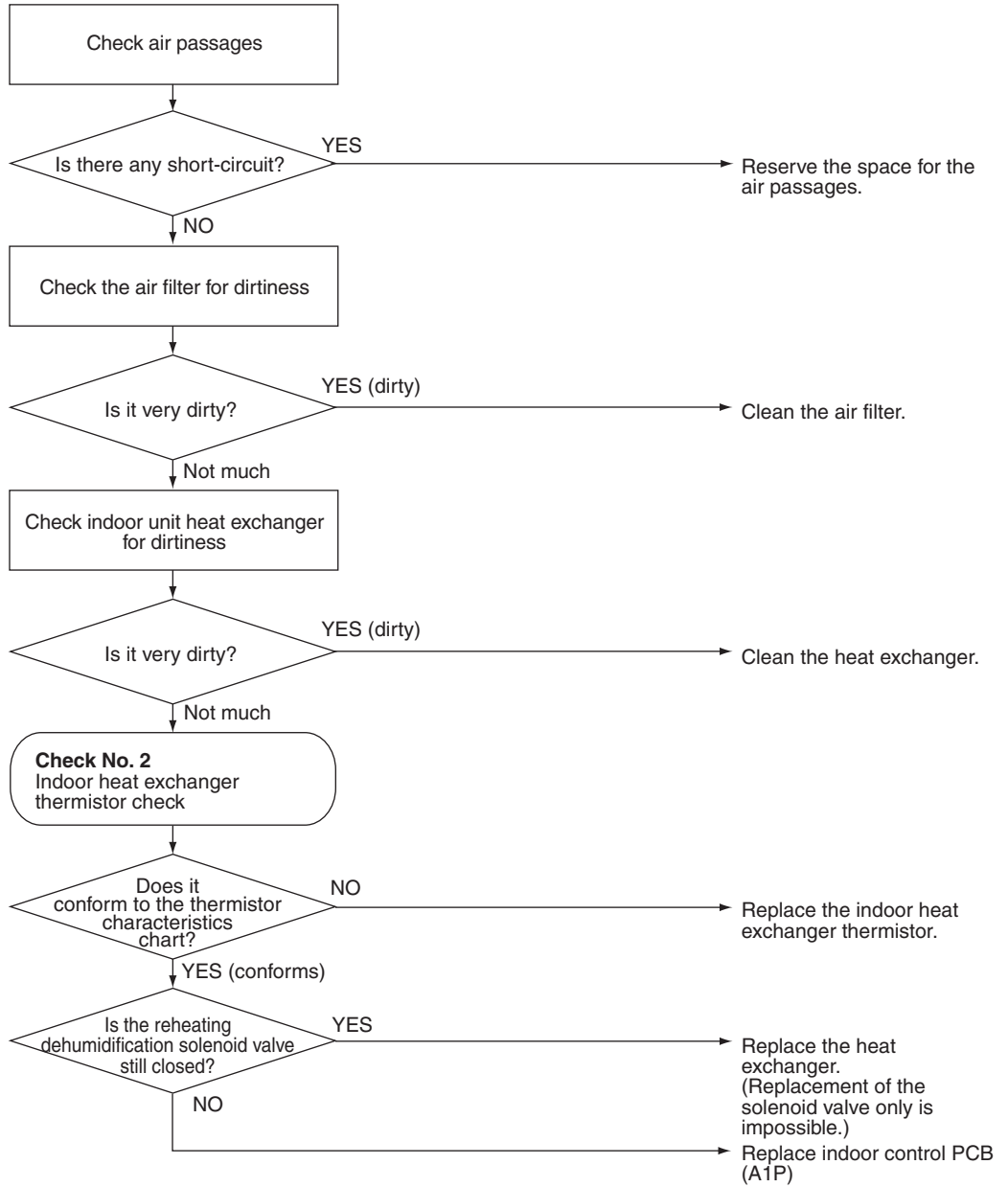

(R6002)

2.9 Fan Motor System (DC Motor) Fault

Remote Control
Display

AB

Method of
Malfunction
Detection

The fan speed detected by the Hall IC during operation of high-pressure fan motor is used to determine abnormal fan operation.

Malfunction
Decision
Conditions

When the detected fan speed is less than 50% of the HH tap under maximum fan motor rpm demanded

Supposed
Causes

- Halt due to rare short circuit inside the fan motor
- Halt due to breakage of wire inside the fan motor
- Halt due to breakage of the lead wire of fan motor
- Faulty detection due to defective indoor control PCB

Troubleshooting



Check No.18
Refer to P.210



Caution Be sure to turn off power switch before connect or disconnect connector, or parts damage may be occurred.

Turn off the power supply
(Turn off the breaker).

Check the connector connection
(S1).

* Connect the connector again for ensuring the connection.

Caution
If the connector is disconnected while the power ON, the motor will be broken.
(Turn power off when connecting the connector.)

Is it normal?

NO

Correct the connection.

YES

Foreign matters in or around the fan?

YES

Remove.

NO

Operate the fan.

Does it rotate smoothly?

NO

Replace the indoor fan motor.

YES

Turn off the power and turn power ON again.

Check No. 18
Check output of indoor unit control PCB (A1P)

Is motor power supply voltage generated?

NO

Replace the indoor unit control PCB (A1P).

YES

Is motor control power voltage DC 15V

NO

Replace the indoor unit control PCB (A1P).

YES

Is rotation number command voltage (DC 5V or more) generated?

NO

Replace the indoor unit control PCB (A1P).

YES

Replace the fan motor.

(R6003)

2.10 Streamer Unit Fault

Remote Control Display *AH*

Method of Malfunction Detection

Malfunction Decision Conditions

- If the error repeats 3 times in air purifying operation.
 - Clearing condition: Continuous run for about 2 minutes (normal).
-

Supposed Causes

- Short circuit caused by the dust or drip of water on the streamer unit electrode part.
- Scratch or crack in the harness for the streamer unit.
- Faulty Streamer unit PCB

Troubleshooting



Caution Be sure to turn off power switch before connect or disconnect connector, or parts damage may be occurred.

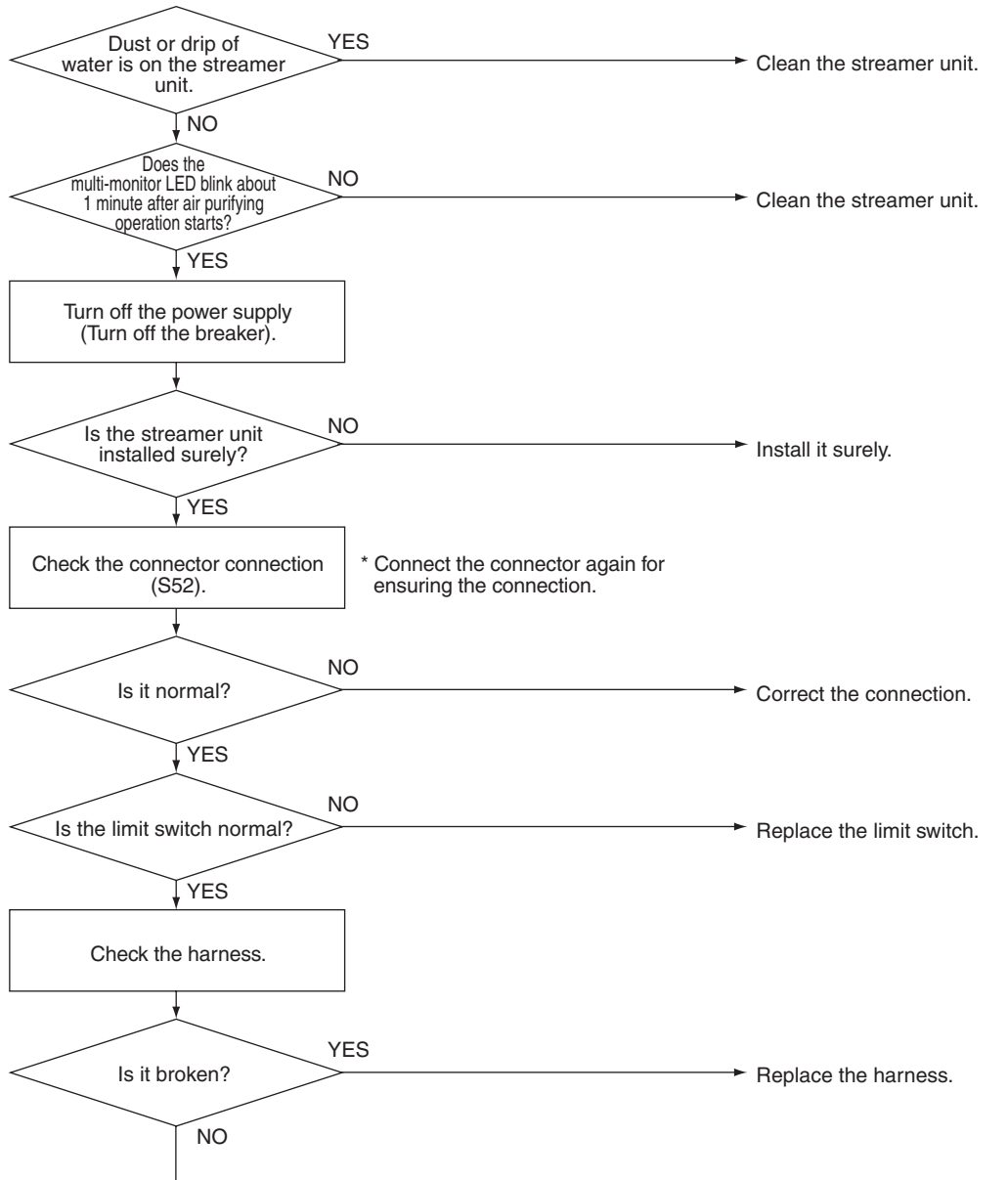

Replace the streamer unit PCB (A5P)
Note 1. Be careful not to break the electrode in cleaning.
Note 2. Since the electrode part is electrified in high voltage, be sure to pull out the power supply plug or turn breaker off in cleaning the electrode part. (Touching in electrifying results in electrical shock.)
 (R6006)

2.11 Thermistor System Fault

Remote Control
Display

Ⓛ4, Ⓛ9

Method of
Malfunction
Detection

Thermistor fault is detected based on the temperature determined by each thermistor

Malfunction
Decision
Conditions

When power is supplied and the input of thermistor is 4.96 V or more or 0.04 V or less
* (for reference)
In case of 120 Ω (equivalent to 212°C) or less or 1860 kΩ (equivalent to -50°C) or more

Supposed
Causes

- Improper connector connection
- Defective thermistor
- Defective PCB for indoor unit control system
- Defective PCB for indoor humidity sensor

Troubleshooting
Chart



Check No.2
Refer to P.202

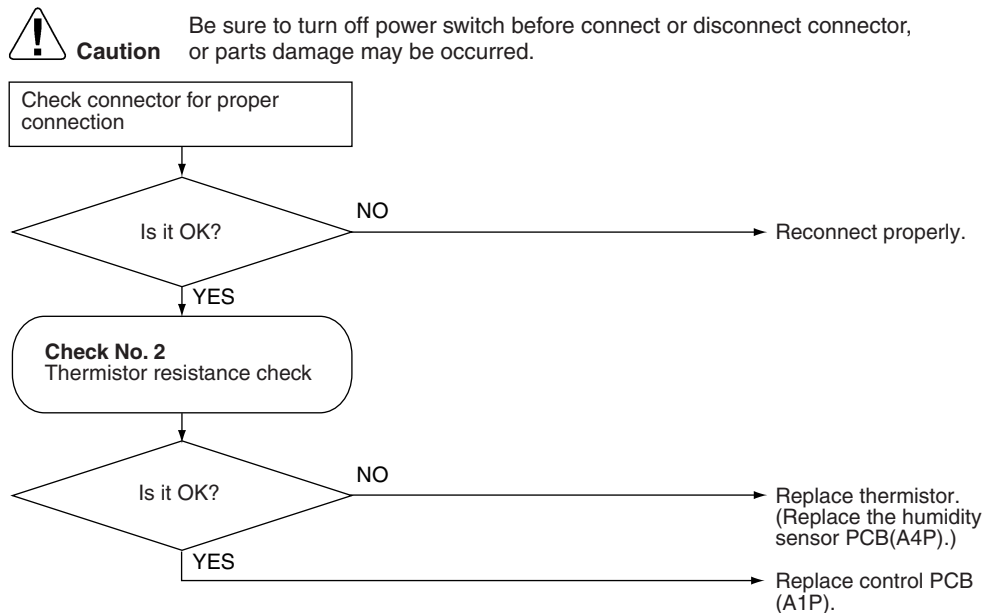

Ⓛ4 : Indoor heat exchanger thermistor

Ⓛ9 : Room temperature thermistor

(R6005)

2.12 Front Panel Open / Close Fault

Remote Control Display E7

Method of Malfunction Detection

Malfunction Decision Conditions

- The system will be shut down when the error occurs twice.

Supposed Causes

- Malfunction of the reduction motor
- Malfunction or deterioration of the front panel mechanism
- Malfunction of the limit switch

Troubleshooting

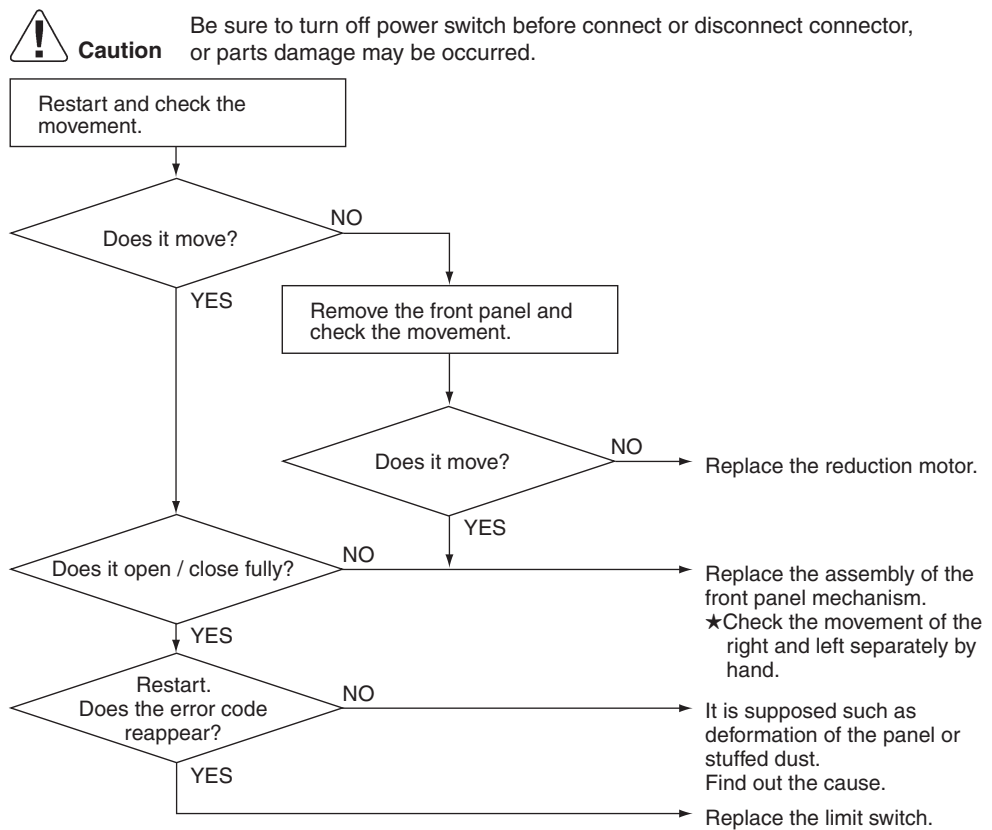

(R3313)

 **Note:** You cannot operate the unit by the remote control when the front panel mechanism breaks down.

<To the dealers: temporary measure before repair>

1. Turn the breaker off.
2. Remove the front panel.
3. Turn the breaker on.
(Wait until the initialization finishes.)
4. Operate the unit by the indoor unit ON/OFF switch.

2.13 Humidity Sensor Fault

Remote Control Display



Method of Malfunction Detection

Sensor faulty is detected by input value.

Malfunction Decision Conditions

When the input from a temperature sensor is 4.96 V or more or 0.04 V or less*

Supposed Causes

- Improper connector connection
- Defective indoor control PCB
- Defective humidity sensor PCB

Troubleshooting



Check No.27
Refer to P.212



Caution

Be sure to turn off power switch before connect or disconnect connector, or parts damage may be occurred.

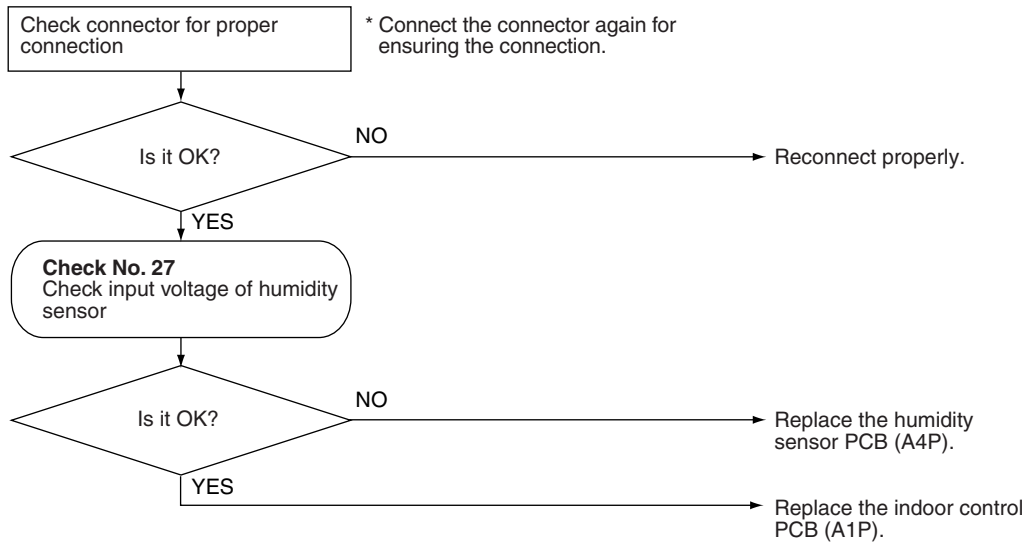

* Connect the connector again for ensuring the connection.

☐ : Humidity sensor

(R3414)

2.14 Signal Transmission Error (Indoor Unit - Outdoor Unit)

Remote Control
Display

U4

Method of
Malfunction
Detection

The data sent from the outdoor unit is checked for problem.

Malfunction
Decision
Conditions

When the data sent from the outdoor unit can not be received without error, or when the disable status of signal transmission continues for 15 sec. and the same status continuously repeats 3 times.

Supposed
Causes

- Defective outdoor unit PCB
- Defective indoor unit PCB
- Signal transmission error between indoor and outdoor unit due to improper wiring
- Signal transmission error between indoor and outdoor unit due to breakage of relay wire (transmission wire)

Troubleshooting



Caution

Be sure to turn off power switch before connect or disconnect connector, or parts damage may be occurred.

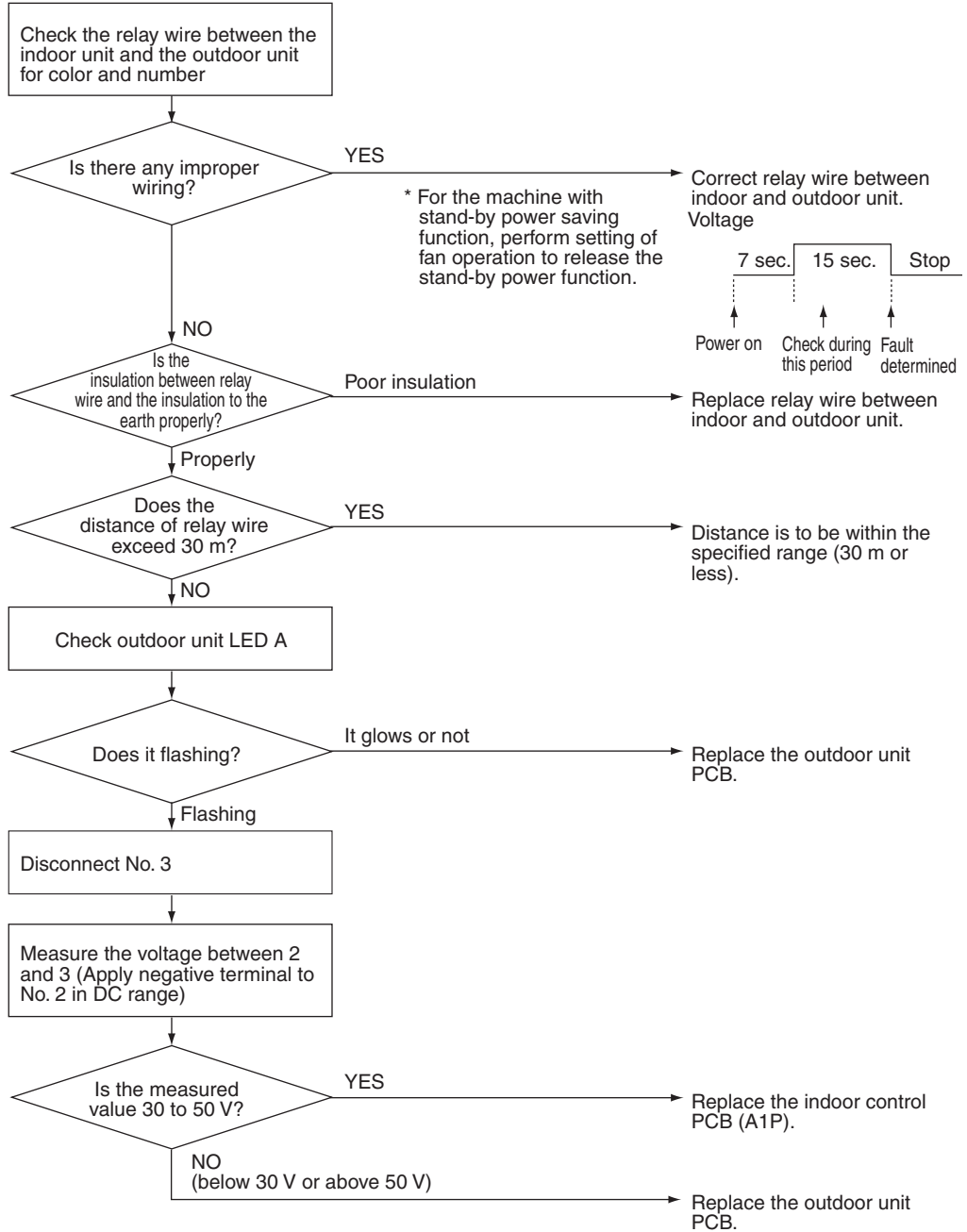

(R6006)

2.15 Incompatible Power Supply between Indoor Unit and Outdoor Unit

Remote Control Display

UR

Method of Malfunction Detection

Check the incompatible power supply between indoor unit and outdoor unit by using signal transmission.

Method of Malfunction Detection

In case that the indoor intake model is connected to outdoor intake model.

Supposed Causes

- Connected to wrong model
- Mounted improper indoor unit PCB
- Defective indoor unit PCB
- Mounted improper outdoor unit PCB or defective PCB

Troubleshooting



Caution

Be sure to turn off power switch before connect or disconnect connector, or parts damage may be occurred.

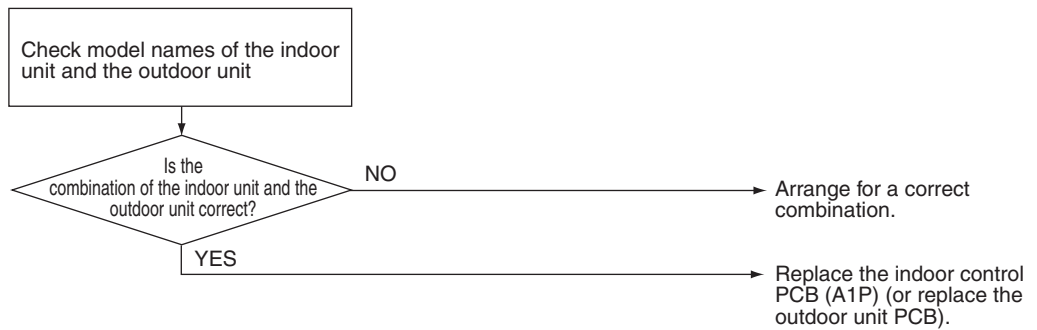

(R6007)

2.16 Incomplete Setting for Hose Length

Remote Control
Display

UA

Method of
Malfunction
Detection

This fault occurs when the humidification hose length is not stored in the EEPROMs of the indoor unit and the outdoor unit.
(Hose length is not stored at initial power on.)

Malfunction
Decision
Conditions

- When the humidification hose length is not stored in EEPROMs of the indoor unit and the outdoor unit.

Supposed
Causes

Hose length is not set.
Hose length is erased by replacement of the indoor unit PCB or the outdoor unit PCB. (When both the indoor unit and the outdoor unit PCBs are replaced simultaneously, the set value is erased.)

Troubleshooting



Caution

Be sure to turn off power switch before connect or disconnect connector, or parts damage may be occurred.

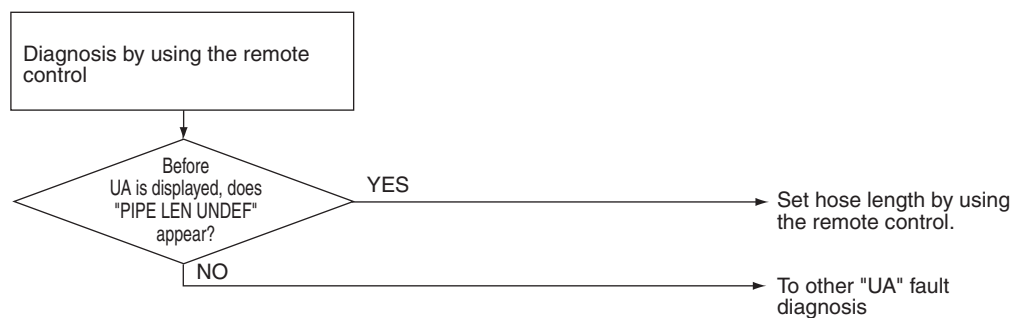

(R3418)

2.17 Outdoor Unit PCB Fault

Remote Control Display

E1

Outdoor Unit LED Display

A 5

Method of Malfunction Detection

- Detect within the programme of the microcomputer that the programme is in good running order.
- Detect input of zero-cross signal.

Malfunction Decision Conditions

- When the programme of the microcomputer is in bad running order.
- Zero-cross signal can not be detected.

Supposed Causes

- Out of control of microcomputer caused by external factors
 - Noise
 - Momentary fall of voltage
 - Momentary power loss
- Defective outdoor unit PCB
- Breakage of harness between PCBs

Troubleshooting



Caution

Be sure to turn off power switch before connect or disconnect connector, or parts damage may be occurred.

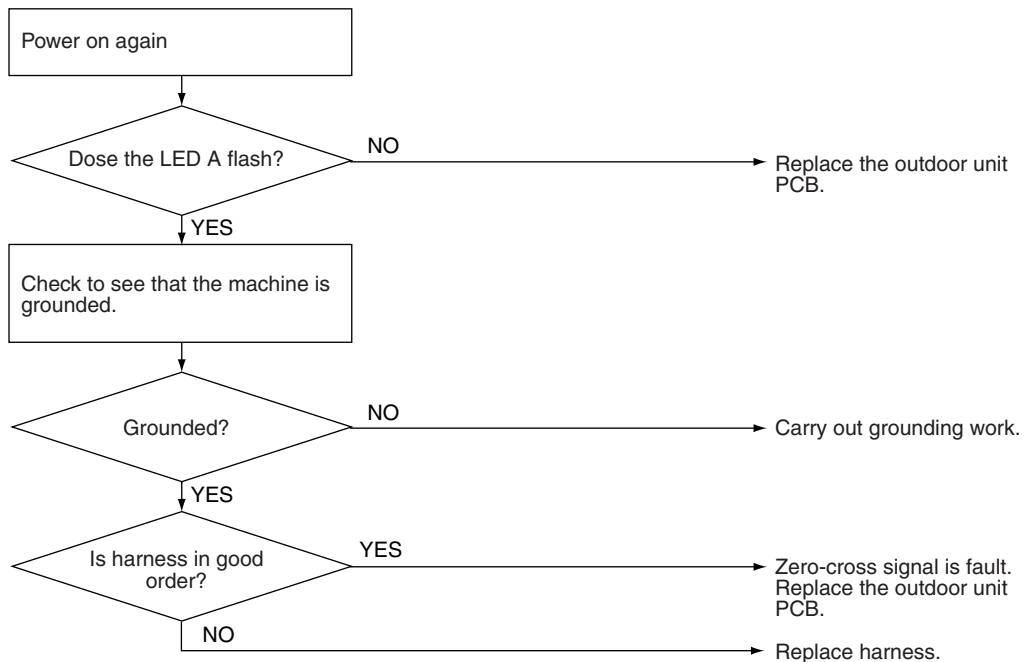

(R6008)

2.18 OL Activation (Compressor Overload)

Remote Control Display **E5**

Method of Malfunction Detection
A compressor overload is detected through compressor OL.

Malfunction Decision Conditions

- If the compressor OL is activated twice, the system will be shut down.
- The error counter will reset itself if this or any other error does not occur during the following 60-minute compressor running time (total time).

* The operating temperature condition is not specified.

Supposed Causes

- Refrigerant shortage
- Four way valve malfunctioning
- Outdoor unit PCB defective
- Water mixed in the local piping
- Electronic expansion valve defective
- Stop valve defective

Troubleshooting

Check No.2
Refer to P.202

Check No.12
Refer to P.205

Check No.17
Refer to P.209

Check No.31
Refer to P.213

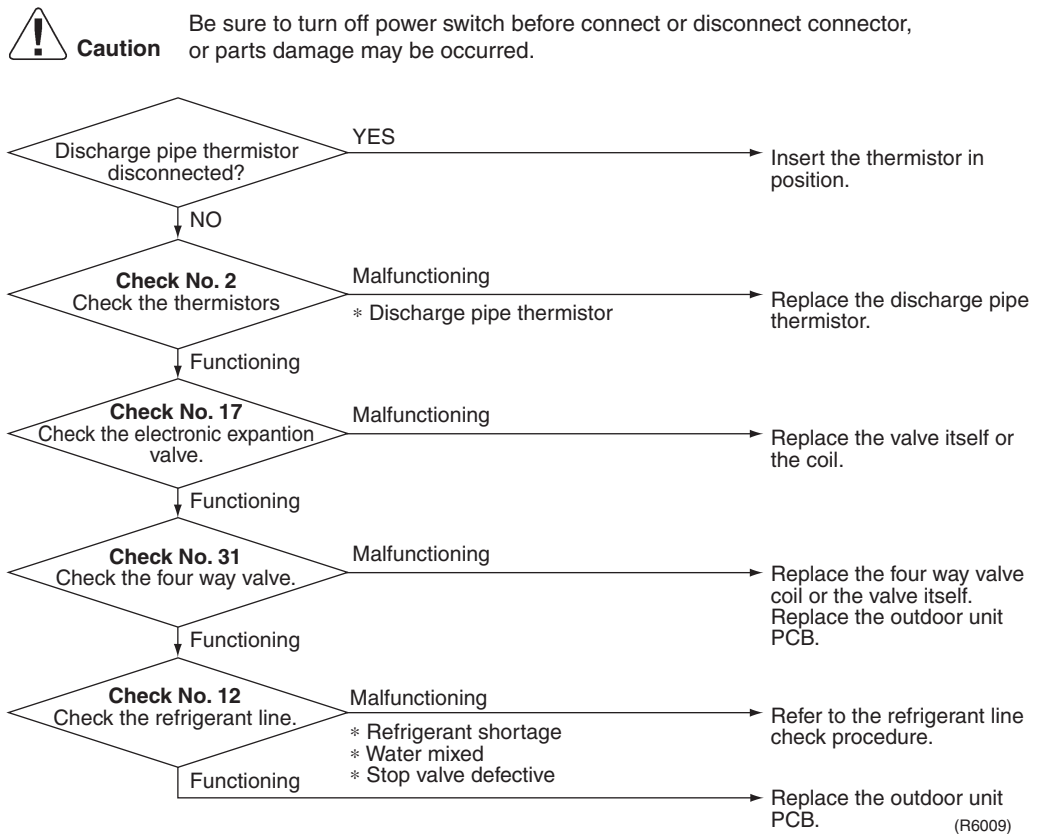

2.19 Compressor Lock

Remote Control Display

EE

Outdoor Unit LED Display

A 5 (-)

Method of Malfunction Detection

Judging from current waveform generated when high-frequency voltage is applied to the compressor.

Malfunction Decision Conditions

- The machine is shut down when the fault count reaches 16.
- Clear condition: Continuous operation for 11 min. (without fault)

Supposed Causes

- Compressor lock
- Disconnection of compressor harness

Troubleshooting



Caution

Be sure to turn off power switch before connect or disconnect connector, or parts damage may be occurred.

Check No.14
Refer to P.206

Turn off the power supply, and disconnect U, V, and W harnesses

Check No.14
Check the inverter by the inverter checker*

* Inverter checker
Part No.: 1225477

Is it OK?

NO

Rectify the power supply or replace the outdoor unit PCB.

YES

Turn off the power supply, replace the harnesses, and restart the compressor after turning on the power supply again.

Does the compressor stop without running?

YES

Replace the compressor.

NO

Does the machine shut down after repeating stop of compressor several times?

NO

Check the electronic expansion valve. Replace the electronic expansion valve.

YES

Replace the compressor.

(R6010)

2.20 DC Fan Lock

Remote Control Display *E7*

Outdoor Unit LED Display A Φ 5 Φ (-)

Method of Malfunction Detection Identify the fan motor system fault based on fan speed detected by Hall IC during high pressure fan motor running.

- Malfunction Decision Conditions**
- When the fan motor is running, the fan does not rotate for 60 sec. or more.
 - Shut down when the error repeats 16 times
 - Clear condition: The fan continuously rotates for 11 min.(without fault)

- Supposed Causes**
- Failure in fan motor
 - Disconnection or improper connection of harness/connector between fan motor and PCB
 - The fan does not rotate because it gets caught in foreign matter

Troubleshooting



Check No.23
Refer to P.211



Caution

Be sure to turn off power switch before connect or disconnect connector, or parts damage may be occurred.

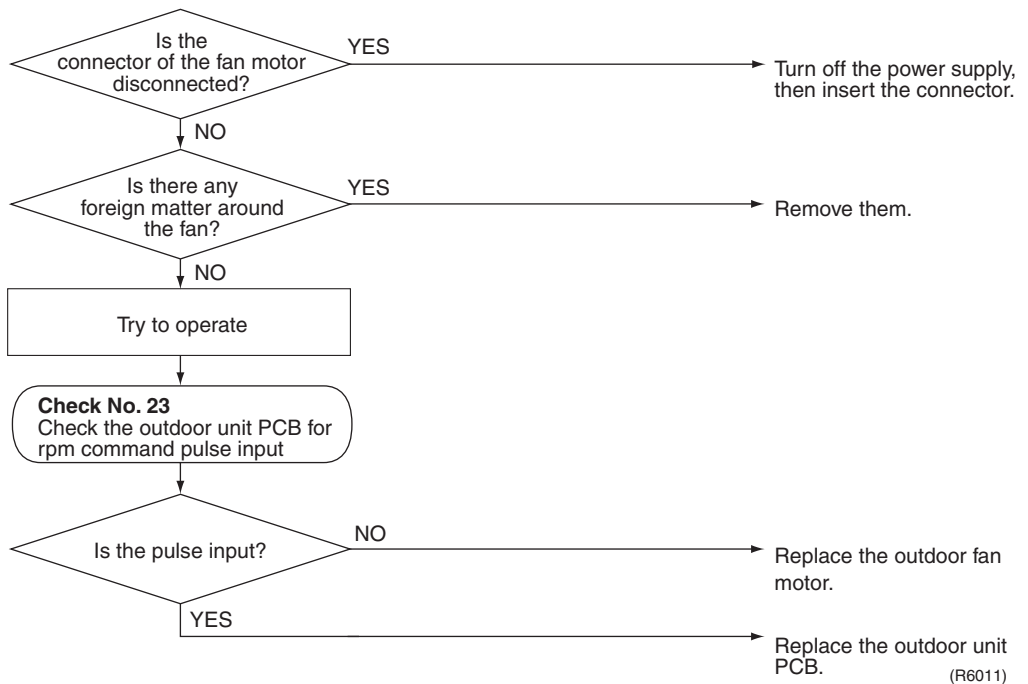

2.21 Input Over Current Detection

Remote Control
Display

EE

Outdoor Unit LED
Display

A Φ 5 Φ (-)

Method of
Malfunction
Detection

Detect an input overcurrent by checking the inverter power consumption or the input current detected by CT with the compressor running.

Malfunction
Decision
Conditions

- When 14 A or more of inverter power consumption or CT input continues for 5 sec.
- The compressor stops if the error occurs, and restarts automatically after 3 minutes standby.

Supposed
Causes

- Overcurrent due to defective compressor
- Overcurrent due to defective power transistor
- Overcurrent due to defective electrolytic capacitor of inverter main circuit
- Overcurrent due to defective outdoor unit PCB
- Detection error due to defective outdoor unit PCB
- Overcurrent due to short circuit

Troubleshooting



Check No.3
Refer to P.203



Check No.11
Refer to P.205



Check No.14
Refer to P.206



Check No.16
Refer to P.208



Caution

Be sure to turn off power switch before connect or disconnect connector, or parts damage may be occurred.

*Input over current may be caused by improper wiring inside the machine. If the machine stops due to input over current after connecting or disconnecting wires to replace part, check wiring for proper connection.

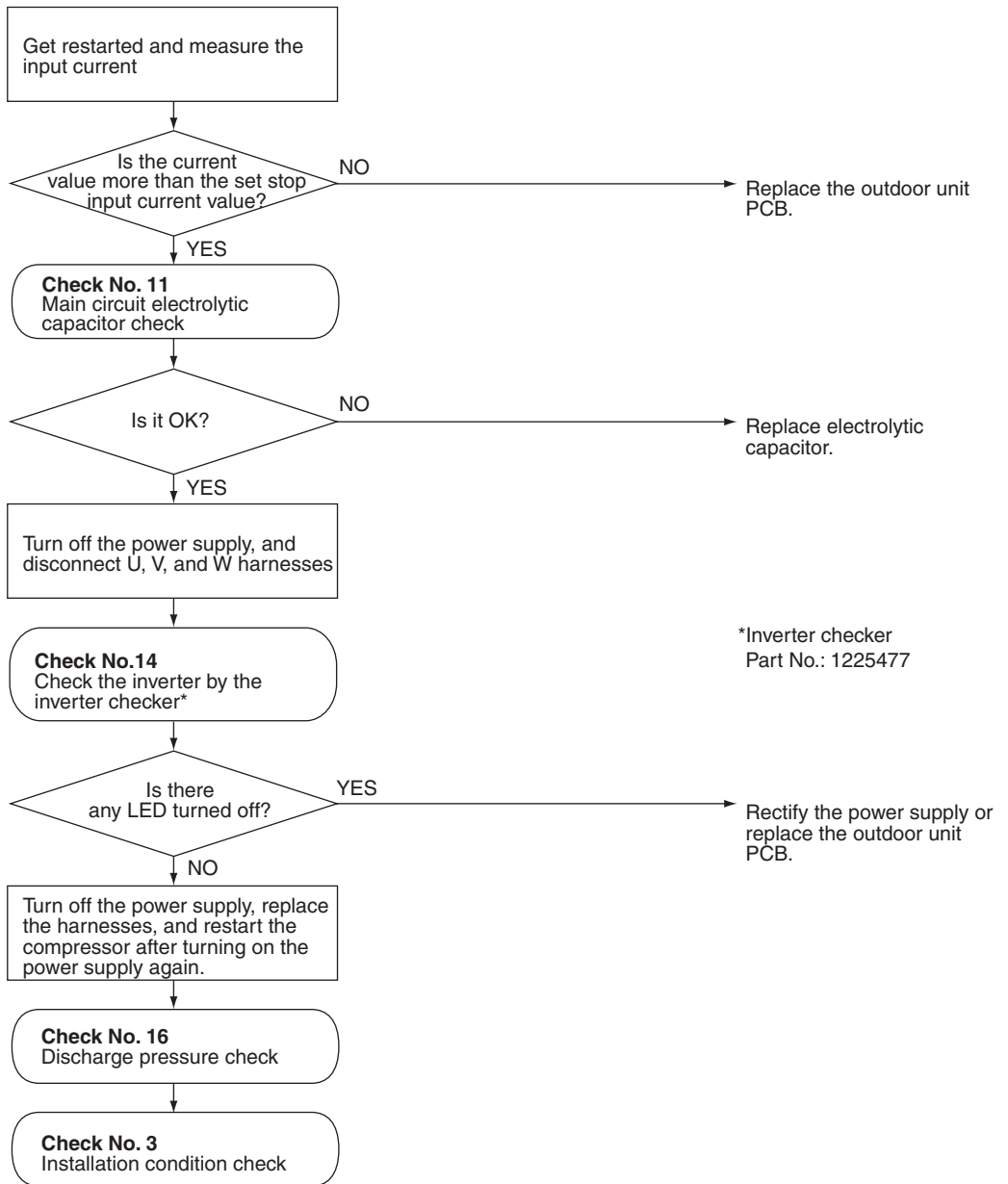

*Inverter checker
Part No.: 1225477

(R6012)

2.22 Four Way Valve Fault

Remote Control Display *ER*

Outdoor Unit LED Display A Φ 5 Φ (-)

Method of Malfunction Detection
 The room temperature thermistor, the indoor heat exchanger thermistor, the outdoor air thermistor, and the outdoor heat exchanger thermistor are checked to see if they function within their normal ranges in the operating mode.

Malfunction Decision Conditions
 ■ When one of the follow condition continues for 10 min, the compressor stops, and restarts automatically after 3 minutes standby.

Cooling / drying

(Room temperature – temperature of indoor heat exchanger) < – 5°C

Heating

(Temperature of indoor heat exchanger – room temperature) < – 5°C

- Shut down when the error repeats twice
- Clear condition : Continuous operation for 60 minutes.

- Supposed Causes**
- Improper connector connection
 - Defective thermistor
 - Defective outdoor unit PCB
 - Defective coil or harness of 4-way valve
 - Defective 4-way valve
 - Insufficient gas
 - Foreign substance mixed in refrigerant

Troubleshooting



Check No.2
Refer to P.202



Check No.12
Refer to P.205



Check No.31
Refer to P.213



Caution Be sure to turn off power switch before connect or disconnect connector, or parts damage may be occurred.

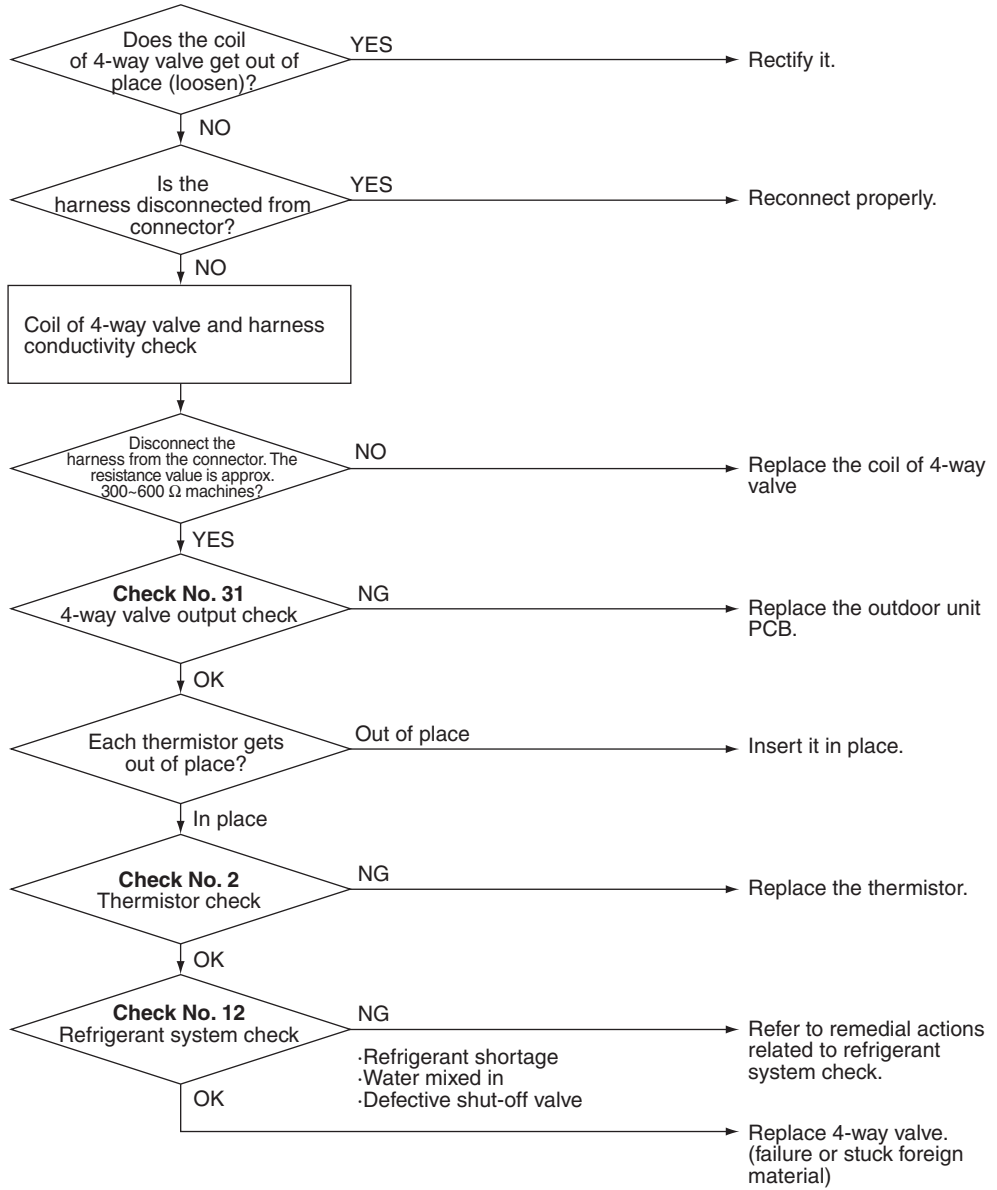

(R6013)

2.23 Discharge Pipe Temperature Control

Remote Control Display

F3

Outdoor Unit LED Display

A Φ 5 Φ (-)

Method of Malfunction Detection

Discharge pipe temperature control (stop, frequency attenuation, etc.) is executed based on the temperature detected by the discharge pipe thermistor.

Malfunction Decision Conditions

- The compressor stops when the discharge pipe temperature is 118°C or more. (Fault condition is cleared when the discharge pipe temperature is below 85°C)
- Shut down when the error repeats 4 times
- Clear condition : Continuous operation for 60 minutes

Supposed Causes

- Insufficient gas
- Faulty operation of 4-way valve
- Defective discharge pipe thermistor (Defective heat exchanger thermistor or outdoor air thermistor)
- Defective outdoor unit PCB
- Water mixed in the field piping
- Defective electronic expansion valve
- Defective stop valve
- Defective indoor solenoid valve

Troubleshooting



Check No.2
Refer to P.202



Check No.12
Refer to P.205



Check No.17
Refer to P.209



Caution

Be sure to turn off power switch before connect or disconnect connector, or parts damage may be occurred.

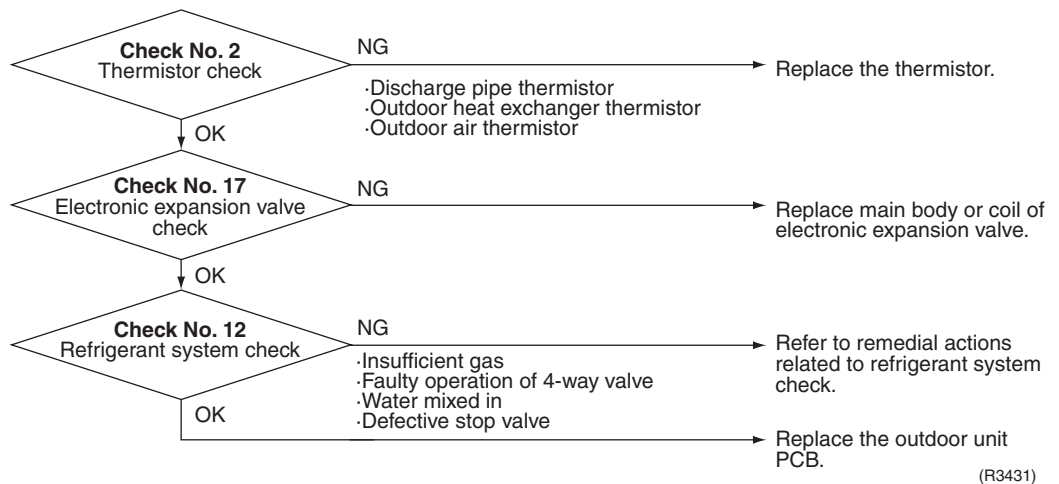

(R3431)

2.24 High Pressure Control in Cooling

Remote Control
Display

FE

Outdoor Unit LED
Display

A Φ 5 Φ (-)

Method of
Malfunction
Detection

During cooling, high pressure control (stop, frequency attenuation, etc.) is executed according to the temperature detected by the heat exchanger thermistor.

Malfunction
Decision
Conditions

During cooling, when the temperature detected by the heat exchanger thermistor is 63°C or more. (Fault condition is cleared when the temperature is below 52°C.)

Supposed
Causes

- Insufficient installation space
- Defective outdoor fan
- Defective electronic expansion valve
- Defective heat exchanger thermistor
- Defective outdoor unit PCB
- Defective stop valve
- Defective solenoid valve for dehumidification

Troubleshooting



Check No.2
Refer to P.202



Check No.3
Refer to P.203



Check No.5
Refer to P.203



Check No.16
Refer to P.208



Check No.17
Refer to P.209



Check No.32
Refer to P.214



Caution

Be sure to turn off power switch before connect or disconnect connector, or parts damage may be occurred.

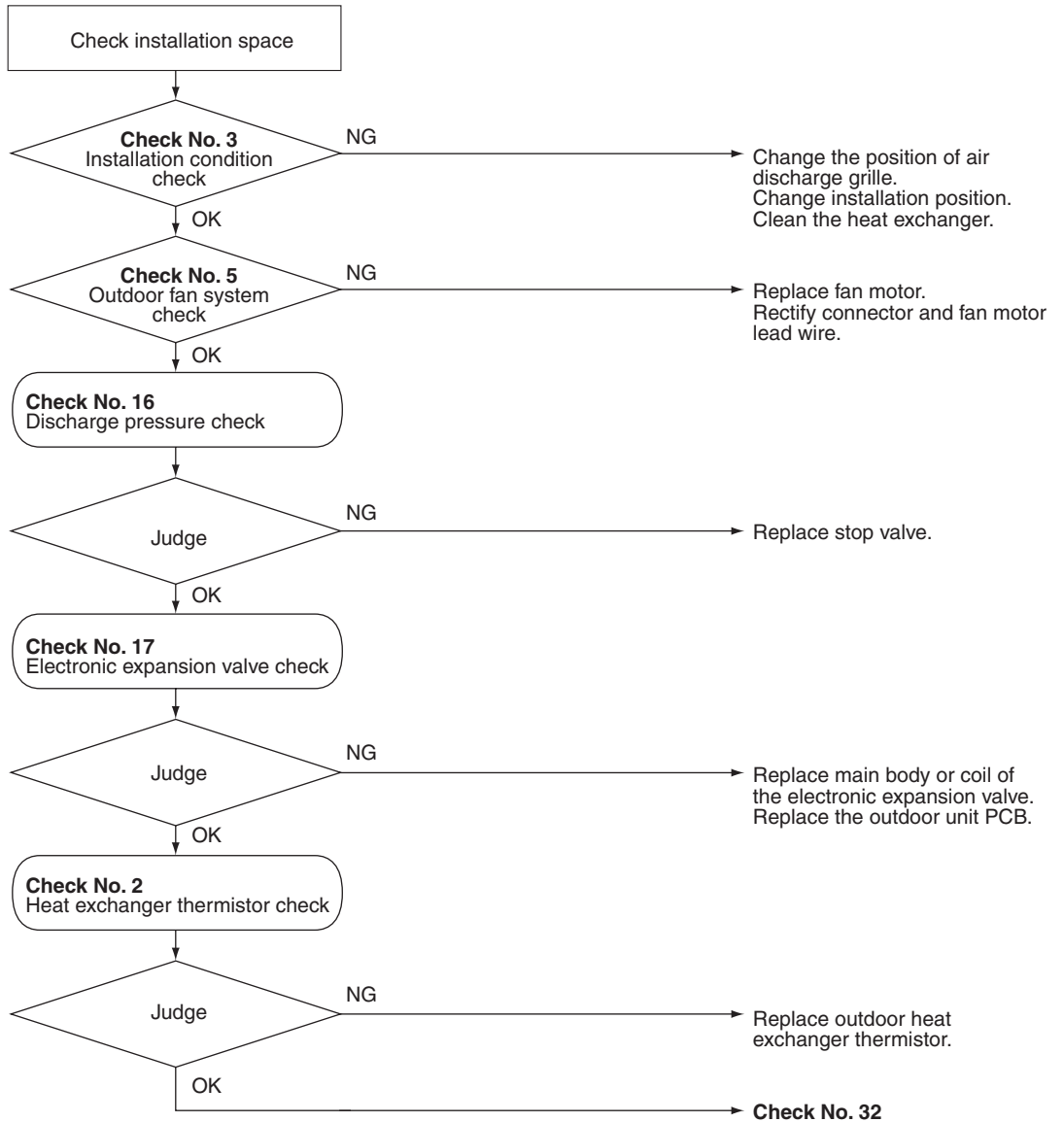

(R3433)

2.25 Compressor Sensor System Fault

Remote Control
Display *H0*

Outdoor Unit LED
Display A ϕ 5 ϕ (-)

Method of
Malfunction
Detection Fault condition is identified by DC current which is detected before compressor startup.

Malfunction
Decision
Conditions ■ When the DC current before compressor startup is other than 0.5 to 4.5 V (detected by converting the sensor output to voltage), or the DC voltage is 50 V or less.

Supposed
Causes ■ Defective PCB
■ Harness disconnection / defective connection

Troubleshooting



Caution

Be sure to turn off power switch before connect or disconnect connector, or parts damage may be occurred.

Replace the outdoor unit PCB.

2.26 Damper Fault

Remote Control Display

H1

Outdoor Unit LED Display

A \circ 5 \circ

Method of Malfunction Detection

Detected by the limit switch (LS) in the humidification unit.

Malfunction Decision Conditions

- Limit switch does not turn on or off when the operation of humidification unit starts or finishes. For example, when turning on the power supply, when humidification operation (including air intake) starts, or when inner heating dry cleaning starts.

Supposed Causes

- Faulty damper operation due to frost
- Faulty damper operation due to foreign material
- Limit switch fault (including improper connection)
- Defective motor for damper

Troubleshooting



Caution

Be sure to turn off power switch before connect or disconnect connector, or parts damage may be occurred.

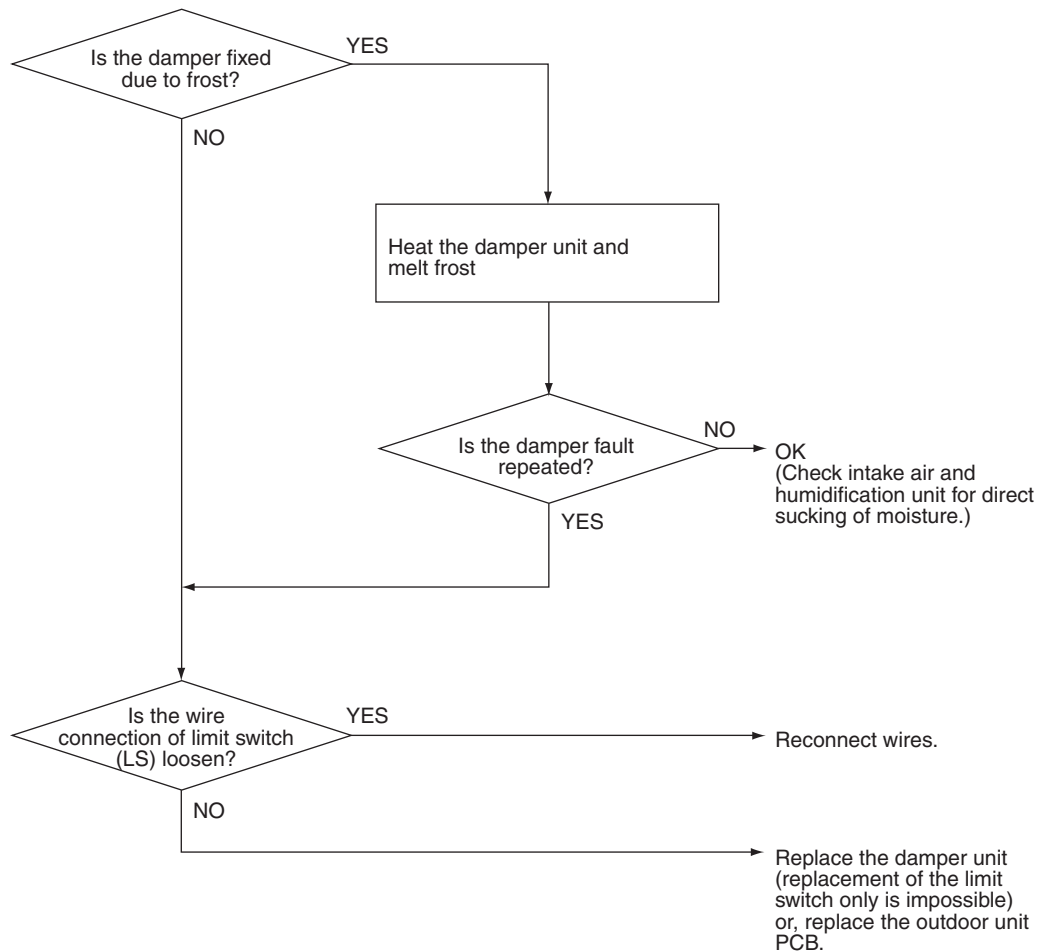

(R3435)

2.27 Position Sensor Fault

Remote Control
Display

H6

Outdoor Unit LED
Display

A ϕ 5 ϕ (-)

Method of
Malfunction
Detection

Startup failure of the compressor is identified by rpm information of the compressor and by electric component position detector.

Malfunction
Decision
Conditions

- When the compressor does not run for 15 sec. after receiving operation start command
- The machine shuts down if the fault occurs 16 times
- Clear condition: The compressor continuously runs for 10 min. without fault

Supposed
Causes

- Detection error due to disconnection of compressor harness
- Startup failure due to defective compressor
- Startup failure due to defective outdoor unit PCB
- Startup failure due to closed stop valve
- Input voltage fault

Troubleshooting



Check No.16
Refer to P.208



Check No.29
Refer to P.212



Check No.14
Refer to P.206



Caution Be sure to turn off power switch before connect or disconnect connector, or parts damage may be occurred.

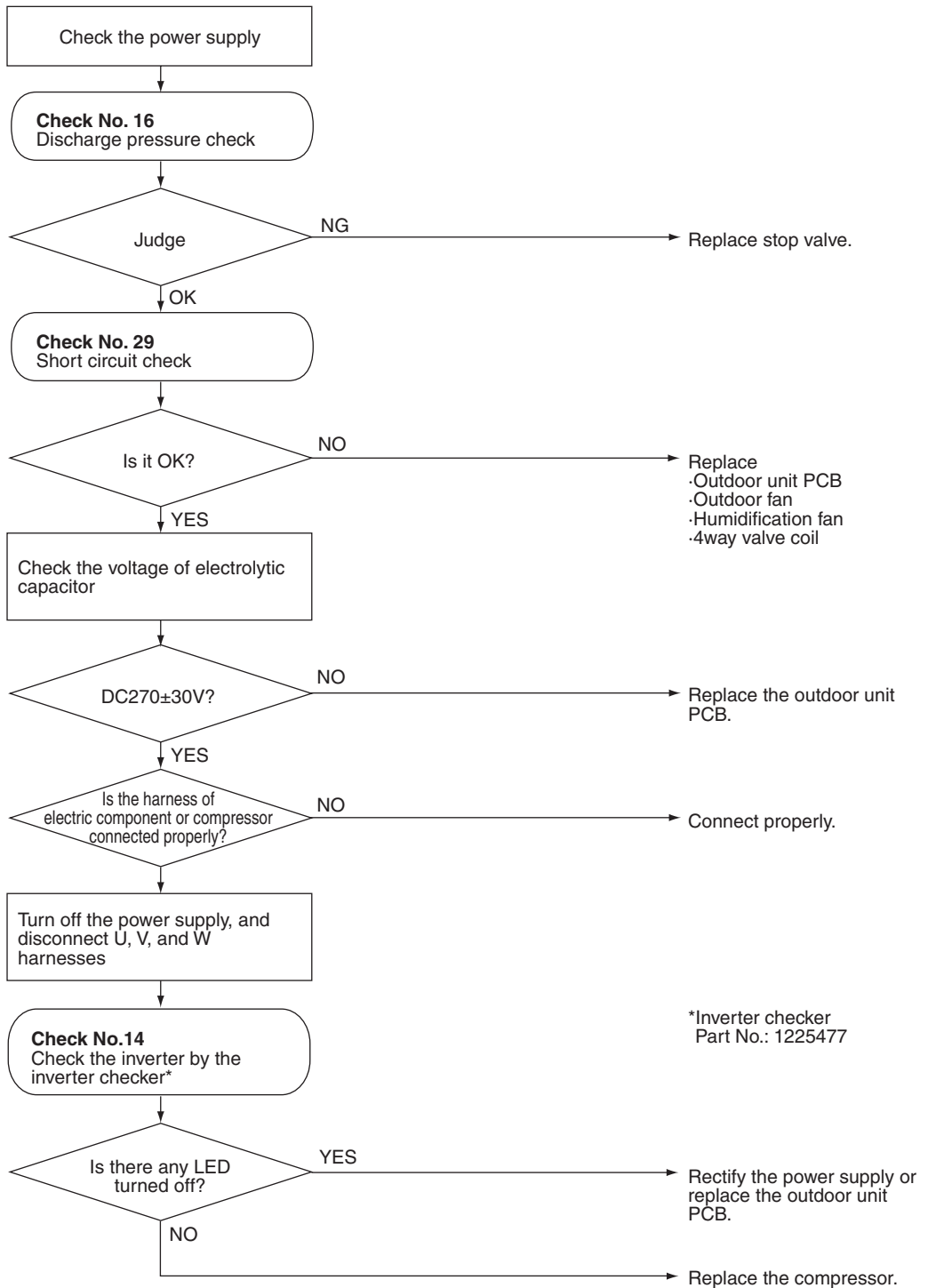

*Inverter checker
Part No.: 1225477

(R3436)

2.28 DC Voltage / DC Current Sensor Fault

Remote Control
Display

HB

Outdoor Unit LED
Display

A Φ 5 Φ (-)

Method of
Malfunction
Detection

DC voltage or DC current sensor system fault is identified based on the compressor operation frequency and the input current detected by the product of DC current and DC voltage.

Malfunction
Decision
Conditions

When the compressor operation frequency is more than 62 Hz and when the input current is less than 0.75 A for 90 sec. continuously (Input current is below 0.5 A)

- The machine shuts down when the fault occurs 4 times.
- Fault counter will be reset to zero if the machine will not stop during accumulated compressor operation time of 60 min. after restored from fault conditions.

Supposed
Causes

- Defective outdoor unit PCB

Troubleshooting



Caution

Be sure to turn off power switch before connect or disconnect connector, or parts damage may be occurred.

Replace the outdoor unit PCB.

2.29 Thermistor System Fault

<p>Remote Control Display</p>	<p><i>P4, J3, J6, H9</i></p>
<p>Outdoor Unit LED Display</p>	<p>A₅ 5 -</p>
<p>Method of Malfunction Detection</p>	<p>This fault is identified based on the thermistor input voltage to the microcomputer. A thermistor fault is identified based on the temperature detected by each thermistor.</p>
<p>Malfunction Decision Conditions</p>	<p>When power is supplied and the thermistor input is 4.98 V or more or when the thermistor input is 0.02 V or less for 5 sec. continuously</p> <p>For J3, “Discharge pipe thermistor < heat exchanger thermistor” is take into consideration to identify the fault.</p>
<p>Supposed Causes</p>	<ul style="list-style-type: none"> ■ Improper connection of connector ■ Defective thermistor ■ Defective indoor unit PCB ■ For J3, defective heat exchanger thermistor (Cooling: outdoor heat exchanger thermistor, heating: indoor heat exchanger thermistor)

Troubleshooting

Check No.2
 Refer to P.202

Caution Be sure to turn off power switch before connect or disconnect connector, or parts damage may be occurred.

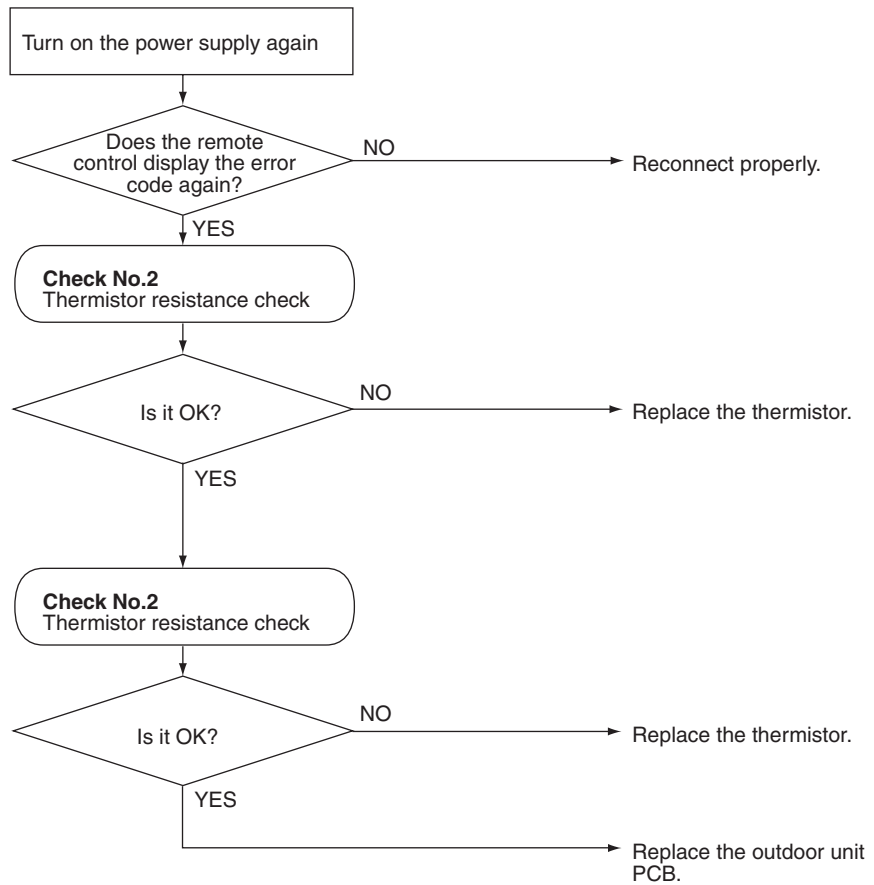

P4 : Radiation fin thermistor
 J3 : Discharge pipe thermistor
 J6 : Outdoor heat exchanger thermistor
 H9 : Outdoor air thermistor

(R3441)

2.30 Abnormal Temperature in Electrical Box

Remote Control
Display

L3

Outdoor Unit LED
Display

A Φ 5 -

Method of
Malfunction
Detection

Temperature rise in the electrical box is identified based on the temperature of the radiation fin detected by the fin thermistor with the compressor off.

Malfunction
Decision
Conditions

When the temperature of the radiation fin is 122°C or more during the compressor off. (When the temperature drops below 113°C, fault condition is cleared.)

Supposed
Causes

- Fin temperature rise due to defective outdoor fan
- Fin temperature rise due to short circuit
- Detection error due to defective fin thermistor
- Detection error due to improper connection of connector
- Detection error due to defective outdoor unit PCB

Troubleshooting



Check No.2
Refer to P.202



Check No.3
Refer to P.203



Check No.5
Refer to P.203



Caution

Be sure to turn off power switch before connect or disconnect connector, or parts damage may be occurred.

(Note on resetting power supply)
To reset the machine, power off status need to continue at least 30 sec.

Turn off the power and turn it on again.



WARNING

To cool down the electric components, the outdoor unit fan gets started when the radiation fin temperature rises above 120 °C and stops when the temperature falls below 113 °C.

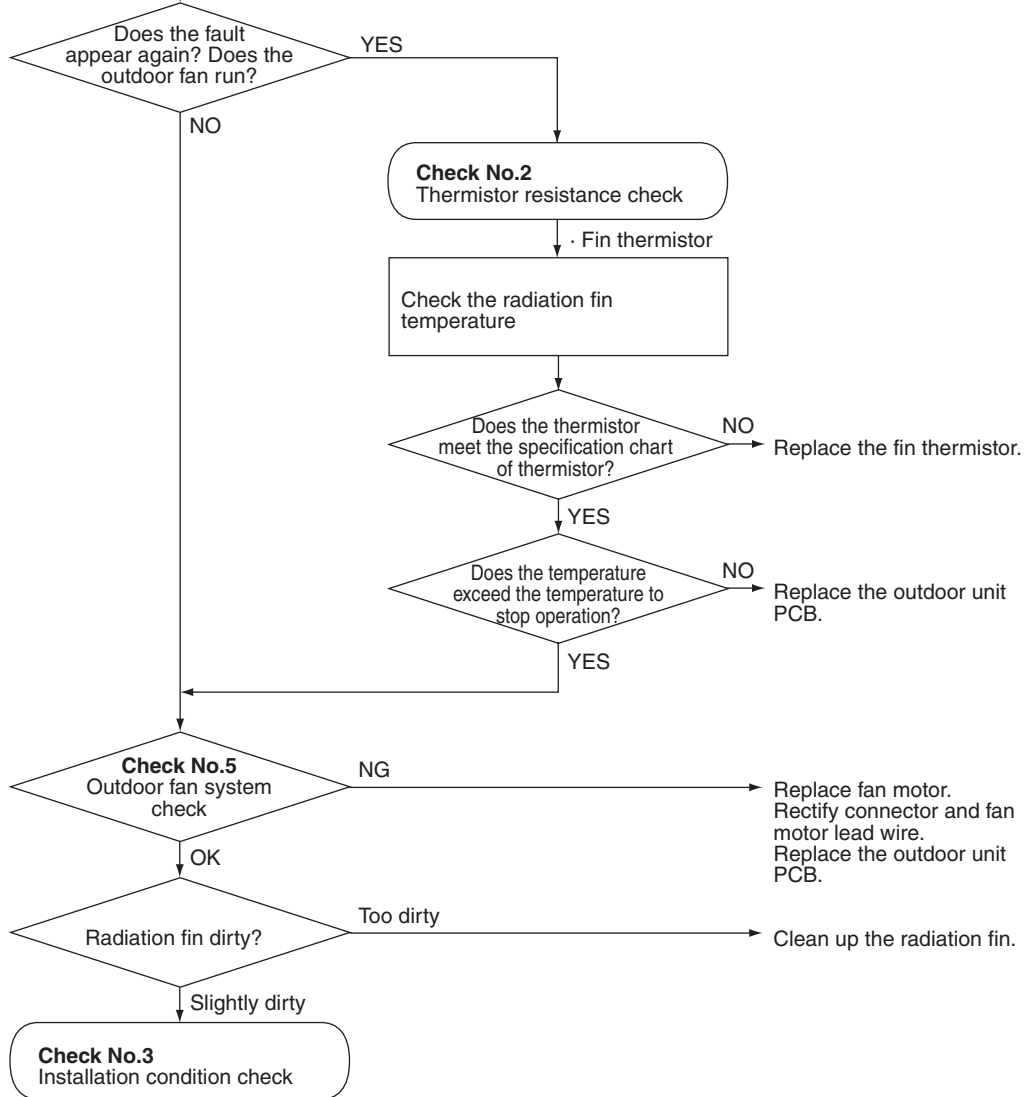

(R6014)

2.31 Temperature Rise in Radiation Fin

Remote Control Display

L4

Outdoor Unit LED Display

A Φ 5 Φ

Method of Malfunction Detection

Temperature rise in the radiation fin is identified based on the temperature of the radiation fin detected by the fin thermistor with the compressor on.

Malfunction Decision Conditions

- The compressor stops when the radiation fin temperature is 86 °C or more. (Fault condition is cleared when the radiation fin temperature is below 67 °C.)
- Shut down when the error repeats 255 times
- Clear condition : Continuous operation for 60 minutes

Supposed Causes

- Fin temperature rise due to defective outdoor fan
- Fin temperature rise due to short circuit
- Detection error due to defective fin thermistor
- Detection error due to improper connection of connector
- Detection error due to defective outdoor unit PCB

Troubleshooting



Check No.2
Refer to P.202



Check No.3
Refer to P.203



Check No.5
Refer to P.203



Caution

Be sure to turn off power switch before connect or disconnect connector, or parts damage may be occurred.

Turn off the power supply and turn it on again to get the system started.



WARNING

To cool down the electric components, the outdoor unit fan gets started when the radiation fin temperature rises above 120 °C and stops when the temperature falls below 113 °C.

Does the fault appear again?

YES

NO

Check No.2
Thermistor resistance check

Fin thermistor

Check the radiation fin temperature

Does the thermistor meet the specification chart of thermistor?

NO

Replace the fin thermistor.

YES

Does the temperature exceed the temperature to stop operation?

NO

Check the power transistor and fin for looseness. If they are found to be fit tightly, replace the PCB or the power transistor.

YES

Check No.5
Outdoor fan system check

NG

Replace fan motor. Rectify connector and fan motor lead wire. Replace the outdoor unit PCB.

OK

Radiation fin dirty?

Too dirty

Clean up the radiation fin.

Slightly dirty

Check No.3
Installation condition check

(R6015)

2.32 Output Overcurrent

Remote Control
Display

L5

Outdoor Unit LED
Display

A ϕ 5 ϕ

Method of
Malfunction
Detection

An output overcurrent is detected by checking the current that flows in the inverter DC section.

Malfunction
Decision
Conditions

- A position signal error occurs while the compressor is running.
- A speed error occurs while the compressor is running.
- The machine shuts down when the signal of output overcurrent is sent 8 times from the output overcurrent detection circuit to the microcomputer.
- Clear condition: The machine continuously runs for about 11 min. (without fault)

Supposed
Causes

- Overcurrent due to defective power transistor
- Overcurrent due to wrong internal wiring
- Overcurrent due to abnormal supply voltage
- Overcurrent due to defective PCB
- Detection error due to defective PCB
- Overcurrent due to closed stop valve
- Overcurrent due to defective compressor
- Overcurrent due to poor installation condition
- Defective indoor solenoid valve

Troubleshooting

Check No.3
 Refer to P.203



Check No.14
 Refer to P.206

Check No.15
 Refer to P.207

Check No.16
 Refer to P.208

 **Caution** Be sure to turn off power switch before connect or disconnect connector, or parts damage may be occurred.

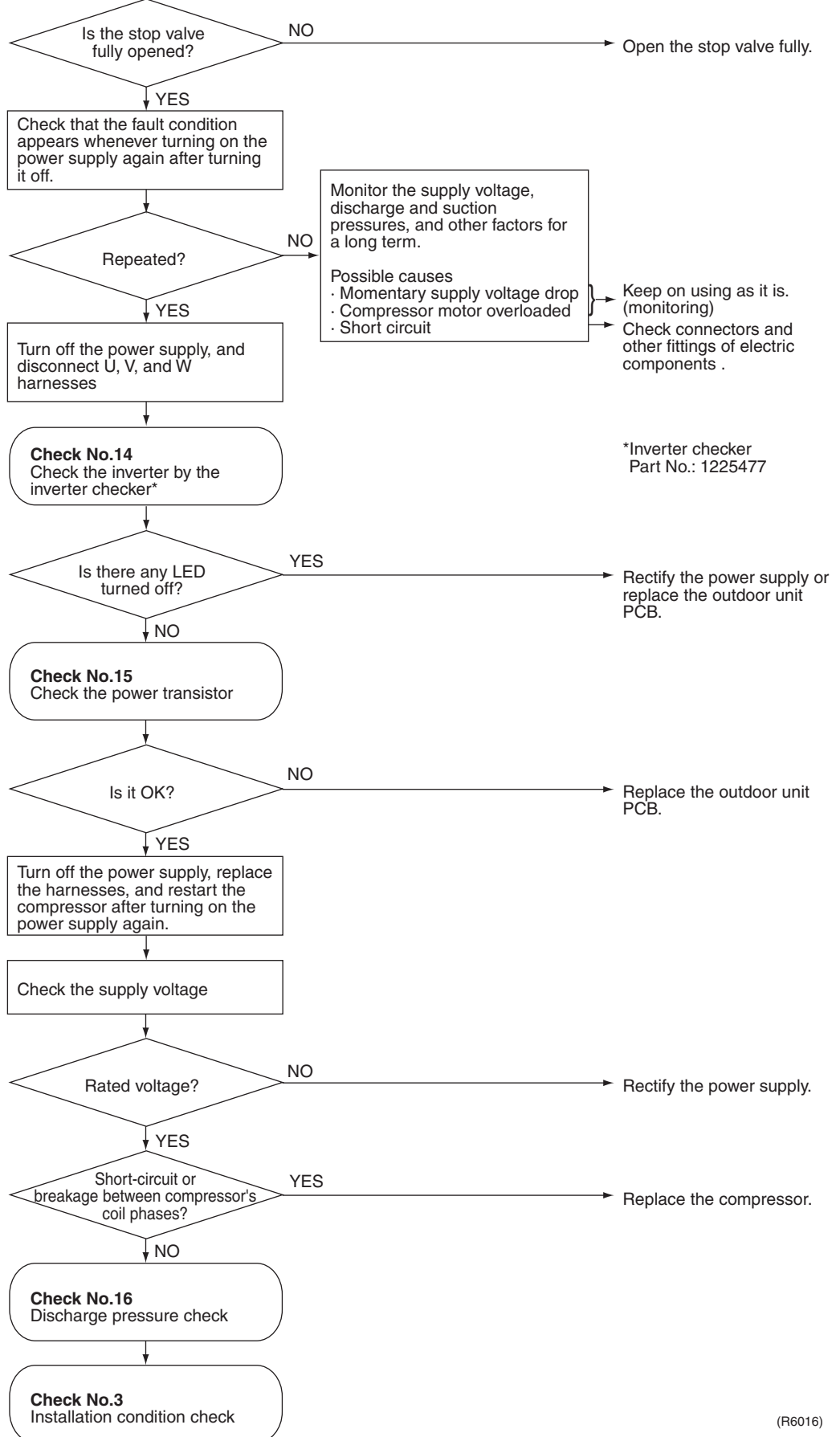
*Output overcurrent may caused by improper wiring inside the machine. If the machine stops due to output overcurrent after connecting or disconnecting wires to replace part, check wiring for proper connection.



(R6016)

2.33 Insufficient Gas

Remote Control Display **U0**

Outdoor Unit LED Display **A0 50 (-)**

Method of Malfunction Detection
Gas shortage detection I:
 Gas shortage is detected by checking the input current value and the compressor running frequency. If the gas is short, the input current is smaller than the normal value.

Gas shortage detection III:
 Gas shortage is detected by checking the difference between ambient temperature and heat exchanger temperature. If the gas is short, the difference is smaller than the normal value.

Malfunction Decision Conditions
Gas shortage detection I:
 The following conditions continue for 7 minutes.
 ♦ Input current × input voltage ≤ 2800 / 256 × output frequency – 350 (W)
 ♦ Output frequency > 54 (Hz)

Gas shortage detection III:
 When the difference of the temperature is smaller than Δ , it is regarded as insufficient gas.

		Δ
Cooling	room temperature – indoor heat exchanger temperature	4.0°C
	outdoor heat exchanger temperature – outdoor temperature	4.0°C
Heating	indoor heat exchanger temperature – room temperature	4.0°C
	outdoor temperature – outdoor heat exchanger temperature	4.0°C

If a gas shortage error takes place 4 times straight, the system will be shut down. The error counter will reset itself if this or any other error does not occur during the following 60-minute compressor running time (total time).

- Supposed Causes**
- Refrigerant shortage (refrigerant leakage)
 - Refrigerant heat exchanger drift
 - Poor compression performance of compressor
 - Closed stop valve
 - Defective electronic expansion valve
 - Defective solenoid valve for dehumidifying

Troubleshooting



Check No.2
Refer to P.202



Check No.17
Refer to P.209

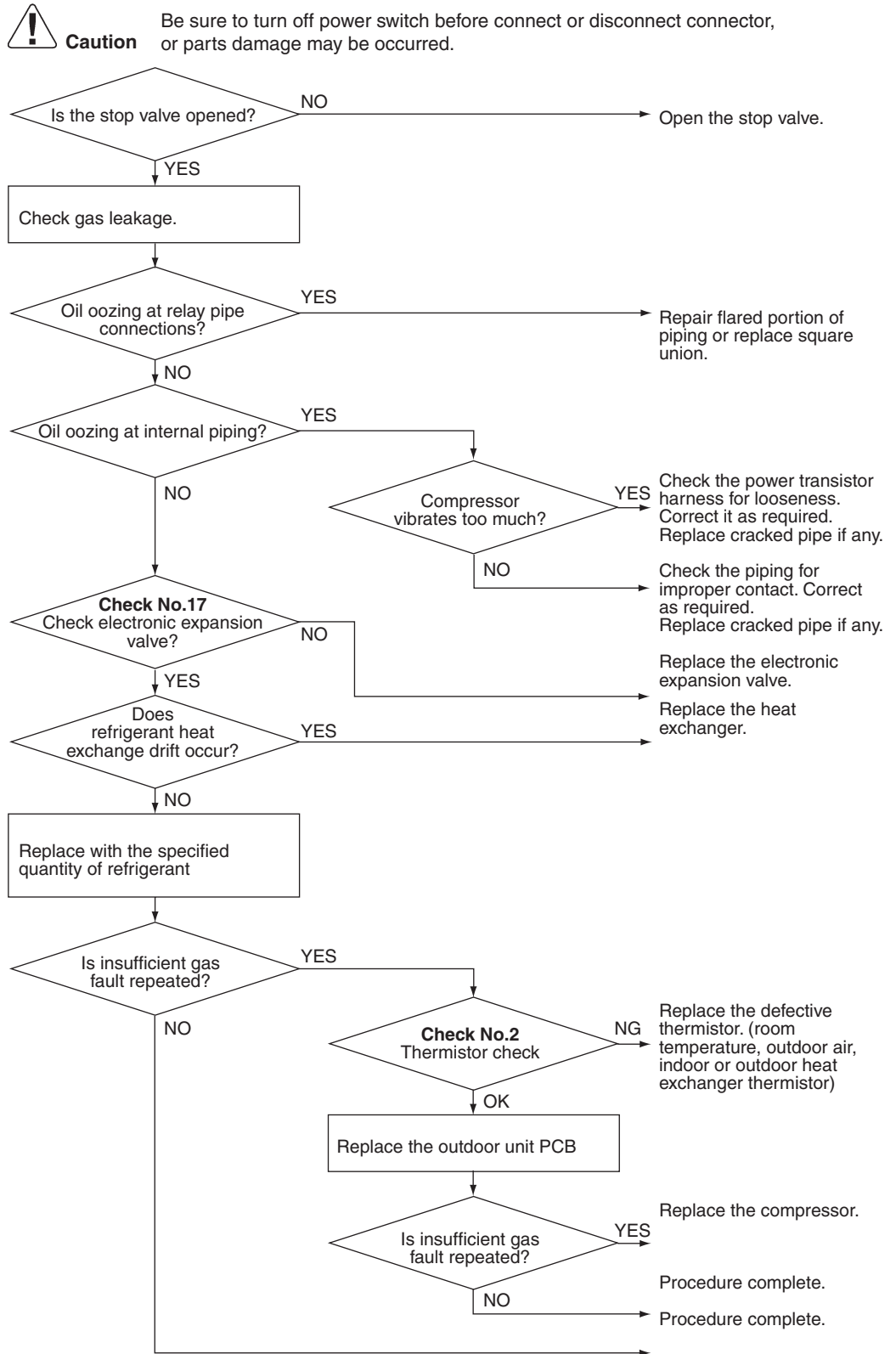

(R3446)

2.34 Over Voltage Protection / Low Voltage Protection

Remote Control Display

U2

Outdoor Unit LED Display

A 5 (-)

Method of Malfunction Detection

Detect an abnormal increase or drop of voltage by the detection circuit or DC voltage detection circuit.

Malfunction Decision Conditions

- When an overcurrent signal is sent to the microcomputer from the overcurrent detection circuit, or the voltage detected by DC voltage detection circuit is less than 150 V and that voltage continues for about 0.1 sec.
- The machine shuts down if the fault conditions occurs 255 times
- Fault counter is reset when the machine continuously runs for 60 min. without fault.

Supposed Causes

- Abnormal supply voltage, momentary power failure
- Defective overcurrent detector or defective DC voltage detection circuit
- Failure in PAM controlled parts

Troubleshooting

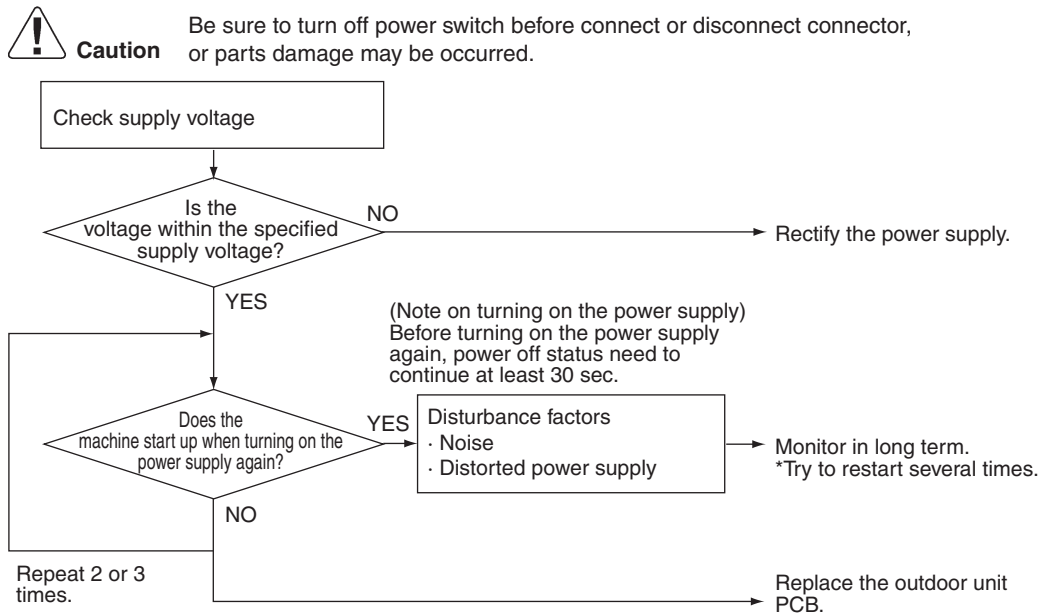

(R3449)

2.35 Outdoor Unit PCB Fault or Communication Circuit Fault

Remote Control Display *U4*

Outdoor Unit LED Display A₀ 5 -

Method of Malfunction Detection

1. Detect within the programme of the microcomputer that the programme is in good running order.
2. When indoor-outdoor unit signal transmission can not be performed for more than 15 sec.
3. Detection of the presence or absence of zero-cross signal.

Malfunction Decision Conditions

1. When the programme of the microcomputer is in bad running order.
2. When indoor-outdoor unit signal transmission can not be performed for more than 15 sec.
3. When zero-cross signal can not be detected for more than 10 sec.

Supposed Causes

- Display disabled due to power supply fault
- Communication circuit fault in outdoor unit PCB
- Out of control of microcomputer caused by external factors
 - Noise
 - Momentary voltage drop
 - Momentary power loss
- Defective outdoor unit PCB
- Defective thermal fuse in outdoor terminal board

Troubleshooting



Caution Be sure to turn off power switch before connect or disconnect connector, or parts damage may be occurred.

Check indoor unit also, because a communication circuit fault may be caused by the problem related to the indoor unit.

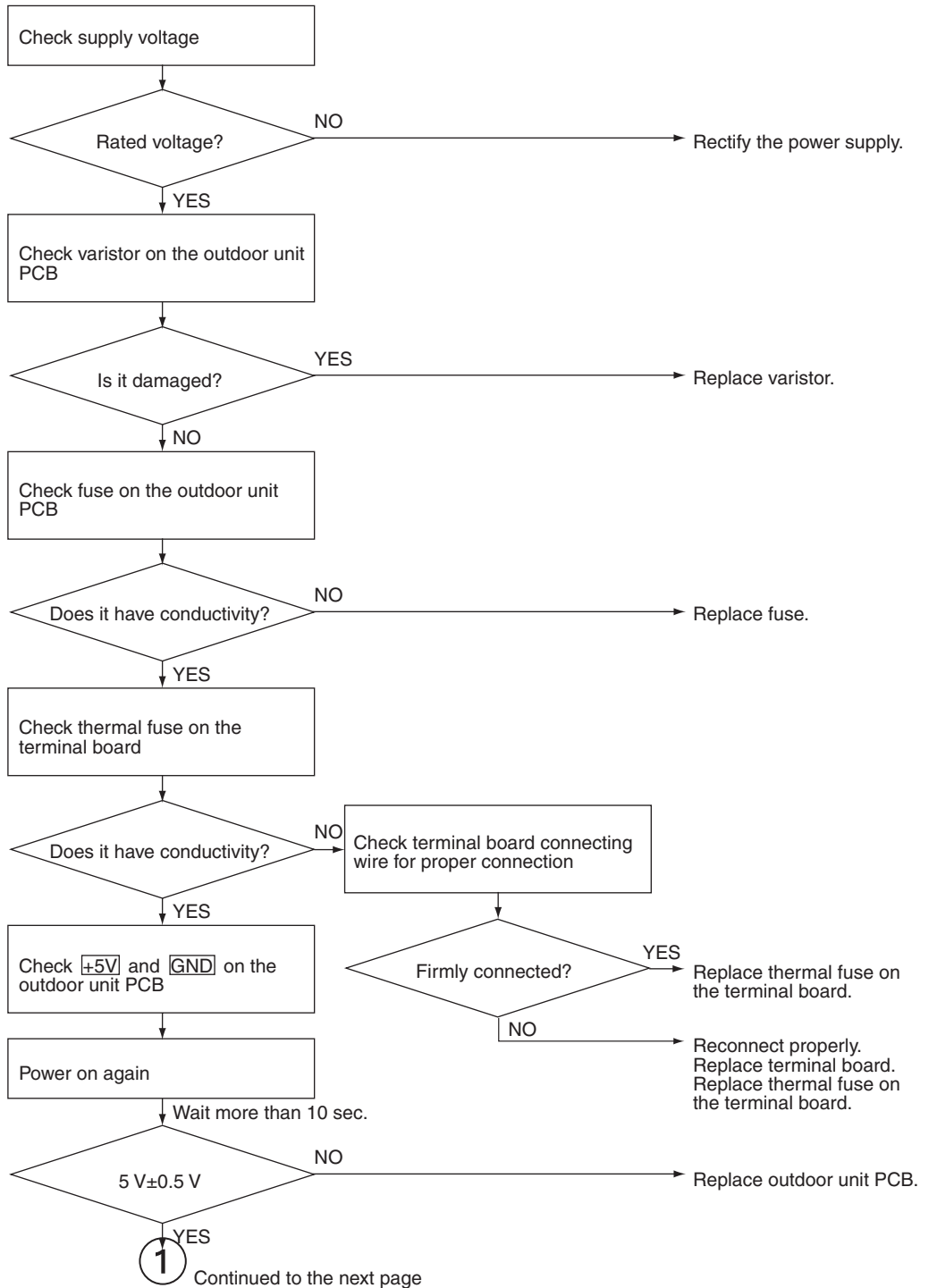

(R6017)

Check No.8
 Refer to P.204

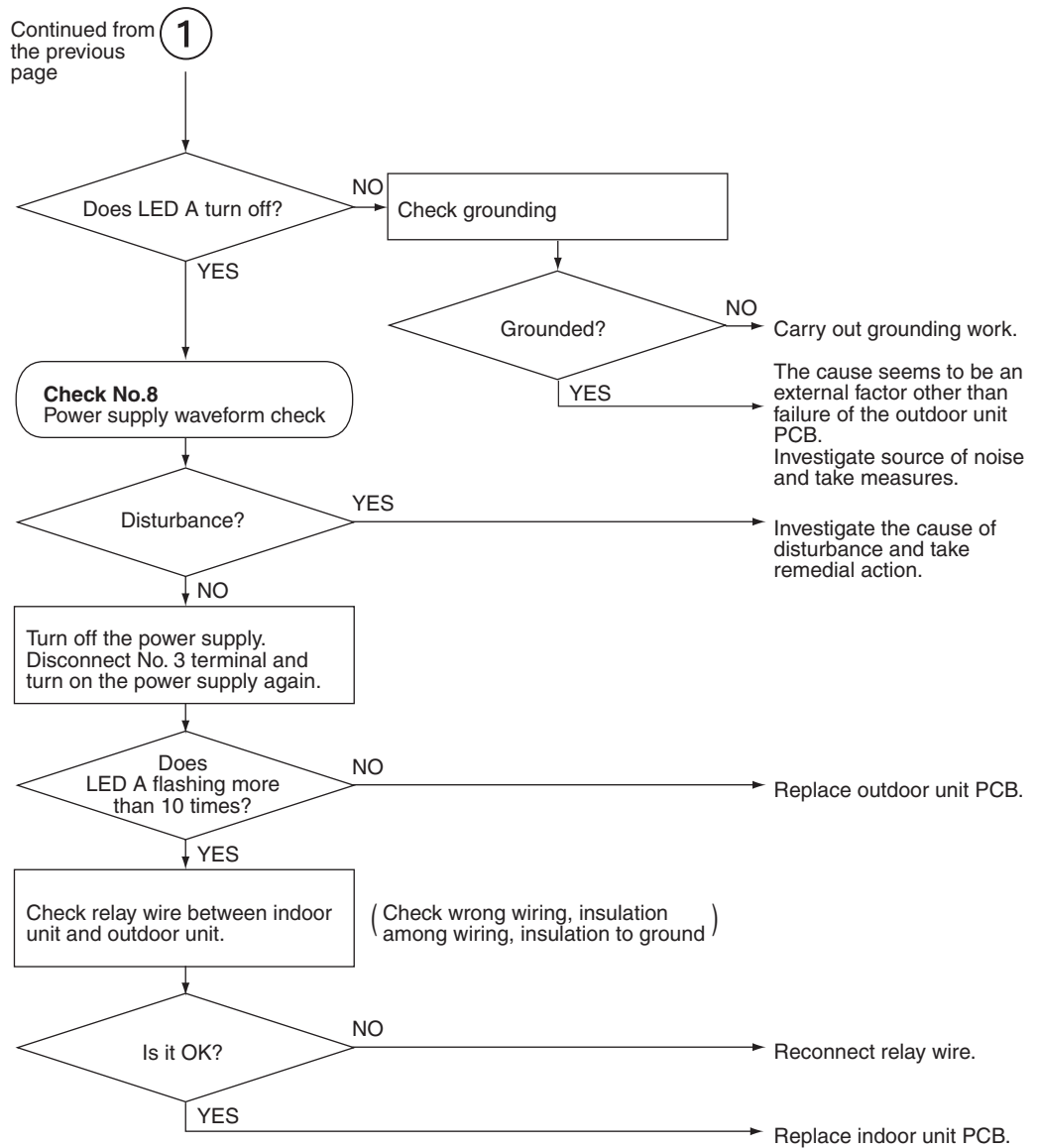

(R3452)

2.36 Signal Transmission Error on Outdoor Unit PCB

Remote Control Display *U7*

Outdoor Unit LED Display A ϕ 5 ϕ (-)

Method of Malfunction Detection Communication error between microcomputer mounted on the main body and inverter.

Malfunction Decision Conditions

- When the data sent from the microcomputer of the inverter can not be received 15 times successively or for 15 sec, the machine shuts down.
- Fault counter is reset when the data from the microcomputer of the inverter can be successfully received.

Supposed Causes

- Defective outdoor unit PCB
- Disconnection or breakage of harness between PCBs

Troubleshooting

**Caution**

Be sure to turn off power switch before connect or disconnect connector, or parts damage may be occurred.

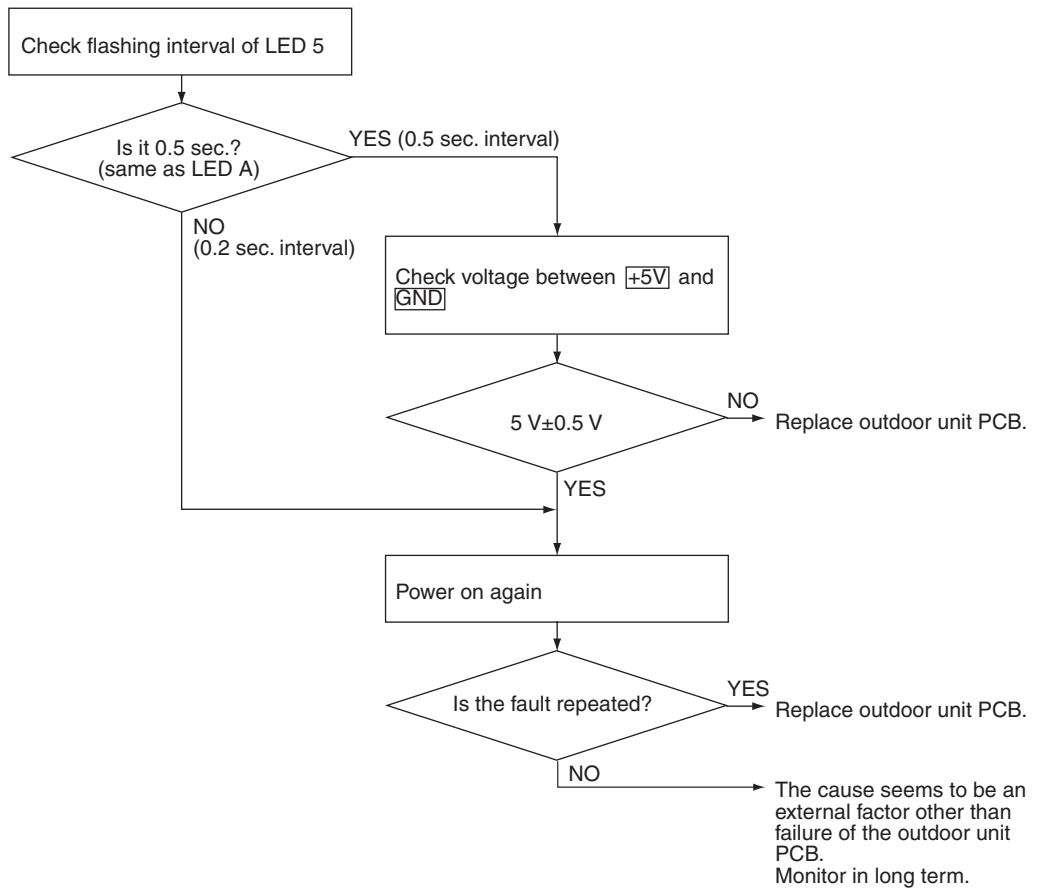

(R6018)

2.37 Fan Motor System Fault / Fan Lock

Remote Control Display

P9

Outdoor Unit LED Display

A Φ 5 Φ

Method of Malfunction Detection

During humidification fan motor running, fan motor system fault is identified based on the fan speed (rpm) detected by Hall IC.

Malfunction Decision Conditions

<Humidification fan>
When fan speed does not reach 100 rpm within 7 sec. after fan motor start up.

Supposed Causes

- <Humidification fan>
- Defective motor for humidification fan
 - Breakage of relay harness or loose connector
 - Detection fault of fan speed due to defective outdoor unit PCB

Troubleshooting



Check No.23
Refer to P.211

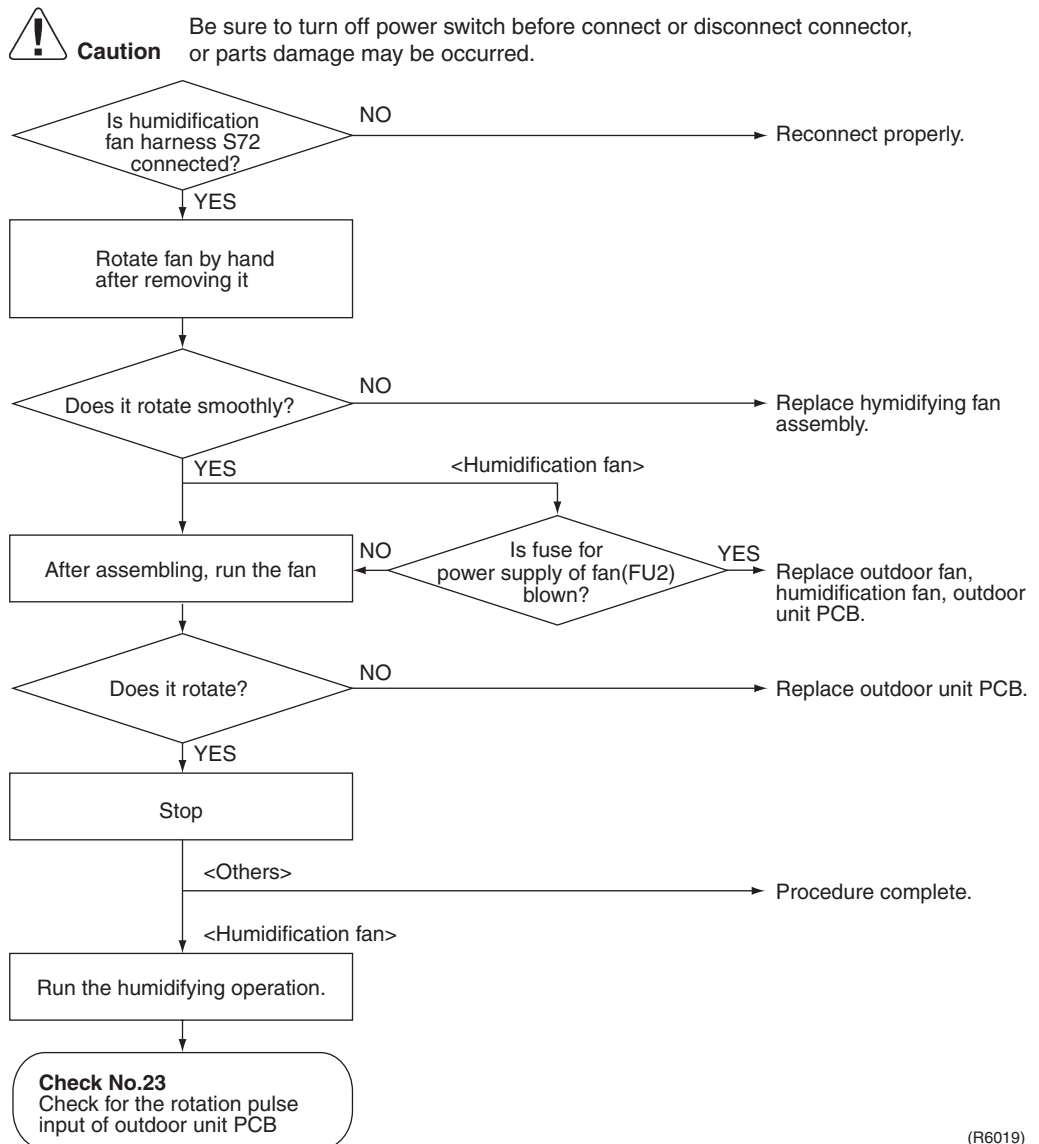

(R6019)

2.38 Heater Wire Fault

Remote Control
Display

PR

Outdoor Unit LED
Display

A ϕ 5 ϕ

**Method of
Malfunction
Detection**

A fault is identified when the outlet temperature of humidification fan does not reach a certain temperature within a given time after the heater turned on.

**Malfunction
Decision
Conditions**

When the temperature detected by the thermistor is lower than the outdoor temperature (at heater turned off) + 6°C, and this condition continues for 30 min.

**Supposed
Causes**

- Breakage of heater filament
- Breakage of heater harness
- Abnormal temperature detected by outdoor temperature thermistor
- Abnormal temperature detected by humidification fan outlet thermistor
- Damaged main relay
- Blown thermal fuse
- Damaged heater control part
- Extremely low voltage

Troubleshooting



Check No.2
Refer to P.202



Caution Be sure to turn off power switch before connect or disconnect connector, or parts damage may be occurred.

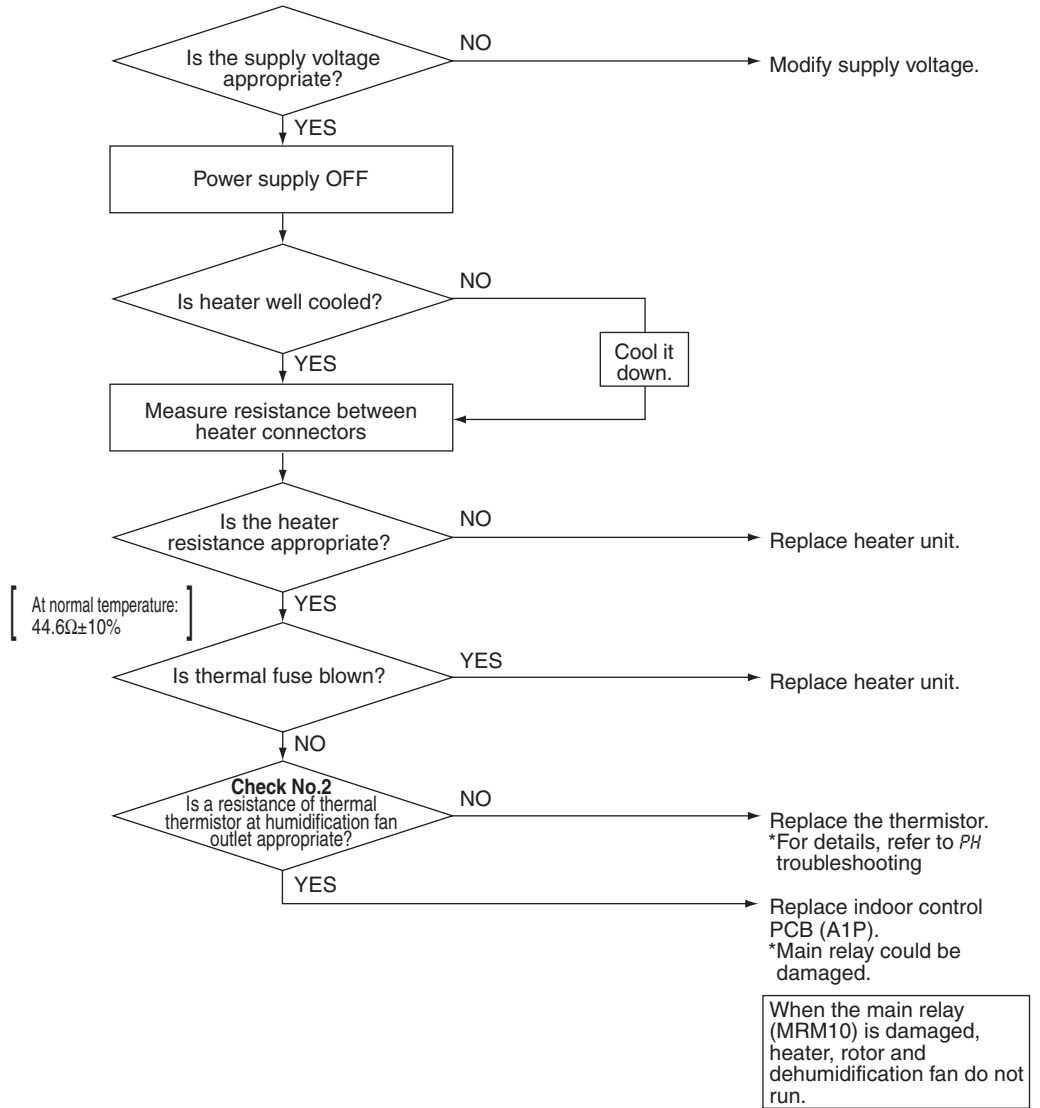

(R6020)

2.39 Humidification Fan Outlet Thermistor Fault / Abnormal Heater Temperature

Remote Control Display *PH*

Outdoor Unit LED Display A ϕ 5 ϕ

Method of Malfunction Detection Detect short circuit and wire breakage of humidification thermistor. When humidification fan outlet temperature becomes high, this condition is identified as an abnormal heater temperature fault.

Malfunction Decision Conditions When power is supplied and the thermistor input is 4.90 V or more, or 0.06 V or less. If the humidification fan outlet temperature is more than 90°C, this condition is identified as abnormal heater temperature fault.

Supposed Causes

- Short circuit and wire breakage of humidification thermistor
- Disconnected connector
- Heater has a high power
- Thermistor temperature detection error
- Defective rotor motor
- Defective dehumidification fan motor
- Defective heater control part
- Defective humidification fan

Troubleshooting



Caution Be sure to turn off power switch before connect or disconnect connector, or parts damage may be occurred.

Check No.2
Refer to P.202



Check No.5
Refer to P.203

[At normal temperature:
44.6Ω±10%]

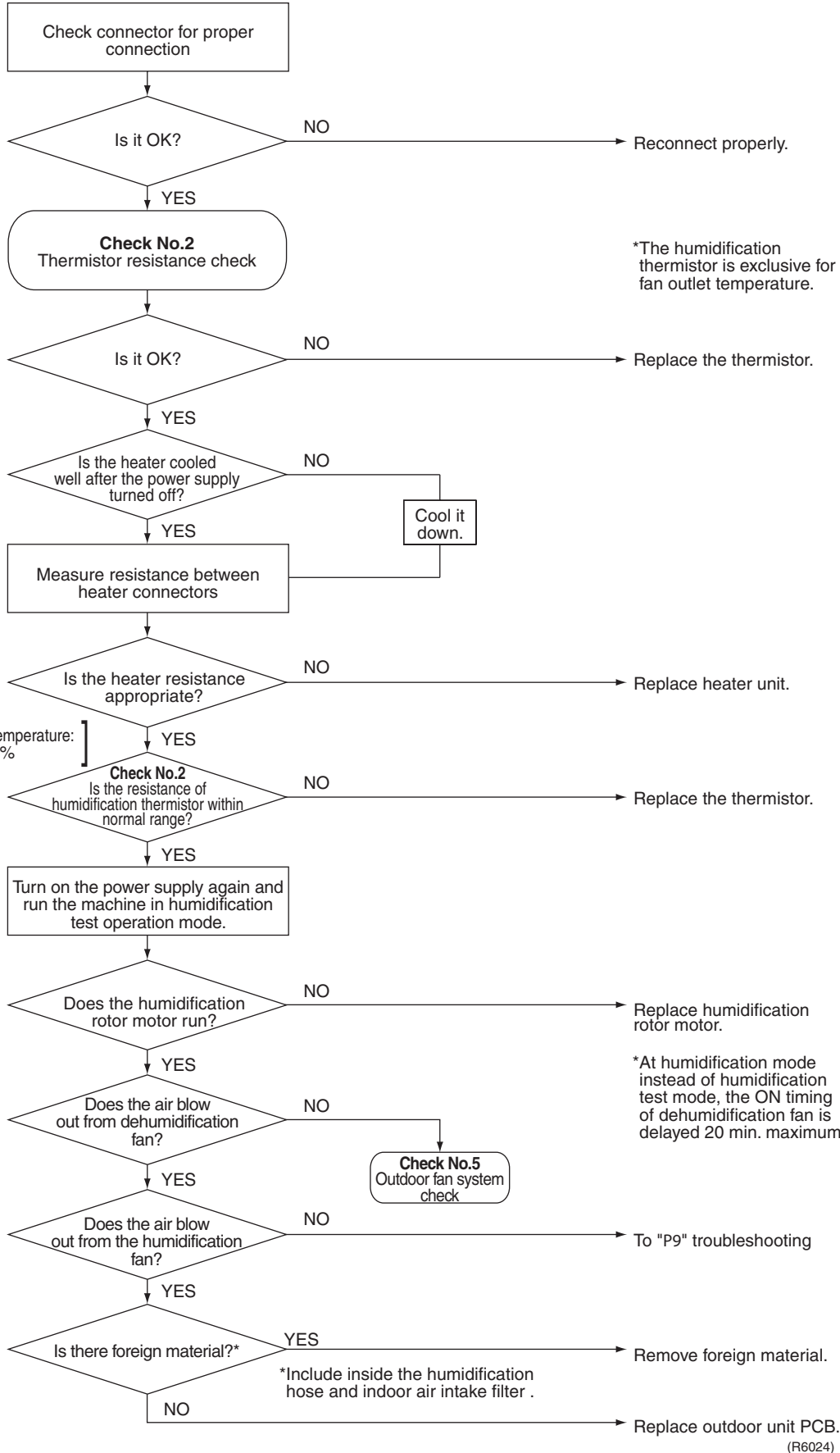

*The humidification thermistor is exclusive for fan outlet temperature.

*At humidification mode instead of humidification test mode, the ON timing of dehumidification fan is delayed 20 min. maximum.

*Include inside the humidification hose and indoor air intake filter .

2.40 Lights-out of Microcomputer Status Lamp

Remote Control Display —

Outdoor Unit LED Display A ● 5 ● (-)

Method of Malfunction Detection When a microcomputer fault is detected, LED A or LED 5 turns off.

Malfunction Decision Conditions

- Outdoor unit PCB is not power supplied
- Power supply failure due to noise

Troubleshooting



Caution

Be sure to turn off power switch before connect or disconnect connector, or parts damage may be occurred.

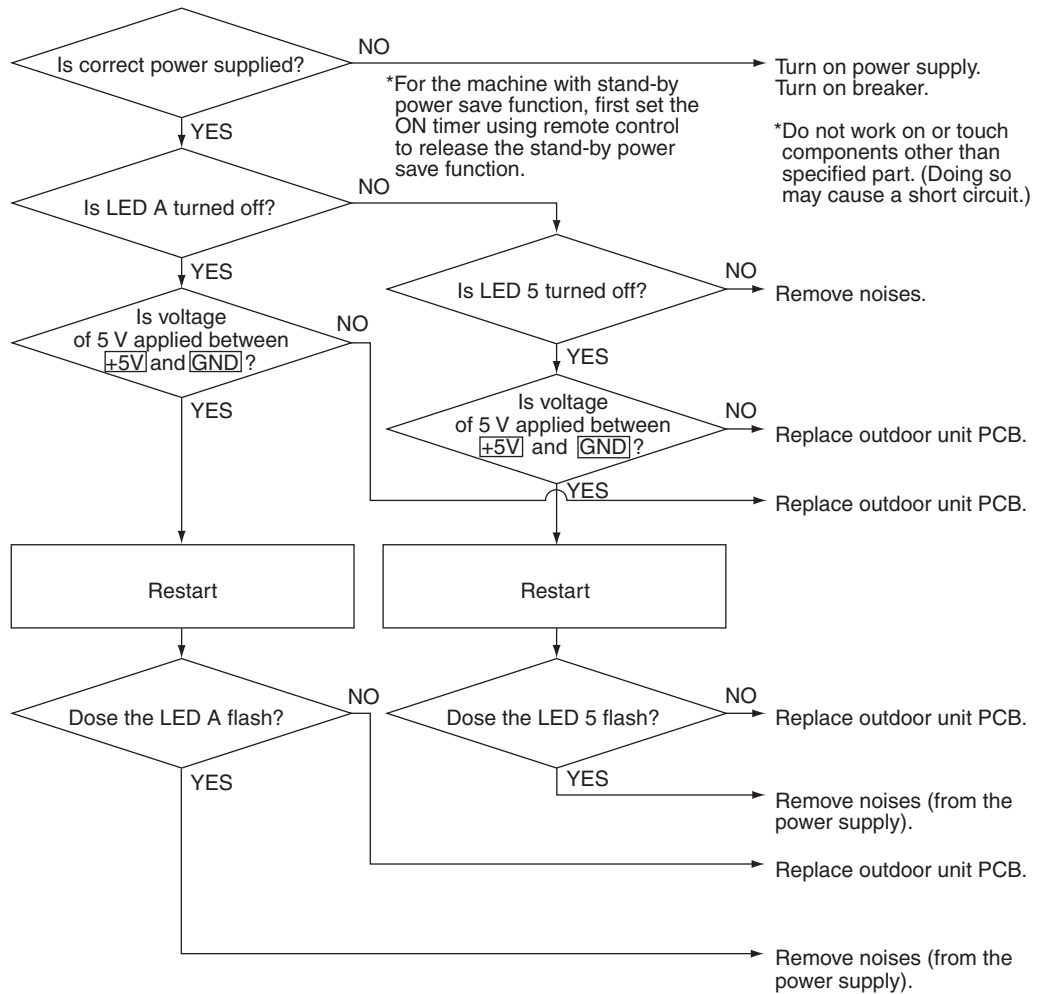

(R6021)

3. Check

3.1 Thermistor Resistance Check

Check No.2

Remove the connectors of the thermistors on the PCB, and measure the resistance of each thermistor using tester.
The relationship between normal temperature and resistance is shown in the graph and the table below.

Temperature (°C)	Thermistor R25°C=20kΩ B=3950
-20	211.0 (kΩ)
-15	150
-10	116.5
-5	88
0	67.2
5	51.9
10	40
15	31.8
20	25
25	20
30	16
35	13
40	10.6
45	8.7
50	7.2

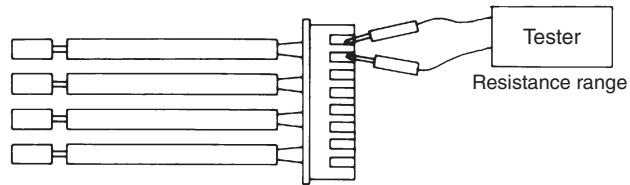

(R25=20kΩ 、 B=3950)

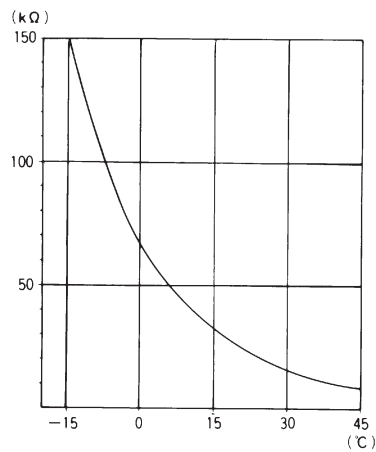

(R1437)

- For the models in which the thermistor is directly mounted on the PCB.

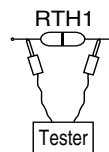

(R3460)

3.2 Installation Condition Check

Check No.3

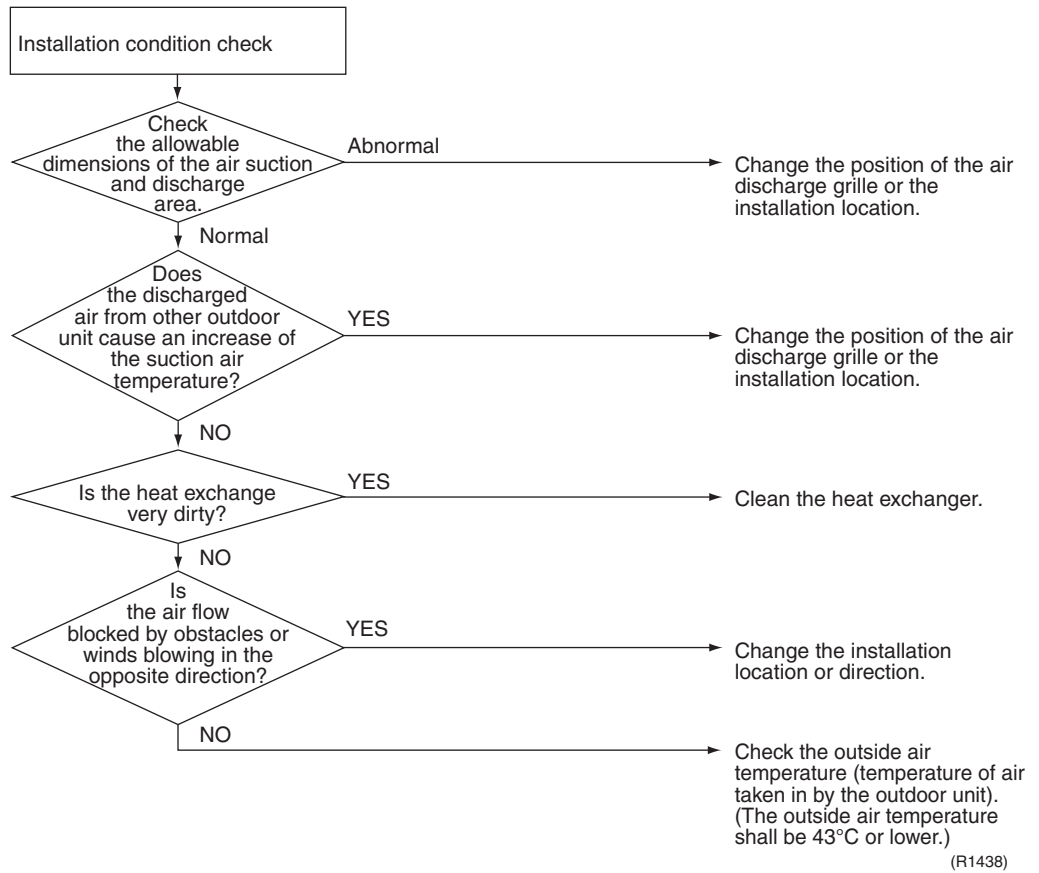

3.3 Outdoor Fan System Check (DC Motor)

Check No.5

Check No.23
 Refer to P.211

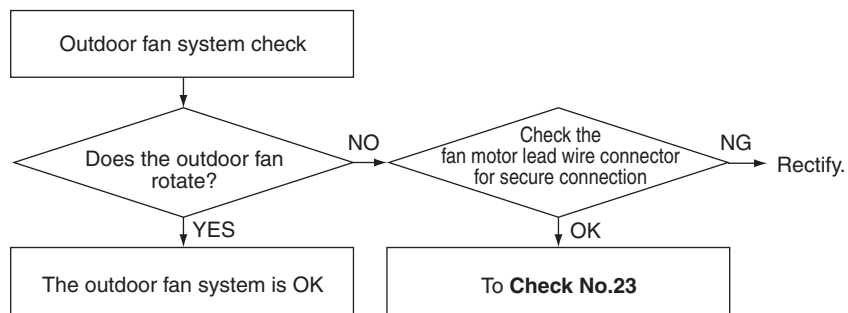

(R3756)

3.4 Power Supply Waveform Check

Check No.8

Check the voltage waveform between power supply terminals on the terminal board for disturbance using oscillo-tester.

- Check to see if the power supply waveform is a sine wave (Fig.1).
- Check to see if there is waveform disturbance near the zero cross (sections circled in Fig.2)

[Fig.1]

[Fig.2]

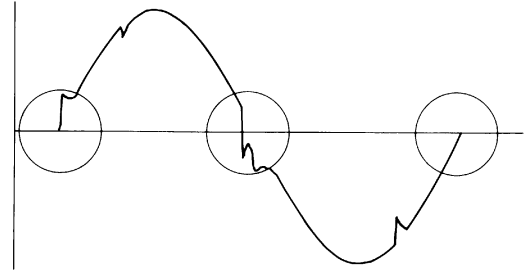
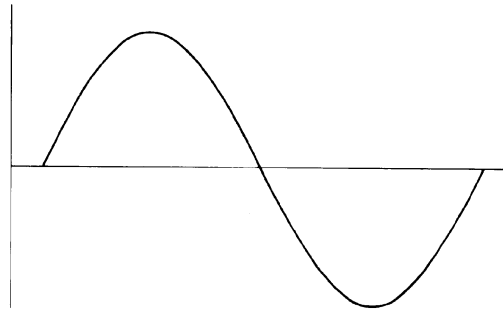

(R1736)

(R1444)

3.5 Capacitor Voltage Check

Check No.10

Before this checking, be sure to check the main circuit for short-circuit (Check No 29).

- Checking the capacitor voltage
- With the circuit breaker still on, measure the voltage according to the drawing of the model in question. Be careful never to touch any live parts.

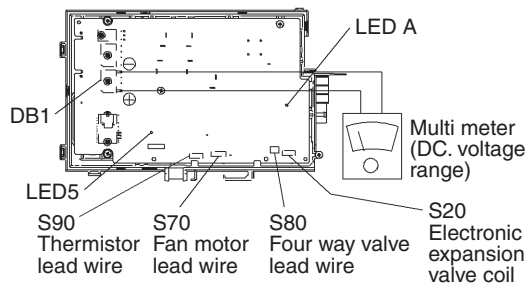

(R6027)

3.6 Main Circuit Electrolytic Capacitor Check

Check No.11

- Do not touch the live parts within 10 min. after the breaker is turned off.
- Even after that, when you touch the parts, check that there is no DC voltage with a tester.
- Check the conductivity with a tester. It is OK if the tester shows good conductivity when pins are replaced.

Set the tester to the resistance measuring range

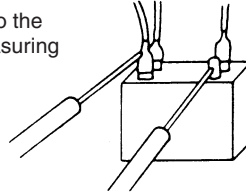

If the pointer swings and returns, the electrolytic capacitor is OK.

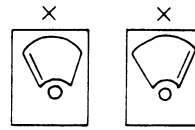

If the pointer does not swing, or does not return, the electrolytic capacitor is out of order.

(R3466)

3.7 Refrigerant System Check

Check No.12

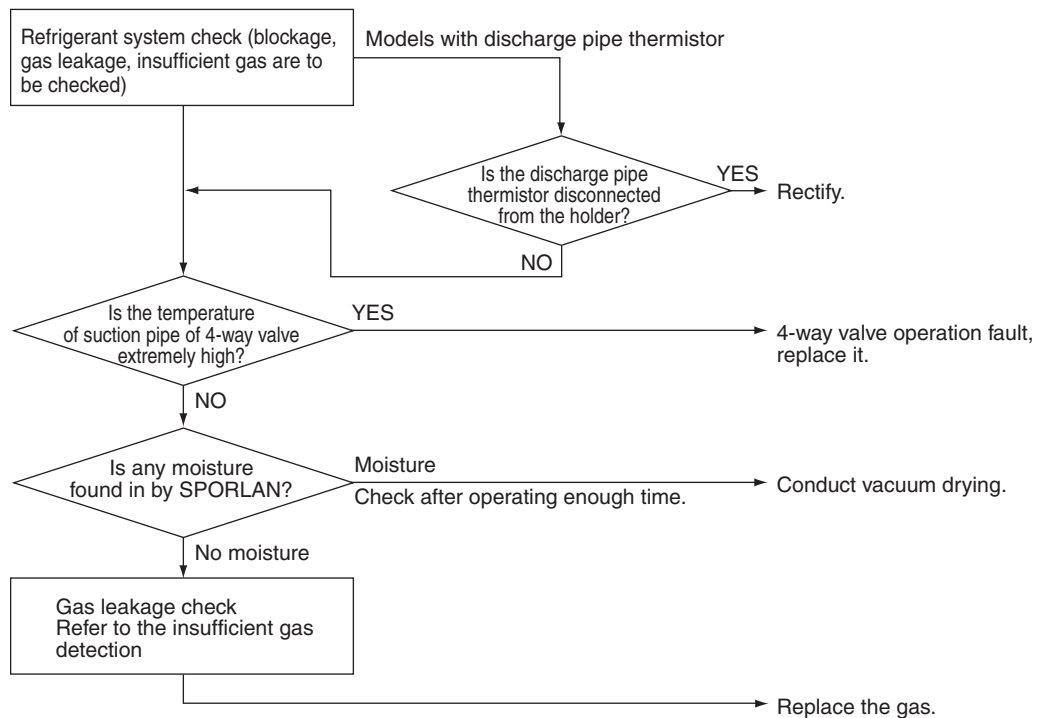

(R6022)

3.8 “Inverter Checker” Check

Check No.14

1. Characteristics

If abnormal stop occurs due to compressor startup failure or overcurrent output when using inverter unit, it is difficult to judge it results from the compressor failure or other failure (control PC board, power transistor, etc.). The inverter analyzer makes it possible to judge the cause of trouble easily and securely. (Connect this analyzer as a quasi compressor instead of compressor and check the output of inverter)

2. Operation Method

- 1) Be sure to turn the power off.
- 2) Install the Inverter Analyzer instead of a compressor.

Note: Make sure the charged voltage of the built-in smoothing electrolytic capacitor drops to 10 VDC or below before carrying out the service work.

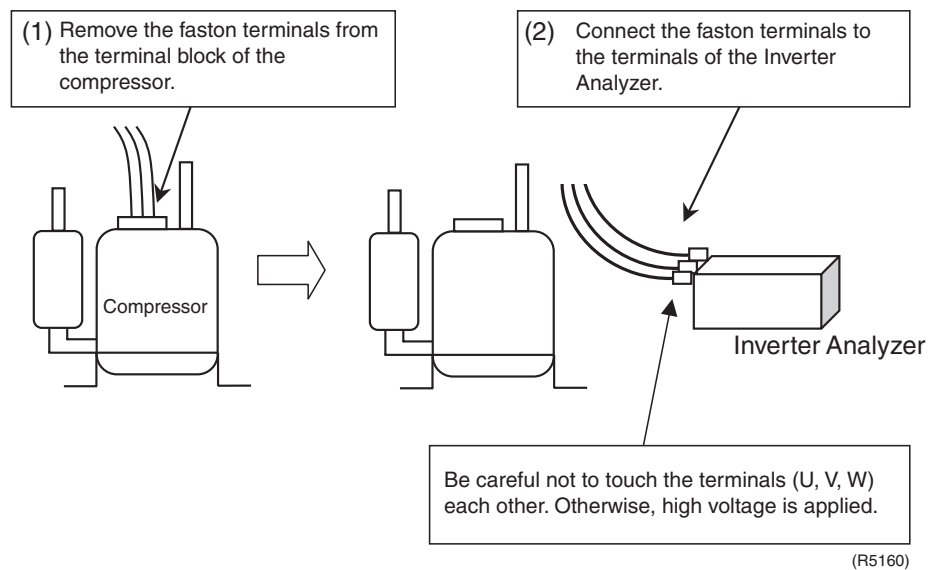

Reference

If the connector terminal of compressor is not a faston terminal (difficult to remove the wire on the terminal), it is possible to connect a wire available on site to the unit from output side of PC board. (Do not connect it to the compressor at the same time, otherwise it may result in incorrect detection.)

- 3) Turn the power on and operate the air conditioner.

3. Diagnose method (Diagnose can be made according to 6 LEDs lighting status as follows:)

(1) When all LEDs are lit uniformly, → Compressor malfunction (to be replaced)

(2) When some of LEDs are not lit (LEDs are not lit or go off, etc.):

Check the individual power transistor. (Refer to check No.15)

* When the power transistor and control PC board are integrated :

→ Replace the control PC board.

* When the power transistor can be checked individually :

↓ Check the resistance value. (Refer to check No.15)

If NG : → The power transistor may have a failure. (Replace the power transistor).

If the power transistor is normal, check if there is any solder cracking on filter PC board.

* If any solder cracking is found: → Replace the filter PC board (or repair the soldered section).

* If filter PC board is normal: → Replace the control PC board.

Caution

- ① When the output frequency is low, the LED flashes slowly. As the frequency increases, the LED flashes quickly. (It looks like the LED is lit)
- ② If the operation is carried out with no load (the condition of the compressor is disconnected), some of units may stop operation with “CT system error” (due to no electric current) or “startup failure” (because the compressor does not turn). In this case, check if the LED is flashing during “operation” to “malfunction stop”. (Refer to the service manual of each air conditioner for checking whether the alarm LEDs for CT system, startup failure, etc. are provided or not.)
- ③ On completion of diagnose by this checker, be sure to re-crimp the faston terminal for resetting the system.
(Otherwise, the terminal may be burned due to loosening.)

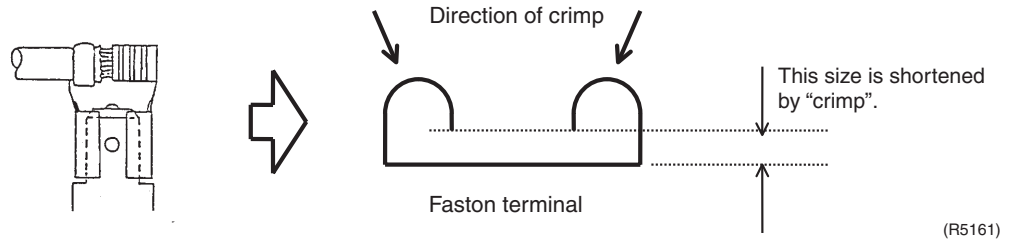

■ **How to activate the inverter test mode**

- 1) Hold the “CLOCK” button for 5 seconds.
(The matrix display will appear on the remote control.)
- 2) Display “SETTING” on the matrix display of the remote control and press the “CLOCK” button.

- 3) “7” will be displayed.
- 4) Press the “CLEAN / FRESH” button for inverter test mode.

3.9 Power Transistor Check

Check No.15

- Do not touch the live parts within 10 min. after the breaker is turned off.
- Even after that, when you touch the parts, check to see that supply voltage of the power transistor is less than 50 V with a tester.
- Measure resistance at connector terminal on PCB or at the relay connector.

(-) terminal of a tester	Power transistor (+)	UVW	Power transistor (-)	UVW
(+) terminal of a tester	UVW	Power transistor (+)	UVW	Power transistor (-)
Resistance in OK	several kΩ~several MΩ			
Resistance in NG	0 or ∞			

3.10 Discharge Pressure Check

Check No.16

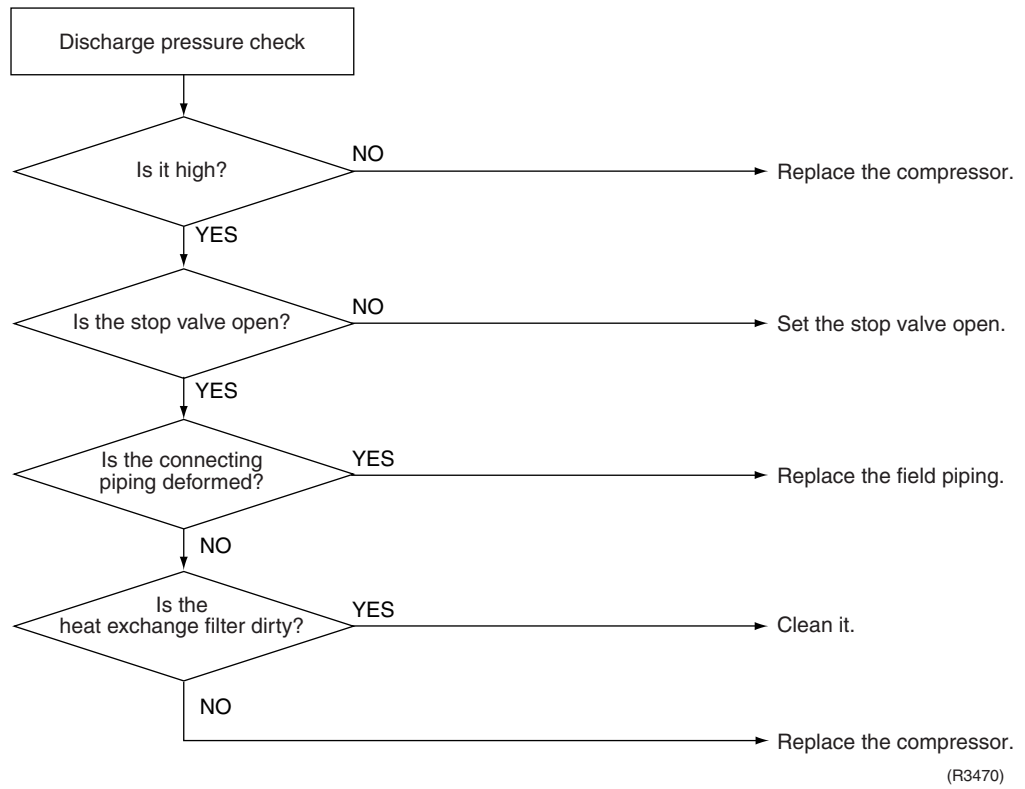

3.11 Electronic Expansion Valve Check

Check No.17

Check the electronic expansion valve (EV) as follows:

1. Check if the EV connector properly inserted into the control PCB. Collate the number of EV main body with that of the connector.
2. Check to see that clatter (latching sound) is heard from all of the EVs when turning on the power supply again after turning it off.
3. If there are EVs which do not sound clatter, disconnect the connectors of these EVs and check them for conductivity.

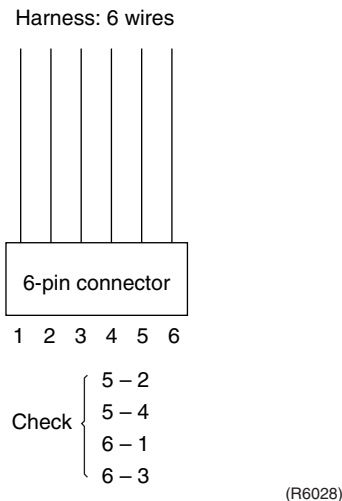

4. If there is no clatter (latching sound) on all of the EVs in step 2, the outdoor PCB is defective.
5. For EVs for which conductivity is established in step 3, connect the coil which sounded clatter to the EV main body which did not sound, and make sure the latching sound be heard again.
If latching sound is heard, outdoor unit PCB is defective.
If there is no latching sound, the EV main body is defective.

i Note Latching sound varies by each valve.

3.12 Indoor Unit PCB Output Check

Check No.18

<Control PCB (A1P)>

1. Check for proper connection.
 2. Check that the supply voltage applied to the motor is output between No.4 pin and No.7 pin).
 3. Check that the motor control voltage is output (between No.3 pin and No.4 pin).
- Check that the rpm command voltage is output (between No.2 pin and No.4 pin).

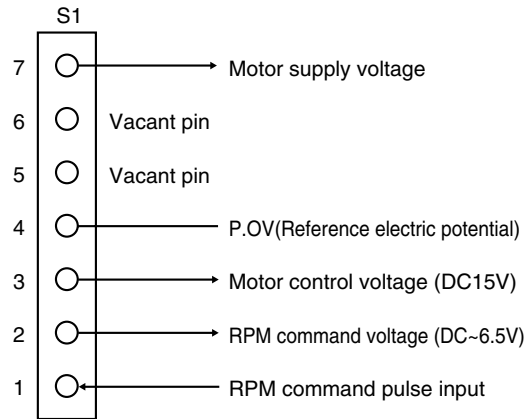

(R4023)

3.13 Rotating Pulse Input on Outdoor Unit PCB Check

Check No.23

< For propeller fan motor or humidification fan >

Make sure voltage of 270 ± 30 V is applied.

1. Set power ON and operation OFF. Remove connector S70 or S72.
2. Check that the voltage between No. 4 pin and No.7 pin is 270 VDC.
3. Check that the control voltage between No. 3 pin and No. 4 pin is 15 VDC.
4. Check that the RPM command voltage between No. 2 pin and No. 4 pin is 5 VDC.
5. Set power OFF and operation OFF. Connect connector S70 or S72.
6. Check whether two pulses (0 - 15 V) are input at No. 1 pin and No. 4 pin when the fan motor is rotated 1 turn by hand.

Fuses are commonly used as follows. Refer to the corresponding circuit diagram.

FU1	SW power supply 4-way valve Hygroscopic fan
FU2	Outdoor fan Humidification fan

When FU2 is melted, check outdoor fan for proper function.

If NG in step 2 → Defective PCB → Replace the PCB.

If NG in step 4 → Defective Hall IC → Replace the DC fan motor.

If OK in both steps 2 and 4 → Replace the PCB.

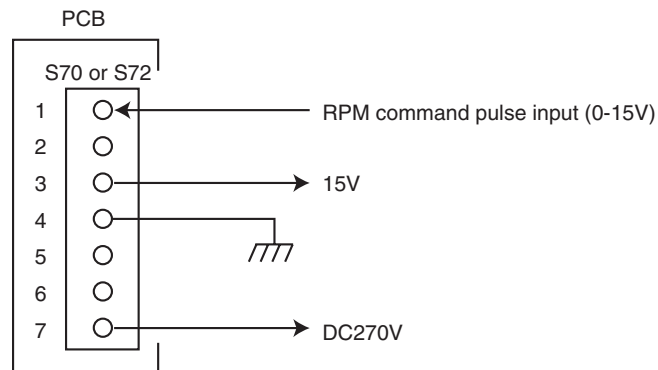

(R3477)

- Propeller fan motor: S70, Humidification fan motor: S72

<For Hygroscopic fan >

Check that the connectors HK1, HK2, HK3 for proper connection.

1. Check that the supply voltage between HK1 and HK3 is 5VDC.

*Check when the machine is not in suspend mode.

2. If NG in step 1 → Defective PCB → Replace the PCB.

FU1	SW power supply 4-way valve Hygroscopic fan
FU2	Outdoor fan Humidification fan

Therefore, when the FU2 is melted, check rotor motor for proper function.

3.14 Humidity Sensor Check

Check No.27

1. Check for proper connection.
 2. Check sensor input level (*1).
 3. Change ambient conditions (*2) and check that input level changes accordingly.
- *1 Input level varies depending on the sensor.
 *2 Changes in humidity, temperature, air flow rate. To do this, merely breathe upon.

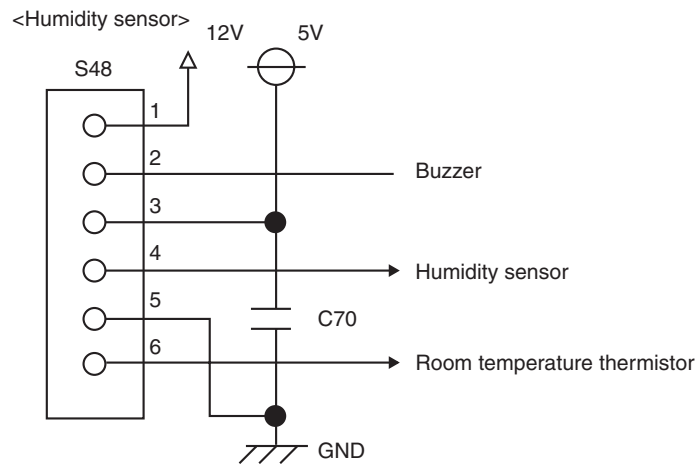

(R6023)

3.15 Main Circuit Short Check

Check No.29

- Measure the resistance between pins at both ends of DB1.
- If the resistance is ∞ or less than 1 k Ω , the main circuit short.

(-) terminal of the tester (in case of digital, (+) terminal)	(~)	(+)	(~)	(-)
(+) terminal of the tester (in case of digital, (-) terminal)	(+)	(~)	(-)	(~)
Resistance in OK	several k Ω ~several M Ω	∞	∞	several k Ω ~several M Ω
Resistance in NG	0 or ∞	0	0	0 or ∞

3.16 Four-way Valve Performance Check

Check No.31

< Caution on resetting the power supply >

* Be sure to wait for 30 sec. or more after turning off the power supply.

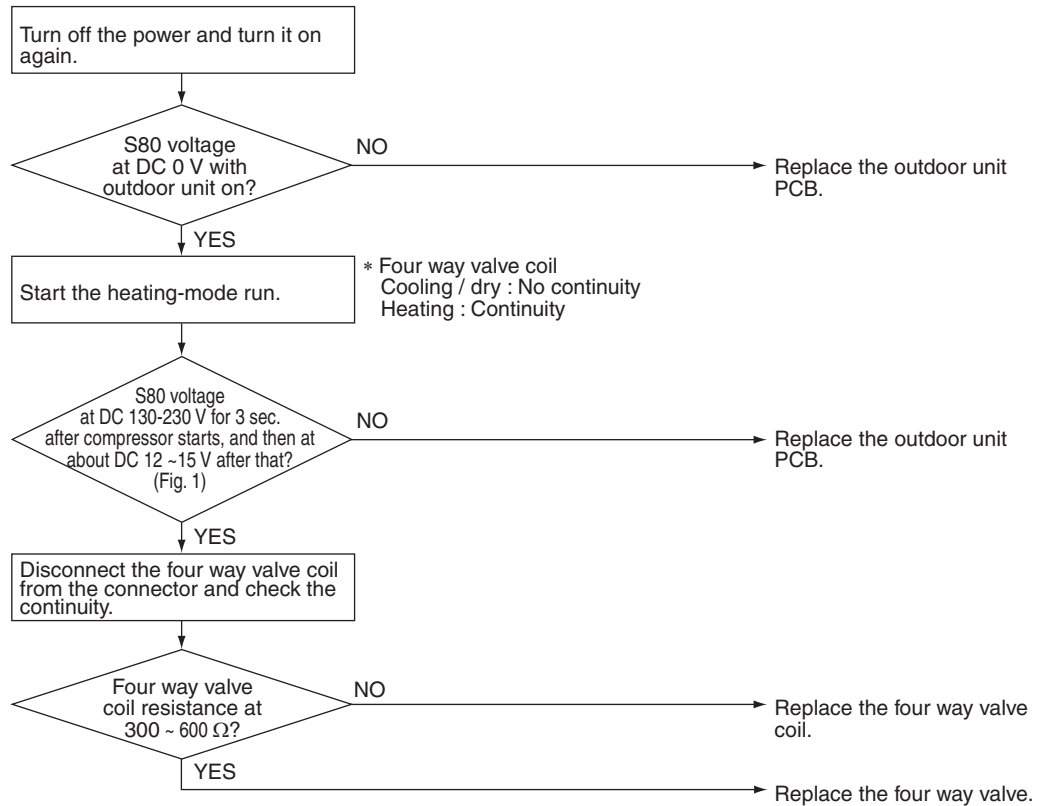

(Fig. 1)

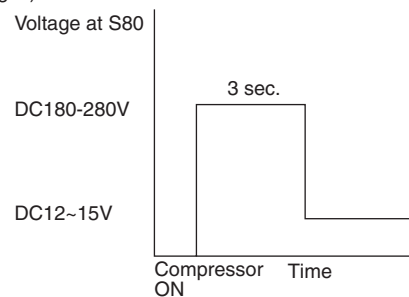

(R6025)

3.17 Solenoid Valve for Dehumidification Check

Check No.32

Faulty criterion:

In dehumidification test operation mode, PCB is identified as a faulty when the solenoid valve does not turn on within 2 sec. after compressor start-up.
(When reheating dehumidifying is not used, the operation mode is similar to cooling operation.)

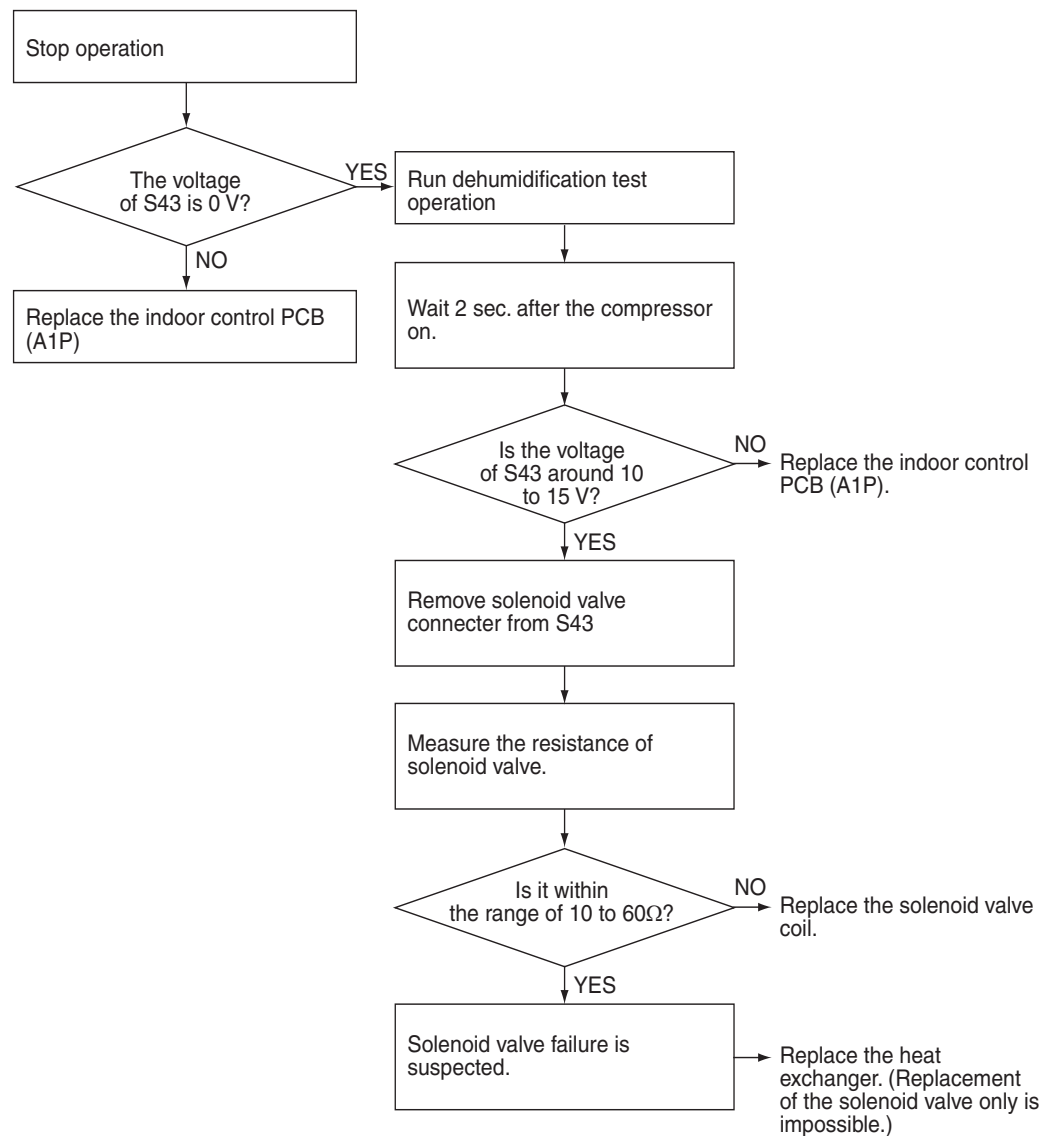

(R6026)

Part 7

Removal Procedure

1. Indoor Unit.....	216
1.1 Removal of the Air Filters / Front panel.....	216
1.2 Removal of the Upper Panel	222
1.3 Removal of the Front Grille	225
1.4 Removal of the Assembly of the Open/Close Mechanism	228
1.5 Removal of the Assembly of the Reduction Motor	230
1.6 Removal of the Electrical Box	233
1.7 Removal of the PCB.....	238
1.8 Removal of the Dehumidifying Solenoid Valve Coil	244
1.9 Removal of the Connecting Duct.....	245
1.10 Removal of the Drain Hose	247
1.11 Removal of the Swing Motor	249
1.12 Removal of the Heat Exchanger	251
1.13 Removal of the Propeller Fan / Fan Motor	254
1.14 Removal of Horizontal Blades / Vertical Blades	257
1.15 Removal of the Streamer Unit.....	259
2. Outdoor Unit.....	263
2.1 Removal of the Humidify Unit.....	263
2.2 Removal of the Heater Assembly / Humidifying Rotor (Moisture Absorption Element) / Humidifying Rotor Motor	266
2.3 Removal of the Humidifying Assembly.....	270
2.4 Removal of the Moisture Absorption Fan Motor.....	273
2.5 Removal of the Propeller Fan / Fan Motor	274
2.6 Removal of the Duct in Humidifier.....	279
2.7 Removal of the Electrical Box	280
2.8 Removal of the PCB.....	284
2.9 Removal of the Sound Blanket.....	287
2.10 Remove the Thermistor Assembly	289
2.11 Removal of the Reactor / Partition Plate	291
2.12 Removal of the Four Way Valve.....	292
2.13 Removal of the Expansion Valve	294
2.14 Removal of the Compressor.....	295

1. Indoor Unit

1.1 Removal of the Air Filters / Front panel

Procedure



Warning Be sure to wait 10 minutes or more after turning off all power supplies before disassembling work.

Step	Procedure	Points
<p>1. External appearance</p>		<ul style="list-style-type: none"> ■ Multi monitor lamp changes its color according to the operation mode. ■ Remote control is interactive communication type.
<p>2. Remove the air filter</p>	<p>1 Hold the front panel on both sides and lift it up.</p>	

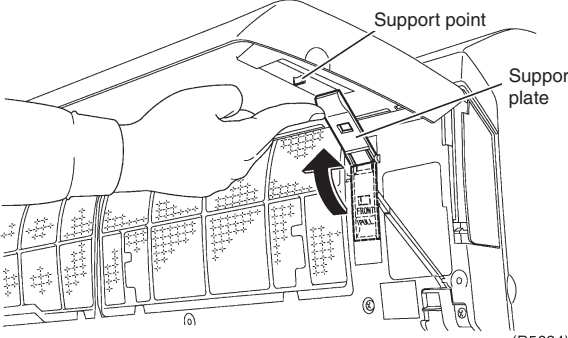
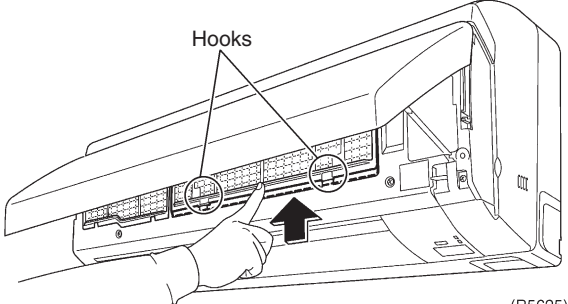
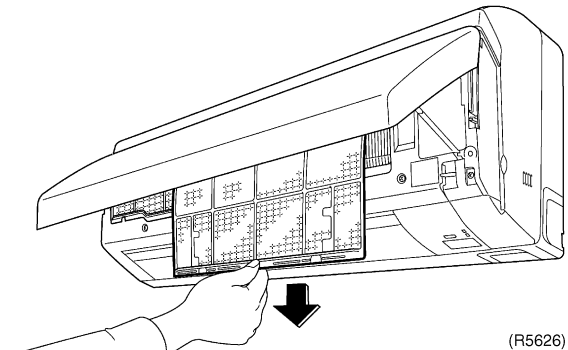
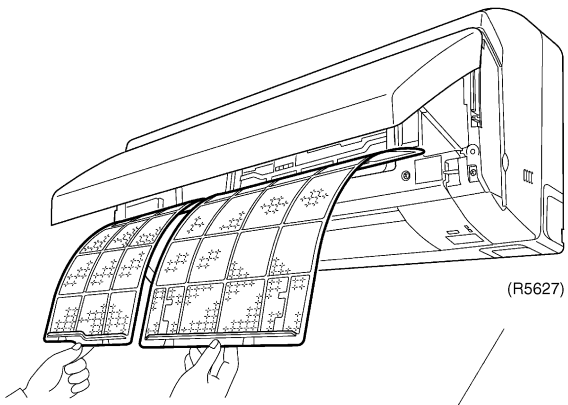
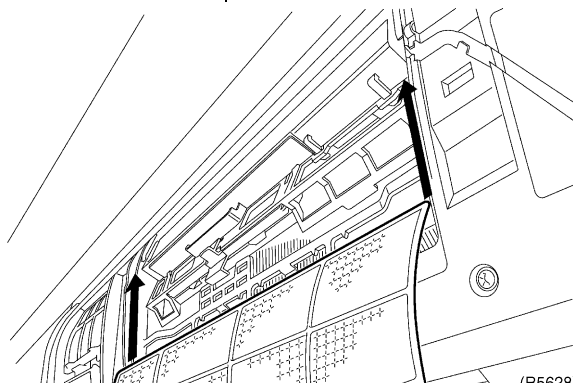
Step	Procedure	Points
2	<p>Keep the front panel open with the support plate.</p>  <p>(R5624)</p>	
3	<p>Push the center part of the air filter up to undo the 2 hooks.</p>  <p>(R5625)</p>	
4	<p>Remove the air filter toward yourself.</p>  <p>(R5626)</p>	
5	<p>The shapes of the right and left filters are different.</p>  <p>(R5627)</p>	<p>■ Insert the filters along with the guide for easy installation.</p>  <p>(R5628)</p>

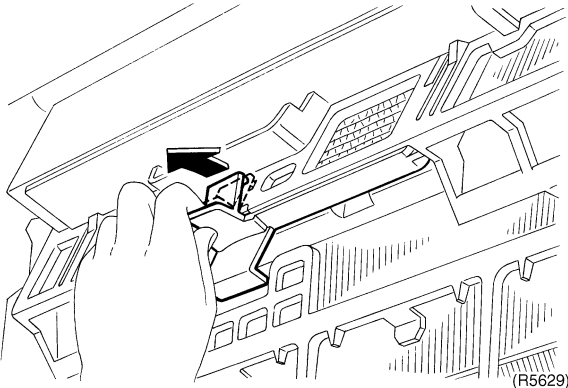
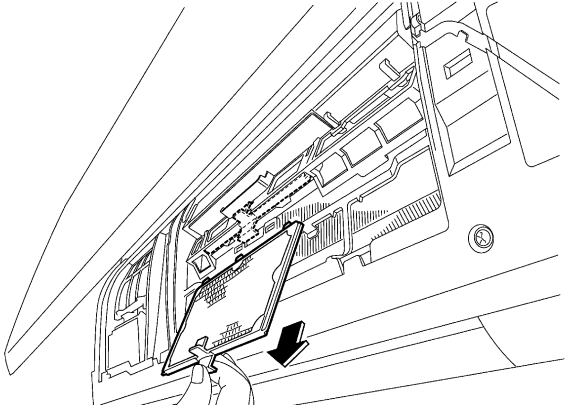
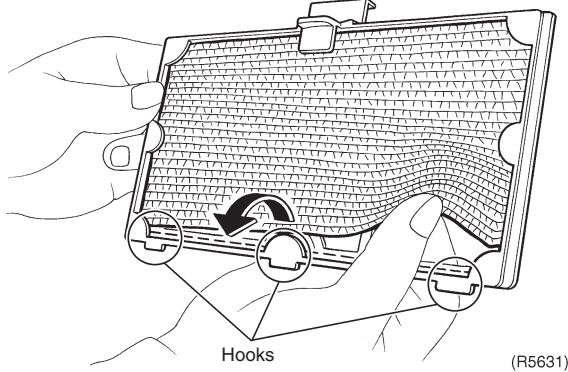
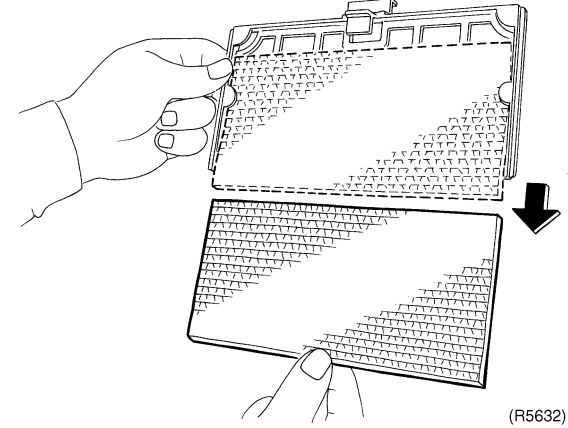
Step	Procedure	Points
3. Remove the deodorizing filter for streamer		
1	<p>Pull the center knob to undo the hook.</p>  <p>(R5629)</p>	
2	<p>Pull out the deodorizing filter for streamer toward yourself.</p>  <p>(R5630)</p>	
3	<p>Undo the 3 hooks on the longitudinal direction.</p>  <p>Hooks (R5631)</p>	<p>■ In cleaning, keep the filter with the frame for prevention of breakage.</p>
4	<p>Slide the filter toward yourself to remove.</p>  <p>(R5632)</p>	

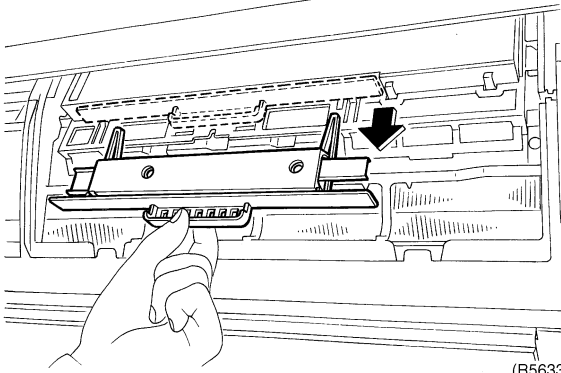
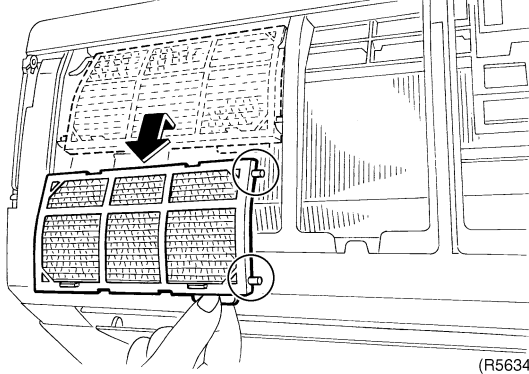
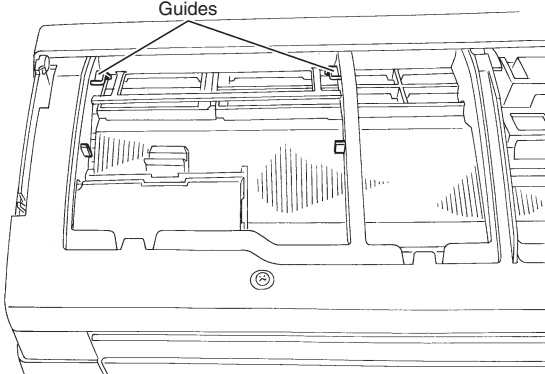
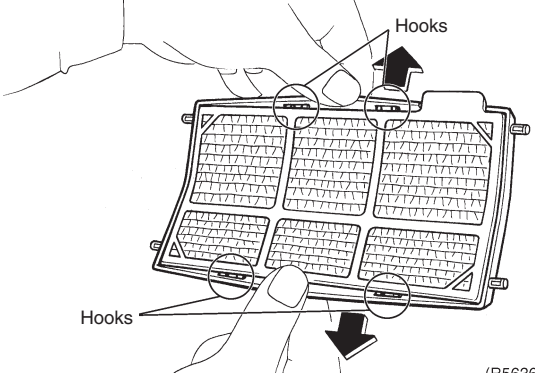
Step	Procedure	Points
4. Remove the streamer unit	<p>1 Pull down the streamer unit with holding the knob.</p>  <p>(R5633)</p>	
5. Remove the titanium apatite photocatalytic air purifying filter	<p>1 Undo the projection of the frame of titanium apatite photocatalytic air purifying filter and remove it.</p>  <p>(R5634)</p> <p>Guides</p>  <p>(R5635)</p> <p>2 Undo the 4 hooks, open the frame, and remove the titanium apatite photocatalytic air purifying filter.</p>  <p>(R5636)</p>	<p>■ Insert the filters along with the guide for easy installation.</p>

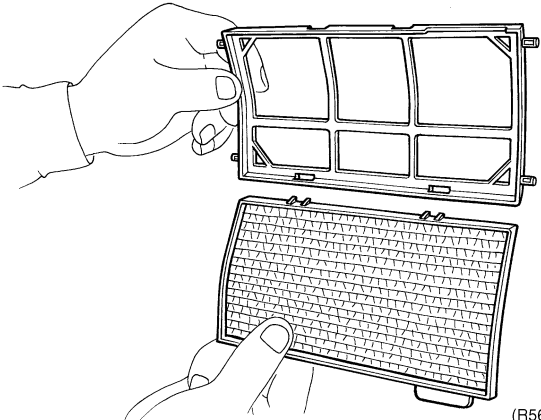
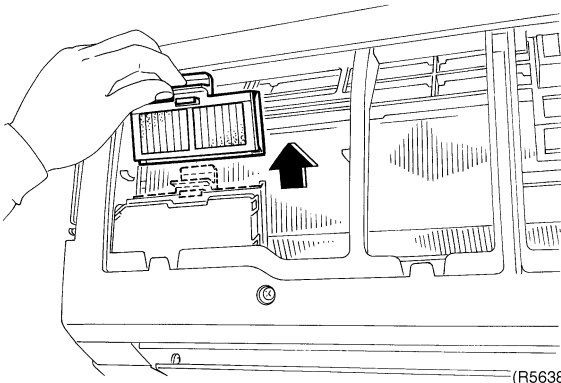
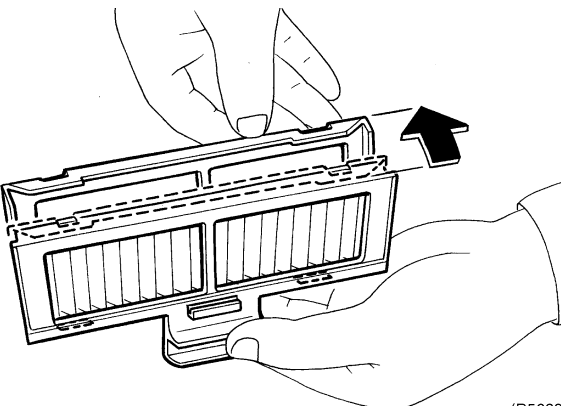
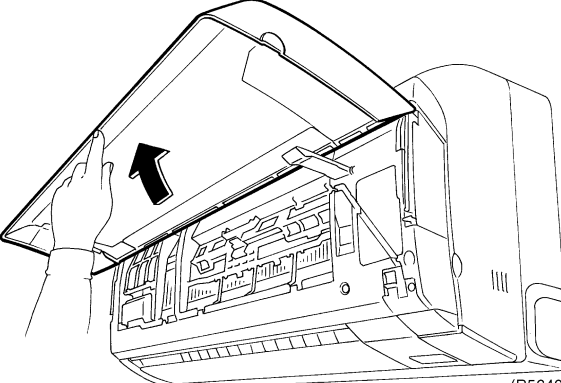
Step	Procedure	Points
	 <p style="text-align: right;">(R5637)</p>	
<p>6. Remove the air supply filter</p> <p>1 Lift the air supply filter up to take out.</p> <p>2 Undo the lower 2 hooks of the air supply filter and open the frame.</p>	 <p style="text-align: right;">(R5638)</p>  <p style="text-align: right;">(R5639)</p>	<ul style="list-style-type: none"> ■ Insert the filters along with the guide for easy installation. ■ Install the air supply filter correctly so that the "Front" mark comes front. ■ Humidifying operation without installing the air supply filter will form condensation inside the panel and it causes water leakage. ■ There are 4 hooks for the air supply filter.
<p>7. Remove the front panel</p> <p>1 Open the front panel further than the stopping position.</p>	 <p style="text-align: right;">(R5640)</p>	

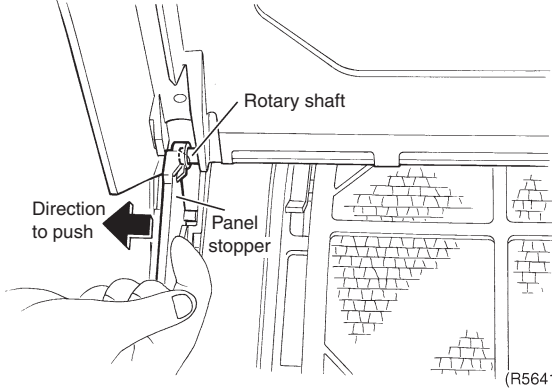
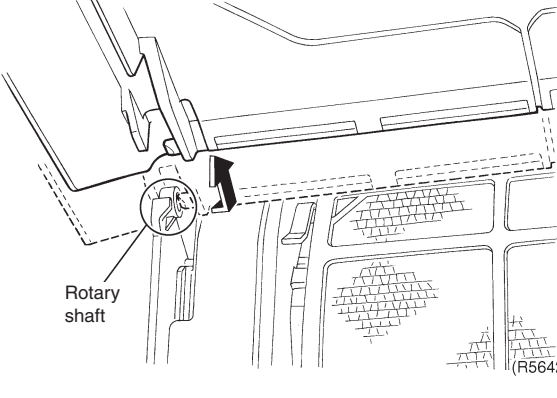
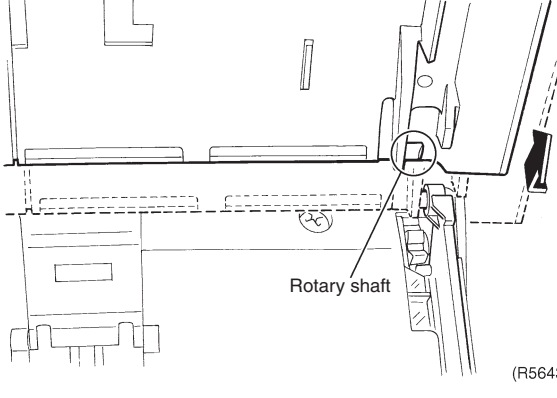
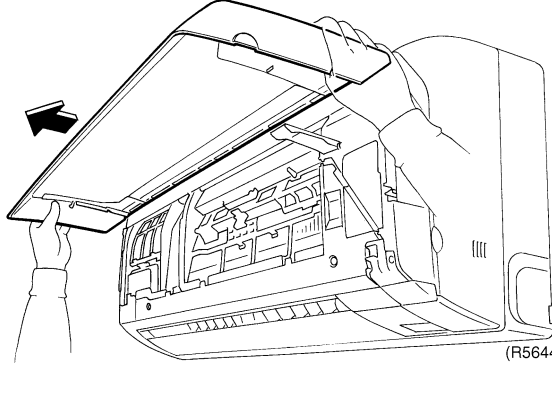
Step	Procedure	Points
2	<p>Push the panel stoppers outward on both right and left sides to detach the rotary shafts from the holes.</p> 	
3	<p>Slide the rotary shaft on the left to the right and pull it out toward yourself.</p> 	
4	<p>Slide the rotary shaft on the right to the left and pull it out toward yourself.</p> 	
5	<p>Remove the front panel.</p> 	

1.2 Removal of the Upper Panel

Procedure

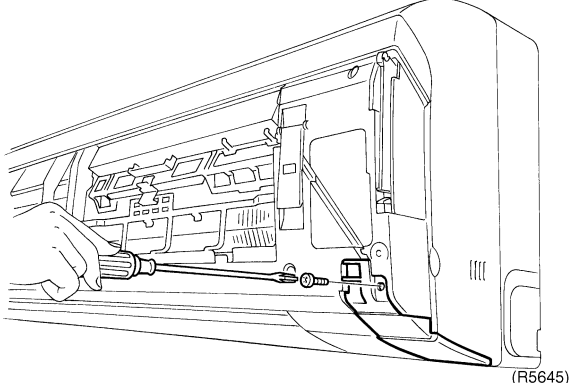
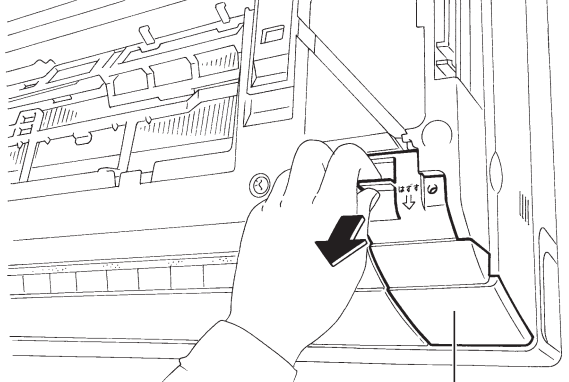
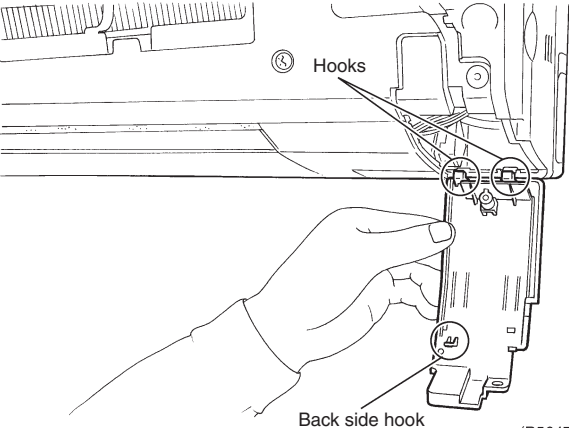

Warning Be sure to wait 10 minutes or more after turning off all power supplies before disassembling work.

Step	Procedure	Points
1. Remove the service cover		
1	<p>Loosen the 1 screw (black) of the service cover.</p>  <p>(R5645)</p>	
2	<p>Slide the service cover downward to undo the hook on the back side (see the figure below).</p>  <p>Service cover (R5646)</p>	
3	<p>When assembling, catch the 2 hooks on the far side first, and close the cover.</p>  <p>Hooks Back side hook (R5647)</p>	<p>■ There is no field setting switch.</p>

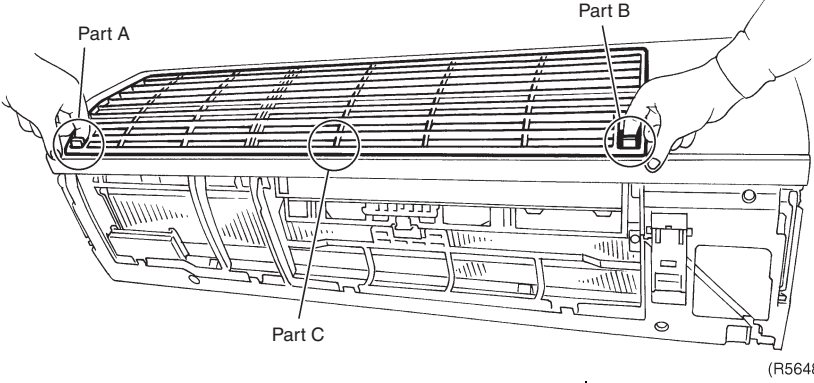
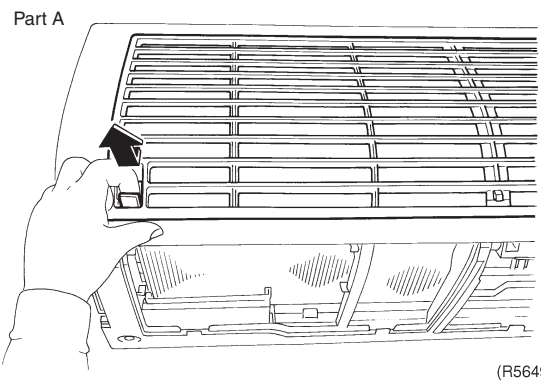
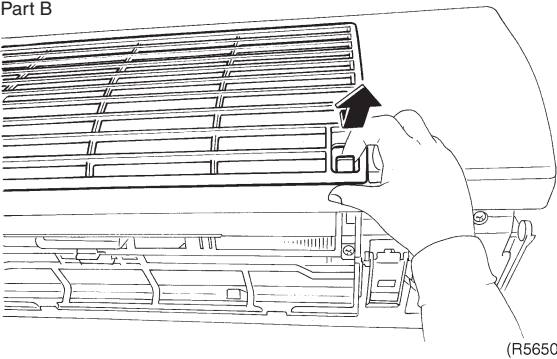
Step	Procedure	Points
<p>2. Remove the upper panel</p>	<p>1 Undo the 3 hooks of the upper panel.</p>  <p>2 In part A, pinch the upper hook, undo the hook, and lift it up.</p>  <p>3 In part B, undo the hook as in part A, and lift it up.</p> 	

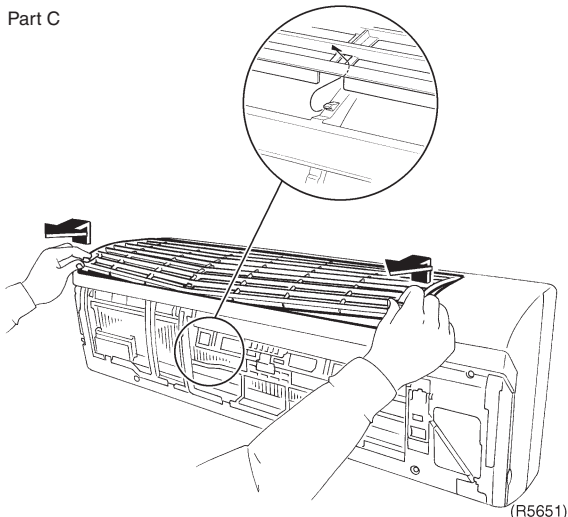
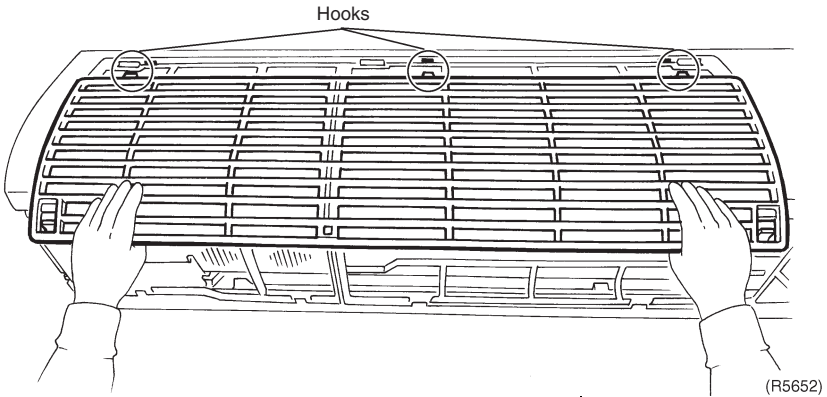
Step	Procedure	Points
4	<p>In part C, lift the right and left sides to bend the upper panel and slightly pull toward yourself to remove.</p> 	
5	<p>Pull the upper panel toward yourself to remove.</p> 	<p>■ When assembling, make sure to catch the far side hooks.</p>

1.3 Removal of the Front Grille

Procedure



Warning Be sure to wait 10 minutes or more after turning off all power supplies before disassembling work.

Step	Procedure	Points
<p>1. Remove the front grille</p> <p>1 Loosen the 3 screws and undo the upper 3 hooks of the front grille.</p> <p>2 Undo the center, right and left hooks.</p> <p>3 Open the horizontal blade (large) fully for preventing the blade from getting caught in pulling the front grille out.</p>	<p style="text-align: center;">Hooks</p> <p style="text-align: center;">Screw</p> <p style="text-align: center;">Screws</p> <p style="text-align: right;">(R5653)</p> <p style="text-align: right;">(R5654)</p> <p style="text-align: right;">(R5655)</p> <p style="text-align: center;">Horizontal blades (large)</p> <p style="text-align: right;">(R5656)</p>	<ul style="list-style-type: none"> ■ If the hooks are hard to be undone, use a flat screwdriver. ■ You can check the position by the projection when it is hard to see.

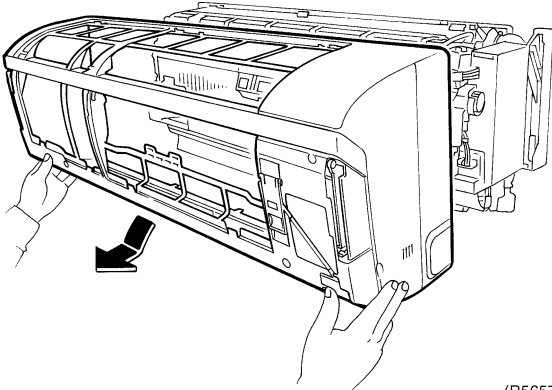
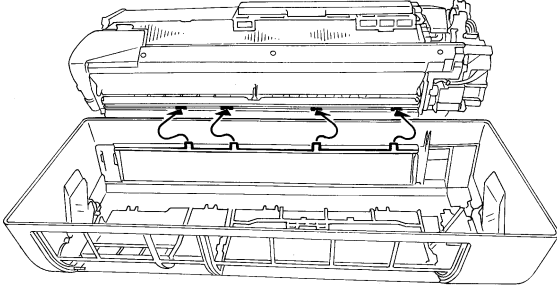
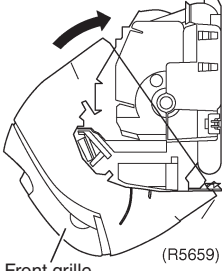
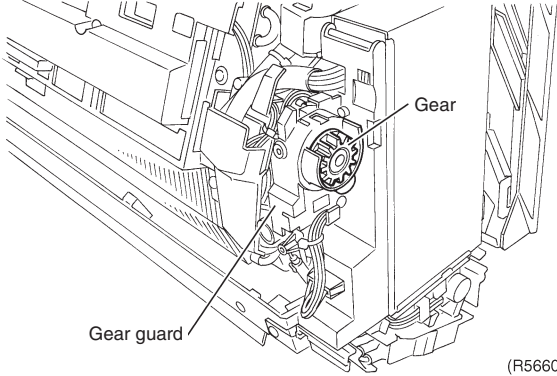
Step	Procedure	Points
4	<p>Slide the front grille toward yourself to remove.</p>  <p>(R5657)</p>	
2. How to install the front grille	<p>1 When assembling the front grille, fit the 4 lower hooks and push in until a click is heard.</p>  <p>(R5658)</p>	<p>Points on installing</p> <ul style="list-style-type: none"> ■ When assembling, make sure that the horizontal blade (large) does not come inside. ■ When assembling, follow the same steps for removal in reverse.  <p>Front grille (R5659)</p>
3. Features of the gear case	<p>1 There is a gear assembly for front panel driving.</p>  <p>(R5660)</p>	<ul style="list-style-type: none"> ■ There is no mark for fitting the gear.

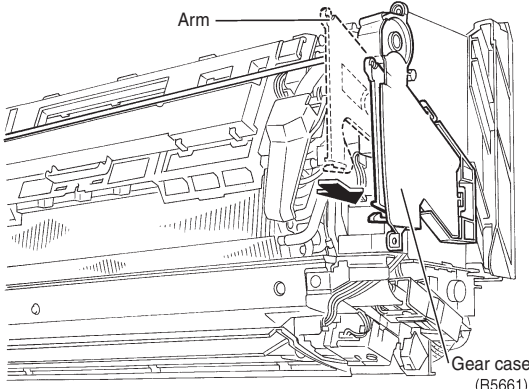
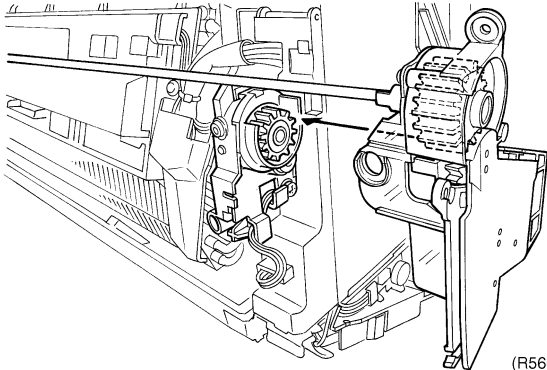
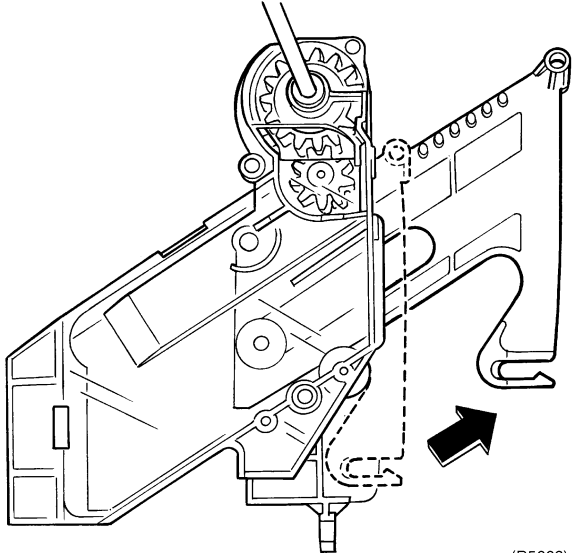
Step	Procedure	Points
2	<p>Check that the arm in the gear case of the front grille is in the stored position.</p>  <p>Arm</p> <p>Gear case (R5661)</p>	<ul style="list-style-type: none"> ■ The gear case is fixed to the front grille. When assembling the front grille, make sure the arm is stored.
3	<p>Installation structure of the gear case.</p>  <p>(R5662)</p>	
4	<p>Movement of the arm.</p>  <p>(R5663)</p>	

1.4 Removal of the Assembly of the Open/Close Mechanism

Procedure



Warning Be sure to wait 10 minutes or more after turning off all power supplies before disassembling work.

Step	Procedure	Points
1.	Remove the open/close mechanism (right)	Preparation
1	Loosen the 1 screw of the open/close mechanism (right).	<ul style="list-style-type: none"> ■ Remove the front grille according to "Removal of the Front Grille". ■ When assembling, catch the lower hook first.
2	Undo the lower hook while straightening the open / close mechanism (right) and remove it.	
3	Pull out the open/close mechanism (right) from the shaft.	

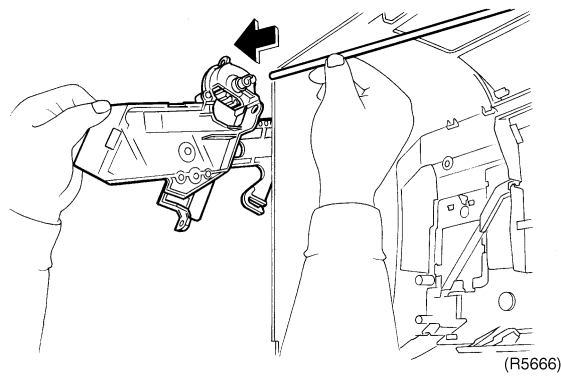
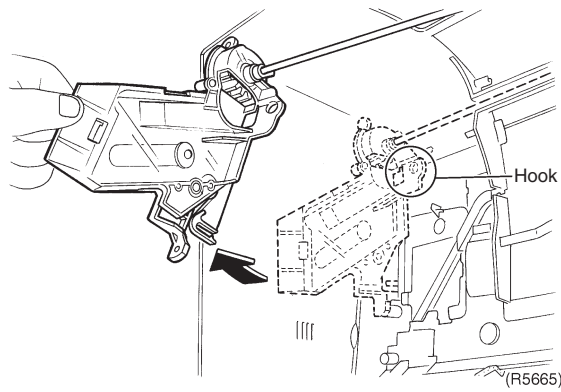
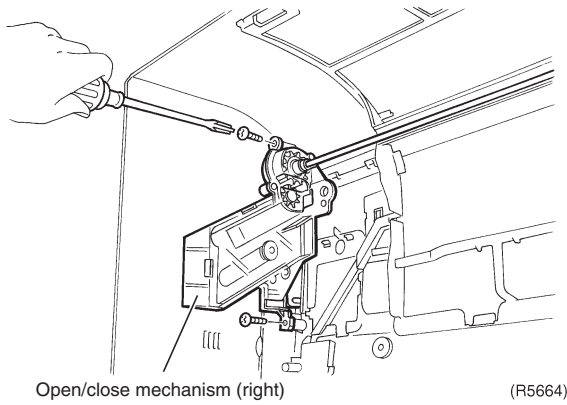

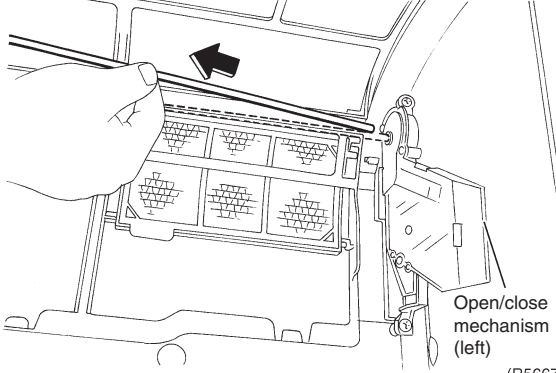
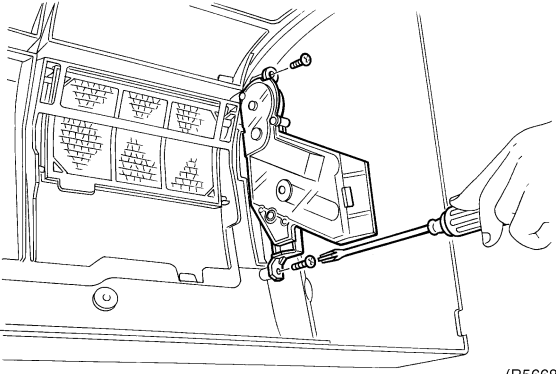
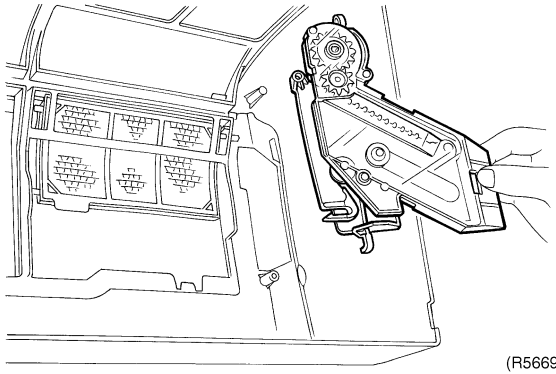
Step	Procedure	Points
2.	Remove the open/close mechanism (left)	
1	<p>Pull out the shaft from the open/close mechanism (left).</p>  <p>Open/close mechanism (left) (R5667)</p>	
2	<p>Loosen the 2 screws of the open/close mechanism (left).</p>  <p>(R5668)</p>	<p>■ Service part is obtained as an assembly kit.</p>
3	<p>Remove the open/close mechanism (left).</p>  <p>(R5669)</p>	

1.5 Removal of the Assembly of the Reduction Motor

Procedure

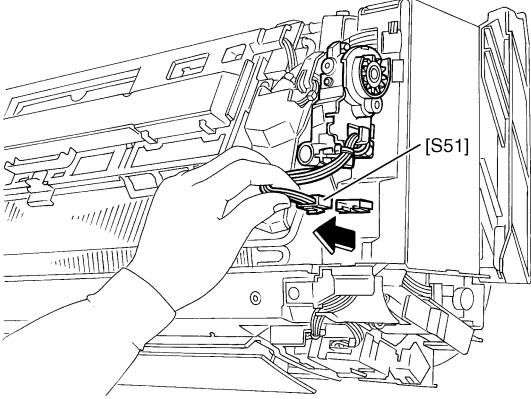
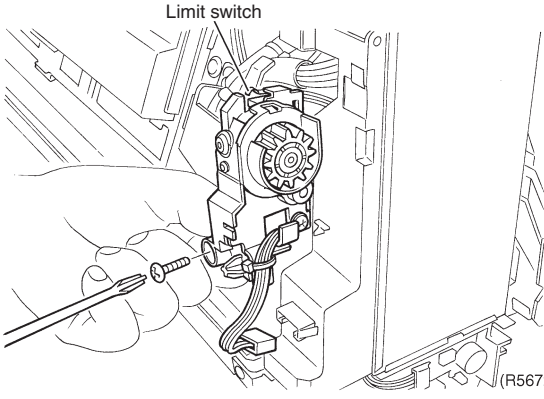
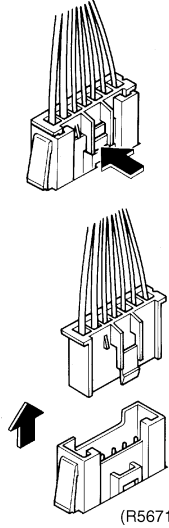
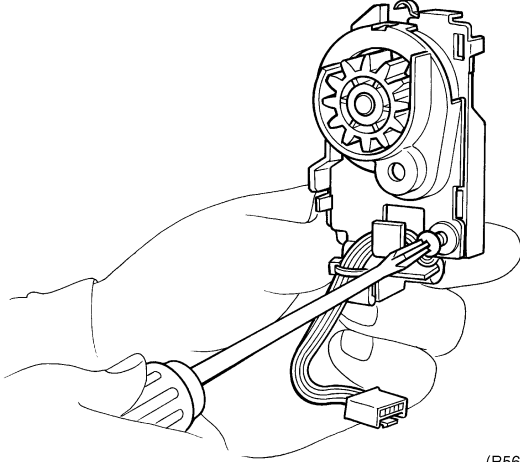

Warning Be sure to wait 10 minutes or more after turning off all power supplies before disassembling work.

Step	Procedure	Points
1. Remove the assembly of the reduction motor		
<p>1 Disconnect the connector for reduction motor [S51].</p> <p>2 Loosen the 1 screw of the assembly of the reduction motor.</p>	 <p style="text-align: right;">(R5670)</p>  <p style="text-align: right;">(R5672)</p>	 <p style="text-align: right;">(R5671)</p> <ul style="list-style-type: none"> ■ The figure above shows the hook on the connector for the assembly of reduction motor. ■ When touching the electrical parts like the limit switch, be sure to conduct the work after discharging static electricity of the human body. It may cause trouble of the PCB.
2. Remove the reduction motor		
1 Loosen the 1 screw.	 <p style="text-align: right;">(R5673)</p>	

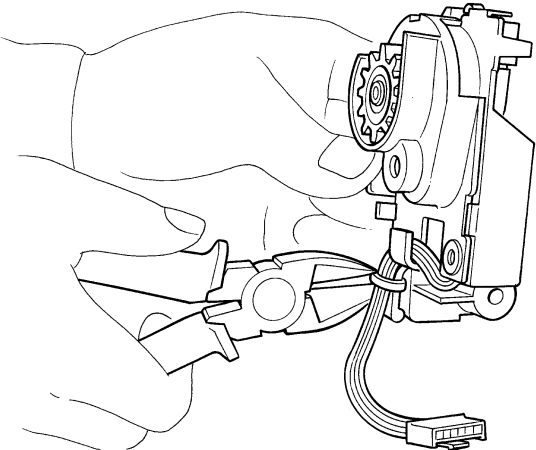
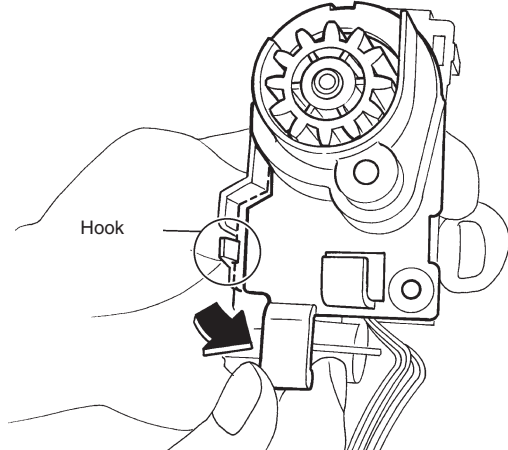
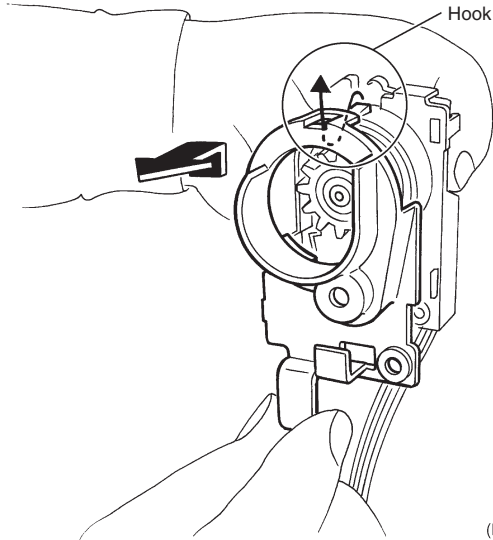
Step	Procedure	Procedure	Points
2	Cut the clamp.	 <p>(R5674)</p>	
3	Slide the cover to the right to undo the hook.	 <p>(R5675)</p>	
4	Lift the cover of the gear case of the reduction motor up slightly to undo the upper hook, and remove it.	 <p>(R5676)</p>	

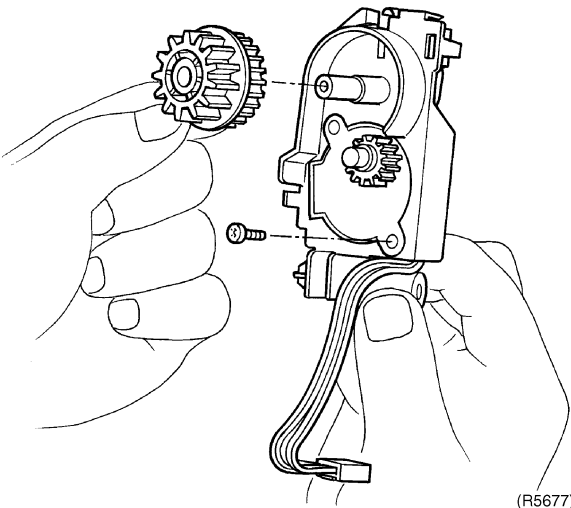
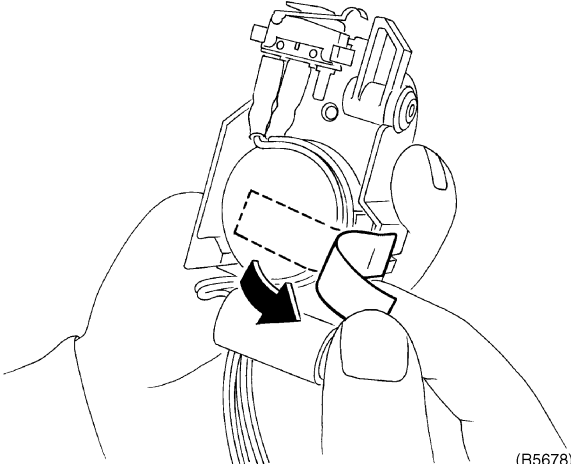
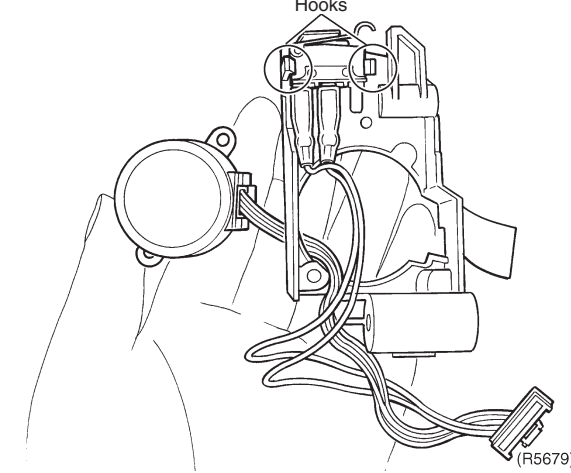
Step	Procedure	Points
5	<p>Pull the gear out to remove. Loosen the 1 screw of the reduction motor.</p>  <p>(R5677)</p>	
6	<p>Turn the assembly over and detach the sealing tape of the reduction motor.</p>  <p>(R5678)</p>	
7	<p>Undo the 2 hooks of the limit switch.</p>  <p>(R5679)</p>	<p>■ The connector of the reduction motor can be disconnected.</p>

1.6 Removal of the Electrical Box

Procedure



Warning Be sure to wait 10 minutes or more after turning off all power supplies before disassembling work.

Step	Procedure	Points
1. Disconnect the wire harnesses around the electrical box		
1 Open the cover of the electrical box.		
2 Remove the connection wire fixing plate and disconnect the connection wire.		
3 The figure shows the arrangement of wiring of wire harnesses (front) and names of parts.		

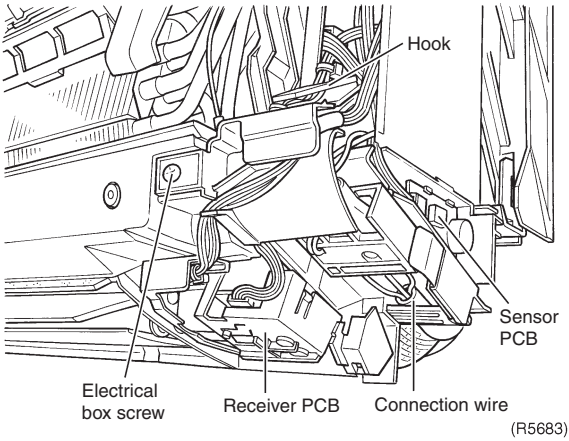
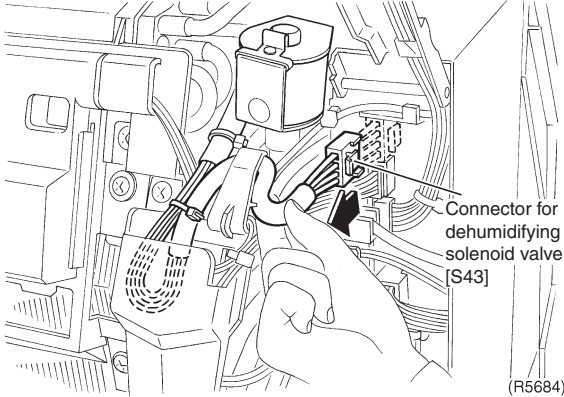
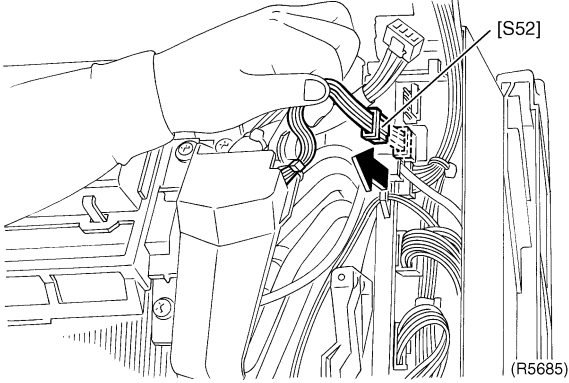
Step	Procedure	Points
4	<p>The figure shows the arrangement of wiring of wire harnesses (under) and names of parts.</p> 	
5	<p>Disconnect the connector for dehumidifying solenoid valve [S43].</p> 	
6	<p>Disconnect the connector for streamer unit [S52].</p> 	

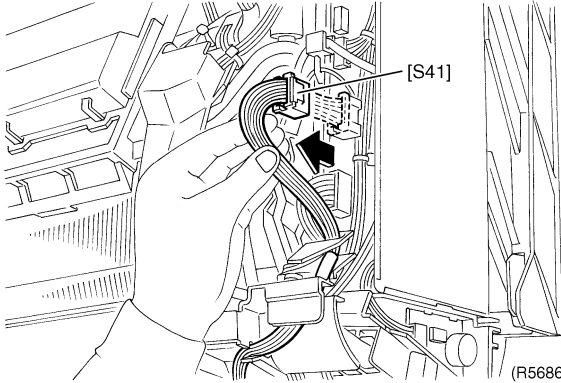
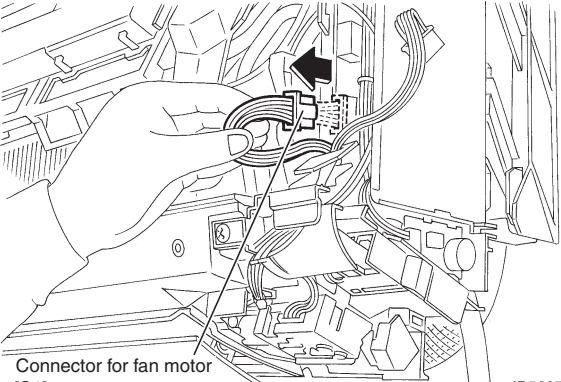
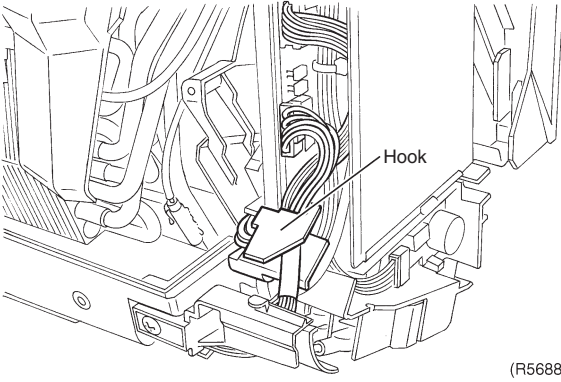
Step	Procedure	Points
7	<p>Disconnect the connector for swing motor [S41].</p>  <p>(R5686)</p>	<ul style="list-style-type: none"> ■ The connector [S41] is for both horizontal blades and vertical blades.
8	<p>Disconnect the connector for fan motor [S1], and undo the 1 hook.</p>  <p>Connector for fan motor [S1]</p> <p>(R5687)</p>  <p>Hook</p> <p>(R5688)</p>	

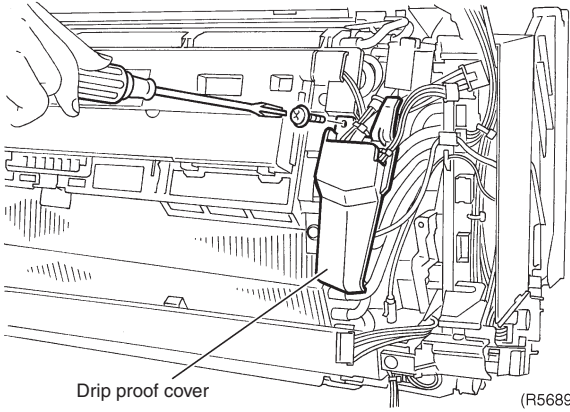
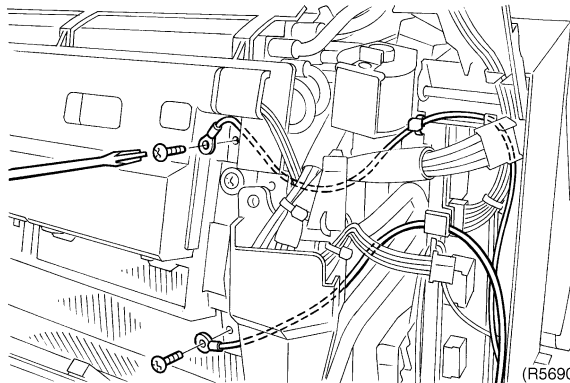
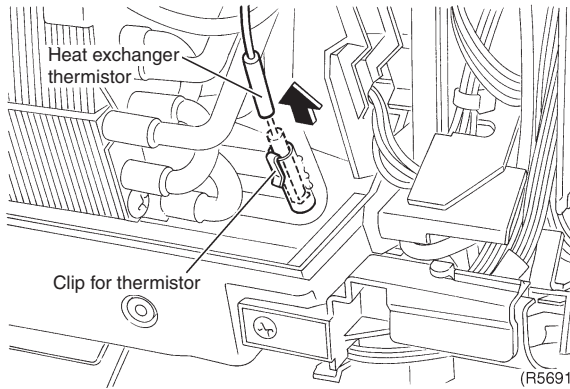
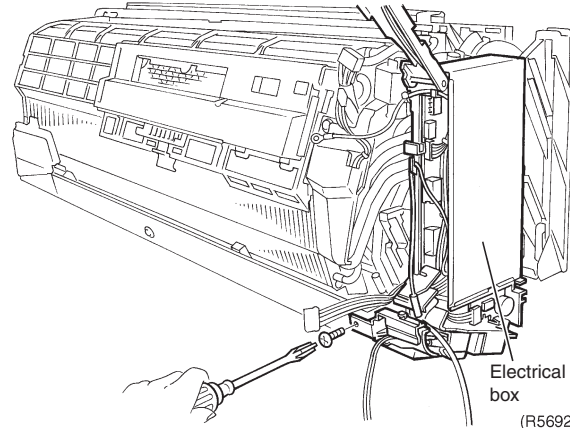
Step	Procedure	Points
<p>9</p> <p>Loosen the 1 screw of the drip proof cover.</p>	 <p>Drip proof cover (R5689)</p>	<ul style="list-style-type: none"> ■ Be careful not to lose the clip for thermistor. ■ Positions of the thermistors are different according to the models.
<p>10</p> <p>Loosen the each screw of the 2 earth wires.</p>	 <p>(R5690)</p>	
<p>11</p> <p>Disconnect the heat exchanger thermistor.</p>	 <p>Heat exchanger thermistor</p> <p>Clip for thermistor (R5691)</p>	
<p>2. Remove the electrical box</p>		
<p>1</p> <p>Loosen the 1 screw of the electrical box.</p>	 <p>Electrical box (R5692)</p>	

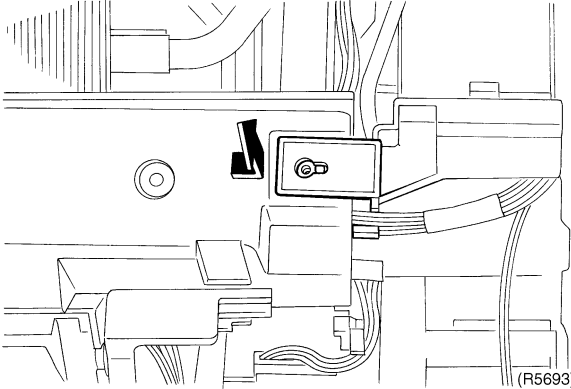
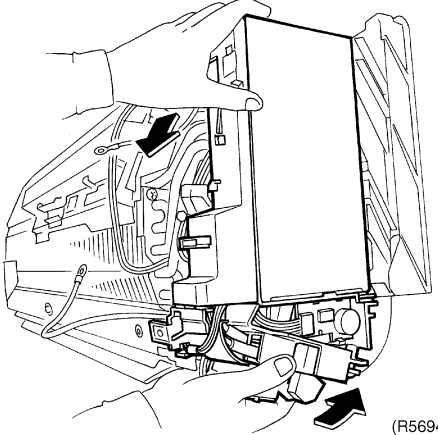
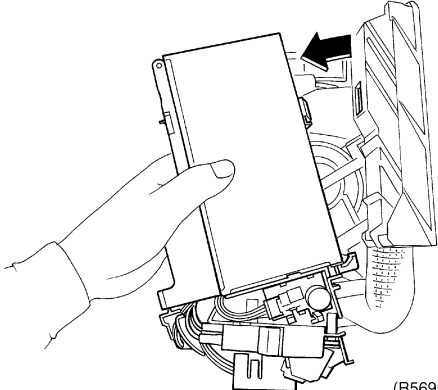
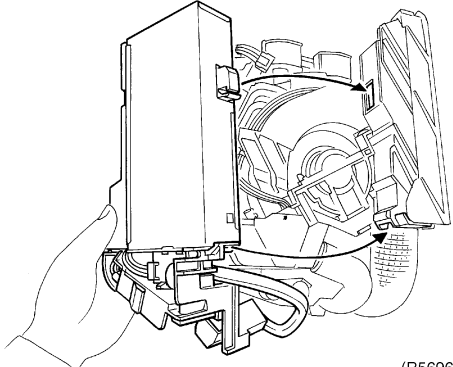
Step	Procedure	Points
2	<p>Close the cover and slide to undo the hook in the key hole.</p>  <p>(R5693)</p>	
3	<p>Push up the bottom side of the electrical box, or push the bottom frame to the back.</p>  <p>(R5694)</p>	
4	<p>Undo the upper hook first.</p>  <p>(R5695)</p>	
5	<p>The shapes of the hook on back side.</p>  <p>(R5696)</p>	<ul style="list-style-type: none"> ■ When assembling, insert the upper hook, push slightly, and make sure to catch the lower hook.

1.7 Removal of the PCB

Procedure

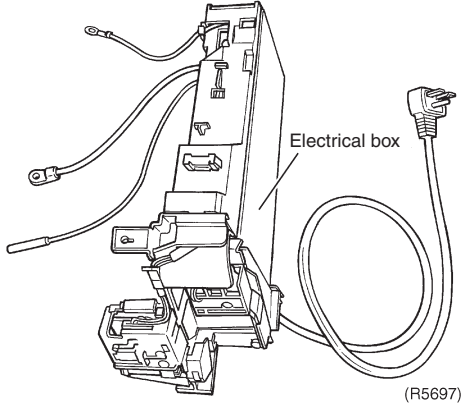
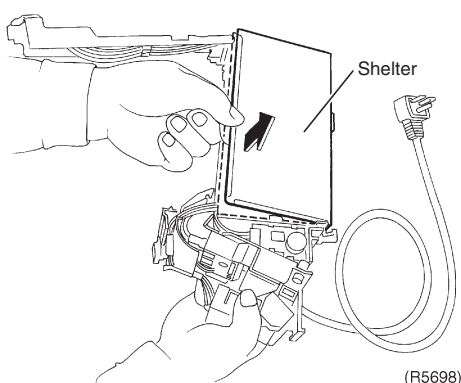
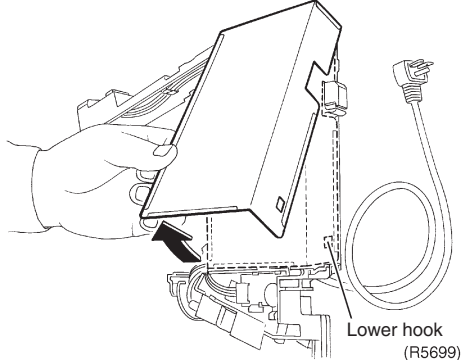
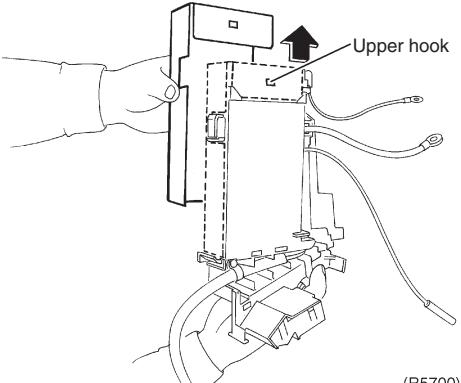

Warning Be sure to wait 10 minutes or more after turning off all power supplies before disassembling work.

Step	Procedure	Points
1. Remove the shelter		<p>Preparation</p> <ul style="list-style-type: none"> Remove the electrical box according to "Removal of the Electrical Box".
1	<p>External appearance of the electrical box.</p>  <p style="text-align: right;">(R5697)</p>	
2	<p>Undo the hook of the shelter.</p>  <p style="text-align: right;">(R5698)</p>	
3	<p>While opening the shelter, undo the lower hook and lift the shelter up to undo the upper hook on the back.</p>  <p style="text-align: right;">Lower hook (R5699)</p>	
4	<p>Slide the shelter upward while lifting up (without hooked) and undo the 2 sockets.</p>  <p style="text-align: right;">Upper hook (R5700)</p>	

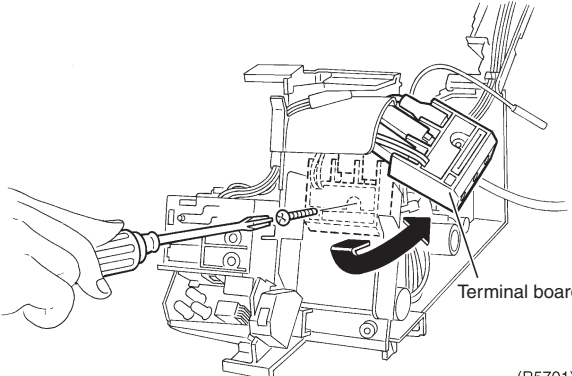
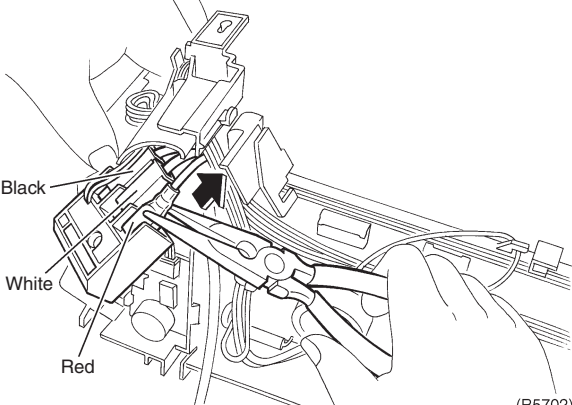
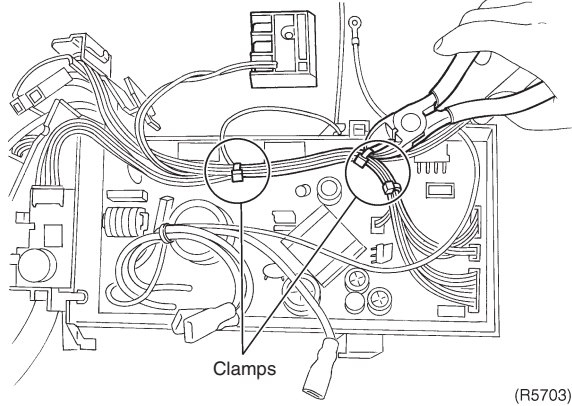
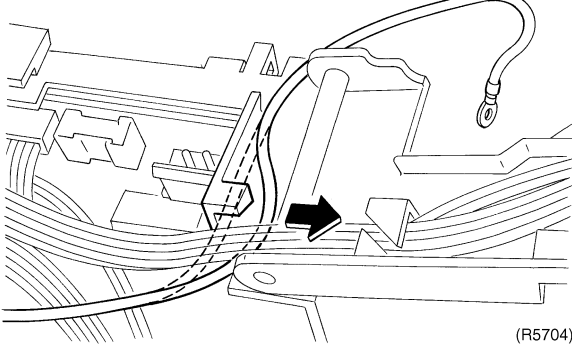
Step	Procedure	Points
<p>2. Remove the power supply terminal board</p>	<p>1 Loosen the 1 screw and pull out the terminal board sideward.</p>  <p>Terminal board</p> <p>(R5701)</p> <p>2 Disconnect the red terminal with pliers and black and white terminals with a flat screwdrivers on the terminal board.</p>  <p>Black</p> <p>White</p> <p>Red</p> <p>(R5702)</p>	<p>Black..... (1) Power supply White (2) Power supply Red (3) Signal</p>
<p>3. Remove the control PCB</p>	<p>1 Cut the 3 clamps.</p>  <p>Clamps</p> <p>(R5703)</p> <p>2 Undo the earth wire from the hook.</p>  <p>(R5704)</p>	<p>■ Clamps should be used all the time. Fix it as it was before.</p>

Step	Procedure	Points
3	Disconnect the connectors [S46] and [S48].	[S46]: to the display PCB [S56] [S48]: to the sensor PCB [CN1]
4	Push out the connector for reduction motor mechanism while pinching the connector from the back side of the electrical box cover.	
5	Loosen the 2 screws and remove the control PCB.	

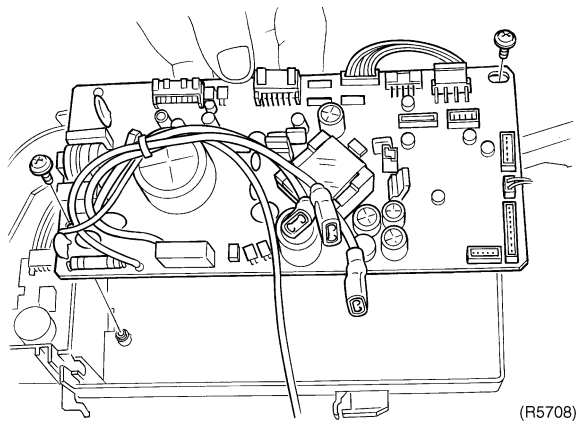
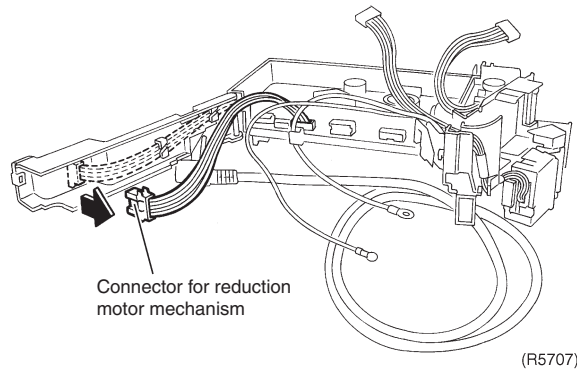
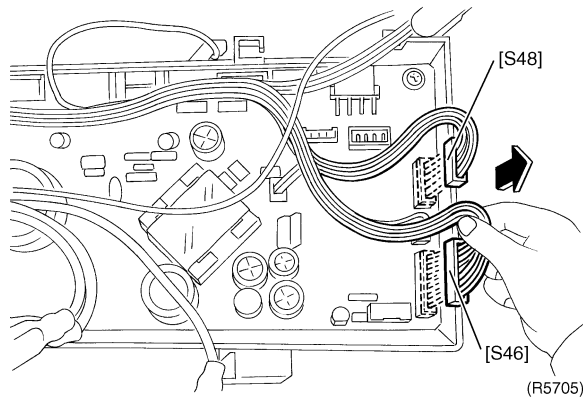

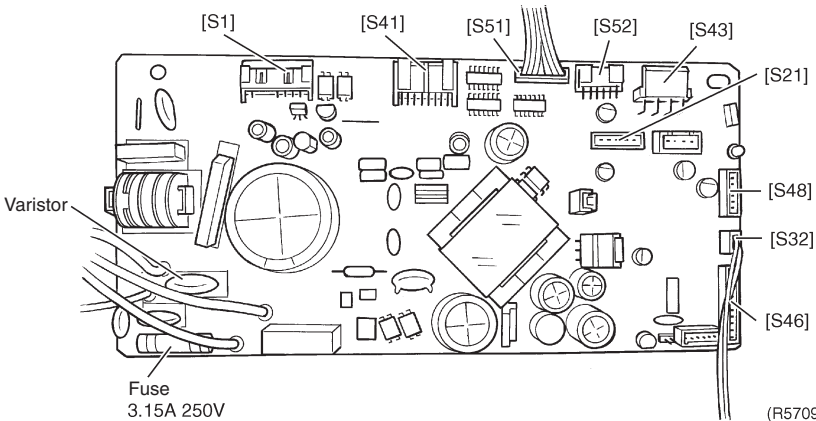
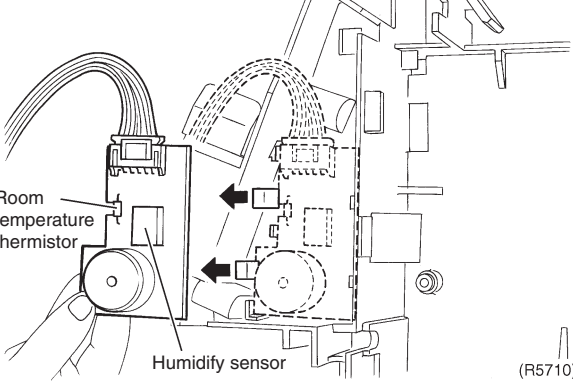
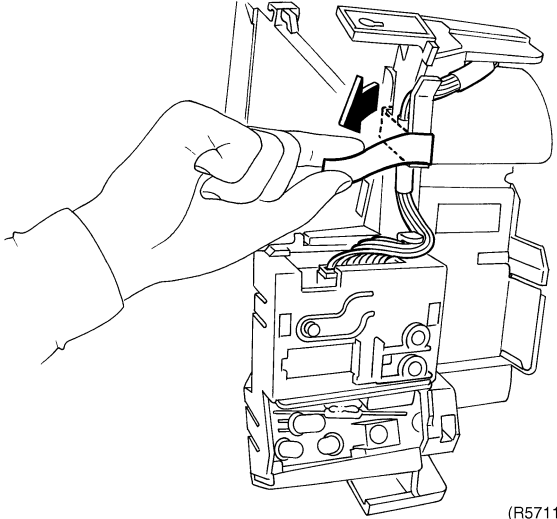
Step	Procedure	Points
6	<p>Names of parts of the control PCB.</p>  <p>[S1]: Fan motor [S21]: HA [S32]: Heat exchanger thermistor [S41]: Swing motor [S43]: Solenoid valve [S46]: to Display PCB [S48]: to Sensor PCB [S51]: Open/close mechanism [S52]: Streamer unit</p> <p>Varistor Fuse 3.15A 250V</p> <p>(R5709)</p>	
4. Remove the sensor PCB		
1	<p>Undo the 1 hook and pull out the sensor PCB.</p>  <p>Room temperature thermistor Humidify sensor</p> <p>(R5710)</p>	
5. Remove the receiver PCB		
1	<p>The arrangement of the wire harnesses.</p> <p>2 Detach the fixing tape and disconnect the connector.</p>  <p>(R5711)</p>	

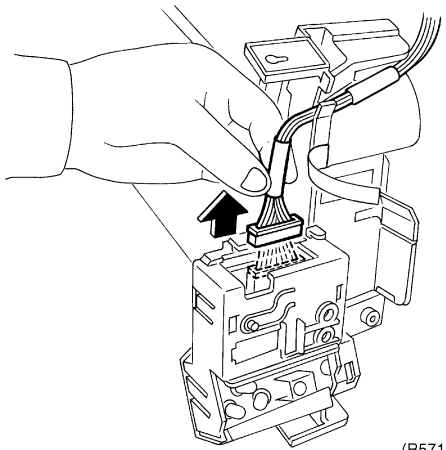
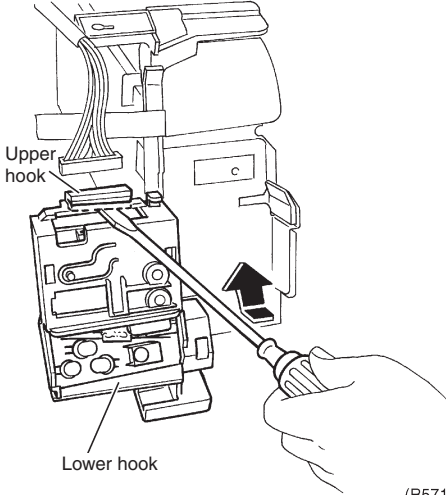
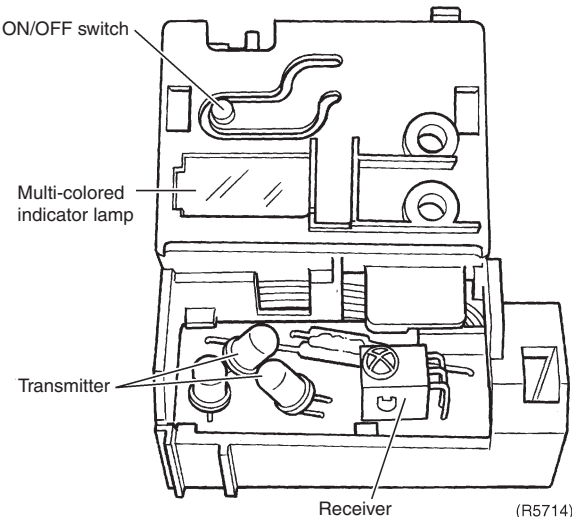
Step	Procedure	Points
<p>3</p> <p>4</p>	 <p>(R5712)</p>  <p>(R5713)</p>  <p>(R5714)</p>	<ul style="list-style-type: none"> ■ Using a flat screwdriver makes it easy to undo the hook.

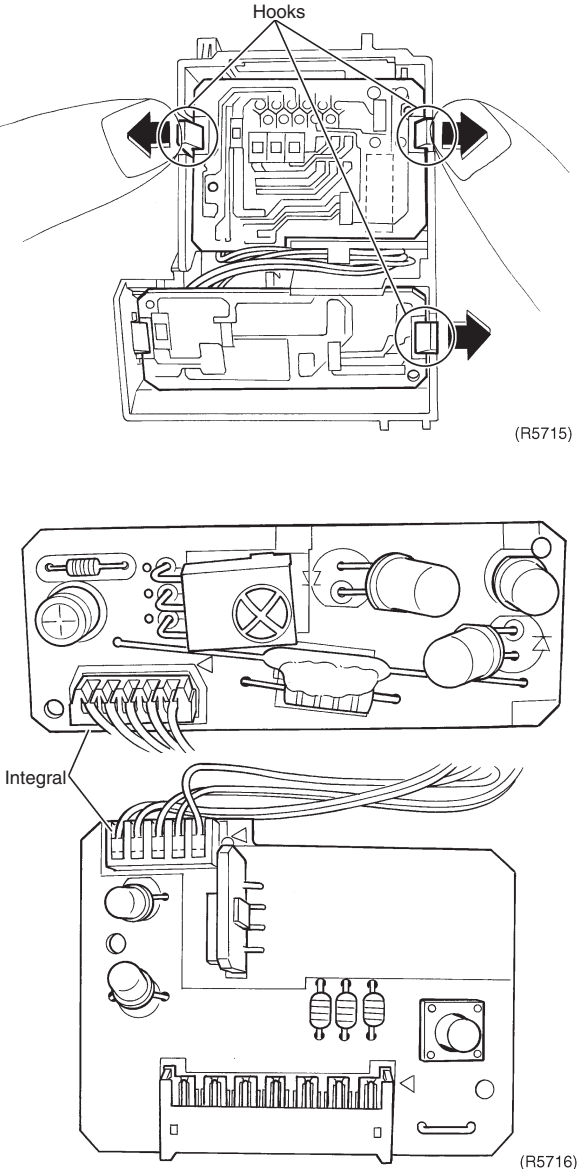
Step	Procedure	Points
<p>5</p>	<p>Undo the 3 hooks of the receiver PCB.</p>  <p>(R5715)</p> <p>(R5716)</p>	<ul style="list-style-type: none"> ■ The receiver PCB and the display PCB are united.

1.8 Removal of the Dehumidifying Solenoid Valve Coil

Procedure

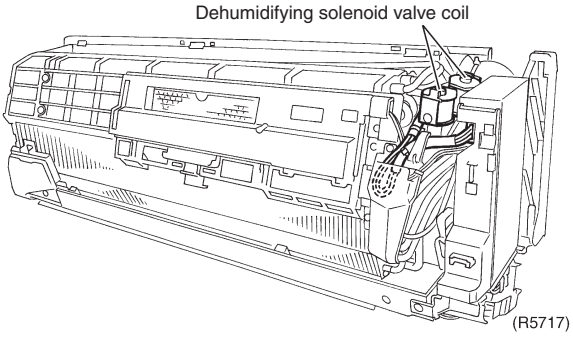
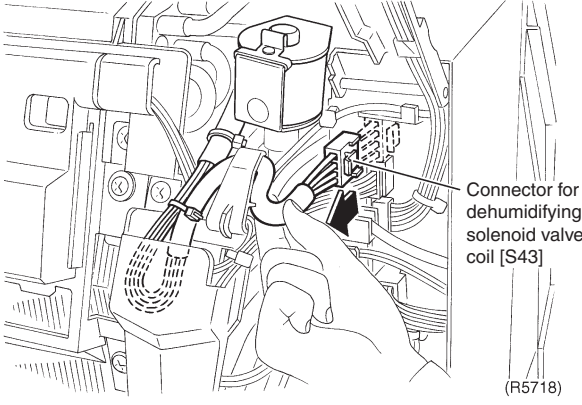
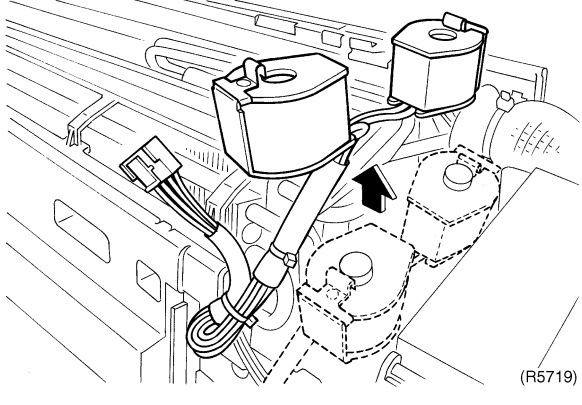

Warning Be sure to wait 10 minutes or more after turning off all power supplies before disassembling work.

Step	Procedure	Points
1	Detach the lead wire from the drip proof cover. 	Preparation <ul style="list-style-type: none"> Remove the front grille according to "Removal of the Front Grille".
2	Disconnect the connector for dehumidifying solenoid valve [S43]. 	
3	Pull the dehumidifying solenoid valve coil to remove. 	<ul style="list-style-type: none"> Solenoid valve does not need screws.

1.9 Removal of the Connecting Duct

Procedure

Warning Be sure to wait 10 minutes or more after turning off all power supplies before disassembling work.

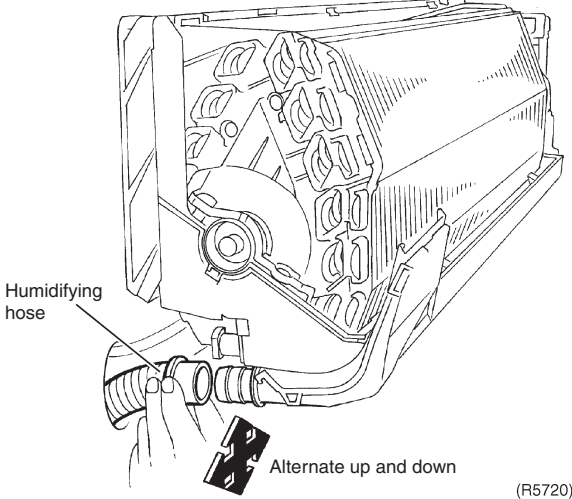
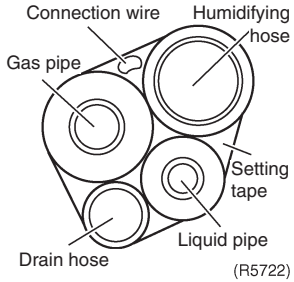
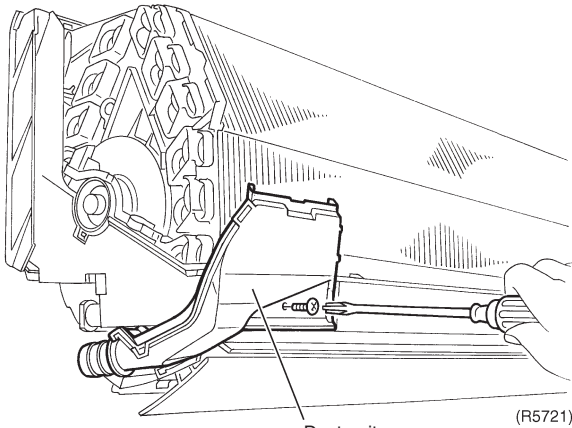
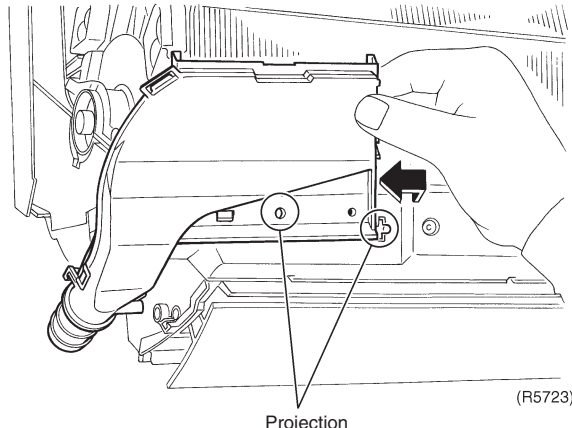
Step	Procedure	Points
1. Remove the connecting duct for humidifying hose		<p>Preparation</p> <ul style="list-style-type: none"> ■ Remove the front grille according to "Removal of the Front Grille". ■ Since inside of the connecting duct has projection hooks, shake the hose up and down to remove. ■ Rotate in the same direction as when assembling for easy removal. ■ Put the drain hose at the bottom and make an inclination downward.
1 Detach the humidifying hose from the duct unit.	 <p>Humidifying hose</p> <p>Alternate up and down (R5720)</p>	 <p>Connection wire Humidifying hose Gas pipe Setting tape Liquid pipe Drain hose (R5722)</p>
2 Loosen the 1 fixing screw for the duct unit.	 <p>Duct unit (R5721)</p>	
3 Lift the right side to undo the projections and slide to the left.	 <p>Projection (R5723)</p>	

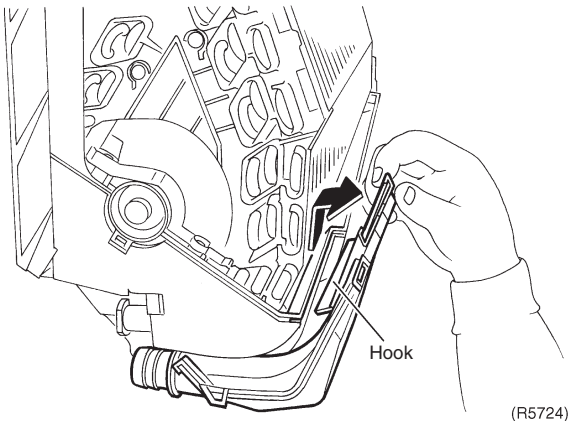
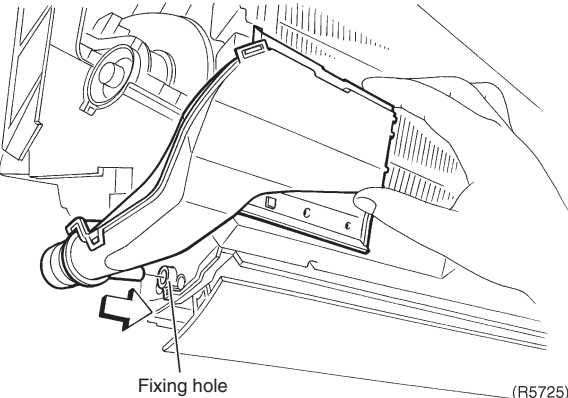
Step	Procedure	Points
4	<p>Slide the duct unit upward to remove.</p>  <p style="text-align: right;">(R5724)</p>	
5	<p>When assembling, make sure to insert into the fixing hole.</p>  <p style="text-align: right;">(R5725)</p>	

1.10 Removal of the Drain Hose

Procedure



Warning Be sure to wait 10 minutes or more after turning off all power supplies before disassembling work.

Step	Procedure	Points
<p>1. Remove the drain hose</p> <p>1 Loosen the screws of the main unit and installation plate.</p> <p>2 Lift the main unit slightly and remove the drain hose. (In case of piping on the right)</p>	<p>(R5726)</p> <p>(R5727)</p>	<ul style="list-style-type: none"> ■ Cover the drain hose with plastic bags or the like so as the remaining drain will not wet the floor. ■ Part A is fixed by the screw from back side. When replacing the hose, make sure to tighten a screw as there is no gap between the heat insulator and the hose.
<p>2. How to conduct piping on the left</p> <p>1 Detach the drain plug on the left.</p>	<p>(R5728)</p>	

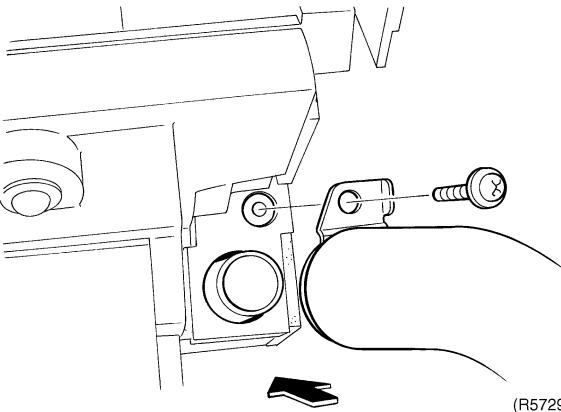
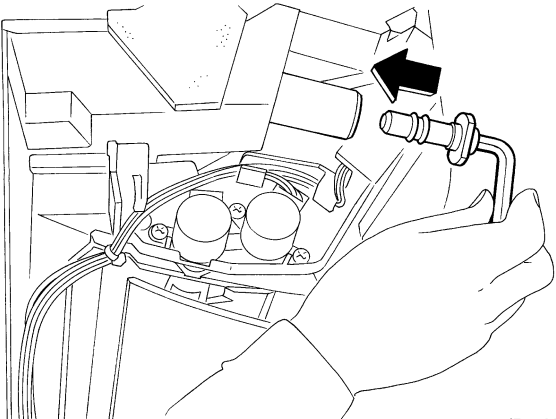
Step	Procedure	Points
2	<p>Insert the drain hose removed in the previous step.</p>  <p>(R5729)</p>	<ul style="list-style-type: none"> ■ Make sure to check the drain hose is inserted firmly.
3	<p>Insert the detached drain plug with an Allen wrench (4mm).</p>  <p>(R5730)</p>	<p>⚠ Caution Do not push the drain plug with a sharp device like a screwdriver. (The drain plug can be damaged and that causes leakage of water.)</p>

1.11 Removal of the Swing Motor

Procedure

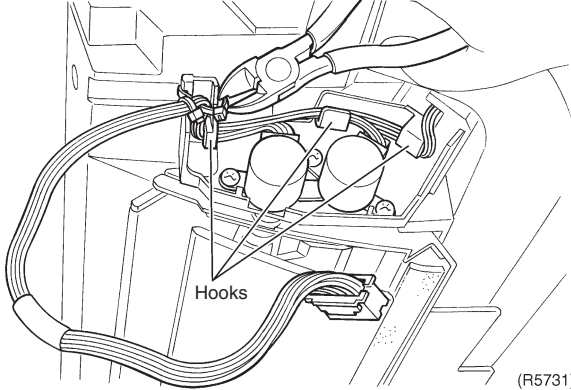
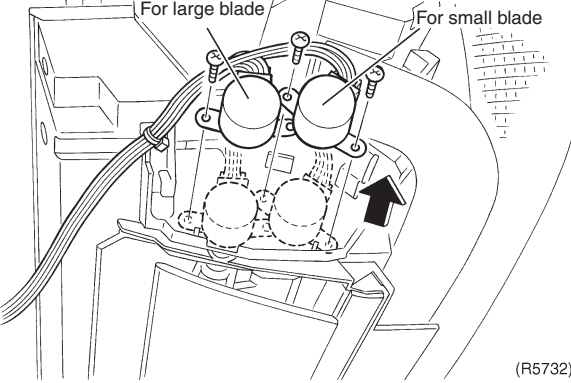
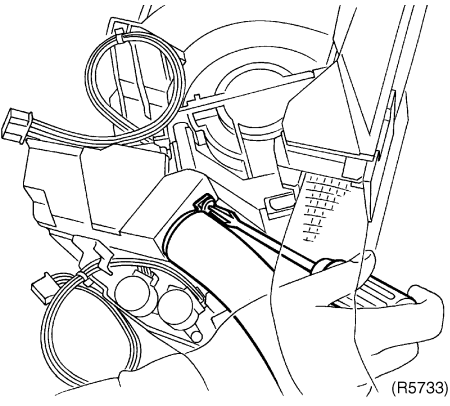
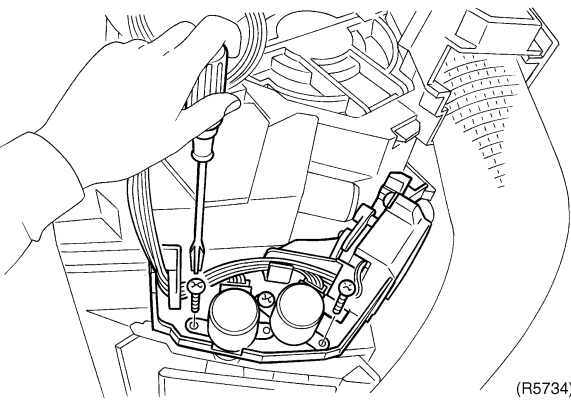

Warning Be sure to wait 10 minutes or more after turning off all power supplies before disassembling work.

Step	Procedure	Points
<p>1. Remove the swing motor</p> <p>1 There are 3 hooks for the lead wire for swing motor.</p> <p>2 Cut the clamp with nippers.</p> <p>3 Undo the lead wire for swing motor from the hooks.</p> <p>4 Loosen the 1 screw of the swing motor for the horizontal blades (large). Loosen the 2 screws of the swing motor for the horizontal blades (small).</p>	 <p>Hooks</p> <p>(R5731)</p>  <p>For large blade</p> <p>For small blade</p> <p>(R5732)</p>	<p>Preparation</p> <ul style="list-style-type: none"> ■ Remove the electrical box according to "Removal of the Electrical Box". ■ The connector for swing motor is disconnectable. ■ The same swing motors are used for both large and small horizontal blades.
<p>2. Remove the swing motor for vertical blades</p> <p>1 Loosen the 1 screw of the drain hose.</p> <p>2 Loosen the 2 screws of the assembly of swing motor.</p>	 <p>(R5733)</p>  <p>(R5734)</p>	<ul style="list-style-type: none"> ■ Working without removing the drain hose is possible.

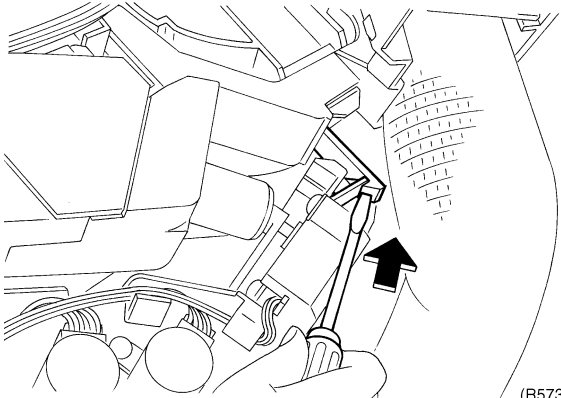
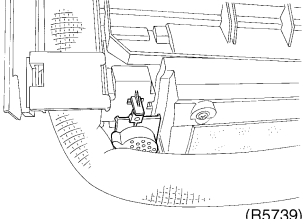
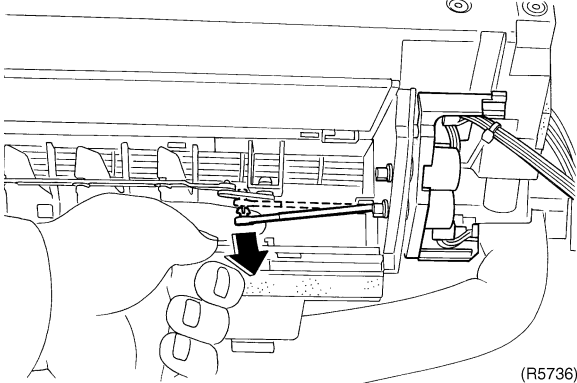
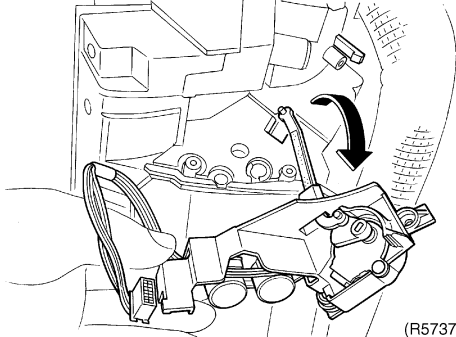
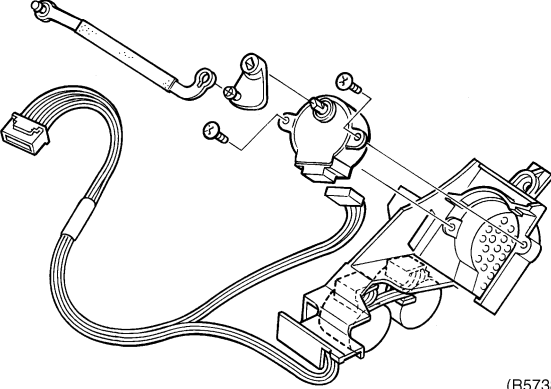
Step	Procedure	Procedure	Points
3	Undo the upper hook of the cover with a flat screwdriver.	 <p>(R5735)</p>	 <p>(R5739)</p> <ul style="list-style-type: none"> ■ The hook on the back of the assembly of swing motor.
4	Undo the hook of connecting shaft for vertical blades.	 <p>(R5736)</p>	
5	Remove the assembly of swing motor.	 <p>(R5737)</p>	
6	Loosen the 2 screws of the swing motor for vertical blades.	 <p>(R5738)</p>	<ul style="list-style-type: none"> ■ When assembling the swing motor for vertical blades, remove the drain hose.

1.12 Removal of the Heat Exchanger

Procedure

Warning Be sure to wait 10 minutes or more after turning off all power supplies before disassembling work.

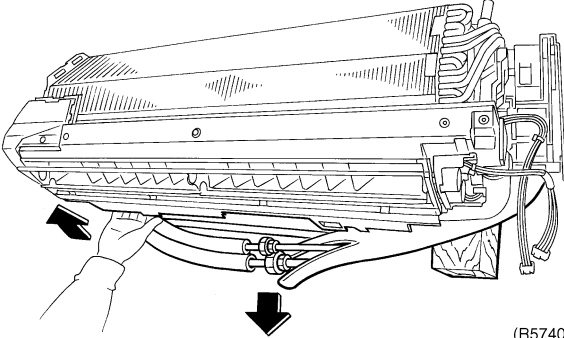
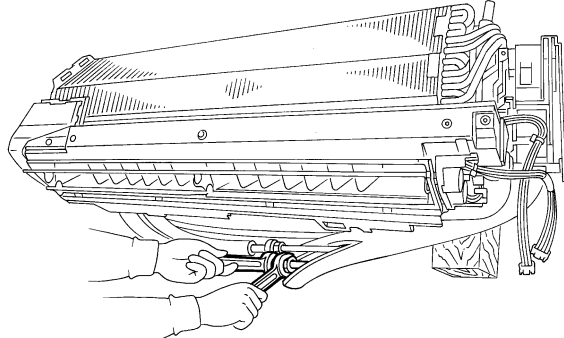
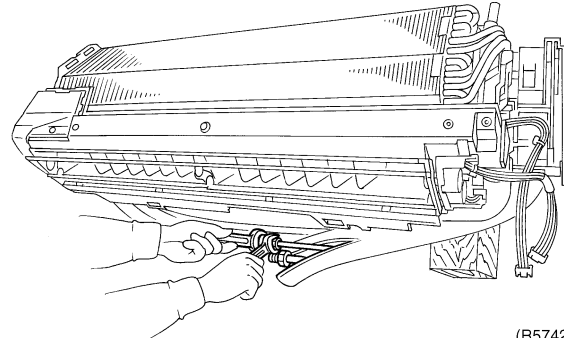
Step	Procedure	Points
1. Remove the refrigerant piping		<p>Preparation</p> <ul style="list-style-type: none"> Remove the drain hose according to "Removal of Drain Hose".
1	<p>Put a wooden block under the indoor unit and pull out the refrigerant piping, drain hose, connection wirings, and so on.</p>  <p>(R5740)</p>	
2	<p>Disconnect the flare nut of the connection of gas pipe with 2 spanners.</p>  <p>(R5741)</p>	<p>Caution In pump-down work, be sure to stop the compressor before disconnecting the refrigerant pipe. If the refrigerant pipe is disconnected with the compressor running and the stop valve being open, air may be sucked in and cause an over-pressure in refrigeration cycle, thus resulting in pipe rupture or accidental injury.</p>
3	<p>Disconnect the flare nut of the connection of liquid pipe with 2 spanners.</p> <p>Caution From the point of view of environmental protection, be sure to use a vacuum pump for air purging.</p>  <p>(R5742)</p>	<ul style="list-style-type: none"> Be careful that remaining drain will not wet the floor. If the drain hose is embedded in the wall, disconnect the drain hose beforehand. Carry out the removal works with 2 pair of spanners.

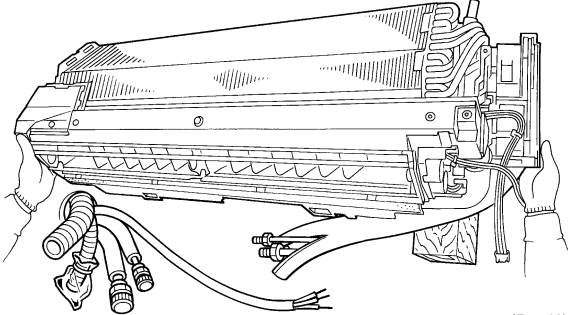
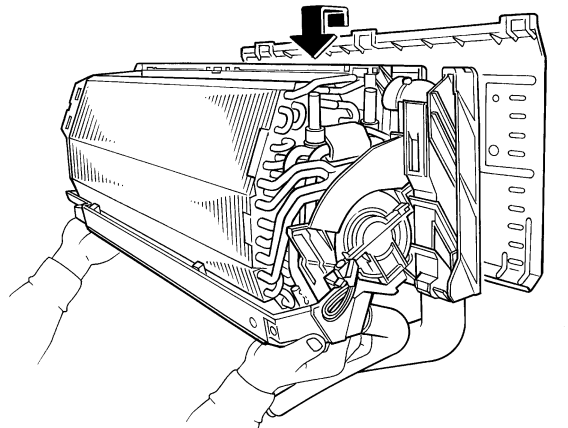
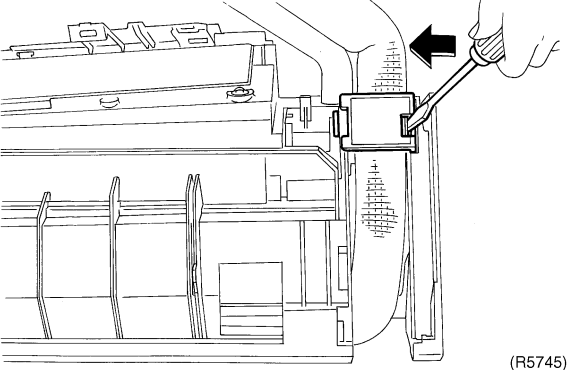
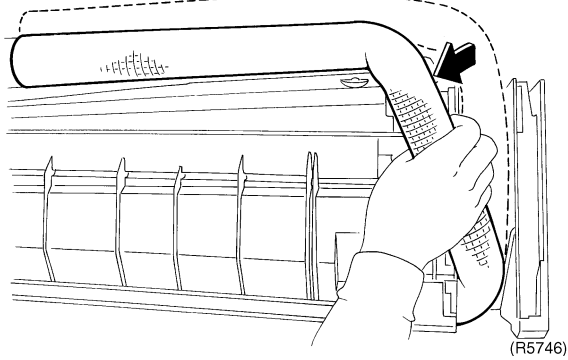
Step	Procedure	Points
<p>2. Remove the indoor unit</p> <p>1 Remove the indoor unit from the installation plate.</p>	 <p>(R5743)</p>  <p>(R5744)</p>	<ul style="list-style-type: none"> When the pipes are disconnected, protect the both openings of pipe side and unit side from entering of moisture.
<p>3. Remove the heat exchanger</p> <p>1 Unfasten the hook of the pipe fixing plate at the back of the unit and pull out the pipe.</p> <p>2 Widen the auxiliary pipe by about 10-20 degrees.</p>	 <p>(R5745)</p>  <p>(R5746)</p>	<ul style="list-style-type: none"> Undo the 2 hooks on the side with a flat screwdriver.

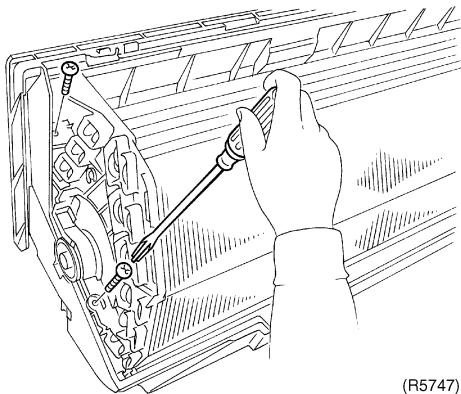
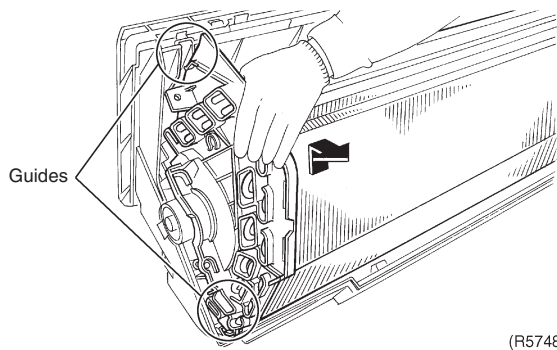
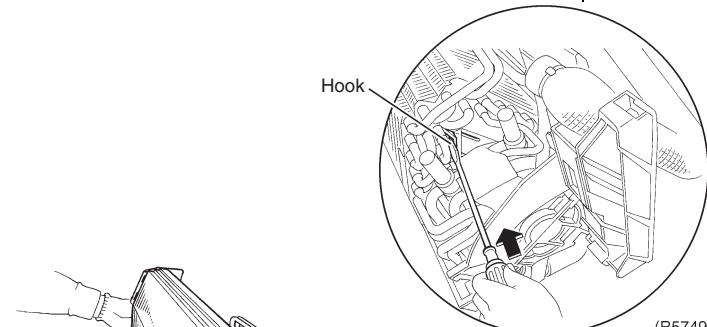
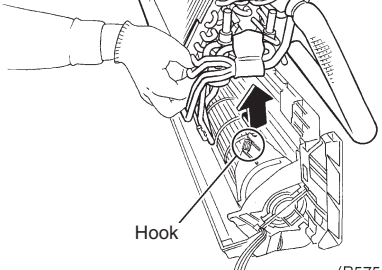
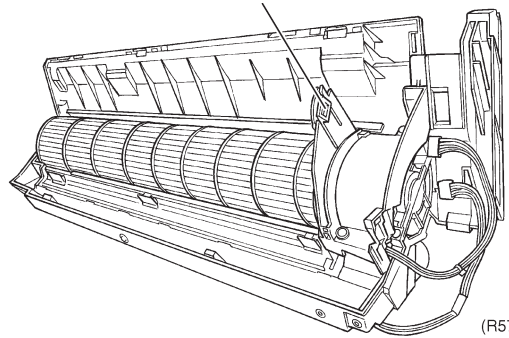
Step	Procedure	Points
3	<p>Loosen the 2 fixing screws for heat exchanger on the left.</p>  <p>(R5747)</p>	
4	<p>Lift the left side of the heat exchanger, and pull towards yourself.</p>  <p>Guides</p> <p>(R5748)</p>	<p>Caution When dismantling or mounting the heat exchanger, be sure to wear gloves or wrap it with cloth before proceeding to the work. (You may be injured by the fins.)</p>
5	<p>Undo the hook through the gap of pipes.</p>  <p>Hook</p> <p>(R5749)</p>	
6	<p>Slide to right to undo the hook and lift the heat exchanger up.</p>  <p>Hook</p> <p>(R5750)</p> <p>Fixing hook for heat exchanger</p>  <p>(R5751)</p>	<p>■ Be careful so the solenoid valve will not be caught in the hook.</p>

1.13 Removal of the Propeller Fan / Fan Motor

Procedure

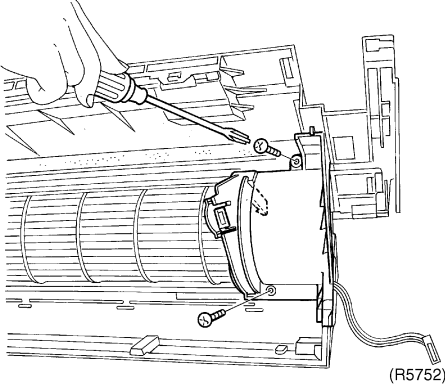
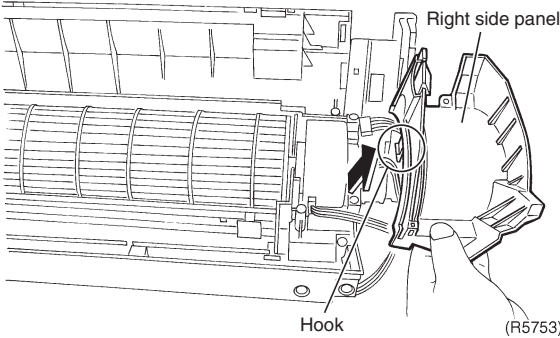
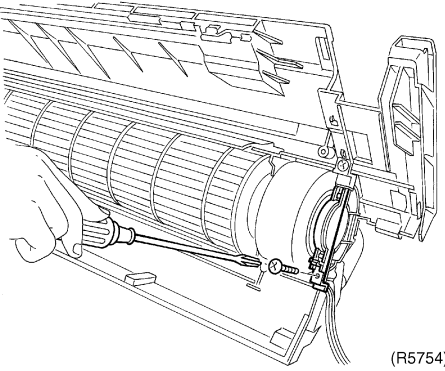
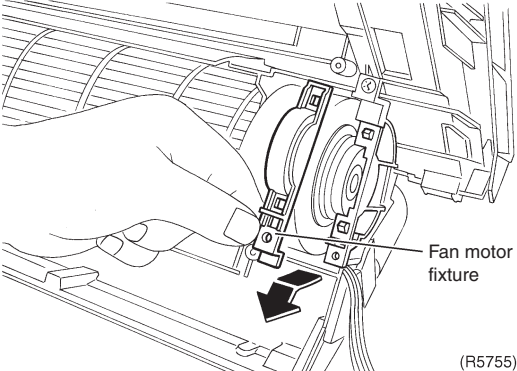

Warning Be sure to wait 10 minutes or more after turning off all power supplies before disassembling work.

Step	Procedure	Points
<p>1. Remove the right side panel</p> <p>1 Loosen the 2 screws of the right side panel.</p> <p>2 Undo the far side hook of the right side panel while inclining toward yourself and remove.</p>	 <p>(R5752)</p>  <p>Right side panel</p> <p>Hook</p> <p>(R5753)</p>	<p>Preparation</p> <ul style="list-style-type: none"> Remove the heat exchanger according to "Removal of the Heat Exchanger".
<p>2. Remove the fan rotor</p> <p>1 Loosen the 2 screws of the fan motor fixture.</p> <p>2 Undo the 2 hooks and remove the fan motor fixture.</p>	 <p>(R5754)</p>  <p>Fan motor fixture</p> <p>(R5755)</p>	

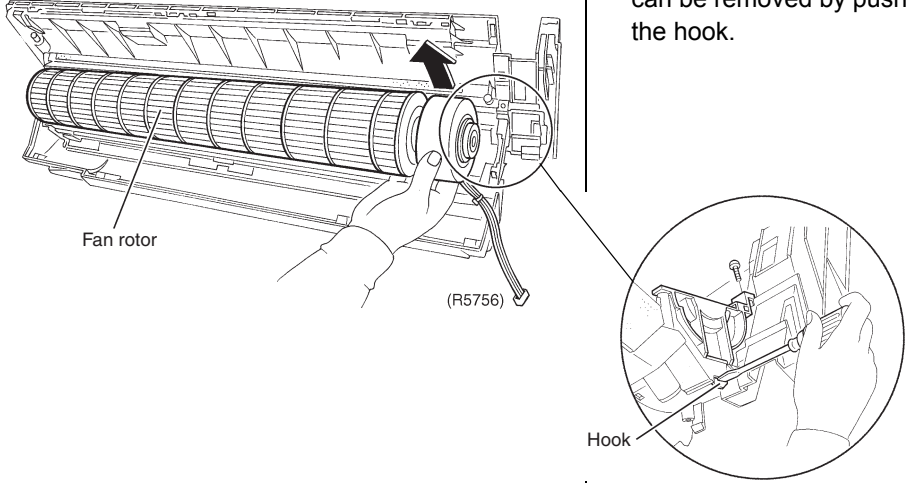
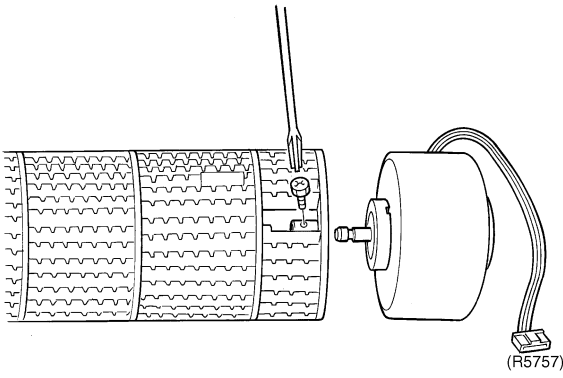
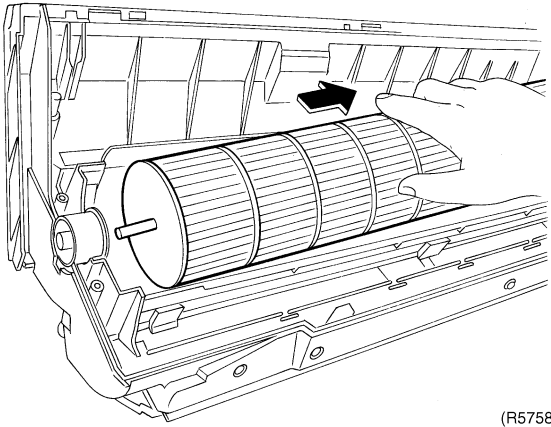
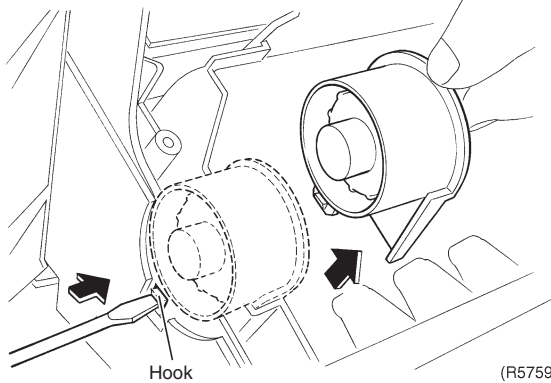
Step	Procedure	Points
3	Remove the fan motor and fan rotor.  <p>Fan rotor</p> <p>(R5756)</p> <p>Hook</p>	<ul style="list-style-type: none"> ■ The fan motor fixture (lower) can be removed by pushing the hook.
3. Remove the fan motor	<ol style="list-style-type: none"> <li data-bbox="212 801 483 898">1 Loosen the fixing screw for fan rotor and fan motor. <li data-bbox="212 936 483 1003">2 Remove the fan motor and fan rotor.  <p>(R5757)</p>	
4. Remove the bearing	<ol style="list-style-type: none"> <li data-bbox="212 1227 483 1261">1 Remove the fan rotor. <li data-bbox="212 1686 483 1753">2 Undo the 1 hook of the bearing.  <p>(R5758)</p>  <p>Hook</p> <p>(R5759)</p>	

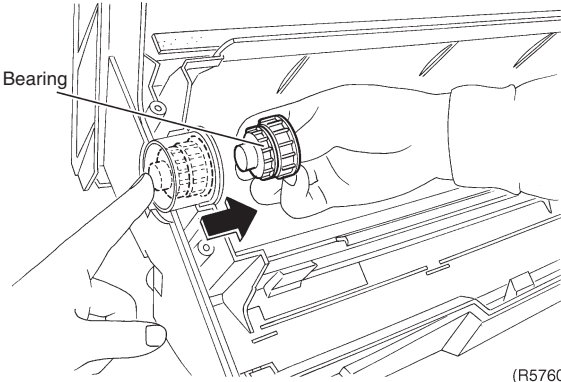
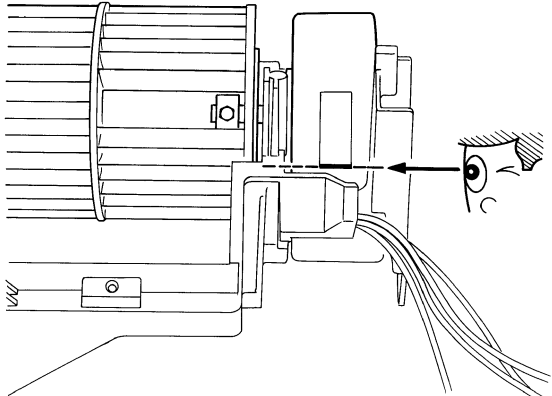
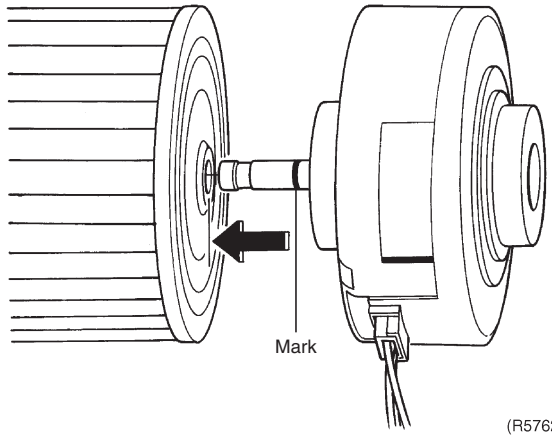
Step	Procedure	Points
3	<p>The bearing is made of rubber. Push it inward firmly and remove it.</p>  <p>(R5760)</p>	
5. How to install the fan motor	<p>1 When assembling, align the mark on the shaft.</p>  <p>(R5761)</p>  <p>(R5762)</p>	

1.14 Removal of Horizontal Blades / Vertical Blades

Procedure

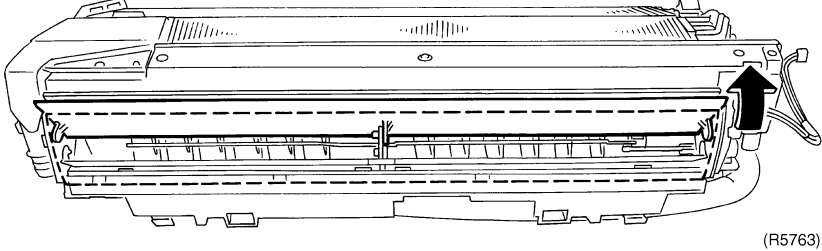
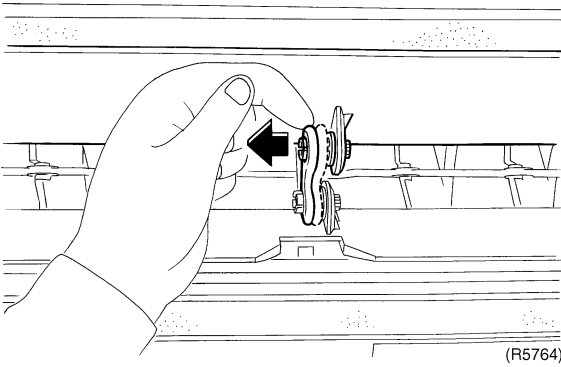
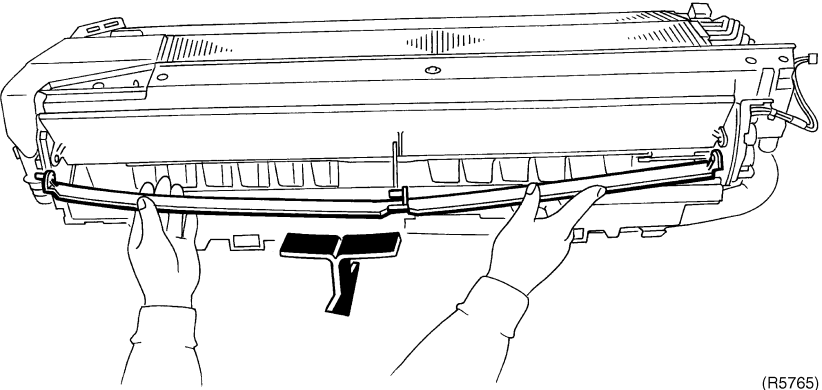
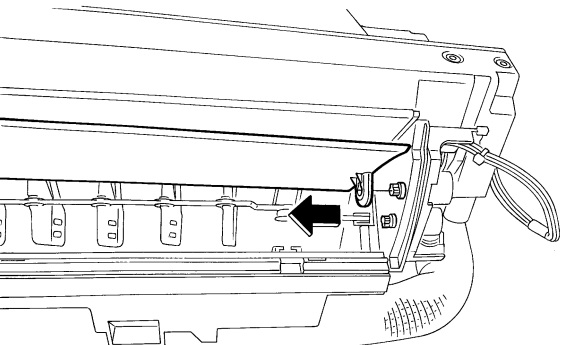

Warning Be sure to wait 10 minutes or more after turning off all power supplies before disassembling work.

Step	Procedure	Points
1. Remove the horizontal blade		
1 Open the horizontal blade (large).	 <p style="text-align: right;">(R5763)</p>	
2 Undo the center fixture for the horizontal blade (large).	 <p style="text-align: right;">(R5764)</p>	<ul style="list-style-type: none"> ■ When installing the horizontal blades, be careful not to put the large and small blades in the wrong position.
3 Undo the left shaft while bending the horizontal blade (small) slightly. Remove the horizontal blade (small).	 <p style="text-align: right;">(R5765)</p>	
4 Undo the right shaft of the horizontal blade (large), and then remove the blade.	 <p style="text-align: right;">(R5766)</p>	<ul style="list-style-type: none"> ■ There is a key alignment mark at the right side.

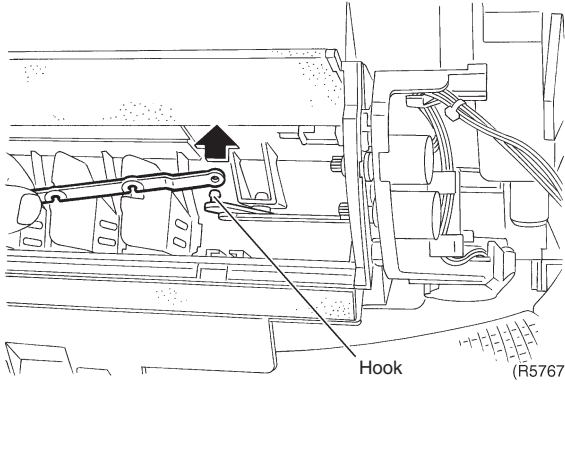
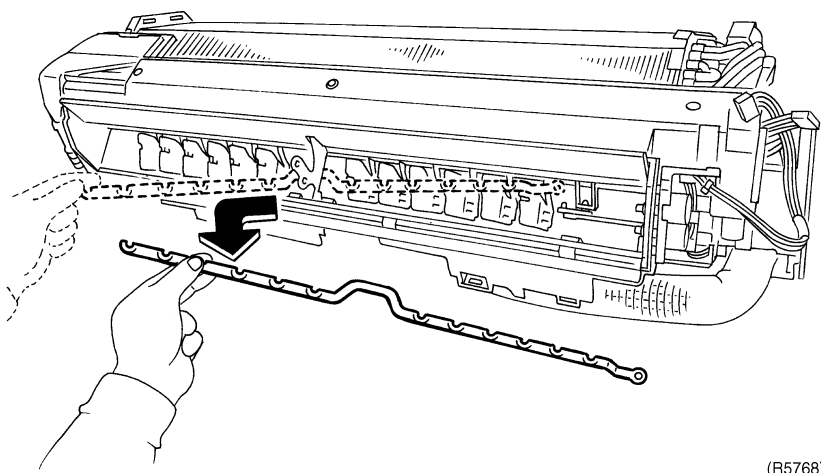
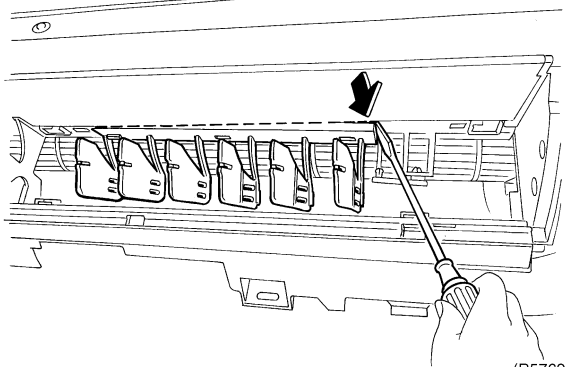
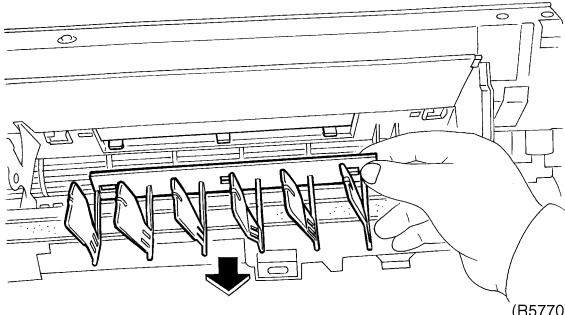
Step	Procedure	Points
<p>2. Remove the interlocking shaft</p>	<p>1 Undo the hook of the interlocking shaft.</p>  <p>2 Remove the interlocking shaft.</p> 	
<p>3. Remove the vertical blades</p>	<p>1 Undo the 3 hooks of the vertical blades with a flat screwdriver.</p>  <p>2 Remove the vertical blades.</p> 	

1.15 Removal of the Streamer Unit

Procedure

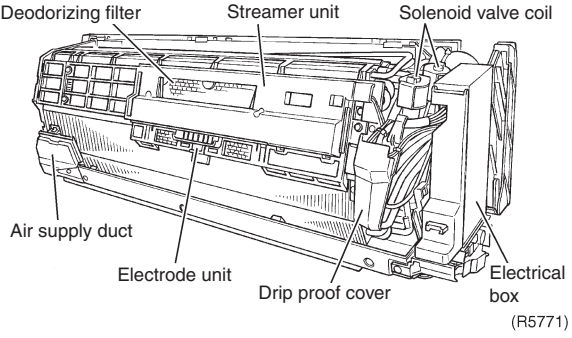
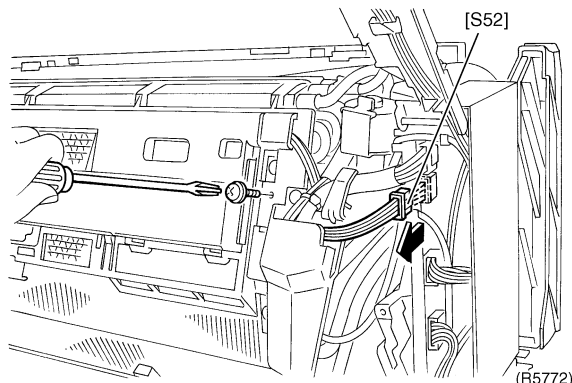
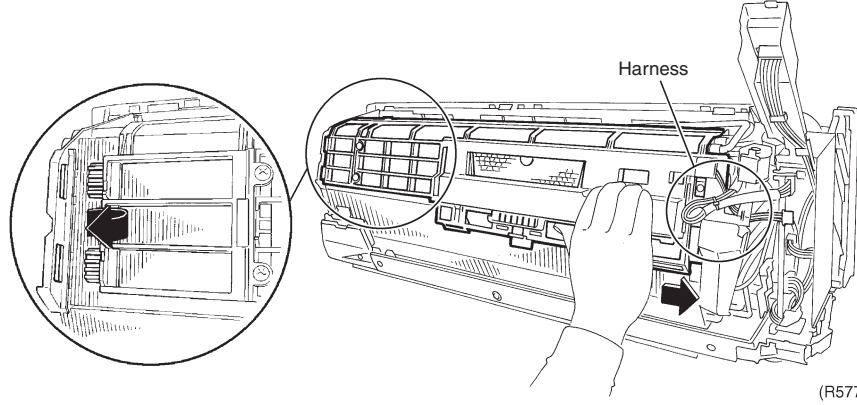
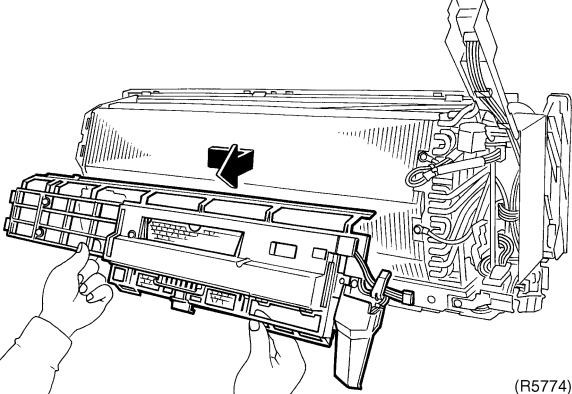

Warning Be sure to wait 10 minutes or more after turning off all power supplies before disassembling work.

Step	Procedure	Points
1.	Remove the streamer unit	
1	<p>Names of parts of the streamer unit.</p>  <p>(R5771)</p>	
2	<p>Open the cover of the electrical box, disconnect the connector for streamer unit [S52], and loosen the 1 screw.</p>  <p>(R5772)</p>	
3	<p>Release the wire harness for solenoid valve coil from drip proof cover.</p>  <p>(R5773)</p>	
4	<p>Slide the streamer unit to the right.</p>	
5	<p>Remove it toward yourself.</p>  <p>(R5774)</p>	

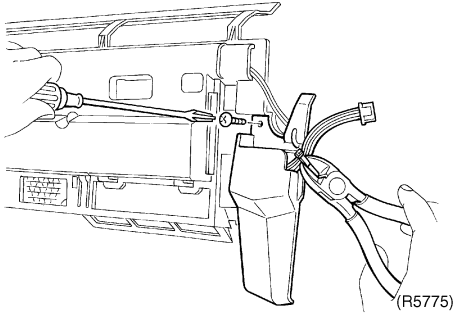
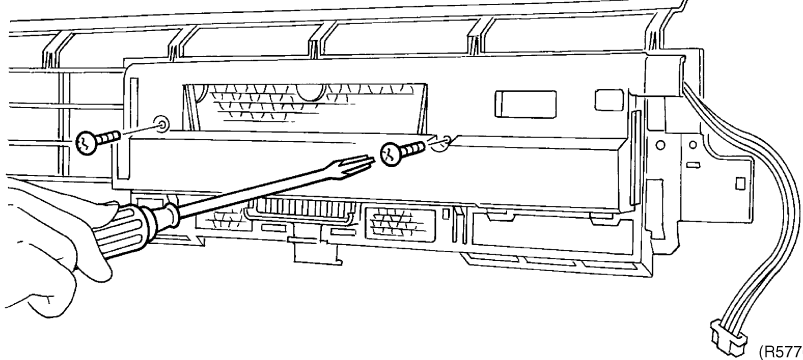
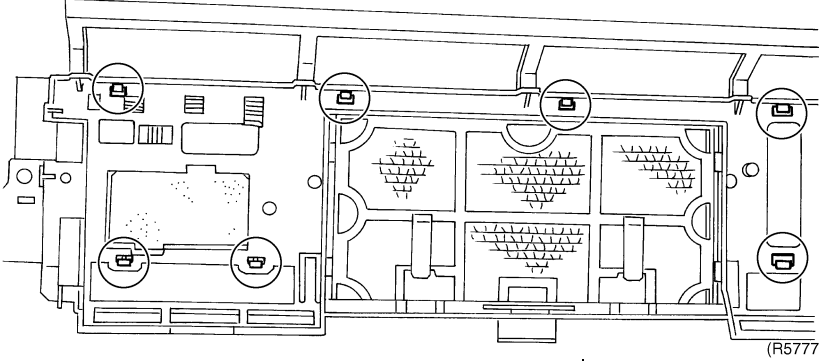
Step	Procedure	Points
6	<p>Cut the clamp and loosen the 1 screw of the drip proof cover.</p> 	
2.	<p>Remove the cover of streamer unit</p> <p>1 Loosen the 2 screws of the cover.</p>  <p style="text-align: right;">:k side (7) (R5776)</p>  <p style="text-align: right;">(R5777)</p>	

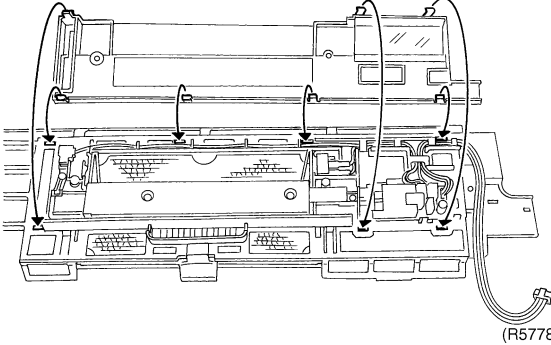
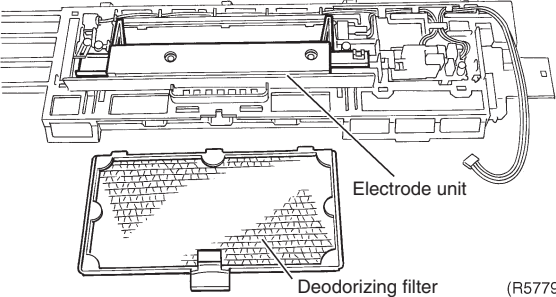
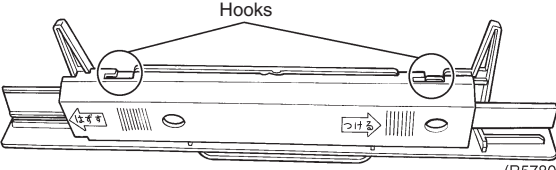
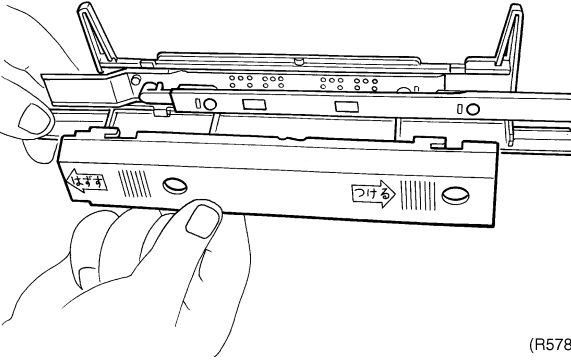
Step	Procedure	Points
2	Turn it back and undo the 7 hooks.	
3. Remove the deodorizing filter and electrode unit	<p data-bbox="212 891 451 981">1 Remove the deodorizing filter and electrode unit.</p>  <p data-bbox="1018 589 1070 607">(R5778)</p> <p data-bbox="212 1193 475 1283">2 Slide the cover of the electrode unit to the left to remove.</p>  <p data-bbox="863 1048 979 1066">Electrode unit</p> <p data-bbox="810 1149 951 1167">Deodorizing filter</p> <p data-bbox="1018 1149 1070 1167">(R5779)</p>  <p data-bbox="730 1245 783 1263">Hooks</p> <p data-bbox="1018 1406 1070 1424">(R5780)</p>  <p data-bbox="1026 1821 1078 1839">(R5781)</p>	<ul style="list-style-type: none"> <li data-bbox="1102 824 1457 880">■ See page 218 for removal of the deodorizing filter. <li data-bbox="1102 1193 1441 1249">■ When assembling, slide to the right.

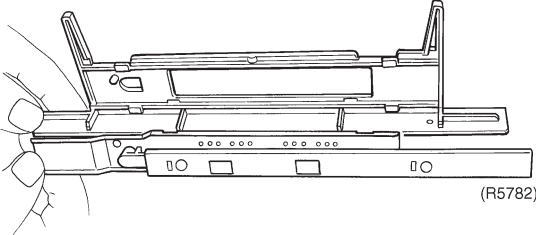
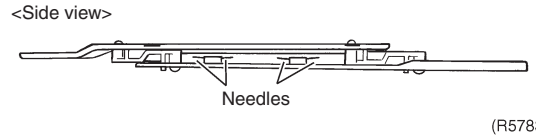
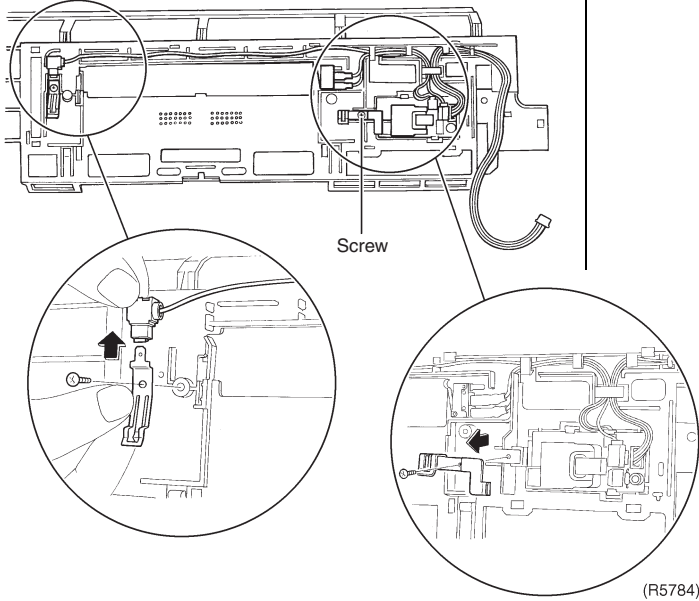
Step	Procedure	Points
3	<p>Electrode for discharging.</p>  <p><Side view></p> 	
4. Remove the streamer unit PCB		
1	<p>Loosen the 1 screw of the electrode plate with a precise screwdriver.</p> 	

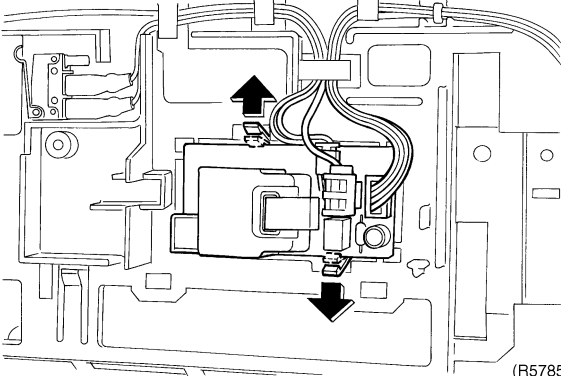
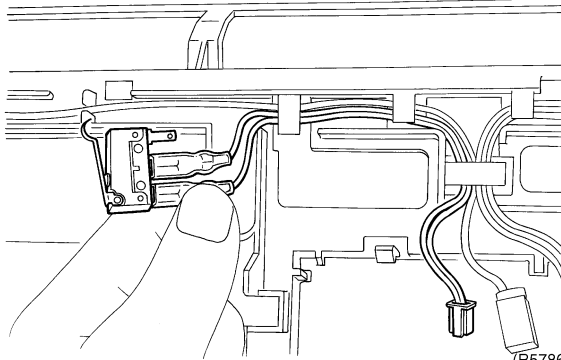
Step	Procedure	Points
2	Undo the 2 hooks of the streamer unit PCB.  (R5785)	
5. Disconnect the limit switch		
1	Disconnect the limit switch.  (R5786)	

2. Outdoor Unit

2.1 Removal of the Humidify Unit

Procedure



Warning Be sure to wait 10 minutes or more after turning off all power supplies before disassembling work.

Step	Procedure	Points
1. External appearance	<p>(R5787)</p> <p>(R5788)</p>	
2. Remove the stop valve cover	<p>1 Loosen the 1 screw of the stop valve cover and slide the cover downward to remove.</p> <p>(R5789)</p>	<p>■ There is no drain unit.</p>

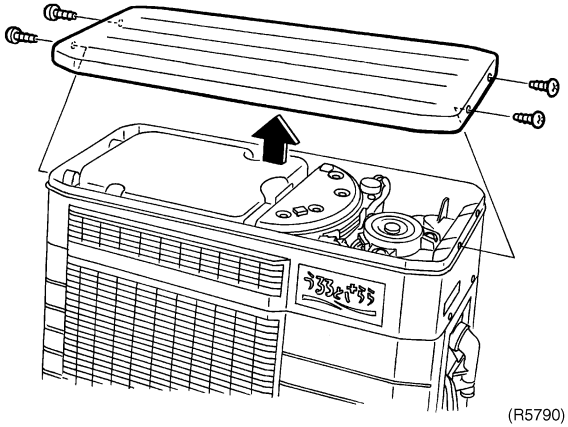
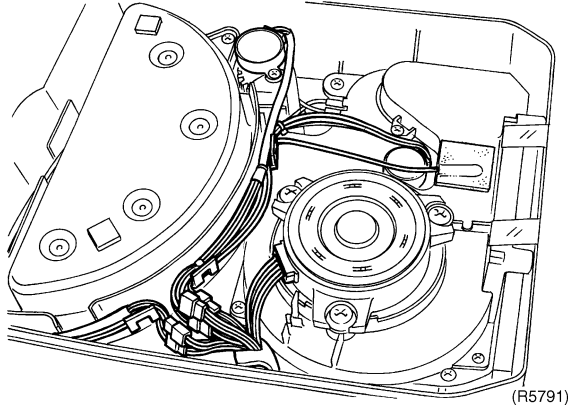
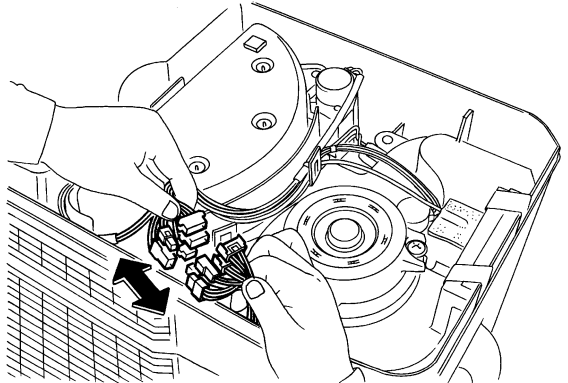
Step	Procedure	Points
<p>3. Remove the top panel</p> <p>1 Loosen the 4 screws.</p>	 <p>(R5790)</p>	
<p>4. Remove the humidify unit</p> <p>1 The figure shows the arrangement of the relay harness.</p> <p>2 Disconnect the 5 relay connectors.</p>	 <p>(R5791)</p>  <p>(R5792)</p>	<p>■ Be sure to wait 10 minutes or more after turning off the power supply before disconnecting the connectors.</p>

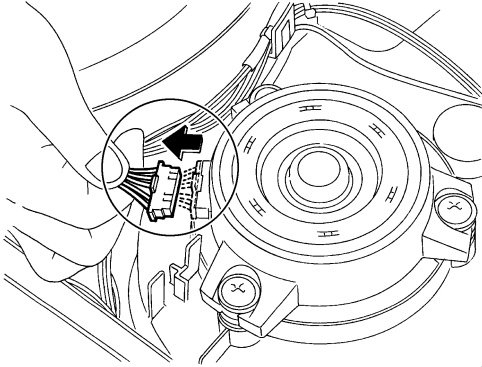
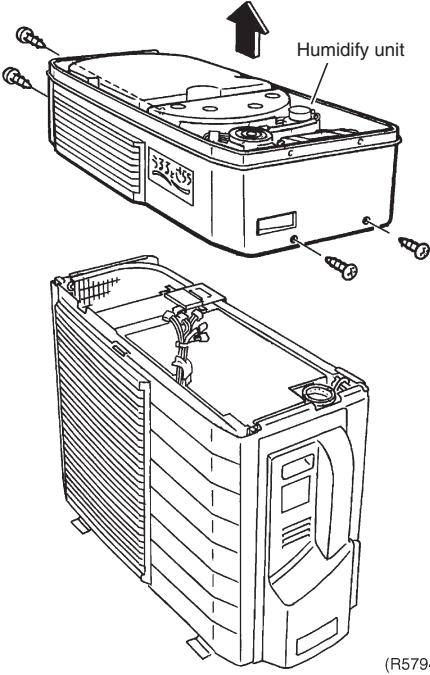
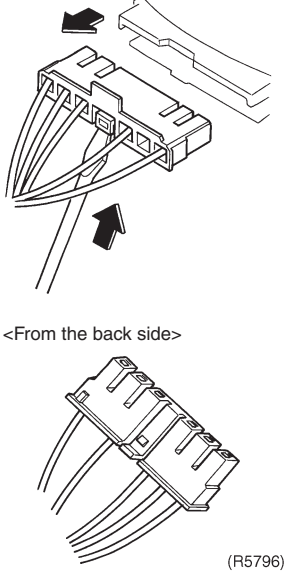
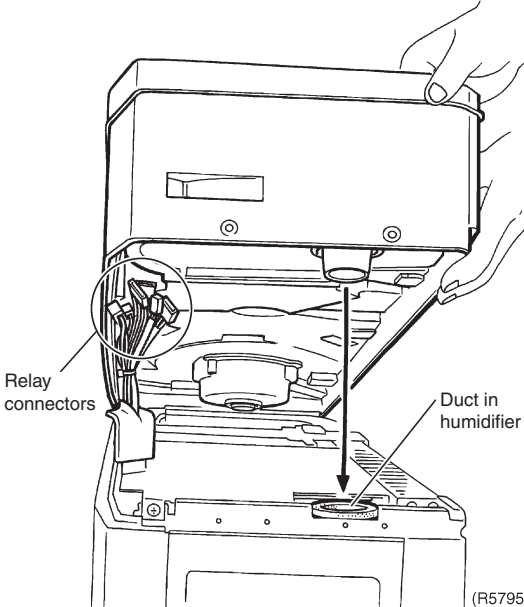
Step	Procedure	Procedure	Points
3	Disconnect the connector for the humidify fan motor.	 <p>(R5793)</p>	<ul style="list-style-type: none"> ■ Be sure to wait 10 minutes or more after turning off the power supply before disconnecting the connectors. ■ Pull out the connector while pushing up the hook on the bottom side.
4	Loosen the 4 screws of humidify unit and lift it up to remove.	 <p>(R5794)</p>	 <p><From the back side></p> <p>(R5796)</p>
5	The figure shows the positions of the duct in humidifier and the relay connectors.	 <p>(R5795)</p>	<ul style="list-style-type: none"> ■ When installing the humidify unit, do not forget to connect the relay connectors.

2.2 Removal of the Heater Assembly / Humidifying Rotor (Moisture Absorption Element) / Humidifying Rotor Motor

Procedure



Warning Be sure to wait 10 minutes or more after turning off all power supplies before disassembling work.

Step	Procedure	Points
1. Inside structure of humidifying unit		<p>Preparation</p> <ul style="list-style-type: none"> Remove the top panel according to "Removal of Humidify Unit".
2. Remove the heater assembly	<p>1 Loosen the 4 screws of the connecting duct on absorption side.</p> <p>2 Detach the lead wire for humidifying rotor motor from the groove.</p>	

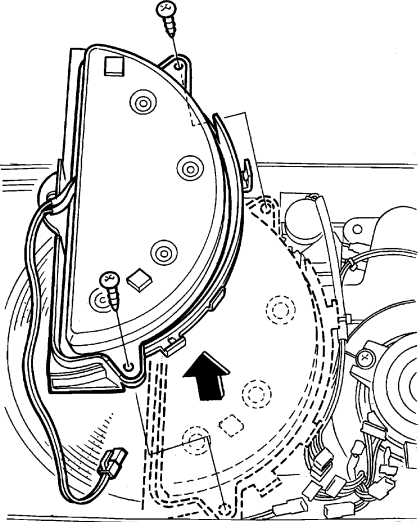
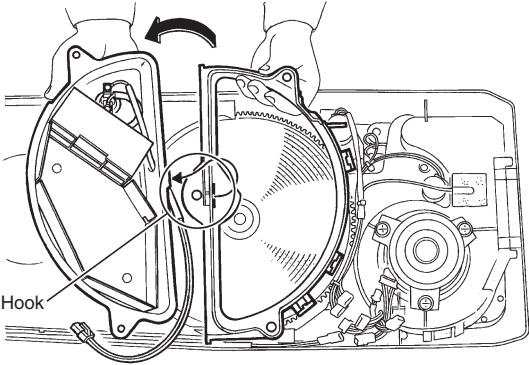
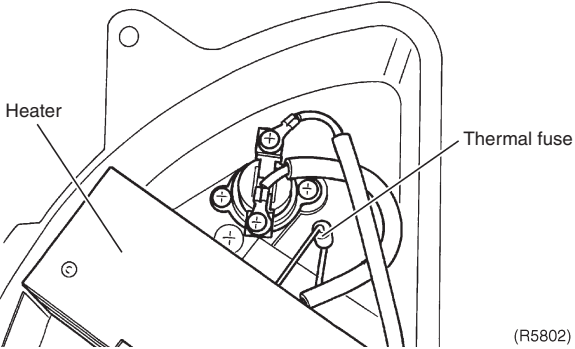
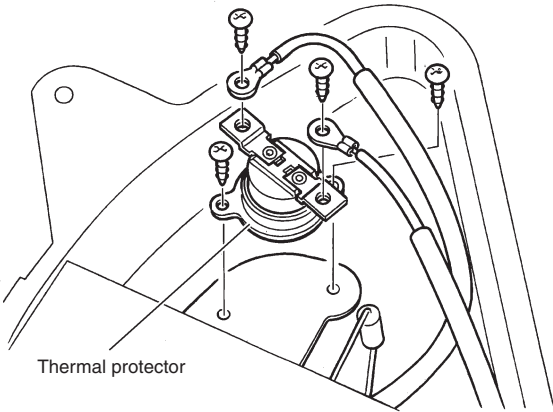
Step	Procedure	Points
3	<p>Loosen the 2 screws to remove the heater assembly.</p>  <p>(R5800)</p>	
4	<p>Undo the 1 hook.</p>  <p>(R5801)</p>	
5	<p>Inside of the heater assembly.</p>  <p>(R5802)</p>	<ul style="list-style-type: none"> ■ Heater and thermal fuse should be replaced as the heater assembly.
6	<p>Loosen the 4 screws of the thermal protector.</p>  <p>(R5803)</p>	<ul style="list-style-type: none"> ■ The thermal protector is removable. Remove it before the lead wire.

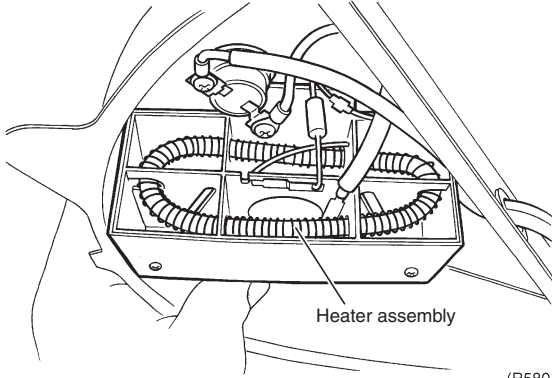
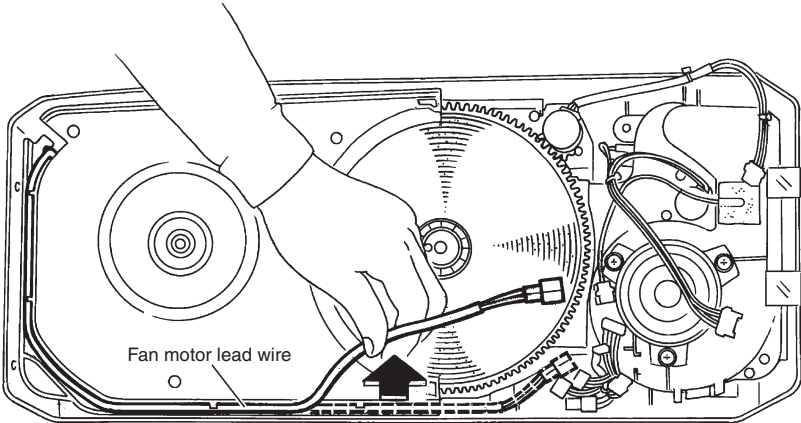
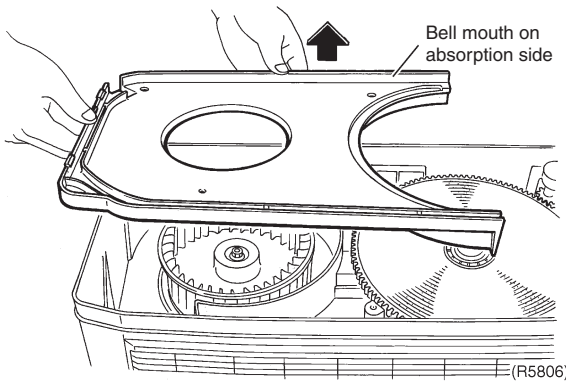
Step	Procedure	Points
7	Inside structure of the heater assembly.  <p style="text-align: center;">Heater assembly</p> <p style="text-align: right;">(R5804)</p>	
3.	Remove the humidifying rotor.	
1	Detach the lead wire for fan motor from the groove.  <p style="text-align: center;">Fan motor lead wire</p> <p style="text-align: right;">(R5805)</p>	
2	Remove the bell mouth on absorption side.  <p style="text-align: center;">Bell mouth on absorption side</p> <p style="text-align: right;">(R5806)</p>	

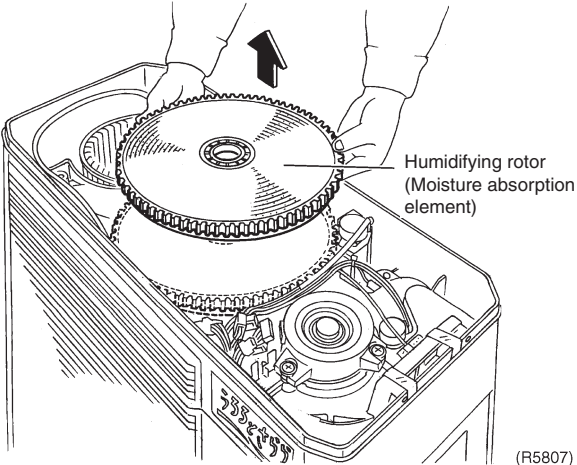
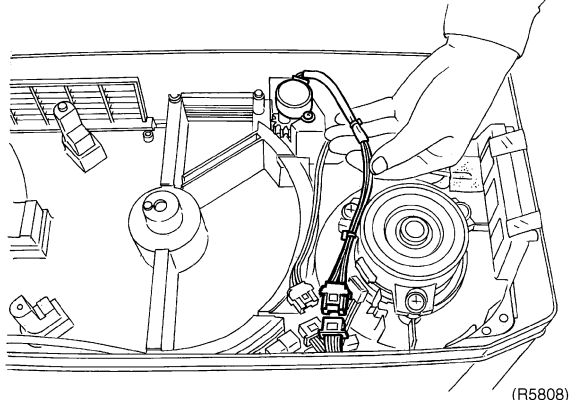
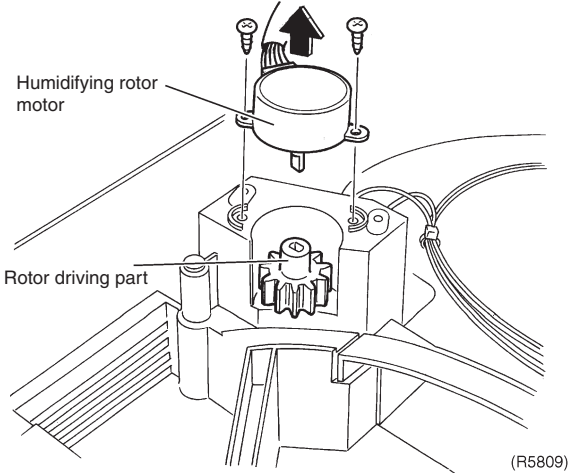
Step	Procedure	Points
3	<p>Lift the humidifying rotor up to remove.</p> 	<ul style="list-style-type: none"> ■ A heat catalyst (black) is applied on the upper side.
4.	<p>Remove the humidifying rotor motor</p>	
1	<p>The figure shows the connector for rotor motor.</p> 	
2	<p>Loosen the 2 screws of the rotor motor.</p> 	

2.3 Removal of the Humidifying Assembly

Procedure

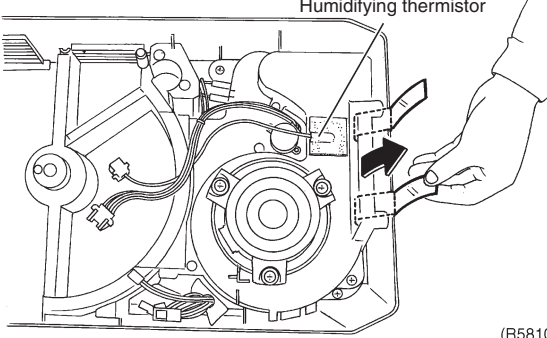
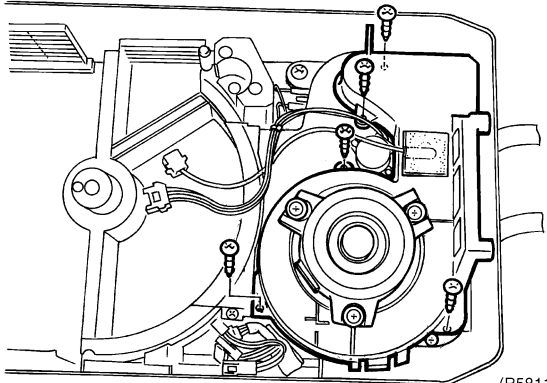
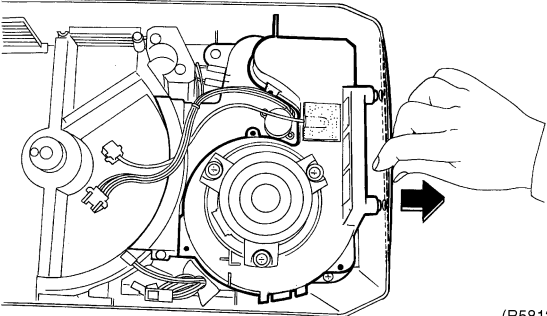

Warning Be sure to wait 10 minutes or more after turning off all power supplies before disassembling work.

Step	Procedure	Points
1. Remove the humidifying fan assembly		<p>Preparation</p> <ul style="list-style-type: none"> Remove the humidify unit according to "Removal of Humidify Unit".
1 Detach the 2 seal materials.	 <p>(R5810)</p>	
2 Loosen the 5 screws of the humidifying fan assembly.	 <p>(R5811)</p>	
3 Undo the 2 hooks on the right.	 <p>(R5812)</p>	<ul style="list-style-type: none"> Undo the hooks while bending the right side panel.

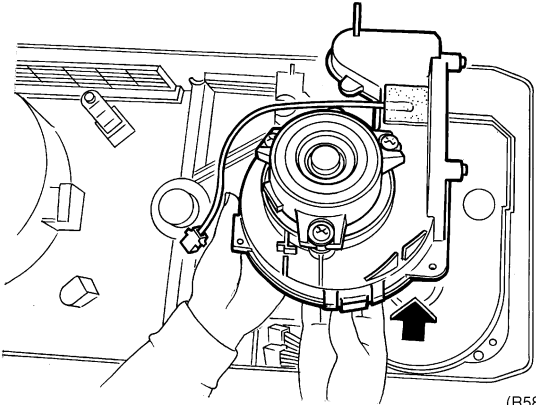
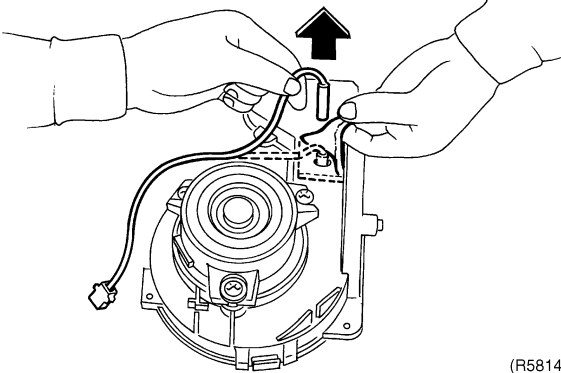
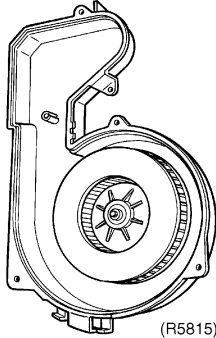
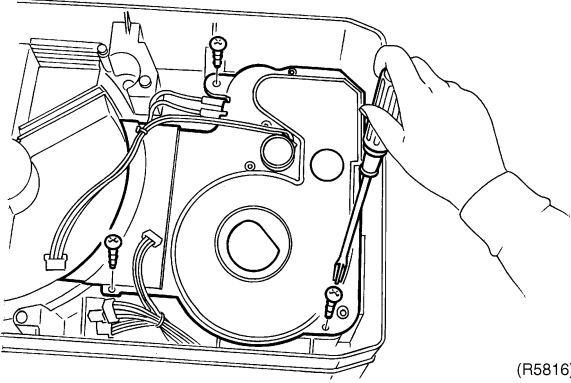
Step	Procedure	Procedure	Points
4	Remove the humidifying assembly.	 <p>(R5813)</p>	<ul style="list-style-type: none"> ■ The humidifying assembly should be replaced as an assembly set. (Disassembling of the assembly can cause a noise.)
5	Detach the seal material to release the humidifying thermistor.	 <p>(R5814)</p>	 <p>(R5815)</p> <ul style="list-style-type: none"> ■ Inside structure of the upper part of the humidifying assembly.
2.	Remove the air supply and exhaust changeover damper	 <p>(R5816)</p>	
1	Loosen the 3 screws of the air supply and exhaust changeover damper.		

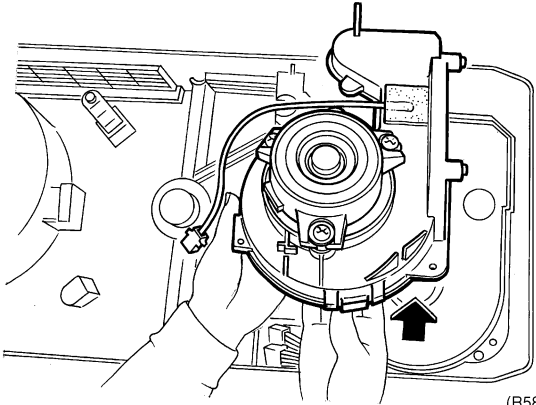
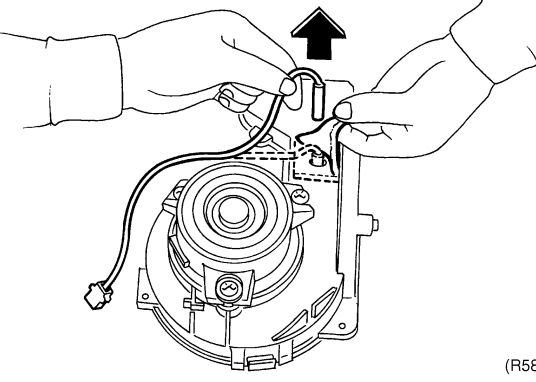
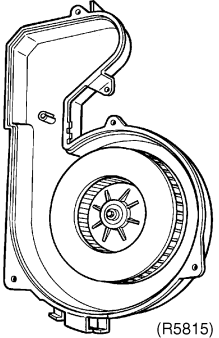
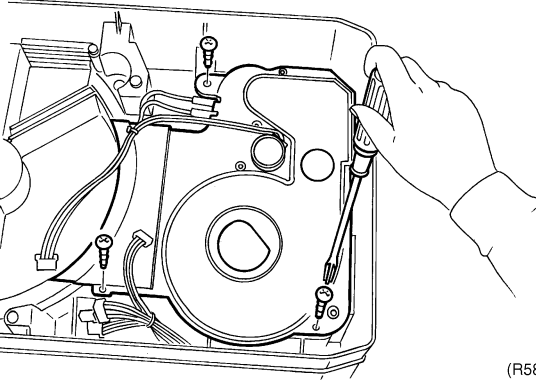
Step	Procedure	Procedure	Points
4	Remove the humidifying assembly.	 <p>(R5813)</p>	<ul style="list-style-type: none"> ■ The humidifying assembly should be replaced as an assembly set. (Disassembling of the assembly can cause a noise.)
5	Detach the seal material to release the humidifying thermistor.	 <p>(R5814)</p>	 <p>(R5815)</p> <ul style="list-style-type: none"> ■ Inside structure of the upper part of the humidifying assembly.
2.	Remove the air supply and exhaust changeover damper	 <p>(R5816)</p>	
1	Loosen the 3 screws of the air supply and exhaust changeover damper.		

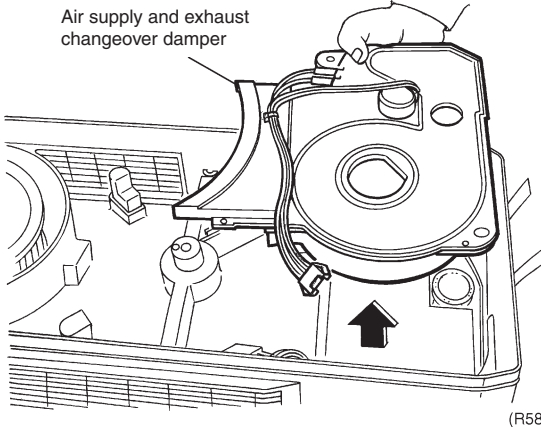
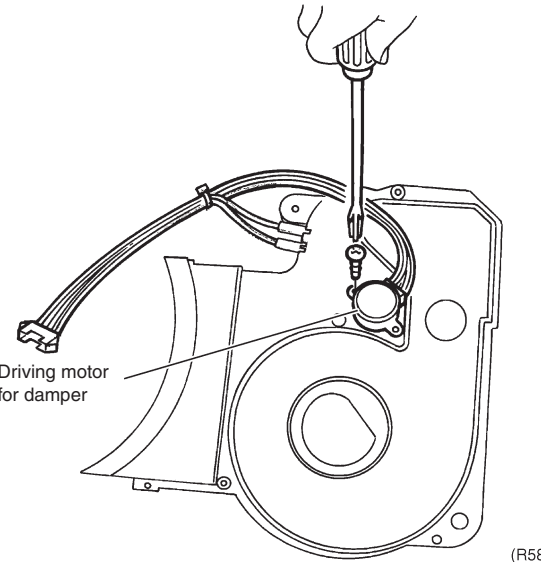
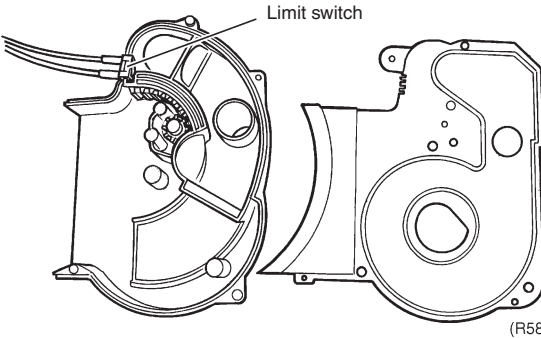
Step	Procedure	Points
2	<p>Lift the air supply and exhaust changeover damper to remove.</p>  <p>Air supply and exhaust changeover damper</p> <p>(R5817)</p>	
3	<p>Loosen the 1 screw of the driving motor for damper.</p>  <p>Driving motor for damper</p> <p>(R5818)</p>  <p>Limit switch</p> <p>(R5819)</p>	

2.4 Removal of the Moisture Absorption Fan Motor

Procedure

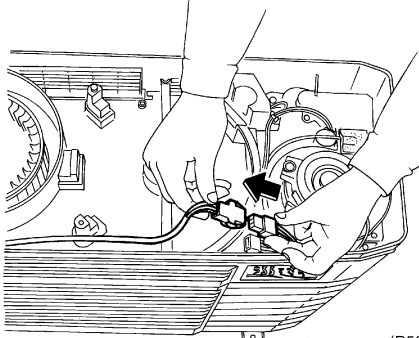
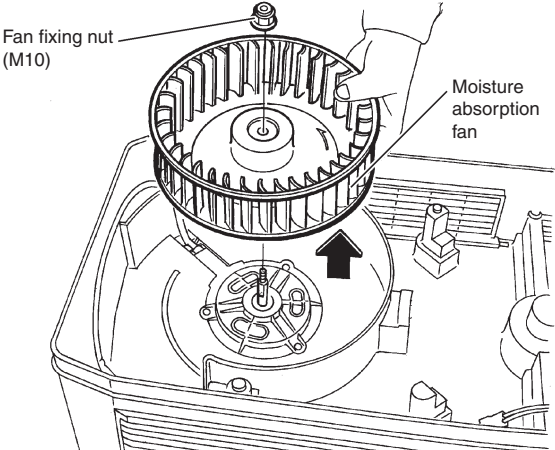
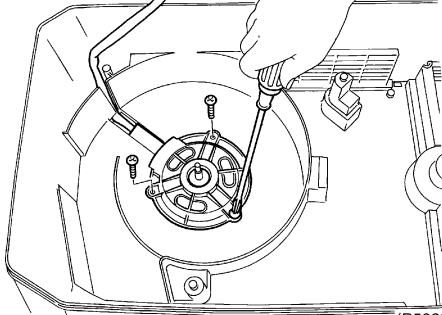
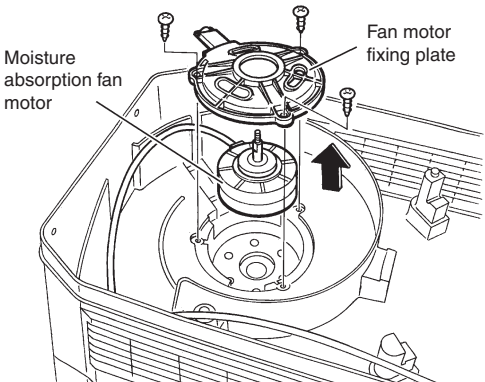
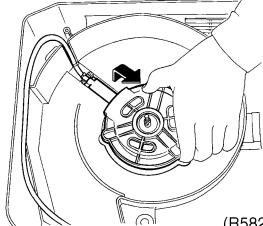

Warning Be sure to wait 10 minutes or more after turning off all power supplies before disassembling work.

Step	Procedure	Points
1. Remove the moisture absorption fan	<p>1 Disconnect the connector for fan motor and remove the bell mouth on absorption side.</p>  <p>(R5820)</p> <p>2 Loosen the fan fixing nut (M10) of the moisture absorption fan and remove.</p>  <p>(R5821)</p>	<p>Preparation</p> <ul style="list-style-type: none"> ■ Remove the humidifying rotor according to "Removal of Humidifying Rotor". ■ When assembling, align the ▼ mark and D cut of the motor shaft.
2. Remove the moisture absorption fan motor	<p>1 Loosen the 3 screws of the fan motor fixing plate.</p>  <p>(R5822)</p> <p>2 Remove the moisture absorption fan motor.</p>  <p>(R5823)</p>	<ul style="list-style-type: none"> ■ Lift the fixing plate first and pull out.  <p>(R5824)</p>

2.5 Removal of the Propeller Fan / Fan Motor

Procedure

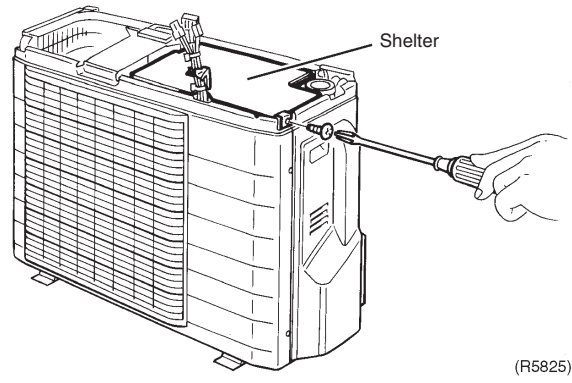
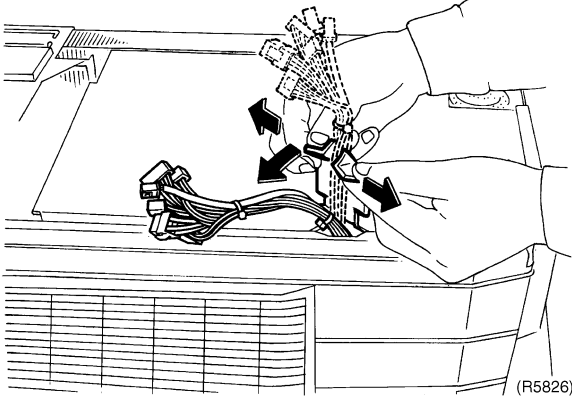
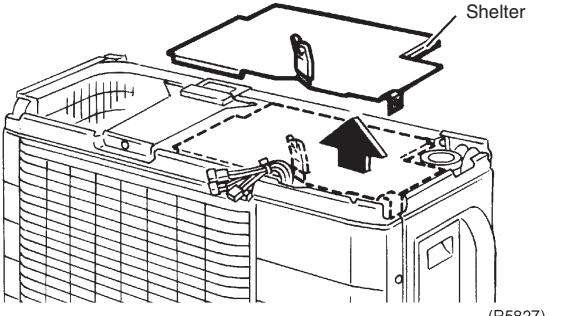
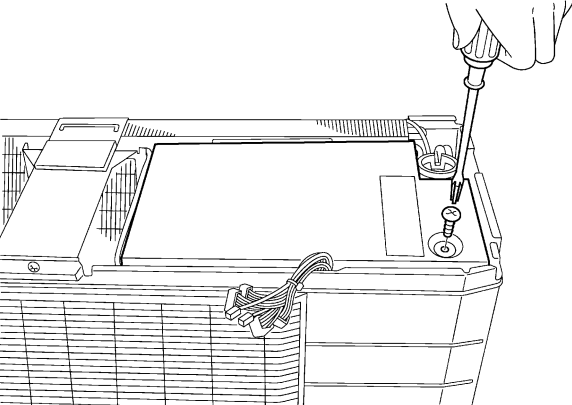

Warning Be sure to wait 10 minutes or more after turning off all power supplies before disassembling work.

Step	Procedure	Points
<p>1. Remove the shelter</p> <p>1 Loosen the 1 screw of the shelter.</p> <p>2 Open the fixing plate and detach the harnesses.</p> <p>3 Remove the shelter.</p>	 <p>(R5825)</p>  <p>(R5826)</p>  <p>(R5827)</p>	<p>Preparation</p> <ul style="list-style-type: none"> ■ Remove the humidify unit according to "Removal of Humidify Unit". ■ Be careful not to forget to install, not to lose, and not to break the shelter and electrical box cover.
<p>2. Remove the electrical box (cover).</p> <p>1 Loosen the 1 screw of the electrical box (cover).</p>	 <p>(R5828)</p>	

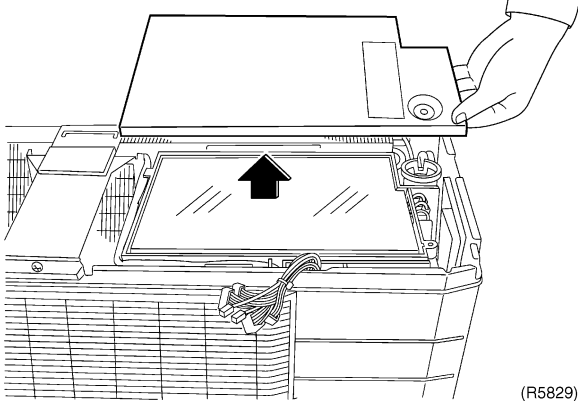
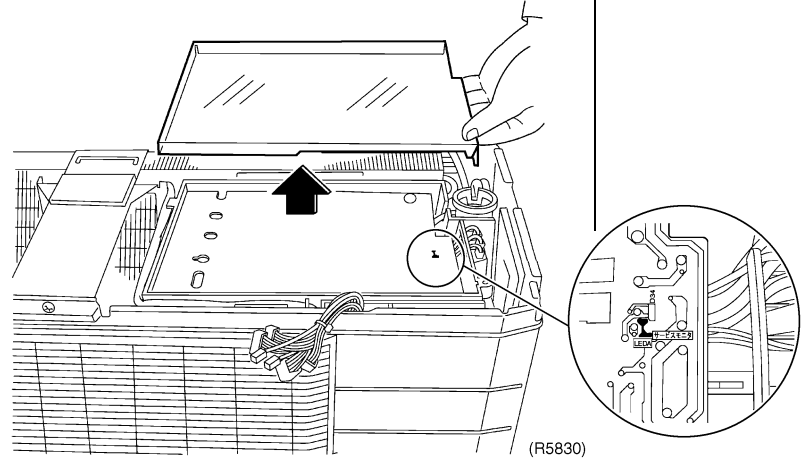
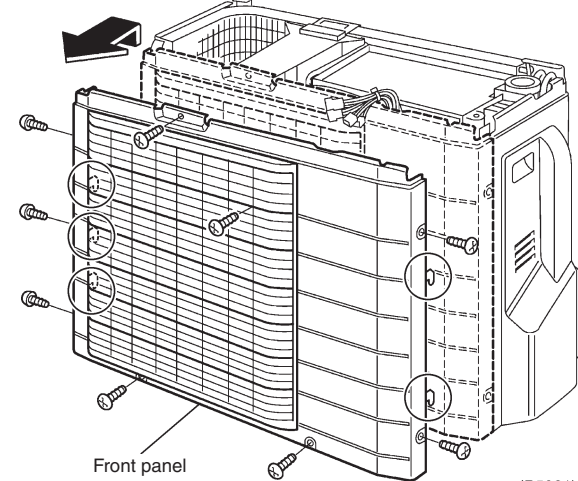
Step	Procedure	Points
2	Lift the electrical box (cover) and remove.  (R5829)	
3.	Remove the drip proof cover 1 Lift the drip proof cover and remove.  (R5830)	<ul style="list-style-type: none"> ■ Service monitor (LED A). ■ Check the LED from the slit.
4.	Remove the front panel 1 Loosen the 9 screws of the front panel. There are 5 hooks in total of right and left.  (R5831)	

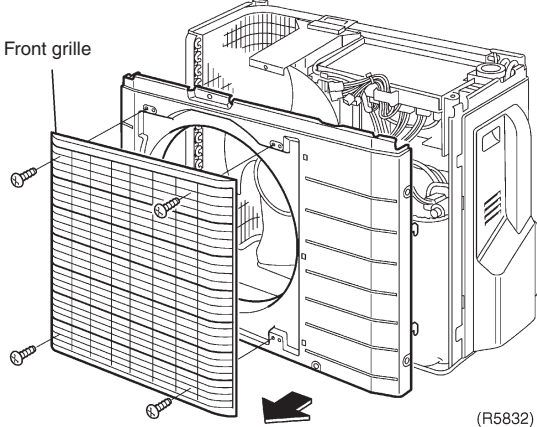
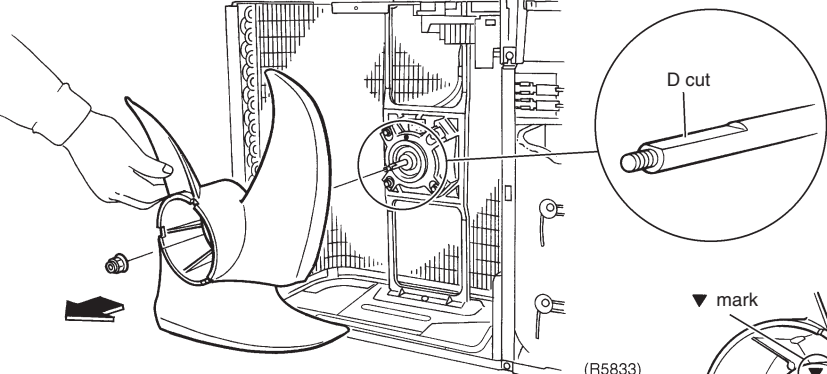
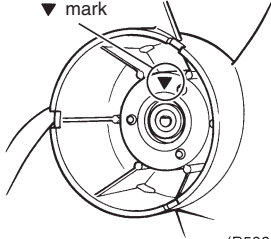
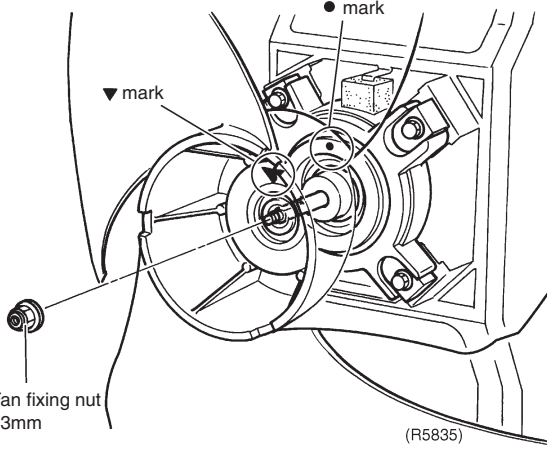
Step	Procedure	Points
2	<p>Loosen the 4 screws to remove the front grille.</p>  <p>Front grille</p> <p>(R5832)</p>	
5.	<p>Remove the propeller fan</p> <p>1 Loosen the fan fixing nut and remove the propeller fan.</p>  <p>D cut</p> <p>(R5833)</p>  <p>v mark</p> <p>(R5834)</p>  <p>v mark</p> <p>• mark</p> <p>Fan fixing nut 13mm</p> <p>(R5835)</p>	<ul style="list-style-type: none"> ■ When assembling, align the ▼ mark of the propeller fan and D cut of the motor shaft. ■ When assembling the fan motor, let the ● mark go upper. (The direction of the lead wire outlet.) ■ Loosen the fan fixing nut with the 13mm spanner.

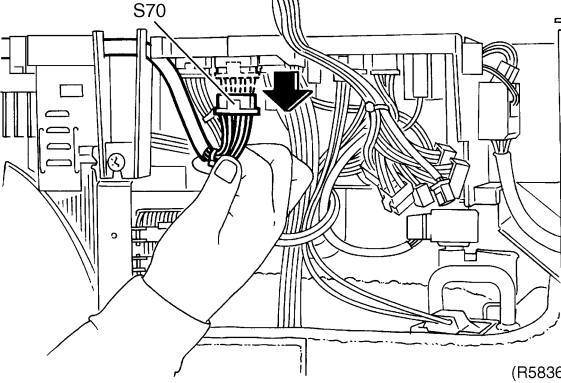
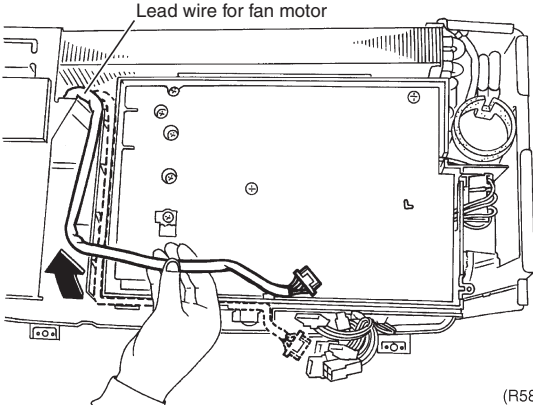
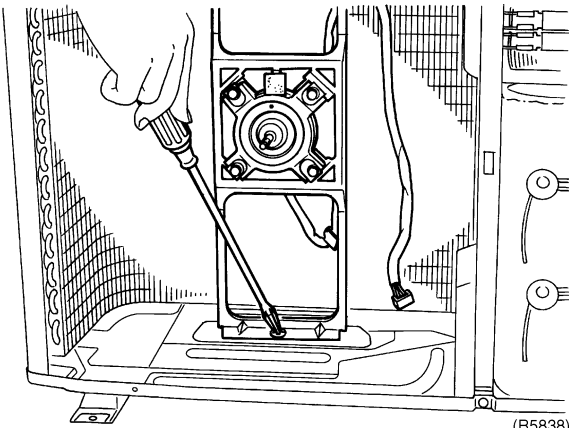
Step	Procedure	Points
6. Remove the fan motor		
1	<p>Disconnect the fan motor connector [S70] from PCB.</p>  <p>(R5836)</p>	
2	<p>Detach the lead wire for fan motor and pass the lead wire downward through the opening.</p>  <p>(R5837)</p>	
3	<p>Loosen the 1 screw of the fan motor fixing plate.</p>  <p>(R5838)</p>	

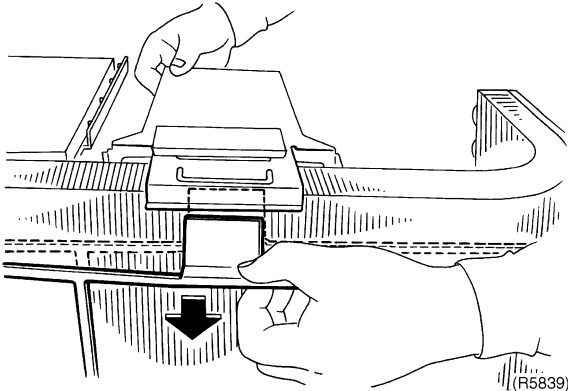
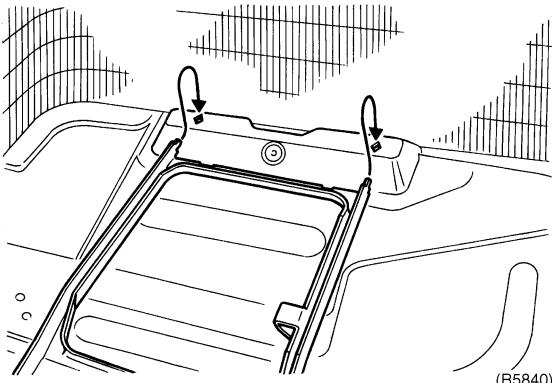
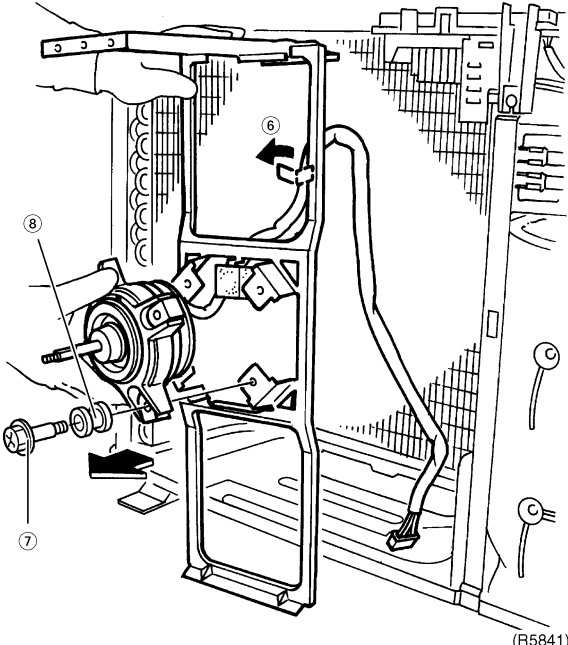
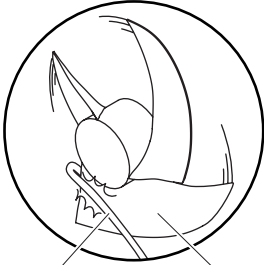
Step	Procedure	Points
4	<p>Detach the upper part of the fan motor fixing plate.</p>  <p>(R5839)</p>	<p>■ Heat exchanger fin</p>
5	<p>Fan motor fixing plate has the 2 hooks on lower part.</p>  <p>(R5840)</p>	
6	<p>Undo the fixing hook for lead wire and detach the lead wire.</p>	
7	<p>Loosen the 4 screws of the fan motor.</p>	
8	<p>Pull out the rubber vibration isolators sideward.</p>  <p>(R5841)</p>	 <p>Lead wire Propeller fan (R3249)</p> <p>■ When assembling, put the lead wire through the back of the motor. (so as not to be entangled with the propeller fan)</p>

2.6 Removal of the Duct in Humidifier

Procedure



Warning Be sure to wait 10 minutes or more after turning off all power supplies before disassembling work.

Step	Procedure	Points
1. Remove the duct in humidifier	<p>(R5842)</p>	
2	<p>Loosen the 1 screw of the duct in humidifier.</p> <p>(R5843)</p>	<p>■ When assembling, make sure to catch the hook.</p>

2.7 Removal of the Electrical Box

Procedure



Warning Be sure to wait 10 minutes or more after turning off all power supplies before disassembling work.

Step	Procedure	Points
1. Disconnect the wire harnesses of the PCB		<p>Preparation</p> <ul style="list-style-type: none"> Remove the front panel according to "Removal of Propeller Fan / Fan Motor".
1 Detach the harnesses for humidify unit from the hook.	<p>(R5844)</p>	
2 Disconnect the connector for fan motor [S70] from the PCB.	<p>(R5845)</p>	
3 Disconnect the connector for humidifying fan motor [S72].	<p>(R5846)</p>	
4 Disconnect the connector for four way valve coil [S80].	<p>(R5847)</p>	

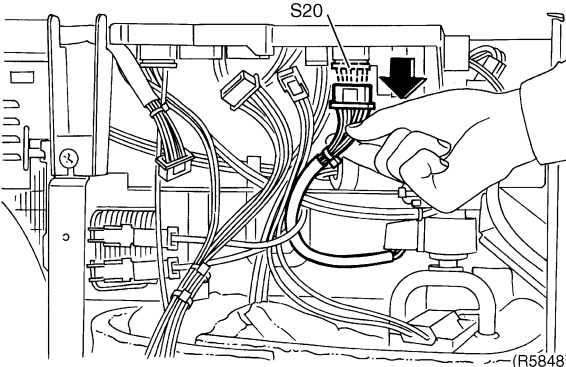
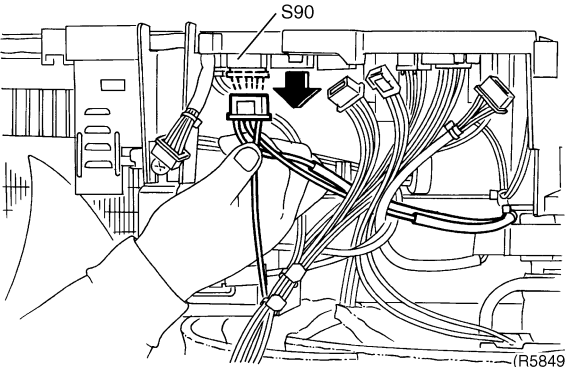
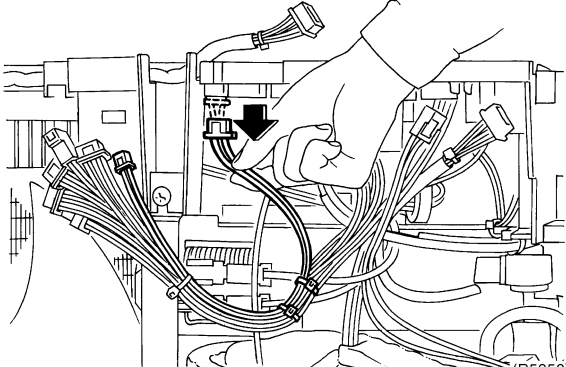
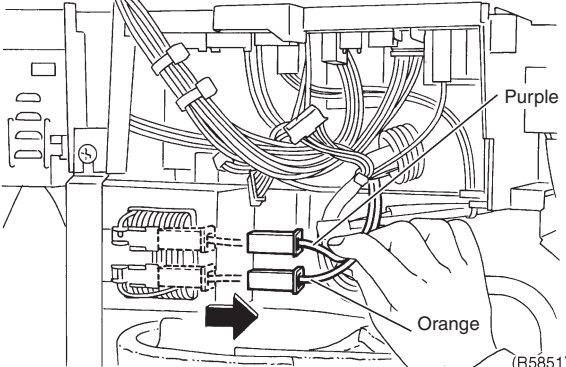
Step	Procedure	Points
5	<p>Disconnect the connector for expansion valve coil [S20].</p>  <p>(R5848)</p>	
6	<p>Disconnect the connector for thermistor assembly [S90].</p>  <p>(R5849)</p>	<ul style="list-style-type: none"> ■ Thermistor assembly is in a set of 3 thermistors. (Outdoor air, heat exchanger, and discharge pipe thermistors)
7	<p>Disconnect the connector for humidifying thermistor [S91].</p>  <p>(R5850)</p>	
8	<p>Disconnect the Faston terminal from the reactor.</p>  <p>(R5851)</p>	

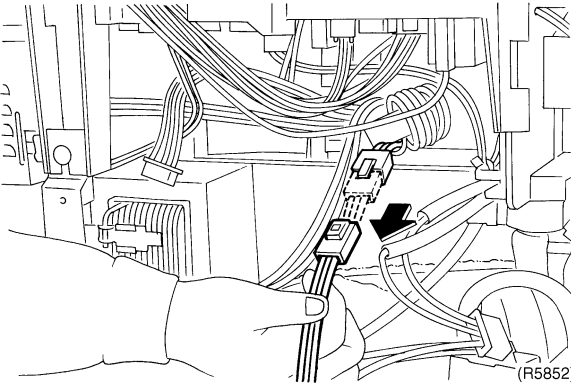
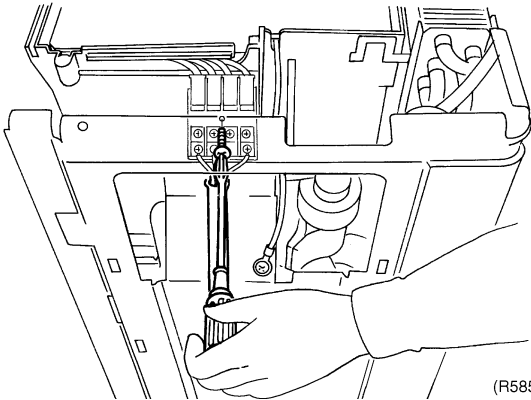
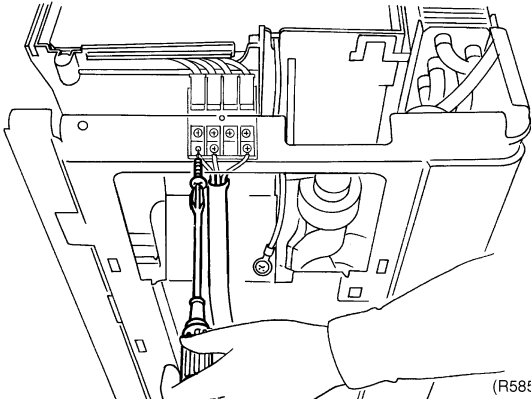
Step	Procedure	Points
9	<p>Disconnect the relay harness for compressor.</p>  <p style="text-align: right;">(R5852)</p>	
<p>2. Disconnect the power supply / connecting wiring</p> <p>1</p> <p>2</p>	<p>Loosen the 1 screw of connecting wire terminal board.</p>  <p style="text-align: right;">(R5853)</p> <p>Disconnect the connecting wires.</p>  <p style="text-align: right;">(R5854)</p>	<ul style="list-style-type: none"> ■ Thermal fuse should be replaced with the terminal board. ■ You can work without removing the terminal board.

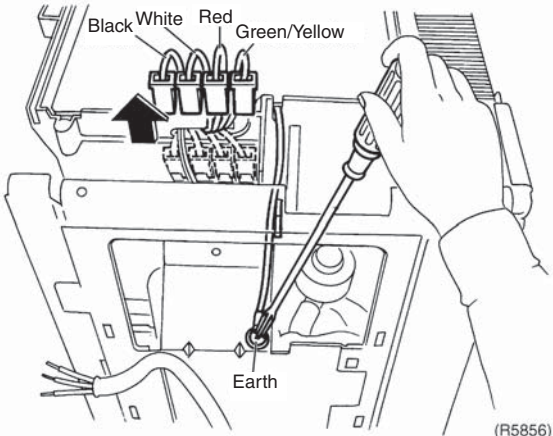
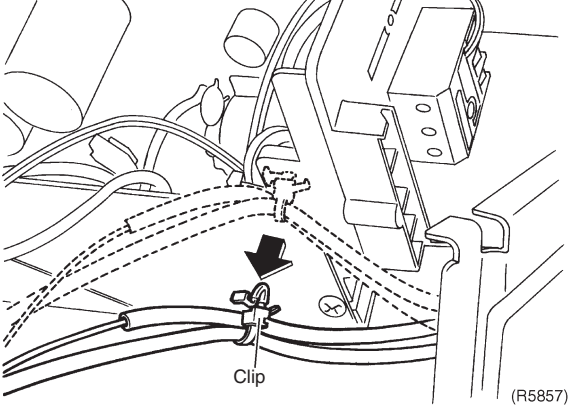
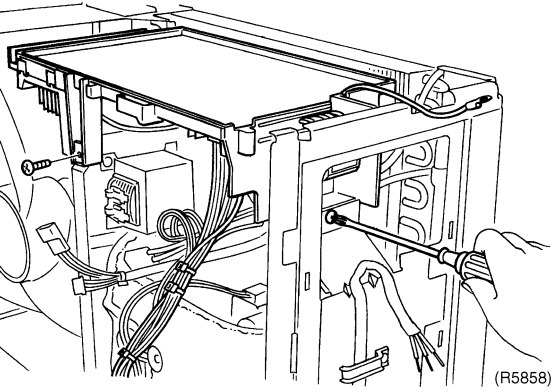
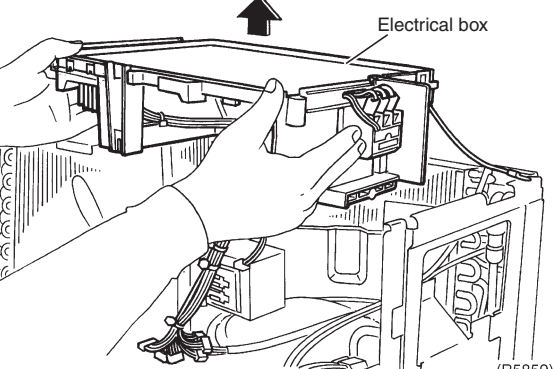
Step	Procedure	Points
4	<p>Disconnect the connectors black (power supply), white (power supply), and red (signal) and detach the earth wire.</p> 	<ul style="list-style-type: none"> ■ Black-power supply White-power supply Red-signal Green/Yellow-earth
5	<p>Undo the clip for the thermistor assembly fixed to the electrical box.</p> 	<ul style="list-style-type: none"> ■ The clip is push-mount type.
6	<p>Loosen the each 1 screw in front and on the right of the electrical box.</p> 	
7	<p>Lift the electrical box to remove.</p> 	

2.8 Removal of the PCB

Procedure



Warning Be sure to wait 10 minutes or more after turning off all power supplies before disassembling work.

Step	Procedure	Procedure	Points
1	Loosen the 7 screws for the PCB or the radiation fin.	<p>(R5860)</p>	<p>Preparation</p> <ul style="list-style-type: none"> ■ Remove the electrical box according to "Removal of Electrical Box". ■ The control PCB is in up side down. ■ PbF (Pb free brazing) is adopted. When replacing, use a exclusive solder and soldering iron.
2	Remove the PCB and the radiation fin.	<p>(R5861)</p> <p>(R5862)</p>	<ul style="list-style-type: none"> ■ In working, be careful not to break the PCB with the excessive force because the PCB and the radiation fin are adhered to one another ■ When assembling, make sure to use the silicon material. Silicon material Part No.: 1172698

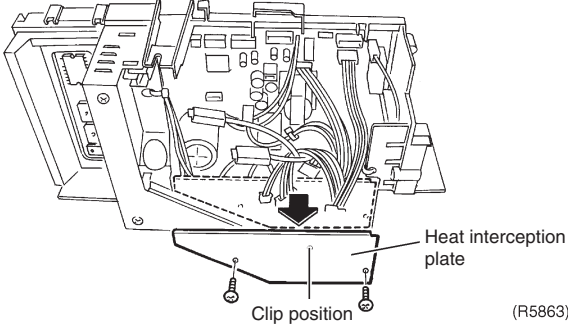
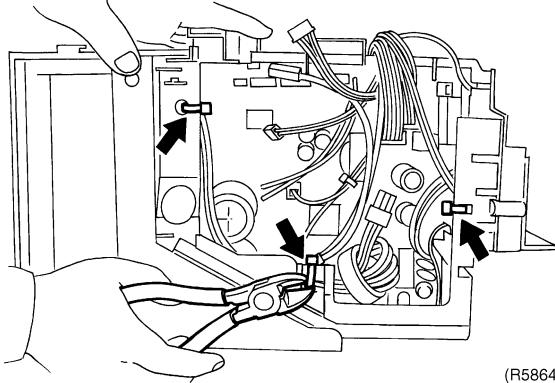
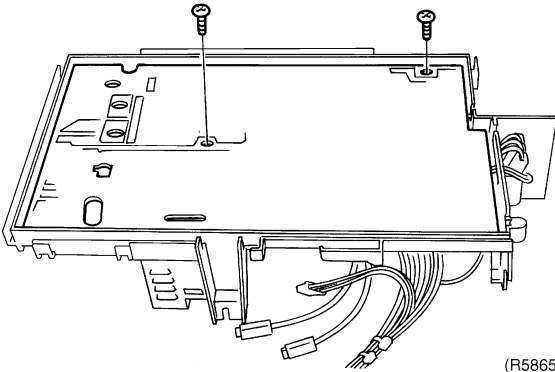
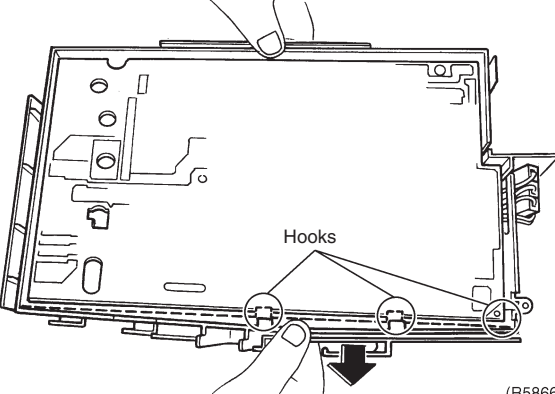
Step	Procedure	Points
3	<p>Loosen the 2 screws and 1 clip to remove the heat interception plate.</p>  <p style="text-align: right;">(R5863)</p>	
4	<p>Cut the fixing clamps for the wire harnesses.</p>  <p style="text-align: right;">(R5864)</p>	
5	<p>Loosen the 2 fixing screws of the PCB.</p>  <p style="text-align: right;">(R5865)</p>	
6	<p>Raise the PCB toward yourself and undo the 3 hooks of the electrical box.</p>  <p style="text-align: right;">(R5866)</p>	

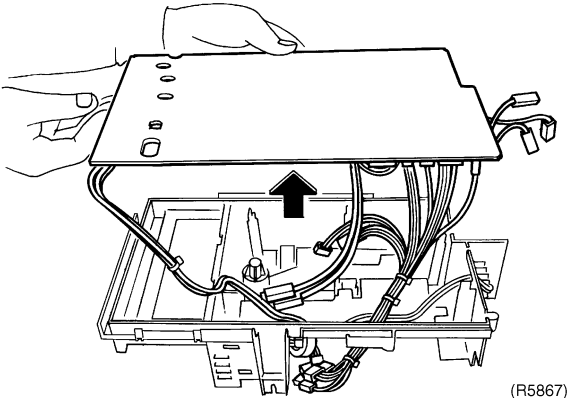
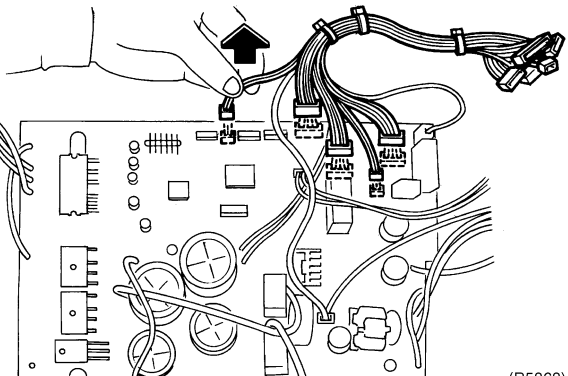
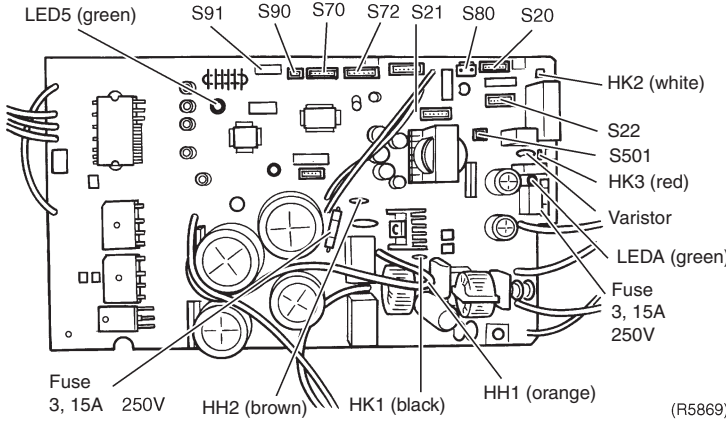
Step	Procedure	Points
7	<p>Remove the PCB from the electrical box.</p>  <p>(R5867)</p>	
8	<p>Disconnect the each wire harness.</p>  <p>(R5868)</p>	<p>S20 : Expansion valve S21 : Humidifying rotor motor S22 : Damper motor S501: LS S70 : Fan motor S72 : Humidifying fan motor S80 : Four way valve S90 : Thermistor (outdoor air / heat exchanger / discharge pipe) S91 : Humidifying thermistor</p>
9	<p>Names of parts of PCB.</p>  <p>(R5869)</p>	

2.9 Removal of the Sound Blanket

Procedure

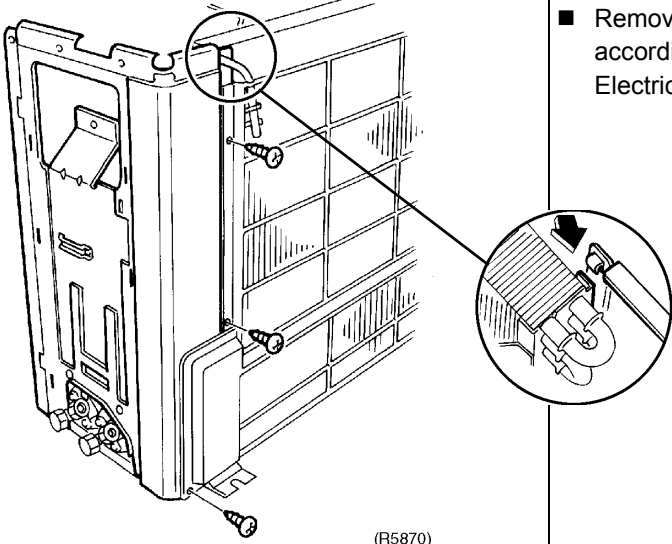
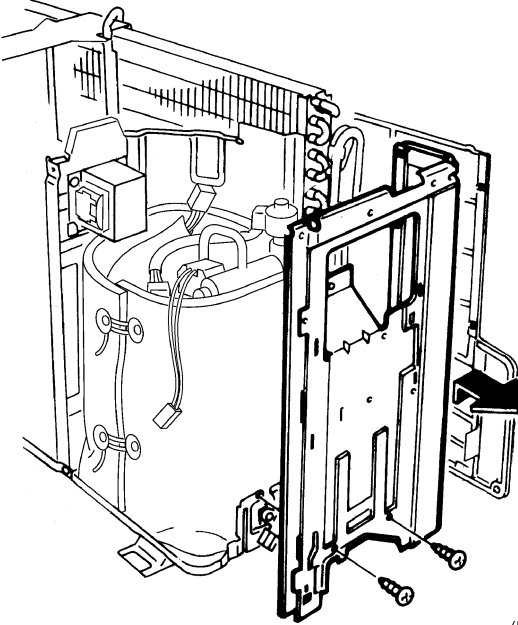
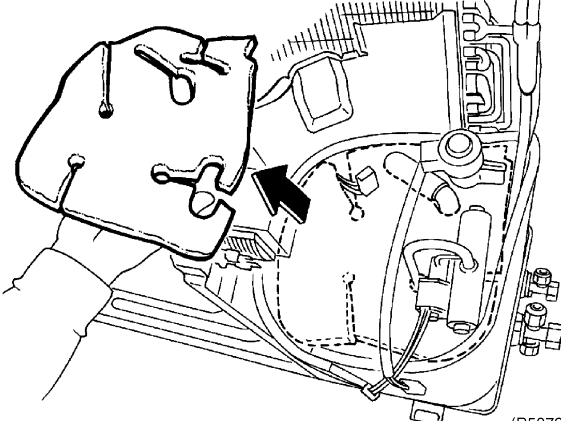

Warning Be sure to wait 10 minutes or more after turning off all power supplies before disassembling work.

Step	Procedure	Points
<p>1. Remove the right side panel</p> <p>1 Loosen the 3 screws on the back side of the right side panel.</p> <p>2 Loosen the 2 screws on the right and slide the panel to undo the 2 lower hooks.</p>	 <p>(R5870)</p>  <p>(R5871)</p>	<p>Preparation</p> <ul style="list-style-type: none"> Remove the electrical box according to "Removal of Electrical Box".
<p>2. Remove the sound blanket</p> <p>1 Lift the sound blanket (top) to remove.</p>	 <p>(R5872)</p>	<ul style="list-style-type: none"> Since the piping ports on the sound blanket are torn easily, remove the blanket carefully.

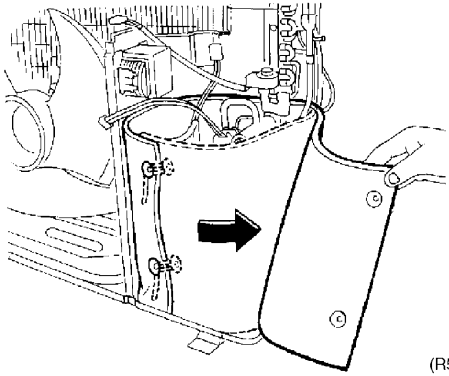
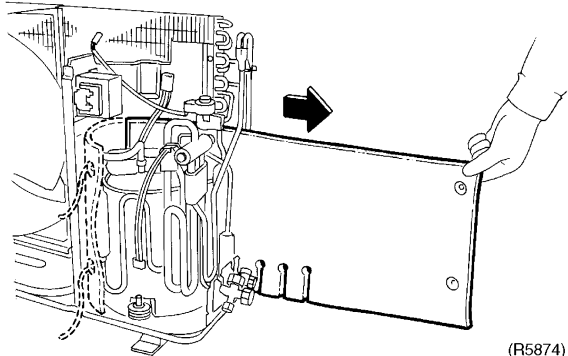
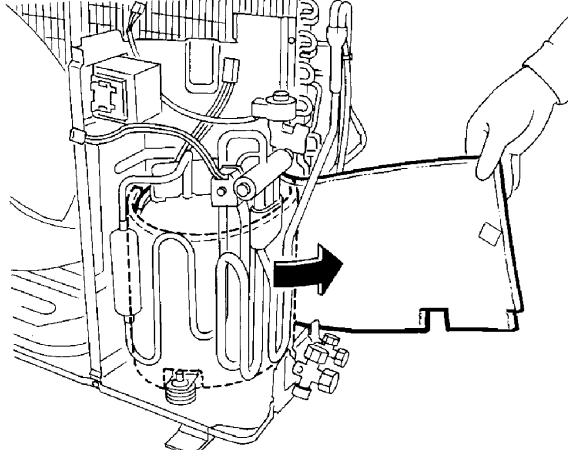
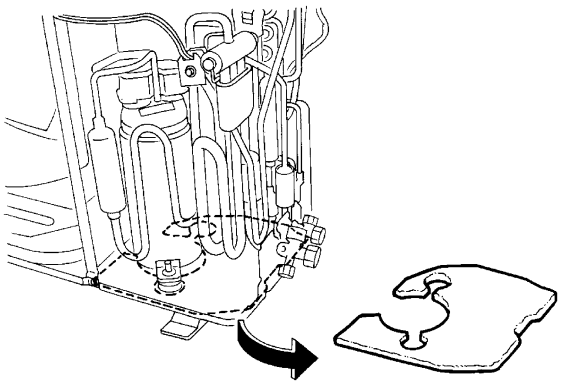
Step	Procedure	Points
2	<p>Undo the fixing strings of the sound blanket (outer body).</p>  <p>(R5873)</p>	
3	<p>Open the sound blanket (outer body) and pull it out.</p>  <p>(R5874)</p>	<ul style="list-style-type: none"> ■ Since the piping ports on the sound blanket are torn easily, remove the blanket carefully.
4	<p>Open the sound blanket (inner body) and pull it out.</p>  <p>(R5875)</p>	
5	<p>Pull the sound blanket (bottom) out.</p>  <p>(R5876)</p>	

2.10 Remove the Thermistor Assembly

Procedure

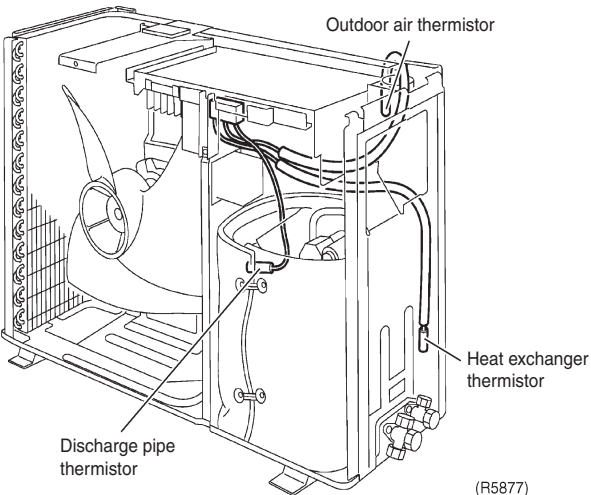
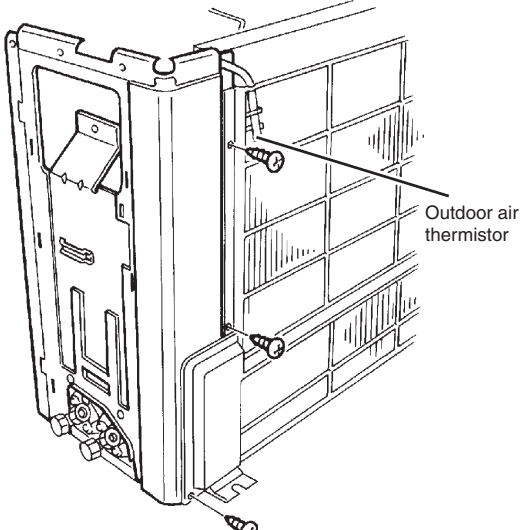
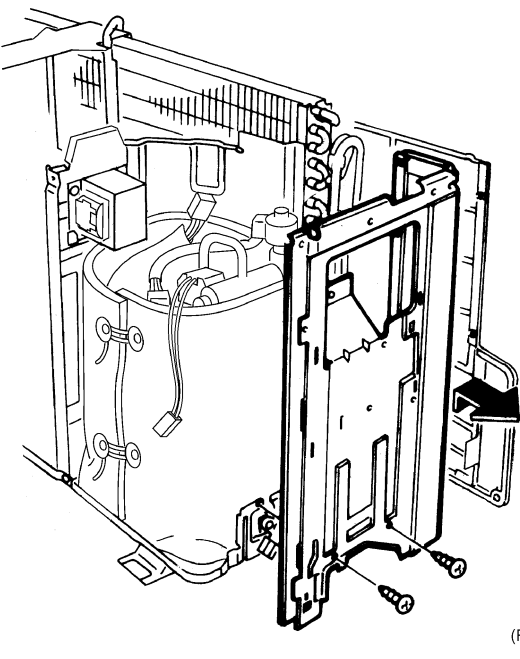

Warning Be sure to wait 10 minutes or more after turning off all power supplies before disassembling work.

Step	Procedure	Points
1	<p>The figure shows the arrangement of the thermistors.</p> 	<p>Preparation</p> <ul style="list-style-type: none"> Remove the thermistor assembly according to "Removal of Electrical Box".
2	<p>Loosen the 3 screws on the back side of the right side panel and detach the outdoor air thermistor.</p> 	
3	<p>Loosen the 2 screws on the right and slide the panel to undo the 2 lower hooks.</p> 	

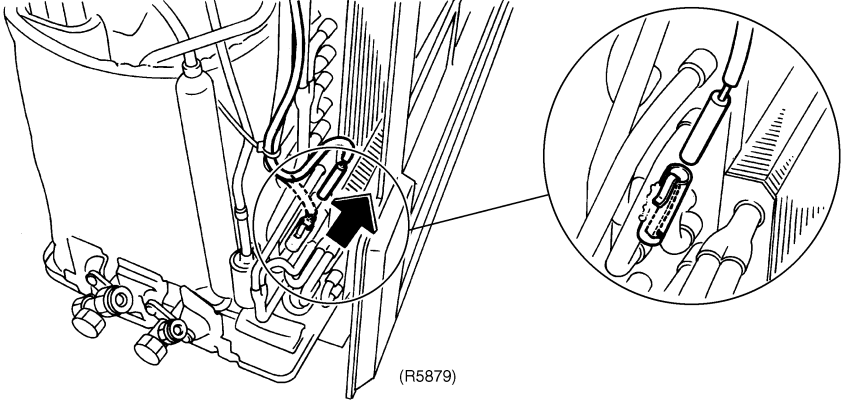
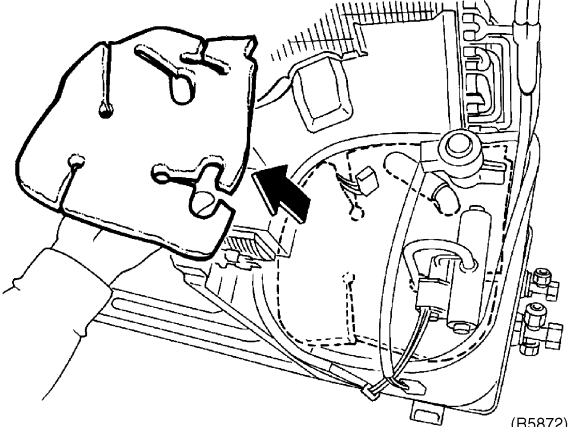
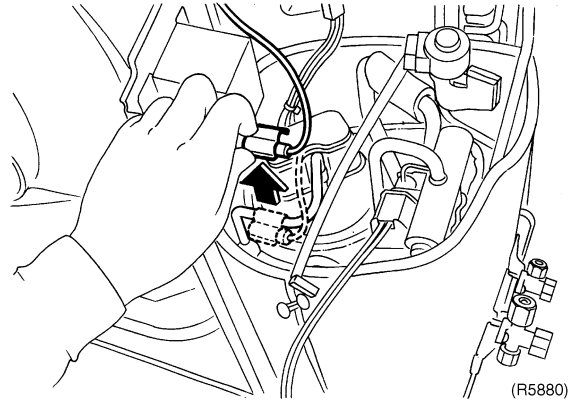
Step	Procedure	Points
4	<p>Detach the heat exchanger thermistor.</p>  <p>(R5879)</p>	
5	<p>Lift the sound blanket (top) to remove.</p>  <p>(R5872)</p>	<ul style="list-style-type: none"> ■ Be careful not to loose the clip for the thermistor. ■ Since the piping ports on the sound blanket are torn easily, remove the blanket carefully.
6	<p>Detach the discharge pipe thermistor.</p>  <p>(R5880)</p>	<ul style="list-style-type: none"> ■ Detach the discharge pipe thermistor while opening the thermistor fixing clip. ■ Be careful not to loose the fixing clip for the discharge pipe thermistor. ■ Meet the edge of the thermistor and clip when assembling.

2.11 Removal of the Reactor / Partition Plate

Procedure

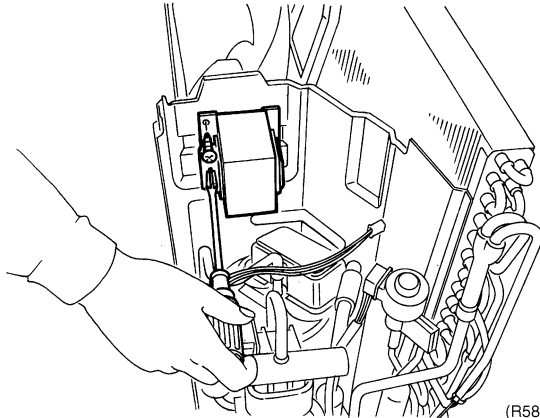
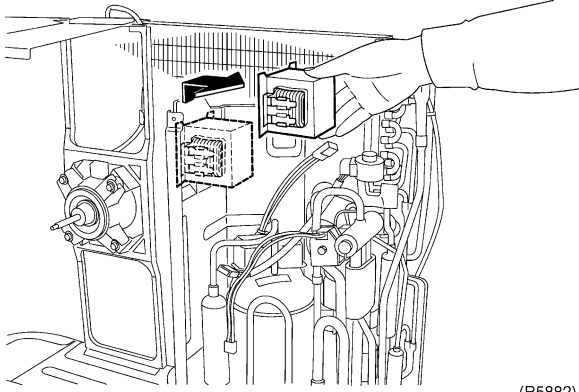
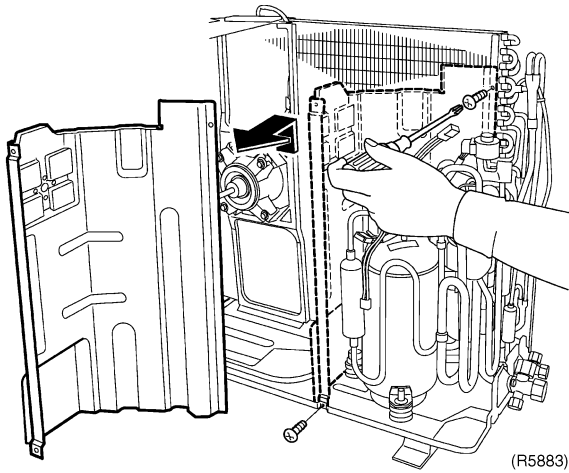
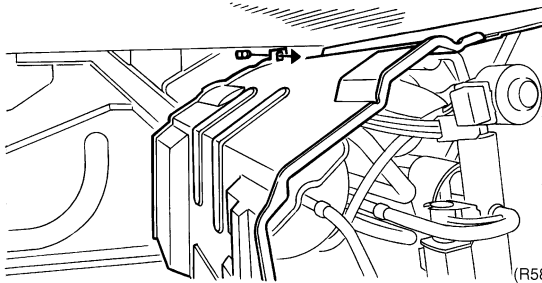

Warning Be sure to wait 10 minutes or more after turning off all power supplies before disassembling work.

Step	Procedure	Points
<p>1. Remove the reactor</p> <p>1 Loosen the 1 screw and lift the reactor to remove.</p>	 <p>(R5881)</p>  <p>(R5882)</p>	<p>Preparation</p> <ul style="list-style-type: none"> ■ Remove the sound blanket according to "Removal of Sound Blanket". ■ The reactor can be removed by loosening only 1 screw.
<p>2. Remove the partition plate</p> <p>2 Loosen the 2 screws and lift the plate to remove.</p>	 <p>(R5883)</p>  <p>(R5884)</p>	<ul style="list-style-type: none"> ■ When assembling, make sure to catch the lower hook of the partition plate.





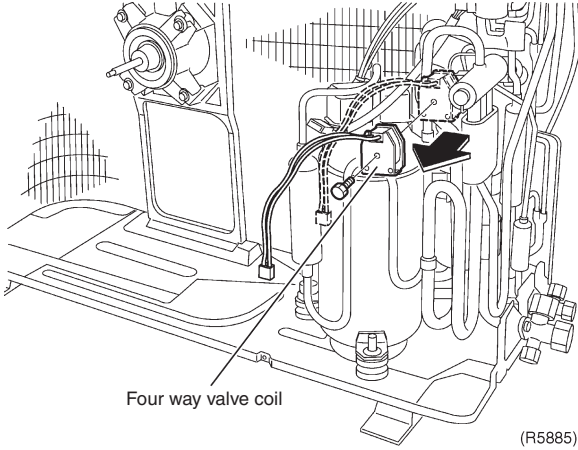
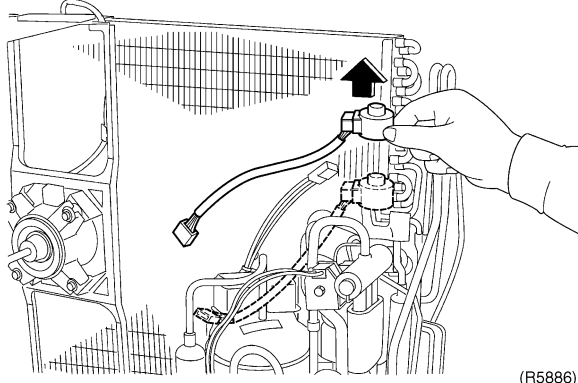
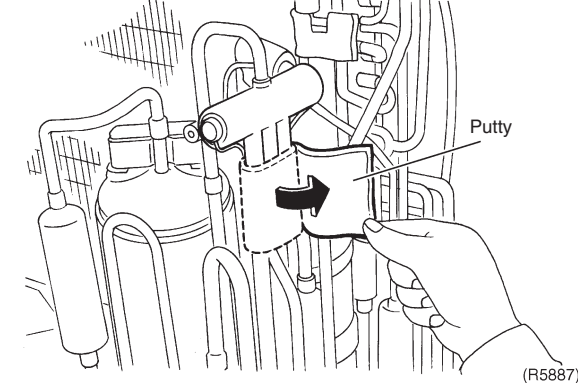

2.12 Removal of the Four Way Valve

Procedure

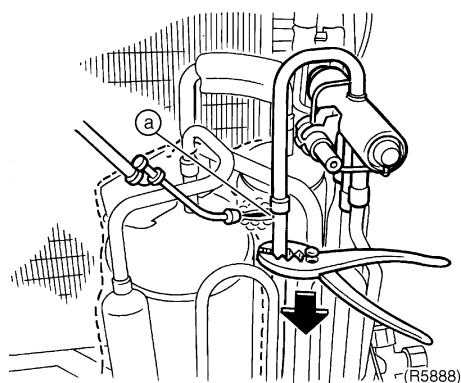

Warning Be sure to wait 10 minutes or more after turning off all power supplies before disassembling work.

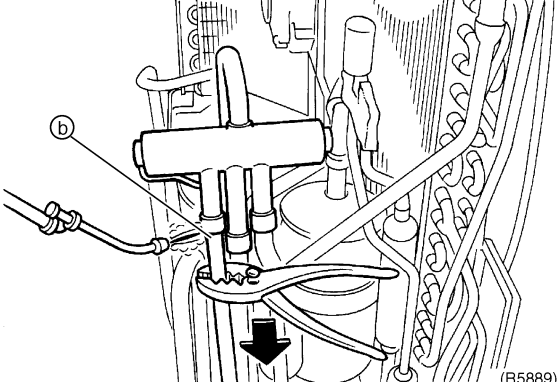
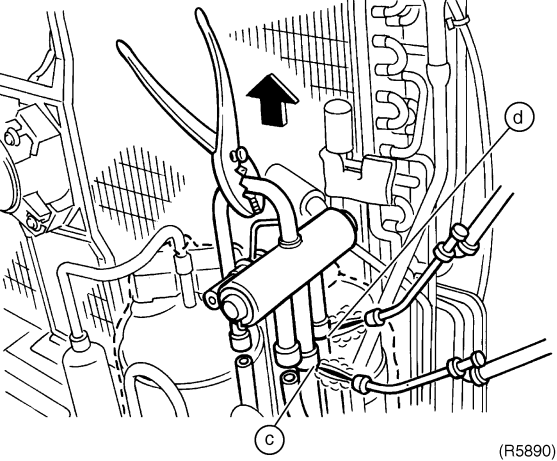
Step	Procedure	Points
1. Remove the peripheral parts		<p>Preparation</p> <ul style="list-style-type: none"> Remove the sound blanket according to "Removal of Sound Blanket".
1 Loosen the 1 screw of the four way valve coil.		
2 Remove the expansion valve coil.		
3 Remove the putty.		

Step	Procedure	Points
<ul style="list-style-type: none"> ■ Provide a protective sheet or a steel plate so that the brazing flame cannot influence peripheries. ■ Before working, make sure that the refrigerant is empty in the circuit. ■ Be sure to apply nitrogen replacement when heating up the brazed part. 		<p>Cautions for restoration</p> <ol style="list-style-type: none"> 1. Restore the piping by non-oxidation brazing. In case of you cannot use the nitrogen gas, restore as quickly as possible. 2. It is required to prevent the carbonization of the oil inside the four way valve and the deterioration of the gaskets affected by heat. For the sake of this, wrap the four way valve with wet cloth and provide water so that the cloth will not be dried and avoid excessive heating. (Keep below 120°C)
<p>2. Remove the four way valve</p>		
<ol style="list-style-type: none"> 1 Heat up the 4 brazed parts of the four way valve. Remove it in the order of (a), (b), (c), (d). 2 Heat up the brazed part and pull out the piping side with pliers. <p> Warning Ventilate when refrigerant leaks during the work. (If refrigerant contacts fire, it will cause to arise toxic gas.)</p> <p> Caution Be careful not to get yourself burnt with the pipes and other parts that are heated by the gas welding rod.</p> <p> Caution From the viewpoint of global environment protection, do not discharge the refrigerant gas in the atmosphere. Make sure to recover the refrigerant gas with the recovery system.</p>	 	<ul style="list-style-type: none"> ■ Be careful so as not to break the pipes by pressing it excessively by pliers when withdrawing it. <p>In case of the difficulty with gas brazing machine</p> <ol style="list-style-type: none"> 1. Disconnect the brazed part where is easy to disconnect and restore. 2. Cut pipes on the main unit by a miniature copper tube cutter in order to make it easy to disconnect. <p> Note: Do not use a metal saw for cutting pipes by all means because the sawdust come into the circuit.</p>

2.13 Removal of the Expansion Valve

Procedure

Warning Be sure to wait 10 minutes or more after turning off all power supplies before disassembling work.

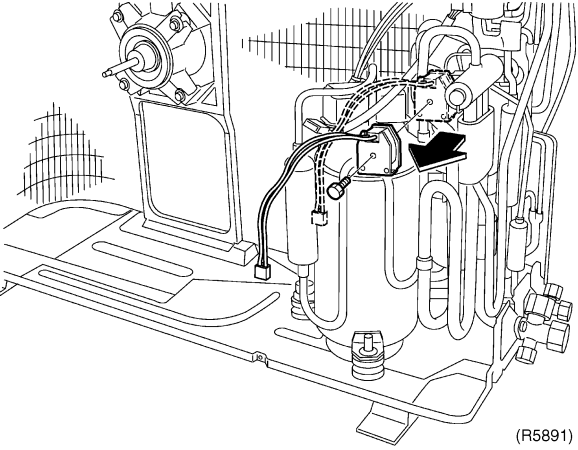
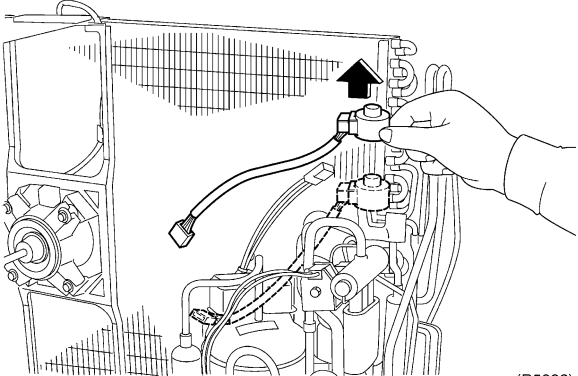
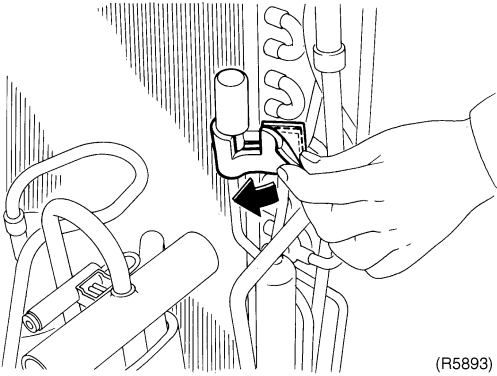
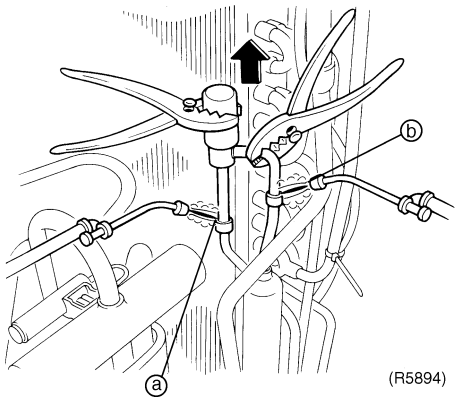
Step	Procedure	Points
<p>1. Remove the peripheral parts</p> <ul style="list-style-type: none"> • Four way valve coil • Expansion valve coil • Putty <p>and so on so as not to be damaged by the brazing flame.</p>	 <p>(R5891)</p>	<p>Preparation</p> <ul style="list-style-type: none"> ■ Remove the sound blanket according to "Removal of Sound Blanket". ■ When assembling, make sure to catch the hook of the expansion valve coil as before.
<p>1 Remove the four any valve coil.</p>		<p>Warning Ventilate when refrigerant leaks during the work. (If refrigerant contacts fire, it will cause to arise toxic gas.)</p>
<p>2 Remove the expansion valve coil.</p>	 <p>(R5892)</p>	<p>Caution Be careful not to get yourself burnt with the pipes and other parts that are heated by the gas welding rod.</p>
<p>3 Remove the putty.</p>	 <p>(R5893)</p>	<p>Caution From the viewpoint of global environment protection, do not discharge the refrigerant gas in the atmosphere. Make sure to recover the refrigerant gas with the recovery system.</p>
<ul style="list-style-type: none"> ■ Before working, make sure that the refrigerant is empty in the circuit. ■ Be sure to apply nitrogen replacement when heating up the brazed part. 		<ul style="list-style-type: none"> ■ Be careful so as not to burn the heat exchanger fin.
<p>2. Remove the expansion valve.</p>		<ul style="list-style-type: none"> ■ When assembling, make sure to catch the hook of the expansion valve coil as before.
<p>1 Remove the 2 brazed parts in the order of (a), (b).</p>	 <p>(R5894)</p>	

2.14 Removal of the Compressor

Procedure



Warning Be sure to wait 10 minutes or more after turning off all power supplies before disassembling work.

Step	Procedure	Points
1. Remove the peripheral parts	<p>(R5895)</p>	<p>Preparation</p> <ul style="list-style-type: none"> Remove the sound blanket according to "Removal of Sound Blanket".
1 Remove the terminal cover.	<p>(R5896)</p>	<ul style="list-style-type: none"> Be careful so as not to burn the compressor terminals or the name plate.
2 Detach the lead wire for compressor.	<p>(R5897)</p>	<p>Make a note.</p>
3 Remove the protecting bushing for the lead wire.	<p>(R5898)</p>	<p>(R6031)</p>
4 Loosen the 1 fixing nut for compressor.		

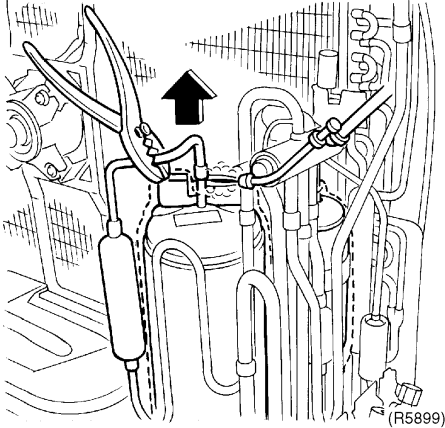
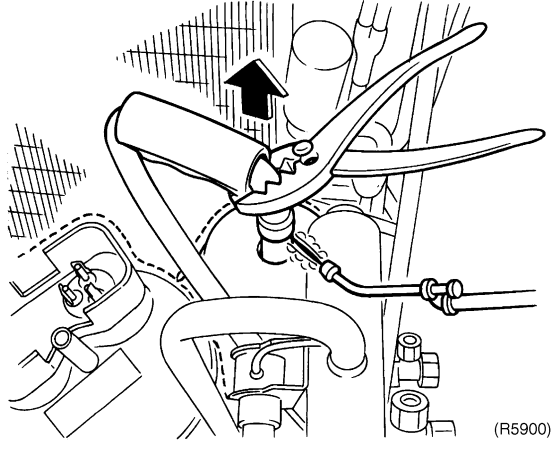
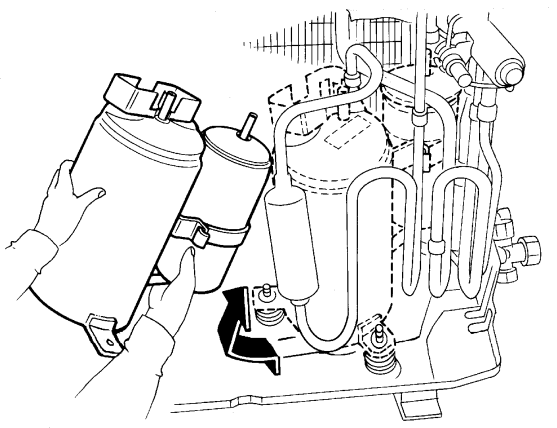
Step	Procedure	Points
<ul style="list-style-type: none"> ■ Provide a protective sheet or a steel plate so that the brazing flame cannot influence peripheries. ■ Before working, make sure that the refrigerant is empty in the circuit. ■ Be sure to apply nitrogen replacement when heating up the brazed part. 		<p>Warning Ventilate when refrigerant leaks during the work. (If refrigerant contacts fire, it will cause to arise toxic gas.)</p> <p>Caution Be careful not to get yourself burnt with the pipes and other parts that are heated by the gas welding rod.</p>
<p>2. Remove the compressor</p>		<p>Cautions for restoration</p>
<p>1 Disconnect the brazing part of the compressor on the discharge side.</p> <p>2 Heat up and disconnect the brazing part on the suction side.</p>		<ol style="list-style-type: none"> 1. Restore the piping by non-oxidation brazing. In case of you cannot use the nitrogen gas, restore as quickly as possible. 2. It is required to prevent the carbonization of the oil inside the four way valve and the deterioration of the gaskets affected by heat. For the sake of this, wrap the four way valve with wet cloth and provide water so that the cloth will not be dried and avoid excessive heating. (Keep below 120°C)
<p>3 Lift up and remove the compressor.</p> <p>Caution From the viewpoint of global environment protection, do not discharge the refrigerant gas in the atmosphere. Make sure to recover the refrigerant gas with the recovery system.</p>		<ul style="list-style-type: none"> ■ Be careful so as not to break the pipes by pressing it excessively by pliers when withdrawing it. <p>In case of the difficulty with gas brazing machine</p> <ol style="list-style-type: none"> 1. Disconnect the brazed part where is easy to disconnect and restore. 2. Cut pipes on the main unit by a miniature copper tube cutter in order to make it easy to disconnect. <p>Note: Do not use a metal saw for cutting pipes by all means because the sawdust come into the circuit.</p>

Part 8 Others

1. Others	298
1.1 Test Run from the Remote Control	298
1.2 Field Setting	299

1. Others

1.1 Test Run from the Remote Control

For Heat pump

In cooling mode, select the lowest programmable temperature; in heating mode, select the highest programmable temperature.

- Trial operation may be disabled in either mode depending on the room temperature.
- After trial operation is complete, set the temperature to a normal level.
(26°C to 28°C in cooling mode, 20°C to 24°C in heating mode)
- For protection, the system disables restart operation for 3 minutes after it is turned off.

Trial Operation and Testing

1. Measure the supply voltage and make sure that it falls in the specified range.
 2. Trial operation should be carried out in either cooling or heating mode.
 3. To perform a test run for humidifying operation, activate test run mode from the remote control following the instructions below and press the "HUMIDIFY" button.
 4. Operate the unit in accordance with the operation manual to check that it operates normally.
- Even when the air conditioner is not operating, it consumes some electric power. If the customer is not going to use the unit soon after it is installed, turn off the breaker to avoid wasting electricity.

Trial operation from Remote Control

- (1) Hold the "CLOCK" button for 5 seconds.
(The matrix display will appear on the remote control.)
- (2) Display "SETTING 1. TEST" on the matrix display of the remote control and press the "CLOCK" button.
- (3) "7" will be displayed and the unit will enter test run mode.
- (4) Press the button corresponding to the test run mode.
 - Test run mode will stop automatically after around 30 minutes.
Press the ON/OFF button to force the test-run to stop.

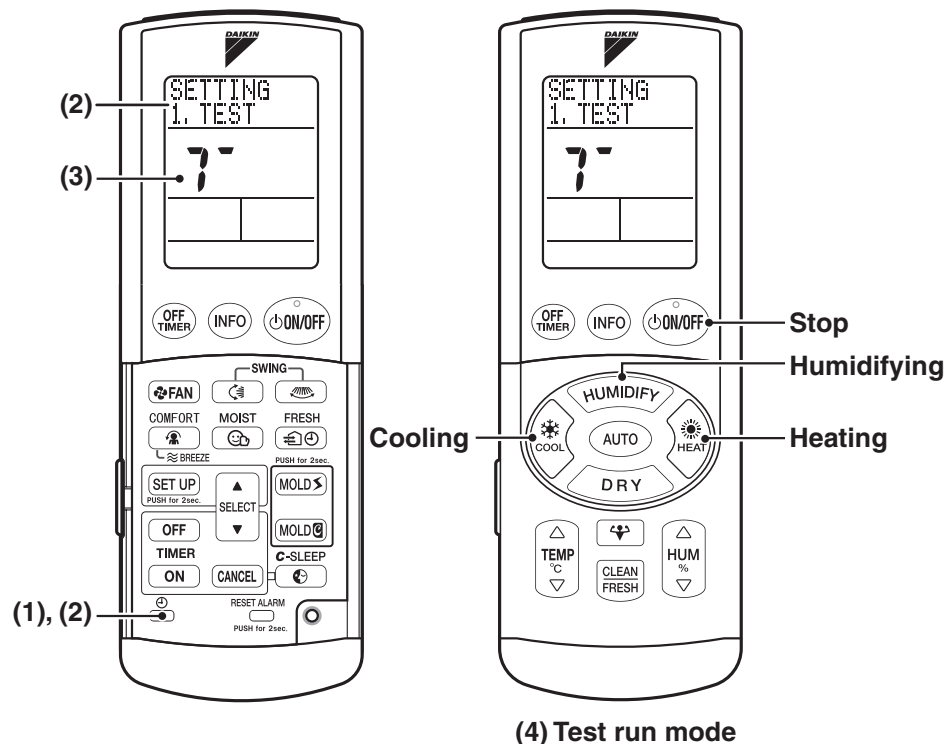

1.2 Field Setting

1.2.1 Humidifying Hose Length

Setting the humidifying hose length.

- Set the humidifying hose length to ensure humidifying capacity. Use the remote control to set the humidifying hose length. When doing this, power on the unit as communication is established between the unit and the remote control.
(The humidifying hose length includes the rear of the indoor unit.)

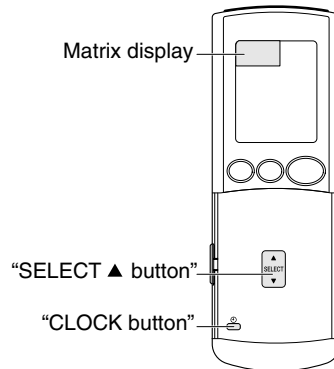

(R5905)

- (1) Hold "CLOCK button" for more than 5 seconds.
(To cancel, do not operate the button for 10 seconds. The display will return to normal.)
- (2) Press "SELECT ▲ . button".
Select " SETTING2. PIPE "
- (3) Press "CLOCK button" to activate the hose length setting mode.
(Be sure to direct the remote control toward the main unit while operating it.)
The display will show the currently set hose length.
(Default is no setting.)
- (4) Press "SELECT ▲ . button" to set the humidifying hose length.
Pressing "SELECT ▲ . button" changes the hose length.
You may set the hose length to 5 levels, ~3M, 3.1~4M, 4.1~6M, 6.1~8M, 8.1~10M.
- (5) Press "CLOCK button" after selecting the hose length.
(Direct the remote control toward the main unit while operating it.)
- (6) Hold "CLOCK button" for more than 5 seconds.
The humidifying hose length setting is complete.

If you set the wrong humidifying hose length, cancel the setting displaying

" PIPE SET
RESET "

When the unit cannot be powered on.

- When setting the humidifying hose length without powering on the unit, the display shows " PIPE LEN
UNDEF " with the step 5) operation shown above but the remote control remembers the set hose length.
(When the customer uses the unit, the humidifying hose length information is sent to the indoor unit to be set.)

1.2.2 How to set the different addresses

When 2 indoor units are installed in one room, the 2 infrared remote controls can be set for different addresses.

- 1) Remove the front grille. (3 screws)
- 2) Cut the address jumper "JA".
(See Fig. 1)

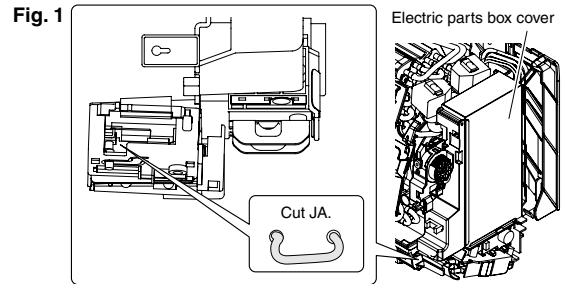

- 3) Remove the remote control lid and cut the address jumper "J4".
(See Fig. 2)

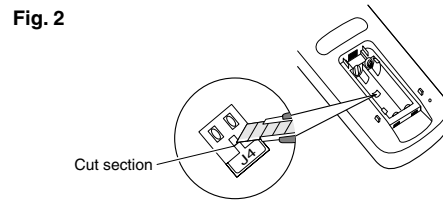

(R5989)

1.2.3 Jumper Setting

Jumper (On indoor control PCB)	Function	When connected (factory set)	When cut
JC	Power failure recovery function	Auto-restart	Unit does not resume operation after recovering from a power failure. Timer ON-OFF settings are cleared.
JB	Fan speed setting when compressor is OFF on thermostat. (effective only at cooling operation)	Fan speed setting ; Remote controlremote control setting	Fan rpm is set to "0" <Fan stop>

Part 9 Appendix

1. Piping Diagrams	302
1.1 Indoor Units	302
1.2 Outdoor Units	302
2. Wiring Diagrams	303
2.1 Indoor Units	303
2.2 Outdoor Units	303

1. Piping Diagrams

1.1 Indoor Units

FTXR28/42/50EV1B

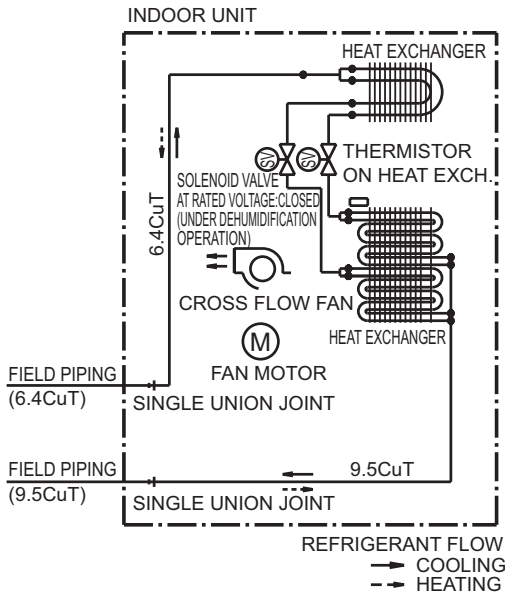

4D054058

1.2 Outdoor Units

RXR28/42/50EV1B

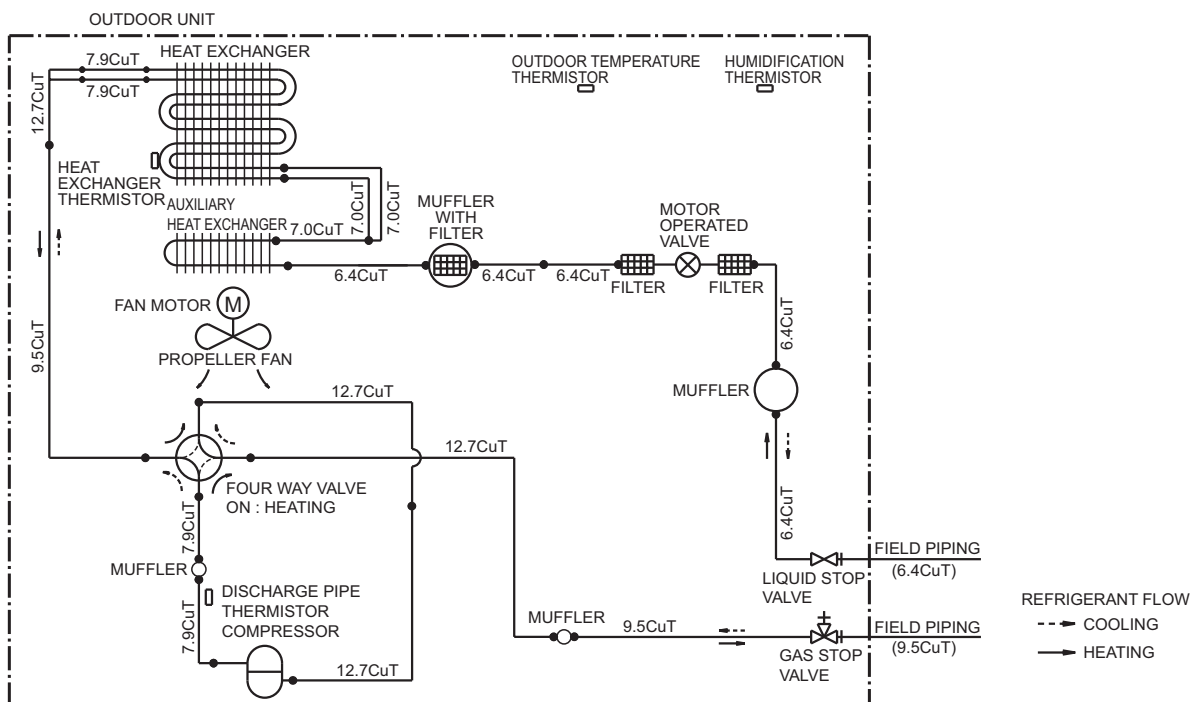

3D053874

2. Wiring Diagrams

2.1 Indoor Units

FTXR28/42/50EV1B

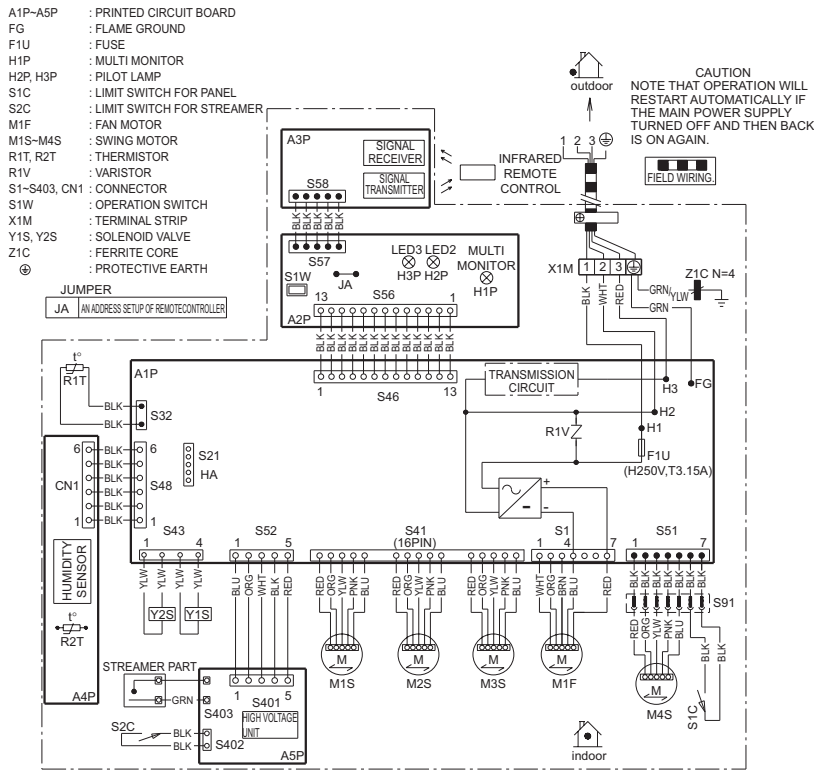

3D052768

2.2 Outdoor Units

RXR28/42/50EV1B

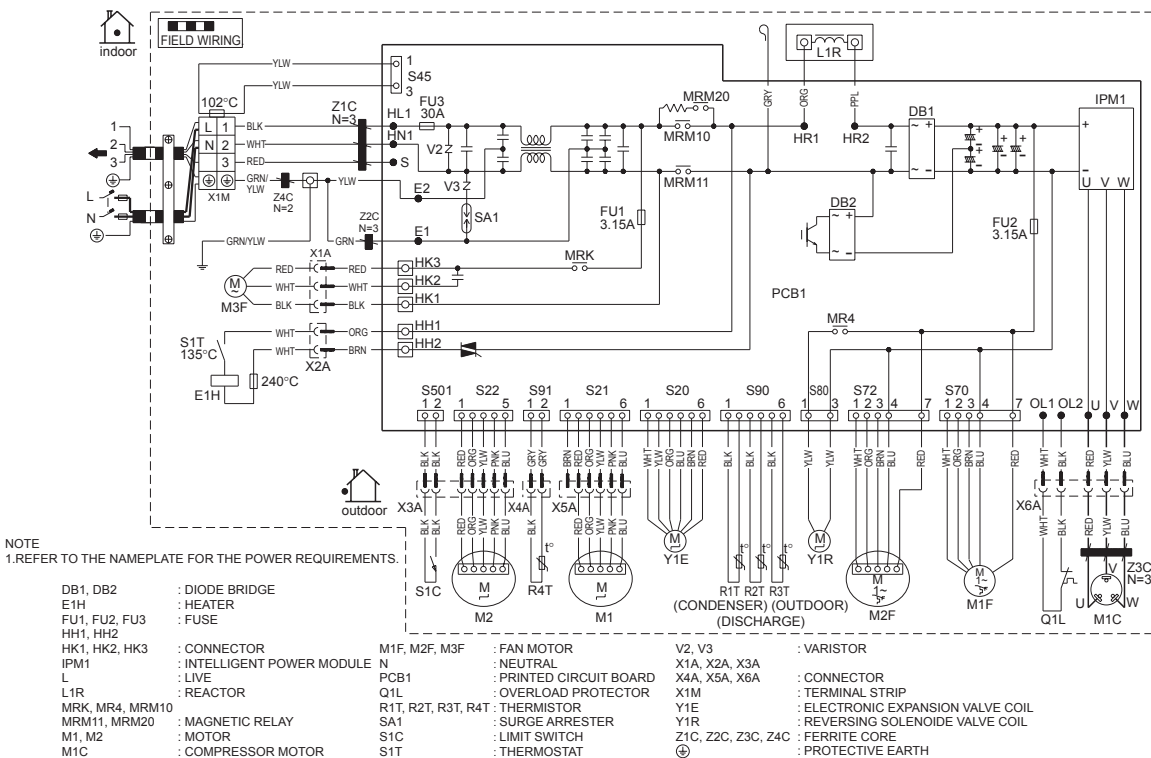

3D053291

Index

Symbols

"inverter checker" check.....	206
"SARARA" drying operation	26, 112
"URURU" humidifying operation	17, 113

Numerics

1/f fluctuation.....	34
24-hour ON/OFF TIMER	54, 117
3-D airflow	37

A

A1.....	150
A5.....	151
A6.....	153
abnormal heater temperature.....	199
abnormal temperature in electrical box	182
address setting jumper.....	8
adjusting airflow direction.....	115
AH.....	155
air filter	122, 216
air supply filter.....	122, 220
air supply ventilation.....	51
airflow direction	35
airflow rate.....	115
auto operation	114
automatic air flow	59
automatic defrosting.....	73
automatic operation.....	31
auto-restart.....	8

B

bearing	255
beep volume.....	119

C

C4.....	157
C7.....	158
C9.....	157
capacitor voltage check.....	204
care and cleaning.....	122
CC.....	159
centralized control	8
check	
"inverter checker" check	206
capacitor voltage check	204
discharge pressure check.....	208
electronic expansion valve check	209
four-way valve performance check	213
humidity sensor check	212
indoor unit PCB output check	210
installation condition check	203
main circuit electrolytic capacitor check.....	205
main circuit short check	212
outdoor fan system check.....	203
power supply waveform check.....	204

power transistor check.....	207
refrigerant system check.....	205
rotating pulse input on	
outdoor unit PCB check	211
solenoid valve for dehumidification check	214
thermistor resistance check	202
check No.10	204
check No.11	205
check No.12	205
check No.14	206
check No.15	207
check No.16	208
check No.17	209
check No.18	210
check No.2	202
check No.23	211
check No.27	212
check No.29	212
check No.3	203
check No.31	213
check No.32	214
check No.5	203
check No.8	204
child proof lock	119
CN1	8
combination of on timer and off TIMER.....	54
comfort airflow mode	30, 32
comfort airflow mode operation	115
comfort sleep operation.....	28, 118
communication circuit fault.....	191
compressor	295
compressor lock	166
compressor overload.....	165
compressor sensor system fault.....	175
compressor start up protection.....	65
connecting duct	245
connectors.....	8, 10
contrast setting	119
control for abnormally high discharge	
temperature	79
control PCB	150, 239
control PCB (indoor).....	9
control PCB (outdoor)	11, 164, 191
control when frequency is changed.....	76
control when starting	76
cooling breeze operation	34, 115
cooling operation	112
countdown off TIMER.....	54, 117

D

damper fault	176
damper for air supply and exhaust changeover ..	271
DC fan lock.....	167
DC voltage / DC current sensor fault.....	179
defrost control	73

dehumidifying solenoid valve	234
dehumidifying solenoid valve coil	244
demonstration mode	
indoor unit	56
outdoor unit	56
deodorizing filter for streamer	122, 218
deodorizing performance	50
description of operation	15
dew prevention	70
diagnosis mode	56
different addresses	300
discharge pipe temperature control	72, 172
discharge pipe thermistor	180, 290
discharge pressure check	208
discharge temperature, abnormally high	79
display PCB	9
draft prevention	61
draftless operation	32
drain hose	247
drain plug	247
drip proof cover	236, 275
dry cooling operation	27
duct in humidifier	279
duct unit	245
E	
E1	164
E5	165
E6	166
E7	167
E8	168
EA	170
electrical box	182
electrical box (indoor)	233
electrical box (outdoor)	280
electronic expansion valve check	209
electronic expansion valve control	75
error code	
A1	150
A5	151
A6	153
AH	155
C4	157
C7	158
C9	157
CC	159
E1	164
E5	165
E6	166
E7	167
E8	168
EA	170
F3	172
F6	173
H0	175
H1	176
H6	177
H8	179
H9	180
J3	180
J6	180
L3	182
L4	184
L5	186
P4	180
P9	196
PA	197
PH	199
U0	188
U2	190
U4	160, 191
U7	194
UA	162, 163
error code indication	139
expansion valve	294
expansion valve coil	281
F	
F3	172
F6	173
failure diagnosis	
by LED indication	138
by remote control	137
with operation lamp	137
failure diagnosis	139
fan lock	196
fan motor	254, 274
fan motor (humidifying)	280
fan motor (indoor)	235
fan motor (outdoor)	280
fan motor system (DC motor) fault	153
fan motor system fault	196
fan rotor	255
fan speed control (indoor unit)	59
fan speed control (outdoor unit)	66
fan speed setting	8, 300
field setting	299
filter cleaning indicator	53
filters	
air filter	122, 216
air supply filter	122, 220
deodorizing filter for streamer	122, 218
titanium apatite photocatalytic	
air purifying filter	122, 219
fin thermistor control	66
flash streamer air purifying operation	48, 116
forced humidifying drying mode	56
forced operation mode	56
forced operation ON / OFF switch	8
four way valve	292
four way valve coil	280
four way valve fault	170
four-way valve operation	64
four-way valve performance check	213
freeze-up protection	69, 151
frequency control	62
fresh air supply ventilation	51, 116
front grille (indoor)	225
front grille (outdoor)	276
front panel (indoor)	216
front panel (outdoor)	275
front panel open / close fault	158

FU1	8, 10
FU2	10
FU3	10
functions	2
fuse	8, 10
H	
H0	175
H1	176
H6	177
H8	179
H9	180
HA	8
Hall IC	153
heat exchanger (indoor)	251
heat exchanger thermistor (indoor)	236
heat exchanger thermistor (outdoor)	290
heat interception plate	285
heater assembly	266
heater wire fault	197
heating operation	113
HH1	10
HH2	10
high pressure control	151
high pressure control in cooling	173
HK1	10
HK2	10
HK3	10
HOME LEAVE ventilation	47
HOME LEAVE ventilation operation	116
horizontal blades	257
hose length	
setting	299
incomplete setting	163
hot start	61
HR1	10
HR2	10
humid heating operation	17
humidification fan outlet thermistor fault	199
humidify unit	263
humidifying air flow rate fine adjusting mode	56
humidifying assembly	270
humidifying hose length setting mode	56
humidifying operation	
check the motion	19
humidification performance	21
humidifying ability	18
humidifying method	17
operating condition	18
performance compensation by hose length	23
reachable humidity	22
relative humidity	19
time chart	20
humidifying rotor	266
humidifying rotor motor	266
humidifying thermistor	281
humidity sensor check	212
humidity sensor fault	159
humidity sensor PCB	9, 159
I	
incompatible power supply	162
incomplete setting for hose length	163
indoor coil freeze-up protection	69
indoor heat exchanger thermistor	157
indoor unit PCB fault	150
indoor unit PCB output check	210
indoor unit quiet operation	39
information display	40, 121
input current control	67
input over current detection	168
installation condition check	203
installation manual	
indoor units	82
outdoor units	96
instruction	107
insufficient gas	188
interlocking shaft	258
J	
J3	180
J4	300
J6	180
JA	8, 300
JB	8, 300
JC	8, 300
jumper setting	300
L	
L3	182
L4	184
L5	186
LED A	8, 10
LED2	8
LED3	8
LED5	10
lights-out of microcomputer status lamp	201
limit switch	262
liquid compression protection 2	71
low voltage protection	190
M	
main circuit electrolytic capacitor check	205
main circuit short check	212
moisture absorption element	266
moisture absorption fan motor	273
moisturizing operation	30, 114
mold proof operation	41, 119, 120
mold proof stick	43
mold shock operation	44, 121
monitor brightness	119
monitor brightness setting	40
multi monitor	39
multi-colored indicator lamp	39
N	
names and functions of parts	108
night set mode	55

O	
OL activation	165
open/close mechanism	228
outdoor air thermistor	180
outdoor fan system check (DC motor)	203
outdoor heat exchanger thermistor	180
outdoor unit PCB fault	164, 191
output overcurrent	186
over current	168
over voltage protection	190
overload	165
P	
P4	180
P9	196
PA	197
partition plate	291
peak-cut control	68, 151
PH	199
PI control	62
piping diagrams	302
position sensor fault	177
power failure recovery function	8, 300
power initialization control	75
power supply terminal board	239
power supply waveform check	204
power transistor check	207
power-airflow dual flaps	35
POWERFUL operation	38, 118
preheating operation	63
preparation before operation	110
pressure equalization control	78
printed circuit board (PCB)	
control PCB	150, 191, 239
display PCB	9
humidity sensor PCB	9, 159, 241
indoor control PCB	9
outdoor control PCB	11, 164
signal receiver / transmitter PCB	9, 241
streamer unit PCB	9, 155, 262
propeller fan	254, 274
Q	
quick warming function	63
R	
R1T	8
R2T	8
radiation fin	184, 284
radiation fin thermistor	180
reactor	281, 291
receiver PCB	241
reduction motor	230
refrigerant piping	251
refrigerant system check	205
reheating dehumidifying method	26
remote control	137
removal procedure	215
room temperature thermistor	157
rotating pulse input on outdoor unit PCB check	211
S	
S1	8, 235, 241
S20	10, 281
S21	8, 10, 241
S22	10
S32	8, 241
S401	8
S402	8
S403	8
S41	8, 235, 241
S43	8, 234, 241
S45	10
S46	8, 241
S48	8, 241
S501	10
S51	8, 230, 241
S52	8, 234, 241
S56	8
S57	8
S58	8
S63	8
S70	10, 280
S72	10, 280
S80	10, 280
S90	10, 281
S91	10, 281
safety precautions	107
sensor PCB	241
service check function	137
service cover	222
set up on remote control	
beep volume	119
child proof lock	119
contrast setting	119
mold proof operation	119
monitor brightness	119
shelter	238, 274
side panel	254
signal receiver / transmitter PCB	9
signal transmission error	160
signal transmission error on outdoor unit PCB	194
solenoid valve for dehumidification check	214
sound blanket	287
special modes	56
specifications	4
stop valve cover	263, 279
streamer unit	234, 259
streamer unit fault	155
streamer unit PCB	9, 155, 262
SW1	8
swing motor	235, 249
T	
target discharge pipe temperature control	77
temperature rise in radiation fin	184
terminal board	282
terminal cover	295
test run	298
thermistor	
discharge pipe thermistor	180
indoor heat exchanger thermistor	157

outdoor air thermistor	180
outdoor heat exchanger thermistor.....	180
radiation fin thermistor	180
room temperature thermistor	157
thermistor assembly	281, 289
thermistor resistance check	202
thermistor system fault.....	157, 180
thermostat control	58
TIMER operation	
24-hour ON/OFF TIMER.....	54, 117
combination of ON TIMER and OFF TIMER	54
countdown OFF TIMER.....	54, 117
titanium apatite photocatalyst.....	50
titanium apatite photocatalytic	
air purifying filter.....	122, 219
top panel	264
trial operation	298
trial operation mode	56
troubleshooting.....	130, 139
troubleshooting	
by LED indication.....	138
by remote control.....	137
with operation lamp	137
U	
U0.....	188
U2.....	190
U4.....	160, 191
U7.....	194
UA	162, 163
upper panel	222
V	
V1.....	8
V2.....	10
V3.....	10
varistor	8, 10
ventilation system.....	52
vertical blades	257
v-shape temperature control	28
W	
wide-angle louvers	36
wipe-clean flat panel	53
wiring diagrams.....	303

"The present publication is drawn up by way of information only and does not constitute an offer binding upon Daikin Europe N.V. Daikin Europe N.V. has compiled the content of this publication to the best of its knowledge. No express or implied warranty is given for the completeness, accuracy, reliability or fitness for particular purpose of its content and the products and services presented therein. Specifications are subject to change without prior notice. Daikin Europe N.V. explicitly rejects any liability for any direct or indirect damage, in the broadest sense, arising from or related to the use and/or interpretation of this publication. All content is copyrighted by Daikin Europe N.V."



Daikin Europe N.V. is approved by LRQA for its Quality Management System in accordance with the ISO9001 standard. ISO9001 pertains to quality assurance regarding design, development, manufacturing as well as to services related to the product.



ISO14001 assures an effective environmental management system in order to help protect human health and the environment from the potential impact of our activities, products and services and to assist in maintaining and improving the quality of the environment.



Daikin units comply with the European regulations that guarantee the safety of the product.



Daikin Europe N.V. participates in the Eurovent Certification Programme for Air Conditioners (AC), Liquid Chilling Packages (LCP) and Fan Coil Units (FC); the certified data of certified models are listed in the Eurovent Directory.

DAIKIN EUROPE N.V.

Naamloze Vennootschap
Zandvoordestraat 300
B-8400 Ostend, Belgium
www.daikin.eu
BTW: BE 0412 120 336
RPR Oostende

