

DAIKIN

INSTALLATION MANUAL

R410A Split Series

INVERTER

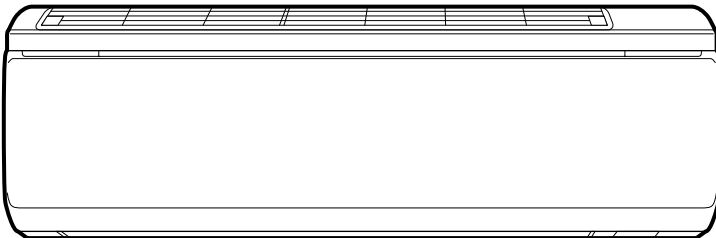

Models

FTXR28EV1B9

FTXR42EV1B9

FTXR50EV1B9

Installation manual
R410A Split series

English

Installationsanleitung
Split-Baureihe R410A

Deutsch

Manuel d'installation
Série split R410A

Français

Montagehandleiding
R410A Split-systeem

Nederlands

Manual de instalación
Serie Split R410A

Español

Manuale d'installazione
Serie Multiambienti R410A

Italiano

Εγχειρίδιο εγκατάστασης
διαιρούμενης σειράς R410A

Ελληνικά

Manual de Instalação
Série split R410A

Portugues

Руководство по монтажу
Серия R410A с раздельной установкой

Русский

Montaj kılavuzları
R410A Split serisi

Türkçe



Safety Precautions

- Read these Safety Precautions carefully to ensure correct installation.
- This manual classifies the precautions into WARNING and CAUTION.
Be sure to follow all the precautions below: they are all important for ensuring safety.





 **WARNING**.....Failure to follow any of **WARNING** is likely to result in such grave consequences as death or serious injury.



 **CAUTION**.....Failure to follow any of **CAUTION** may result in grave consequences in some cases.

- The following safety symbols are used throughout this manual:

| | | |
|--|---|--|
|  Be sure to observe this instruction. |  Be sure to establish an earth connection. |  Never attempt. |
|--|---|--|

- After completing installation, test the unit to check for installation errors. Give the user adequate instructions concerning the use and cleaning of the unit according to the Operation Manual.

|  WARNING | |
|--|---|
| • Installation should be left to the dealer or another professional. Improper installation may cause water leakage, electrical shock, or fire. | |
| • Install the air conditioner according to the instructions given in this manual. Incomplete installation may cause water leakage, electrical shock, or fire. | |
| • Be sure to use the supplied or specified installation parts. Use of other parts may cause the unit to come to lose, water leakage, electrical shock, or fire. | |
| • Install the air conditioner on a solid base that can support the weight of the unit. An inadequate base or incomplete installation may cause injury in the event the unit falls off the base. | |
| • Electrical work must be performed in accordance with relevant local and national regulations and with instructions in this installation manual. Be sure to use a dedicated power supply circuit only. Insufficiency of power circuit capacity and improper workmanship may result in electric shocks or fire. | |
| • Be sure to use a dedicated power circuit. Never use a power supply shared by another appliance. | |
| • For wiring, use a cable length enough to cover the entire distance with no connection. Do not use an extension cord. Do not put other loads on the power supply, use a dedicated power circuit. (Failure to do so may cause abnormal heat, electric shock or fire.) | |
| • Use the specified types of wires for electrical connections between the indoor and outdoor units. Firmly clamp the interconnecting wires so their terminals receive no external stresses. Incomplete connections or clamping may cause terminal overheating or fire. | |
| • After connecting interconnecting and supply wiring be sure to shape the cables so that they do not put undue force on the electrical covers or panels. Install covers over the wires. Incomplete cover installation may cause terminal overheating, electrical shock, or fire. | |
| • If any refrigerant has leaked out during the installation work, ventilate the room. (The refrigerant produces a toxic gas if exposed to flames.) |  |
| • After all installation is complete, check to make sure that no refrigerant is leaking out. (The refrigerant produces a toxic gas if exposed to flames.) |  |
| • When installing or relocating the system, be sure to keep the refrigerant circuit free from substances other than the specified refrigerant (R410A), such as air. (Any presence of air or other foreign substance in the refrigerant circuit causes an abnormal pressure rise or rupture, resulting in injury.) | |
| • During pump-down, stop the compressor before removing the refrigerant piping. If the compressor is still running and the shut-off valve is open during pump-down, air will be sucked in when the refrigerant piping is removed, causing abnormal pressure in the freezer cycle which will lead to breakage and even injury. | |
| • During installation, attach the refrigerant piping securely before running the compressor. If the compressor is not attached and the shut-off valve is open during pump-down, air will be sucked in when the compressor is run, causing abnormal pressure in the freezer cycle which will lead to breakage and even injury. | |
| • Be sure to establish an earth. Do not earth the unit to a utility pipe, arrester, or telephone earth. Incomplete earth may cause electrical shock, or fire. A high surge current from lightning or other sources may cause damage to the air conditioner. |  |
| • Be sure to install an earth leakage breaker. Failure to install an earth leakage breaker may result in electric shocks, or fire. | |

|  CAUTION | |
|---|---|
| • Do not install the air conditioner in a place where there is danger of exposure to inflammable gas leakage. If the gas leaks and builds up around the unit, it may catch fire. |  |
| • Establish drain piping according to the instructions of this manual. Inadequate piping may cause flooding. | |
| • Tighten the flare nut according to the specified method such as with a torque wrench. If the flare nut is tightened too hard, the flare nut may crack after a long time and cause refrigerant leakage. | |

Accessories

| | | | | | |
|--|---|--|---|--------------------------|---|
| Ⓐ Mounting plate | 1 | Ⓔ Air supply filter frame | 1 | Ⓙ AAA dry-cell batteries | 2 |
| Ⓑ Deodorizing filter for streamer | 1 | Ⓕ Indoor unit fixing screws (M4 × 12L) | 3 | Ⓚ Operation manual | 1 |
| Ⓒ Titanium apatite photocatalytic air-purifying filter | 1 | Ⓖ Wireless remote controller | 1 | Ⓛ Installation manual | 1 |
| Ⓓ Air supply filter | 1 | Ⓗ Remote controller holder | 1 | | |

Choosing an Installation Site

- Before choosing the installation site, obtain user approval.

1. Indoor unit.

- The indoor unit should be sited in a place where:
 - 1) the restrictions on installation specified in the indoor unit installation drawings are met,
 - 2) both air intake and exhaust have clear paths met,
 - 3) the unit is not in the path of direct sunlight,
 - 4) the unit is away from the source of heat or steam,
 - 5) there is no source of machine oil vapour (this may shorten indoor unit life),
 - 6) cool (warm) air is circulated throughout the room,
 - 7) the unit is away from electronic ignition type fluorescent lamps (inverter or rapid start type) as they may shorten the remote control range,
 - 8) the unit is at least 1 metre away from any television or radio set (unit may cause interference with the picture or sound),
 - 9) install at the recommended height (2.3m).

2. Wireless remote controller.

- 1) Turn on all the fluorescent lamps in the room, if any, and find the site where remote control signals are properly received by the indoor unit (within 7 metres).

Indoor Unit Installation Drawings

1. Precautions for humidifying hose installation work.

- When embedding humidifying hose:
 - 1) Cannot be installed to the existing embedded piping. Embedding work is separately necessary.
- The length of the humidifying hose is marked on the hose packing material.
 - 1) Use an extension hose (sold separately) when extending the humidifying hose.
 - 2) The length of the humidifying hose needs to be set to ensure humidifying capacity. Cut off any excess hose. Use the remote controller to set the hose length. (Refer to page 12.)
- If the humidifying hose needs to be cut to be laid, cut it, lay it, and connect it using the joint or elbow included with the outdoor unit. When doing this, wrap it to prevent air leaks with the binding band included with the outdoor unit. (Refer to page 9.)
- When laying the humidifying hose inside the wall, block the ends of the humidifying hose with tape or the like to prevent water or anything else from entering it until it is connected to the indoor unit and outdoor unit ducts.
- Do not bend the humidifying hose more than 90°.

Indoor Unit Installation Drawings

2. Removing and installing indoor unit.

• Installation method

- 1) Using the Δ marks (3 locations) on top of the indoor unit, attach the (A) mounting plate hooks onto the indoor unit.
- 2) Attach the tabs on the bottom frame onto the (A) mounting plate. If the tabs are not hooked onto the plate, remove the front grille to hook them. (Check to see if the tabs are hooked securely.)

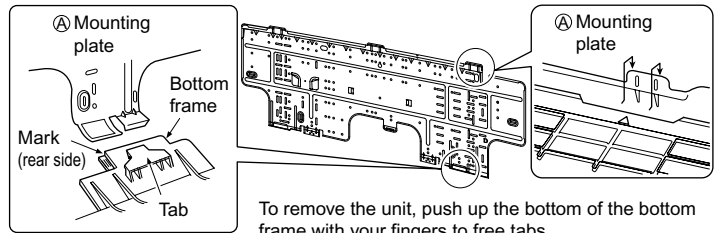

To remove the unit, push up the bottom of the bottom frame with your fingers to free tabs. (Mark parts (2 locations) on the bottom of the front grille.)

• Removal method

Push up the mark part on the bottom of the front grille, discharge the tabs, and then remove the unit while lifting it up.

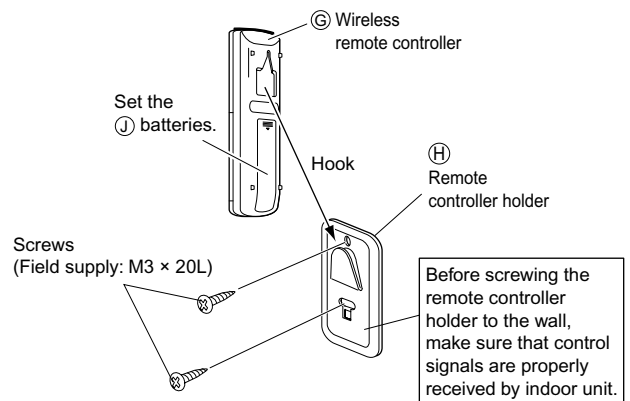
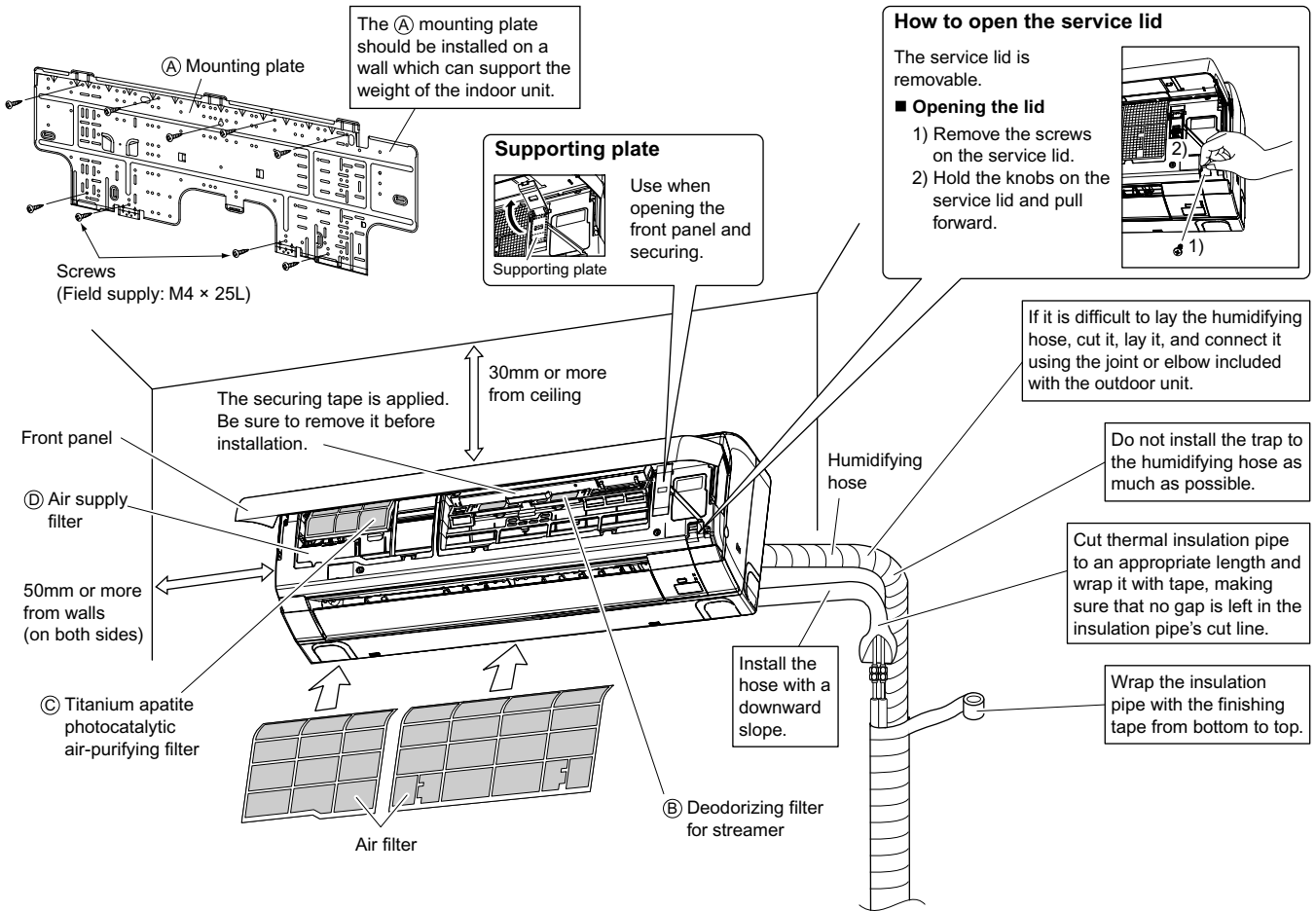

Installation Tips

1. Removing and installing front panel.

• Removal method

- 1) Open the front panel.
- 2) Spread out the shaft hole on the left side and remove the rotating shaft.
Spread out the shaft hole on the right side as well and remove the rotating shaft.

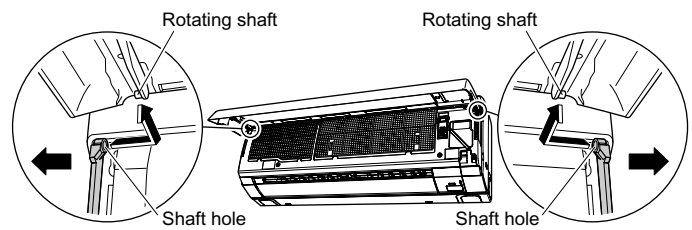

• Installation method

- Insert the right and left rotating shafts on the front panel into the shaft holes one at a time and slowly close the panel.
(Press on both sides of the front panel.)

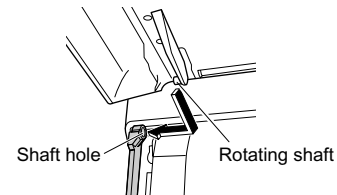

2. Removing and installing the upper panel.

• Removal method

- 1) Remove the front panel and air filter.
- 2) Hold and pull forward 2 tabs on both sides to discharge them, discharge the center tab, and then lift up the upper panel.

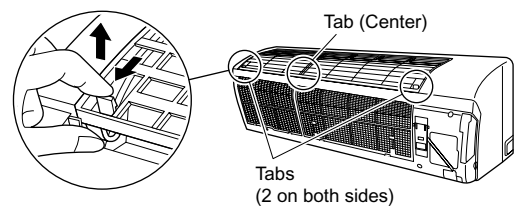

• Installation method

- 1) Push in the upper panel along the guide on the top of the front grille and insert the 3 tabs into the slots on the front grille.
- 2) Push the upper panel down until it clicks.
- 3) Attach the air filter and front panel.

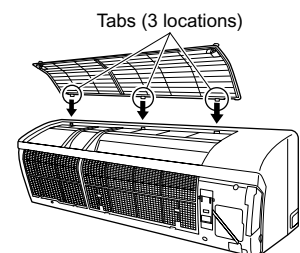

6. How to replace the drain plug and drain hose.

• Replacing onto the left side

- 1) Remove the insulation fixing screws on the right to remove the drain hose.
- 2) Reattach the insulation fixing screw on the right as it was.
*(Forgetting to attach this may cause water leakages.)
- 3) Remove the drain plug on the left side and attach it to the right side.
- 4) Insert the drain hose and tighten with included ⑥ indoor unit fixing screw.

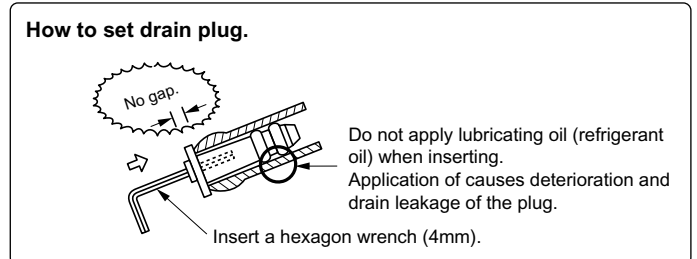
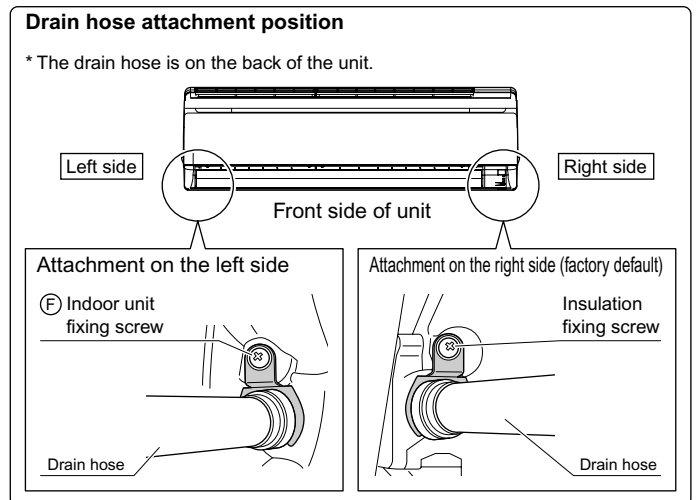

7. How to set the different addresses.

- When 2 indoor units are installed in one room, the 2 wireless remote controllers can be set for different addresses.

- 1) Remove the front grille. (3 screws)
- 2) Cut the address jumper "JA". (See Fig. 1)

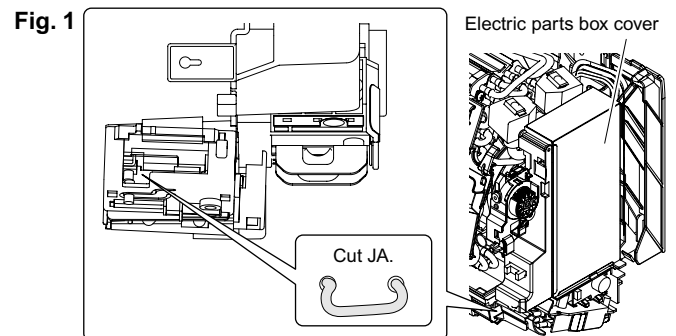

- 3) Remove the remote controller lid and cut the address jumper "J4". (See Fig. 2)

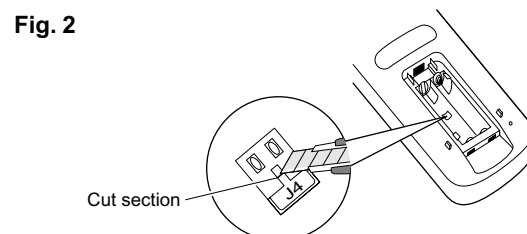

Indoor Unit Installation

1. Installing the mounting plate.

- The (A) mounting plate should be installed on a wall which can support the weight of the indoor unit.
 - Temporarily secure the (A) mounting plate to the wall, make sure that the panel is completely level, and mark the boring points on the wall.
 - Secure the (A) mounting plate to the wall with screws.

Recommended mounting plate retention spots and Dimensions

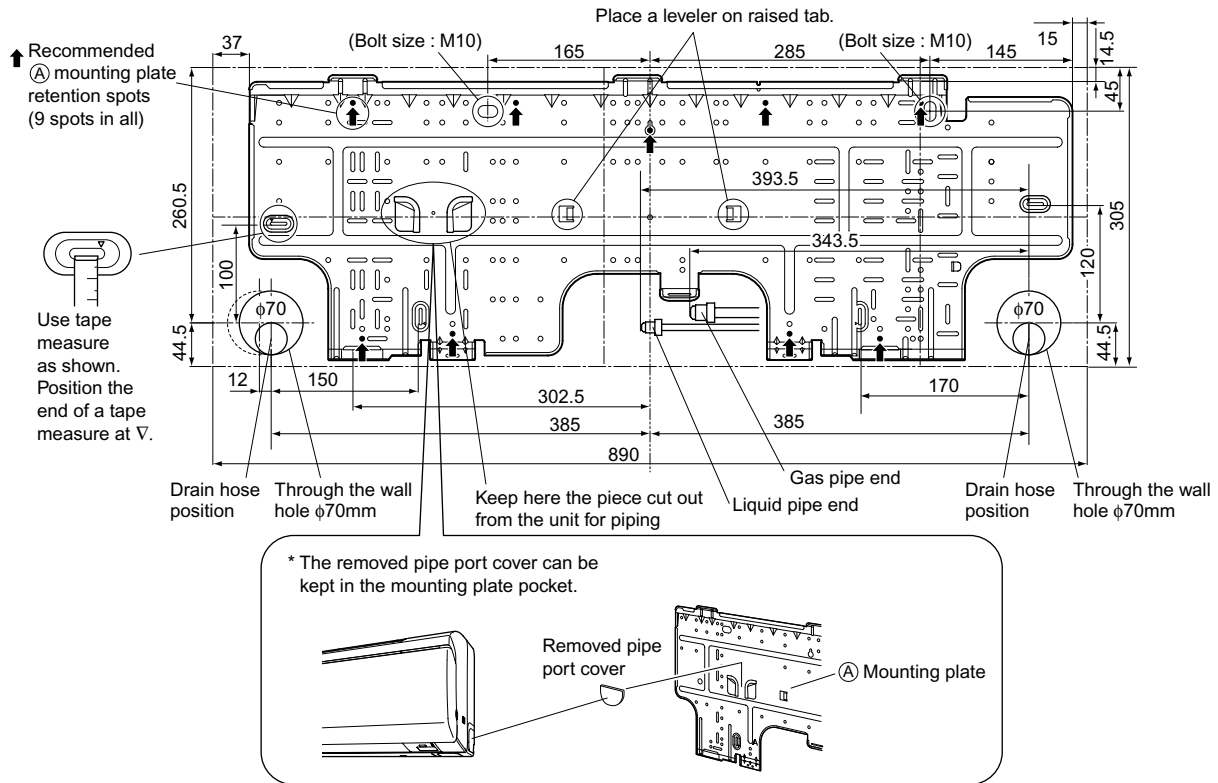

2. Boring a wall hole and installing wall embedded pipe.

- For walls containing metal frame or metal board, be sure to use a wall embedded pipe and wall cover in the feed-through hole to prevent possible heat, electrical shock, or fire.
- Be sure to caulk the gaps around the pipes with caulking material to prevent water leakage.
 - Bore a feed-through hole of 70mm in the wall so it has a down slope toward the outside.
 - Insert a wall pipe into the hole.
 - Insert a wall cover into wall pipe.
 - After completing refrigerant piping, wiring, and drain piping, caulk pipe hole gap with putty.

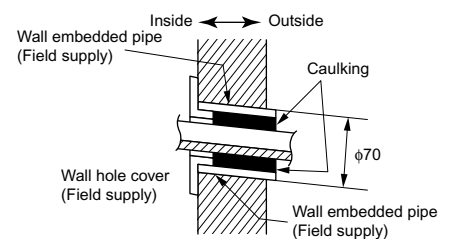

3. Installing inter-unit wiring.

- Open the front panel and remove the service lid.
- Pull out the inter-unit wiring from the back of the indoor unit to the front. It is easier to pull out if bending up the wire edge in advance.
- To connect the inter-unit wiring after hooking the unit onto the (A) mounting plate, connect the inter-unit wiring as shown in the figure at right.

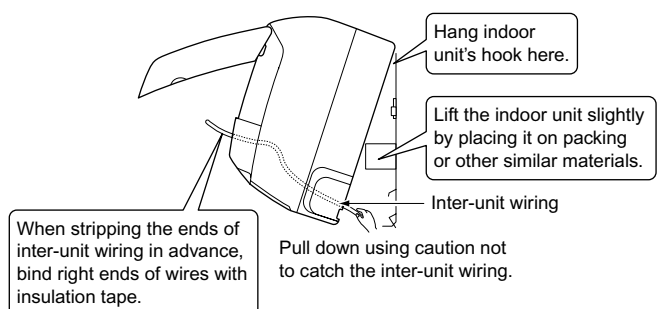

4. Laying piping, hoses, and wiring.

- Connect the humidifying hose to the indoor unit duct. See **5. Humidifying hose installation work** for details.
- Lay the piping, drain hose and humidifying hose according to the orientation of the piping coming out of the unit, as shown below.
- Make sure the drain hose is sloped downward.
- Wrap the piping, drain hose and humidifying hose together using insulation tape.

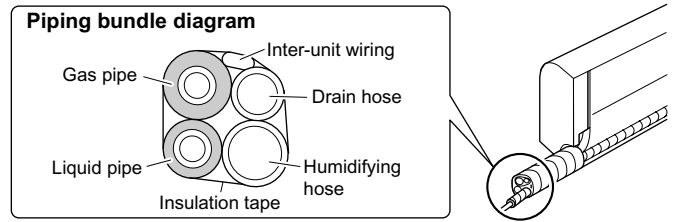

4-1. Right-side, right-back, or right-bottom piping.

• Right-side piping

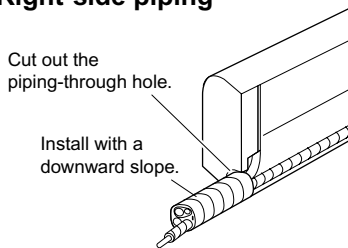

• Right-back piping

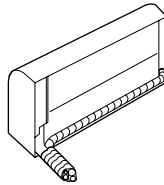

• Right-bottom piping

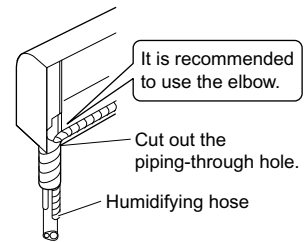

- 1) Wrap the piping, hose and inter-unit wiring using insulation tape as shown in the piping bundle diagram.
- 2) Put all the pipes through the through-hole in the wall and hook the indoor unit onto the (A) mounting plate.
- 3) Connect the pipes.

4-2. Left-side, left-back, or left-bottom piping.

• Left-side piping

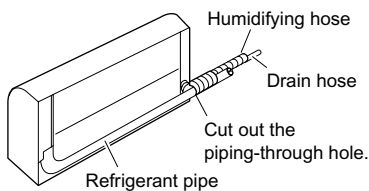

• Left-back piping

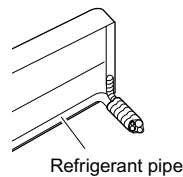

• Left-bottom piping

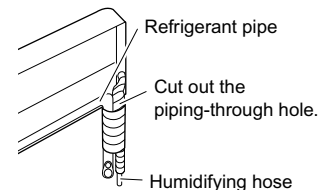

- 1) Replace the drain plug and drain hose. (**How to replace the drain plug and drain hose.**)
- 2) Pull in the refrigerant piping and lay it so that it matches the liquid and gas piping marked on the (A) mounting plate.
- 3) Hook the indoor unit onto the (A) mounting plate.
- 4) Connect the pipes. If it is difficult to do, remove the front panel first.
- 5) Wrap the insulation on the piping with insulation tape. If you are not replacing the drain hose, store it in the location shown below.

When securing the indoor unit with screws

- 1) Remove the front grille.
- 2) Secure the indoor unit with the (E) indoor unit fixing screws.
- 3) Install the front grille.

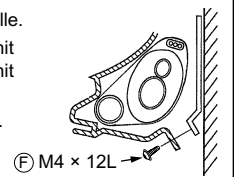

4-3. Left-back piping.

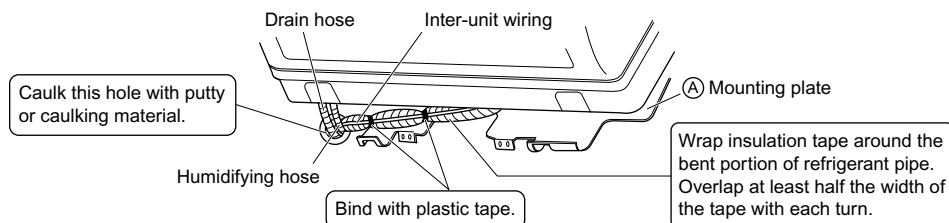

Indoor Unit Installation

4-4. Wall embedded piping.

Follow the instructions given under

Left-side, left-back, or left-bottom piping

- 1) Insert the drain hose to this depth so it won't be pulled out of the drain pipe.

Insert drain hose to this depth so it won't be pulled out of drain pipe.

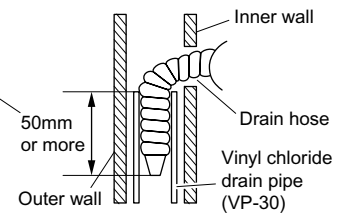

⚠ WARNING

Do not bundle the power cord with a binding band, a twist tie or other method. This may cause heat, electric shock or fire.

5. Humidifying hose installation work.

5-1. Connecting to the indoor unit.

- Connect the cuff side of the humidifying hose to the indoor unit duct.

It is easier to connect the hose with the front grille removed.

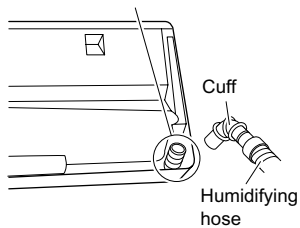

Connect the cuff side of the humidifying hose to the indoor unit duct.

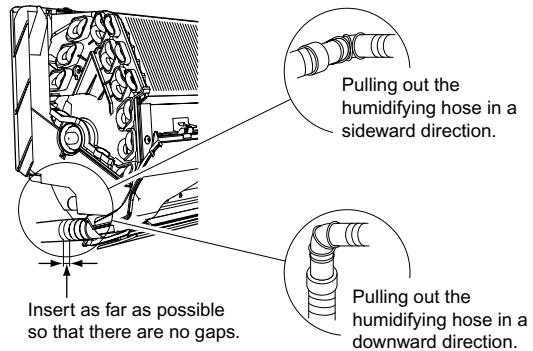

• Left-back piping

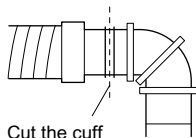

Cut the cuff at this part.

(If it is too long, cut the humidifying hose and bond the separately sold cuff with adhesive for vinyl to adjust the length.)

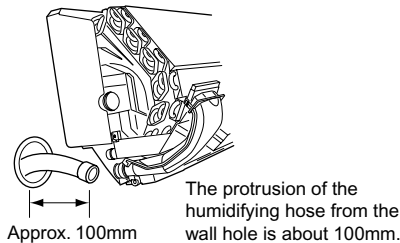

The protrusion of the humidifying hose from the wall hole is about 100mm.

⚠ CAUTION

Use caution not to deform the cuff while installing the humidifying hose.

5-2. Connecting the cut humidifying hoses.

- When install the cut humidifying hoses, follow the instructions below.

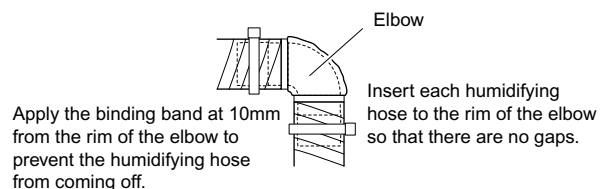
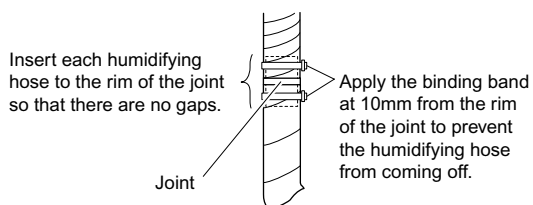

- Use not more than 1 elbow to ensure humidifying capacity.

6. Wiring.

- 1) Strip wire ends (15mm).
- 2) Match wire colours with terminal numbers on indoor and outdoor unit's terminal blocks and firmly screw wires to the corresponding terminals.
- 3) Connect the earth wires to the corresponding terminals.
- 4) Pull wires to make sure that they are securely latched up, then retain wires with wire retainer.
- 5) In case of connecting to an adapter system. Run the remote control cable and attach the S21.
(Refer to 7. **Connecting to the HA system.**)
- 6) Shape the wires so that the service lid fits securely, then close service lid.

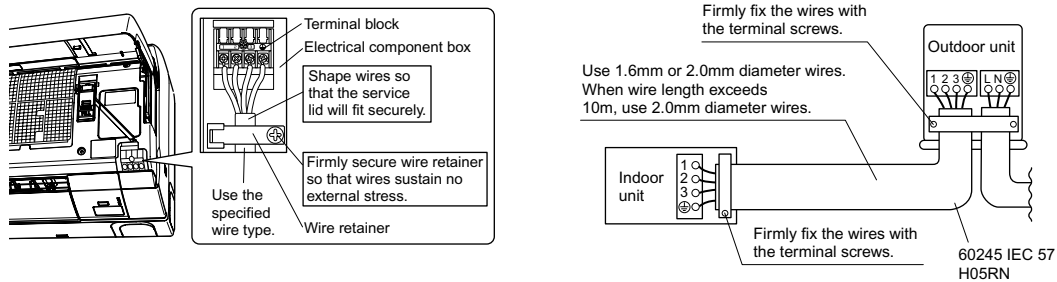

⚠ WARNING

- 1) Do not use tapped wires, stranded wires, extension cords, or starburst connections, as they may cause overheating, electrical shock, or fire.
- 2) Do not use locally purchased electrical parts inside the product. (Do not branch the power for the drain pump, etc., from the terminal block.) Doing so may cause electric shock or fire.
- 3) Do not connect the power wire to the indoor unit. Doing so may cause electric shock or fire.

7. Connecting to the HA system.

- 1) Remove the front grille. (3 screws)
- 2) Remove the decelerator assembly parts. (1 screw)
 - 2-1) Remove the decelerator assembly part screws. (See Fig. 1)
 - 2-2) Remove the decelerator assembly part connector. Remove by pressing on the tabs on the bottom of the connector.
(See the tab position diagram 1)
- 3) Remove the electric parts box. (1 screw, 2 tabs)
 - 3-1) Remove the electric parts box fixing screw.
 - 3-2) Pull the electric parts box toward you and discharge the tab2.

Fig. 1

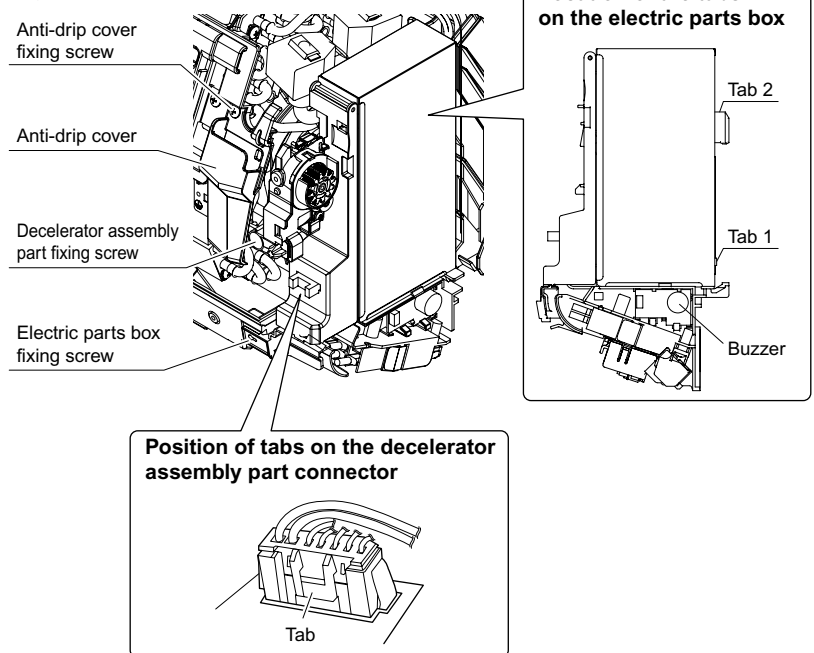

Indoor Unit Installation

- 4) Remove the electric parts box cover. (3 tabs) (Refer to Fig. 2)
 - 4-1) Discharge the tab 3.
 - 4-2) Pull up the electric parts box cover slowly, discharge the tab 4, slide up, and discharge the tab 5.
- 5) Insert the connection cord into the HA connector "S21".

Fig. 2

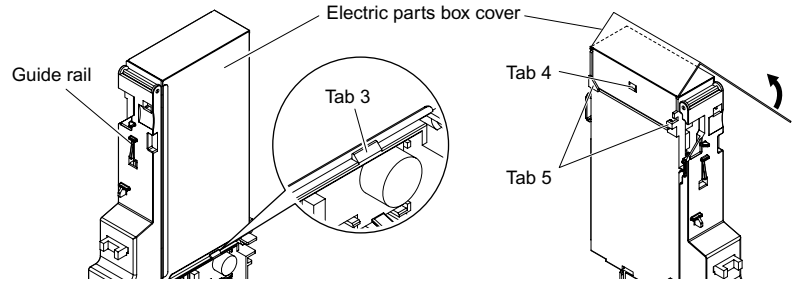

- 6) Lay the connection cord as shown in "Fig. 3".
- 7) Replace the electric parts box cover and electric parts box as they were.
- 8) Attach the decelerator assembly part along with the guide rail. (Refer to Fig. 2)
- 9) Install the front grille.

Fig. 3

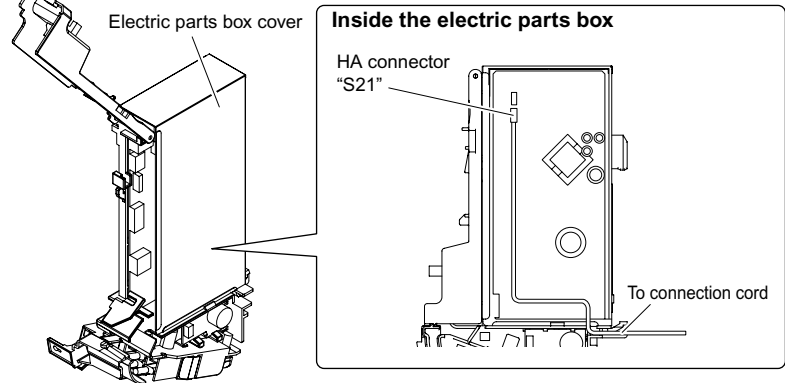

8. Drain piping.

- 1) Connect the drain hose, as described right.
- 2) Remove the air filters and pour some water into the drain pan to check the water flows smoothly.
- 3) When drain hose requires extension, obtain an extension hose commercially available. Be sure to thermally insulate the indoor section of the extension hose.
- 4) When connecting a rigid polyvinyl chloride pipe (nominal diameter 13mm) directly to the drain hose attached to the indoor unit as with embedded piping work, use any commercially available drain socket (nominal diameter 13mm) as a joint.

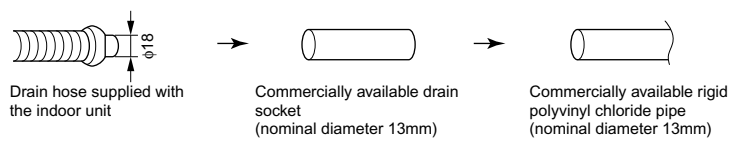
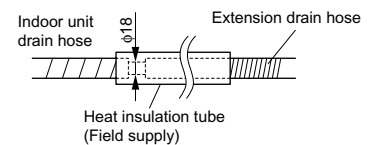
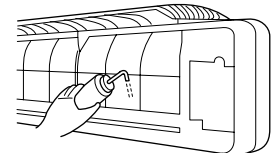
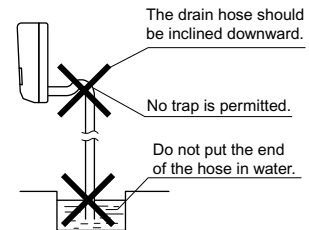

9. Improving installation strength.

- We recommend screwing the indoor unit onto a (A) mounting plate in order to improve the installation strength.
- 1) Remove the front grille.
 - 2) Screw in the indoor unit with (E) fixing screws.
 - 3) Attach the front grille.

Screw position
Front diagram

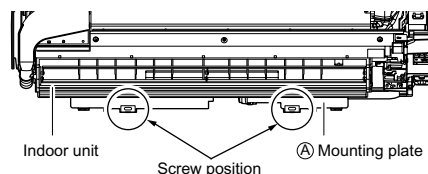

Enlarged diagram

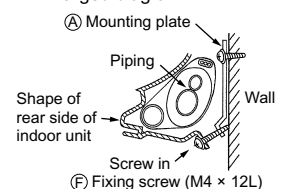

Setting the Humidifying Hose Length

1. Setting the humidifying hose length.

- Set the humidifying hose length to ensure humidifying capacity.
Use the remote controller to set the humidifying hose length.
When doing this, power on the unit as communication is established between the unit and the remote controller.
(The humidifying hose length includes the rear of the indoor unit.)

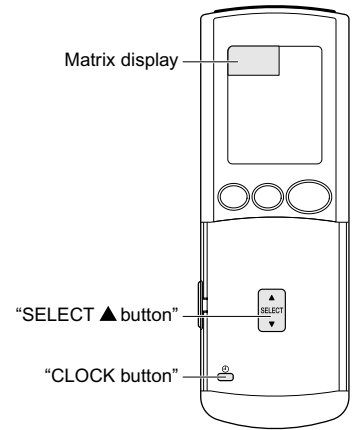

- 1) Hold "CLOCK button" for more than 5 seconds.
(To cancel, do not operate the button for 10 seconds. The display will return to normal.)
- 2) Press "SELECT ▲ button".
Select "SETTING2. PIPE".
- 3) Press "CLOCK button" to activate the hose length setting mode.
(Be sure to direct the remote controller toward the main unit while operating it.)
The display will show the currently set hose length.
(Default is no setting.)
- 4) Press "SELECT ▲ button" to set the humidifying hose length.
Pressing "SELECT ▲ button" changes the hose length.
You may set the hose length to 5 levels, ~3M, 3.1~4M, 4.1~6M, 6.1~8M, 8.1~10M.
- 5) Press "CLOCK button" after selecting the hose length.
(Direct the remote controller toward the main unit while operating it.)
- 6) Hold "CLOCK button" for more than 5 seconds.
The humidifying hose length setting is complete.

Matrix display
SETTING
1. TEST

SETTING
2. PIPE

PIPE LEN
UNDEF

PIPE LEN
~3M

PIPE LEN
3.1~4M

PIPE SET
RESET

PIPE LEN
4.1~6M

(Setting 4.1 to 6m)

⌚ 10:00

(10:00 a.m.)

If you set the wrong humidifying hose length, cancel the setting displaying

"PIPE SET RESET" with the step 4) operation and reset it.

PIPE SET
RESET

2. When the unit cannot be powered on.

- When setting the humidifying hose length without powering on the unit, the display shows "PIPE LEN UNDEF" with the step 5) operation shown above but the remote controller remembers the set hose length.
(When the customer uses the unit, the humidifying hose length information is sent to the indoor unit to be set.)

PIPE LEN
UNDEF

Refrigerant Piping Work

1. Flaring the pipe end.

- 1) Cut the pipe end with a pipe cutter.
- 2) Remove burrs with the cut surface facing downward so that the chips do not enter the pipe.
- 3) Put the flare nut on the pipe.
- 4) Flare the pipe.
- 5) Check that the flaring is properly made.

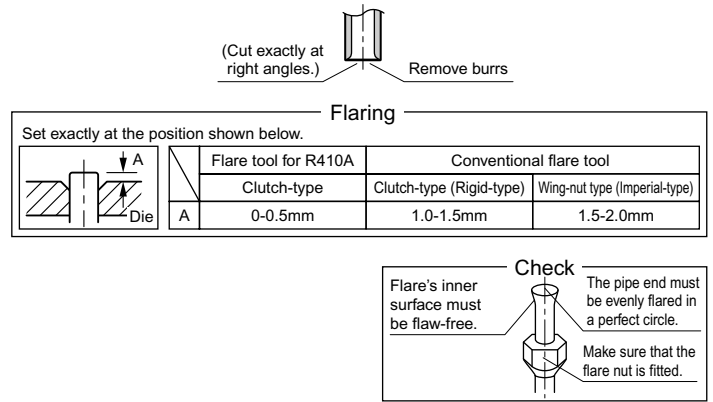

⚠ WARNING

- 1) Do not use mineral oil on flared part.
- 2) Prevent mineral oil from getting into the system as this would reduce the lifetime of the units.
- 3) Never use piping which has been used for previous installations. Only use parts which are delivered with the unit.
- 4) Do never install a drier to this R410A unit in order to guarantee its lifetime.
- 5) The drying material may dissolve and damage the system.
- 6) Incomplete flaring may cause refrigerant gas leakage.

2. Refrigerant piping.

⚠ CAUTION

- 1) Use the flare nut fixed to the main unit. (To prevent cracking of the flare nut by aged deterioration.)
- 2) To prevent gas leakage, apply refrigeration oil only to the inner surface of the flare. (Use refrigeration oil for R410A.)
- 3) Use torque wrenches when tightening the flare nuts to prevent damage to the flare nuts and gas leakage.

Align the centres of both flares and tighten the flare nuts 3 or 4 turns by hand. Then tighten them fully with the torque wrenches.

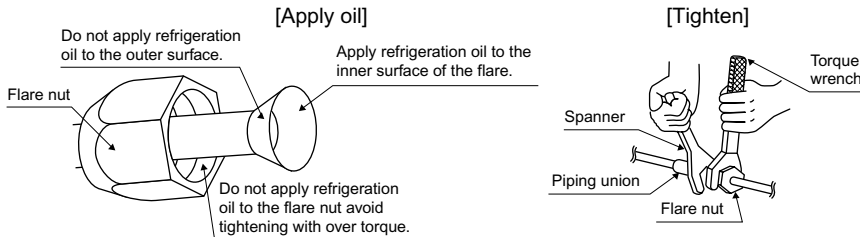

| Flare nut tightening torque | |
|-------------------------------------|-------------------------------------|
| Gas side | Liquid side |
| 3/8 inch | 1/4 inch |
| 32.7-39.9N • m (330-407kgf • cm) | 14.2-17.2N • m (144-175kgf • cm) |

2-1. Caution on piping handling.

- 1) Protect the open end of the pipe against dust and moisture.
- 2) All pipe bends should be as gentle as possible. Use a pipe bender for bending.

2-2. Selection of copper and heat insulation materials.

- When using commercial copper pipes and fittings, observe the following:
 - 1) Insulation material: Polyethylene foam
Heat transfer rate: 0.041 to 0.052W/mK (0.035 to 0.045 kcal/(mh•°C))
Refrigerant gas pipe's surface temperature reaches 110°C max.
Choose heat insulation materials that will withstand this temperature.
 - 2) Be sure to insulate both the gas and liquid piping and to provide insulation dimensions as below.

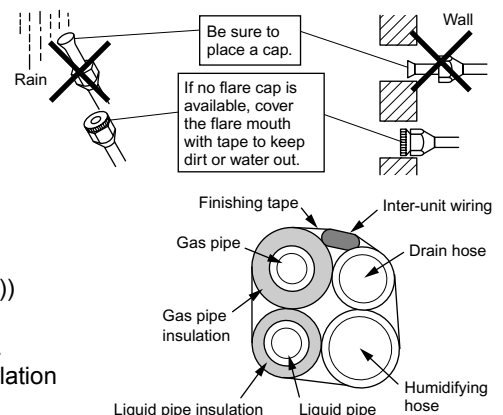

| Gas side | Liquid side | Gas pipe thermal insulation | Liquid pipe thermal insulation |
|----------------------------|-------------|-----------------------------|--------------------------------|
| O.D. 9.5mm | O.D. 6.4mm | I.D. 12-15mm | I.D. 8-10mm |
| Minimum bend radius | | Thickness 10mm Min. | |
| 30mm or more | | | |
| Thickness 0.8mm (C1220T-O) | | | |

- 3) Use separate thermal insulation pipes for gas and liquid refrigerant pipes.

Trial Operation and Testing

1. Trial operation and testing.

1-1. Measure the supply voltage and make sure that it falls in the specified range.

1-2. Trial operation should be carried out in either cooling or heating mode.

- In cooling mode, select the lowest programmable temperature; in heating mode, select the highest programmable temperature.
 - 1) Trial operation may be disabled in either mode depending on the room temperature.
Use the remote controller for trial operation as described below.
 - 2) After trial operation is complete, set the temperature to a normal level (26°C to 28°C in cooling mode, 20°C to 24°C in heating mode).
 - 3) For protection, the system disables restart operation for 3 minutes after it is turned off.

1-3. To perform a test run for humidifying operation, activate test run mode from the remote controller following the instructions below and press the “HUMIDIFY” button.

1-4. Operate the unit in accordance with the operation manual to check that it operates normally.

- Even when the air conditioner is not operating, it consumes some electric power. If the customer is not going to use the unit soon after it is installed, turn off the breaker to avoid wasting electricity.

| Trial operation from remote controller |
|---|
| 1) Hold the “CLOCK” button for 5 seconds. (The matrix display will appear on the remote controller.) 2) Display “SETTING” on the matrix display of the remote controller and press the “CLOCK” button. 3) “7” will be displayed and the unit will enter test run mode. 4) Press the button for test run mode. <ul style="list-style-type: none"> • Test run mode will stop automatically after around 30 minutes. Press the ON/OFF button to force the test-run to stop. |

2. Test items.

| Test items | Symptom (diagnostic display on RC) | Check |
|---|--|-------|
| Indoor and outdoor units are installed properly on solid bases. | Fall, vibration, noise | |
| Did you install the air supply filter? | Noise, water leakage | |
| Did you install the deodorizing filter for the streamer and the titanium apatite photocatalytic air-purifying filter? | Noise, water leakage | |
| Have you performed a gas leak test? | Incomplete cooling/heating function | |
| No refrigerant gas leaks. | Incomplete cooling/heating function | |
| Refrigerant gas and liquid pipes and indoor drain hose extension are thermally insulated. | Water leakage | |
| Draining line is properly installed. | Water leakage | |
| Does the drain hose produce abnormal noise (perking sound) when using the ventilation fan or others? | Use of separately sold air cut drain plug. | |
| System is properly earthed. | Electrical leakage | |
| The specified wires are used for inter-unit wiring connections. | Inoperative or burn damage | |
| Indoor or outdoor unit’s air intake or exhaust has clear path of air. Stop valves are opened. | Incomplete cooling/heating function | |
| Indoor unit properly receives remote controller commands. | Inoperative | |
| Did you check the address setting? | Inoperative | |
| Did you set the humidifying hose length? | <ul style="list-style-type: none"> • LED lamp blinks at power on. • The buzzer sounds during a test run. • Poor performance and noise | |

DAIKIN INDUSTRIES, LTD.

Head office:
Umeda Center Bldg., 2-4-12, Nakazaki-Nishi,
Kita-ku, Osaka, 530-8323 Japan

Tokyo office:
JR Shinagawa East Bldg., 2-18-1, Konan,
Minato-ku, Tokyo, 108-0075 Japan
http://www.daikin.com/global_ac/

DAIKIN EUROPE NV

Zandvoordestraat 300, B-8400 Oostende, Belgium



Two-dimensional bar code is a code for manufacturing.

3P190651-1J

M06B103D (1012) HT