



technical data

Wall Mounted Unit
FXAQ-P

air conditioning systems

R-410A



technical data

Wall Mounted Unit
FXAQ-P

air conditioning systems

R-410A

TABLE OF CONTENTS

FXAQ-P

1	Specifications	2
	Technical Specifications	2
	Electrical Specifications (50Hz)	3
2	Safety device settings	4
3	Options	4
4	Capacity tables	5
	Cooling capacity tables	5
	Heating capacity tables	7
5	Dimensional drawing & centre of gravity	9
	Dimensional drawing	9
6	Piping diagram	11
7	Wiring diagram	12
	Wiring diagram	12
8	Sound data	13
	Sound pressure spectrum	13
9	Installation	15
	Drainage instructions	15
	Service space	16

1 Specifications

1-1 Technical Specifications				FXAQ20P	FXAQ25P	FXAQ32P	FXAQ40P	FXAQ50P	FXAQ63P
Capacity	Cooling	kW	2.2	2.8	3.6	4.5	5.6	7.1	
	Heating	kW	2.5	3.2	4.0	5.0	6.3	8.0	
Power Input (50Hz)	Cooling	kW	0.019	0.028	0.030	0.020	0.033	0.050	
	Heating	kW	0.029	0.034	0.035	0.020	0.039	0.060	
Casing	Colour	white (3.0Y8.5/0.5)							
Dimensions	Unit	Height	mm	290					
		Width	mm	795			1,050		
		Depth	mm	238					
Weight	Unit	kg	11			14			
Heat Exchanger	Dimensions	Nr of Rows		2					
		Fin Pitch	mm	1.4					
		Face Area	m ²	0.161			0.213		
		Nr of Stages		14					
Fan	Type	Cross flow fan							
Fan - Air flow rate (50Hz)	Cooling	High	m ³ /min	7.5	8	8.5	12	15	19
		Low	m ³ /min	4.5	5	5.5	9	12	14
Fan	Motor	Model		QCL9661M			QCL9686M		
		Output (high)	W	40			43		
		Drive		Direct drive					
Refrigerant	Name	R-410A							
Piping connections	Liquid (OD)	Type		Flare connection					
		Diameter	mm	6.35			9.52		
	Gas	Type		Flare connection					
		Diameter	mm	12.7			15.9		
	Drain	Diameter	mm	VP13 (I.D. 13/O.D. 18)					
Heat Insulation		Foamed polystyrene/foamed polyethylene							
Air Filter	Washable resin net								
Refrigerant control	Electronic expansion valve								
Temperature control	Microprocessor thermostat for cooling and heating								
Safety devices	Fuse								
Standard Accessories	Installation and operation manual								
	Installation panel								
	Paper pattern for installation								
	Insulation tape								
	Clamps								
	Screws								
Notes	Le capacità di raffreddamento nominali si riferiscono a: temperatura interna: 27°CBS, 19°CBU, temperatura esterna: 35°CBS, lunghezza equivalente del circuito frigorifero: 7,5m, dislivello: 0m.								
	Le capacità di riscaldamento nominali si riferiscono a: temperatura interna: 20°CBS, temperatura acqua in entrata: 20°C, lunghezza equivalente del circuito frigorifero: 7,5m, dislivello: 0m								
	Capacities are net, including a deduction for cooling (an addition for heating) for indoor fan motor heat.								

1 Specifications

1-2 Electrical Specifications (50Hz)			FXAQ20P	FXAQ25P	FXAQ32P	FXAQ40P	FXAQ50P	FXAQ63P
Power Supply	Name		V1					
	Phase		1~					
	Frequency	Hz	50					
	Voltage	V	220-240					
Current	Minimum circuit amps (MCA)	A	0.3	0.4		0.5		0.6
	Maximum fuse amps (MFA)	A	16					
	Full load amps (FLA)	A	0.2	0.3		0.4		0.5
Voltage range	Minimum	V	-10%					
	Maximum	V	+10%					
Notes			Voltage range : units are suitable for use on electrical systems where voltage supplied to unit terminals is not below or above listed range limits.					
			Maximum allowable voltage range variation between phases is 2%.					
			MCA/MFA : MCA = 1.25 x FLA					
			MFA is smaller than or equal to 4 x FLA					
			Next lower standard fuse rating minimum 16A					
			Select wire size based on the MCA					
			Instead of a fuse, use a circuit breaker					

2 Safety device settings

FXAQ20-63P

	FXAQ20P	FXAQ25P	FXAQ32P	FXAQ40P	FXAQ50P	FXAQ63P
PC BOARD FUSE	250V 3.15A					

4D034906J

3 Options

FXAQ20-63P

Individual control systems

	FXAQ20P	FXAQ25P	FXAQ32P	FXAQ40P	FXAQ50P	FXAQ63P
WIRED REMOTE CONTROL	BRC1D52/BRC1E51A					
INFRARED REMOTE CONTROL	Heat pump					
	Cooling only					

Centralised control systems

	FXAQ20P	FXAQ25P	FXAQ32P	FXAQ40P	FXAQ50P	FXAQ63P
CENTRALISED REMOTE CONTROL	DCS302C51					
UNIFIED ON/OFF CONTROL	DCS301B51					
SCHEDULE TIMER	DST301B51					

Others

	FXAQ20P	FXAQ25P	FXAQ32P	FXAQ40P	FXAQ50P	FXAQ63P
WIRING ADAPTER FOR ELECTRICAL APPENDICES (1)	KRP2A51#					
WIRING ADAPTER FOR ELECTRICAL APPENDICES (2)	KRP4A51#					
INSTALLATION BOX FOR ADAPTER PCB (2) (3)	KRP4A93					
REMOTE SENSOR	KRCS01-1					
ELECTRICAL BOX WITH EARTH TERMINAL (3 BLOCKS)	KJB311A					
ELECTRICAL BOX WITH EARTH TERMINAL (2 BLOCKS)	KJB212A					
NOISE FILTER (FOR ELECTROMAGNETIC INTERFACE USE ONLY)	KEK26-1					
EXTERNAL CONTROL ADAPTER FOR OUTDOOR UNITS (INSTALLATION ON INDOOR UNIT)	DTA104A61#					
DRAIN PUMP KIT	K-DU572EVE					
ADAPTER FOR MULTI TENANT	DTA114A61					

3D023974M

NOTES

- 1 Installation box is necessary for each adapter marked with #.
- 2 Up to 2 adapters can be fixed per installation box.
- 3 Only 1 installation box can be installed per indoor unit.

4 Capacity tables

4 - 1 Cooling capacity tables

FXAQ-P		TC: Total capacity; kW - SHC: Sensible capacity; kW														
Unit size	Nominal capacity	Outdoor air temp.	Indoor air temperature													
			14.OWB		16.OWB		18.OWB		19.OWB		20.OWB		22.OWB		24.OWB	
			20.0DB	23.0DB	26.0DB	27.0DB	28.0DB	30.0DB	32.0DB	°CDB	TC	SHC	TC	SHC	TC	SHC
20	2.2	10.0	1.5	1.5	1.8	1.8	2.1	1.9	2.2	1.9	2.3	1.9	2.6	2.0	2.9	1.9
		12.0	1.5	1.5	1.8	1.8	2.1	1.9	2.2	1.9	2.3	1.9	2.6	2.0	2.9	1.9
		14.0	1.5	1.5	1.8	1.8	2.1	1.9	2.2	1.9	2.3	1.9	2.6	2.0	2.8	1.9
		16.0	1.5	1.5	1.8	1.8	2.1	1.9	2.2	1.9	2.3	1.9	2.6	2.0	2.8	1.9
		18.0	1.5	1.5	1.8	1.8	2.1	1.9	2.2	1.9	2.3	1.9	2.6	2.0	2.7	1.9
		20.0	1.5	1.5	1.8	1.8	2.1	1.9	2.2	1.9	2.3	1.9	2.6	2.0	2.7	1.9
		21.0	1.5	1.5	1.8	1.8	2.1	1.9	2.2	1.9	2.3	1.9	2.6	2.0	2.7	1.9
		23.0	1.5	1.5	1.8	1.8	2.1	1.9	2.2	1.9	2.3	1.9	2.6	1.9	2.6	1.9
		25.0	1.5	1.5	1.8	1.8	2.1	1.9	2.2	1.9	2.3	1.9	2.6	1.9	2.6	1.9
		27.0	1.5	1.5	1.8	1.8	2.1	1.9	2.2	1.9	2.3	1.9	2.5	1.9	2.6	1.8
		29.0	1.5	1.5	1.8	1.8	2.1	1.9	2.2	1.9	2.3	1.9	2.5	1.9	2.5	1.8
		31.0	1.5	1.5	1.8	1.8	2.1	1.9	2.2	1.9	2.3	1.9	2.4	1.9	2.5	1.8
		33.0	1.5	1.5	1.8	1.8	2.1	1.9	2.2	1.9	2.3	1.9	2.4	1.9	2.5	1.8
		35.0	1.5	1.5	1.8	1.8	2.1	1.9	2.2	1.9	2.3	1.9	2.4	1.9	2.4	1.8
37.0	1.5	1.5	1.8	1.8	2.1	1.9	2.2	1.9	2.3	1.9	2.3	1.8	2.4	1.7		
39.0	1.5	1.5	1.8	1.8	2.1	1.9	2.2	1.9	2.2	1.9	2.2	1.9	2.3	1.8	2.3	1.7
25	2.8	10.0	1.9	1.8	2.3	2.0	2.6	2.2	2.8	2.2	3.0	2.2	3.4	2.3	3.7	2.3
		12.0	1.9	1.8	2.3	2.0	2.6	2.2	2.8	2.2	3.0	2.2	3.4	2.3	3.6	2.2
		14.0	1.9	1.8	2.3	2.0	2.6	2.2	2.8	2.2	3.0	2.2	3.4	2.3	3.6	2.3
		16.0	1.9	1.8	2.3	2.0	2.6	2.2	2.8	2.2	3.0	2.2	3.4	2.3	3.5	2.2
		18.0	1.9	1.8	2.3	2.0	2.6	2.2	2.8	2.2	3.0	2.2	3.4	2.3	3.5	2.2
		20.0	1.9	1.8	2.3	2.0	2.6	2.2	2.8	2.2	3.0	2.2	3.4	2.3	3.4	2.2
		21.0	1.9	1.8	2.3	2.0	2.6	2.2	2.8	2.2	3.0	2.2	3.4	2.3	3.4	2.2
		23.0	1.9	1.8	2.3	2.0	2.6	2.2	2.8	2.2	3.0	2.2	3.3	2.3	3.4	2.2
		25.0	1.9	1.8	2.3	2.0	2.6	2.2	2.8	2.2	3.0	2.2	3.3	2.2	3.3	2.2
		27.0	1.9	1.8	2.3	2.0	2.6	2.2	2.8	2.2	3.0	2.2	3.2	2.2	3.3	2.1
		29.0	1.9	1.8	2.3	2.0	2.6	2.2	2.8	2.2	3.0	2.2	3.2	2.2	3.2	2.1
		31.0	1.9	1.8	2.3	2.0	2.6	2.2	2.8	2.2	3.0	2.2	3.1	2.2	3.2	2.1
		33.0	1.9	1.8	2.3	2.0	2.6	2.2	2.8	2.2	3.0	2.2	3.1	2.2	3.1	2.1
		35.0	1.9	1.8	2.3	2.0	2.6	2.2	2.8	2.2	3.0	2.2	3.0	2.2	3.1	2.1
37.0	1.9	1.8	2.3	2.0	2.6	2.2	2.8	2.2	2.9	2.2	3.0	2.1	3.0	2.0		
39.0	1.9	1.8	2.3	2.0	2.6	2.2	2.8	2.2	2.9	2.2	2.9	2.1	3.0	2.0		
32	3.6	10.0	2.4	2.2	2.9	2.4	3.4	2.6	3.6	2.7	3.8	2.7	4.3	2.8	4.7	2.8
		12.0	2.4	2.2	2.9	2.4	3.4	2.6	3.6	2.7	3.8	2.7	4.3	2.8	4.7	2.8
		14.0	2.4	2.2	2.9	2.4	3.4	2.6	3.6	2.7	3.8	2.7	4.3	2.8	4.6	2.8
		16.0	2.4	2.2	2.9	2.4	3.4	2.6	3.6	2.7	3.8	2.7	4.3	2.8	4.6	2.8
		18.0	2.4	2.2	2.9	2.4	3.4	2.6	3.6	2.7	3.8	2.7	4.3	2.8	4.5	2.7
		20.0	2.4	2.2	2.9	2.4	3.4	2.6	3.6	2.7	3.8	2.7	4.3	2.8	4.4	2.7
		21.0	2.4	2.2	2.9	2.4	3.4	2.6	3.6	2.7	3.8	2.7	4.3	2.8	4.4	2.7
		23.0	2.4	2.2	2.9	2.4	3.4	2.6	3.6	2.7	3.8	2.7	4.2	2.8	4.3	2.7
		25.0	2.4	2.2	2.9	2.4	3.4	2.6	3.6	2.7	3.8	2.7	4.2	2.8	4.3	2.6
		27.0	2.4	2.2	2.9	2.4	3.4	2.6	3.6	2.7	3.8	2.7	4.1	2.7	4.2	2.6
		29.0	2.4	2.2	2.9	2.4	3.4	2.6	3.6	2.7	3.8	2.7	4.1	2.7	4.2	2.6
		31.0	2.4	2.2	2.9	2.4	3.4	2.6	3.6	2.7	3.8	2.7	4.0	2.7	4.1	2.6
		33.0	2.4	2.2	2.9	2.4	3.4	2.6	3.6	2.7	3.8	2.7	3.9	2.6	4.0	2.5
		35.0	2.4	2.2	2.9	2.4	3.4	2.6	3.6	2.7	3.8	2.7	3.9	2.6	4.0	2.5
37.0	2.4	2.2	2.9	2.4	3.4	2.6	3.6	2.7	3.7	2.6	3.8	2.6	3.9	2.5		
39.0	2.4	2.2	2.9	2.4	3.4	2.6	3.6	2.7	3.7	2.6	3.8	2.6	3.8	2.5		
40	4.5	10.0	3.0	2.9	3.6	3.3	4.2	3.7	4.5	3.5	4.8	3.6	5.4	3.6	5.9	3.6
		12.0	3.0	2.9	3.6	3.3	4.2	3.7	4.5	3.5	4.8	3.6	5.4	3.6	5.8	3.5
		14.0	3.0	2.9	3.6	3.3	4.2	3.7	4.5	3.5	4.8	3.6	5.4	3.6	5.8	3.5
		16.0	3.0	2.9	3.6	3.3	4.2	3.7	4.5	3.5	4.8	3.6	5.4	3.6	5.7	3.5
		18.0	3.0	2.9	3.6	3.3	4.2	3.7	4.5	3.5	4.8	3.6	5.4	3.6	5.6	3.4
		20.0	3.0	2.9	3.6	3.3	4.2	3.7	4.5	3.5	4.8	3.6	5.4	3.6	5.5	3.4
		21.0	3.0	2.9	3.6	3.3	4.2	3.7	4.5	3.5	4.8	3.6	5.4	3.6	5.5	3.4
		23.0	3.0	2.9	3.6	3.3	4.2	3.7	4.5	3.5	4.8	3.6	5.3	3.6	5.4	3.3
		25.0	3.0	2.9	3.6	3.3	4.2	3.7	4.5	3.5	4.8	3.6	5.2	3.6	5.3	3.3
		27.0	3.0	2.9	3.6	3.3	4.2	3.7	4.5	3.5	4.8	3.6	5.2	3.5	5.3	3.3
		29.0	3.0	2.9	3.6	3.3	4.2	3.7	4.5	3.5	4.8	3.6	5.1	3.5	5.2	3.2
		31.0	3.0	2.9	3.6	3.3	4.2	3.7	4.5	3.5	4.8	3.6	5.0	3.4	5.1	3.2
		33.0	3.0	2.9	3.6	3.3	4.2	3.7	4.5	3.5	4.8	3.6	4.9	3.4	5.0	3.1
		35.0	3.0	2.9	3.6	3.3	4.2	3.7	4.5	3.5	4.7	3.6	4.9	3.4	5.0	3.1
37.0	3.0	2.9	3.6	3.3	4.2	3.7	4.5	3.5	4.7	3.5	4.8	3.3	4.9	3.1		
39.0	3.0	2.9	3.6	3.3	4.2	3.7	4.5	3.5	4.6	3.5	4.7	3.3	4.8	3.0		

4 Capacity tables

4 - 1 Cooling capacity tables

FXAQ-P																
Unit size	Nominal capacity	Outdoor air temp. °CDB	Indoor air temperature													
			14.0WB		16.0WB		18.0WB		19.0WB		20.0WB		22.0WB		24.0WB	
			20.0DB		23.0DB		26.0DB		27.0DB		28.0DB		30.0DB		32.0DB	
			TC	SHC	TC	SHC	TC	SHC	TC	SHC	TC	SHC	TC	SHC	TC	SHC
50	5.6	10.0	3.8	3.2	4.5	3.7	5.2	4.1	5.6	4.2	6.0	4.3	6.7	4.4	7.4	4.4
		12.0	3.8	3.2	4.5	3.7	5.2	4.1	5.6	4.2	6.0	4.3	6.7	4.4	7.3	4.3
		14.0	3.8	3.2	4.5	3.7	5.2	4.1	5.6	4.2	6.0	4.3	6.7	4.4	7.2	4.3
		16.0	3.8	3.2	4.5	3.7	5.2	4.1	5.6	4.2	6.0	4.3	6.7	4.4	7.1	4.3
		18.0	3.8	3.2	4.5	3.7	5.2	4.1	5.6	4.2	6.0	4.3	6.7	4.4	7.0	4.2
		20.0	3.8	3.2	4.5	3.7	5.2	4.1	5.6	4.2	6.0	4.3	6.7	4.4	6.9	4.2
		21.0	3.8	3.2	4.5	3.7	5.2	4.1	5.6	4.2	6.0	4.3	6.7	4.4	6.8	4.2
		23.0	3.8	3.2	4.5	3.7	5.2	4.1	5.6	4.2	6.0	4.3	6.6	4.4	6.7	4.1
		25.0	3.8	3.2	4.5	3.7	5.2	4.1	5.6	4.2	6.0	4.3	6.5	4.3	6.6	4.1
		27.0	3.8	3.2	4.5	3.7	5.2	4.1	5.6	4.2	6.0	4.3	6.4	4.3	6.6	4.0
		29.0	3.8	3.2	4.5	3.7	5.2	4.1	5.6	4.2	6.0	4.3	6.3	4.2	6.5	4.0
		31.0	3.8	3.2	4.5	3.7	5.2	4.1	5.6	4.2	6.0	4.3	6.2	4.2	6.4	3.9
		33.0	3.8	3.2	4.5	3.7	5.2	4.1	5.6	4.2	6.0	4.3	6.1	4.2	6.3	3.9
		35.0	3.8	3.2	4.5	3.7	5.2	4.1	5.6	4.2	5.9	4.3	6.0	4.1	6.2	3.8
		37.0	3.8	3.2	4.5	3.7	5.2	4.1	5.6	4.2	5.8	4.3	5.9	4.1	6.1	3.8
39.0	3.8	3.2	4.5	3.7	5.2	4.1	5.6	4.2	5.7	4.2	5.8	4.0	6.0	3.8		
63	7.1	10.0	4.8	4.1	5.7	4.6	6.6	5.1	7.1	5.3	7.6	5.4	8.5	5.6	9.3	5.3
		12.0	4.8	4.1	5.7	4.6	6.6	5.1	7.1	5.3	7.6	5.4	8.5	5.6	9.2	5.3
		14.0	4.8	4.1	5.7	4.6	6.6	5.1	7.1	5.3	7.6	5.4	8.5	5.6	9.1	5.2
		16.0	4.8	4.1	5.7	4.6	6.6	5.1	7.1	5.3	7.6	5.4	8.5	5.6	9.0	5.2
		18.0	4.8	4.1	5.7	4.6	6.6	5.1	7.1	5.3	7.6	5.4	8.5	5.6	8.8	5.2
		20.0	4.8	4.1	5.7	4.6	6.6	5.1	7.1	5.3	7.6	5.4	8.5	5.6	8.7	5.1
		21.0	4.8	4.1	5.7	4.6	6.6	5.1	7.1	5.3	7.6	5.4	8.5	5.6	8.7	5.1
		23.0	4.8	4.1	5.7	4.6	6.6	5.1	7.1	5.3	7.6	5.4	8.4	5.5	8.5	5.0
		25.0	4.8	4.1	5.7	4.6	6.6	5.1	7.1	5.3	7.6	5.4	8.3	5.5	8.4	5.0
		27.0	4.8	4.1	5.7	4.6	6.6	5.1	7.1	5.3	7.6	5.4	8.1	5.4	8.3	4.9
		29.0	4.8	4.1	5.7	4.6	6.6	5.1	7.1	5.3	7.6	5.4	8.0	5.4	8.2	4.9
		31.0	4.8	4.1	5.7	4.6	6.6	5.1	7.1	5.3	7.6	5.4	7.9	5.3	8.1	4.8
		33.0	4.8	4.1	5.7	4.6	6.6	5.1	7.1	5.3	7.6	5.4	7.8	5.2	7.9	4.8
		35.0	4.8	4.1	5.7	4.6	6.6	5.1	7.1	5.3	7.5	5.4	7.7	5.2	7.8	4.7
		37.0	4.8	4.1	5.7	4.6	6.6	5.1	7.1	5.3	7.4	5.3	7.5	5.1	7.7	4.7
39.0	4.8	4.1	5.7	4.6	6.6	5.1	7.1	5.3	7.2	5.3	7.4	5.1	7.6	4.6		

4 Capacity tables

4 - 2 Heating capacity tables

FXAQ-P									
Unit Size	Nominal capacity	Outdoor air temperature		Indoor air temperature °CDB					
				16.0	18.0	20.0	21.0	22.0	24.0
		°CDB	°CWB	kW	kW	kW	kW	kW	kW
20	2.5	-19.8	-20.0	1.5	1.5	1.5	1.5	1.5	1.5
		-18.8	-19.0	1.5	1.5	1.5	1.5	1.5	1.5
		-16.7	-17.0	1.6	1.6	1.6	1.6	1.6	1.6
		-14.7	-15.0	1.7	1.7	1.7	1.7	1.7	1.7
		-12.6	-13.0	1.8	1.8	1.8	1.8	1.8	1.8
		-10.5	-11.0	1.9	1.9	1.9	1.9	1.9	1.9
		-9.5	-10.0	1.9	1.9	1.9	1.9	1.9	1.9
		-8.5	-9.1	2.0	2.0	1.9	1.9	1.9	1.9
		-7.0	-7.6	2.0	2.0	2.0	2.0	2.0	2.0
		-5.0	-5.6	2.1	2.1	2.1	2.1	2.1	2.1
		-3.0	-3.7	2.2	2.2	2.2	2.2	2.2	2.2
		0.0	-0.7	2.3	2.3	2.3	2.3	2.3	2.2
		3.0	2.2	2.5	2.5	2.4	2.4	2.3	2.2
		5.0	4.1	2.5	2.5	2.5	2.4	2.3	2.2
		7.0	6.0	2.6	2.6	2.5	2.4	2.3	2.2
9.0	7.9	2.7	2.7	2.5	2.4	2.3	2.2		
11.0	9.8	2.8	2.7	2.5	2.4	2.3	2.2		
13.0	11.8	2.8	2.7	2.5	2.4	2.3	2.2		
15.0	13.7	2.8	2.7	2.5	2.4	2.3	2.2		
25	3.2	-19.8	-20.0	1.9	1.9	1.9	1.9	1.9	1.9
		-18.8	-19.0	1.9	1.9	1.9	1.9	1.9	1.9
		-16.7	-17.0	2.1	2.1	2.0	2.0	2.0	2.0
		-14.7	-15.0	2.2	2.2	2.2	2.2	2.2	2.1
		-12.6	-13.0	2.3	2.3	2.3	2.3	2.3	2.3
		-10.5	-11.0	2.4	2.4	2.4	2.4	2.4	2.4
		-9.5	-10.0	2.5	2.4	2.4	2.4	2.4	2.4
		-8.5	-9.1	2.5	2.5	2.5	2.5	2.5	2.5
		-7.0	-7.6	2.6	2.6	2.6	2.6	2.6	2.6
		-5.0	-5.6	2.7	2.7	2.7	2.7	2.7	2.7
		-3.0	-3.7	2.8	2.8	2.8	2.8	2.8	2.8
		0.0	-0.7	3.0	3.0	3.0	3.0	3.0	2.8
		3.0	2.2	3.1	3.1	3.1	3.1	3.0	2.8
		5.0	4.1	3.3	3.2	3.2	3.1	3.0	2.8
		7.0	6.0	3.4	3.4	3.2	3.1	3.0	2.8
9.0	7.9	3.5	3.4	3.2	3.1	3.0	2.8		
11.0	9.8	3.6	3.4	3.2	3.1	3.0	2.8		
13.0	11.8	3.6	3.4	3.2	3.1	3.0	2.8		
15.0	13.7	3.6	3.4	3.2	3.1	3.0	2.8		
32	4.0	-19.8	-20.0	2.4	2.4	2.3	2.3	2.3	2.3
		-18.8	-19.0	2.4	2.4	2.4	2.4	2.4	2.4
		-16.7	-17.0	2.6	2.6	2.6	2.6	2.6	2.5
		-14.7	-15.0	2.7	2.7	2.7	2.7	2.7	2.7
		-12.6	-13.0	2.9	2.8	2.8	2.8	2.8	2.8
		-10.5	-11.0	3.0	3.0	3.0	3.0	3.0	3.0
		-9.5	-10.0	3.1	3.1	3.1	3.1	3.0	3.0
		-8.5	-9.1	3.1	3.1	3.1	3.1	3.1	3.1
		-7.0	-7.6	3.2	3.2	3.2	3.2	3.2	3.2
		-5.0	-5.6	3.4	3.4	3.4	3.4	3.4	3.4
		-3.0	-3.7	3.5	3.5	3.5	3.5	3.5	3.5
		0.0	-0.7	3.7	3.7	3.7	3.7	3.7	3.5
		3.0	2.2	3.9	3.9	3.9	3.9	3.7	3.5
		5.0	4.1	4.1	4.1	4.0	3.9	3.7	3.5
		7.0	6.0	4.2	4.2	4.0	3.9	3.7	3.5
9.0	7.9	4.3	4.3	4.0	3.9	3.7	3.5		
11.0	9.8	4.5	4.3	4.0	3.9	3.7	3.5		
13.0	11.8	4.5	4.3	4.0	3.9	3.7	3.5		
15.0	13.7	4.5	4.3	4.0	3.9	3.7	3.5		
40	5.0	-19.8	-20.0	3.0	2.9	2.9	2.9	2.9	2.9
		-18.8	-19.0	3.0	3.0	3.0	3.0	3.0	3.0
		-16.7	-17.0	3.2	3.2	3.2	3.2	3.2	3.2
		-14.7	-15.0	3.4	3.4	3.4	3.4	3.4	3.4
		-12.6	-13.0	3.6	3.6	3.6	3.5	3.5	3.5
		-10.5	-11.0	3.7	3.7	3.7	3.7	3.7	3.7
		-9.5	-10.0	3.8	3.8	3.8	3.8	3.8	3.8
		-8.5	-9.1	3.9	3.9	3.9	3.9	3.9	3.9
		-7.0	-7.6	4.0	4.0	4.0	4.0	4.0	4.0
		-5.0	-5.6	4.2	4.2	4.2	4.2	4.2	4.2
		-3.0	-3.7	4.4	4.4	4.4	4.4	4.4	4.4
		0.0	-0.7	4.7	4.6	4.6	4.6	4.6	4.4
		3.0	2.2	4.9	4.9	4.9	4.8	4.7	4.4
		5.0	4.1	5.1	5.1	5.0	4.8	4.7	4.4
		7.0	6.0	5.2	5.2	5.0	4.8	4.7	4.4
9.0	7.9	5.4	5.3	5.0	4.8	4.7	4.4		
11.0	9.8	5.6	5.3	5.0	4.8	4.7	4.4		
13.0	11.8	5.6	5.3	5.0	4.8	4.7	4.4		
15.0	13.7	5.6	5.3	5.0	4.8	4.7	4.4		

4 Capacity tables

4 - 2 Heating capacity tables

FXAQ-P									
Unit Size	Nominal capacity	Outdoor air temperature		Indoor air temperature °CDB					
				16.0	18.0	20.0	21.0	22.0	24.0
		°CDB	°CWB	kW	kW	kW	kW	kW	kW
50	6.3	-19.8	-20.0	3.7	3.7	3.7	3.7	3.7	3.7
		-18.8	-19.0	3.8	3.8	3.8	3.8	3.8	3.8
		-16.7	-17.0	4.1	4.0	4.0	4.0	4.0	4.0
		-14.7	-15.0	4.3	4.3	4.3	4.2	4.2	4.2
		-12.6	-13.0	4.5	4.5	4.5	4.5	4.5	4.5
		-10.5	-11.0	4.7	4.7	4.7	4.7	4.7	4.7
		-9.5	-10.0	4.8	4.8	4.8	4.8	4.8	4.8
		-8.5	-9.1	4.9	4.9	4.9	4.9	4.9	4.9
		-7.0	-7.6	5.1	5.1	5.1	5.1	5.1	5.1
		-5.0	-5.6	5.3	5.3	5.3	5.3	5.3	5.3
		-3.0	-3.7	5.5	5.5	5.5	5.5	5.5	5.5
		0.0	-0.7	5.9	5.9	5.8	5.8	5.8	5.8
		3.0	2.2	6.2	6.2	6.2	6.1	5.9	5.5
		5.0	4.1	6.4	6.4	6.3	6.1	5.9	5.5
		7.0	6.0	6.6	6.6	6.3	6.1	5.9	5.5
		9.0	7.9	6.8	6.7	6.3	6.1	5.9	5.5
11.0	9.8	7.0	6.7	6.3	6.1	5.9	5.5		
13.0	11.8	7.1	6.7	6.3	6.1	5.9	5.5		
15.0	13.7	7.1	6.7	6.3	6.1	5.9	5.5		
63	8.0	-19.8	-20.0	4.7	4.7	4.7	4.7	4.7	4.7
		-18.8	-19.0	4.9	4.9	4.8	4.8	4.8	4.8
		-16.7	-17.0	5.1	5.1	5.1	5.1	5.1	5.1
		-14.7	-15.0	5.4	5.4	5.4	5.4	5.4	5.4
		-12.6	-13.0	5.7	5.7	5.7	5.7	5.7	5.7
		-10.5	-11.0	6.0	6.0	6.0	6.0	6.0	5.9
		-9.5	-10.0	6.1	6.1	6.1	6.1	6.1	6.1
		-8.5	-9.1	6.3	6.3	6.2	6.2	6.2	6.2
		-7.0	-7.6	6.5	6.5	6.4	6.4	6.4	6.4
		-5.0	-5.6	6.8	6.7	6.7	6.7	6.7	6.7
		-3.0	-3.7	7.0	7.0	7.0	7.0	7.0	7.0
		0.0	-0.7	7.5	7.4	7.4	7.4	7.4	7.0
		3.0	2.2	7.9	7.8	7.8	7.7	7.5	7.0
		5.0	4.1	8.1	8.1	8.0	7.7	7.5	7.0
		7.0	6.0	8.4	8.4	8.0	7.7	7.5	7.0
		9.0	7.9	8.7	8.5	8.0	7.7	7.5	7.0
11.0	9.8	8.9	8.5	8.0	7.7	7.5	7.0		
13.0	11.8	9.0	8.5	8.0	7.7	7.5	7.0		
15.0	13.7	9.0	8.5	8.0	7.7	7.5	7.0		

5 Dimensional drawing & centre of gravity

5 - 1 Dimensional drawing

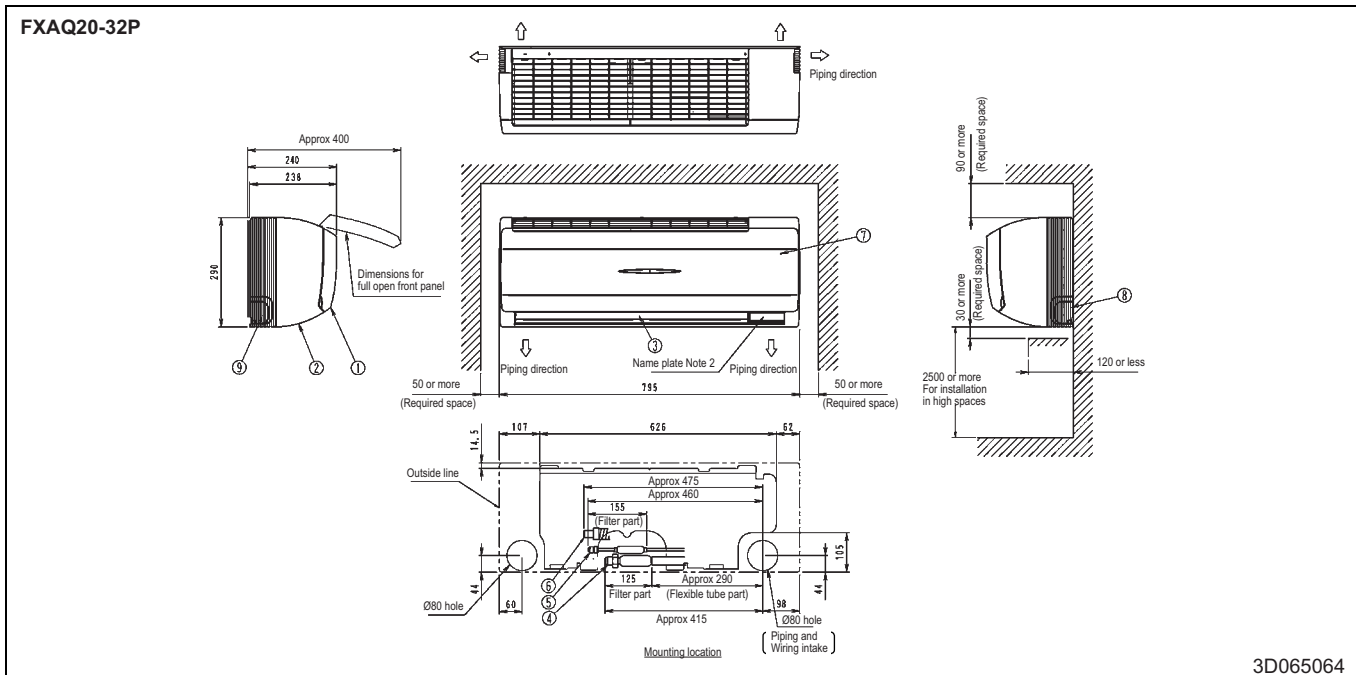

3D065064

Nr	Name	Description
1	Front panel	
2	Front grill	
3	Air outlet	
4	Gas pipe	Ø12.7mm Flare connection
5	Liquid pipe	Ø6.4mm Flare connection
6	Drain hose	VP13 (External dia. Ø18)
7	Grounding terminal	M4
8	Right side pipe connection hole	
9	Left side pipe connection hole	

- NOTES**
- 1 Location of unit's Name Plate: Right side surface of casing.
 - 2 In case of using infrared remote control, this position will be a signal receiver. Refer to the drawing of infrared remote control in detail.

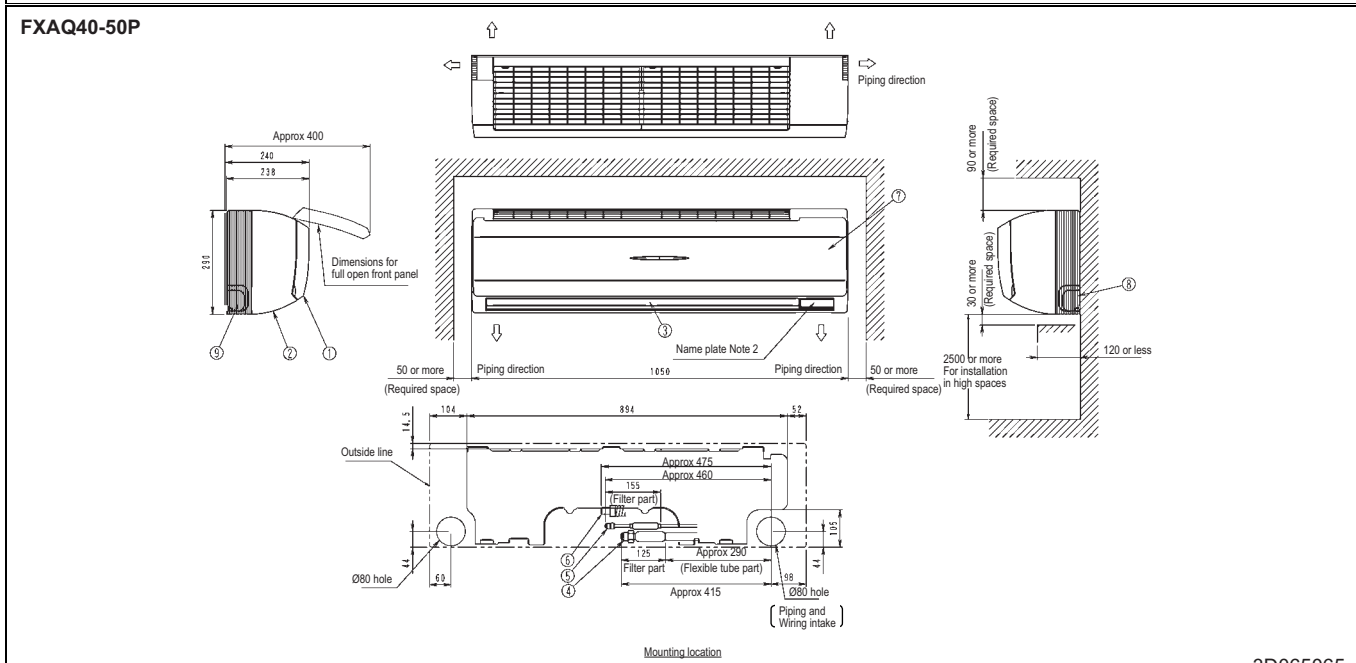

3D065065

Nr	Name	Description
1	Front panel	
2	Front grill	
3	Air outlet	
4	Gas pipe	Ø12.7mm Flare connection
5	Liquid pipe	Ø6.4mm Flare connection
6	Drain hose	VP13 (External dia. Ø18)
7	Grounding terminal	M4
8	Right side pipe connection hole	
9	Left side pipe connection hole	

- NOTES**
- 1 Location of unit's Name Plate: Right side surface of casing.
 - 2 In case of using infrared remote control, this position will be a signal receiver. Refer to the drawing of infrared remote control in detail.

5 Dimensional drawing & centre of gravity

5 - 1 Dimensional drawing

FXAQ63P

3D065066

Nr	Name	Description
1	Front panel	
2	Front grill	
3	Air outlet	
4	Gas pipe	Ø15.9mm Flare connection
5	Liquid pipe	Ø9.5mm Flare connection
6	Drain hose	VP13 (External dia. Ø18)
7	Grounding terminal	M4
8	Right side pipe connection hole	
9	Left side pipe connection hole	

NOTES

- 1 Location of unit's of Name Plate: Right side surface of casing.
- 2 In case of using infrared remote control, this position will be a signal receiver. Refer to the drawing of infrared remote control in detail.

6 Piping diagram

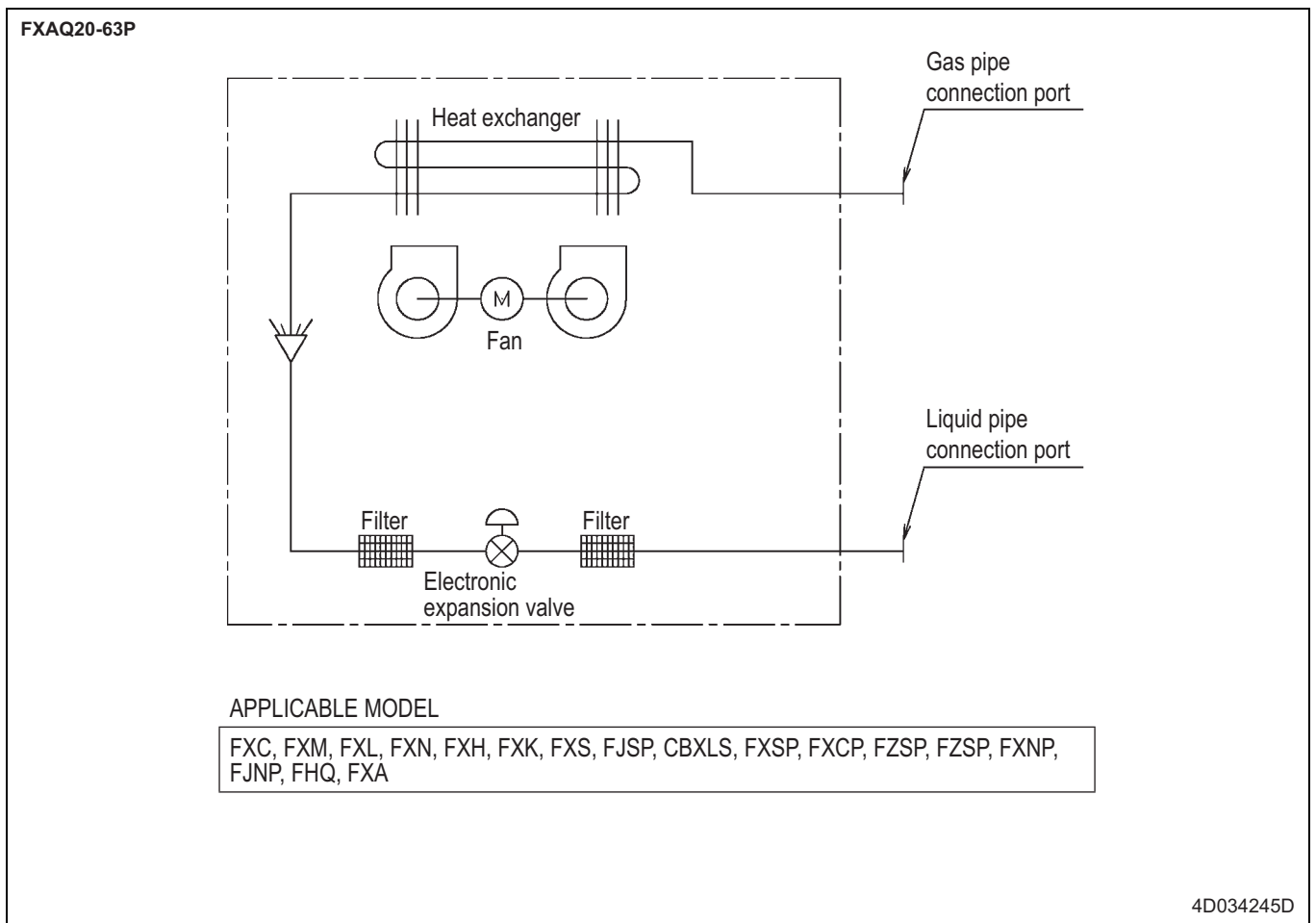

7 Wiring diagram

7 - 1 Wiring diagram

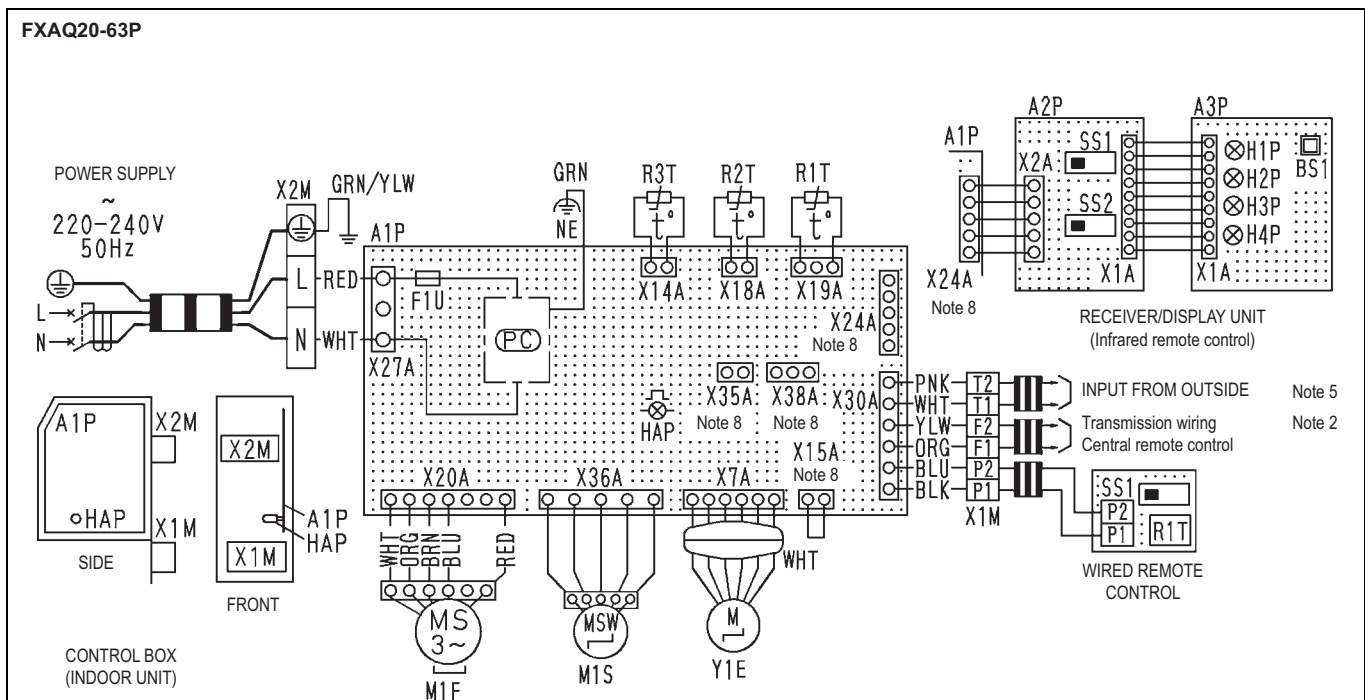

INDOOR UNIT		BS1	Push button (on/off)
A1P	Printed circuit board	H1P	Light emitting diode (on-red)
F1U	Fuse (t, 3.15AH, 250V)	H2P	Light emitting diode (timer green)
HAP	Light emitting diode (service motor green)	H3P	Light emitting diode (filter sign-red)
M1F	Motor (indoor fan)	H4P	Light emitting diode (defrost-orange)
M1S	Motor (swing flap)	SS1	Selector switch (main/sub)
R1T	Thermistor (air)	SS2	Selector switch (wireless address set)
R2T	Thermistor (coil liquid pipe)	WIRED REMOTE CONTROL	
R3T	Thermistor (coil gas pipe)	R1T	Thermistor (air)
X1M	Terminal block (control)	SS1	Selector switch (main/sub)
X2M	Terminal block (power)	CONNECTOR FOR OPTIONAL PARTS	
Y1E	Electronic expansion valve	X15A	Connector (float switch)
(PC)	Power circuit	X24A	Connector (infrared remote control)
RECEIVER/DISPLAY UNIT (ATTACHED TO INFRARED REMOTE CONTROL)		X35A	Connector (group control adaptor)
A2P	Printed circuit board	X38A	Connector (adaptor for multi tenant)
A3P	Printed circuit board		

3D064997A

NOTES

- : terminal : connector
 : terminal : connector
- In case using central remote control, connect it to the unit in accordance with the attached installation manual.
- Symbols shows as follows: RED: red - WHT: white - GRN: green - PNK: pink - YLW: yellow - BLK: black - ORG: orange - BLU: blue.
- Shows short circuit connector.
- When connecting the input wires from outside, forced off or on/off control operation can be selected by remote control. In details, refer to the installation manual attached the unit.
- Remote control model varies according to the combination system, confirm engineering data and catalogs, etc, before connecting.
- Confirm the method of setting the selector switch (SS1, SS2) of wired remote control and wireless remote control by installation manual and engineering data, etc.
- X15A, X24A, X35A and X38A are connected when the optional accessories are being used.

8 Sound data

8 - 1 Sound pressure spectrum

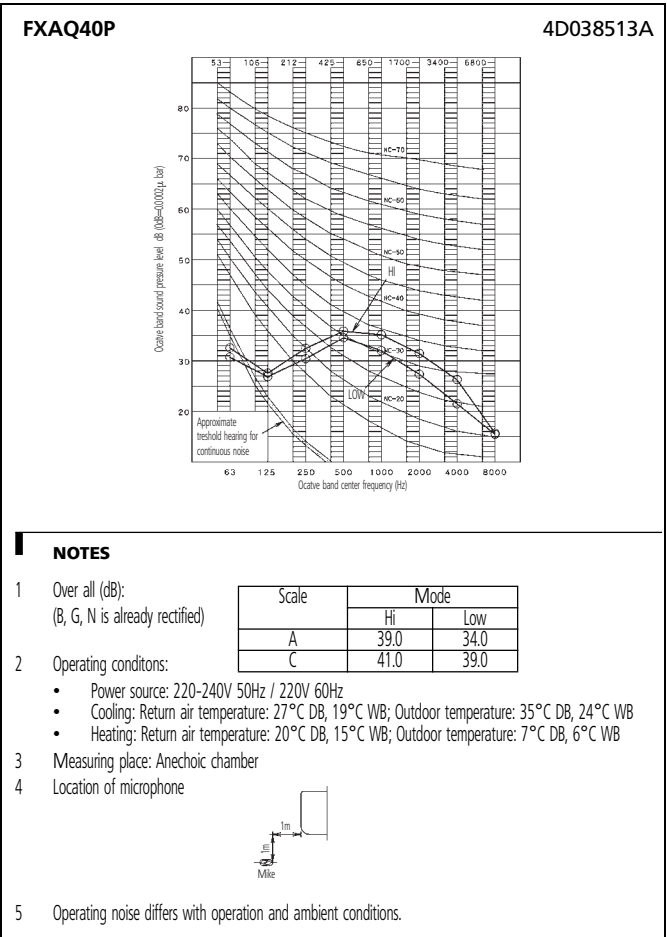
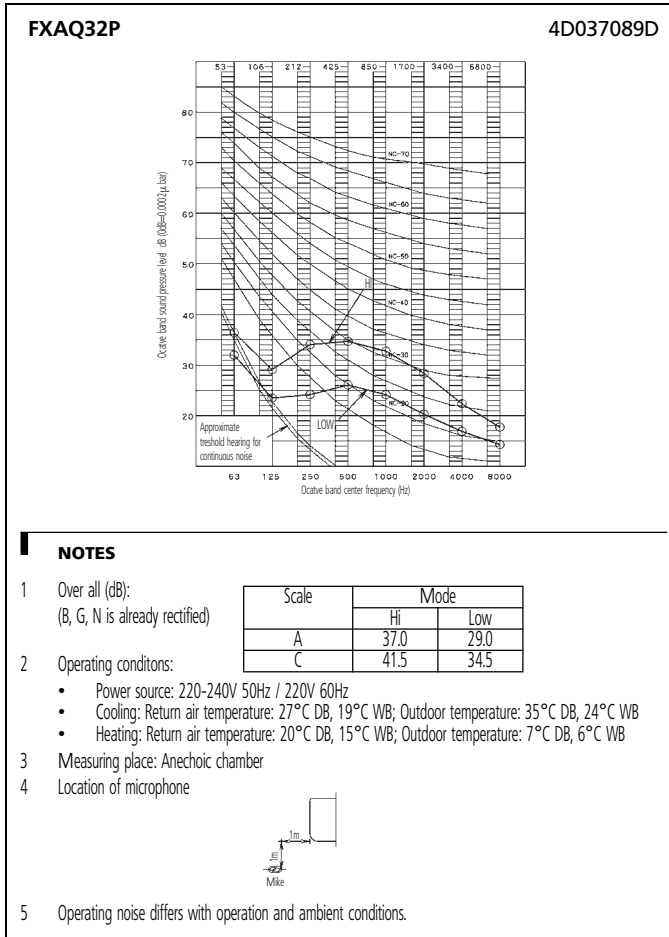
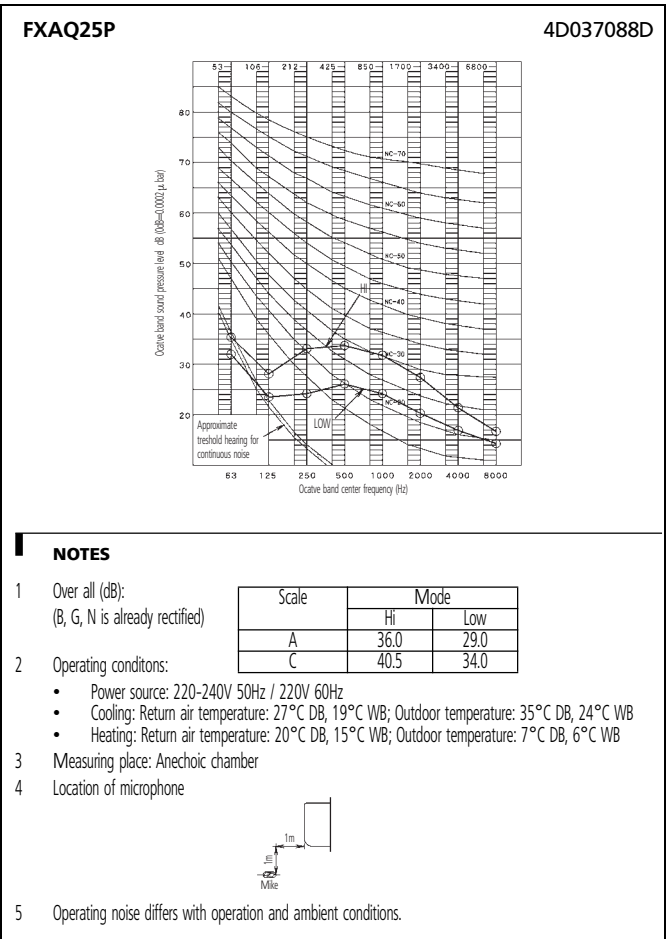
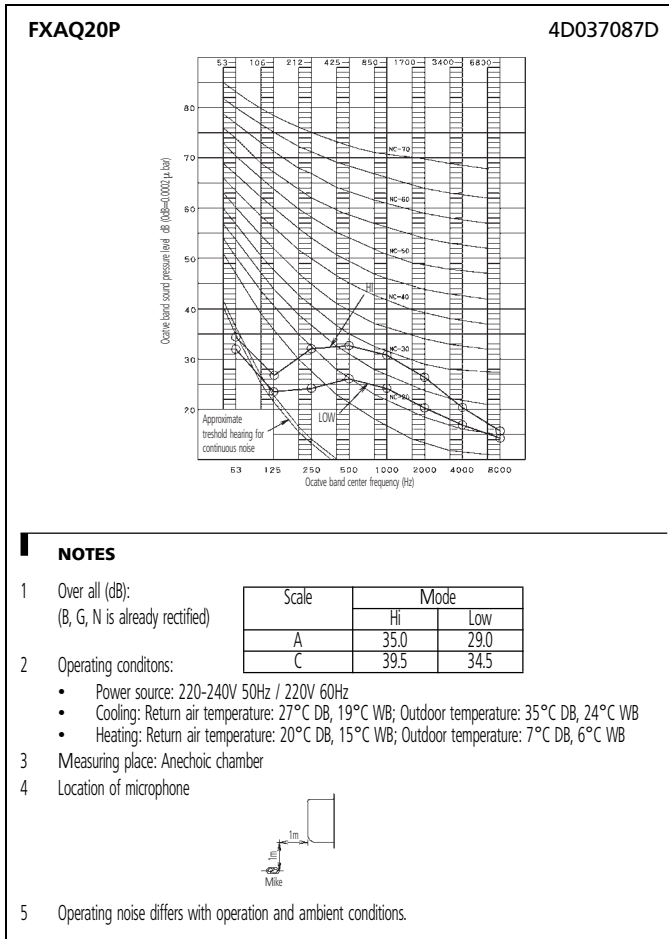

8 Sound data

8 - 1 Sound pressure spectrum

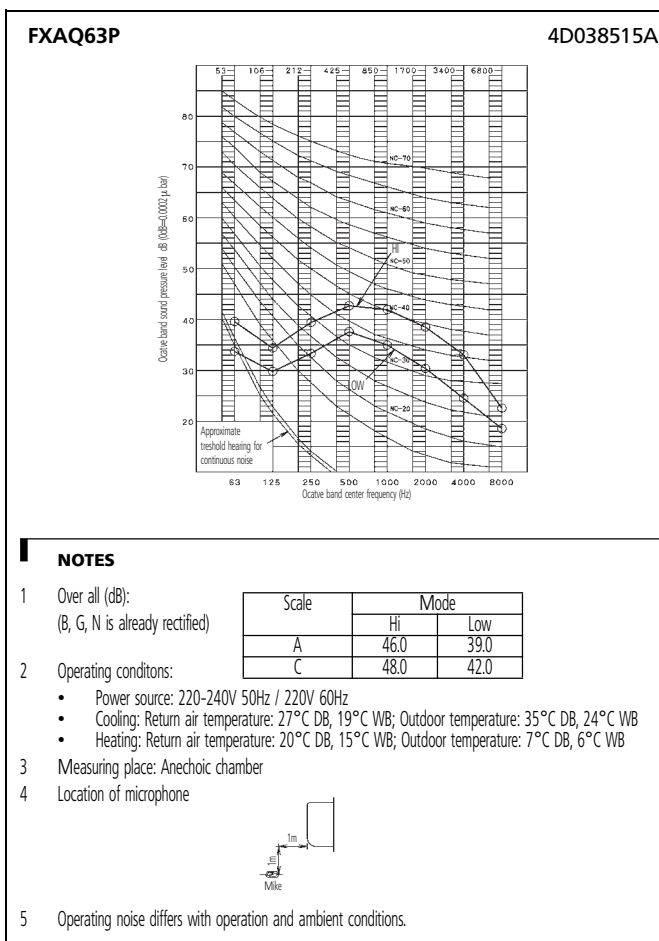
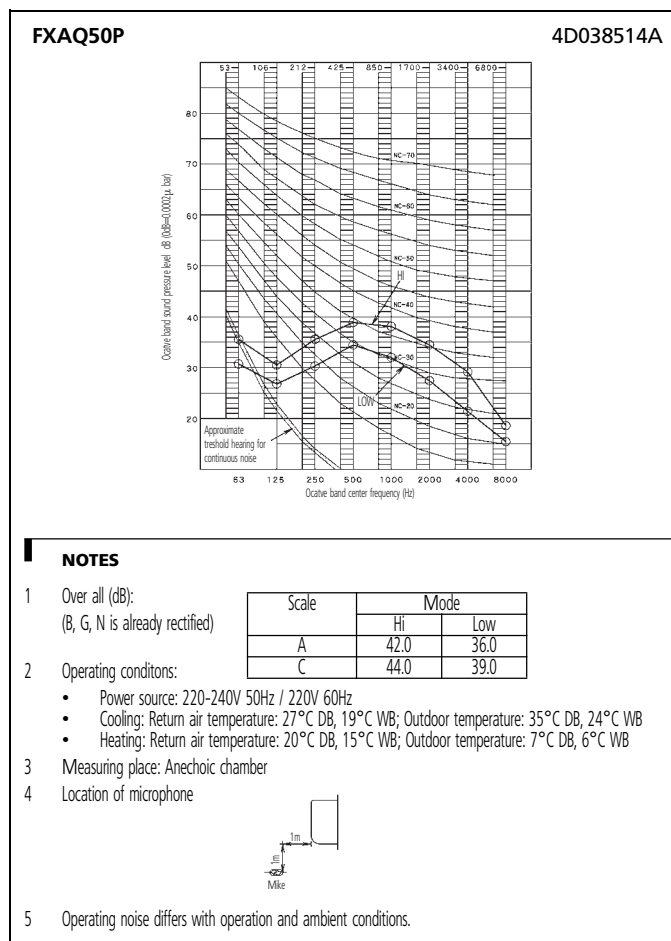

9 Installation

9 - 1 Drainage instructions

Install the drain piping

- The drain pipe should be short with a downward slope and should prevent the formation of air pockets.

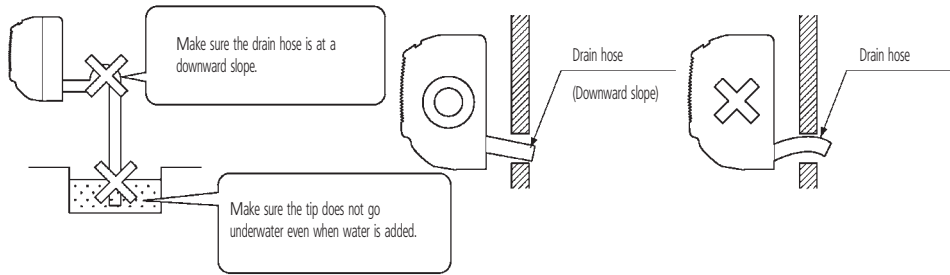

- When extending the drain hose, use a commercially available drain extension hose, and be sure to insulate the extended section of the drain hose which is indoors.

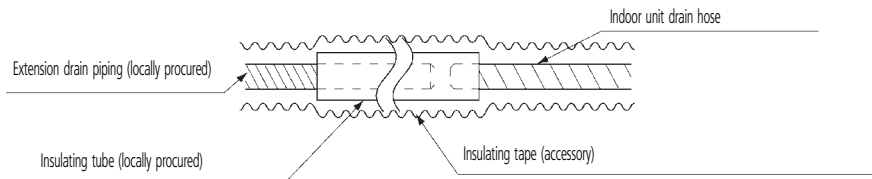

- Make sure the diameter of the piping is the same as the piping (hard vinyl chloride, nominal diameter 13mm) or bigger.
- When directly connecting a hard vinyl chloride pipe joint (nominal diameter 13mm) to the drain hose connected to the indoor unit (i.e. for embedded piping, etc.), use a commercially available hard vinyl chloride pipe joint (nominal diameter 13mm).

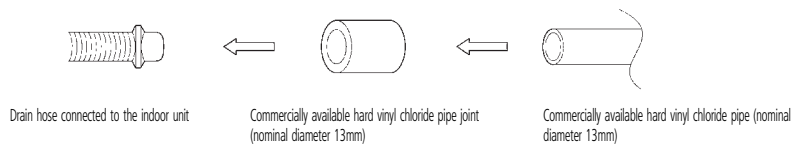

9 Installation

9 - 2 Service space

FXAQ-P

1 Select an installation site where the following conditions are fulfilled and that meets with your customer's approval.

- In the upper space (including the back of the ceiling) of the indoor unit where there is no possible dripping of water from the refrigerant pipe, drain pipe, water pipe, etc.
- Where the wall is strong enough to bear the indoor unit weight.
- Where sufficient clearance for installation and maintenance can be ensured. (Refer to Fig. 1 and Fig. 2)
- Where optimum air distribution can be ensured.
- Where nothing blocks the air passage.
- Where condensate can be properly drained.
- Where the wall is not significantly tilted.
- Where not exposed to combustible gases.
- Where pipe between indoor and outdoor units is possible within the allowable limit. (Refer to the installation manual of the outdoor unit.)
- Install the indoor and outdoor units, power cable and transmission wiring, at least 1 m from TVs and radios, to prevent distorted pictures and static. (Depending on the type and source of the electrical waves, static may be heard even when more than 1 m away.)
- Install the indoor unit no less than 2.5 m above the floor. Where unavoidably lower, take what measures are necessary to keep hands out of the air inlet.
- Where the cool (warm) air reaches all across the room.

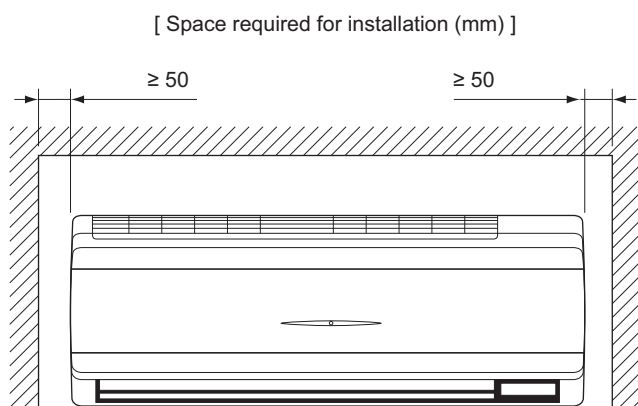

Fig. 1

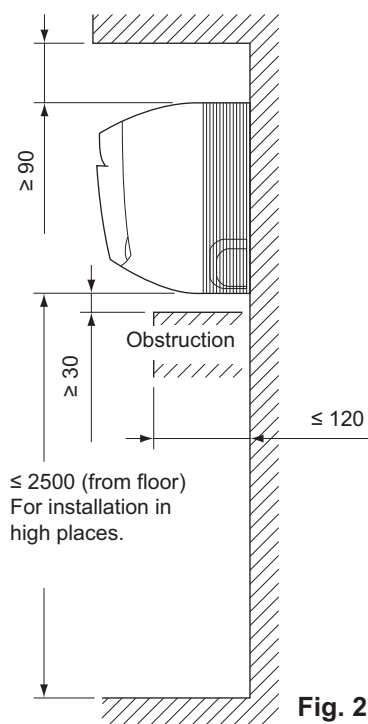

Fig. 2

- 2 Consider whether the place where the unit will be installed can support the full weight of the unit, and reinforce it with boards and beams, etc. if needed before proceeding with the installation. Also, reinforce the place to prevent vibration and noise before installing. (The installation pitch can be found on the paper pattern for installation (3), so refer to it when considering the necessity for reinforcing the location.)**
- 3 The indoor unit may not be directly installed on the wall. Use the attached installation panel (1) before installing the unit.**

3P156215-12U

In all of us,
a green heart



Daikin's unique position as a manufacturer of air conditioning equipment, compressors and refrigerants has led to its close involvement in environmental issues. For several years Daikin has had the intension to become a leader in the provision of products that have limited impact on the environment. This challenge demands the eco design and development of a wide range of products and an energy management system, resulting in energy conservation and a reduction of waste.



Daikin Europe N.V. is approved by LRQA for its Quality Management System in accordance with the ISO9001 standard. ISO9001 pertains to quality assurance regarding design, development, manufacturing as well as to services related to the product.



ISO14001 assures an effective environmental management system in order to help protect human health and the environment from the potential impact of our activities, products and services and to assist in maintaining and improving the quality of the environment.



Daikin units comply with the European regulations that guarantee the safety of the product.

VRV® products are not within the scope of the Eurovent certification programme.

The present publication is drawn up by way of information only and does not constitute an offer binding upon Daikin Europe N.V.. Daikin Europe N.V. has compiled the content of this publication to the best of its knowledge. No express or implied warranty is given for the completeness, accuracy, reliability or fitness for particular purpose of its content and the products and services presented therein. Specifications are subject to change without prior notice. Daikin Europe N.V. explicitly rejects any liability for any direct or indirect damage, in the broadest sense, arising from or related to the use and/or interpretation of this publication. All content is copyrighted by Daikin Europe N.V..

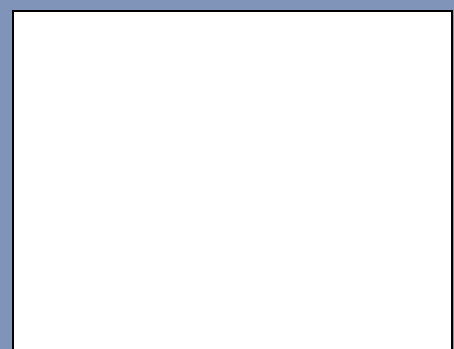

DAIKIN EUROPE N.V.

Naamloze Vennoetschap
Zandvoordestraat 300
B-8400 Oostende, Belgium
www.daikin.eu
BE 0412 120 336
RPR Oostende