

**DAIKIN**



# INSTALLATION MANUAL

**VRV** System Inverter Air Conditioners

FXDQ15A2VEB  
FXDQ20A2VEB  
FXDQ25A2VEB  
FXDQ32A2VEB  
FXDQ40A2VEB  
FXDQ50A2VEB  
FXDQ63A2VEB



## CONTENTS

1. SAFETY PRECAUTIONS.....	1
2. BEFORE INSTALLATION .....	2
3. SELECTING INSTALLATION SITE.....	3
4. PREPARATIONS BEFORE INSTALLATION .....	4
5. INDOOR UNIT INSTALLATION .....	5
6. REFRIGERANT PIPING WORK .....	5
7. DRAIN PIPING WORK.....	7
8. INSTALLING THE DUCT .....	8
9. ELECTRIC WIRING WORK .....	9
10. WIRING EXAMPLE .....	10
11. FIELD SETTING AND TEST RUN .....	12
12. WIRING DIAGRAM .....	14

The original instructions are written in English. All other languages are translations of the original instructions.

### 1. SAFETY PRECAUTIONS

Please read these “SAFETY PRECAUTIONS” carefully before installing air conditioning equipment and be sure to install it correctly.

After completing installation, conduct a trial operation to check for faults and explain to the customer how to operate the air conditioner and take care of it with the aid of the operation manual. Ask the customer to store the installation manual along with the operation manual for future reference.

**This air conditioner comes under the term “appliances not accessible to the general public”.**

Meaning of WARNING and CAUTION notices

 **WARNING** ..... Failure to follow these instructions properly may result in personal injury or loss of life.

 **CAUTION** ..... Failure to observe these instructions properly may result in property damage or personal injury, which may be serious depending on the circumstances.

-  **WARNING**
- Ask your dealer or qualified personnel to carry out installation work.  
Do not attempt to install the air conditioner yourself. Improper installation may result in water leakage, electric shocks or fire.
  - Install the air conditioner in accordance with the instructions in this installation manual.  
Improper installation may result in water leakage, electric shocks or fire.
  - Consult your local dealer regarding what to do in case of refrigerant leakage. When the air conditioner is to be installed in a small room, it is necessary to take proper measures so that the amount of any leaked refrigerant does not exceed the concentration limit in the event of a leakage. Otherwise, this may lead to an accident due to oxygen depletion.
  - Be sure to use only the specified accessories and spare parts for installation work.  
Failure to use the specified parts may result in the unit falling, water leakage, electric shocks or fire.
  - Install the air conditioner on a foundation strong enough to withstand the weight of the unit.

- A foundation of insufficient strength may result in the equipment falling and causing injury.
- Carry out the specified installation work after taking into account strong winds, typhoons or earthquakes.  
Failure to do so during installation work may result in the unit falling and causing accidents.
- Make sure that a separate power supply circuit is provided for this unit and that all electrical work is carried out by qualified personnel according to local laws and regulations and this installation manual.  
An insufficient power supply capacity or improper electrical construction may lead to electric shocks or fire.
- Make sure that all wiring is secured, the specified wires are used, and that there is no strain on the terminal connections or wires. Improper connections or securing of wires may result in abnormal heat build-up or fire.
- When wiring the power supply and connecting the remote controller wiring and transmission wiring, position the wires so that the control box lid can be securely fastened. Improper positioning of the control box lid may result in electric shocks, fire or the terminals overheating.
- If refrigerant gas leaks during installation, ventilate the area immediately.  
Toxic gas may be produced if the refrigerant comes into contact with fire.
- After completing installation, check for refrigerant gas leakage.  
Toxic gas may be produced if the refrigerant gas leaks into the room and comes into contact with a source of fire, such as a fan heater, stove or cooker.
- Be sure to switch off the unit before touching any electrical parts.
- Do not touch the switch with wet fingers.  
Touching the switch with wet fingers can cause electric shock.
- Be sure to earth the air conditioner.  
Do not earth the unit to a utility pipe, lightning conductor or telephone earth lead.  
Imperfect earthing may result in electric shocks or fire.  
A high surge current from lightning or other sources may cause damage to the air conditioner.
- Be sure to install an earth leakage breaker.  
Failure to install an earth leakage breaker may result in electric shocks or fire.

-  **CAUTION**
- While following the instructions in this installation manual, install drain piping to ensure proper drainage and insulate piping to prevent condensation.  
Improper drain piping may result in indoor water leakage and property damage.
  - Install the indoor and outdoor units, power cord and connecting wires at least 1 meter away from televisions or radios to prevent picture interference and noise.  
(Depending on the incoming signal strength, a distance of 1 meter may not be sufficient to eliminate noise.)
  - Remote controller (wireless kit) transmitting distance can be shorter than expected in rooms with electronic fluorescent lamps (inverter or rapid start types).  
Install the indoor unit as far away from fluorescent lamps as possible.
  - Only handle the indoor unit with gloves.



- Do not install the air conditioner in the following locations:
  - Where there is a high concentration of mineral oil spray or vapour (e.g. a kitchen).  
Plastic parts will deteriorate, parts may fall off and water leakage could result.
  - Where corrosive gas, such as sulphurous acid gas, is produced.  
Corroding of copper pipes or soldered parts may result in refrigerant leakage.
  - Near machinery emitting electromagnetic radiation.  
Electromagnetic radiation may disturb the operation of the control system and result in a malfunction of the unit.
  - Where flammable gas may leak, where there is carbon fibre or ignitable dust suspensions in the air, or where volatile flammables such as paint thinner or gasoline are handled.

Operating the unit in such conditions may result in fire.

- Do not touch the heat exchanger fins.  
Improper handling may result in injury.
- Be very careful about product transportation.  
Some products use PP bands for packaging. Do not use any PP bands for a means of transportation. It is dangerous.
- Safely dispose of the packing materials.  
Packing materials, such as nails and other metal or wooden parts, may cause stabs or other injuries.  
Tear apart and throw away plastic packaging bags so that children will not play with them. If children play with a plastic bag which was not torn apart, they face the risk of suffocation.
- Do not turn off the power immediately after stopping operation.  
Always wait at least 5 minutes before turning off the power.  
Otherwise, water leakage and trouble may occur.
- In a domestic environment this product may cause radio interference in which case the user may be required to take adequate measures.

Follow national standards for installation work.

## 2. BEFORE INSTALLATION

**The accessories needed for installation must be retained in your custody until the installation work is completed. Do not discard them!**

- Decide upon a line of transport.
- Leave the unit inside its packaging while moving, until reaching the installation site. Where unpacking is unavoidable, use a sling of soft material or protective plates together with a rope when lifting, to avoid damage or scratches to the unit.

**When moving the unit at or after opening, hold the unit by the hanger brackets. Do not apply force to the refrigerant piping, drain piping or flange parts.**

**Be sure to check the type of R410A refrigerant to be used before installing the unit. (Using an incorrect refrigerant will prevent normal operation of the unit.)**







For the installation of an outdoor unit, refer to the installation manual attached to the outdoor unit.





### 2-1 PRECAUTIONS

- Be sure to instruct customers how to properly operate the unit (operating different functions, and adjusting the temperature ) by having them carry out operations themselves while looking at the operation manual.
- Do not install in locations where the air contains high levels of salt such as that near the ocean and where voltage fluctuates greatly such as that in factories, or in vehicles or vessels.

### 2-2 ACCESSORIES

Check the following accessories are included with your unit.

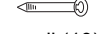
Name	Metal clamp (1)	Drain hose (2)	Insulation for fitting	Sealing pad
Quantity	1 pc.	1 pc.	1 each	1 each
Shape			 for liquid pipe (3)  for gas pipe (4)	 Large (5)  mid. (6)

Name	Screws for duct flanges (7)	Washer for hanging bracket (8)	Clamp	Washer fixing plate (11)
Quantity	1 set	8 pcs.	1 set	4 pcs.
Shape	 26 pcs.		 Large (9) 8 pcs.  small (10) 4 pcs.	

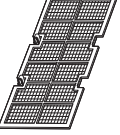
Name	Sealing material (12)	Air filter (13)	(Other) • Operation manual • Installation manual (this manual)
Quantity	2 pcs.	1 pc.	
Shape			

### 2-3 OPTIONAL ACCESSORIES

- This indoor unit requires one of the operation remote controls listed below.

Remote controller	
Wired type	BRC1D52/BRC1D61/BRC1E51/BRC2C51/ BRC1E52/BRC3A61
Wireless type	BRC4C62

**FOR THE FOLLOWING ITEMS, TAKE SPECIAL CARE DURING CONSTRUCTION AND CHECK AFTER INSTALLATION IS FINISHED.**

#### a. Items to be checked after completion of work

Items to be checked	If not properly done, what is likely to occur	Check
Are the indoor and outdoor unit fixed firmly?	The units may drop, vibrate or make noise.	
Is the gas leak test finished?	It may result in insufficient cooling.	
Is the unit fully insulated?	Condensate may drip.	
Does drainage flow smoothly?	Condensate may drip.	
Does the power supply voltage correspond to that shown on the name plate?	The unit may malfunction or the components burn out.	
Are wiring and piping correct?	The unit may malfunction or the components burn out.	
Is the unit safely grounded?	Incomplete grounding may result in electric shocks.	
Is wiring size according to specifications?	The unit may malfunction or the components burn out.	



Is something blocking the air outlet or inlet of either the indoor or outdoor units?	It may result in insufficient cooling.	
Are refrigerant piping length and additional refrigerant charge noted down?	The refrigerant charge in the system is not clear.	

Also review the "SAFETY PRECAUTIONS".

**b. Items to be checked at time of delivery**

Items to be checked	Check
Did you explain about operations while showing the operation manual to your customer?	
Did you hand the operation manual and warranty over to your customer?	
Did you explain about the way of maintaining and cleaning local procurements (air filter, grille (both air outlet and suction grille), etc.) to your customer?	
Did you hand manuals of local procurements (in case equipped) over to your customer?	

**c. Points for explanation about operations**

The items with  WARNING and  CAUTION marks in the operation manual are the items pertaining to possibilities for bodily injury and material damage in addition to the general usage of the product. Accordingly, it is necessary that you make a full explanation about the described contents and also ask your customers to read the operation manual.

**3. SELECTING INSTALLATION SITE**

 **CAUTION**

- When moving the unit during or after unpacking, make sure to lift it by holding its lifting lugs. Do not exert any pressure on other parts, especially the refrigerant piping, drain piping and flange parts.
- If you think the humidity inside the ceiling might exceed 30°C and RH80%, reinforce the insulation on the unit body. Use glass wool or polyethylene foam as insulation so that it is no thicker than 10mm and fits inside the ceiling opening.

**(1) Select an installation site where the following conditions are fulfilled and that meets with your customer's approval.**

- Where optimum air distribution can be ensured.
- Where nothing blocks air passage.
- Where condensate can be properly drained.
- Where the ceiling is strong enough to bear the indoor unit weight.
- Where the false ceiling is not noticeably on an incline.
- Where there is no risk of flammable gas leakage.
- Where sufficient clearance for maintenance and service can be ensured. **(Refer to Fig. 1)**
- Where piping between indoor and outdoor units is possible within the allowable limit. (Refer to the installation manual for the outdoor unit.)
- The equipment is not intended for use in a potentially explosive atmosphere.

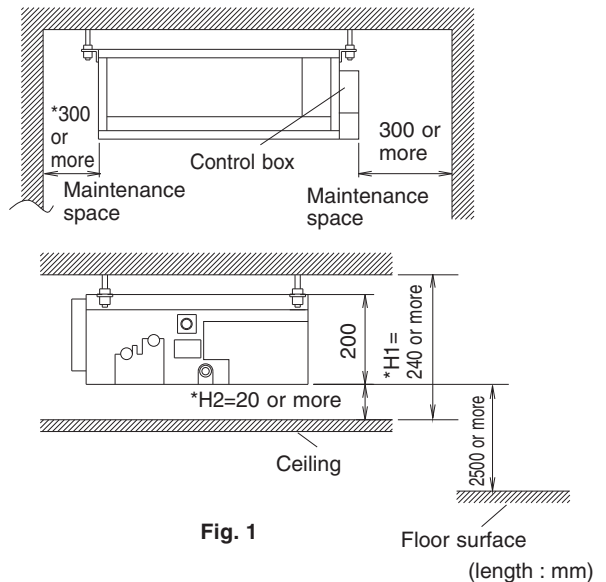

Fig. 1

- \*H1 dimension means the minimum height of the unit.
- Select the \*H1, \*H2 dimension such that a downward slope of at least 1/100 is ensured as indicated in "7. DRAIN PIPING WORK".
- The maintenance space marked with "\*" is required when the installation box for adaptor PC board (KRP1BA101) sold separately is used.

**[ PRECAUTION ]**

- Install the indoor and outdoor units, power supply wiring and connecting wires at least 1 m away from televisions or radios in order to prevent image interference or noise. (Depending on the radio waves, a distance of 1 m may not be sufficient enough to eliminate the noise.)
  - If installing the wireless kit in a room with electronic fluorescent lighting (inverter or rapid start type), the remote controller's transmission distance may be shortened. Indoor units should be installed as far away from fluorescent lighting as possible.
- (2) Use suspension bolts for installation. Check whether the ceiling is strong enough to support the weight of the unit or not. If there is a risk, reinforce the ceiling before installing the unit.**
- To avoid contact with the fan, one of the following precaution actions must be taken:
    - Install the unit as high as possible at a minimum bottom height of 2.7 m.
    - Install the unit as high as possible at a minimum bottom height of 2.5 m in case the fan is externally screened by parts which can be removed without the aid of tools (e.g. false sealing, grill ...).
    - Install the unit with ducting and grill which can only be removed with the aid of tooling. It shall be installed so that it gives adequate protection against touching the fan. If a maintenance panel exists in the ducting, it shall only be possible to remove the panel by the aid of tooling to avoid contact with the fan. The protection shall be according to relevant European and local legislation. There are no restrictions concerning the installation height.

## 4. PREPARATIONS BEFORE INSTALLATION

### (1) Confirm the positional relationship between the unit and suspension bolts. (Refer to Fig. 2)

- Install the inspection opening on the control box side where maintenance and inspection of the control box and drain pump are easy. Install the inspection opening also in the lower part of the unit.

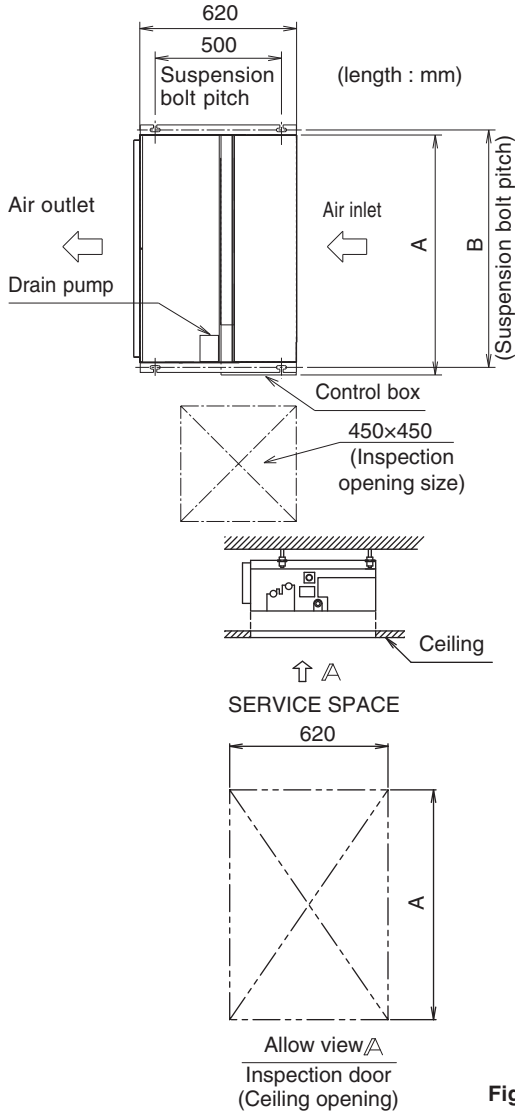

Fig. 2

(length: mm)

Model	A	B
15-20-25-32 type	750	740
40-50 type	950	940
63 type	1150	1140

### (2) Make sure the range of the unit's external static pressure is not exceeded.

(See the technical documentation for the range of the external static pressure setting.)

### (3) Open the installation hole. (Pre-set ceilings)

- Once the installation hole is opened in the ceiling where the unit is to be installed, pass refrigerant piping, drain piping, transmission wiring, and remote controller wiring (It is not necessary if using a wireless remote controller) to the unit's piping and wiring holes. See "6. REFRIGERANT PIPING WORK", "7. DRAIN PIPING WORK", and "10. WIRING EXAMPLE".
- After opening the ceiling hole, make sure ceiling is level if needed. It might be necessary to reinforce the ceiling frame to prevent shaking. Consult an architect or carpenter for details.

### (4) Install the suspension bolts.

(Use W3/8 to M10 suspension bolts.)

Use a hole-in-anchor for existing ceilings, and a sunken insert, sunken anchor or other part to be procured in the field to reinforce the ceiling to bearing the weight of the unit for new ceiling. (Refer to Fig. 3)

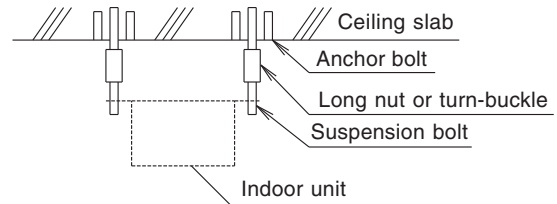

Note: All the above parts are field supplied.

Fig. 3

### (5) In case of bottom suction

- Remove the chamber lid. (7 locations)
- Reattached the removed chamber lid in the orientation shown in Fig. 4. (7 locations)
- Attach the air filter (accessory) in the manner shown in the diagram. The four holes which cannot be covered by the air filter should be covered with commercially available tape.

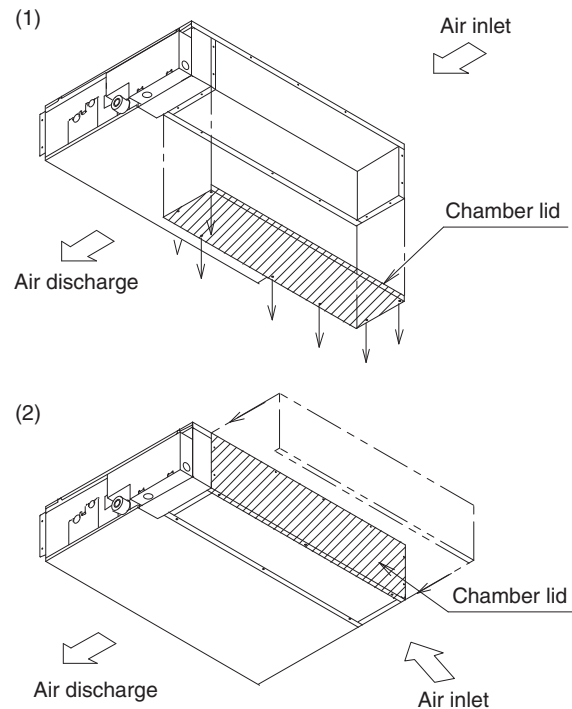
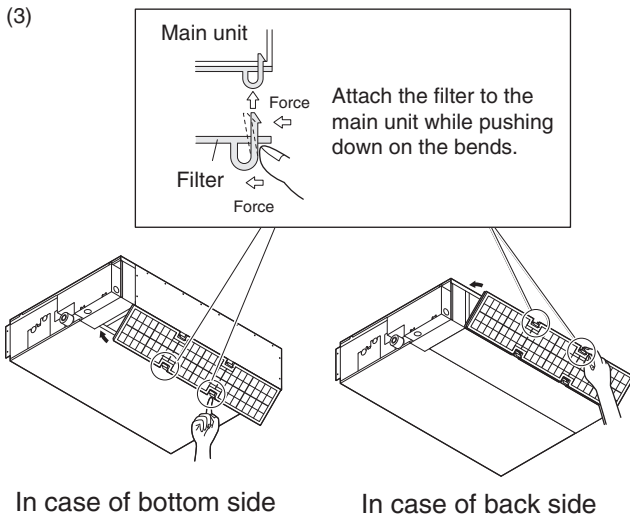

Fig. 4



## 5. INDOOR UNIT INSTALLATION

«As for the parts to be used for installation work, be sure to use the provided accessories and specified parts designated by our company.»

### (1) Install the indoor unit temporarily.

- Attach the hanger bracket to the suspension bolt. Be sure to fix it securely by using a nut and washer from the upper and lower sides of the hanger bracket. (Refer to Fig. 5)

[ Securing the hanger bracket ]      [ How to secure washers ]

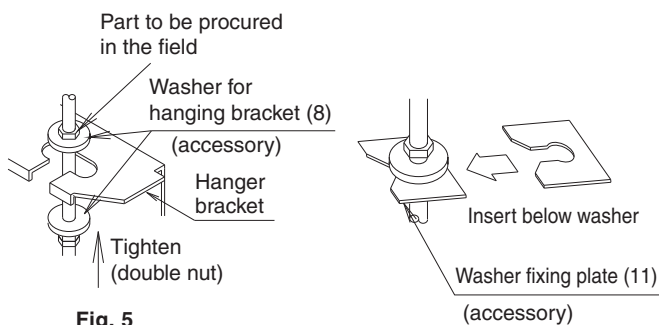

### [ PRECAUTION ]

Since the unit uses a plastic drain pan, prevent welding spatter and other foreign substances from the air outlet during installation.

### (2) Adjust the height of the unit.

### (3) Check the unit is horizontally level.

### ⚠ CAUTION

- Make sure the unit is installed level using a level or a plastic tube filled with water. In using a plastic tube instead of a level, adjust the top surface of the unit to the surface of the water at both ends of the plastic tube and adjust the unit horizontally. (One thing to watch out for in particular is if the unit is installed so that the slope is not in the direction of the drain piping, this might cause leaking.)

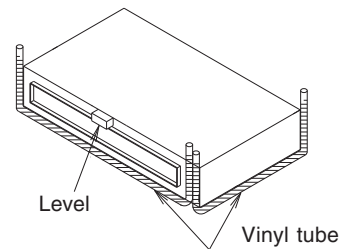

### (4) Tighten the upper nut.

## 6. REFRIGERANT PIPING WORK

«For refrigerant piping of outdoor units, see the installation manual attached to the outdoor unit.»

«Execute heat insulation work completely on both sides of the gas piping and the liquid piping. Otherwise, a water leakage can result sometimes.»

Use insulation that can withstand temperatures of at least 120°C. Reinforce the insulation on the refrigerant piping according to the installation environment. If the temperature above the ceiling might reach 30°C or the humidity RH80%. Condensation may form on the surface of the insulation.»

### ⚠ CAUTION

Follow the points at below.

- Use a pipe cutter and flare suitable for the type of refrigerant.
- Apply ester oil or ether oil to the flare section when using a flare connection.
- Only use the flare nuts included with the unit. Using different flare nuts may cause the refrigerant to leak.
- To prevent dust, moisture or other foreign matter from infiltrating the piping, either pinch the end or cover it with tape.
- Do not allow anything other than the designated refrigerant to get mixed into the refrigerant circuit, such as air, etc. If any refrigerant gas leaks while working on the unit, ventilate the room thoroughly right away.

### (1) Connect the piping.

- The outdoor unit is charged with refrigerant.
- Be sure to use both a spanner and torque wrench together, as shown in the drawing, when connecting or disconnecting pipes to/from the unit. (Refer to Fig. 6)

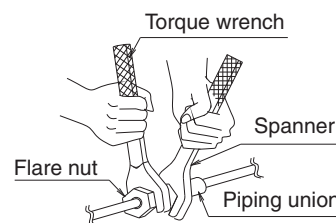

Fig. 6

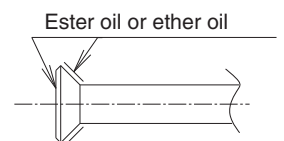

Fig. 7

- Refer to the Table 1 for the dimensions of flare nut spaces.
- Apply ester oil or ether oil to flare section (both inside and out) when using flare nut connections and then turn 3 or 4 times by hand. (Refer to Fig. 7)

- Refer to Table 1 for tightening torque.

Table 1

Pipe size	Tightening torque	Flare dimension A (mm)	Flare shape
φ 6.4	15 – 17 N·m	8.7 – 9.1	
φ 9.5	33 – 39 N·m	12.8 – 13.2	
φ 12.7	50 – 60 N·m	16.2 – 16.6	
φ 15.9	63 – 75 N·m	19.3 – 19.7	

**CAUTION**

**Overtightening may damage the flare and cause leaks. Be careful for oil not to adhere to any portions other than a flare part. If oil adhere to resin parts etc., there is a possibility of damaging by deterioration.**

- Refer to Table 2 if no torque wrench is available. Using a wrench to tighten flare nuts causes the tightening torque to suddenly grow much tighter after a certain point. From there, tighten the nut further by the appropriate angle listed in Table 2.

(2) After the work is finished, make sure to check that there is no gas leak.

(3) After checking for gas leaks, be sure to insulate the pipe connections referring to Fig. 8.

- Insulate using the insulation for fitting (3) (4) included with the liquid and gas pipes. Besides, make sure the insulation for fitting (3) (4) on the liquid and gas piping has its seams facing up.
- (Tighten both edges with clamp (9).)
- For the gas piping, wrap the mid. sealing pad (6) over the insulation for fitting (4) (flare nut part).

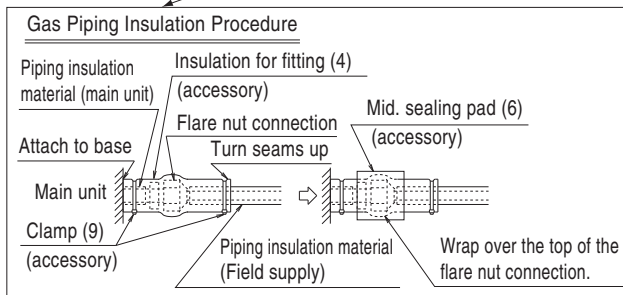
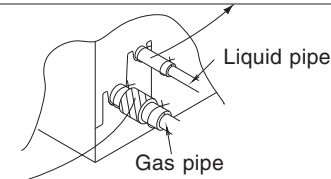
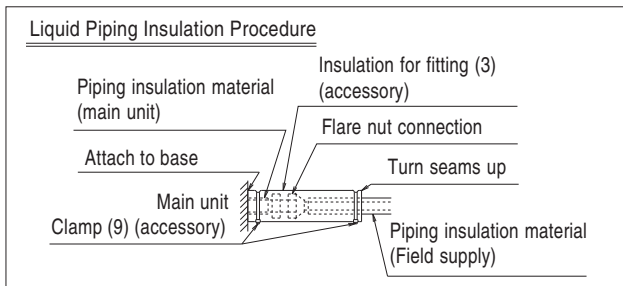

Fig. 8

**CAUTION**

Be sure to insulate any field piping all the way to the piping connection inside the unit. Any exposed piping may cause condensation or burns if touched.

- When brazing the refrigerant piping, perform nitrogen replacement first, or perform the brazing (CAUTION 2) while feeding nitrogen into the refrigerant piping (CAUTION 1), and finally connect the indoor unit using the flare connections. (Refer to Fig. 9)

**CAUTION**

1. When brazing a pipe while feeding nitrogen inside the pipe, make sure to set the nitrogen pressure to 0.02 MPa (0.2 kg/cm<sup>2</sup>) using the pressure reducing valve. (This pressure is such that breeze is blown to your cheek.)
2. Do not use a flux when brazing the refrigerant pipe joints. Use phosphor copper brazer (BCuP-2: JIS Z 3264/B-Cu93P-710/795: ISO 3677) which does not require flux. (Using a flux containing chlorine may cause the piping to corrode. Using a welding flux containing fluorine may cause the refrigerant lubricant to deteriorate, and affect adversely the refrigerant piping system.)

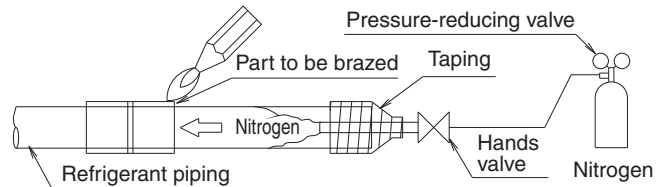

Fig. 9

**Not recommendable but in case of emergency**

You must use a torque wrench but if you are obliged to install the unit without a torque wrench, you may follow the installation method mentioned below.

**After the work is finished, make sure to check that there is no gas leak.**

When you keep on tightening the flare nut with a spanner, there is a point where the tightening torque suddenly increases. From that position, further tighten the flare nut the angle shown below:

Table 2

Pipe size	Further tightening angle	Recommended arm length of tool
φ 6.4 (1/4")	60 to 90 degrees	Approx. 150mm
φ 9.5 (3/8")	60 to 90 degrees	Approx. 200mm
φ 12.7 (1/2")	30 to 60 degrees	Approx. 250mm
φ 15.9 (5/8")	30 to 60 degrees	Approx. 300mm



## 7. DRAIN PIPING WORK

### ⚠ CAUTION

- Make sure all water is out before making the duct connection.

#### (1) Install the drain piping.

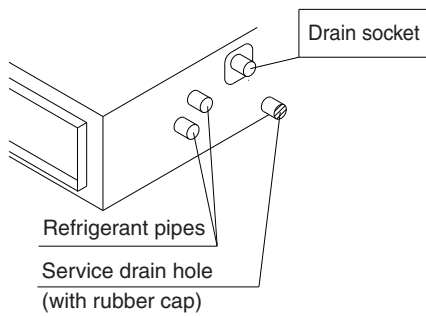

- Make sure the drain works properly.
- The diameter of the drain piping should be greater than or equal to the diameter of the connecting pipe (vinyl tube; pipe size: 20 mm; outer dimension: 26 mm). (not including the riser)
- Keep the drain piping short and sloping downwards at a gradient of at least 1/100 to prevent air pockets from forming. (Refer to Fig. 10)

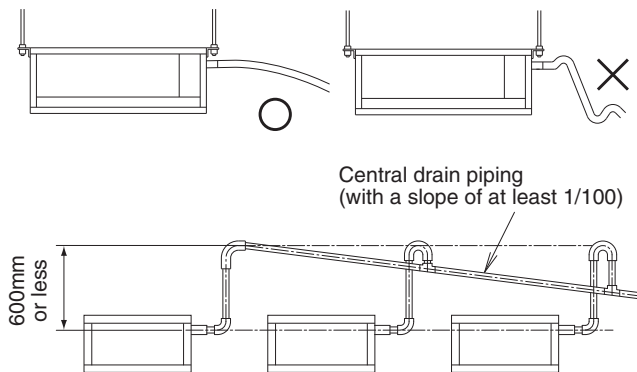

Fig. 10

### ⚠ CAUTION

Water accumulating in the drain piping can cause the drain to clog.

- To keep the drain piping from sagging, space hanging bracket every 1 to 1.5 m.
- Use the drain hose (2) and the metal clamp (1). Insert the drain hose (2) fully into the drain socket and firmly tighten the metal clamp (1) with the upper part of the tape on the hose end. Tighten the metal clamp (1) until the screw head is less than 4 mm from the hose. (Refer to Fig. 11, 12)
- The two areas below should be insulated because condensation may form there causing water to leak.
  - Drain piping passing indoors
  - Drain socket

Referring the figure below, insulate the metal clamp (1) and drain hose (2) using the included large sealing pad (5). (Refer to Fig. 12)

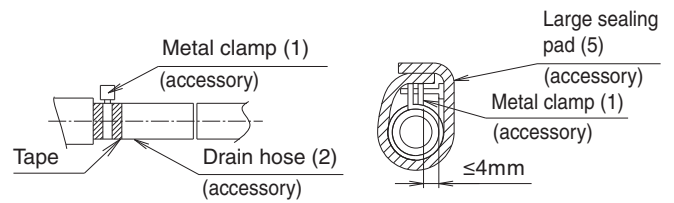

Fig. 11

Fig. 12

#### < PRECAUTIONS FOR DRAIN RAISING PIPE >

- Make sure the drain raising pipe height is no higher than 600mm.
- Place the drain raising pipe vertically and make sure it is no further than 300mm from the unit. (Refer to Fig. 13)

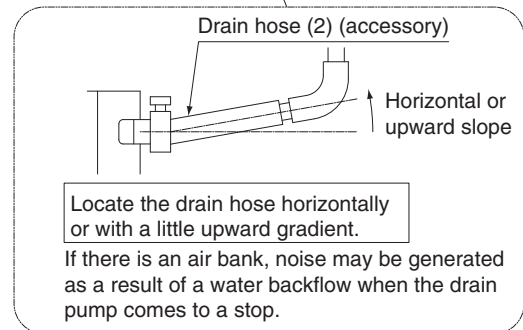
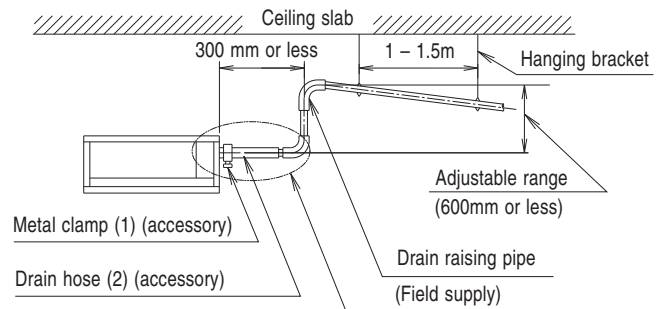

Fig. 13

#### < PRECAUTIONS >

##### Drain piping connections

- Do not connect the drain piping directly to sewage pipes that smell of ammonia. The ammonia in the sewage might enter the indoor unit through the drain piping and corrode the heat exchanger.
- Do not twist or bend the drain hose (2), so that excessive force is not applied to it. (This type of treatment may cause leaking.)
- If you are using central drain piping, follow the procedure outlined in the figure 10.
- Select central drain piping of proper size according to the capacity of the connected unit.

#### (2) After piping work is finished, check drainage flows smoothly, with manner described below.

### ⚠ CAUTION

- The electric wiring work shall be performed by qualified electricians.
- If workers not having the electrician qualification have performed the electric wiring work, the steps 3 to 7 shall be performed after the **TEST RUN**.

1. Remove the control box lid. Connect the remote controller and power supply (single-phase, 50 Hz 220-240 V or single-phase, 60Hz 220V) respectively to the terminal block and securely connect the earth also (as shown in the figure below).



— **CAUTION** —

Securely clamp the cables with the clamps (9)(10) offered as accessories as shown in Fig. 17 so that tension will not be applied on the cable connection areas.

2. Confirm that the control box lid is closed before turning on the power.
3. Remove the inspection lid.
4. Gradually pour approximately 1L of water from the inspection window into the drain pan to check drainage.

— **CAUTION** —

Be sure to prevent an external force from being exerted on the float switch.  
(This may cause breakage.)

5. Attach the inspection lid.
6. Perform the following operation using the remote controller, and check drainage.
  - Select the inspection/test operation button “TEST” using the remote controller. The unit will engage the test operation. Press the operation selector button “”, and select FAN OPERATION “”.
  - Press the ON/OFF button “”. (The indoor fan and drain pump will operate.)

— **CAUTION** —

The fan will turn also at the same time. Take due care. Do not touch the drain pump to prevent electric shock.

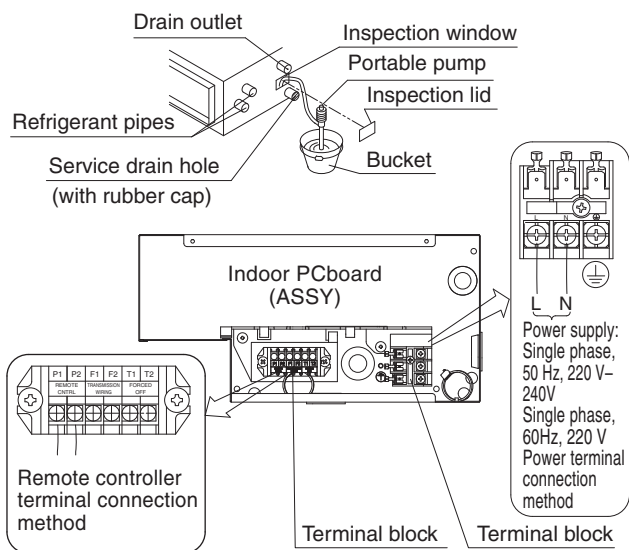

7. Make sure to use the remote controller in finishing the operation.

## 8. INSTALLING THE DUCT

Connect the duct supplied in the field.

### Air inlet side

- Attach the duct and intake-side flange (field supply).
- Connect the flange to the main unit with accessory screws (7).

Class	15 · 20 · 25 · 32	40 · 50	63
Number of positions	16	22	26

- Wrap the intake-side flange and duct connection area with aluminum tape or something similar to prevent air escaping.

— **CAUTION** —

When attaching a duct to the intake side, be sure to attach an air filter inside the air passage on the intake side. (Use an air filter whose dust collecting efficiency is at least 50% in a gravimetric technique.)

The included filter is not used when the intake duct is attached.

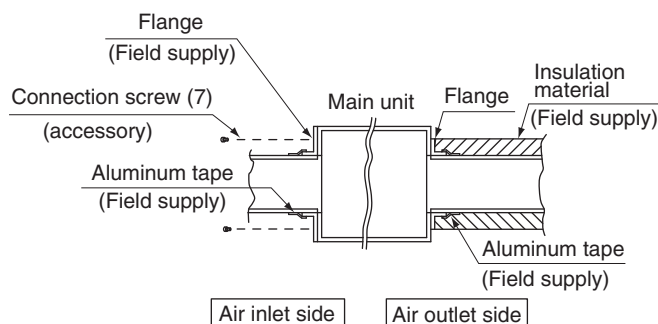

### Air outlet side

- Connect the duct according to the air inside of the outlet-side flange.
- Wrap the outlet-side flange and the duct connection area with aluminum tape or something similar to prevent air escaping.

— **CAUTION** —

- Be sure to insulate the duct to prevent condensation from forming. (Material: glass wool or polyethylene foam, 25 mm thick)
- Use electric insulation between the duct and the wall when using metal ducts to pass metal laths of the net or fence shape or metal plating into wooden buildings.
- Be sure to explain about the way of maintaining and cleaning local procurements (air filter, grille (both air outlet and suction grille), etc.) to your customer.

## 9. ELECTRIC WIRING WORK

### 9-1 GENERAL INSTRUCTIONS

- Shut off the power before doing any work.
- All field supplied parts and materials, electric works must conform to local codes.
- Use copper wire only.
- See also the "Wiring Diagram plate" attached to the control box lid when laying electrical wiring.
- For details on hooking up the remote controller, refer to the "REMOTE CONTROLLER INSTALLATION MANUAL".
- All wiring must be performed by an authorized electrician.
- This system consists of multiple indoor units. Mark each indoor unit as unit A, unit B . . . , and be sure the terminal board wiring to the outdoor unit and BS unit are properly matched. If wiring and piping between the outdoor unit and an indoor unit are mismatched, the system may cause a malfunction.
- A circuit breaker capable of shutting down power supply to the entire system must be installed.
- Refer to the installation manual attached to the outdoor unit for the size of power supply wiring connected to the outdoor unit, the capacity of the circuit breaker and switch, and wiring instructions.
- Be sure to ground the air conditioner.
- Do not the earth wire should come in contact with gas pipes, water pipes, lightning rods, or telephone earth wires.
  - Gas pipes: gas leaks can cause explosions and fire.
  - Water pipes: they cannot be grounded if hard vinyl pipes are used.
  - Telephone earth wire and lightning rods: the ground potential when struck by lightning gets extremely high.
- To avoid short circuiting the power supply wire, be sure to use insulated terminals.
- Do not turn on the power supply (circuit breaker or earth leakage breaker) until all other work is done.

### 9-2 SPECIFICATIONS FOR FIELD SUPPLIED FUSES AND WIRE

#### Power-related

Model	Power supply wiring (including earth wire)			
	Number of units	Field fuses 	Wire	Size
15 · 20 · 25 · 32 type	1	16 A	H05VV-U3G (NOTE 1)	Size must comply with local codes.
40 · 50 type				
63 type				

Model	Transmission wiring Remote controller wiring	
	Wire	Size (mm <sup>2</sup> )
15 · 20 · 25 · 32 type	Sheathed vinyl cord or cable (2 wires) (NOTE 2)	0.75 - 1.25
40 · 50 type		
63 type		

#### NOTES

- Shows only in case of protected pipes. Use H07RN-F in case of no protection.
- Insulated thickness : 1mm or more.
- If the wiring is in a place where people it can be easily touched by people, install an earth leakage breaker to prevent electric shock.
- When using an earth leakage breaker, make sure to select one useful also to protection against overcurrent and short-circuit.  
When using an earth leakage breaker only for earth device, make sure to use a wiring interrupter together.

- The length of the transmission wiring and remote controller wiring are as follows.

Length of the transmission wiring and remote controller wiring

Outdoor unit – Indoor unit	Max. 1000m (Total wiring length: 2000m)
Indoor unit – Remote controller	Max. 500m

### 9-3 ELECTRICAL CHARACTERISTICS

Model	Units			Power supply		Fan motor	
	Hz	Volts	Voltage range	MCA	MFA	KW	FLA
15 · 20 · 25 · 32	50	220-240	Min. 198 Max. 264	0.4	16	0.036	0.3
40				0.5		0.038	0.4
50				0.5		0.038	0.4
63				0.6		0.060	0.5
15 · 20 · 25 · 32	60	220	Min. 198 Max. 242	0.4	16	0.036	0.3
40				0.5		0.038	0.4
50				0.5		0.038	0.4
63				0.6		0.060	0.5

MCA: Minimum Circuit Amps (A) MFA:Max. Fuse Amps (A)  
KW: Fan motor output (kW) FLA:Full Load Amps (A)

## 10. WIRING EXAMPLE

### 10-1 HOW TO CONNECT WIRINGS

- Wire only after removing the control box lid as shown in Fig. 17, referring to view A.

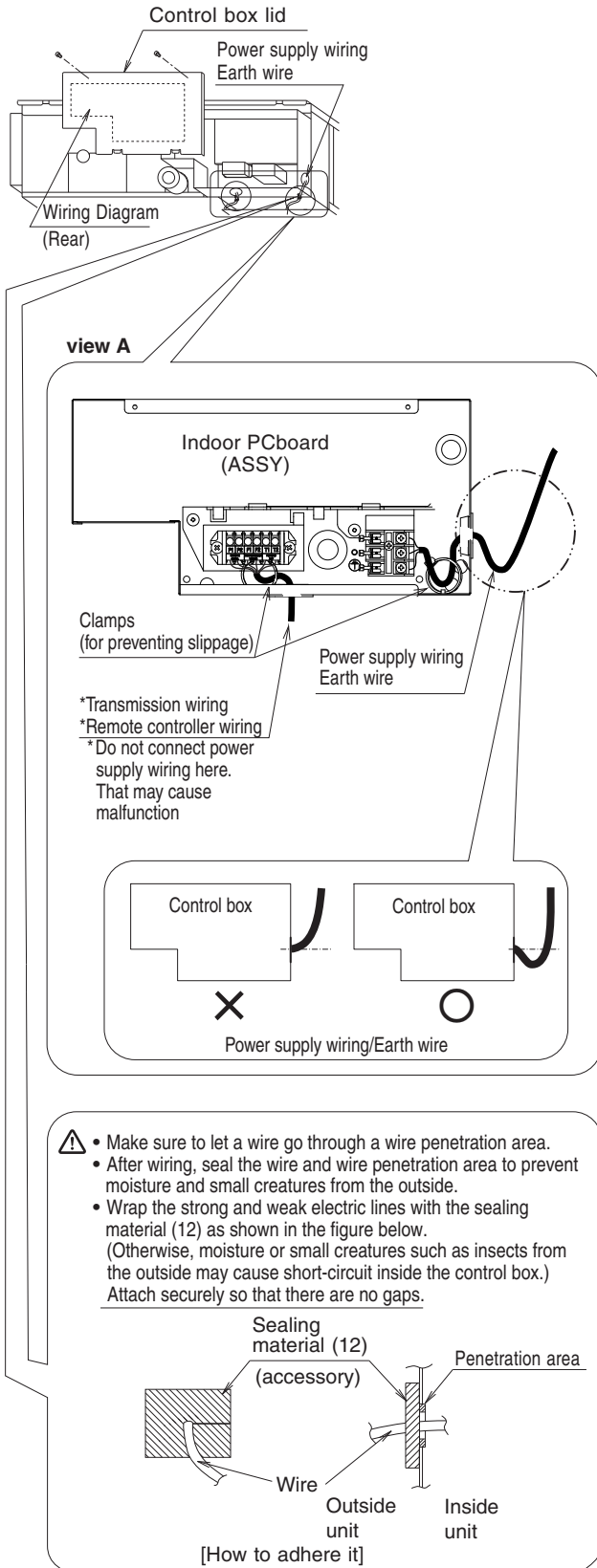

Fig. 17

### ⚠ CAUTION

- Be sure to attach power supply wiring and earth wire to the control box with the clamp.
- When doing the wiring, make sure the wiring is neat and does not cause the control box lid to stick up, then close the cover firmly. When attaching the control box lid, make sure you do not pinch any wires.
- Outside the air conditioners, separate the weak wiring (remote controller and transmission wiring) and strong wiring (earth wire and power supply wiring) at least 50 mm so that they do not pass through the same place together. Proximity may cause electrical interference, malfunctions, and breakage.
- A main switch or other means for disconnection, having a contact separation in all poles, must be incorporated in the fixed wiring in accordance with relevant local and national legislation.  
Note that the operation will restart automatically if the main power supply is turned off and then turned back on again.

### [ PRECAUTIONS ]

- Refer to the "REMOTE CONTROLLER INSTALLATION MANUAL" on how to install and lay the wiring for the remote controller.
- See also the "Wiring Diagram plate" attached to the control box lid when laying electrical wiring.
- Connect the remote controller and transmission wiring their respective terminal blocks.

### ⚠ CAUTION

- **Do not, under any circumstances, connect the power supply wiring to the remote controller or transmission wiring terminal block. Doing so can destroy the entire system.**

### [ Connecting electrical wiring, remote controller wiring, and transmission wiring ] (Refer to Fig. 18)

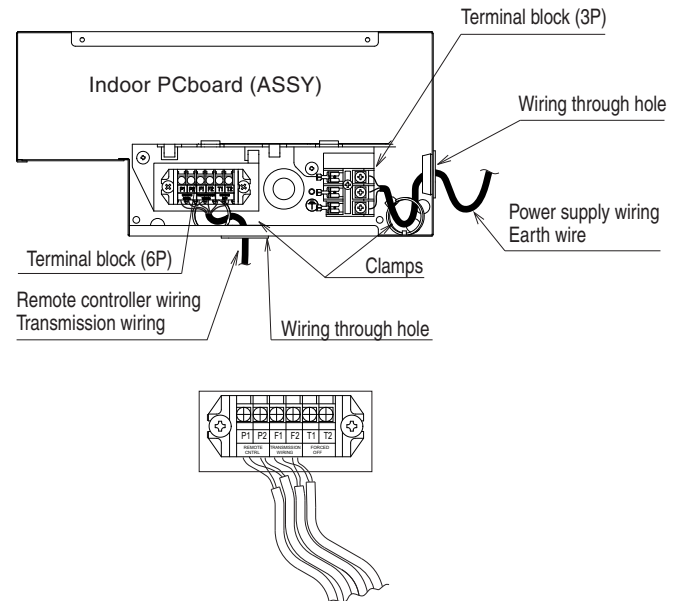

Fig. 18

### • Power supply and Earth wiring

Remove the control box lid.

Next, pull the wires into the unit through the wiring through hole and connect to the terminal block (3P).

Be sure to put the part of the sheathed vinyl into the control box.

- **Remote controller and transmission wiring**  
Pull the wires into the unit through the wiring through hole and connect to the terminal block (6P).  
Be sure to put the part of the sheathed vinyl into the control box.

〈 **Precautions when laying power supply wiring** 〉

- Wiring of different thicknesses cannot be connected to the power supply wiring terminal block. (Slack in the power supply wiring may cause abnormal heat.)
- Use sleeve-insulated round crimp-style terminals for connections to the power supply wiring terminal block. When none are available, connect wires of the same diameter to both sides, as shown in the figure.

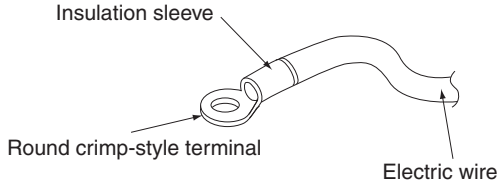

Connect wires of the same gauge to both sides.

Do not connect wires of the same gauge to one side.

Do not connect wires of different gauges.

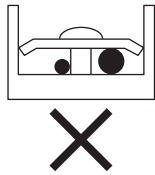
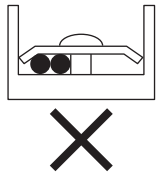
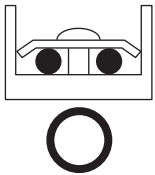

**Follow the instructions are below if the wiring may get very hot due to slack in the power supply wiring.**

- For wiring, use the designated power supply wiring and connect firmly, then secure to prevent outside pressure being exerted on the terminal board.
- Use the correct screwdriver for tightening the terminal screws. If the blade of screwdriver is too small, the head of the screw might be damaged, and the screw will not be properly tightened.
- If the terminal screws are tightened too hard, screws might be damaged.
- Refer to the table below for the tightening torque of the terminal screws.

Terminal block	Tightening torque (N·m)
Remote controller / transmission wiring terminal block (6P)	0.79 – 0.97
Power supply wiring terminal block (3P)	1.18 – 1.44

**[ WIRING EXAMPLE ]**

**No. 1 system When using 1 remote controller for 1 indoor unit**

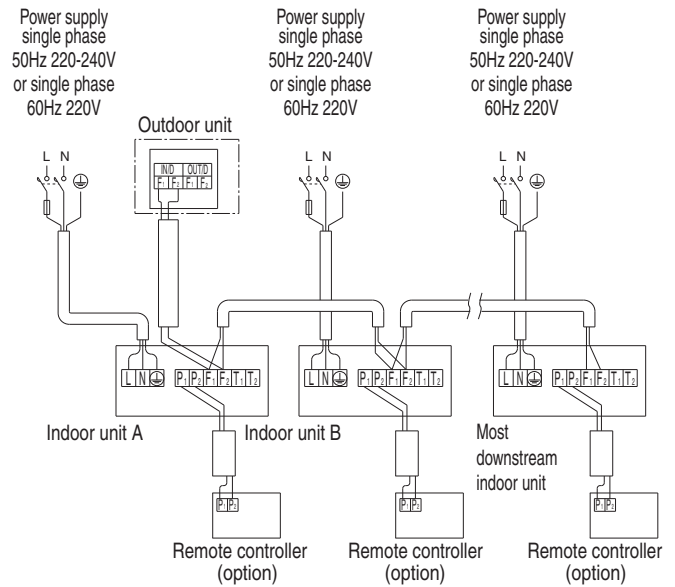

**Fig. 19**

**No. 2 system For group control or use with 2 remote controllers**

Power supply single phase  
50Hz 220-240V  
or single phase  
60Hz 220V

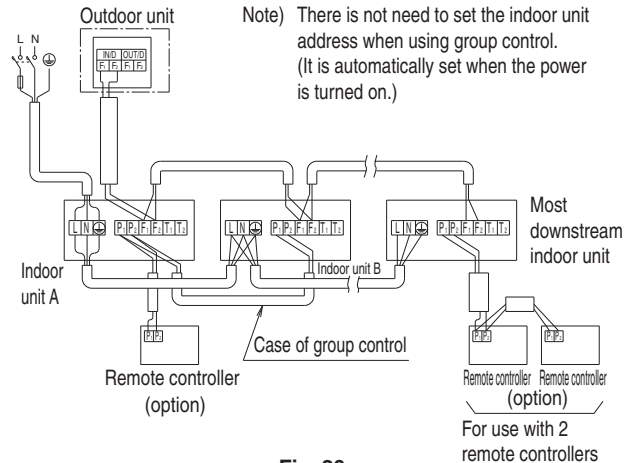

Note) There is not need to set the indoor unit address when using group control. (It is automatically set when the power is turned on.)

**Fig. 20**

### No. 3 system When including BS unit

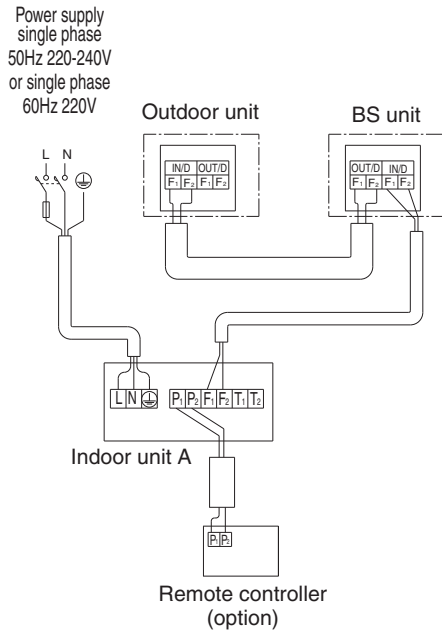

Fig. 21

### 10-2 CONTROL BY 2 REMOTE CONTROLLERS (Controlling 1 indoor unit by 2 remote controllers)

- When using 2 remote controllers, one must be set to "MAIN" and the other to "SUB".

#### MAIN/SUB CHANGEOVER

- Insert a screwdriver into the recess between the upper and lower part of remote controller and, working from the 2 positions, pry off the upper part (2 locations).

The remote controller PC board is attached to the upper part of remote controller.

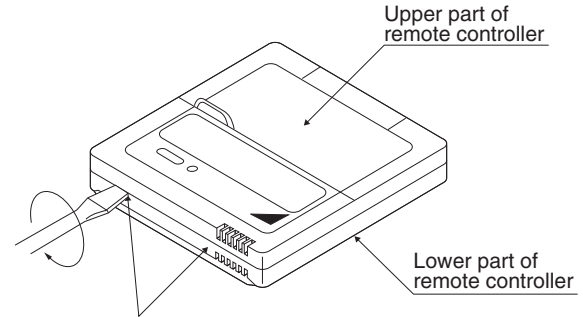

Insert the screwdriver here and gently work off the upper part of remote controller.

- Turn the MAIN/SUB changeover switch on one of the two remote controller PC boards to "S".  
(Leave the switch of the other remote controller set to "M".)

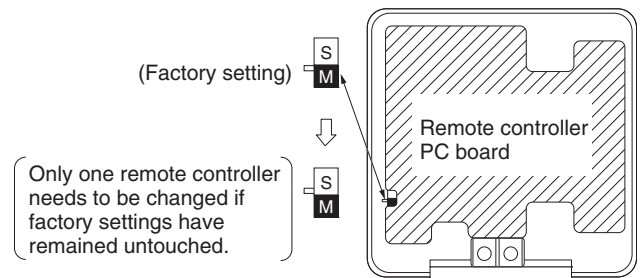

#### Wiring Method (See "9. ELECTRIC WIRING WORK")

- Remove the control box lid.
- Add remote controller 2 (SUB) to the terminal block for remote controller (P<sub>1</sub>, P<sub>2</sub>) in the control box.  
(There is no polarity.)

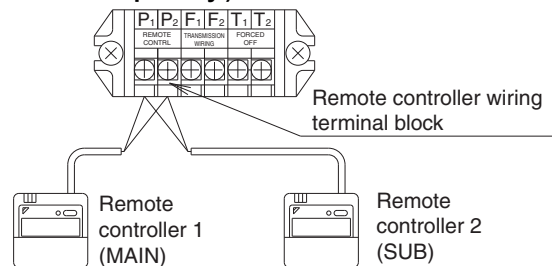

**[ PRECAUTIONS ]**

- Crossover wiring is needed when using group control and 2 remote controllers at the same time.
- Connect the indoor unit at the end of the crossover wire (P<sub>1</sub>, P<sub>2</sub>) to remote controller 2 (SUB).

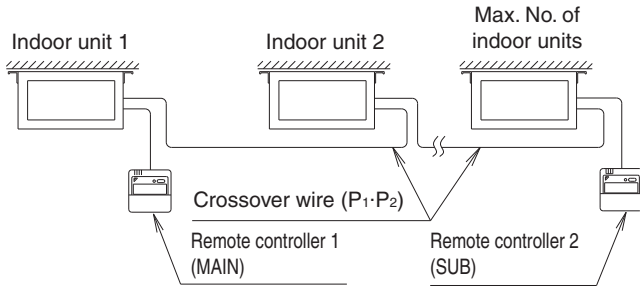

**10-3 REMOTE CONTROL (FORCED OFF AND ON/OFF OPERATION)**

- Connect input lines from the outside to the terminals T<sub>1</sub> and T<sub>2</sub> on the terminal block (6P) for remote controller to achieve remote control.
- See the “11. FIELD SETTING AND TEST RUN” for details on operation.

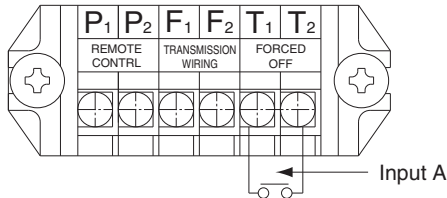

Wire specification	Sheathed vinyl cord or cable (2 wires)
Gauge	0.75 - 1.25 mm <sup>2</sup>
Length	Max. 100 m
External terminal	Contact that can ensure the minimum applicable load of 15 V DC, 1 mA.

**10-4 CENTRALIZED CONTROL**

- For centralized control, it is necessary to designate the group No. For details, refer to the manual of each optional controllers for centralized control.

**11. FIELD SETTING AND TEST RUN**

(Field settings may have to be performed using the remote controller, depending on the type of installation.)

- (1) Make sure the control box lids are closed on the indoor and outdoor units.
- (2) Depending on the type of installation, make the field settings from the remote controller after the power is turned on, following the “Field Settings” manual which came with the remote controller.
  - The settings can select “Mode No.,” “FIRST CODE NO.” and “SECOND CODE NO.”.
  - The “Field Settings” included with the remote controller lists the order of the settings and method of operation.

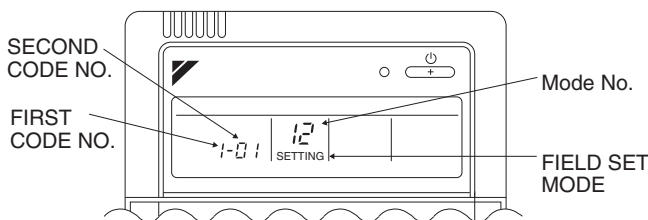

- Lastly, make sure the customer keeps the “Field Settings” manual, along with the operating manual, in a safe place.

**11-1 SETTING THE STATIC PRESSURE SELECTION**

- Select the SECOND CODE NO. for the resistance of the connected duct.  
(The SECOND CODE NO. is set to “01” when shipped.)
- See the technical documentation for details.

External static pressure	Mode No.	FIRST CODE NO.	SECOND CODE NO.
Standard (10Pa)	13(23)	5	01
High static pressure setting (30Pa)			02

**11-2 REMOTE CONTROL SETTING**

- Forced off and ON/OFF operation should be selected by selecting the SECOND CODE NO. as shown in the table below.  
(The SECOND CODE NO. is set to “01” when shipped.)

External ON/OFF input	Mode No.	FIRST CODE NO.	SECOND CODE NO.
Forced off	12(22)	1	01
ON/OFF operation			02

- Input A of forced off and ON/OFF operation work as shown in the table below.

Forced off	ON/OFF operation
Input A “on” to force a stop (remote controller reception prohibited)	Unit operated by changing input A from “off” to “on”
Input A “off” to allow remote controller	Unit stopped by changing input A from “on” to “off”

**11-3 SETTING THE FILTER SIGN DISPLAY INTERVAL**

- Explain the following to the customer if the filter dirt settings have been changed.
- The filter sign display time is set to 2500 hours (equivalent to 1 year’s use) when shipped.
- The settings can be changed to not display.
- When installing the unit in a place with much dusts, set the filter sign display time to shorter intervals (1,250 hours).
- Explain it to the customer that the filter needs to be cleaned regularly to prevent clogging and also the time that is set.

Mode No.	FIRST CODE NO.		SECOND CODE NO.	
			01	02
10 (20)	0	Filter dirt	low	high
	1 (low/high)	Displayed time (units: hours)	2500/ 1250	10000/ 5000
	3	Filter sign display	ON	OFF

## 11-4 SETTINGS FOR SEPARATELY SOLD ACCESSORIES

- See the instruction manuals included with separately sold accessories for the necessary settings.





### 〈 When using a wireless remote controller 〉

- A wireless remote controller address needs to be set when using a wireless remote controller. See the installation manual included with the wireless remote controller for details on how to make the settings.

### (3) Perform a test run according to the outdoor unit's installation manual.

- The operation lamp of the remote controller will flash when a malfunction occurs. Check the malfunction code on the liquid crystal display to identify the point of trouble. An explanation of malfunction codes and the corresponding trouble is provided in "CAUTION FOR SERVICING" of the outdoor unit.

If the display shows any of the following, there is a possibility that the wiring was done incorrectly or that the power is not on, so check again.

Remote control display	Content
"  " display	<ul style="list-style-type: none"> <li>• There is a short circuit at the FORCED OFF terminals (T<sub>1</sub>, T<sub>2</sub>).</li> </ul>
"  " display	<ul style="list-style-type: none"> <li>• The test-run has not been performed.</li> </ul>
"  " display "  " display	<ul style="list-style-type: none"> <li>• The power on the outdoor unit is off.</li> <li>• The outdoor unit has not been wired for power supply.</li> <li>• Wiring is incorrect for the transmission wiring and / or FORCED OFF wiring.</li> <li>• The transmission wiring is cut.</li> </ul>
"  " display	<ul style="list-style-type: none"> <li>• Reversed transmission wiring</li> </ul>
No display	<ul style="list-style-type: none"> <li>• The power on the indoor unit is off.</li> <li>• The indoor unit has not been wired for power supply.</li> <li>• Wiring is incorrect for the remote controller wiring, the transmission wiring and / or the FORCED OFF wiring.</li> <li>• The remote controller wiring is cut.</li> </ul>



### CAUTION

- Always stop the test run using the remote controller to stop operation.

### (4) After finishing the test run, make sure to check drainage in the drain pump according to "7. DRAIN PIPING WORK".



## 12. WIRING DIAGRAM

	: FIELD WIRING
	: CONNECTOR
	: WIRE CLAMP
	: PROTECTIVE EARTH (SCREW)
L	: LIVE
N	: NEUTRAL

BLK	: BLACK	PRP	: PURPLE
BLU	: BLUE	RED	: RED
BRN	: BROWN	WHT	: WHITE
GRY	: GREY	YLW	: YELLOW
ORG	: ORANGE	GRN	: GREEN
PNK	: PINK		

### INDOOR UNIT

A1P	.....	PRINTED CIRCUIT BOARD
C105	.....	CAPACITOR
PS	.....	POWER SUPPLY CIRCUIT
F1U	.....	FUSE (T, 3,15A, 250V)
F2U	.....	FIELD FUSE
HAP	.....	LIGHT EMITTING DIODE (SERVICE MONITORING –GREEN)
M1F	.....	MOTOR (FAN)
M1P	.....	MOTOR (DRAIN PUMP)
Q1DI	.....	EARTH LEAK DETECTOR
R1T	.....	THERMISTOR (AIR)
R2T, R3T	.....	THERMISTOR (COIL)
S1L	.....	FLOAT SWITCH
V1R	.....	DIODE BRIDGE
X1M	.....	TERMINAL BLOCK (CONTROL)
X2M	.....	TERMINAL BLOCK (POWER SUPPLY)
Y1E	.....	ELECTRONIC EXPANSION VALVE
Z1F	.....	NOISE FILTER
Z1C	.....	FERRITE CORE (NOISE FILTER)

### RECEIVER/DISPLAY UNIT

A2P	.....	PRINTED CIRCUIT BOARD
A3P	.....	PRINTED CIRCUIT BOARD
BS1	.....	PUSH BUTTON (ON/OFF)
H1P	.....	LIGHT EMITTING DIODE (ON-RED)
H2P	.....	LIGHT EMITTING DIODE (FILTER DING-RED)
H3P	.....	LIGHT EMITTING DIODE (TIMER-GREEN)
H4P	.....	LIGHT EMITTING DIODE (DEFROST-ORANGE)
SS1	.....	SELECTOR SWITCH (MAIN/SUB)
SS2	.....	SELECTOR SWITCH (WIRELESS ADDRESS SET)

### ADAPTOR FOR WIRING

KHuR	.....	MAGNETIC RELAY
KFR	.....	MAGNETIC RELAY
KCR	.....	MAGNETIC RELAY
F3U, F4U	.....	FUSE ( (B), 5A, 250V)

### CONNECTOR FOR OPTIONAL PARTS

X24A	.....	CONNECTOR (WIRELESS REMOTE CONTROLLER)
X33A	.....	CONNECTOR (ADAPTOR FOR WIRING)
X35A	.....	CONNECTOR (POWER SUPPLY CONNECTOR)
X38A	.....	CONNECTOR (MULTI TENANT)

### WIRED REMOTE CONTROLLER

R1T	.....	THERMISTOR (AIR)
SS1	.....	SELECTOR SWITCH (MAIN/SUB)

WIRED REMOTE CONTROLLER	:	Wired remote controller
(OPTIONAL ACCESSORY)	:	(Optional accessory)
SWITCH BOX (INDOOR)	:	Switch box (indoor)
TRANSMISSION WIRING	:	Transmission wiring
CENTRAL REMOTE CONTROLLER	:	Central remote controller
INPUT FROM OUTSIDE	:	Input from outside

#### NOTE



1. USE COPPER CONDUCTORS ONLY.
2. WHEN USING THE CENTRAL REMOTE CONTROLLER, SEE MANUAL FOR CONNECTION TO THE UNIT.
3. WHEN CONNECTING THE INPUT WIRES FROM OUTSIDE, FORCED "OFF" OR "ON/OFF" CONTROL OPERATION CAN BE SELECTED BY THE REMOTE CONTROLLER. SEE INSTALLATION MANUAL FOR MORE DETAILS.
4. REMOTE CONTROLLER MODEL VARIES ACCORDING TO THE COMBINATION SYSTEM, CONFIRM ENGINEERING DATA AND CATALOGS, ETC. BEFORE CONNECTING.

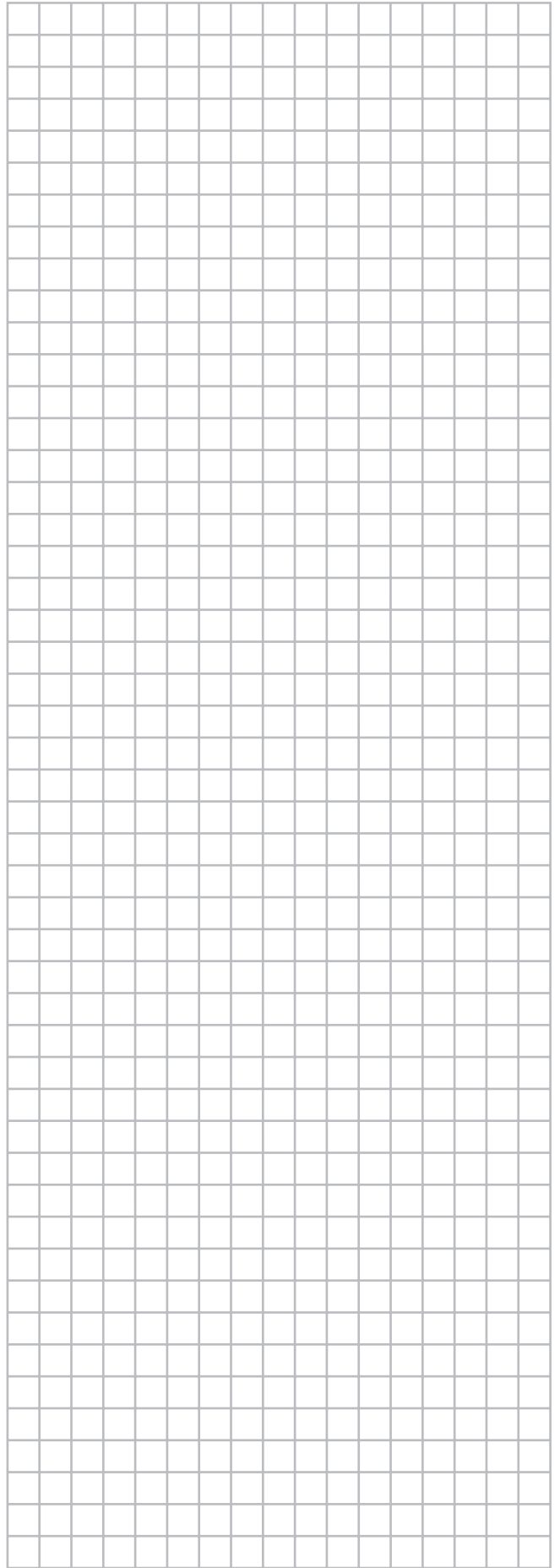
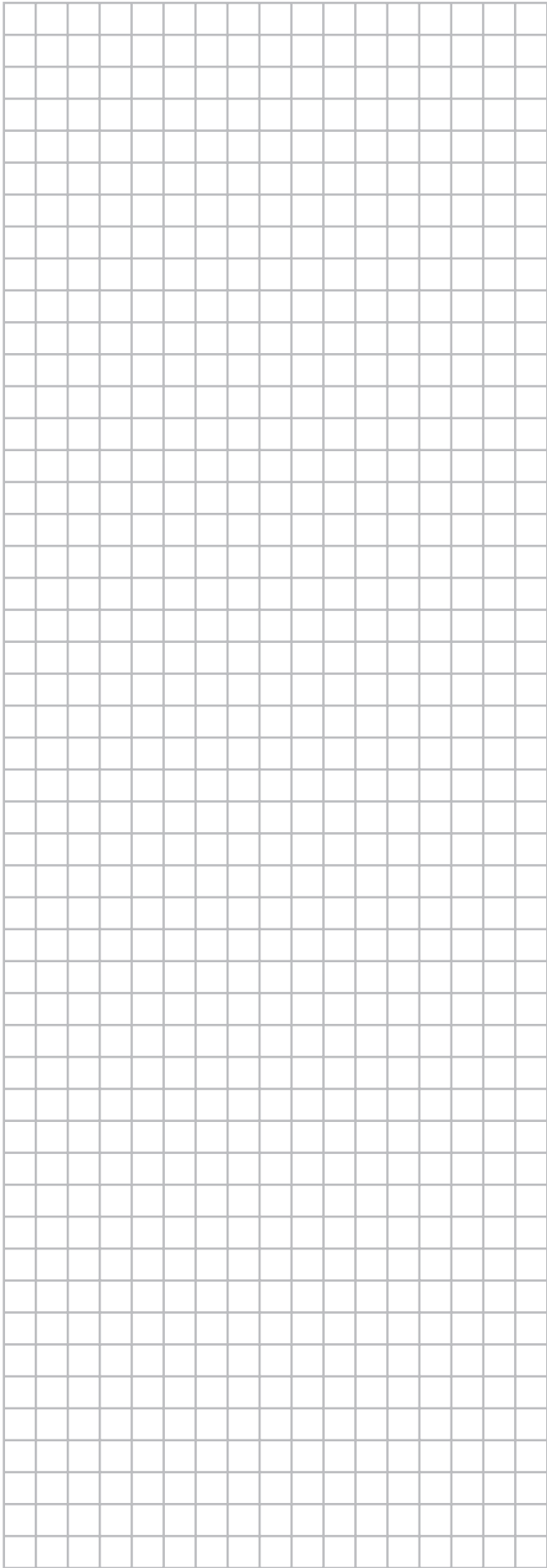

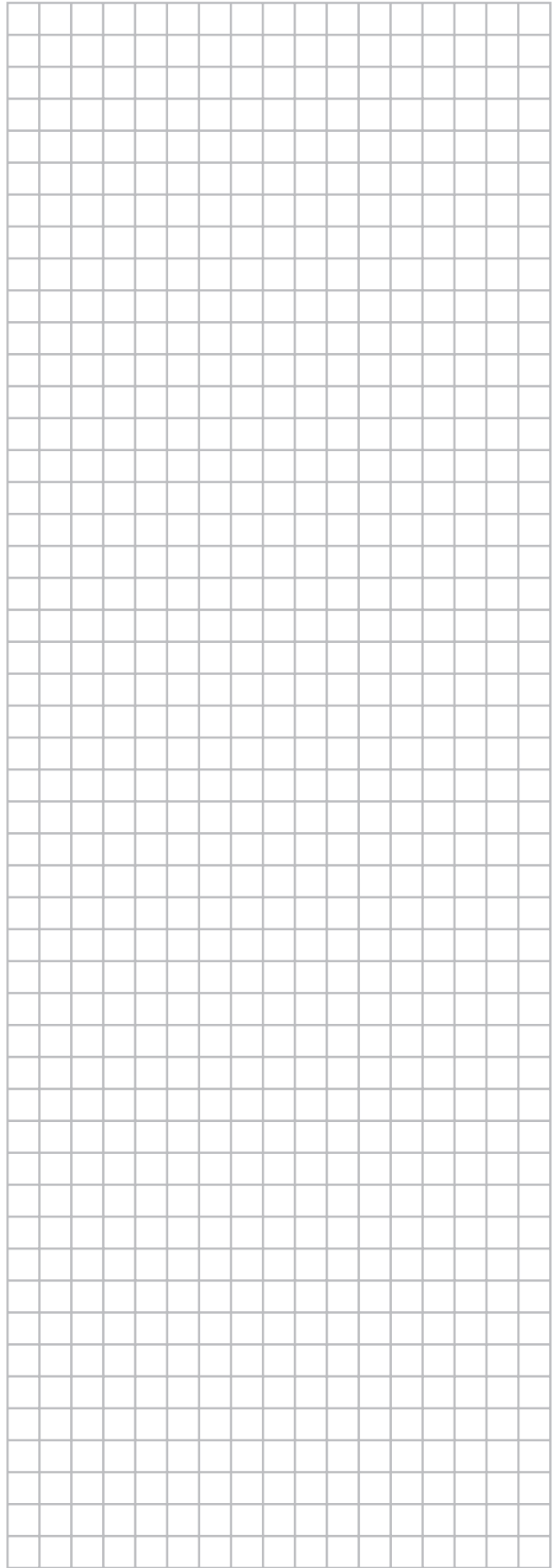
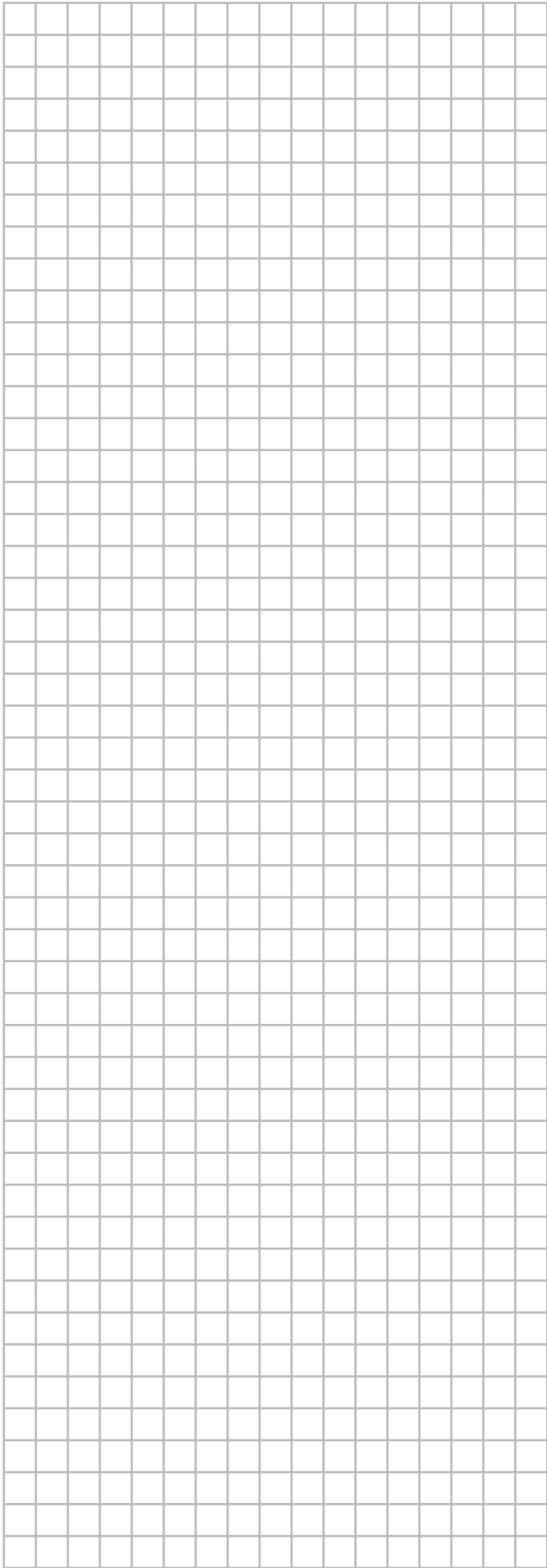

**DAIKIN INDUSTRIES CZECH REPUBLIC s.r.o.**

U Nové Hospody 1/1155, 301 00 Plzeň Skvrňany, Czech Republic

**DAIKIN EUROPE N.V.**

Zandvoordestraat 300, B-8400 Oostende, Belgium

Copyright 2012 Daikin



4P325876-1 2012.07