

DAIKIN



OPERATION MANUAL

VRV System Inverter Air Conditioners

FXDQ15A2VEB
FXDQ20A2VEB
FXDQ25A2VEB
FXDQ32A2VEB
FXDQ40A2VEB
FXDQ50A2VEB
FXDQ63A2VEB

Thank you for purchasing this Daikin air conditioner.

Carefully read this operation manual before using the air conditioner.

This operation manual is prepared for only the indoor unit. To understand the whole set fully, read this manual together with the operation manual for the outdoor unit.

The next items are described in the operation manual for the outdoor unit.

- Part names and functions of remote controller
- Operation procedure
- Troubleshooting

For the warranty card, receive it from your dealer and store it with this operation manual.

Vielen Dank für den Kauf einer Klimaanlage von Daikin.

Lesen Sie dieses Betriebshandbuch vor Inbetriebnahme der Klimaanlage sorgfältig durch.

In diesem Handbuch wird nur die Installation der Raumeinheit beschrieben. Um die Gesamtanlage zu verstehen, lesen sie dieses Handbuch zusammen mit dem Handbuch der Außeneinheit.

In der Bedienungsanleitung der Außeneinheit finden Sie Details zu den folgenden Punkten.

- Teilebezeichnungen und Funktionen der Fernbedienung
- Bedienung
- Fehlersuche

Verwahren Sie die Garantiekarte, die Sie von Ihrem Händler erhalten, zusammen mit dieser Bedienungsanleitung auf.

Nous vous remercions pour votre acquisition de ce système de climatisation Daikin.

Lisez attentivement ce manuel avant d'utiliser le climatiseur.

Ce mode d'emploi ne concerne que l'unité intérieure. Pour bien comprendre tout le système, lisez ce mode d'emploi et celui de l'unité extérieure.

Les points suivants sont décrits dans le mode d'emploi de l'unité extérieure.

- Nom des pièces et fonctions de la télécommande
- Procédure d'utilisation
- Dépannage

Faites-vous remettre le bon de garantie par votre revendeur et rangez-le avec le mode d'emploi.

Wij danken u voor de aankoop van deze Daikin-airconditioner.

Lees deze bedrijfshandleiding aandachtig door voordat u de airconditioner gebruikt.

Deze bedieningshandleiding is alleen bedoeld voor de binnenunit. Lees deze handleiding en de bedieningshandleiding voor de buitenunit aandachtig door om de werking van het hele systeem te begrijpen.

In de bedieningshandleiding voor de buitenunit zijn de volgende items zijn beschreven.

- Onderdelenamen en functies van de afstandsbediening
- Bedieningsprocedure
- Storingen verhelpen

Bewaar de garantietaart die u van uw leverancier ontvangt bij deze bedieningshandleiding.

Le agradecemos la compra de este acondicionador de aire Daikin.

Lea cuidadosamente el manual de funcionamiento antes de utilizar el acondicionador de aire.

Este manual de uso hace referencia únicamente a la unidad interior. Para obtener información de todo el conjunto, lea este manual junto con el manual de uso para la unidad exterior.

Los siguientes elementos se describen en el manual de uso de la unidad exterior.

- Nombres de componentes y funciones del control remoto
- Procedimiento de funcionamiento
- Solución de problemas

Solicite la tarjeta de garantía a su concesionario y guárdela con este manual de uso.

La ringraziamo di aver acquistato questo condizionatore d'aria Daikin.

Leggere attentamente questo manuale prima di utilizzare il condizionatore.

Questo manuale di istruzioni riguarda solo l'unità interna. Per imparare a usare l'intero sistema, leggere questo manuale insieme al manuale di istruzioni dell'unità esterna.

Le voci seguenti vengono trattate nel manuale di istruzioni dell'unità esterna.

- Nome delle parti e funzioni del telecomando
- Procedure operative
- Risoluzione dei problemi

Per quanto riguarda il certificato di garanzia, esso viene consegnato al cliente dal rivenditore e il cliente è invitato a conservarlo insieme al manuale di istruzioni.

Σας ευχαριστούμε που αγοράσατε αυτή την κλιματιστική συσκευή της Daikin.

Διαβάστε προσεκτικά αυτό το εγχειρίδιο χρήσης πριν χρησιμοποιήσετε την κλιματιστική συσκευή.

Το παρόν εγχειρίδιο λειτουργίας έχει ετοιμαστεί μόνο για την εσωτερική μονάδα. Για την πλήρη κατανόηση όλου του συνόλου, διαβάστε το παρόν εγχειρίδιο μαζί με το εγχειρίδιο λειτουργίας της εξωτερικής μονάδας.

Τα επόμενα αντικείμενα περιγράφονται στο εγχειρίδιο λειτουργίας της εξωτερικής μονάδας.

- Όνομα ανταλλακτικών και λειτουργία του τηλεχειριστηρίου
- Διαδικασία λειτουργίας
- Αντιμετώπιση προβλημάτων

Για την κάρτα εγγύησης, παραλάβετε την από τον αντιπρόσωπο σας και κρατήστε την μαζί με το εγχειρίδιο λειτουργίας.

Obrigado pela sua compra deste aparelho de ar condicionado Daikin.

Leia com atenção este manual de operação antes de proceder à utilização do aparelho de ar condicionado.

Este manual de utilização destina-se exclusivamente à unidade interior. Para entender exaustivamente a totalidade do aparelho, leia este manual em conjunto com o manual de utilização da unidade exterior.

Os itens seguintes são descritos no manual de utilização da unidade exterior.

- Nomes de peças e funções do controlador remoto
- Procedimento de funcionamento
- Resolução de Problemas

Relativamente ao cartão de garantia, obtenha-o junto do representante e guarde-o com este manual de funcionamento.

Благодарим за покупку кондиционера Daikin.

До начала работы с кондиционером внимательно изучите данное руководство по эксплуатации.

Данное руководство по эксплуатации относится только к комнатному блоку. Для того чтобы полностью ознакомиться с комплектом, прочтите данное руководство вместе с руководством по эксплуатации наружного блока.

В руководстве по эксплуатации наружного блока приводится описание следующих пунктов.

- Наименования частей и функции удаленного контроллера
- Процедура эксплуатации
- Поиск и устранение неисправностей

Получите у Вашего дилера гарантийный талон и храните его вместе с данным руководством по эксплуатации.

Daikin klima satın aldığınız için teşekkür ederiz.

Klimanızı kullanmadan önce bu kullanma kılavuzunu dikkatlice okuyunuz.

Bu işletme elkitabı sadece iç ünite için hazırlanmıştır. Tüm seti tam anlamak için, bu elkitabını dış ünitenin işletme elkitabıyla birlikte okuyun.

Aşağıdaki öğeler, dış ünitenin işletme elkitabında açıklanmıştır.

- Parça adları ve uzaktan kumandanın işlevleri
- Çalışma prosedürü
- Arıza giderme

Garanti kartını satıcınızdan alın ve bu işletme elkitabıyla birlikte saklayın.

Part name and functions

In case of suction from bottom side

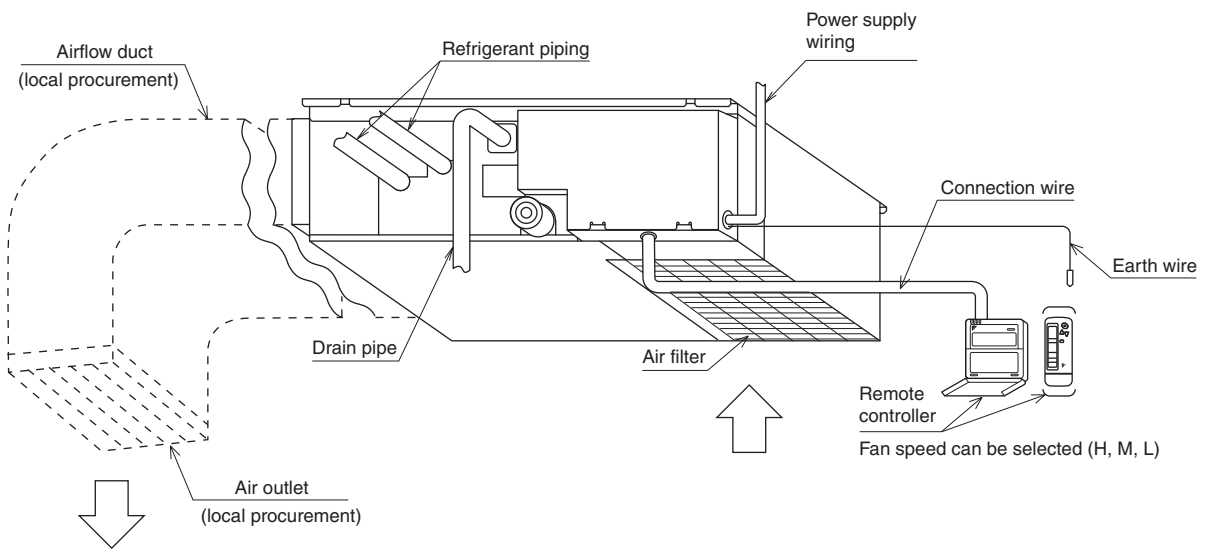

Σε περίπτωση αναρρόφησης από την πίσω πλευρά

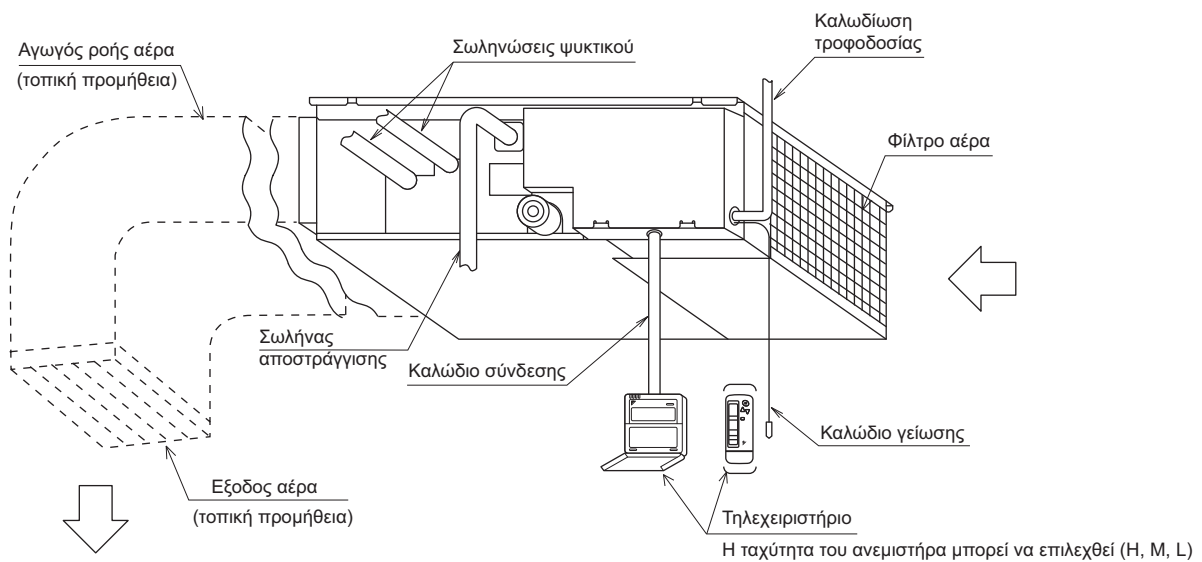

The original instructions are written in English. All other languages are translations of the original instructions.

Important information regarding the refrigerant used

This product contains fluorinated greenhouse gases covered by the Kyoto Protocol.

Refrigerant type: R410A

GWP⁽¹⁾ value: 1975

⁽¹⁾ GWP = global warming potential

Periodical inspections for refrigerant leaks may be required depending on European or local legislation. Please contact your local dealer for more information.

Safety precautions

To gain full advantage of the air conditioner's functions and to avoid malfunction due to mishandling, we recommend that you read this instruction manual carefully before use.

- This air conditioner is classified under "appliances not accessible to the general public".
- **The precautions described herein are classified as WARNING and CAUTION. They both contain important information regarding safety. Be sure to observe all precautions without fail.**

 **WARNING** Failure to follow these instructions properly may result in personal injury or loss of life.

 **CAUTION** Failure to observe these instructions properly may result in property damage or personal injury, which may be serious depending on the circumstances.

After reading, keep this manual in a convenient place so that you can refer to it whenever necessary. If the equipment is transferred to a new user, be sure also to hand over the manual.

WARNING

- **Consult your local dealer about installation work.**
Doing the work yourself may result in water leakage, electric shocks or fire hazards.
- **Consult your local dealer regarding modification, repair and maintenance of the air conditioner.**
Improper workmanship may result in water leakage, electric shocks or fire hazards.

- **Beware of fire in case of refrigerant leakage.**
If the air conditioner is not operating correctly, i.e. not generating cool or warm air, refrigerant leakage could be the cause.
Consult your dealer for assistance.
The refrigerant within the air conditioner is safe and normally does not leak.
However, in the event of a leakage, contact with a naked burner, heater or cooker may result in generation of noxious gas.
Do not longer use the air conditioner until a qualified service person confirms that the leakage has been repaired.
- **Consult your local dealer regarding relocation and reinstallation of the air conditioner.**
Improper installation work may result in leakage, electric shocks or fire hazards.
- **This appliance is not intended for use by persons, including children, with reduced physical, sensory or mental capabilities, or lack of experience and knowledge, unless they have been given supervision or instruction concerning use of the appliance by a person responsible for their safety.**
Children shall be supervised to ensure that they do not play with the appliance.

CAUTION

- **Do not place objects in direct proximity of the outdoor unit and do not let leaves and other debris accumulate around the unit.**
Leaves are a hotbed for small animals which can enter the unit. Once in the unit, such animals can cause malfunctions, smoke or fire when making contact with electrical parts.
- **This appliance is intended to be used by expert or trained users in shops, in light industry and on farms, or for commercial use by lay persons.**

Maintenance

WARNING

- **Only a qualified person is allowed to perform maintenance without daily maintenance.**
- **Before touching any of connection wirings, be sure to turn off all power supply switches.**
- **Do not use flammable materials (e.g., hair-spray or insecticide) near the product. Do not clean the product with organic solvents such as paint thinner.**
The use of organic solvents may cause crack damage to the product, electric shocks, or fire.

- **Contact professional personnel about attachment of accessories and be sure to use only accessories specified by the manufacturer.**

If a defect results from your own workmanship, it may result in water leaks, electric shock or fire.

⚠ CAUTION

- **Before cleaning, be sure to stop unit operation, turn the breaker off or remove the power cord.**

Otherwise, an electric shock and injury may result.

- **Do not wash the air conditioner with water, as this may result in electric shocks or fire.**

- **Consult your dealer regarding cleaning the inside of the air conditioner.**

Improper cleaning may cause breakage of plastic parts, water leakage and other damage as well as electric shocks.

- **Watch your steps at the time of air filter cleaning or inspection.**

High-place work is required, to which utmost attention must be paid.

If the scaffold is unstable, you may fall or topple down, thus causing injury.

⟨Maintenance and inspection⟩

- Clean the drain pan periodically. The drain pipes clogged with dust will cause water leakage.
- For cleaning, consult with your Daikin dealer. (Before each season when cooling or heating is required, clean the air conditioner.)
- If the area around the indoor unit is very dusty, use a dust-proof cover (local procurement).

⟨Cleaning the inside of the indoor unit⟩

- It is necessary to clean the inside of the indoor unit periodically.

Since the cleaning requires special technologies, request a Daikin dealer to clean them.

Daily maintenance:

⟨Cleaning the air filter⟩

Explanation

- Removing the air filter except when cleaning the air conditioner may result in accidents.
- When the  mark is displayed on the remote controller, please clean the filter.
- When the operating time exceeds the designated time, this mark will be displayed.
- If using the air conditioner under very dusty environment, increase the frequency of air filter cleaning.

- When you want to change the setting time until the  mark is displayed, consult with your dealer.

(The default factory setting is 2500 hours.)

- There are the following time, display pattern.
1250, 2500, 5000, 10000

1. Remove the air filter.

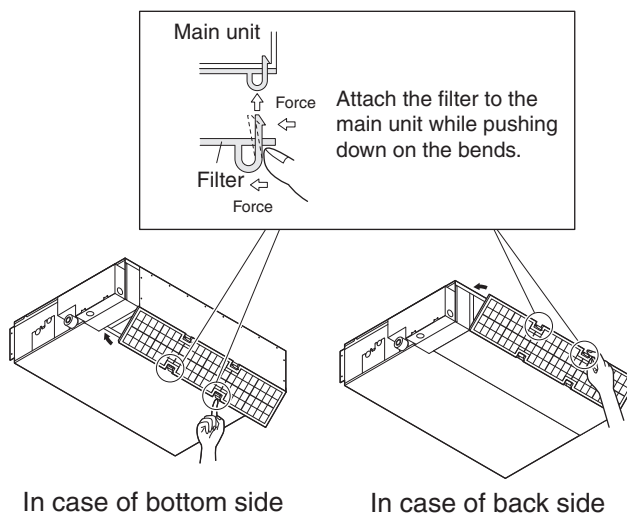

2. Clean it.

⚠ CAUTION

- Do not wash the air conditioner with hot water of more than 50°C. Doing so may result in discoloration or deformation.
- Never dry the filter by direct firing. Doing so may result in burning.
- For cleaning local procurements, consult with your dealer.

- (1) Use a vacuum cleaner (A) or wash the air filter (B) to remove dust and trash.

- (A) Remove dust and trash using a vacuum cleaner.



- (B) Wash it with water.

When the air filter is very dirty, use a soft brush and neutral detergent.



Dewater and dry in the shade.



3. Attach the air filter.

4. Push the “filter sign reset” button on the remote controller.

The display “” vanishes.

⟨Cleaning the air outlet and exterior⟩

CAUTION

- Do not use gasoline, benzene, thinner, polishing powder or liquid insecticide.
- Do not use hot water of 50°C or higher, as doing so may result in discoloration or deformation.

(1) Clean with dry soft cloth.
(When it is difficult to remove stains, use water or neutral detergent.)

If the following phenomenon occurs, contact your dealer.

WARNING

- **When the air conditioner is malfunctioning (giving off a burning odour, etc.) turn off power to the unit and contact your local dealer.**

Continued operation under such circumstances may result in a failure, electric shocks or fire hazards.

- **Contact your dealer.**

Phenomenon

- If a safety device such as a fuse, a breaker or an earth leakage breaker frequently actuates; **Take the following actions before contact.** Do not turn on the main power switch.
- If the ON/OFF switch does not properly work; **Take the following actions before contact.** Turn off the main power switch.

Phenomenon

- Water leaks out from the air conditioner. **Take the following actions before contact.** Stop the operation.

Phenomenon

- The “OPERATION lamp”, “INSPECTION display” or “UNIT No.” is winking and lit, and “MALFUNCTION CODE” is displayed.

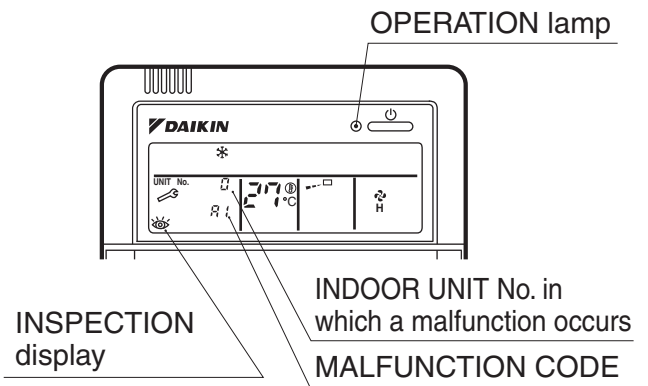

Take the following actions before contact. Inform the dealer of the details being displayed on the remote controller.

Product type and running noise

Model No.		15	20	25	32	40	50	63
		Model						
Type	Function	Heat pump type						
	Combination system	Separate type						
	Condenser cooling method	Air cooling type						
	Air blowing method	Direct air-blowing type						
	Rated cooling capacity (W)	1700	2200	2800	3600	4500	5600	7100
	Rated heating capacity (W)	1900	2500	3200	4000	5000	6300	8000
Operating sound dB (A) (conversion values under noise-less room)		32	33	33	33	34	35	36

Explanation

- The actual value during operation is higher than the indicated value under the influence of environmental noise and echo.
- The above data is subject to change by means of technological innovation.
- The operating sound is based on the rear side suction inlet, and the external static pressure 10Pa.
Operating sound for under suction inlet:
[operating sound for rear side suction inlet] + 5dB.
However, when installation to which the external static pressure becomes low is carried out 5dB or more may go up.

After-sales service and maintenance

After-sales service:

— **WARNING** —

- **Consult your local dealer regarding modification, repair and maintenance of the air conditioner.**
Improper workmanship may result in water leakage, electric shocks or fire hazards.
- **Consult your local dealer regarding relocation and reinstallation of the air conditioner.**
Improper installation work may result in leakage, electric shocks or fire hazards.
- **Beware of fire in case of refrigerant leakage.**
If the air conditioner is not operating correctly, i.e. not generating cool or warm air, refrigerant leakage could be the cause.
Consult your dealer for assistance.
The refrigerant within the air conditioner is safe and normally does not leak.
However, in the event of a leakage, contact with a naked burner, heater or cooker may result in generation of noxious gas.
Do not longer use the air conditioner until a qualified service person confirms that the leakage has been repaired.

-
- **When asking your dealer to repair, inform related staff of the details as follows:**
 - Product No. of air conditioner:
Refer to the warranty card.
 - Shipping date and installation date:
Refer to the warranty card.
 - Malfunction:
Inform the staff of the defective details.
(Malfunction code being displayed on the remote controller.)
 - Name, address, telephone number
 - **Repair where the warranty term is expired**
Contact your dealer. If necessary to repair, pay service is available.
 - **Minimum storage period of important parts**
Even after a certain type of air conditioner is discontinued, we at Daikin have the related important parts in stock for 9 years at least.
The important parts indicate parts essential to operate the air conditioner.
 - **Maintenance and inspection**
Since dust collects after using the unit for several years, the performance will be deteriorated to some extent.
It is recommended to request the technical staff to perform maintenance (pay service). For further details, consult with your dealer.

- **Where to call**
For after-sales service, etc., consult with your dealer.
- **When disposing the air conditioner, removing/installing and maintaining it, collect the refrigerant.**

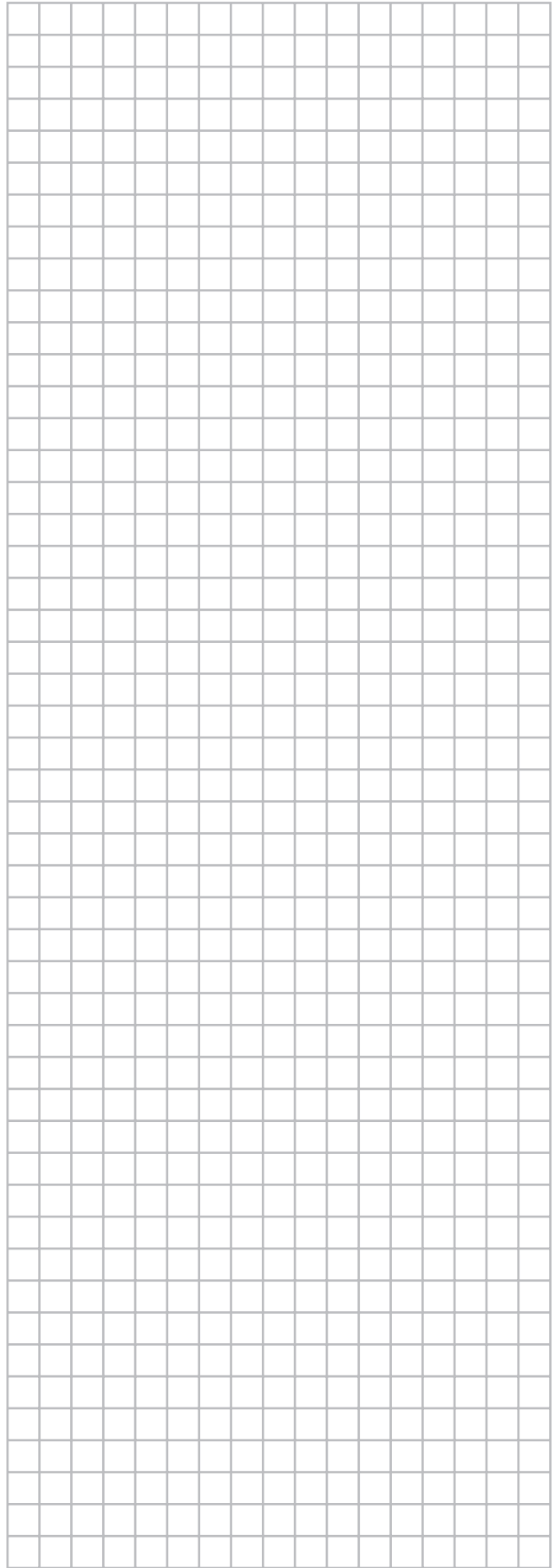
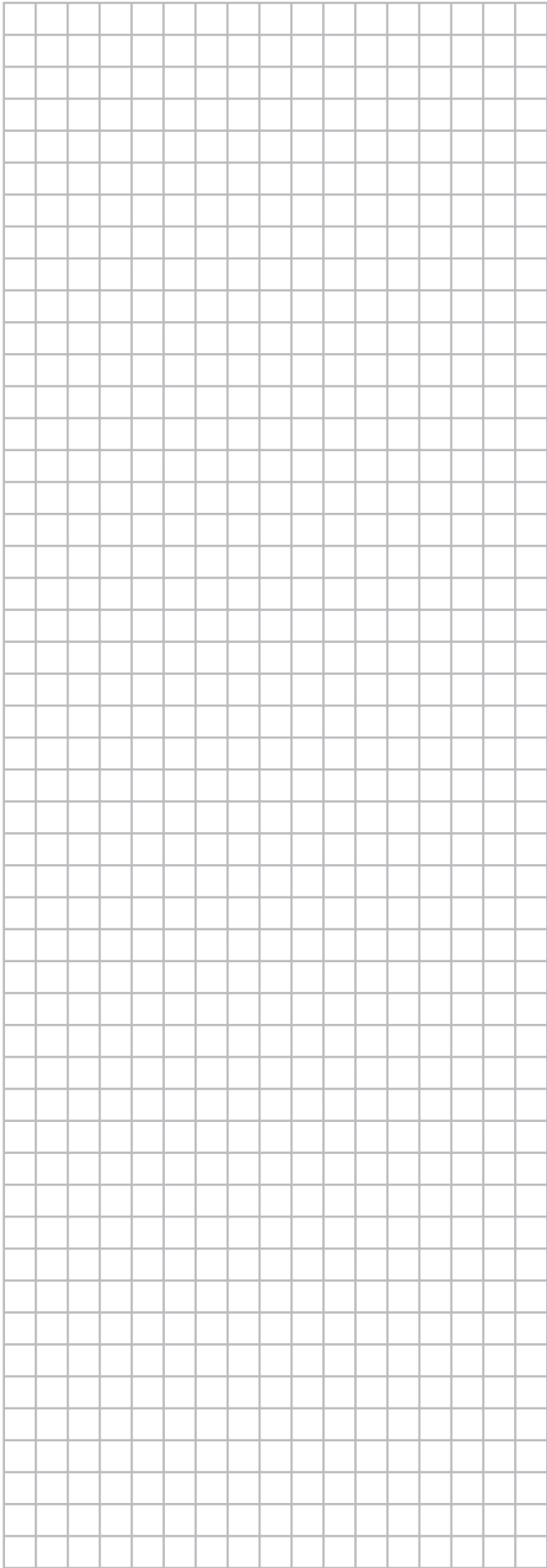

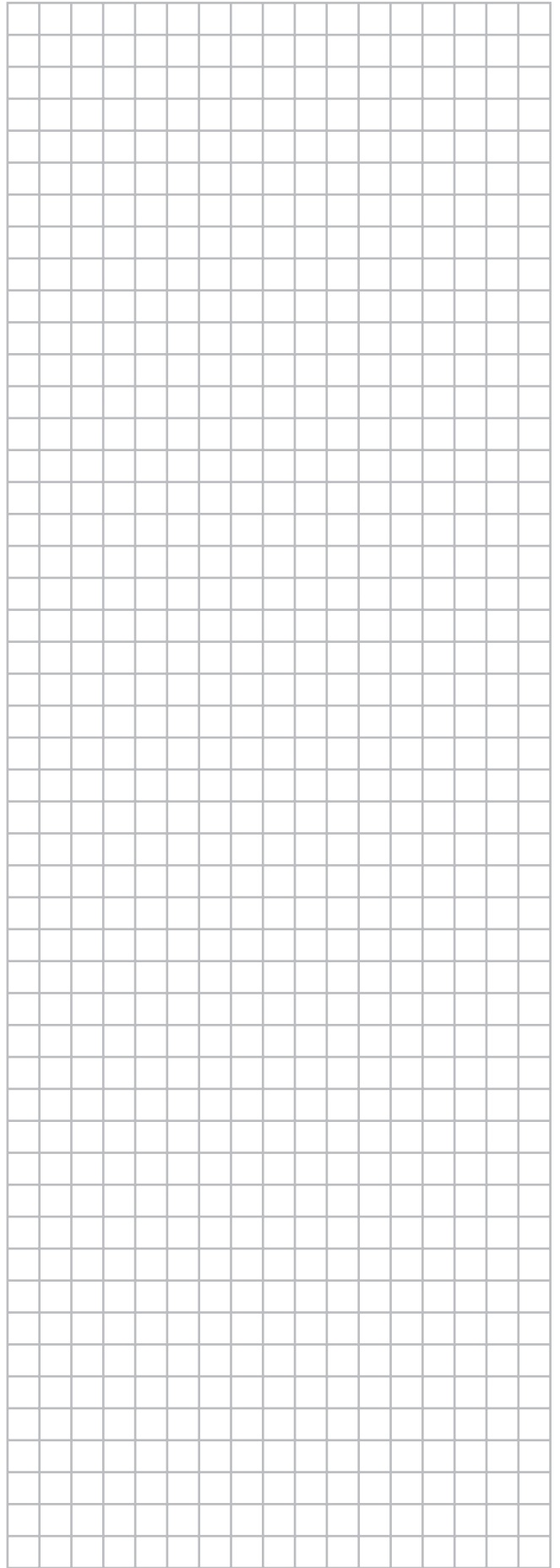
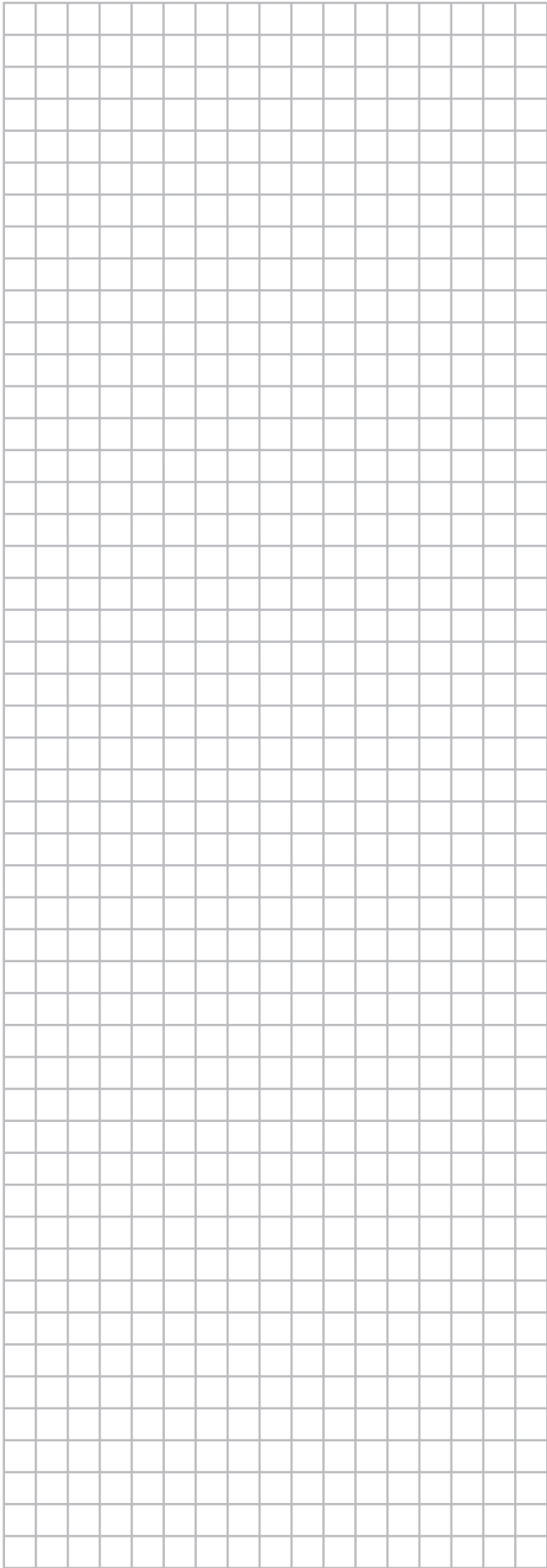

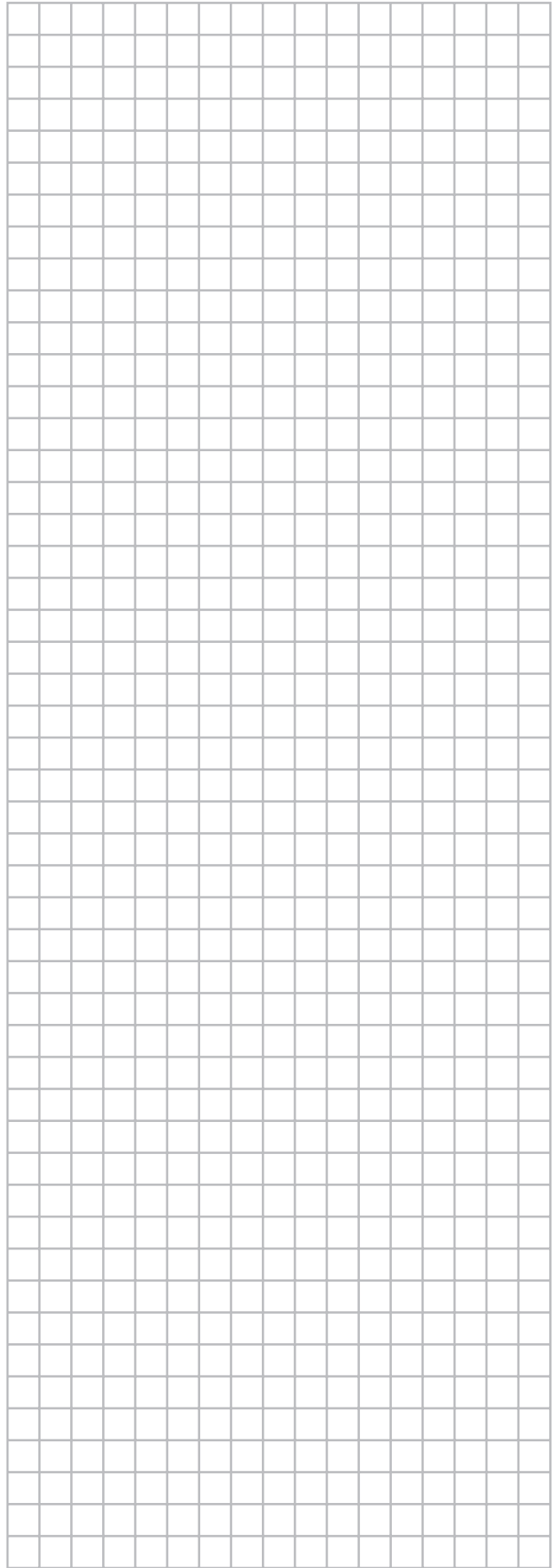
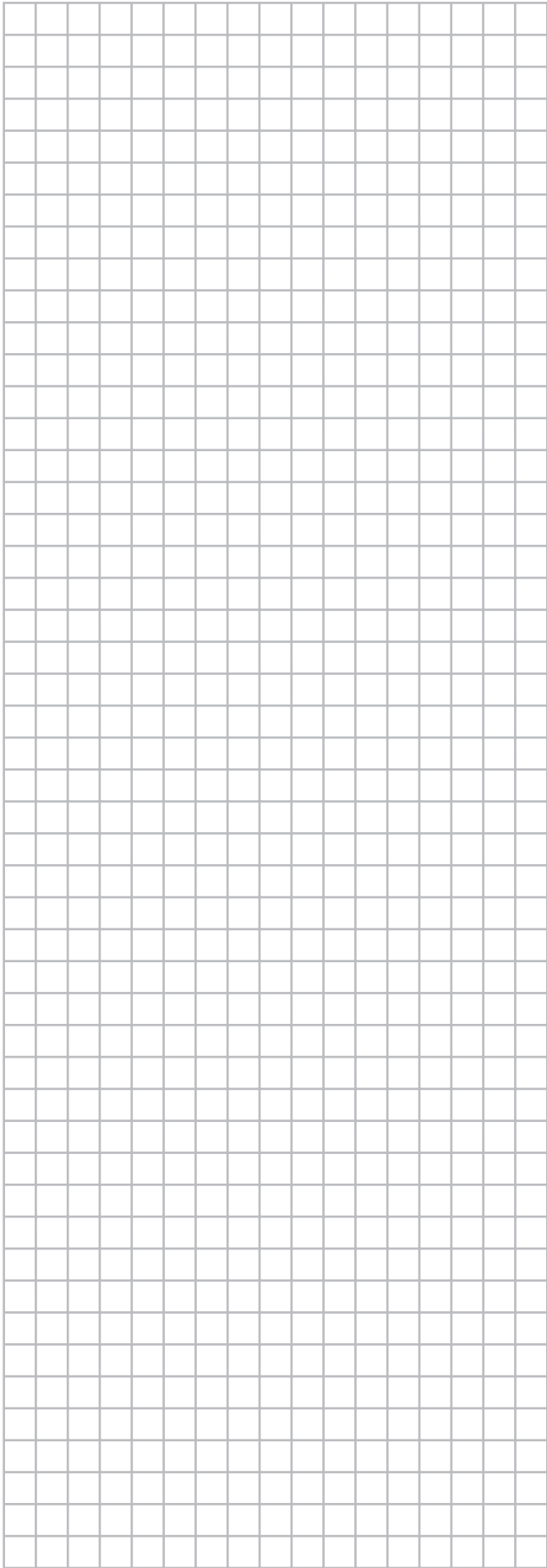

DAIKIN INDUSTRIES CZECH REPUBLIC s.r.o.

U Nové Hospody 1/1155, 301 00 Plzeň Skvrňany, Czech Republic

DAIKIN EUROPE N.V.

Zandvoordestraat 300, B-8400 Oostende, Belgium

Copyright 2012 Daikin



4P324678-1 2012.07