

DAIKIN



INSTALLATION AND OPERATION MANUAL

***VRV* System air conditioner**

FXFQ20M7V1B
FXFQ25M7V1B
FXFQ32M7V1B
FXFQ40M7V1B
FXFQ50M7V1B
FXFQ63M7V1B
FXFQ80M7V1B
FXFQ100M7V1B
FXFQ125M7V1B

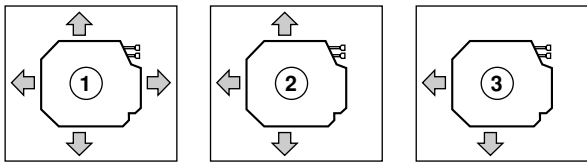

1

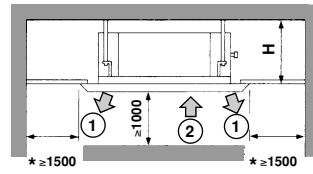

2

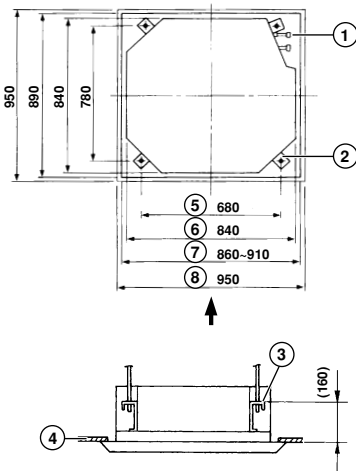
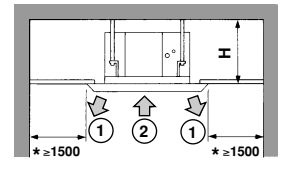

3

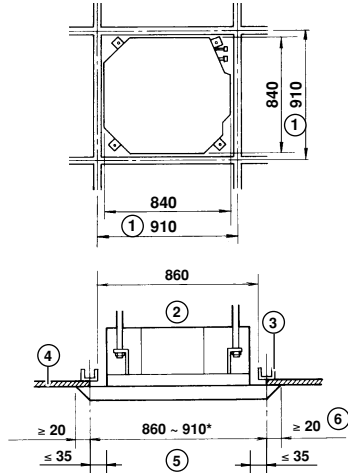

4

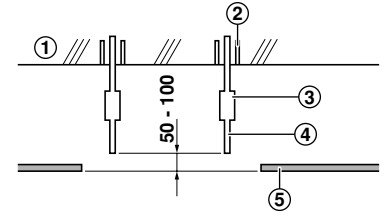

5

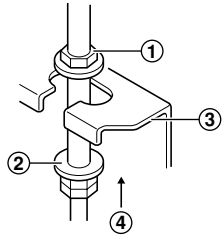

6

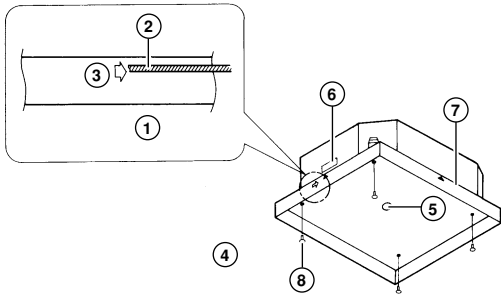

7

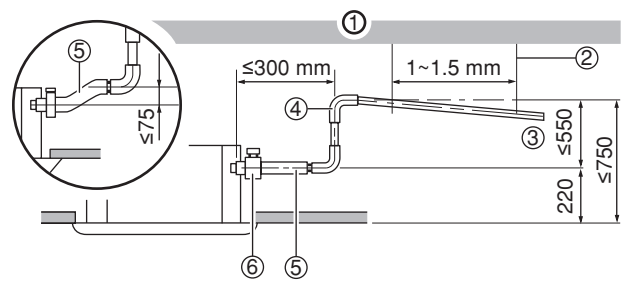

8

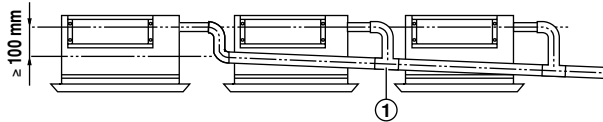

9

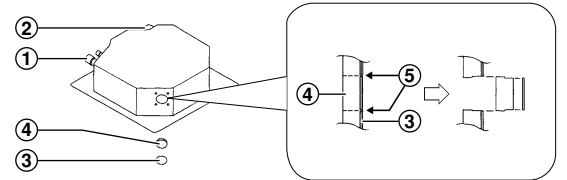

10

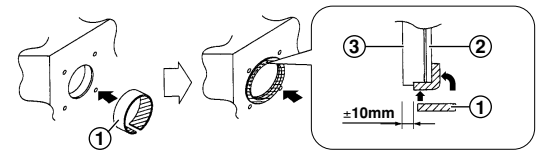

11

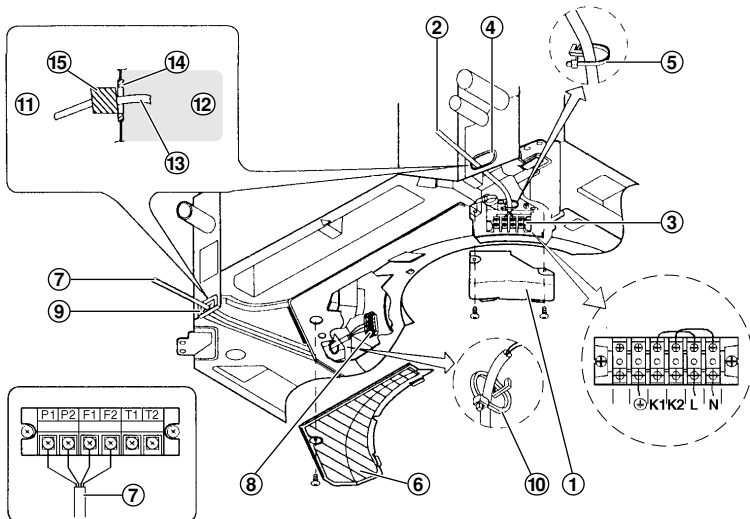

12

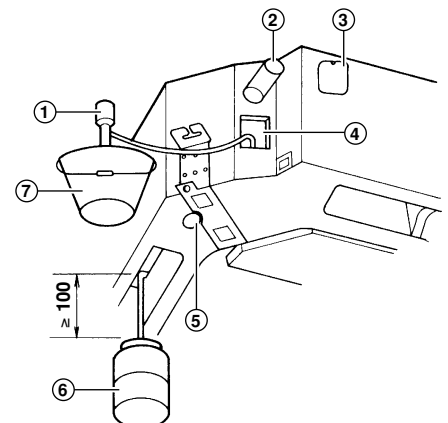

13

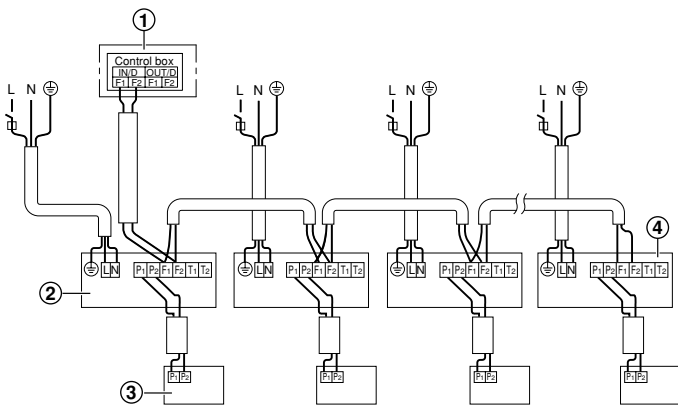

14

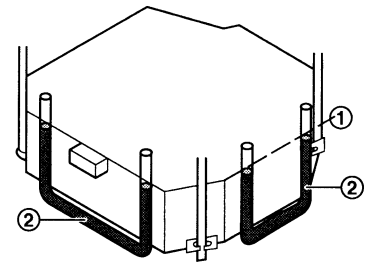

15

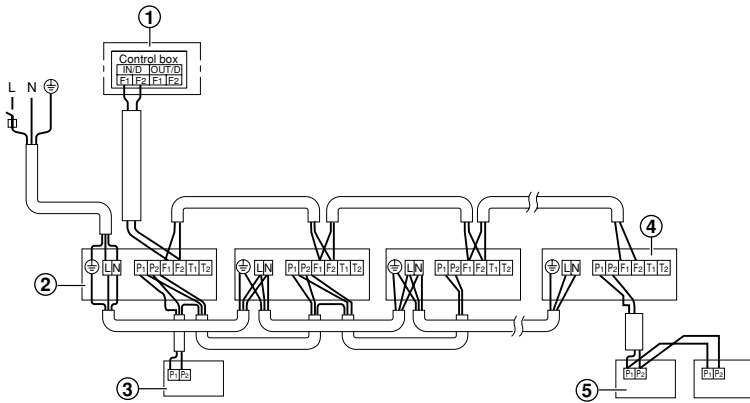

16

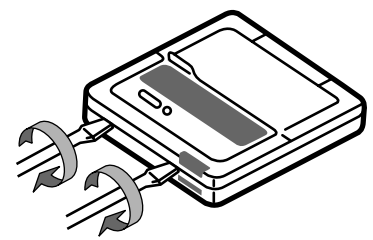

17

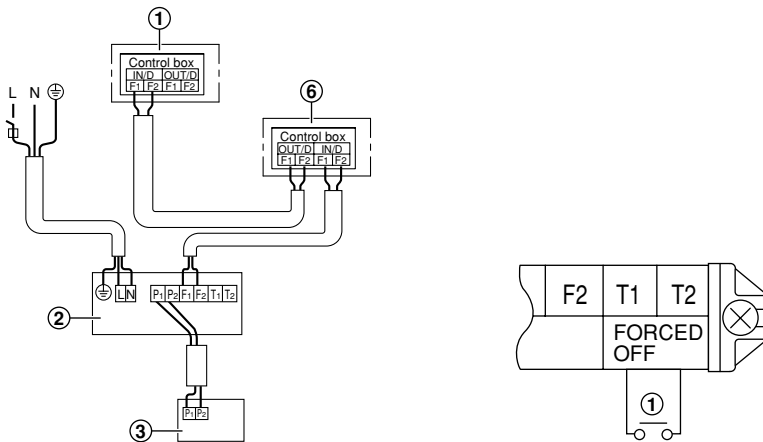

18

19

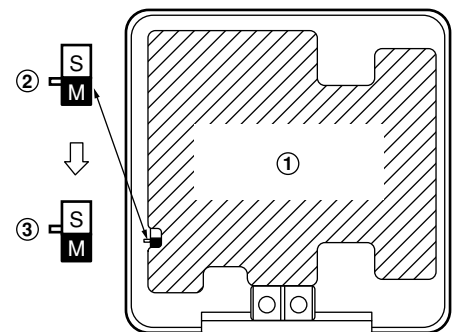

20

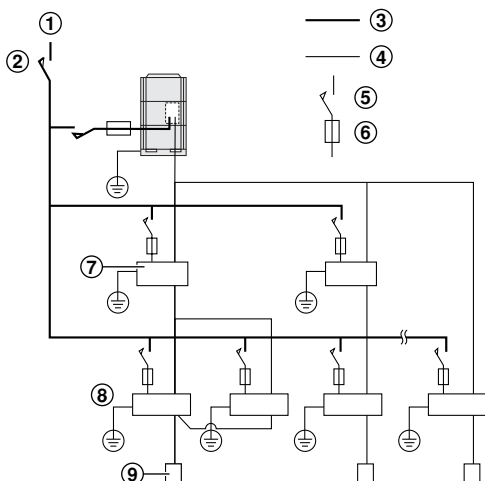

21

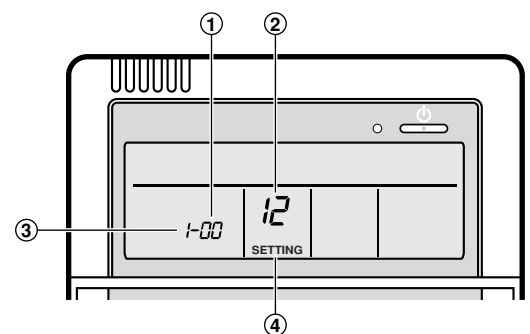

22

Daikin Europe N.V.

declares under its sole responsibility that the air conditioning models to which this declaration relates:
erklärt auf seine alleinige Verantwortung daß die Modelle der Klimageräte für die diese Erklärung bestimmt ist:
déclare sous sa seule responsabilité que les appareils d'air conditionné visés par la présente déclaration:

verklaart hierbij op eigen exclusieve verantwoordelijkheid dat de airconditioning units waarop deze verklaring betrekking heeft:
declara baja su única responsabilidad que los modelos de aire acondicionado a los cuales hace referencia la declaración:
dichiara sotto sua responsabilità che i condizionatori modello a cui è riferita questa dichiarazione:

δηλώνει με αποκλειστική της ευθύνη ότι τα μοντέλα των κλιματιστικών συσκευών στα οποία αναφέρεται η παρούσα δήλωση:
declara sob sua exclusiva responsabilidade que os modelos de ar condicionado a que esta declaração se refere:
erklærer under eneansvar, at klimateknologimodellerne, som denne deklaration vedrører:

deklarerar i egenskap av huvudansvarig, att luftkonditioneringsmodellerna som berörs av denna deklaration innebär att:
erklærer et fullstendig ansvar for at de luftkonditioneringsmodeller som berøres av denne deklarasjon innebærer at:
ilmoittaa yksinomaan omalla vastuullaan, että tämän ilmoituksen tarkoitamat ilmastointilaitteiden mallit:

FXFQ20M7V1B, FXFQ25M7V1B, FXFQ32M7V1B, FXFQ40M7V1B, FXFQ50M7V1B,
FXFQ63M7V1B, FXFQ80M7V1B, FXFQ100M7V1B, FXFQ125M7V1B,

are in conformity with the following standard(s) or other normative document(s), provided that these are used in accordance with our instructions:
der/den folgenden Norm(en) oder einem anderen Normdokument oder -dokumenten entspricht/entsprechen, unter der Voraussetzung, daß sie gemäß unseren Anweisungen eingesetzt werden:
sont conformes à la/aux norme(s) ou autre(s) document(s) normatif(s), pour autant qu'ils soient utilisés conformément à nos instructions:

conform de volgende norm(en) of één of meer andere bindende documenten zijn, op voorwaarde dat ze worden gebruikt overeenkomstig onze instructies:
están en conformidad con la(s) siguiente(s) norma(s) u otro(s) documento(s) normativo(s), siempre que sean utilizados de acuerdo con nuestras instrucciones:
sono conformi al(i) seguente(i) standard(s) o altro(i) documento(i) a carattere normativo, a patto che vengano usati in conformità alle nostre istruzioni:

είναι σύμφωνα με το(α) ακόλουθο(α) πρότυπο(α) ή άλλο έγγραφο(α) κανονισμών, υπό την προϋπόθεση ότι χρησιμοποιούνται σύμφωνα με τις οδηγίες μας:
estão em conformidade com a(s) seguinte(s) norma(s) ou outro(s) documento(s) normativo(s), desde que estes sejam utilizados de acordo com as nossas instruções:
overholder følgende standard(er) eller andet/andre retningsgivende dokument(er), forudsat at disse anvendes i henhold til vore instrukser:

respektive utrustning är utförd i överensstämmelse med och följer följande standard(er) eller andra normgivande dokument, under förutsättning att användning sker i överensstämmelse med våra instruktioner:
respektive utstyr er i overensstemmelse med følgende standard(er) eller andre normgivende dokument(er), under forutsetning av at disse brukes i henhold til våre instrukser:
vastaavat seuraavien standardien ja muiden ohjeellisten dokumenttien vaatimuksia edellyttäen, että niitä käytetään ohjeidemme mukaisesti:

EN60335-2-40,

following the provisions of:
gemäß den Vorschriften der:
conformément aux stipulations des:
overeenkomstig de bepalingen van:
siguiendo las disposiciones de:
secondo le prescrizioni per:
με τήρηση των διατάξεων των:
de acordo com o previsto em:
under iagttagelse af bestemmelserne i:
enligt villkoren i:
gitt i henhold til bestemmelsene i:
noudattaen määräyksiä:

Low Voltage 73/23/EEC
Machinery Safety 98/37/EEC
Electromagnetic Compatibility 89/336/EEC *

Directives, as amended.
Direktiven, gemäß Änderung.
Directives, telles que modifiées.
Richtlijnen, zoals geamendeerd.
Directivas, según lo enmendado.
Direttive, come da modifica.
Οδηγιών, όπως έχουν τροποποιηθεί.
Directivas, conforme alteração em.
Direktiver, med senere ændringer.
Direktiv, med företagna ändringar.
Direktiver, med foretatte endringer.
Direktivejä, sellaisina kuin ne ovat muutettuina.

* Note as set out in the Technical Construction File **DAIKIN.TCF.022** and judged positively by **TNO** according to the **Certificate 0301130401**.
Hinweis wie in der Technischen Konstruktionsakte **DAIKIN.TCF.022** aufgeführt und von **TNO** positiv ausgezeichnet gemäß **Zertifikat 0301130401**.
Remarque tel que stipulé dans le Fichier de Construction Technique **DAIKIN.TCF.022** et jugé positivement par **TNO** conformément au **Certificat 0301130401**.
Bemerk zoals vermeld in het Technisch Constructiedossier **DAIKIN.TCF.022** en in orde bevonden door **TNO** overeenkomstig **Certificaat 0301130401**.
Nota tal como se expone en el Archivo de Construcción Técnica **DAIKIN.TCF.022** y juzgado positivamente por **TNO** según el **Certificado 0301130401**.
Nota delineato nel File Tecnico di Costruzione **DAIKIN.TCF.022** e giudicato positivamente da **TNO** secondo il **Certificato 0301130401**.
Σημείωση όπως προσδιορίζεται στο Αρχείο Τεχνικής Κατασκευής **DAIKIN.TCF.022** και κρίνεται θετικά από το **TNO** σύμφωνα με το **Πιστοποιητικό 0301130401**.
Nota tal como estabelecido no Ficheiro Técnico de Construção **DAIKIN.TCF.022** e com o parecer positivo de **TNO** de acordo com o **Certificado 0301130401**.
Bemærk som anført i den Tekniske Konstruktionsfil **DAIKIN.TCF.022** og positivt vurderet af **TNO** i henhold til **Certifikat 0301130401**.
Information utrustningen är utförd i enlighet med den Tekniska Konstruktionsfilen **DAIKIN.TCF.022** som positivt intygas av **TNO** vilket också framgår av **Certifikat 0301130401**.
Merk som det fremkommer i den Tekniske Konstruktionsfilen **DAIKIN.TCF.022** og gjennom positiv bedømmelse av **TNO** ifølge **Sertifikat 0301130401**.
Huom jotta on esitetty Teknisessä Asiakirjassa **DAIKIN.TCF.022** ja jotta **TNO** on hyväksynyt **Sertifikaatin 0301130401 mukaisesti**.



DAIKIN EUROPE NV
Zandvoordestraat 300, B-8400 Oostende, Belgium

CONTENTS

	Page
Before installation	1
Selecting installation site	2
Preparations before installation	2
Installation procedures for fresh air intake duct connection.....	3
Indoor unit installation.....	3
Refrigerant piping work.....	3
Drain piping work.....	4
Electric wiring work.....	5
Wiring example and how to set the remote controller	5
Wiring example	6
Field setting	6
Installation of the decoration panel.....	7
Test operation	7
Maintenance	7
Wiring diagram	9



READ THESE INSTRUCTIONS CAREFULLY BEFORE INSTALLATION. KEEP THIS MANUAL IN A HANDY PLACE FOR FUTURE REFERENCE.

IMPROPER INSTALLATION OR ATTACHMENT OF EQUIPMENT OR ACCESSORIES COULD RESULT IN ELECTRIC SHOCK, SHORT-CIRCUIT, LEAKS, FIRE OR OTHER DAMAGE TO THE EQUIPMENT. BE SURE ONLY TO USE ACCESSORIES MADE BY DAIKIN WHICH ARE SPECIFICALLY DESIGNED FOR USE WITH THE EQUIPMENT AND HAVE THEM INSTALLED BY A PROFESSIONAL.

IF UNSURE OF INSTALLATION PROCEDURES OR USE, ALWAYS CONTACT YOUR DAIKIN DEALER FOR ADVICE AND INFORMATION.

BEFORE INSTALLATION

- Leave the unit inside its packaging until you reach the installation site. Where unpacking is unavoidable, use a sling of soft material or protective plates together with a rope when lifting, this to avoid damage or scratches to the unit.
- Refer to the installation manual of the outdoor unit for items not described in this manual.
- Caution concerning refrigerant series R-410A:
The connectable outdoor units must be designed exclusively for R-410A.









Precautions

- Do not install or operate the unit in rooms mentioned below.
 - Places with mineral oil, or filled with oil vapour or spray like in kitchens. (Plastic parts may deteriorate.)
 - Where corrosive gas like sulphurous gas exists. (Copper tubing and brazed spots may corrode.)
 - Where volatile flammable gas like thinner or gasoline is used.
 - Where machines generating electromagnetic waves exist. (Control system may malfunction.)
 - Where the air contains high levels of salt such as air near the ocean and where voltage fluctuates a lot (e.g. in factories). Also in vehicles or vessels.

- When selecting the installation site, use the supplied paper pattern for installation.
- Do not install accessories on the casing directly. Drilling holes in the casing may damage electrical wires and consequently cause fire.

Accessories

Check if the following accessories are included with your unit.

 Clamp 1 piece	Also used as packing material  Paper pattern for installation 1 piece	 Drain hose 1 piece
 Screws M5 For paper pattern for installation 4 pieces.	 Washer for hanging bracket 8 pieces	 Sealing 2 pieces
Insulation for fitting 1 each  for gas pipe		 for liquid pipe
Other: installation and operation manual		

Optional accessories

- There are two types of remote controllers: wired and wireless. Select a remote controller according to customers request and install in an appropriate place. Refer to catalogues and technical literature for selecting a suitable remote controller.
- A decoration panel is also required for this indoor unit.

For the following items, take special care during construction and check after installation is finished

Tick ✓ when checked	
<input type="checkbox"/>	Is the indoor unit fixed firmly? The unit may drop, vibrate or make noise.
<input type="checkbox"/>	Is the gas leak test finished? It may result in insufficient cooling.
<input type="checkbox"/>	Is the unit fully insulated? Condensate water may drip.
<input type="checkbox"/>	Does drainage flow smoothly? Condensate water may drip.
<input type="checkbox"/>	Does the power supply voltage correspond to that shown on the name plate? The unit may malfunction or components may burn out.
<input type="checkbox"/>	Are wiring and piping correct? The unit may malfunction or components may burn out.
<input type="checkbox"/>	Is the unit safely grounded? Dangerous at electric leakage.
<input type="checkbox"/>	Is the wiring size according to specifications? The unit may malfunction or components may burn out.
<input type="checkbox"/>	Is nothing blocking the air outlet or inlet of either the indoor or outdoor units? It may result in insufficient cooling.
<input type="checkbox"/>	Are refrigerant piping length and additional refrigerant charge noted down? The refrigerant charge in the system might not be clear.

Notes to the installer

- Read this manual carefully to ensure correct installation. Be sure to instruct the customer how to properly operate the system and show him/her the enclosed operation manual.
- Explain to the customer what system is installed on the site. Be sure to fill out the appropriate installation specifications in the chapter "What to do before operation" of the outdoor unit operation manual.

SELECTING INSTALLATION SITE

When the conditions in the ceiling are exceeding 30°C and a relative humidity of 80%, or when fresh air is inducted into the ceiling, an additional insulation is required (minimum 10 mm thickness, polyethylene foam).

For this unit you can select different air flow directions. It is necessary to purchase an optional blocking pad kit to discharge the air in 2 or 3 directions.

1 Select an installation site where the following conditions are fulfilled and that meets your customer's approval.

- Where optimum air distribution can be ensured.
- Where nothing blocks air passage.
- Where condensate water can be properly drained.
- Where the false ceiling is not noticeably on an incline.
- Where sufficient clearance for maintenance and service can be ensured.
- Where piping between indoor and outdoor units is possible within the allowable limit. (Refer to the installation manual of the outdoor unit.)
- Keep indoor unit, outdoor unit, power supply wiring and transmission wiring at least 1 meter away from televisions and radios. This is to prevent image interference and noise in those electrical appliances.
(Noise may be generated depending on the conditions under which the electric wave is generated, even if 1 meter is kept.)

2 Ceiling height

This indoor unit may be installed on ceilings up to 3.5 m in height (for 80~125 units: 4.2 m). However, it becomes necessary to make field settings by the remote controller when installing the unit at a height over 2.7 m (for 80~125 units: 3.2 m). To avoid accidental touching, it is recommended to install the unit higher than 2.5 m.

Refer to the chapter "Field setting" and to the decoration panel installation manual.

3 Air flow directions

Select the air flow directions best suited to the room and point of installation. (For air discharge in 2 or 3 directions, it is necessary to make field settings by means of the remote controller and to close the air outlet(s). Refer to the installation manual of the optional blocking pad kit and to the chapter "Field setting".) (See figure 1 (↑ = air flow direction))

- 1 Air discharge in 4 directions
- 2 Air discharge in 3 directions
- 3 Air discharge in 2 directions

4 Use suspension bolts for installation. Check whether the ceiling is strong enough to support the weight of the indoor unit. If there is a risk, reinforce the ceiling before installing the unit.

(The installation pitch is marked on the paper pattern for installation. Refer to it to check for points requiring reinforcing.) Space required for installation see figure 2 (↑ = air flow direction)

- 1 Air discharge
- 2 Air inlet

NOTE Leave 200 mm or more space where marked with *; on sides where the air outlet is closed.

Model	H
FXFQ20~63	≥240
FXFQ80~125	≥298

PREPARATIONS BEFORE INSTALLATION

1. Relation of ceiling opening to unit and suspension bolt position. (See figure 3)

- 1 Refrigerant piping
- 2 Suspension bolt (x4)
- 3 Hanger bracket
- 4 False ceiling
- 5 Suspension bolt pitch
- 6 Indoor unit
- 7 Ceiling opening
- 8 Decoration panel

■ Installation is possible when opening dimensions are as follows. When installing the unit within the frame for fixing ceiling materials. (See figure 4)

- 1 Dimensions inside frame
- 2 Opening dimension inside the frame for ceiling
- 3 Frame
- 4 Ceiling material
- 5 Ceiling opening dimension
- 6 Ceiling-panel overlapping dimension

NOTE Installation is possible with a ceiling dimension of 910 mm (marked with*). However, to achieve a ceiling-panel overlapping dimension of 20 mm, the spacing between the ceiling and the unit should be 35 mm or less. If the spacing between ceiling and the unit is over 35 mm, attach ceiling material to the part or recover the ceiling.

2. Make the ceiling opening needed for installation where applicable. (For existing ceilings.)

- Refer to the paper pattern for installation for the ceiling opening dimensions.
- Create the ceiling opening required for installation. From the side of the opening to the casing outlet, implement the refrigerant and drain piping and wiring for remote controller (unnecessary for wireless type) and indoor-outdoor unit casing outlet. Refer to each piping or wiring section.
- After making an opening in the ceiling, it may be necessary to reinforce ceiling beams to keep the ceiling level and to prevent it from vibrating. Consult the builder for details.

3. Install the suspension bolts. (use either a W3/8 or M10 size bolt.)

Use anchors for existing ceilings, and a sunken insert, sunken anchors or other field supplied parts for new ceilings to reinforce the ceiling in order to bear the weight of the unit. Adjust clearance from the ceiling before proceeding further.

Installation example see figure 5.

- 1 Ceiling slab
- 2 Anchor
- 3 Long nut or turn-buckle
- 4 Suspension bolt
- 5 False ceiling

NOTE All the above parts are field supplied.

NOTE For other installation than standard installation, contact your Daikin dealer for details.

INSTALLATION PROCEDURES FOR FRESH AIR INTAKE DUCT CONNECTION

1. Preparing the connection hole (See figure 10).

- Cut off the knockout hole on the side plate with a nipper.
- Cut the inner insulation of the hole portion with a cutter.

- 1 Piping
- 2 Drain pipe
- 3 Side plate
- 4 Inner insulation
- 5 Slit

2. Placing the insulation (See figure 11).

- Put the insulation tightly around the hole of the unit as shown. The ends of the side plate and the inner insulation must be completely adhered without leaving any clearance along the circumference of the hole.

Make sure the inner surface of insulation tightly contacts the inner insulation edge and the side plate.

- 1 Insulation (field supply)
- 2 Side plate
- 3 Inner insulation

INDOOR UNIT INSTALLATION

When installing optional accessories (except for the decoration panel), read also the installation manual of the optional accessories. Depending on the field conditions, it may be easier to install optional accessories before the indoor unit is installed. However, for existing ceilings, install fresh air inlet component kit and branch duct before installing the unit.

1. Install the indoor unit temporarily.

- Attach the hanger bracket to the suspension bolt. Be sure to fix it securely by using a nut and washer from the upper and lower sides of the hanger bracket.

Securing the hanger bracket see figure 6.

- 1 Nut (field supplied)
- 2 Washer (supplied with the unit)
- 3 Hanger bracket
- 4 Tighten (double nut)

2. Fix the paper pattern for installation. (For new ceilings only.)

- The paper pattern for installation corresponds with the measurements of the ceiling opening. Consult the builder for details.
- The centre of the ceiling opening is indicated on the paper pattern for installation. The centre of the unit is indicated on the unit casing and on the paper pattern for installation.
- After removing the packaging material from the paper pattern for installation, attach the paper pattern for installation to the unit with the attached screws as shown in figure 7.

- 1 Height adjustment of the unit
- 2 Ceiling material
- 3 Lower surface of ceiling
- 4 Installation of paper pattern for installation (supplied with the unit)
- 5 Centre of the ceiling opening
- 6 Centre of the unit
- 7 Paper pattern for installation
- 8 Screws (supplied with the unit)

- The ceiling height is shown on the side of the paper pattern for installation. Adjust the height of the unit according to this indication.

3. Adjust the unit to the right position for installation.

(Refer to the chapter "Preparations before installation".)

4. Check if the unit is horizontally levelled.

- Do not install the unit tilted. The indoor unit is equipped with a built-in drain pump and float switch. (If the unit is tilted against condensate flow, the float switch may malfunction and cause water to drip.)
- Check if the unit is levelled at all four corners with a water level or a water-filled vinyl tube as shown in figure 15.

- 1 Water level
- 2 Vinyl tube

5. Remove the paper pattern for installation. (For new ceilings only.)

REFRIGERANT PIPING WORK

For refrigerant piping of outdoor unit, refer to the installation manual supplied with the outdoor unit.

Execute heat insulation work completely on both sides of the gas piping and the liquid piping. Otherwise, this can sometimes result in water leakage.

Before rigging tubes, check which type of refrigerant is used.



All field piping must be provided by a licensed refrigeration technician and must comply with the relevant local and national codes.

- Use a pipe cutter and flare suitable for the used refrigerant.
- Apply ether oil or ester oil around the flare portions before connecting.
- To prevent dust, moisture or other foreign matter from infiltrating the tube, either pinch the end, or cover it with tape.
- Use copper alloy seamless pipes (ISO 1337).
- The outdoor unit is charged with refrigerant.
- Be sure to use both a spanner and torque wrench together when connecting or disconnecting pipes to/from the unit.

- 1 Torque wrench
- 2 Spanner
- 3 Piping union
- 4 Flare nut

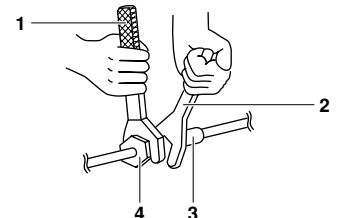

- Do not mix anything other than the specified refrigerant, such as air, etc., inside the refrigerant circuit.
- Refer to Table 1 for the dimensions of flare nut spaces and the appropriate tightening torque. (Overtightening may damage the flare and cause leaks.)

Table 1

Pipe gauge	Tightening torque	Flare dimension A (mm)	Flare shape
Ø6.4	14.2~17.2 N•m (144~176 kgf•cm)	8.7~9.1	
Ø9.5	32.7~39.9 N•m (333~407 kgf•cm)	12.8~13.2	
Ø12.7	49.5~60.3 N•m (504~616 kgf•cm)	16.2~16.6	
Ø15.9	61.8~75.4 N•m (630~770 kgf•cm)	19.3~19.7	

- When connecting the flare nut, coat the flare both inside and outside with ether oil or ester oil and initially tighten by hand 3 or 4 turns before tightening firmly.

Coat here with ether oil or ester oil

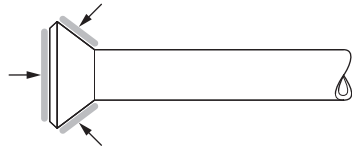

- Check the pipe connector for gas leaks, then insulate it as shown in the figure below.

- Liquid pipe
- Gas pipe
- Insulation for fitting of liquid line (supplied with the unit)
- Insulation for fitting of gas line (supplied with the unit)
- Clamps (use 2 clamps per insulation)

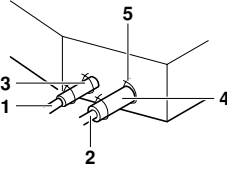

- If the refrigerant gas leaks during the work, ventilate the area. A toxic gas is emitted by the refrigerant gas being exposed to a fire.
- Finally make sure there is no refrigerant gas leak. A toxic gas may be released by the refrigerant gas leaking indoor and being exposed to flames from an area heater, cooking stove, etc.

DRAIN PIPING WORK

Rig the drain piping as shown in figure and take measures against condensation. Improperly rigged piping could lead to leaks and eventually wet furniture and belongings.

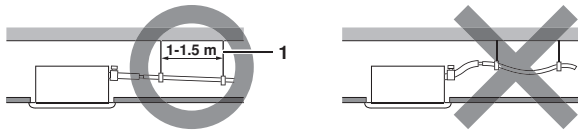

- Hanging bar

1. Install the drain pipes.

- Keep piping as short as possible and slope it downwards so that air may not remain trapped inside the pipe.
- Keep pipe size equal to or greater than that of the connecting pipe (Vinyl pipe of 25 mm nominal diameter and 32 mm outer diameter).
- Insert the supplied drain hose into the drain socket, up to the white tape.
- Tighten the clamp until the screw head is less than 4 mm from the hose.

- Clamp metal (supplied with the unit)
- Drain hose (supplied with the unit)
- White tape (field supply)

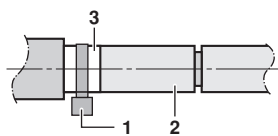

- Insulate the drain hose inside the building.
- If the drain hose cannot be sufficiently set on a slope, fit the hose with drain raising piping (field supply).

How to perform piping (See figure 8)

- Ceiling slab
- Hanger bracket
- Adjustable range
- Drain raising pipe
- Drain hose (supplied with the unit)
- Clamp metal (supplied with the unit)

- Connect the drain hose to the drain raising pipes, and insulate them.

- Connect the drain hose to the drain outlet on the indoor unit, and tighten it with the clamp.

Precautions

- Install the drain raising pipes at a height of less than 550 mm.
- Install the drain raising pipes at a right angle to the indoor unit and no more than 300 mm from the unit.

NOTE



- The incline of attached drain hose should be 75 mm or less so that the drain socket does not have to stand additional force.
- To ensure a downward slope of 1:100, install hanging bars every 1 to 1.5 m.
- If unifying multiple drain pipes, install the pipes as shown in figure 9. Select converging drain pipes whose gauge is suitable for the operating capacity of the unit.

- T-joint converging drain pipes

2. After piping work is finished, check if drainage flows smoothly.

- Open the water inlet lid, add approximately 2 l of water gradually and check the drainage flow.

Method of adding water. See figure 13.

- Portable pump
- Drain pipe
- Service cover
- Inspection opening
- Service drain outlet (with rubber plug) (Use this outlet to drain water from the drain pan)
- Plastic watering can (Tube should be about 100 mm long.) (Adding water through air discharge outlet)
- Bucket (Adding water from inspection opening)





When electric wiring work is finished

Check drainage flow during COOL running, explained in chapter "Test operation".

When electric wiring work is not finished

- Remove the switch box lid and connect the power supply and remote controller to the terminals. See figure 12.

- Switch box lid (1)
- Power supply
- Power supply terminal board
- Rubber bush A
- Clamp A
- Switch box lid (2) with wiring diagram label
- Transmission wiring
- Terminal board for transmission wiring
- Rubber bush B
- Clamp B
- Outside of the unit
- Inside of the unit
- Cable (power supply or transmission wiring)
- Opening for the cable
- Small sealing (supplied with the unit)

- Next, press the inspection/test operation button  on the remote controller. The unit will engage the test operation mode. Press the operation mode selector button  until selecting fan operation . Then, press the on/off button . The indoor unit fan and drain pump will start up. Check that the water has drained from the unit. Press  to go back to the first mode.

ELECTRIC WIRING WORK

General instructions

- All field supplied parts and materials and electric works must conform to local codes.
- Use copper wire only.
- Follow the "Wiring diagram" attached to the unit body to wire the outdoor unit, indoor units and the remote controller. For details on hooking up the remote controller, refer to the "Installation manual of the remote controller".
- All wiring must be performed by an authorized electrician.
- A circuit breaker capable of shutting down power supply to the entire system must be installed.
Note that the operation will restart automatically if the main power supply is turned off and then turned back on again.
- This system consists of multiple indoor units. Mark each indoor unit as unit A, unit B..., and be sure the terminal board wiring to the outdoor unit and BS unit are properly matched. If wiring and piping between the outdoor unit and an indoor unit are mismatched, the system may cause a malfunction.

Electrical characteristics

Model	Hz	Volts	Voltage range
FXFQ20~125	50	230	min. 198-max. 264

Model	power supply		Fan motor	
	MCA	MFA	KW	FLA
FXFQ20•25•32•40•50	0.5	16 A	0.045	0.4
FXFQ63	0.6	16 A	0.045	0.5
FXFQ80	1.0	16 A	0.090	0.8
FXFQ100	1.1	16 A	0.090	0.9
FXFQ125	1.4	16 A	0.090	1.1

MCA: Min. circuit Amps (A)
MFA: Max. Fuse Amps (A)
KW: Fan Motor Rated Output (kW)
FLA: Full Load Amps (A)

NOTE For details, refer to "Electrical data".



Specifications for field supplied fuses and wire

Model	Power supply wiring		
	Field fuses	Wire	Size
FXFQ20~125	16 A	H05VV-U3G	Local codes

Model	Transmission wiring	
	Wire	Size
FXFQ20~125	Sheathed wire (2)	0.75-1.25 mm ²

NOTE



- For details, refer to the chapter "Wiring example".
- Allowable length of transmission wiring between indoor and outdoor units, and between the indoor unit and the remote controller is as follows:
 - Outdoor unit - indoor unit: max. 1000 m (total wiring length: 2000 m)
 - Indoor unit - remote controller: max 500 m

WIRING EXAMPLE AND HOW TO SET THE REMOTE CONTROLLER

How to connect wiring (See figure 12)

- Power supply wiring**
Remove the switch box lid (1) and connect the wires to the power supply terminal board inside. While doing this, pull the wires inside through the rubber bush A and clamp the wires along with other wires using clamp A, untightening the clip of clamp A by pressing. After the connection, tighten clamp A as before.
- Unit wiring and remote controller wiring**
Remove the switch box lid (2) and pull the wires inside through the rubber bush B and connect to the terminal board for unit transmission wiring.
- After connection**
Attach the small sealing (supplied with the unit) around the cables to prevent infiltrating of water from the outside into the unit. If two or more cables are used, divide the small sealing into the required number of pieces and wrap them around all the cables.

- Switch box lid (1)
- Power supply
- Power supply terminal board
- Rubber bush A
- Clamp A
- Switch box lid (2) with wiring diagram label
- Transmission wiring
- Terminal board for transmission wiring
- Rubber bush B
- Clamp B
- Outside of the unit
- Inside of the unit
- Cable (power supply or transmission wiring)
- Opening for the cable
- Small sealing

Precautions

- Observe the notes mentioned below when wiring to the power supply terminal board.
 - Do not connect wires of different gauge to the same power supply terminal. (Looseness in the connection may cause overheating.)
 - When connecting wires of the same gauge, connect them according to the figure.

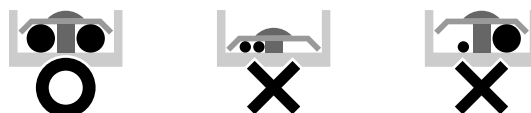

Use the specified electric wire. Connect the wire securely to the terminal. Lock the wire down without applying excessive force to the terminal. (tightening torque 1.31 N•m ±10 %)

- 2 Keep total current of crossover wiring between indoor units less than 12 A. Branch the line outside the terminal board of the unit in accordance with electrical equipment standards, when using two power wiring of a gauge greater than 2 mm² (Ø1.6).
The branch must be sheathed in order to provide an equal or greater degree of insulation as power supply wiring itself.
- 3 Do not connect wires of different gauge to the same grounding terminal. Looseness in the connection may deteriorate the protection.
- 4 Remote controller cords and wires connecting the units should be located at least 50 mm away from power supply wiring. Not following this guideline may result in malfunction due to electrical noise.
- 5 For the remote controller wiring, refer to the "Installation manual of the remote controller" supplied with the remote controller.
- 6 Never connect the power supply wiring to the terminal board for transmission wiring. This mistake could damage the entire system.
- 7 Use only specified wires and tightly connect wires to the terminals. Be careful that wires do not place external stress on the terminals. Keep wiring in neat order so that they do not obstruct other equipment such as popping open the service cover. Make sure the cover closes tight. Incomplete connections could result in overheating, and in the worse case, electric shock or fire.

WIRING EXAMPLE

- Fit the power supply wiring of each unit with a switch and fuse as shown in figure 21.

- 1 Power supply
- 2 Main switch
- 3 Power supply wiring
- 4 Transmission wiring
- 5 Switch
- 6 Fuse
- 7 BS unit REYQ only
- 8 Indoor unit
- 9 Remote controller

Complete system example (3 systems)

- See figures 14, 16 and 18.

- 1 Outdoor unit
- 2 Indoor unit
- 3 Remote controller (Optional accessories)
- 4 Most downstream indoor unit
- 5 For use with 2 remote controllers
- 6 BS unit

When using 1 remote controller for 1 indoor unit. (Normal operation.) (See figure 14).

For group control or use with 2 remote controllers (See figure 16).

When including BS unit (See figure 18).

NOTE



It is not necessary to designate indoor unit address when using group control. The address is automatically set when the power is activated.

Precautions

1. A single switch can be used to supply power to units on the same system. However, branch switches and branch circuit breakers must be selected carefully.
2. For a group control remote controller, choose the remote controller that suits the indoor unit which has the most functions.
3. Do not ground the equipment on gas pipes, water pipes, lightning rods or crossground with telephones. Improper grounding could result in electric shock.

FIELD SETTING

Field setting must be made from the remote controller in accordance with the installation condition.

- Setting can be made by changing the "Mode number", "FIRST CODE No." and "SECOND CODE No.".
- For setting and operation, refer to the "Field setting" in the installation manual of the remote controller.

Setting ceiling height

- Select the SECOND CODE No. that corresponds to the ceiling height. (SECOND CODE No. is factory set to "01" for a ceiling height of 2.7 m or less.)

Ceiling height (m)					
units 20~63	units 80~125		Mode n°	1st code n°	2nd code n°
<2.7	<3.2	N	13 (23)	0	01
>2.7 or <3.0	<3.2 or <3.6	H	13 (23)	0	02
>3.0 or <3.5	>3.6 or <4.2	S	13 (23)	0	03

The figure of ceiling height is for air discharge in 4 directions.

Setting air discharge direction

- For changing air discharge direction (2 or 3 directions), refer to the option handbook of the optional blocking pad kit. (SECOND CODE No. is factory set to "01" for air discharge in 4 directions.)

Setting when installing high performance filters

- In case of installing high performance filters, refer to the option handbook of the high performance filters.

Setting air filter sign

- Remote controllers are equipped with liquid crystal air filter signs to display the time to clean the air filter.
- Change the SECOND CODE No. Depending on the amount of dirt or dust in the room. (SECOND CODE No. is factory set to "01" for air filter contamination-light)

Air Filter contamination

Setting	Display interval	Mode n°	1st code n°	2nd code n°
Light	±2500 hrs	10 (20)	0	01
Heavy	±1250 hrs	10 (20)	0	02

- When using wireless remote controllers it is necessary to use address setting. Refer to the installation manual attached to the wireless remote controller for the setting instructions.

Control by 2 Remote Controllers (Controlling 1 indoor unit by 2 remote controllers)

- When using 2 remote controllers, one must be set to "MAIN" and the other to "SUB".

Main/sub changeover

- Insert a wedge-head screwdriver into the recess between the upper and lower part of the remote controller and, working from the 2 positions, pry off the upper part. (See figure 17)
(The remote controller PC board is attached to the upper part of the remote controller.)
- Turn the main/sub changeover switch on one of the two remote controller PC boards to "S". (See figure 20)
(Leave the switch of the other remote controller set to "M".)

- Remote controller PC board
- Factory setting
- Only one remote controller needs to be changed

Computerised control (forced off and on/off operation)

- Wire specifications and how to perform wiring.
 - Connect input from outside to terminals T1 and T2 of the terminal board (remote controller to transmission wiring).

Wire specification	Sheathed vinyl cord or cable (2 wire)
Gauge	0.75-1.25 mm ²
Length	Max. 100 m
External terminal	Contact that can ensure the minimum applicable load of 15 V DC, 10 mA

See figure 19

- Input A
 - The following table explains "forced off" and "on/off operations" in response to input A.

Forced off	on/off operation
Input "on" stops operation	input off → on: turns on the unit (impossible by remote controllers)
Input "off" enables control	input on → off: turns off the unit (by remote controller)

- How to select forced off and on/off operation
 - Turn the power on and then use the remote controller to select operation.
 - Set the remote controller to the field set mode. For details, refer to the chapter "How to set in the field", in the remote controller manual.
 - When in the field set mode, select mode No. 12, then set the first code (switch) No. to "1". Then set second code (position) No. to "01" for forced off and to "02" for on/off operation. (forced off at factory set.) (See figure 22)

- Second code No.
- Mode No.
- First code No.
- Field set mode

Centralized control

- For centralized control, it is necessary to designate the group No. For details, refer to the manual of each optional controller for centralized control.

INSTALLATION OF THE DECORATION PANEL

Refer to the installation manual attached to the decoration panel.

After installing the decoration panel, ensure that there is no space between the unit body and decoration panel. Otherwise air may leak through the gap and cause dewdrop.

TEST OPERATION

Refer to the installation manual of the outdoor unit.

- The operation lamp of the remote controller will flash when an error occurs. Check the error code on the liquid crystal display to identify the trouble. An explanation of error codes and the corresponding trouble are provided on "Caution for servicing" of the indoor unit.

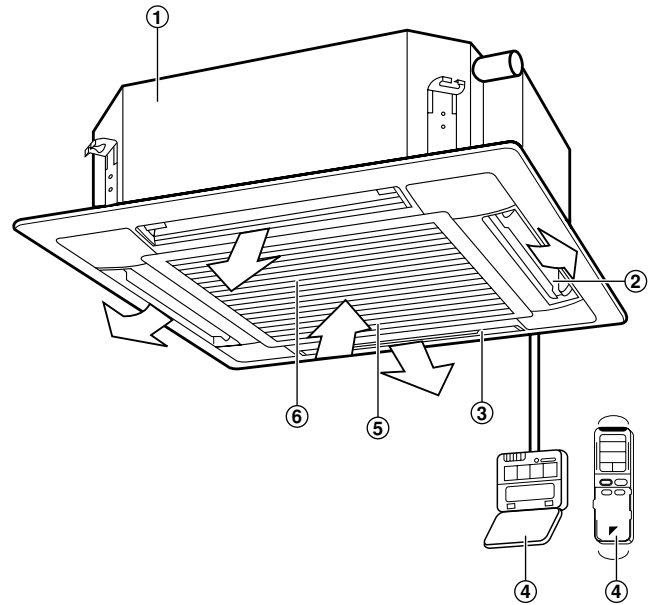

- Drain pumping device (built-in) drain water is removed from the room during cooling
- Air flow flap (at air outlet)
- Air outlet
- Remote controller
- Suction grill
- Air filter (inside suction grill)

MAINTENANCE

IMPORTANT

- ONLY A QUALIFIED SERVICE PERSON IS ALLOWED TO PERFORM MAINTENANCE.
- BEFORE OBTAINING ACCESS TO TERMINAL DEVICES, ALL POWER SUPPLY CIRCUITS MUST BE INTERRUPTED.
- DO NOT USE WATER OR AIR OF 50°C OR HIGHER FOR CLEANING AIR FILTERS AND OUTSIDE PANELS.
- WHEN CLEANING THE HEAT EXCHANGER, BE SURE TO REMOVE THE SWITCHBOX, FAN MOTOR AND DRAIN PUMP. WATER OR DETERGENT MAY DETERIORATE THE INSULATION OF ELECTRIC COMPONENTS AND RESULT IN BURN-OUT OF THESE COMPONENTS.

How to clean the air filter

Clean the air filter when the display shows "  " (TIME TO CLEAN AIR FILTER).

Increase the frequency of cleaning if the unit is installed in a room where the air is extremely contaminated.

(As a yardstick for yourself, consider cleaning the filter once a half year.)

If dirt becomes impossible to clean, change the air filter. (Air filter for exchange is optional.)

1. Open the suction grill.
Push both knobs simultaneously and carefully lower the grille. (Identical procedure for closing.)

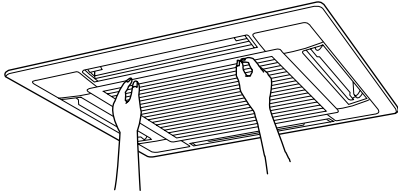

2. Remove the air filters.
Pull the air filter clips toward you, and detach the filter.

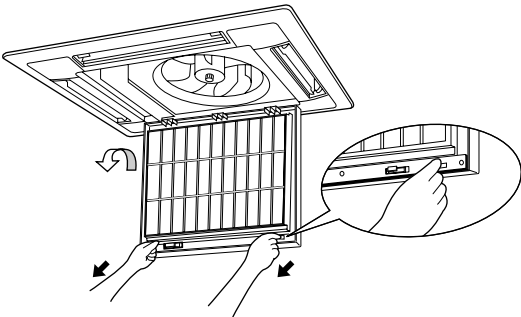

3. Clean the air filter.
Use a vacuum cleaner or wash the air filter with water. When the air filter is very dirty, use a soft brush and neutral detergent.



Remove water and dry in the shade.

4. Fix the air filter.
Attach the air filter to the suction grill by hanging it to the projected portion above the suction grill. Press the bottom of the air filter against the projections on the bottom of the grille to snap the air filter into its place.

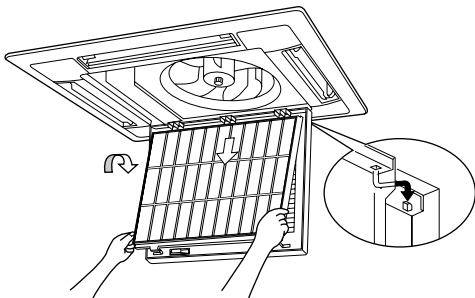

5. Shut the air inlet grill.
Refer to item No. 1.
6. After turning power on, press the FILTER SIGN RESET button.
The "TIME TO CLEAN AIR FILTER" display disappears. (For details, refer to the operation manual of the outdoor unit.)

NOTE  Do not remove the air filter except when cleaning. Unnecessary handling may damage the filter.

How to clean the air outlet and outside panels

- Clean with a soft cloth.
- When it is difficult to remove stains, use water or neutral detergent.
- When the blade is extremely contaminated, remove it as below and clean or exchange it. (Blade for exchange is optional.)

NOTE  Do not use gasoline, benzene, thinner, polishing powder nor liquid insecticide. It may cause discolouring or warping.

- Do not let the indoor unit get wet. It may cause electric shock or fire.

How to clean the suction grill

1. Open the suction grill.
Push both knobs simultaneously and carefully lower the grille. (Identical procedure for closing.)

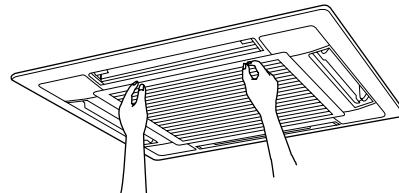

2. Detach the suction grill
Open the suction grill 45 degrees and lift it upward.

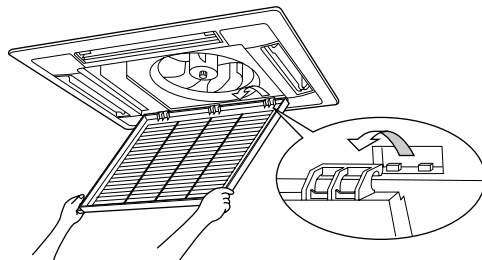

3. Clean the suction grill
Wash it with a soft brush and neutral detergent, and dry thoroughly.







NOTE  When the suction grill is very dirty, use a typical kitchen cleaner and let it sit for about 10 minutes. Then, wash it with water.

4. Reattach the suction grill
See item n° 2.
5. Close the suction grill
See item n° 1.

Disposal requirements

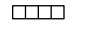
Dismantling of the unit, treatment of the refrigerant, oil and eventual other parts, should be done in accordance with the relevant local and national regulations.

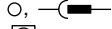
WIRING DIAGRAM

	: FIELD WIRING	BLK	: BLACK
	: TERMINAL	BLU	: BLUE
	: CONNECTOR	ORG	: ORANGE
	: WIRE CLAMP	PNK	: PINK
	: PROTECTIVE EARTH (SCREW)	RED	: RED
		WHT	: WHITE
		YLW	: YELLOW

- 33H..... FLOAT SWITCH
- A1P..... PRINTED CIRCUIT BOARD
- C1R..... CAPACITOR (FAN MOTOR)
- C3..... CAPACITOR
- F1U..... FUSE (250 V/5 A)
- HAP..... LIGHT EMITTING DIODE (SERVICE MONITOR - GREEN)
- M1F..... MOTOR (INDOOR FAN)
- M1P..... MOTOR (DRAIN PUMP)
- M1S..... MOTOR (SWING FLAP)
- Q1F..... THERMO SWITCH (M1F EMBEDDED)
- R1T..... THERMISTOR (AIR)
- R2T,R3T..... THERMISTOR (COIL)
- RyP..... MAGNETIC RELAY (DRAIN PUMP)
- X1M,X2M..... TERMINAL STRIP
- PC..... PHASE CONTROL CIRCUIT
- T1R..... TRANSFORMER (230 V/22 V)
- Y1E..... ELECTRONIC EXPANSION CIRCUIT

WIRED REMOTE CONTROLLER

- R1T..... THERMISTOR (AIR)
- SS1..... SELECTOR SWITCH (MAIN/SUB)

RECEIVER/DISPLAY UNIT (ATTACHED TO WIRELESS REMOTE CONTROLLER)

- A2P,A3P..... PRINTED CIRCUIT BOARD
- BS..... ON/OFF BUTTON
- H1P..... LIGHT EMITTING DIODE (SERVICE MONITOR - RED)
- H2P..... LIGHT EMITTING DIODE (SERVICE MONITOR - GREEN)
- H3P..... LIGHT EMITTING DIODE (SERVICE MONITOR - RED)
- H4P..... LIGHT EMITTING DIODE (SERVICE MONITOR - ORANGE)
- SS1..... SELECTOR SWITCH (MAIN/SUB)
- SS2..... SELECTOR SWITCH (WIRELESS ADDRESS SET)

CONNECTOR FOR OPTIONAL PARTS

- X18A..... CONNECTOR (ADAPTOR FOR ELECTRICAL APPENDICES)
- X23A..... CONNECTOR (WIRELESS REMOTE CONTROLLER)

RECEIVER/DISPLAY UNIT	:
WIRED REMOTE CONTROLLER	:
SWITCH BOX	:
TRANSMISSION WIRING	:
INPUT FROM OUTSIDE	:
CENTRAL REMOTE CONTROLLER	:

NOTE



1. WHEN USING THE CENTRAL REMOTE CONTROLLER, SEE MANUAL FOR CONNECTION TO THE UNIT.
2. X23A IS CONNECTED WHEN THE CENTRAL REMOTE CONTROLLER IS USED.
3. WHEN CONNECTING THE INPUT WIRES FROM OUTSIDE, FORCED OFF OR ON/OFF CONTROL OPERATION CAN BE SELECTED BY THE REMOTE CONTROLLER. SEE INSTALLATION MANUAL FOR MORE DETAILS.

