

DAIKIN

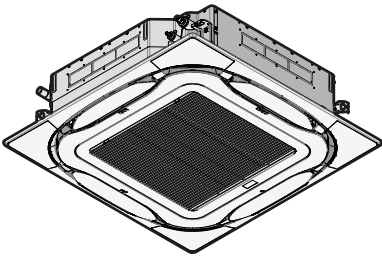

Installer and user reference guide

VRV system air conditioner



**FXFQ20BVEB
FXFQ25BVEB
FXFQ32BVEB
FXFQ40BVEB
FXFQ50BVEB
FXFQ63BVEB
FXFQ80BVEB
FXFQ100BVEB
FXFQ125BVEB**

Installer and user reference guide
VRV system air conditioner

English

Table of contents

Table of contents

1	General safety precautions	3	8.2	Precautions when commissioning	19
1.1	About the documentation	3	8.3	Checklist before commissioning	19
1.1.1	Meaning of warnings and symbols	3	8.4	To perform a test run	19
1.2	For the user	3	8.5	Error codes when performing a test run	20
1.3	For the installer	3	9	Hand-over to the user	20
1.3.1	General	3	10	Disposal	20
1.3.2	Installation site	4	11	Technical data	20
1.3.3	Refrigerant	5	11.1	Piping diagram: Indoor unit	21
1.3.4	Brine	6	11.2	Wiring diagram	21
1.3.5	Water	6	11.2.1	Unified wiring diagram legend	21
1.3.6	Electrical	6			
2	About the documentation	7			
2.1	About this document	7			
	For the installer	8			
3	About the box	8			
3.1	Overview: About the box	8			
3.2	Indoor unit	8			
3.2.1	To unpack and handle the unit	8			
3.2.2	To remove the accessories from the indoor unit	8			
4	About the units and options	8			
4.1	Overview: About the units and options	8			
4.2	Identification	8			
4.2.1	Identification label: Indoor unit	9			
4.3	System layout	9			
4.4	Combining units and options	9			
4.4.1	Possible options for the indoor unit	9			
5	Preparation	9			
5.1	Overview: Preparation	9			
5.2	Preparing the installation site	9			
5.2.1	Installation site requirements of the indoor unit	9			
5.3	Preparing refrigerant piping	10			
5.3.1	Refrigerant piping requirements	10			
5.3.2	Refrigerant piping insulation	11			
5.4	Preparing electrical wiring	11			
5.4.1	About preparing electrical wiring	11			
6	Installation	11			
6.1	Overview: Installation	11			
6.2	Mounting the indoor unit	11			
6.2.1	Precautions when mounting the indoor unit	11			
6.2.2	Guidelines when installing the indoor unit	11			
6.2.3	Guidelines when installing the drain piping	12			
6.3	Connecting the refrigerant piping	14			
6.3.1	About connecting the refrigerant piping	14			
6.3.2	Precautions when connecting the refrigerant piping	14			
6.3.3	Guidelines when connecting the refrigerant piping	14			
6.3.4	Pipe bending guidelines	15			
6.3.5	To flare the pipe end	15			
6.3.6	To connect the refrigerant piping to the indoor unit	15			
6.4	Connecting the electrical wiring	15			
6.4.1	About connecting the electrical wiring	15			
6.4.2	Precautions when connecting the electrical wiring	16			
6.4.3	Guidelines when connecting the electrical wiring	16			
6.4.4	Specifications of standard wiring components	16			
6.4.5	To connect the electrical wiring on the indoor unit	16			
7	Configuration	17			
7.1	Field settings	17			
8	Commissioning	18			
8.1	Overview: Commissioning	18			
	For the user	22			
12	About the system	22			
12.1	System layout	22			
12.2	Information requirements for fan coil units	22			
13	User interface	22			
14	Before operation	22			
15	Operation	23			
15.1	Operating the system	23			
15.1.1	About operating the system	23			
15.1.2	About cooling, heating, fan only, and automatic operation	23			
15.1.3	About the heating operation	23			
15.1.4	To operate the system	23			
15.2	Using the dry program	23			
15.2.1	About the dry program	23			
15.2.2	To use the dry program	23			
15.3	Adjusting the air flow direction	24			
15.3.1	About the air flow flap	24			
15.4	Active circulation airflow	24			
15.4.1	To start the active circulation airflow	24			
16	Energy saving and optimum operation	24			
17	Maintenance and service	25			
17.1	Precautions for maintenance and service	25			
17.2	Cleaning the air filter, suction grille, air outlet and outside panels	25			
17.2.1	To clean the air filter	25			
17.2.2	To clean the suction grille	26			
17.2.3	To clean the air outlet and outside panels	26			
17.3	Maintenance after a long stop period	26			
17.4	Maintenance before a long stop period	26			
17.5	About the refrigerant	26			
17.6	After-sales service and warranty	27			
17.6.1	Warranty period	27			
17.6.2	Recommended maintenance and inspection	27			
17.6.3	Recommended maintenance and inspection cycles	27			
17.6.4	Shortened maintenance and replacement cycles	27			
18	Troubleshooting	27			
18.1	Symptoms that are NOT system malfunctions	28			
18.1.1	Symptom: The system does not operate	28			
18.1.2	Symptom: The fan speed does not correspond to the setting	28			
18.1.3	Symptom: The fan direction does not correspond to the setting	28			
18.1.4	Symptom: White mist comes out of a unit (Indoor unit)	28			
18.1.5	Symptom: White mist comes out of a unit (Indoor unit, outdoor unit)	28			
18.1.6	Symptom: The user interface display reads "U4" or "U5" and stops, but then restarts after a few minutes	28			
18.1.7	Symptom: Noise of air conditioners (Indoor unit)	28			

18.1.8	Symptom: Noise of air conditioners (Indoor unit, outdoor unit).....	29
18.1.9	Symptom: Noise of air conditioners (Outdoor unit)	29
18.1.10	Symptom: Dust comes out of the unit	29
18.1.11	Symptom: The units can give off odours.....	29
18.1.12	Symptom: The outdoor unit fan does not spin	29
18.1.13	Symptom: The display shows "88".....	29
18.1.14	Symptom: The compressor in the outdoor unit does not stop after a short heating operation	29

19	Relocation	29
20	Disposal	29
21	Glossary	29

1 General safety precautions

1.1 About the documentation

- The original documentation is written in English. All other languages are translations.
- The precautions described in this document cover very important topics, follow them carefully.
- The installation of the system, and all activities described in the installation manual and the installer reference guide **MUST** be performed by an authorised installer.

1.1.1 Meaning of warnings and symbols

 **DANGER**
Indicates a situation that results in death or serious injury.

 **DANGER: RISK OF ELECTROCUTION**
Indicates a situation that could result in electrocution.

 **DANGER: RISK OF BURNING**
Indicates a situation that could result in burning because of extreme hot or cold temperatures.

 **DANGER: RISK OF EXPLOSION**
Indicates a situation that could result in explosion.



 **WARNING**
Indicates a situation that could result in death or serious injury.

 **WARNING: FLAMMABLE MATERIAL**

 **CAUTION**
Indicates a situation that could result in minor or moderate injury.

 **NOTICE**
Indicates a situation that could result in equipment or property damage.

 **INFORMATION**
Indicates useful tips or additional information.

Symbol	Explanation
	Before installation, read the installation and operation manual, and the wiring instruction sheet.
	Before performing maintenance and service tasks, read the service manual.

Symbol	Explanation
	For more information, see the installer and user reference guide.

1.2 For the user

- If you are NOT sure how to operate the unit, contact your installer.
- This appliance can be used by children aged from 8 years and above and persons with reduced physical, sensory or mental capabilities or lack of experience and knowledge if they have been given supervision or instruction concerning use of the appliance in a safe way and understand the hazards involved. Children shall NOT play with the appliance. Cleaning and user maintenance shall NOT be made by children without supervision.

 **WARNING**
To prevent electric shocks or fire:

- Do NOT rinse the unit.
- Do NOT operate the unit with wet hands.
- Do NOT place any objects containing water on the unit.

 **NOTICE**

- Do NOT place any objects or equipment on top of the unit.
- Do NOT sit, climb or stand on the unit.

- Units are marked with the following symbol:



This means that electrical and electronic products may NOT be mixed with unsorted household waste. Do NOT try to dismantle the system yourself: the dismantling of the system, treatment of the refrigerant, of oil and of other parts must be done by an authorized installer and must comply with applicable legislation.

Units must be treated at a specialized treatment facility for reuse, recycling and recovery. By ensuring this product is disposed of correctly, you will help to prevent potential negative consequences for the environment and human health. For more information, contact your installer or local authority.

- Batteries are marked with the following symbol:



This means that the batteries may NOT be mixed with unsorted household waste. If a chemical symbol is printed beneath the symbol, this chemical symbol means that the battery contains a heavy metal above a certain concentration.

Possible chemical symbols are: Pb: lead (>0.004%).

Waste batteries must be treated at a specialized treatment facility for reuse. By ensuring waste batteries are disposed of correctly, you will help to prevent potential negative consequences for the environment and human health.

1.3 For the installer

1.3.1 General

If you are NOT sure how to install or operate the unit, contact your dealer.

1 General safety precautions

NOTICE

Improper installation or attachment of equipment or accessories could result in electric shock, short-circuit, leaks, fire or other damage to the equipment. Only use accessories, optional equipment and spare parts made or approved by Daikin.

WARNING

Make sure installation, testing and applied materials comply with applicable legislation (on top of the instructions described in the Daikin documentation).

CAUTION

Wear adequate personal protective equipment (protective gloves, safety glasses,...) when installing, maintaining or servicing the system.

WARNING

Tear apart and throw away plastic packaging bags so that nobody, especially children, can play with them. Possible risk: suffocation.

DANGER: RISK OF BURNING

- Do NOT touch the refrigerant piping, water piping or internal parts during and immediately after operation. It could be too hot or too cold. Give it time to return to normal temperature. If you must touch it, wear protective gloves.
- Do NOT touch any accidental leaking refrigerant.

WARNING

Provide adequate measures to prevent that the unit can be used as a shelter by small animals. Small animals that make contact with electrical parts can cause malfunctions, smoke or fire.

CAUTION

Do NOT touch the air inlet or aluminium fins of the unit.

NOTICE

- Do NOT place any objects or equipment on top of the unit.
- Do NOT sit, climb or stand on the unit.

NOTICE

Works executed on the outdoor unit are best done under dry weather conditions to avoid water ingress.

In accordance with the applicable legislation, it might be necessary to provide a logbook with the product containing at least: information on maintenance, repair work, results of tests, stand-by periods,...

Also, at least, following information MUST be provided at an accessible place at the product:

- Instructions for shutting down the system in case of an emergency
- Name and address of fire department, police and hospital
- Name, address and day and night telephone numbers for obtaining service

In Europe, EN378 provides the necessary guidance for this logbook.

1.3.2 Installation site

- Provide sufficient space around the unit for servicing and air circulation.
- Make sure the installation site withstands the weight and vibration of the unit.

- Make sure the area is well ventilated. Do NOT block any ventilation openings.
- Make sure the unit is level.

Do NOT install the unit in the following places:

- In potentially explosive atmospheres.
- In places where there is machinery that emits electromagnetic waves. Electromagnetic waves may disturb the control system, and cause malfunction of the equipment.
- In places where there is a risk of fire due to the leakage of flammable gases (example: thinner or gasoline), carbon fibre, ignitable dust.
- In places where corrosive gas (example: sulphurous acid gas) is produced. Corrosion of copper pipes or soldered parts may cause the refrigerant to leak.

Instructions for equipment using R32 refrigerant

If applicable.

WARNING

- Do NOT pierce or burn.
- Do NOT use means to accelerate the defrosting process or to clean the equipment, other than those recommended by the manufacturer.
- Be aware that R32 refrigerant does NOT contain an odour.

WARNING

The appliance shall be stored so as to prevent mechanical damage and in a well-ventilated room without continuously operating ignition sources (example: open flames, an operating gas appliance or an operating electric heater) and have a room size as specified below.

NOTICE

- Do NOT re-use joints which have been used already.
- Joints made in installation between parts of refrigerant system shall be accessible for maintenance purposes.

WARNING

Make sure installation, servicing, maintenance and repair comply with instructions from Daikin and with applicable legislation (for example national gas regulation) and are executed only by authorised persons.

Installation space requirements

NOTICE

- Pipework shall be protected from physical damage.
- Installation of pipework shall be kept to a minimum.

WARNING

If appliances contain R32 refrigerant, the floor area of the room in which the appliances are installed, operated and stored MUST be larger than the minimum floor area defined in table below A (m²). This applies to:

- Indoor units **without** a refrigerant leakage sensor; in case of indoor units **with** refrigerant leakage sensor, consult the installation manual
- Outdoor units installed or stored indoors (e.g. winter garden, garage, machinery room)
- Pipework in unventilated spaces

To determine the minimum floor area

- Determine the total refrigerant charge in the system (= factory refrigerant charge ① + ② additional refrigerant amount charged).

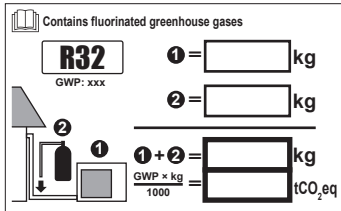

- Determine which graph or table to use.
 - For indoor units: Is the unit ceiling-mounted, wall-mounted or floor-standing?
 - For outdoor units installed or stored indoors, and field piping in unventilated spaces, this depends on the installation height:

If the installation height is...	Then use the graph or table for...
<1.8 m	Floor-standing units
1.8 ≤ x < 2.2 m	Wall-mounted units
≥ 2.2 m	Ceiling-mounted units

- Use the graph or table to determine the minimum floor area.

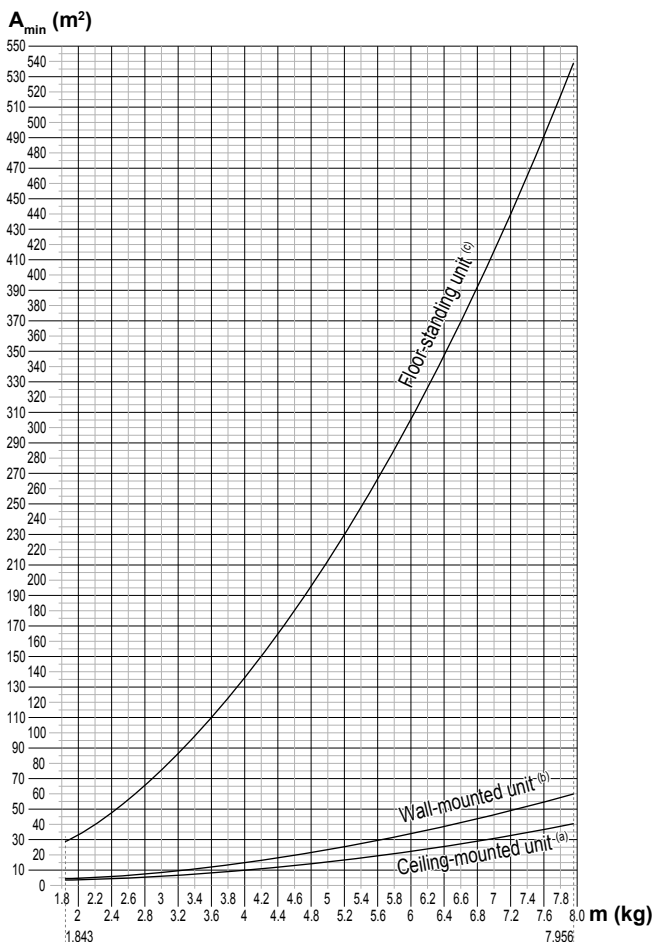

Ceiling-mounted unit ^(a)		Wall-mounted unit ^(b)		Floor-standing unit ^(c)	
m (kg)	A _{min} (m ²)	m (kg)	A _{min} (m ²)	m (kg)	A _{min} (m ²)
≤1.842	—	≤1.842	—	≤1.842	—
1.843	3.64	1.843	4.45	1.843	28.9
2.0	3.95	2.0	4.83	2.0	34.0
2.2	4.34	2.2	5.31	2.2	41.2
2.4	4.74	2.4	5.79	2.4	49.0
2.6	5.13	2.6	6.39	2.6	57.5
2.8	5.53	2.8	7.41	2.8	66.7
3.0	5.92	3.0	8.51	3.0	76.6
3.2	6.48	3.2	9.68	3.2	87.2
3.4	7.32	3.4	10.9	3.4	98.4
3.6	8.20	3.6	12.3	3.6	110
3.8	9.14	3.8	13.7	3.8	123
4.0	10.1	4.0	15.1	4.0	136
4.2	11.2	4.2	16.7	4.2	150
4.4	12.3	4.4	18.3	4.4	165
4.6	13.4	4.6	20.0	4.6	180
4.8	14.6	4.8	21.8	4.8	196
5.0	15.8	5.0	23.6	5.0	213
5.2	17.1	5.2	25.6	5.2	230
5.4	18.5	5.4	27.6	5.4	248
5.6	19.9	5.6	29.7	5.6	267
5.8	21.3	5.8	31.8	5.8	286
6.0	22.8	6.0	34.0	6.0	306
6.2	24.3	6.2	36.4	6.2	327
6.4	25.9	6.4	38.7	6.4	349
6.6	27.6	6.6	41.2	6.6	371
6.8	29.3	6.8	43.7	6.8	394
7.0	31.0	7.0	46.3	7.0	417
7.2	32.8	7.2	49.0	7.2	441
7.4	34.7	7.4	51.8	7.4	466
7.6	36.6	7.6	54.6	7.6	492
7.8	38.5	7.8	57.5	7.8	518
7.956	40.1	7.956	59.9	7.956	539

- m Total refrigerant charge in the system
- A_{min} Minimum floor area
- (a) Ceiling-mounted unit (= Ceiling-mounted unit)
- (b) Wall-mounted unit (= Wall-mounted unit)
- (c) Floor-standing unit (= Floor-standing unit)

1.3.3 Refrigerant

If applicable. See the installation manual or installer reference guide of your application for more information.



NOTICE

Make sure refrigerant piping installation complies with applicable legislation. In Europe, EN378 is the applicable standard.



NOTICE

Make sure the field piping and connections are NOT subjected to stress.



WARNING

During tests, NEVER pressurize the product with a pressure higher than the maximum allowable pressure (as indicated on the nameplate of the unit).



WARNING

Take sufficient precautions in case of refrigerant leakage. If refrigerant gas leaks, ventilate the area immediately. Possible risks:

- Excessive refrigerant concentrations in a closed room can lead to oxygen deficiency.
- Toxic gas may be produced if refrigerant gas comes into contact with fire.

1 General safety precautions



DANGER: RISK OF EXPLOSION

Pump down – Refrigerant leakage. If you want to pump down the system, and there is a leak in the refrigerant circuit:

- Do NOT use the unit's automatic pump down function, with which you can collect all refrigerant from the system into the outdoor unit. **Possible consequence:** Self-combustion and explosion of the compressor because of air going into the operating compressor.
- Use a separate recovery system so that the unit's compressor does NOT have to operate.



WARNING

ALWAYS recover the refrigerant. Do NOT release them directly into the environment. Use a vacuum pump to evacuate the installation.



NOTICE

After all the piping has been connected, make sure there is no gas leak. Use nitrogen to perform a gas leak detection.



NOTICE



- To avoid compressor breakdown, do NOT charge more than the specified amount of refrigerant.
- When the refrigerant system is to be opened, refrigerant MUST be treated according to the applicable legislation.



WARNING

Make sure there is no oxygen in the system. Refrigerant may only be charged after performing the leak test and the vacuum drying.

- In case re-charge is required, refer to the nameplate of the unit. It states the type of refrigerant and necessary amount.
- The unit is factory charged with refrigerant and depending on pipe sizes and pipe lengths some systems require additional charging of refrigerant.
- Only use tools exclusively for the refrigerant type used in the system, this to ensure pressure resistance and prevent foreign materials from entering into the system.
- Charge the liquid refrigerant as follows:

If	Then
A siphon tube is present (i.e., the cylinder is marked with "Liquid filling siphon attached")	Charge with the cylinder upright. 
A siphon tube is NOT present	Charge with the cylinder upside down. 

- Open refrigerant cylinders slowly.
- Charge the refrigerant in liquid form. Adding it in gas form may prevent normal operation.



CAUTION

When the refrigerant charging procedure is done or when pausing, close the valve of the refrigerant tank immediately. If the valve is NOT closed immediately, remaining pressure might charge additional refrigerant. **Possible consequence:** Incorrect refrigerant amount.

1.3.4 Brine

If applicable. See the installation manual or installer reference guide of your application for more information.



WARNING

The selection of the brine MUST be in accordance with the applicable legislation.



WARNING

Take sufficient precautions in case of brine leakage. If brine leaks, ventilate the area immediately and contact your local dealer.



WARNING

The ambient temperature inside the unit can get much higher than that of the room, e.g. 70°C. In case of a brine leak, hot parts inside the unit can create a hazardous situation.



WARNING

The use and installation of the application MUST comply with the safety and environmental precautions specified in the applicable legislation.

1.3.5 Water

If applicable. See the installation manual or installer reference guide of your application for more information.



NOTICE

Make sure water quality complies with EU directive 98/83 EC.

1.3.6 Electrical



DANGER: RISK OF ELECTROCUTION

- Turn OFF all power supply before removing the switch box cover, connecting electrical wiring or touching electrical parts.
- Disconnect the power supply for more than 1 minute, and measure the voltage at the terminals of main circuit capacitors or electrical components before servicing. The voltage MUST be less than 50 V DC before you can touch electrical components. For the location of the terminals, see the wiring diagram.
- Do NOT touch electrical components with wet hands.
- Do NOT leave the unit unattended when the service cover is removed.



WARNING

If NOT factory installed, a main switch or other means for disconnection, having a contact separation in all poles providing full disconnection under overvoltage category III condition, MUST be installed in the fixed wiring.



WARNING

- ONLY use copper wires.
- Make sure the field wiring complies with the applicable legislation.
- All field wiring MUST be performed in accordance with the wiring diagram supplied with the product.
- NEVER squeeze bundled cables and make sure they do NOT come in contact with the piping and sharp edges. Make sure no external pressure is applied to the terminal connections.
- Make sure to install earth wiring. Do NOT earth the unit to a utility pipe, surge absorber, or telephone earth. Incomplete earth may cause electrical shock.
- Make sure to use a dedicated power circuit. NEVER use a power supply shared by another appliance.
- Make sure to install the required fuses or circuit breakers.
- Make sure to install an earth leakage protector. Failure to do so may cause electric shock or fire.
- When installing the earth leakage protector, make sure it is compatible with the inverter (resistant to high frequency electric noise) to avoid unnecessary opening of the earth leakage protector.



CAUTION

When connecting the power supply, the earth connection must be made before the current-carrying connections are established. When disconnecting the power supply, the current-carrying connections must be separated before the earth connection is. The length of the conductors between the power supply stress relief and the terminal block itself must be as such that the current-carrying wires are tightened before the earth wire is in case the power supply is pulled loose from the stress relief.



NOTICE

Precautions when laying power wiring:



- Do NOT connect wiring of different thicknesses to the power terminal block (slack in the power wiring may cause abnormal heat).
- When connecting wiring which is the same thickness, do as shown in the figure above.
- For wiring, use the designated power wire and connect firmly, then secure to prevent outside pressure being exerted on the terminal board.
- Use an appropriate screwdriver for tightening the terminal screws. A screwdriver with a small head will damage the head and make proper tightening impossible.
- Over-tightening the terminal screws may break them.



WARNING

- After finishing the electrical work, confirm that each electrical component and terminal inside the electrical components box is connected securely.
- Make sure all covers are closed before starting up the unit.



NOTICE

Only applicable if the power supply is three-phase, and the compressor has an ON/OFF starting method.

If there exists the possibility of reversed phase after a momentary black out and the power goes on and off while the product is operating, attach a reversed phase protection circuit locally. Running the product in reversed phase can break the compressor and other parts.

2 About the documentation

2.1 About this document

Target audience

Authorised installers + end users



INFORMATION

This appliance is intended to be used by expert or trained users in shops, in light industry and on farms, or for commercial use by lay persons.

Documentation set

This document is part of a documentation set. The complete set consists of:

- **General safety precautions:**
 - Safety instructions that you must read before installing
 - Format: Paper (in the box of the indoor unit)
- **Indoor unit installation and operation manual:**
 - Installation and operation instructions
 - Format: Paper (in the box of the indoor unit)
- **Installer and user reference guide:**
 - Preparation of the installation, good practices, reference data,...
 - Detailed step-by-step instructions and background information for basic and advanced usage
 - Format: Digital files on <http://www.daikineurope.com/support-and-manuals/product-information/>

Latest revisions of the supplied documentation may be available on the regional Daikin website or via your dealer.

The original documentation is written in English. All other languages are translations.

Technical engineering data

- A **subset** of the latest technical data is available on the regional Daikin website (publicly accessible).
- The **full set** of latest technical data is available on the Daikin extranet (authentication required).

3 About the box

For the installer

3 About the box

3.1 Overview: About the box

This chapter describes what you have to do after the box with the indoor unit is delivered on-site.

It contains information about:

- Unpacking and handling the unit
- Removing the accessories from the unit

Keep the following in mind:

- At delivery, the unit **MUST** be checked for damage. Any damage **MUST** be reported immediately to the carrier's claims agent.
- Bring the packed unit as close as possible to its final installation position to prevent damage during transport.
- Prepare the path along which you want to bring the unit inside in advance.

3.2 Indoor unit

3.2.1 To unpack and handle the unit

Use a sling of soft material or protective plates together with a rope when lifting the unit. This to avoid damage or scratches to the unit.

Lift the unit by holding on to the hanger brackets without exerting any pressure on other parts, especially on refrigerant piping, drain piping and other resin parts.

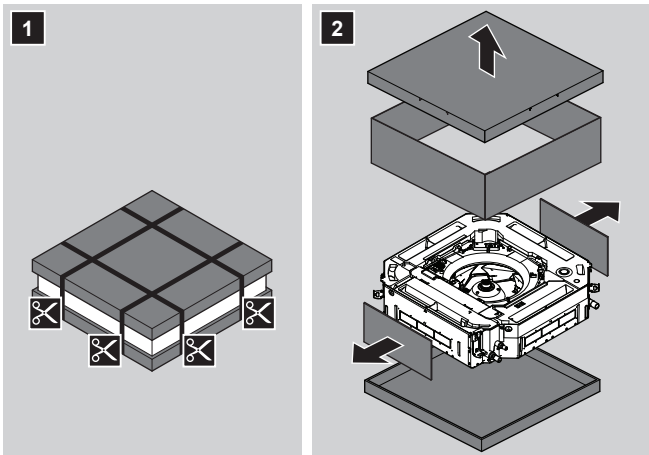

3.2.2 To remove the accessories from the indoor unit

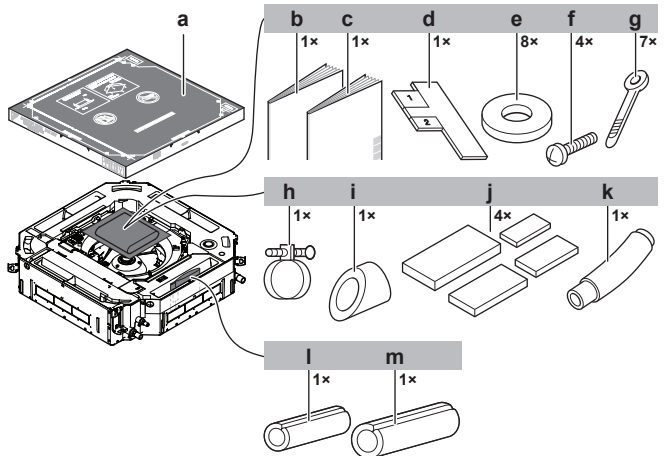

- a Paper pattern for installation (upper part of packing)
- b General safety precautions
- c Indoor unit installation and operation manual
- d Installation guide
- e Washers for hanger brackets
- f Screws (to temporarily attach the paper pattern for installation to the indoor unit)
- g Cable ties
- h Metal clamp
- i Insulation piece (drain pipe)
- j Sealing pads: Large (drain pipe), medium 1 (gas pipe), medium 2 (liquid pipe), small (electrical wiring)
- k Drain hose
- l Insulation piece: Small (liquid pipe)
- m Insulation piece: Large (gas pipe)

4 About the units and options

4.1 Overview: About the units and options

This chapter contains information about:

- Identifying the indoor unit
- Combining outdoor and indoor units
- Combining the indoor unit with options

i INFORMATION

For year-round cooling applications with low indoor humidity conditions, such as Electronic Data Processing rooms, contact your dealer or see the engineering databook or the service manual.

4.2 Identification

! NOTICE

When installing or servicing several units at the same time, make sure **NOT** to switch the service panels between different models.

4.2.1 Identification label: Indoor unit

Location

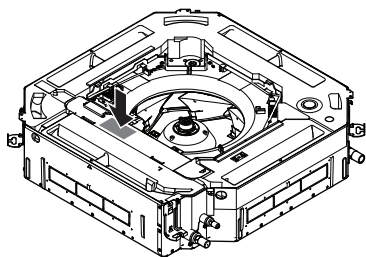

4.3 System layout



NOTICE

Design of the system must not be done at temperatures below -15°C .

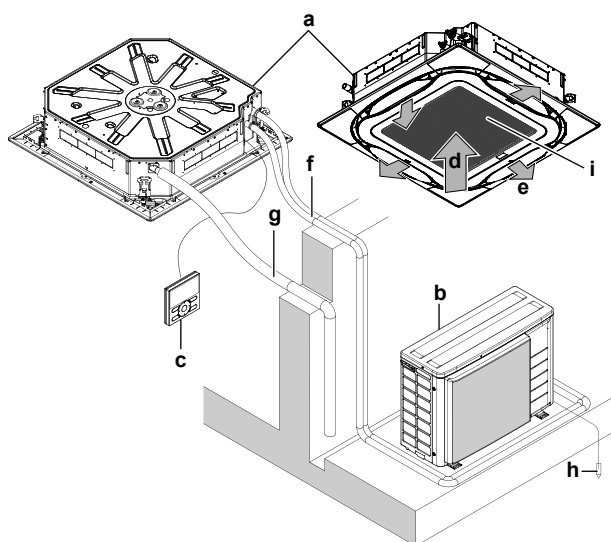

- a Indoor unit
- b Outdoor unit
- c User interface
- d Suction air
- e Discharge air
- f Refrigerant piping + interconnection cable
- g Drain pipe
- h Earth wiring
- i Suction grille and air filter

4.4 Combining units and options

4.4.1 Possible options for the indoor unit

Make sure you have the following mandatory options:

- User interface: Wired or wireless
- Decoration panel: Standard, self-cleaning or design

5 Preparation

5.1 Overview: Preparation

This chapter describes what you have to do and know before going on-site.

It contains information about:

- Preparing the installation site
- Preparing the refrigerant piping

- Preparing the electrical wiring

5.2 Preparing the installation site

Do NOT install the unit in places often used as work place. In case of construction works (e.g. grinding works) where a lot of dust is created, the unit MUST be covered.

Choose an installation location with sufficient space for carrying the unit in and out of the site.

5.2.1 Installation site requirements of the indoor unit



INFORMATION

Also read the following requirements:

- General installation site requirements. See the "General safety precautions" chapter.
- Refrigerant piping requirements (length, height difference). See further in this "Preparation" chapter.



INFORMATION

The sound pressure level is less than 70 dBA.



CAUTION

Appliance not accessible to the general public, install it in a secured area, protected from easy access.

This unit, both indoor and outdoor, is suitable for installation in a commercial and light industrial environment.

Do NOT install the unit in the following places:

- In places where a mineral oil mist, spray or vapour may be present in the atmosphere. Plastic parts may deteriorate and fall off or cause water leakage.

It is NOT recommended to install the unit in the following places because it may shorten the life of the unit:

- Where the voltage fluctuates a lot
- In vehicles or vessels
- Where acidic or alkaline vapour is present



NOTICE

The equipment described in this manual may cause electronic noise generated from radio-frequency energy. The equipment complies to specifications that are designed to provide reasonable protection against such interference. However, there is no guarantee that interference will not occur in a particular installation.

It is therefore recommended to install the equipment and electric wires keeping proper distances away from stereo equipment, personal computers, etc.

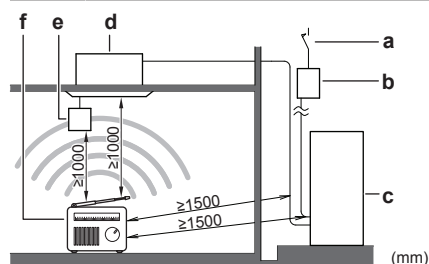

- a Earth leakage protector
- b Fuse
- c Outdoor unit
- d Indoor unit
- e User interface
- f Personal computer or radio

5 Preparation

In places with weak reception, keep distances of 3 m or more to avoid electromagnetic disturbance of other equipment and use conduit tubes for power and transmission lines.

- **Fluorescent lights.** When installing a wireless user interface in a room with fluorescent lights, mind the following to avoid interference:
 - Install the wireless user interface as close as possible to the indoor unit.
 - Install the indoor unit as far as possible from the fluorescent lights.
- Take care that in the event of a water leak, water cannot cause any damage to the installation space and surroundings.
- Choose a location where the hot/cold air discharged from the unit or the operation noise, will NOT disturb anyone.
- **Air flow.** Make sure nothing blocks the air flow.
- **Drainage.** Make sure condensation water can be evacuated properly.
- **Paper pattern for installation** (upper part of packing) (accessory). When selecting the installation location, use the paper pattern. It contains the dimensions of the unit and the required ceiling opening.
- **Air flow directions.** You can select different air flow directions. Choose the one best suited for the room. Also make sure the "Air flow direction" field setting corresponds with the actual situation (see "7.1 Field settings" on page 17).

Example:

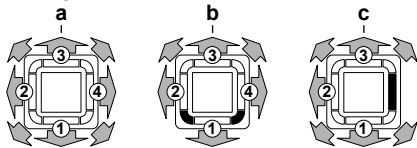

- a All-round air flow
- b 4-way air flow (with closed corners) (optional blocking pad kit required)
- c 3-way air flow (optional blocking pad kit required)

- **Ceiling insulation.** When conditions in the ceiling exceed 30°C and a relative humidity of 80%, or when fresh air is inducted into the ceiling, then additional insulation is required (minimum 10 mm thickness, polyethylene foam).

- **Spacing.** Mind the following requirements:

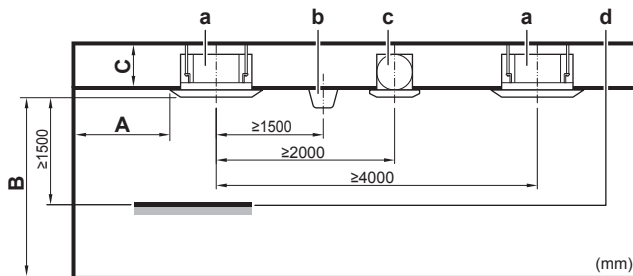

- A Minimum distance to the wall (see below)
- B Minimum and maximum distance to the floor (see below)
- C **20~63 class:**
 - ≥214 mm: In case of installation with standard decoration panel
 - ≥256 mm: In case of installation with design decoration panel
 - ≥294 mm: In case of installation with self-cleaning decoration panel
 - ≥263 mm: In case of installation with fresh air intake kit
- 80~100 class:**
 - ≥256mm: In case of installation with standard decoration panel
 - ≥298mm: In case of installation with design decoration panel
 - ≥306mm: In case of installation with fresh air intake kit
 - ≥316mm: In case of installation with self-cleaning decoration panel
- 125 class:**

- ≥298 mm: In case of installation with standard decoration panel
- ≥340 mm: In case of installation with design decoration panel
- ≥348 mm: In case of installation with fresh air intake kit
- ≥378 mm: In case of installation with self-cleaning decoration panel

- a Indoor unit
- b Lighting (the figure shows ceiling-mounted lighting, but recessed lighting is also allowed)
- c Air fan
- d Static volume (example: table)

- **A: Minimum distance to the wall.** Depends on the air flow directions towards the wall.

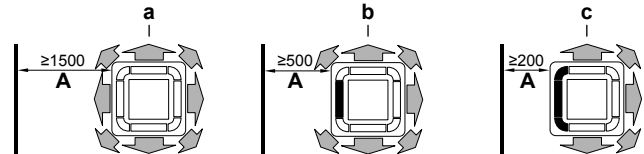

- a Air outlet and corners open
- b Air outlet closed, corners open (optional blocking pad kit required)
- c Air outlet and corners closed (optional blocking pad kit required)

- **B: Minimum and maximum distance to the floor:**

- Minimum: 2.7 m to avoid accidental touching.
- Maximum: Depends on the air flow directions and the capacity class. Also make sure the "Ceiling height" field setting corresponds with the actual situation. See "7.1 Field settings" on page 17.

If air flow direction...	Then B	
	FXFQ20~100	FXFQ125
All-round	≤3.5 m	≤4.2 m
4-way ^(a)	≤4.0 m	≤4.5 m
3-way ^(a)	≤3.5 m	≤4.2 m

(a) Optional blocking kit required

5.3 Preparing refrigerant piping

5.3.1 Refrigerant piping requirements

i INFORMATION

Also read the precautions and requirements in the "General safety precautions" chapter.

Refrigerant piping diameter

Use the same diameters as the connections on the outdoor units:

Class	L1 liquid piping	L1 gas piping
20~50	Ø6.4 mm	Ø12.7 mm
63~125	Ø9.5 mm	Ø15.9 mm

Refrigerant piping material

- **Piping material:** Phosphoric acid deoxidised seamless copper.
- **Flare connections:** Only use annealed material.
- **Piping temper grade and thickness:**

Outer diameter (Ø)	Temper grade	Thickness (t) ^(a)	
6.4 mm (1/4")	Annealed (O)	≥0.8 mm	
9.5 mm (3/8")			
12.7 mm (1/2")			
15.9 mm (5/8")			

- (a) Depending on the applicable legislation and the unit's maximum working pressure (see "PS High" on the unit name plate), larger piping thickness might be required.

5.3.2 Refrigerant piping insulation

- Use polyethylene foam as insulation material:
 - with a heat transfer rate between 0.041 and 0.052 W/mK (0.035 and 0.045 kcal/mh°C)
 - with a heat resistance of at least 120°C
- Insulation thickness

Ambient temperature	Humidity	Minimum thickness
≤30°C	75% to 80% RH	15 mm
>30°C	≥80% RH	20 mm

5.4 Preparing electrical wiring

5.4.1 About preparing electrical wiring

i INFORMATION

Also read the precautions and requirements in the "General safety precautions" chapter.

! WARNING

- If the power supply has a missing or wrong N-phase, equipment might break down.
- Establish proper earthing. Do NOT earth the unit to a utility pipe, surge absorber, or telephone earth. Incomplete earthing may cause electrical shock.
- Install the required fuses or circuit breakers.
- Secure the electrical wiring with cable ties so that the cables do NOT come in contact with sharp edges or piping, particularly on the high-pressure side.
- Do NOT use taped wires, stranded conductor wires, extension cords, or connections from a star system. They can cause overheating, electrical shock or fire.
- Do NOT install a phase advancing capacitor, because this unit is equipped with an inverter. A phase advancing capacitor will reduce performance and may cause accidents.

! WARNING

- All wiring MUST be performed by an authorised electrician and MUST comply with the applicable legislation.
- Make electrical connections to the fixed wiring.
- All components procured on-site and all electrical construction MUST comply with the applicable legislation.

! WARNING

ALWAYS use multicore cable for power supply cables.

6 Installation

6.1 Overview: Installation

This chapter describes what you have to do and know on-site to install the system.

Typical workflow

Installation typically consists of the following stages:

- Mounting the outdoor unit.
- Mounting the indoor unit (+ decoration panel).
- Connecting the refrigerant piping.
- Checking the refrigerant piping.
- Charging refrigerant.
- Connecting the electrical wiring.
- Finishing the outdoor installation.
- Finishing the indoor installation.

i INFORMATION

This chapter only describes installation instructions specific to the indoor unit. For the other instructions, see:

- The installation manual of the outdoor unit
- The installation manual of the user interface
- The installation manual of the decoration panel

! NOTICE

After installing the decoration panel:

- Make sure there is no gap between the unit body and the decoration panel. **Possible consequence:** Air might leak and cause dew drop.
- Make sure no oil remains on the plastic parts of the decoration panel. **Possible consequence:** Degradation and damage of plastic parts.

6.2 Mounting the indoor unit

6.2.1 Precautions when mounting the indoor unit

i INFORMATION

Also read the precautions and requirements in the following chapters:

- General safety precautions
- Preparation

6.2.2 Guidelines when installing the indoor unit

i INFORMATION

Optional equipment. When installing optional equipment, also read the installation manual of the optional equipment. Depending on the field conditions, it might be easier to install the optional equipment first.

- In case of installation with a fresh air intake kit.** Install the fresh air intake kit always **before** installing the unit.
- Decoration panel.** Install the decoration panel always **after** installing the unit.
- Ceiling strength.** Check whether the ceiling is strong enough to support the weight of the unit. If there is a risk, reinforce the ceiling before installing the unit.
 - For existing ceilings, use anchors.
 - For new ceilings, use sunken inserts, sunken anchors or other field supplied parts.

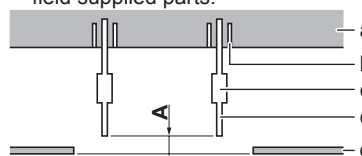

A 50~100 mm: In case of installation with standard panel

6 Installation

100~150 mm: In case of installation with fresh air intake kit or design panel

130~180 mm: In case of installation with self-cleaning decoration panel

- a Ceiling slab
- b Anchor
- c Long nut or turnbuckle
- d Suspension bolt
- e Suspended ceiling

- **Suspension bolts.** Use M8~M10 suspension bolts for installation. Attach the hanger bracket to the suspension bolt. Fix it securely using a nut and washer from the upper and lower sides of the hanger bracket.

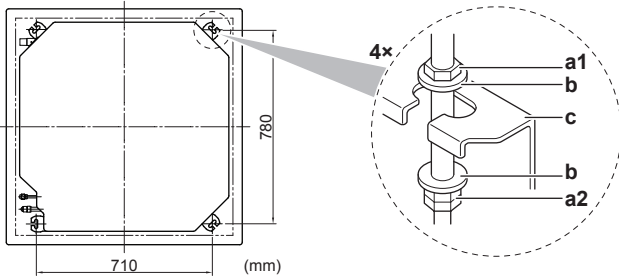

- a1 Nut (field supply)
- a2 Double nut (field supply)
- b Washer (accessories)
- c Hanger bracket (attached to the unit)

- **Paper pattern for installation** (upper part of the packing). Use the paper pattern to determine the correct horizontal positioning. It contains the necessary dimensions and centers. You can attach the paper pattern to the unit.

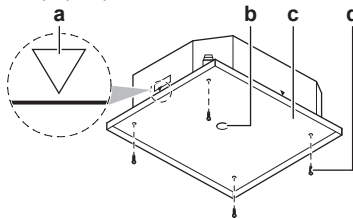

- a Centre of the unit
- b Centre of the ceiling opening
- c Paper pattern for installation (upper part of the packing)
- d Screws (accessories)

▪ Ceiling opening and unit:

- Make sure the ceiling opening is within the following limits:

Minimum: 860 mm to be able to fit the unit.

Maximum: 910 mm to ensure enough overlap between the decoration panel and the suspended ceiling. If the ceiling opening is larger, add extra ceiling material.

- Make sure the unit and its hanger brackets (suspension) are centered within the ceiling opening.

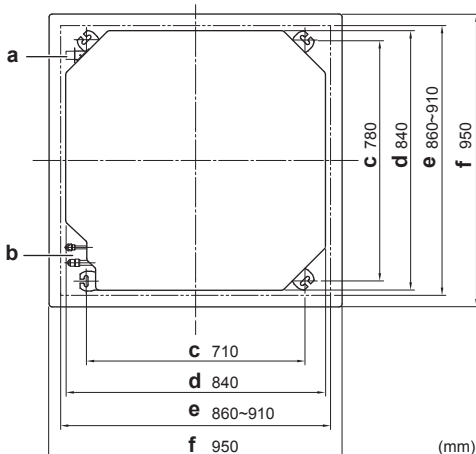

- a Drain piping
- b Refrigerant piping
- c Hanger bracket pitch (suspension)

- d Unit
- e Ceiling opening
- f Decoration panel

	If A	Then	
		B	C
	≥860 mm	10 mm	45 mm
	≤910 mm	35 mm	20 mm

- A Ceiling opening
- B Distance between the unit and the ceiling opening
- C Overlap between the decoration panel and the suspended ceiling

- **Installation guide.** Use the installation guide to determine the correct vertical position.

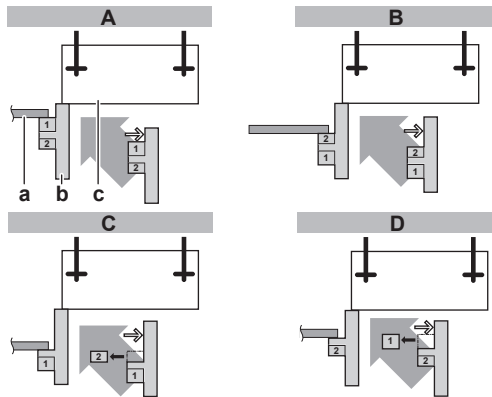

- A In case of installation with standard decoration panel
- B In case of installation with fresh air intake kit
- C In case of installation with self-cleaning decoration panel
- D In case of installation with design decoration panel
- a Suspended ceiling
- b Installation guide (accessory)
- c Unit

- **Level.** Make sure the unit is level at all 4 corners using a level or a water-filled vinyl tube.

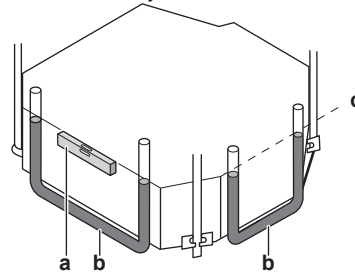

- a Level
- b Vinyl tube
- c Water level

! NOTICE

Do NOT install the unit tilted. **Possible consequence:** If the unit is tilted against the direction of the condensate flow (the drain piping side is raised), the float switch might malfunction and cause water to drip.

6.2.3 Guidelines when installing the drain piping

Make sure condensation water can be evacuated properly. This involves:

- General guidelines
- Connecting the drain piping to the indoor unit
- Checking for water leaks

General guidelines

- **Pipe length.** Keep drain piping as short as possible.
- **Pipe size.** Keep the pipe size equal to or greater than that of the connecting pipe (vinyl pipe of 25 mm nominal diameter and 32 mm outer diameter).
- **Slope.** Make sure the drain piping slopes down (at least 1/100) to prevent air from being trapped in the piping. Use hanging bars as shown.

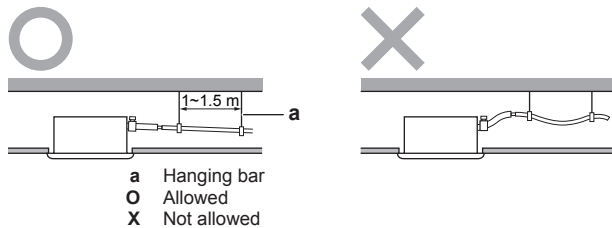

- **Rising piping.** If necessary to make the slope possible, you can install rising piping.

- Drain hose inclination: 0~75 mm to avoid stress on the piping and to avoid air bubbles.
- Rising piping: ≤300 mm from the unit, ≤675 mm perpendicular to the unit.

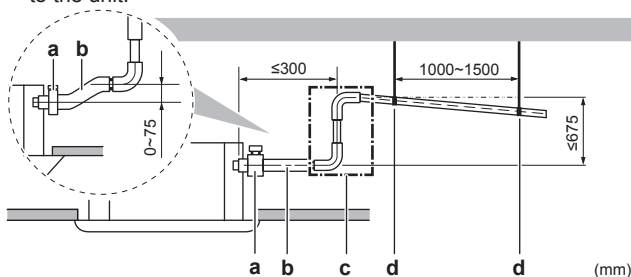

- **Condensation.** Take measures against condensation. Insulate the complete drain piping in the building.

- **Combining drain pipes.** You can combine drain pipes. Make sure to use drain pipes and T-joints with a correct gauge for the operating capacity of the units.

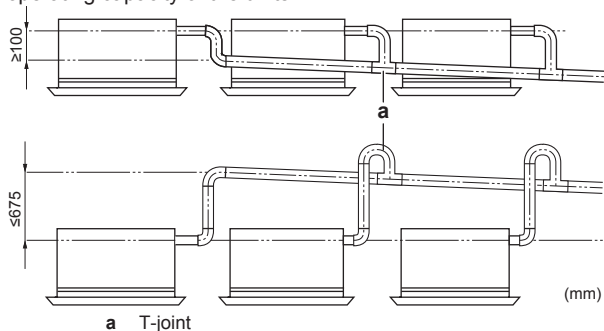

To connect the drain piping to the indoor unit

NOTICE

Incorrect connection of the drain hose might cause leaks, and damage the installation space and surroundings.

- 1 Push the drain hose as far as possible over the drain pipe connection.
- 2 Tighten the metal clamp until the screw head is less than 4 mm from the metal clamp part.
- 3 Check for water leaks (see "To check for water leaks" on page 13).

- 4 Install the insulation piece (drain pipe).
- 5 Wind the large sealing pad (= insulation) around the metal clamp and drain hose, and fix it with cable ties.
- 6 Connect the drain piping to the drain hose.

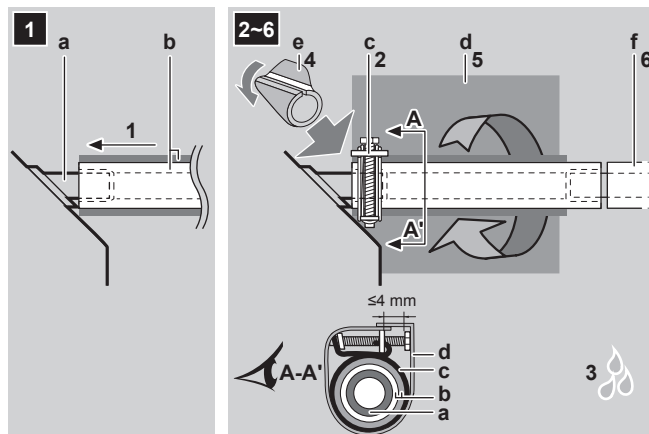

- a** Drain pipe connection (attached to the unit)
b Drain hose (accessory)
c Metal clamp (accessory)
d Large sealing pad (accessory)
e Insulation piece (drain pipe) (accessory)
f Drain piping (field supply)

To check for water leaks

The procedure differs depending on whether electrical wiring is already finished. When electrical wiring is not finished yet, you need to temporarily connect the user interface and power supply to the unit.

When electrical wiring is not finished yet

- 1 Temporarily connect electrical wiring.
 - Remove the switch box cover (a).
 - Connect the user interface and transmission wiring (b).
 - Connect the power supply (1~ 220-240 V 50/60 Hz) and earth (c).
 - Reattach the switch box cover (a).

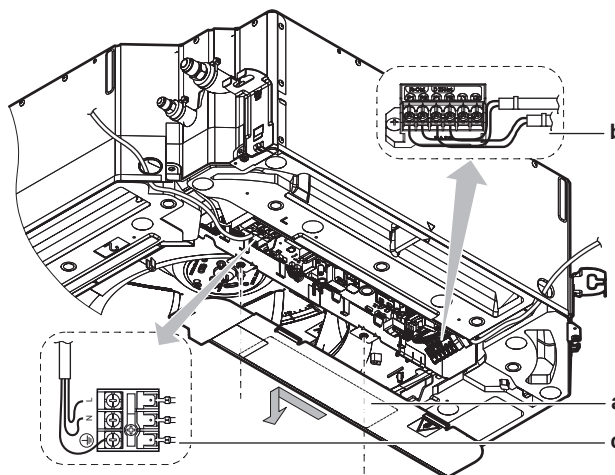

- 2 Turn ON the power.
- 3 Start cooling operation (see "8.4 To perform a test run" on page 19).
- 4 Gradually pour approximately 1 l of water through the air discharge outlet, and check for leaks.

6 Installation

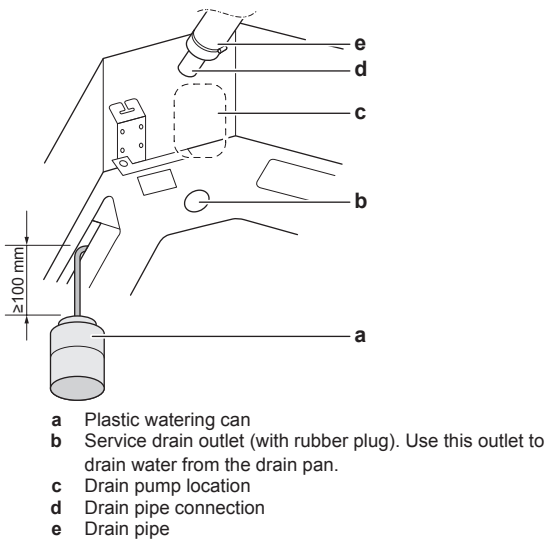

- 5 Turn OFF the power.
- 6 Disconnect the electrical wiring.
 - Remove the switch box cover.
 - Disconnect the power supply and earth.
 - Disconnect the user interface.
 - Reattach the switch box cover.

When electrical wiring is finished already

- 1 Start cooling operation (see "8.4 To perform a test run" on page 19).
- 2 Gradually pour approximately 1 l of water through the air discharge outlet, and check for leaks (see "When electrical wiring is not finished yet" on page 13).

6.3 Connecting the refrigerant piping

6.3.1 About connecting the refrigerant piping

Before connecting the refrigerant piping

Make sure the outdoor and indoor unit are mounted.

Typical workflow

Connecting the refrigerant piping involves:

- Connecting the refrigerant piping to the indoor unit
- Connecting the refrigerant piping to the outdoor unit
- Insulating the refrigerant piping
- Keeping in mind the guidelines for:
 - Pipe bending
 - Flaring pipe ends
 - Using the stop valves

6.3.2 Precautions when connecting the refrigerant piping



INFORMATION

Also read the precautions and requirements in the following chapters:

- General safety precautions
- Preparation



DANGER: RISK OF BURNING



CAUTION

- Do NOT use mineral oil on flared part.
- Do NOT reuse piping from previous installations.
- NEVER install a drier to this R410A unit to guarantee its lifetime. The drying material may dissolve and damage the system.



NOTICE

Take the following precautions on refrigerant piping into account:

- Avoid anything but the designated refrigerant to get mixed into the refrigerant cycle (e.g. air).
- Only use R410A when adding refrigerant.
- Only use installation tools (e.g. manifold gauge set) that are exclusively used for R410A installations to withstand the pressure and to prevent foreign materials (e.g. mineral oils and moisture) from mixing into the system.
- Install the piping so that the flare is NOT subjected to mechanical stress
- Protect the piping as described in the following table to prevent dirt, liquid or dust from entering the piping.
- Use caution when passing copper tubes through walls (see figure below).

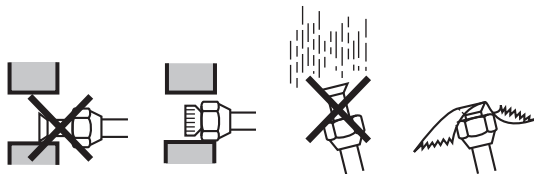

Unit	Installation period	Protection method
Outdoor unit	>1 month	Pinch the pipe
	<1 month	Pinch or tape the pipe
Indoor unit	Regardless of the period	



INFORMATION

Do NOT open the refrigerant stop valve before checking the refrigerant piping. When you need to charge additional refrigerant it is recommended to open the refrigerant stop valve after charging.

6.3.3 Guidelines when connecting the refrigerant piping

Take the following guidelines into account when connecting pipes:

- Coat the flare inner surface with ether oil or ester oil when connecting a flare nut. Tighten 3 or 4 turns by hand, before tightening firmly.

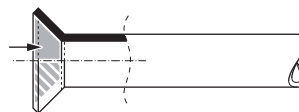

- ALWAYS use 2 wrenches together when loosening a flare nut.
- ALWAYS use a spanner and torque wrench together to tighten the flare nut when connecting the piping. This to prevent nut cracking and leaks.

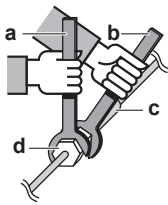

- a Torque wrench
- b Spanner
- c Piping union
- d Flare nut

Piping size (mm)	Tightening torque (N·m)	Flare dimensions (A) (mm)	Flare shape (mm)
Ø6.4	15~17	8.7~9.1	
Ø9.5	33~39	12.8~13.2	
Ø12.7	50~60	16.2~16.6	
Ø15.9	63~75	19.3~19.7	

6.3.4 Pipe bending guidelines

Use a pipe bender for bending. All pipe bends should be as gentle as possible (bending radius should be 30~40 mm or larger).

6.3.5 To flare the pipe end



CAUTION

- Incomplete flaring may cause refrigerant gas leakage.
- Do NOT re-use flares. Use new flares to prevent refrigerant gas leakage.
- Use flare nuts that are included with the unit. Using different flare nuts may cause refrigerant gas leakage.

- 1 Cut the pipe end with a pipe cutter.
- 2 Remove burrs with the cut surface facing down so that the chips do NOT enter the pipe.

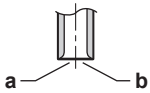

- a Cut exactly at right angles.
- b Remove burrs.

- 3 Remove the flare nut from the stop valve and put the flare nut on the pipe.
- 4 Flare the pipe. Set exactly at the position as shown in the following figure.

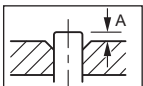

	Flare tool for R410A (clutch type)	Conventional flare tool	
		Clutch type (Ridgid-type)	Wing nut type (Imperial-type)
A	0~0.5 mm	1.0~1.5 mm	1.5~2.0 mm

- 5 Check that the flaring is properly made.

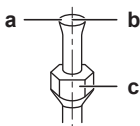

- a Flare's inner surface MUST be flawless.
- b The pipe end MUST be evenly flared in a perfect circle.
- c Make sure the flare nut is fitted.

6.3.6 To connect the refrigerant piping to the indoor unit



CAUTION

Install the refrigerating piping or components in a position where they are unlikely to be exposed to any substance which may corrode components containing refrigerant, unless the components are constructed of materials that are inherently resistant to corrosion or are suitably protected against corrosion.

- **Pipe length.** Keep refrigerant piping as short as possible.
- **Flare connections.** Connect refrigerant piping to the unit using flare connections.
- **Insulation.** Insulate the refrigerant piping on the indoor unit as follows:

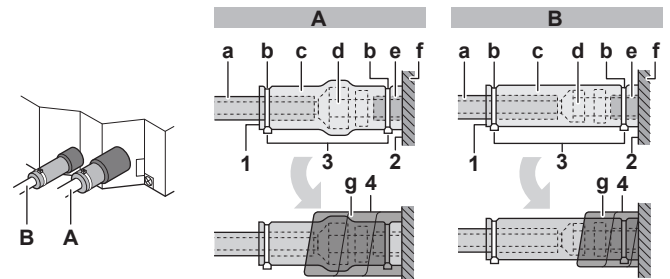

- A Gas piping
 - B Liquid piping
 - a Insulation material (field supply)
 - b Cable tie (accessory)
 - c Insulation pieces: Large (gas pipe), small (liquid pipe) (accessories)
 - d Flare nut (attached to the unit)
 - e Refrigerant pipe connection (attached to the unit)
 - f Unit
 - g Sealing pads: Medium 1 (gas pipe), medium 2 (liquid pipe) (accessories)
- 1 Turn up the seams of the insulation pieces.
 - 2 Attach to the base of the unit.
 - 3 Tighten the cable ties on the insulation pieces.
 - 4 Wrap the sealing pad from the base of the unit to the top of the flare nut.



NOTICE

Make sure to insulate all refrigerant piping. Any exposed piping might cause condensation.

6.4 Connecting the electrical wiring

6.4.1 About connecting the electrical wiring

Typical workflow

Connecting the electrical wiring typically consists of the following stages:

- 1 Making sure the power supply system complies with the electrical specifications of the units.
- 2 Connecting the electrical wiring to the outdoor unit.
- 3 Connecting the electrical wiring to the indoor unit.
- 4 Connecting the main power supply.

6 Installation

6.4.2 Precautions when connecting the electrical wiring



INFORMATION

Also read the precautions and requirements in the following chapters:

- General safety precautions
- Preparation



DANGER: RISK OF ELECTROCUTION



WARNING

ALWAYS use multicore cable for power supply cables.



WARNING

Use an all-pole disconnection type breaker with at least 3 mm between the contact point gaps that provide full disconnection under overvoltage category III.



WARNING

If the supply cord is damaged, it MUST be replaced by the manufacturer, its service agent or similarly qualified persons in order to avoid a hazard.

6.4.3 Guidelines when connecting the electrical wiring

Keep the following in mind:

- If stranded conductor wires are used, install a round crimp-style terminal on the end of the wire. Place the round crimp-style terminal on the wire up to the covered part and fasten the terminal with the appropriate tool.

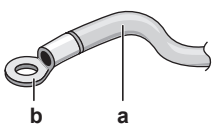

- a Stranded conductor wire
- b Round crimp-style terminal

- Use the following methods for installing wires:

Wire type	Installation method
Single-core wire	<p>a Curled single-core wire b Screw c Flat washer</p>
Stranded conductor wire with round crimp-style terminal	<p>a Terminal b Screw c Flat washer O Allowed X NOT allowed</p>

Tightening torques

Wiring	Screw size	Tightening torque (N·m)
Interconnection cable (indoor↔outdoor)	M4	1.18~1.44
User interface cable	M3.5	0.79~0.97

6.4.4 Specifications of standard wiring components

Component	Class	Class					
		20~40	50	63	80	100	125
Power supply cable	MCA ^(a)	0.5 A	0.6 A	0.7 A	1.2 A	1.3 A	1.4 A
	Voltage	220~240 V					
	Phase	1~					
	Frequency	50/60 Hz					
	Wire sizes	Must comply with applicable legislation					
Interconnection cable	4-core cable 1.5 mm ² ~2.5 mm ² and applicable for 220~240 V H05RN-F (60245 IEC 57)						
User interface cable	Vinyl cords with 0.75 to 1.25 mm ² sheath or cables (2-core wires) Maximum 500 m H03VV-F (60227 IEC 52)						
Recommended field fuse	16 A						
Earth leakage circuit breaker	Must comply with applicable legislation						

(a) MCA=Minimum circuit ampacity. Stated values are maximum values (see electrical data of combination with indoor units for exact values).

6.4.5 To connect the electrical wiring on the indoor unit



NOTICE

- Follow the wiring diagram (delivered with the unit, located at the inside of the service cover).
- For instructions on how to connect the decoration panel and the sensor kit, see the installation manual delivered with the panel or the kit.
- Make sure the electrical wiring does NOT obstruct proper reattachment of the service cover.

It is important to keep the power supply and the transmission wiring separated from each other. In order to avoid any electrical interference the distance between both wirings should ALWAYS be at least 50 mm.



NOTICE

Be sure to keep the power line and transmission line apart from each other. Transmission wiring and power supply wiring may cross, but may NOT run parallel.

- 1 Remove the service cover.
- 2 **User interface cable:** Route the cable through the frame, connect the cable to the terminal block, and fix the cable with a cable tie.
- 3 **Interconnection cable (indoor↔outdoor):** Route the cable through the frame, connect the cable to the terminal block (make sure the numbers match with the numbers on the outdoor unit, and connect the earth wire), and fix the cable with a cable tie.

- Divide the small sealing (accessory) and wrap it around the cables to prevent water from entering the unit. Seal all gaps to prevent small animals from entering the system.



WARNING

Provide adequate measures to prevent that the unit can be used as a shelter by small animals. Small animals that make contact with electrical parts can cause malfunctions, smoke or fire.

- Reattach the service cover.



NOTICE

When closing the service cover, make sure that the tightening torque for screws is $\leq 1.5N \cdot m$.

Wiring example

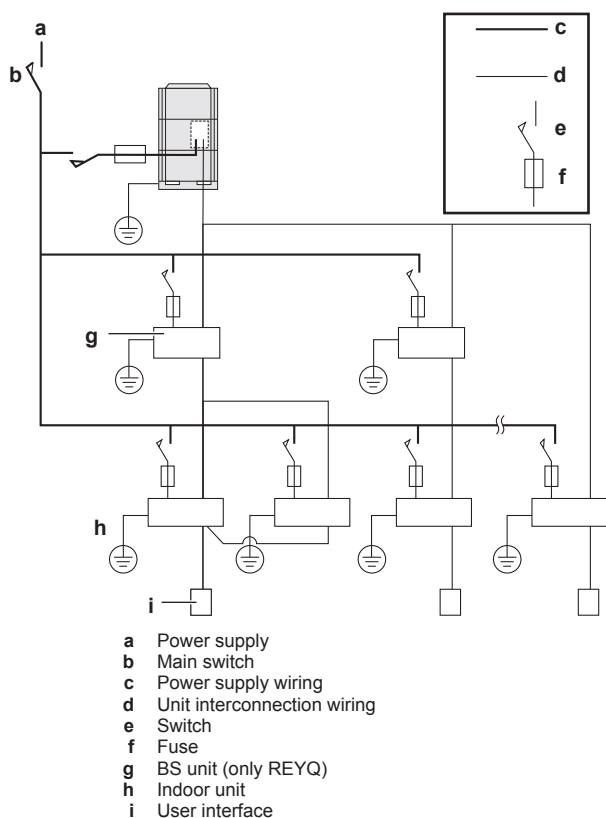

Complete system example

- When 1 user interface controls 1 indoor unit.

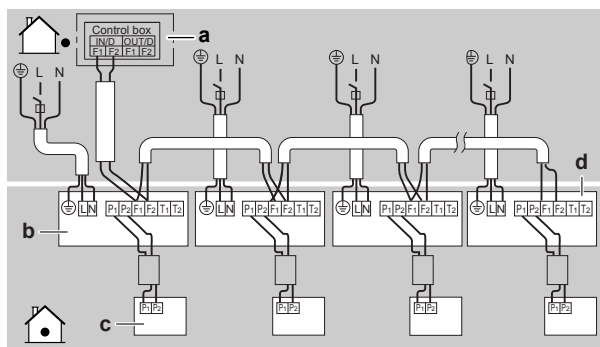

- Group control or use with 2 user interfaces.

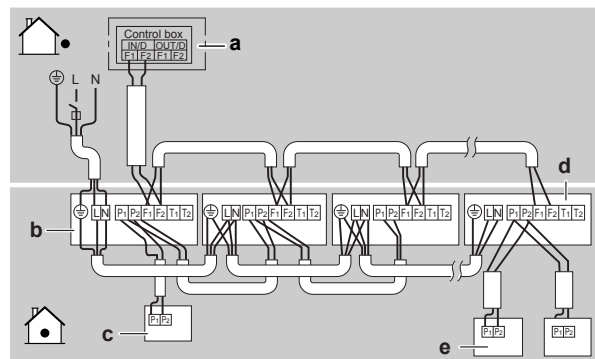

- When including BS unit (only REYQ).

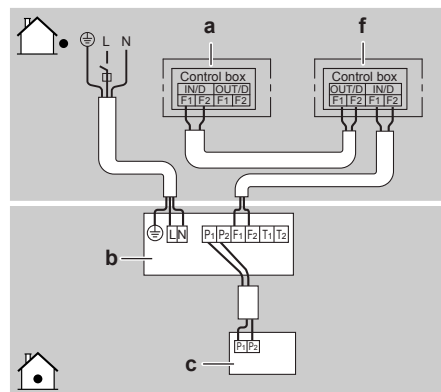

- a** Outdoor unit
b Indoor unit
c User interface
d Most downstream indoor unit
e For use with 2 user interfaces
f BS unit

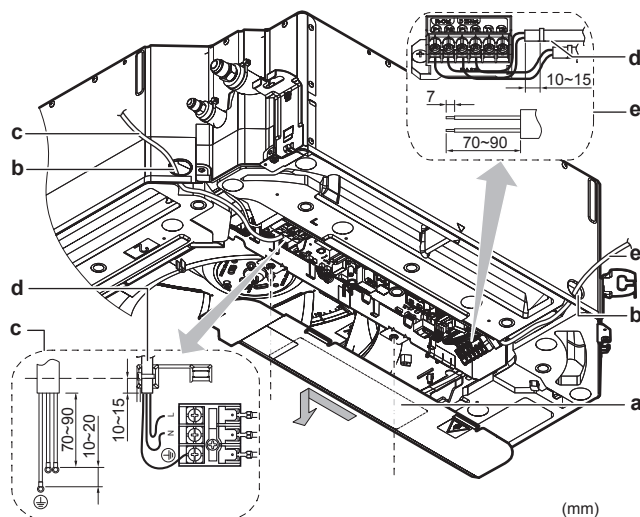

- a** Service cover (with wiring diagram on the back)
b Opening for cables
c Connection of power supply (including earth)
d Cable tie
e Connection of user interface and interconnection cable

7 Configuration

7.1 Field settings

Make the following field settings so that they correspond with the actual installation setup and with the needs of the user:

- Ceiling height
- Design decoration panel (if applicable)
- Air flow direction

8 Commissioning

- Air volume when thermostat control is OFF
- Time to clean air filter

Setting: Ceiling height

This setting must correspond with the actual distance to the floor, capacity class and air flow directions.

- For 3-way and 4-way air flows (which require an optional blocking pad kit), see the installation manual of the optional blocking pad kit.
- For all-round air flow, use the table below.

If the distance to the floor is (m)		Then ¹		
FXFQ20~100	FXFQ125	M	C1	C2
≤2.7	≤3.2	13 (23)	0	01
2.7<x≤3.0	3.2<x≤3.6			02
3.0<x≤3.5	3.6<x≤4.2			03

Setting: Decoration panel type

When installing or changing the decoration panel type, ALWAYS check if the correct values are set.

If the ... decoration panel is used	Then ¹		
	M	C1	C2
Standard or self-cleaning	13 (23)	15	01
Design			02

Setting: Air flow direction

This setting must correspond with the actual used air flow directions. See the installation manual of the optional blocking pad kit and the manual of the user interface.

Default: 01 (= all-round air flow)

Example:

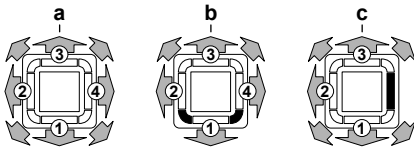

- a All-round air flow
- b 4-way air flow (all air outlets open, 2 corners closed) (optional blocking pad kit required)
- c 3-way air flow (1 air outlet closed, all corners open) (optional blocking pad kit required)

Setting: Air volume when thermostat control is OFF

This setting must correspond with the needs of the user. It determines the fan speed of the indoor unit during thermostat OFF condition.

- 1 If you have set the fan to operate, set the air volume speed:

If you want	Outdoor unit	Then ¹		
		M	C1	C2
During cooling operation	LL ²	12	6	01
	Setup volume ²	(22)		02

⁽¹⁾ Field settings are defined as follows:

- **M**: Mode number – **First number**: for group of units – **Number between brackets**: for individual unit
- **C1**: First code number
- **C2**: Second code number
- **■**: Default

⁽²⁾ Fan speed:

- **LL**: Low fan speed
- **Setup volume**: The fan speed corresponds to the speed the user has set (low, medium, high) using the fan speed button on the user interface.

	If you want	Then ¹		
		Outdoor unit		
		M	C1	C2
During heating operation	LL ²	12	3	01
	Setup volume ²	(22)		02

Setting: Time to clean air filter

This setting must correspond with the air contamination in the room. It determines the interval at which the **TIME TO CLEAN AIR FILTER** notification is displayed on the user interface. When using a wireless user interface, you must also set the address (see the installation manual of the user interface).

If you want an interval of... (air contamination)	Then ¹		
	M	C1	C2
±2500 h (light)	10 (20)	0	01
±1250 h (heavy)			02
No notification		3	02

Individual setting in a simultaneous operation system

We recommend using the optional user interface to set the slave unit.

Perform the following steps:

- 2 Change the second code number to 02 to perform individual setting on the slave unit.

If you want to set the slave unit as...	Then ¹		
	M	C1	C2
Unified setting	21(11)	01	01
Individual setting			02

- 3 Perform field setting for the master unit.
- 4 Turn off the main power supply switch.
- 5 Disconnect the remote controller from the master unit and connect it to the slave unit.
- 6 Change to individual setting.
- 7 Perform field setting for the slave unit.
- 8 Turn off the main power supply or, in case of more slave units, repeat the previous steps for all slave units.
- 9 Disconnect the user interface from the slave unit and reconnect it to the master unit.

It is not necessary to rewire the remote controller from the master unit if the optional user interface is used. (However, remove the wires attached to the user interface terminal board of the master unit)

8 Commissioning

8.1 Overview: Commissioning

This chapter describes what you have to do and know to commission the system after it is installed.

Typical workflow

Commissioning typically consists of the following stages:

- 1 Checking the "Checklist before commissioning".
- 2 Performing a test run for the system.

8.2 Precautions when commissioning

INFORMATION

During the first running period of the unit, the required power may be higher than stated on the nameplate of the unit. This phenomenon is caused by the compressor, that needs a continuous run time of 50 hours before reaching smooth operation and stable power consumption.

NOTICE

Before starting up the system, the unit **MUST** be energised for at least 6 hours to avoid compressor breakdown during startup.

NOTICE

NEVER operate the unit without thermistors and/or pressure sensors/switches. Burning of the compressor might result.

NOTICE

Do **NOT** operate the unit until the refrigerant piping is complete (when operated this way, the compressor will break).

NOTICE

Cooling operation mode. Perform the test run in cooling operation mode so that stop valves failing to open can be detected. Even if the user interface was set to heating operation mode, the unit will run in cooling operation mode during 2-3 minutes (although the user interface will display the heating icon), and then automatically switch to heating operation mode.

NOTICE

If you cannot operate the unit in test run, see **"8.5 Error codes when performing a test run"** on page 20.

WARNING

If the panels on the indoor units are not installed yet, make sure to power **OFF** the system after finishing the test run. To do so, turn **OFF** operation via the user interface. Do **NOT** stop operation by turning **OFF** the circuit breakers.

8.3 Checklist before commissioning

After the installation of the unit, first check the following items. Once all below checks are fulfilled, the unit **MUST** be closed, **ONLY** then can the unit be powered up.

<input type="checkbox"/>	You read the complete installation instructions, as described in the installer reference guide .
<input type="checkbox"/>	The indoor units are properly mounted.
<input type="checkbox"/>	In case a wireless user interface is used: The indoor unit decoration panel with infrared receiver is installed.
<input type="checkbox"/>	The outdoor unit is properly mounted.
<input type="checkbox"/>	There are NO missing phases or reversed phases .
<input type="checkbox"/>	The system is properly earthed and the earth terminals are tightened.

<input type="checkbox"/>	The fuses or locally installed protection devices are installed according to this document, and have NOT been bypassed.
<input type="checkbox"/>	The power supply voltage matches the voltage on the identification label of the unit.
<input type="checkbox"/>	There are NO loose connections or damaged electrical components in the switch box.
<input type="checkbox"/>	The insulation resistance of the compressor is OK.
<input type="checkbox"/>	There are NO damaged components or squeezed pipes on the inside of the indoor and outdoor units.
<input type="checkbox"/>	There are NO refrigerant leaks .
<input type="checkbox"/>	The correct pipe size is installed and the pipes are properly insulated.
<input type="checkbox"/>	The stop valves (gas and liquid) on the outdoor unit are fully open.

8.4 To perform a test run

This task is only applicable when using the BRC1E52 or BRC1E53 user interface. When using any other user interface, see the installation manual or service manual of the user interface.

NOTICE

Do not interrupt the test run.



INFORMATION

Backlight. To perform an ON/OFF action on the user interface, the backlight does not need to be lit. For any other action, it needs to be lit first. The backlight is lit for ± 30 seconds when you press a button.

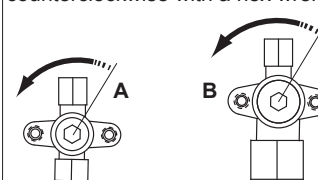
- 1 Perform introductory steps.

#	Action
1	Open the liquid stop valve (A) and gas stop valve (B) by removing the stem cap and turning counterclockwise with a hex wrench until it stops. 
2	Close the service cover to prevent electric shocks.
3	Turn ON power for at least 6 hours before starting operation to protect the compressor.
4	On the user interface, set the unit to cooling operation mode.

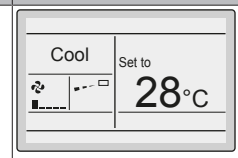
- 2 Start the test run

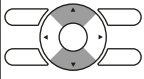
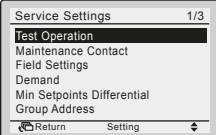
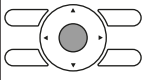
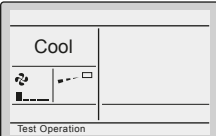
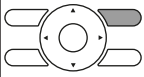

#	Action	Result
1	Go to the home menu.	
2	Press at least 4 seconds. 	The Service Settings menu is displayed.

9 Hand-over to the user

#	Action	Result
3	Select Test Operation. 	
4	Press. 	Test Operation is displayed on the home menu. 
5	Press within 10 seconds. 	Test run starts.

3 Check operation for 3 minutes.

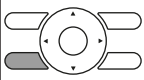
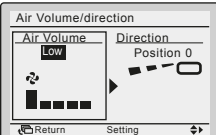
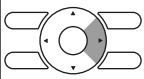
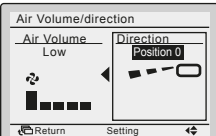
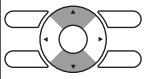
4 Check operation of the airflow direction.

#	Action	Result
1	Press. 	
2	Select Position 0. 	
3	Change the position. 	If the airflow flap of the indoor unit moves, operation is OK. If not, operation is not OK.
4	Press. 	The home menu is displayed.

5 Stop the test run.

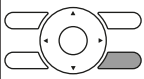
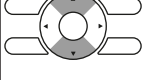
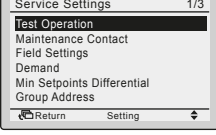
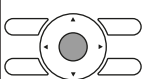
#	Action	Result
1	Press at least 4 seconds. 	The Service Settings menu is displayed.
2	Select Test Operation. 	
3	Press. 	The unit returns to normal operation, and the home menu is displayed.

8.5 Error codes when performing a test run

If the installation of the outdoor unit has NOT been done correctly, the following error codes may be displayed on the user interface:

Error code	Possible cause
Nothing displayed (the currently set temperature is not displayed)	<ul style="list-style-type: none"> The wiring is disconnected or there is a wiring error (between power supply and outdoor unit, between outdoor unit and indoor units, between indoor unit and user interface). The fuse on the outdoor or indoor unit PCB has blown.
E3, E4 or L8	<ul style="list-style-type: none"> The stop valves are closed. The air inlet or air outlet is blocked.
E7	<p>There is a missing phase in case of three-phase power supply units.</p> <p>Note: Operation will be impossible. Turn OFF the power, recheck the wiring, and switch two of the three electrical wires.</p>
L4	The air inlet or air outlet is blocked.
U0	The stop valves are closed.
U2	<ul style="list-style-type: none"> There is a voltage imbalance. There is a missing phase in case of three-phase power supply units. Note: Operation will be impossible. Turn OFF the power, recheck the wiring, and switch two of the three electrical wires.
U4 or UF	The inter-unit branch wiring is not correct.
UA	The outdoor and indoor unit are incompatible.

9 Hand-over to the user

Once the test run is finished and the unit operates properly, please make sure the following is clear for the user:

- Make sure that the user has the printed documentation and ask him/her to keep it for future reference. Inform the user that he can find the complete documentation at the URL mentioned earlier in this manual.
- Explain the user how to properly operate the system and what to do in case of problems.
- Show the user what to do for the maintenance of the unit.

10 Disposal



NOTICE

Do NOT try to dismantle the system yourself: dismantling of the system, treatment of the refrigerant, oil and other parts MUST comply with applicable legislation. Units MUST be treated at a specialised treatment facility for reuse, recycling and recovery.

11 Technical data

- A **subset** of the latest technical data is available on the regional Daikin website (publicly accessible).
- The **full set** of latest technical data is available on the Daikin extranet (authentication required).

11.1 Piping diagram: Indoor unit

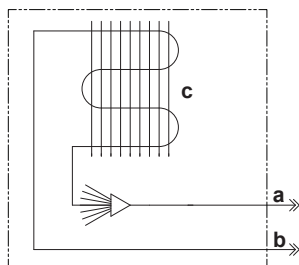

- a Liquid pipe connection
- b Gas pipe connection
- c Heat exchanger

11.2 Wiring diagram

11.2.1 Unified wiring diagram legend

For applied parts and numbering, refer to the wiring diagram on the unit. Part numbering is by Arabic numbers in ascending order for each part and is represented in the overview below symbol "*" in the part code.

Symbols:

	Circuit breaker		Protective earth
	Connection		Protective earth (screw)
	Connector		Rectifier
	Earth		Relay connector
	Field wiring		Short-circuit connector
	Fuse		Terminal
	Indoor unit		Terminal strip
	Outdoor unit		Wire clamp

Colors:

BLK	Black	ORG	Orange
BLU	Blue	PNK	Pink
BRN	Brown	PRP, PPL	Purple
GRN	Green	RED	Red
GRY	Grey	WHT	White
		YLW	Yellow

Legends:

A*P	Printed circuit board
BS*	Pushbutton ON/OFF, operation switch
BZ, H*C	Buzzer
C*	Capacitor
AC*, CN*, E*, HA*, HE*, HL*, HN*, HR*, MR*_A, MR*_B, S*, U, V, W, X*A, K*R_*	Connection, connector
D*, V*D	Diode
DB*	Diode bridge
DS*	Dip switch
E*H	Heater
FU*, F*U, (for characteristics, refer to PCB inside your unit)	Fuse
FG*	Connector (frame ground)
H*	Harness
H*P, LED*, V*L	Pilot lamp, light emitting diode

HAP	Light emitting diode (service monitor green)
HIGH VOLTAGE	High voltage
IES	Intelligent eye sensor
IPM*	Intelligent power module
K*R, KCR, KFR, KHuR, K*M	Magnetic relay
L	Live
L*	Coil
L*R	Reactor
M*	Stepper motor
M*C	Compressor motor
M*F	Fan motor
M*P	Drain pump motor
M*S	Swing motor
MR*, MRCW*, MRM*, MRN*	Magnetic relay
N	Neutral
n=*, N=*	Number of passes through ferrite core
PAM	Pulse-amplitude modulation
PCB*	Printed circuit board
PM*	Power module
PS	Switching power supply
PTC*	Thermistor PTC
Q*	Insulated gate bipolar transistor (IGBT)
Q*DI	Earth leak circuit breaker
Q*L	Overload protector
Q*M	Thermo switch
R*	Resistor
R*T	Thermistor
RC	Receiver
S*C	Limit switch
S*L	Float switch
S*NPH	Pressure sensor (high)
S*NPL	Pressure sensor (low)
S*PH, HPS*	Pressure switch (high)
S*PL	Pressure switch (low)
S*T	Thermostat
S*RH	Humidity sensor
S*W, SW*	Operation switch
SA*, F1S	Surge arrestor
SR*, WLU	Signal receiver
SS*	Selector switch

12 About the system

SHEET METAL	Terminal strip fixed plate	X*	Terminal
T*R	Transformer	X*M	Terminal strip (block)
TC, TRC	Transmitter	Y*E	Electronic expansion valve coil
V*, R*V	Varistor	Y*R, Y*S	Reversing solenoid valve coil
V*R	Diode bridge	Z*C	Ferrite core
WRC	Wireless remote controller	ZF, Z*F	Noise filter

For the user

12 About the system

The indoor unit of this split system air conditioner can be used for heating/cooling applications.

NOTICE

Do NOT use the system for other purposes. In order to avoid any quality deterioration, do NOT use the unit for cooling precision instruments, food, plants, animals, or works of art.

NOTICE

For future modifications or expansions of your system:

A full overview of allowable combinations (for future system extensions) is available in technical engineering data and should be consulted. Contact your installer to receive more information and professional advice.

12.1 System layout

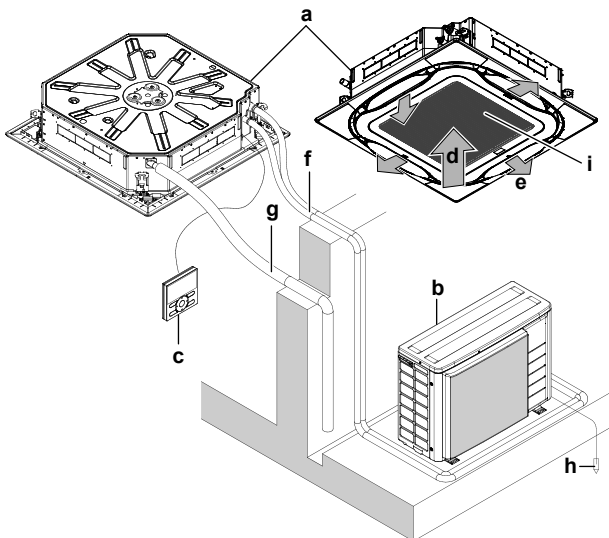

- a Indoor unit
- b Outdoor unit
- c User interface
- d Suction air
- e Discharge air
- f Refrigerant piping + interconnection cable
- g Drain pipe
- h Earth wiring
- i Suction grille and air filter

12.2 Information requirements for fan coil units

Item	Symbol	Value	Unit
Cooling capacity (sensible)	$P_{rated,c}$	A	kW

Item	Symbol	Value	Unit
Cooling capacity (latent)	$P_{rated,c}$	B	kW
Heating capacity	$P_{rated,h}$	C	kW
Total electric power input	P_{elec}	D	kW
Sound power level (per speed setting, if applicable)	L_{WA}	E	dB

Contact details:

DAIKIN INDUSTRIES CZECH REPUBLIC s.r.o. U Nové Hospody 1/1155, 301 00 Plzeň Skvrňany, Czech Republic

	A	B	C	D	E
FXFQ20	1.8	0.4	2.5	0.038	49
FXFQ25	2.1	0.7	3.2	0.038	49
FXFQ32	2.8	0.8	4	0.038	49
FXFQ40	3.4	1.1	5	0.038	51
FXFQ50	4.1	1.5	6.3	0.053	51
FXFQ63	5.2	1.9	8	0.061	53
FXFQ80	6.5	2.5	10	0.092	55
FXFQ100	7.8	3.4	12.5	0.115	60
FXFQ125	9.8	4.2	16	0.186	61

13 User interface

CAUTION

- NEVER touch the internal parts of the controller.
- Do NOT remove the front panel. Some parts inside are dangerous to touch and appliance problems may happen. For checking and adjusting the internal parts, contact your dealer.

This operation manual will give a non-exhaustive overview of the main functions of the system.

For more information about the user interface, see the operation manual of the installed user interface.

14 Before operation

WARNING

This unit contains electrical and hot parts.

WARNING

Before operating the unit, be sure the installation has been carried out correctly by an installer.

CAUTION

It is not good for your health to expose your body to the air flow for a long time.

**CAUTION**

To avoid oxygen deficiency, ventilate the room sufficiently if equipment with burner is used together with the system.

**CAUTION**

Do NOT operate the system when using a room fumigation-type insecticide. Chemicals could collect in the unit, and endanger the health of people who are hypersensitive to chemicals.

**NOTICE**

Be sure to turn on the power 6 hours before operation in order to have power running to the crankcase heater and to protect the compressor.

This operation manual is for the following systems with standard control. Before initiating operation, contact your dealer for the operation that corresponds to your system type and mark. If your installation has a customised control system, ask your dealer for the operation that corresponds to your system.

Operation modes:

- Heating and cooling (air to air).
- Fan only operation (air to air).

15 Operation

15.1 Operating the system

15.1.1 About operating the system

- To protect the unit, turn on the main power switch 6 hours before operation.
- If the main power supply is turned off during operation, operation will restart automatically after the power turns back on again.

15.1.2 About cooling, heating, fan only, and automatic operation

- The air flow rate may adjust itself depending on the room temperature or the fan may stop immediately. This is not a malfunction.

15.1.3 About the heating operation

It may take longer to reach the set temperature for general heating operation than for cooling operation.

The following operation is performed in order to prevent the heating capacity from dropping or cold air from blowing.

Defrost operation

In heating operation, freezing of the outdoor unit's air cooled coil increases over time, restricting the energy transfer to the outdoor unit's coil. Heating capability decreases and the system needs to go into defrost operation to be able to remove frost from the outdoor unit's coil. During defrost operation the heating capacity on the indoor unit side will temporarily drop until defrosting is completed. After defrosting, the unit will regain its full heating capacity.

The indoor unit will stop fan operation, the refrigerant cycle will reverse and energy from inside the building will be used to defrost the outdoor unit coil.

The indoor unit will indicate defrost operation on the display

Hot start

In order to prevent cold air from blowing out of an indoor unit at the start of heating operation, the indoor fan is automatically stopped. The display of the user interface shows

**INFORMATION**

- The heating capacity drops when the outside temperature falls. If this happens, use another heating device together with the unit. (When using together with appliances that produce open fire, ventilate the room constantly). Do not place appliances that produce open fire in places exposed to the air flow from the unit or under the unit.
- It takes some time to heat up the room from the time the unit is started since the unit uses a hot-air circulating system to heat the entire room.
- If the hot air rises to the ceiling, leaving the area above the floor cold, we recommend that you use the circulator (the indoor fan for circulating air). Contact your dealer for details.

15.1.4 To operate the system

- 1 Press the operation mode selector button on the user interface several times and select the operation mode of your choice.

Cooling operation

Heating operation

Fan only operation

- 2 Press the ON/OFF button on the user interface.

Result: The operation lamp lights up and the system starts operating.

15.2 Using the dry program

15.2.1 About the dry program

- The function of this program is to decrease the humidity in your room with minimal temperature decrease (minimal room cooling).
- The micro computer automatically determines temperature and fan speed (cannot be set by the user interface).
- The system does not go into operation if the room temperature is low (<20°C).

15.2.2 To use the dry program

To start

- 1 Press the operation mode selector button on the user interface several times and select

- 2 Press the ON/OFF button of the user interface.

Result: The operation lamp lights up and the system starts operating.

To stop

- 3 Press the ON/OFF button on the user interface once again.

Result: The operation lamp goes out and the system stops operating.

**NOTICE**

Do not turn off power immediately after the unit stops, but wait for at least 5 minutes.

16 Energy saving and optimum operation

15.3 Adjusting the air flow direction

Refer to the operation manual of the user interface.

15.3.1 About the air flow flap

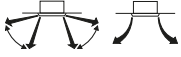

Double flow+multi-flow units

For the following conditions, a micro computer controls the air flow direction which may be different from the display.

Cooling	Heating
<ul style="list-style-type: none"> When the room temperature is lower than the set temperature. 	<ul style="list-style-type: none"> When starting operation. When the room temperature is higher than the set temperature. At defrost operation.
<ul style="list-style-type: none"> When operating continuously at horizontal air flow direction. When continuous operation with downward air flow is performed at the time of cooling with a ceiling-suspended or a wall-mounted unit, the micro computer may control the flow direction, and then the user interface indication will also change. 	

The air flow direction can be adjusted in one of the following ways:

- The air flow flap itself adjusts its position.
- The air flow direction can be fixed by the user.
- Automatic and desired position

WARNING

Never touch the air outlet or the horizontal blades while the swing flap is in operation. Fingers may become caught or the unit may break down.

NOTICE

- The movable limit of the flap is changeable. Contact your dealer for details. (only for double-flow, multi-flow, corner, ceiling-suspended and wall-mounted).
- Avoid operating in the horizontal direction . It may cause dew or dust to settle on the ceiling or flap.

15.4 Active circulation airflow

Use active circulation airflow to heat or cool the room more quickly.

15.4.1 To start the active circulation airflow

- Set the active circulation airflow

1	Go to the home screen.	
2	Press.	
3	Select Circulation airflow	

4	Choose enable and confirm.	
5	Confirm setting.	
6	Go to the home screen.	
7	Check if Air Volume/direction is set to automatic. If not set to automatic.	

- Turn on the unit by the user interface.

16 Energy saving and optimum operation

Observe the following precautions to ensure the system operates properly.

- Adjust the air outlet properly and avoid direct air flow to room inhabitants.
- Adjust the room temperature properly for a comfortable environment. Avoid excessive heating or cooling.
- Prevent direct sunlight from entering a room during cooling operation by using curtains or blinds.
- Ventilate often. Extended use requires special attention to ventilation.
- Keep doors and windows closed. If the doors and windows remain open, air will flow out of your room causing a decrease in the cooling or heating effect.
- Be careful NOT to cool or heat too much. To save energy, keep the temperature setting at a moderate level.
- NEVER place objects near the air inlet or the air outlet of the unit. Doing so may cause a reduced heating/cooling effect or stop operation.
- Turn off the main power supply switch to the unit when the unit is NOT used for longer periods of time. If the main power supply switch is on, the unit consumes electricity. Before restarting the unit, turn on the main power supply switch 6 hours before operation to ensure smooth running.
- When the display shows (time to clean the air filter), clean the filters (see "17.2.1 To clean the air filter" on page 25).
- Keep the indoor unit and user interface at least 1 m away from televisions, radios, stereos, and other similar equipment. Failing to do so may cause static or distorted pictures.
- Do NOT place items under the indoor unit, as they may be damaged by water.
- Condensation may form if the humidity is above 80% or if the drain outlet gets blocked.

17 Maintenance and service

17.1 Precautions for maintenance and service



CAUTION: Pay attention to the fan!

It is dangerous to inspect the unit while the fan is running.

Be sure to turn off the main switch before executing any maintenance task.



CAUTION

Do NOT insert fingers, rods or other objects into the air inlet or outlet. When the fan is rotating at high speed, it will cause injury.



NOTICE

Never inspect or service the unit by yourself. Ask a qualified service person to perform this work. However, as end user, you may clean the air filter, suction grille, air outlet and outside panels.



WARNING

Never replace a fuse with a fuse of a wrong ampere ratings or other wires when a fuse blows out. Use of wire or copper wire may cause the unit to break down or cause a fire.



CAUTION

After a long use, check the unit stand and fitting for damage. If damaged, the unit may fall and result in injury.



NOTICE

Do NOT wipe the controller operation panel with benzine, thinner, chemical dust cloth, etc. The panel may get discoloured or the coating peeled off. If it is heavily dirty, soak a cloth in water-diluted neutral detergent, squeeze it well and wipe the panel clean. Wipe it with another dry cloth.



CAUTION

Before accessing terminal devices, make sure to interrupt all power supply.



NOTICE

When cleaning the heat exchanger, make sure to remove the switch box, fan motor, drain pump and float switch. Water or detergent might deteriorate the insulation of electronic components and result in burnout of these components.

17.2 Cleaning the air filter, suction grille, air outlet and outside panels



CAUTION

Turn off the unit before cleaning the air filter, suction grille, air outlet and outside panels.

17.2.1 To clean the air filter

When to clean the air filter:

- Rule of thumb: Clean every 6 months. If the air in the room is extremely contaminated, increase the cleaning frequency.
- Depending on the settings, the user interface can display the **TIME TO CLEAN AIR FILTER** notification. Clean the air filter when the notification is displayed.

- If the dirt becomes impossible to clean, change the air filter (= optional equipment).

How to clean the air filter:



NOTICE

Do NOT use water of 50°C or higher. **Possible consequence:** Discoloration and deformation.

- 1 Open the suction grille.

Standard panel:

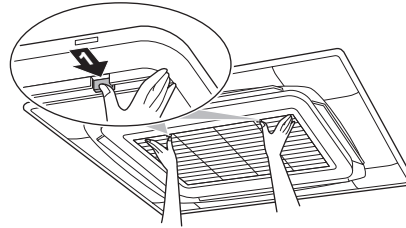

Design panel:

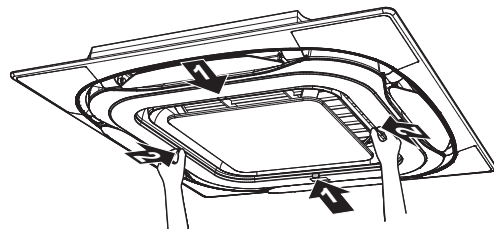

- 2 Remove the air filter.

Standard panel:

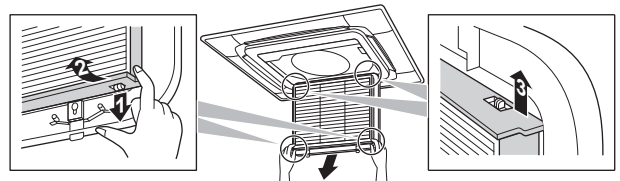

Design panel:

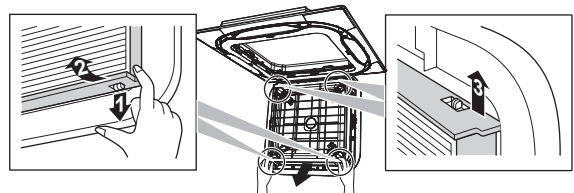

- 3 Clean the air filter. Use a vacuum cleaner or wash with water. If the air filter is very dirty, use a soft brush and neutral detergent.

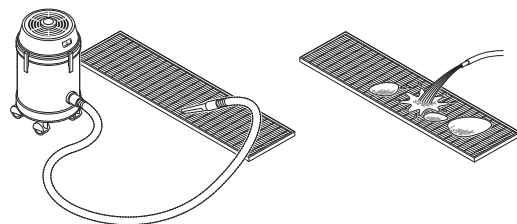

- 4 Dry the air filter in the shadow.
- 5 Reattach the air filter and close the suction grille.
- 6 Turn ON the power.
- 7 Press the **FILTER SIGN RESET** button.

Result: The **TIME TO CLEAN AIR FILTER** notification disappears from the user interface.

17 Maintenance and service

17.2.2 To clean the suction grille

NOTICE

Do NOT use water of 50°C or higher. **Possible consequence:** Discoloration and deformation.

- 1 Open the suction grille.

Standard panel:

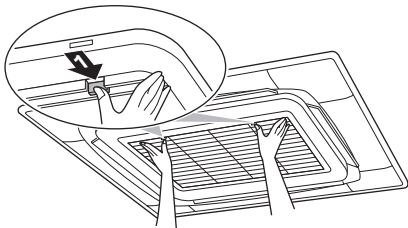

Design panel:

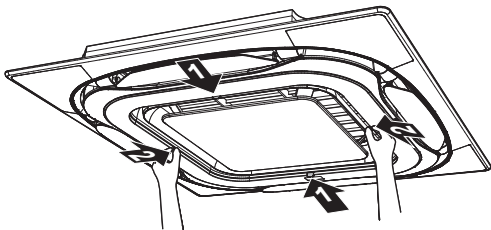

- 2 Remove the suction grille.

Standard panel:

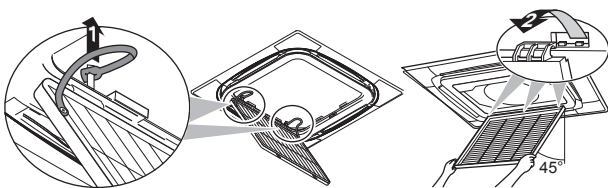

Design panel:

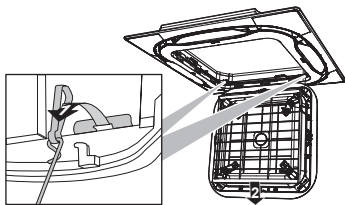

- 3 Remove the air filter.

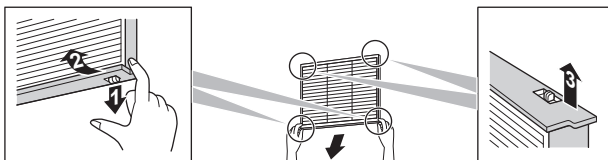

- 4 Clean the suction grille. Wash with a soft bristle brush, and water or neutral detergent. If the suction grille is very dirty, use a typical kitchen cleaner, leave it on for 10 min, then wash it with water.
- 5 Reattach the air filter and suction grille, and close the suction grille.

17.2.3 To clean the air outlet and outside panels

WARNING

Do NOT let the indoor unit get wet. **Possible consequence:** Electric shock or fire.

NOTICE

- Do NOT use gasoline, benzene, thinner polishing powder or liquid insecticide. **Possible consequence:** Discoloration and deformation.
- Do NOT use water or air of 50°C or higher. **Possible consequence:** Discoloration and deformation.
- Do NOT scrub firmly when washing the blade with water. **Possible consequence:** The surface sealing peels off.

Clean with a soft cloth. If it is difficult to remove stains, use water or neutral detergent.

17.3 Maintenance after a long stop period

E.g., at the beginning of the season.

- Check and remove everything that might be blocking inlet and outlet vents of indoor units and outdoor units.
- Clean air filters and casings of indoor units (see "17.2.1 To clean the air filter" on page 25 and "17.2.3 To clean the air outlet and outside panels" on page 26).
- Turn on the power at least 6 hours before operating the unit in order to ensure smoother operation. As soon as the power is turned on, the user interface display appears.

17.4 Maintenance before a long stop period

E.g., at the end of the season.

- Let the indoor units run in fan only operation for about half a day in order to dry the interior of the units. Refer to "15.1.2 About cooling, heating, fan only, and automatic operation" on page 23 for details on fan only operation.
- Turn off the power. The user interface display disappears.
- Clean air filters and casings of indoor units (see "17.2.1 To clean the air filter" on page 25 and "17.2.3 To clean the air outlet and outside panels" on page 26).

17.5 About the refrigerant

This product contains fluorinated greenhouse gases. Do NOT vent gases into the atmosphere.

Refrigerant type: R410A

Global warming potential (GWP) value: 2087.5

NOTICE

Applicable legislation on **fluorinated greenhouse gases** requires that the refrigerant charge of the unit is indicated both in weight and CO₂ equivalent.

Formula to calculate the quantity in CO₂ equivalent tonnes: GWP value of the refrigerant × total refrigerant charge [in kg] / 1000

Please contact your installer for more information.

WARNING

The refrigerant in the system is safe and normally does not leak. If the refrigerant leaks in the room, contact with a fire of a burner, a heater or a cooker may result in a harmful gas.

Turn off any combustible heating devices, ventilate the room and contact the dealer where you purchased the unit.

Do not use the system until a service person confirms that the portion where the refrigerant leaks is repaired.

17.6 After-sales service and warranty

17.6.1 Warranty period

- This product includes a warranty card that was filled in by the dealer at the time of installation. The completed card has to be checked by the customer and stored carefully.
- If repairs to the product are necessary within the warranty period, contact your dealer and keep the warranty card at hand.

17.6.2 Recommended maintenance and inspection

Since dust collects when using the unit for several years, performance of the unit will deteriorate to some extent. As taking apart and cleaning interiors of units requires technical expertise and in order to ensure the best possible maintenance of your units, we recommend to enter into a maintenance and inspection contract on top of normal maintenance activities. Our network of dealers has access to a permanent stock of essential components in order to keep your unit in operation as long as possible. Contact your dealer for more information.

When asking your dealer for an intervention, always state:

- The complete model name of the unit.
- The manufacturing number (stated on the nameplate of the unit).
- The installation date.
- The symptoms or malfunction, and details of the defect.



WARNING

- Do not modify, disassemble, remove, reinstall or repair the unit yourself as incorrect dismantling or installation may cause an electric shock or fire. Contact your dealer.
- In case of accidental refrigerant leaks, make sure there are no naked flames. The refrigerant itself is entirely safe, non-toxic and non-combustible, but it will generate toxic gas when it accidentally leaks into a room where combustible air from fan heaters, gas cookers, etc. is present. Always have qualified service personnel confirm that the point of leakage has been repaired or corrected before resuming operation.

17.6.3 Recommended maintenance and inspection cycles

Be aware that the mentioned maintenance and replacement cycles do not relate to the warranty period of the components.

Component	Inspection cycle	Maintenance cycle (replacements and/or repairs)
Electric motor	1 year	20,000 hours
PCB		25,000 hours
Heat exchanger		5 years
Sensor (thermistor, etc.)		5 years
User interface and switches		25,000 hours
Drain pan		8 years
Expansion valve		20,000 hours
Solenoid valve		20,000 hours

The table assumes the following conditions of use:

- Normal use without frequent starting and stopping of the unit. Depending on the model, we recommend not starting and stopping the machine more than 6 times/hour.

- Operation of the unit is assumed to be 10 hours/day and 2,500 hours/year.



NOTICE

- The table indicates main components. Refer to your maintenance and inspection contract for more details.
- The table indicates recommended intervals of maintenance cycles. However, in order to keep the unit operational as long as possible, maintenance work may be required sooner. Recommended intervals can be used for appropriate maintenance design in terms of budgeting maintenance and inspection fees. Depending on the content of the maintenance and inspection contract, inspection and maintenance cycles may in reality be shorter than listed.

17.6.4 Shortened maintenance and replacement cycles

Shortening of "maintenance cycle" and "replacement cycle" needs to be considered in following situations:

The unit is used in locations where:

- Heat and humidity fluctuate out of the ordinary.
- Power fluctuation is high (voltage, frequency, wave distortion, etc.) (the unit cannot be used if power fluctuation is outside the allowable range).
- Bumps and vibrations are frequent.
- Dust, salt, harmful gas or oil mist such as sulphurous acid and hydrogen sulfide may be present in the air.
- The machine is started and stopped frequently or operation time is long (sites with 24 hour air-conditioning).

Recommended replacement cycle of wear parts

Component	Inspection cycle	Maintenance cycle (replacements and/or repairs)
Air filter	1 year	5 years
High efficiency filter		1 year
Fuse		10 years
Pressure containing parts		In case of corrosion, contact your local dealer.



NOTICE

- The table indicates main components. Refer to your maintenance and inspection contract for more details.
- The table indicates recommended intervals of replacement cycles. However, in order to keep the unit operational as long as possible, maintenance work may be required sooner. Recommended intervals can be used for appropriate maintenance design in terms of budgeting maintenance and inspection fees. Contact your dealer for details.



INFORMATION

Damage due to taking apart or cleaning interiors of units by anyone other than our authorised dealers may not be included in the warranty.

18 Troubleshooting

If one of the following malfunctions occur, take the measures shown below and contact your dealer.

18 Troubleshooting



WARNING

Stop operation and shut off the power if anything unusual occurs (burning smells etc.).

Leaving the unit running under such circumstances may cause breakage, electric shock or fire. Contact your dealer.

The system MUST be repaired by a qualified service person.

Malfunction	Measure
If a safety device such as a fuse, a breaker or an earth leakage breaker frequently actuates or the ON/OFF switch does NOT properly work.	Turn OFF the main power switch.
If water leaks from the unit.	Stop the operation.
The operation switch does NOT work well.	Turn OFF the power supply.
If the user interface display indicates the unit number, the operation lamp flashes and the malfunction code appears.	Notify your installer and report the malfunction code.

If the system does NOT properly operate except for the above mentioned cases and none of the above mentioned malfunctions is evident, investigate the system according to the following procedures.

Malfunction	Measure
If the system does not operate at all.	<ul style="list-style-type: none"> ▪ Check if there is no power failure. Wait until power is restored. If power failure occurs during operation, the system automatically restarts immediately after power is restored. ▪ Check if no fuse has blown or breaker is activated. Change the fuse or reset the breaker if necessary.
The system operates but cooling or heating is insufficient.	<ul style="list-style-type: none"> ▪ Check if air inlet or outlet of outdoor or indoor unit is not blocked by obstacles. Remove any obstacles and make sure the air can flow freely. ▪ Check if the air filter is not clogged (see "17.2.1 To clean the air filter" on page 25). ▪ Check the temperature setting. ▪ Check the fan speed setting on your user interface. ▪ Check for open doors or windows. Close doors and windows to prevent wind from coming in. ▪ Check if there are too many occupants in the room during cooling operation. Check if the heat source of the room is excessive. ▪ Check if direct sunlight enters the room. Use curtains or blinds. ▪ Check if the air flow angle is proper.

If after checking all above items, it is impossible to fix the problem yourself, contact your installer and state the symptoms, the complete model name of the unit (with manufacturing number if possible) and the installation date (possibly listed on the warranty card).

18.1 Symptoms that are NOT system malfunctions

The following symptoms are NOT system malfunctions:

18.1.1 Symptom: The system does not operate

- The air conditioner does not start immediately after the ON/OFF button on the user interface is pressed. If the operation lamp lights, the system is in normal condition. To prevent overloading of the compressor motor, the air conditioner starts 5 minutes after it is turned ON again in case it was turned OFF just before. The same starting delay occurs after the operation mode selector button was used.
- If "Under Centralized Control" is displayed on the user interface, pressing the operation button causes the display to blink for a few seconds. The blinking display indicates that the user interface cannot be used.
- The system does not start immediately after the power supply is turned on. Wait one minute until the micro computer is prepared for operation.

18.1.2 Symptom: The fan speed does not correspond to the setting

The fan speed does not change even if the fan speed adjustment button is pressed. During heating operation, when the room temperature reaches the set temperature, the outdoor unit goes off and the indoor unit changes to whisper fan speed. This is to prevent cold air blowing directly on occupants of the room. The fan speed will not change if the button is pressed.

18.1.3 Symptom: The fan direction does not correspond to the setting

The fan direction does not correspond with the user interface display. The fan direction does not swing. This is because the unit is being controlled by the micro computer.

18.1.4 Symptom: White mist comes out of a unit (Indoor unit)

- When humidity is high during cooling operation. If the interior of an indoor unit is extremely contaminated, the temperature distribution inside a room becomes uneven. It is necessary to clean the interior of the indoor unit. Ask your dealer for details on cleaning the unit. This operation requires a qualified service person.
- Immediately after the cooling operation stops and if the room temperature and humidity are low. This is because warm refrigerant gas flows back into the indoor unit and generates steam.

18.1.5 Symptom: White mist comes out of a unit (Indoor unit, outdoor unit)

When the system is changed over to heating operation after defrost operation. Moisture generated by defrost becomes steam and is exhausted.

18.1.6 Symptom: The user interface display reads "U4" or "U5" and stops, but then restarts after a few minutes

This is because the user interface is intercepting noise from electric appliances other than the air conditioner. The noise prevents communication between the units, causing them to stop. Operation automatically restarts when the noise ceases.

18.1.7 Symptom: Noise of air conditioners (Indoor unit)

- A "zeen" sound is heard immediately after the power supply is turned on. The electronic expansion valve inside an indoor unit starts working and makes the noise. Its volume will reduce in about one minute.

- A continuous low "shah" sound is heard when the system is in cooling operation or at a stop. When the drain pump is in operation, this noise is heard.
- A "pishi-pishi" squeaking sound is heard when the system stops after heating operation. Expansion and contraction of plastic parts caused by temperature change make this noise.

18.1.8 Symptom: Noise of air conditioners (Indoor unit, outdoor unit)

- A continuous low hissing sound is heard when the system is in cooling or defrost operation. This is the sound of refrigerant gas flowing through both indoor and outdoor units.
- A hissing sound which is heard at the start or immediately after stopping operation or defrost operation. This is the noise of refrigerant caused by flow stop or flow change.

18.1.9 Symptom: Noise of air conditioners (Outdoor unit)

When the tone of operating noise changes. This noise is caused by the change of frequency.

18.1.10 Symptom: Dust comes out of the unit

When the unit is used for the first time in a long time. This is because dust has gotten into the unit.

18.1.11 Symptom: The units can give off odours

The unit can absorb the smell of rooms, furniture, cigarettes, etc., and then emit it again.

18.1.12 Symptom: The outdoor unit fan does not spin

During operation. The speed of the fan is controlled in order to optimise product operation.

18.1.13 Symptom: The display shows "88"

This is the case immediately after the main power supply switch is turned on and means that the user interface is in normal condition. This continues for 1 minute.

18.1.14 Symptom: The compressor in the outdoor unit does not stop after a short heating operation

This is to prevent refrigerant from remaining in the compressor. The unit will stop after 5 to 10 minutes.

19 Relocation

Contact your dealer for removing and reinstalling the total unit. Moving units requires technical expertise.

20 Disposal



NOTICE

Do NOT try to dismantle the system yourself: dismantling of the system, treatment of the refrigerant, oil and other parts MUST comply with applicable legislation. Units MUST be treated at a specialised treatment facility for reuse, recycling and recovery.

21 Glossary

Dealer

Sales distributor for the product.

Authorized installer

Technical skilled person who is qualified to install the product.

User

Person who is owner of the product and/or operates the product.

Applicable legislation

All international, European, national and local directives, laws, regulations and/or codes that are relevant and applicable for a certain product or domain.

Service company

Qualified company which can perform or coordinate the required service to the product.

Installation manual

Instruction manual specified for a certain product or application, explaining how to install, configure and maintain it.

Operation manual

Instruction manual specified for a certain product or application, explaining how to operate it.

Maintenance instructions

Instruction manual specified for a certain product or application, which explains (if relevant) how to install, configure, operate and/or maintain the product or application.

Accessories

Labels, manuals, information sheets and equipment that are delivered with the product and that need to be installed according to the instructions in the accompanying documentation.

Optional equipment

Equipment made or approved by Daikin that can be combined with the product according to the instructions in the accompanying documentation.

Field supply

Equipment NOT made by Daikin that can be combined with the product according to the instructions in the accompanying documentation.

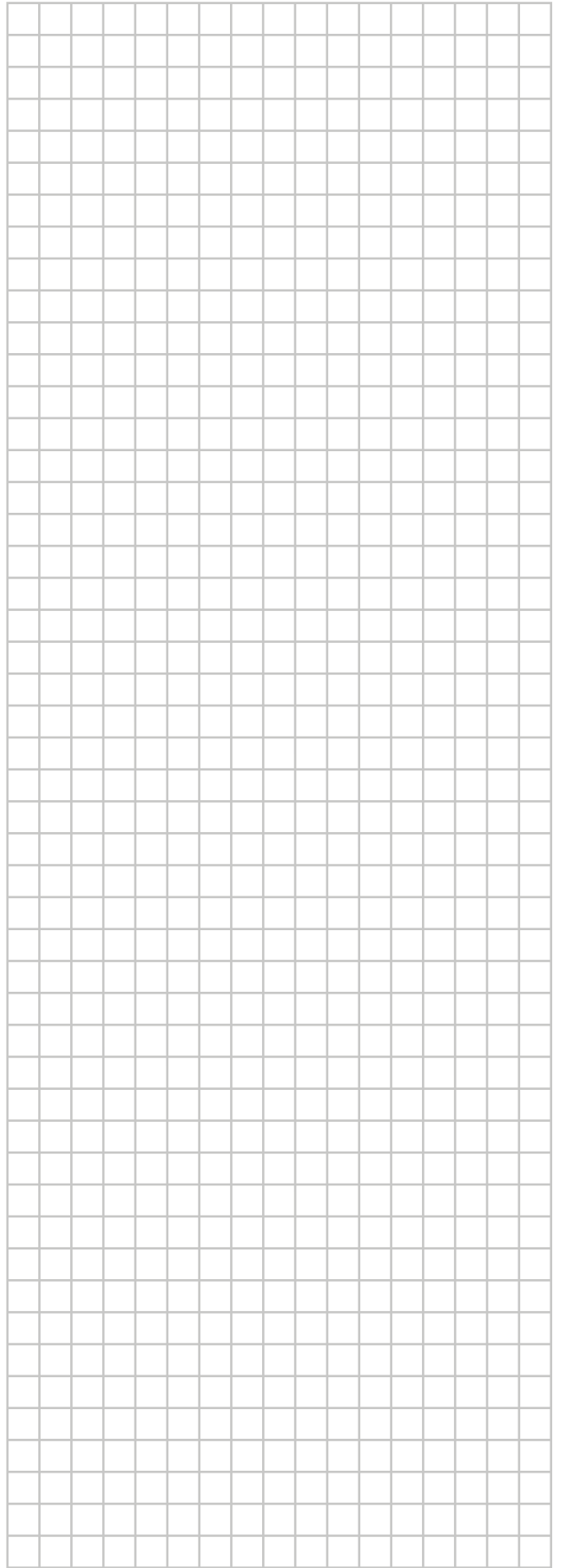
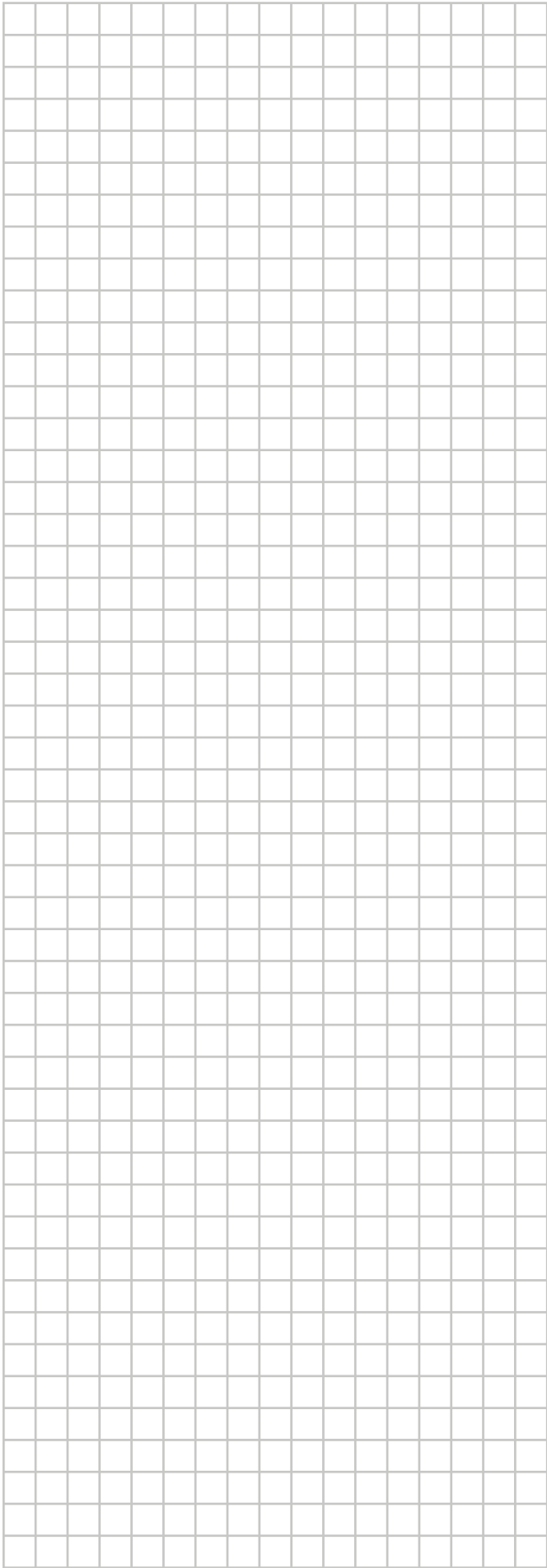



ERC

DAIKIN INDUSTRIES CZECH REPUBLIC s.r.o.
U Nové Hospody 1/1155, 301 00 Plzeň Skvrňany, Czech Republic

DAIKIN EUROPE N.V.
Zandvoordestraat 300, B-8400 Oostende, Belgium

Copyright 2018 Daikin

4P561452-1 2018.12