

DAIKIN



INSTALLATION MANUAL

***VRV III* System air conditioner**

REMQ8P9Y1B
REMQ10P8Y1B
REM(H)Q12P8Y1B
REMQ14P8Y1B
REMQ16P8Y1B

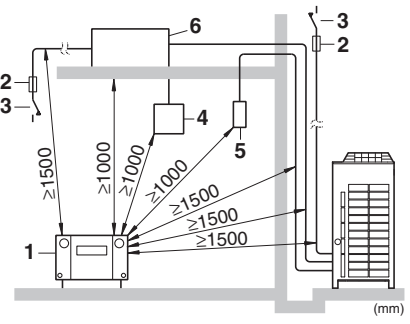
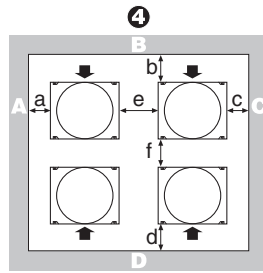
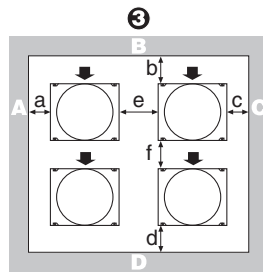
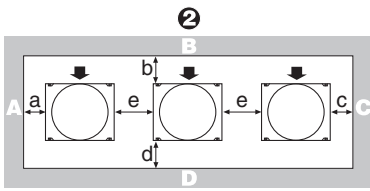
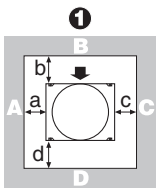

	A+B+C+D		A+B
①	a ≥ 10 mm b ≥ 300 mm c ≥ 10 mm d ≥ 500 mm	a ≥ 50 mm b ≥ 100 mm c ≥ 50 mm d ≥ 500 mm	a ≥ 200 mm b ≥ 300 mm
②	a ≥ 10 mm b ≥ 300 mm c ≥ 10 mm d ≥ 500 mm e ≥ 20 mm	a ≥ 50 mm b ≥ 100 mm c ≥ 50 mm d ≥ 500 mm e ≥ 100 mm	a ≥ 200 mm b ≥ 300 mm e ≥ 400 mm
③	a ≥ 10 mm b ≥ 300 mm c ≥ 10 mm d ≥ 500 mm e ≥ 20 mm f ≥ 600 mm	a ≥ 50 mm b ≥ 100 mm c ≥ 50 mm d ≥ 500 mm e ≥ 100 mm f ≥ 500 mm	
④	a ≥ 10 mm b ≥ 300 mm c ≥ 10 mm d ≥ 300 mm e ≥ 20 mm f ≥ 500 mm	a ≥ 50 mm b ≥ 100 mm c ≥ 50 mm d ≥ 100 mm e ≥ 100 mm f ≥ 500 mm	

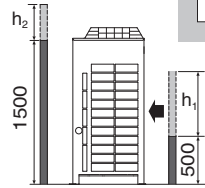

$$h_1 > 0 \rightarrow b \geq b + \frac{h_1}{2}$$

$$h_2 > 0 \rightarrow d \geq d + \frac{h_2}{2}$$

2

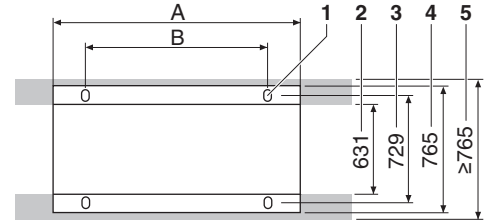

1

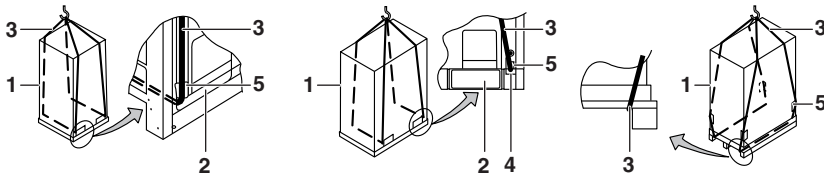

3

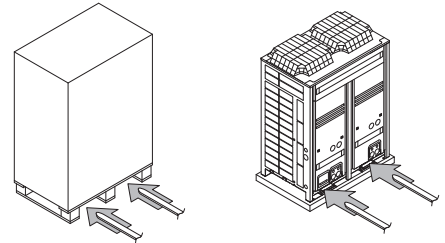

4

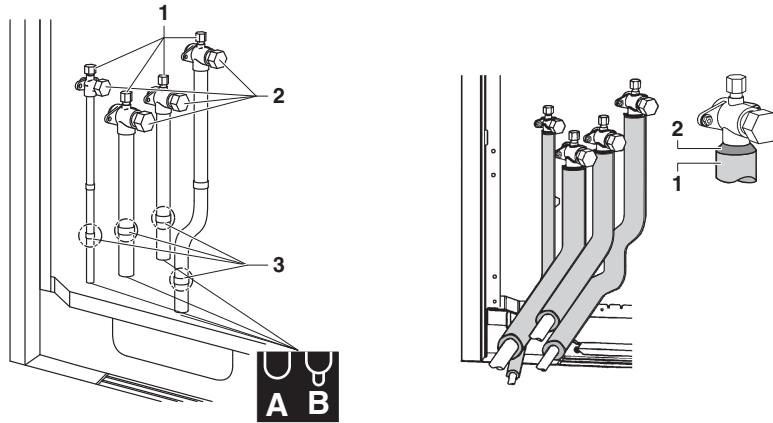

5

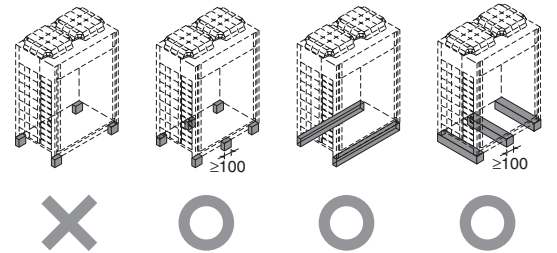

6

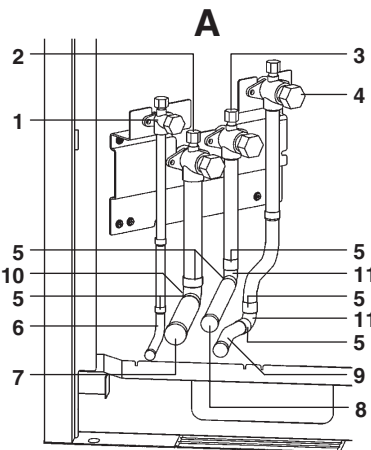

7

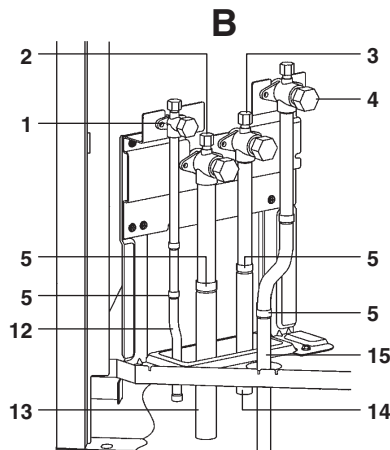

8

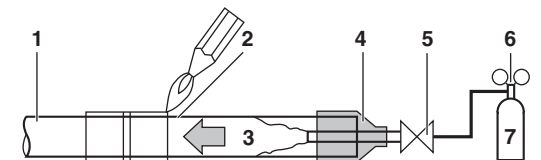

9



11

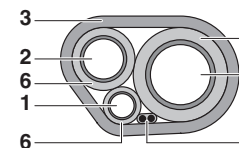

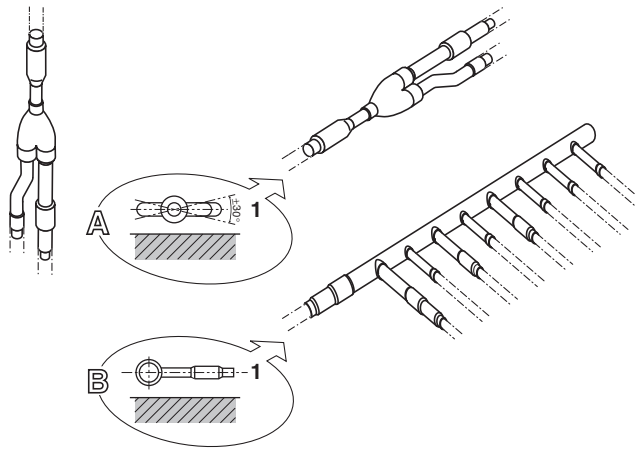

12

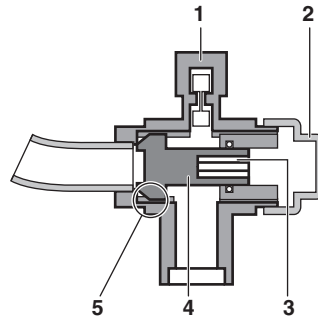

13

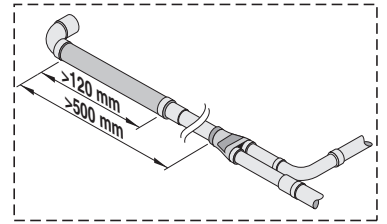
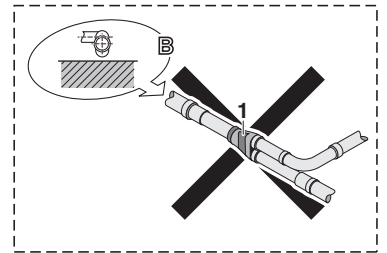
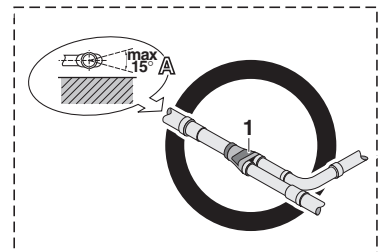

16

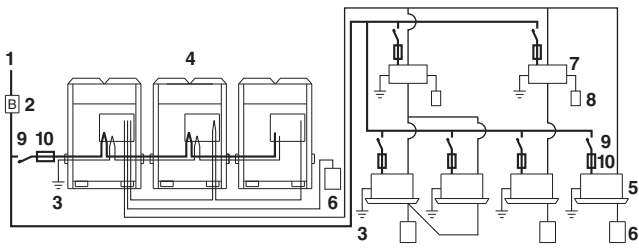

14

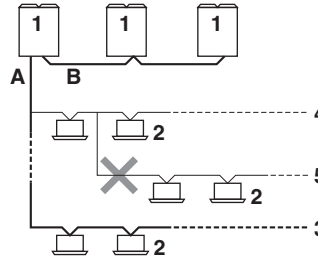

15

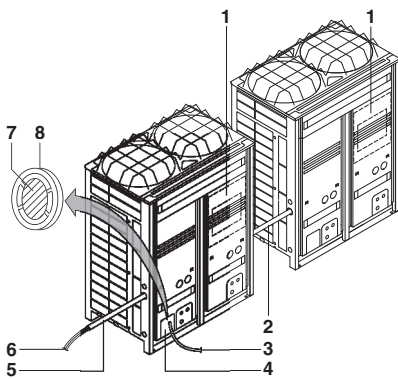

17

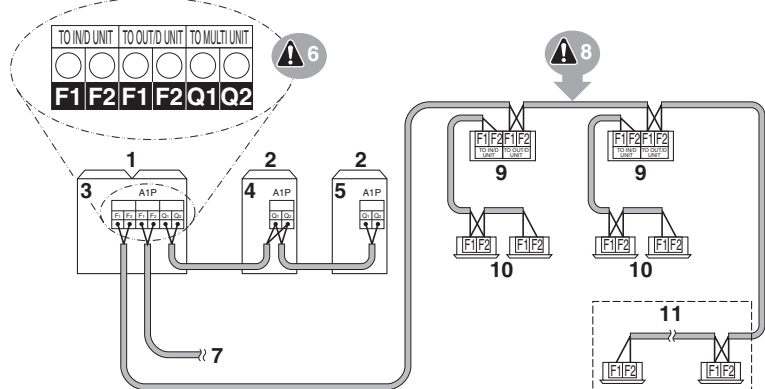

18

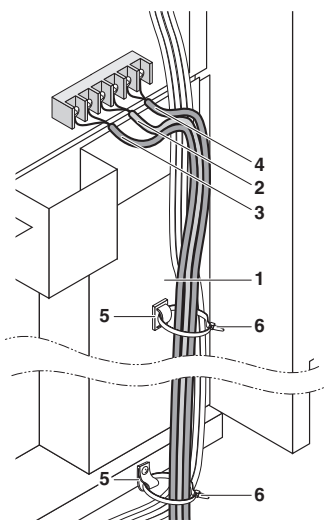

20

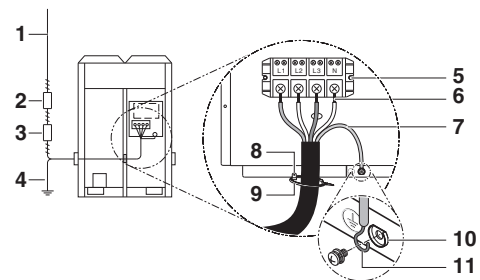

19

REMQ8-12

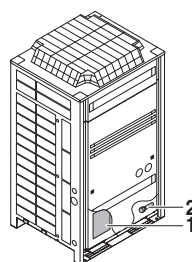

REMQ14+16
REMHQ12

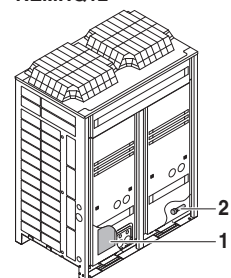

21

CONTENTS

	Page
1. Introduction.....	1
1.1. Combination.....	2
1.2. Standard supplied accessories.....	2
1.3. Optional accessories.....	2
1.4. Technical and Electrical specifications.....	2
2. Main components.....	2
3. Selection of location.....	3
4. Inspecting and handling the unit.....	4
5. Unpacking and placing the unit.....	4
6. Refrigerant piping.....	5
6.1. Installation tools.....	5
6.2. Selection of piping material.....	5
6.3. Pipe connection.....	5
6.4. Connecting the refrigerant piping.....	6
6.5. Protection against contamination when installing pipes.....	8
6.6. Example of connection.....	9
7. Leak test and vacuum drying.....	11
8. Field wiring.....	12
8.1. Internal wiring – Parts table.....	12
8.2. Optional parts connector.....	13
8.3. Power circuit and cable requirements.....	13
8.4. General cautions.....	14
8.5. System examples.....	14
8.6. Leading power line and transmission line.....	15
8.7. Field line connection: transmission wiring.....	15
8.8. Field line connection: power wiring.....	16
8.9. Wiring example for wiring inside unit.....	17
9. Pipe insulation.....	17
10. Checking of unit and installation conditions.....	17
11. Charging refrigerant.....	17
11.1. Important information regarding the refrigerant used.....	17
11.2. Precautions when adding R410A.....	18
11.3. Stop valve operation procedure.....	18
11.4. How to check how many units are connected.....	18
11.5. Additional refrigerant charge.....	19
11.6. Procedure for inputting the additional refrigerant charge weight into the PCB.....	22
11.7. Checks after adding refrigerant.....	23
12. Before operation.....	23
12.1. Service precautions.....	23
12.2. Checks before initial start-up.....	24
12.3. Field setting.....	24
12.4. Test operation.....	26
12.5. Final check after installation.....	27
13. Service mode operation.....	27
14. Additional refrigerant charging method.....	27
15. Caution for refrigerant leaks.....	28
16. Disposal requirements.....	29

 READ THIS MANUAL ATTENTIVELY BEFORE STARTING UP THE UNIT. DO NOT THROW IT AWAY. KEEP IT IN YOUR FILES FOR FUTURE REFERENCE.

IMPROPER INSTALLATION OR ATTACHMENT OF EQUIPMENT OR ACCESSORIES COULD RESULT IN ELECTRIC SHOCK, SHORT-CIRCUIT, LEAKS, FIRE OR OTHER DAMAGE TO THE EQUIPMENT. BE SURE ONLY TO USE ACCESSORIES MADE BY DAIKIN WHICH ARE SPECIFICALLY DESIGNED FOR USE WITH THE EQUIPMENT AND HAVE THEM INSTALLED BY A PROFESSIONAL.

DAIKIN EQUIPMENT IS DESIGNED FOR COMFORT APPLICATIONS. FOR USE IN OTHER APPLICATIONS, PLEASE CONTACT YOUR LOCAL DAIKIN DEALER.

IF UNSURE OF INSTALLATION PROCEDURES OR USE, ALWAYS CONTACT YOUR DEALER FOR ADVICE AND INFORMATION.

THIS AIR CONDITIONER COMES UNDER THE TERM "APPLIANCES NOT ACCESSIBLE TO THE GENERAL PUBLIC".

The English text is the original instruction. Other languages are translations of the original instructions.



The refrigerant charge of the system must be less than 100 kg. This means that in case the calculated refrigerant charge is equal to or more than 95 kg you must divide your multiple outdoor system into smaller independent systems, each containing less than 95 kg refrigerant charge.

For factory charge, refer to the unit name plate.



The refrigerant R410A requires strict cautions for keeping the system clean, dry and tight.

- Clean and dry
Foreign materials (including mineral oils such as SUNISO oil or moisture) should be prevented from getting mixed into the system.

- Tight
R410A does not contain any chlorine, does not destroy the ozone layer and does not reduce the earth's protection against harmful ultraviolet radiation. R410A can contribute slightly to the greenhouse effect if it is released. Therefore we should take special attention to check the tightness of the installation.

Read "6. Refrigerant piping" on page 5 carefully and follow these procedures correctly.



Since design pressure is 4.0 MPa or 40 bar (for R407C units: 3.3 MPa or 33 bar), pipes of larger wall thickness may be required. The wall thickness of piping must be carefully selected, refer to paragraph "6.2. Selection of piping material" on page 5 for more details.

1. INTRODUCTION

This installation manual concerns VRV inverters of the Daikin REY(H)Q-P series. These units are designed for outdoor installation and used for cooling and heat pump applications. The REYQ18~48P system is a multi outdoor system composed of 2 or 3 REMQ8~16P outdoor units with rated cooling capacities ranging from 50.4 to 135 kW and rated heating capacities ranging from 56.5 to 150 kW.

The REYHQ system is a multi outdoor system composed of 2x REMQ8 or 1x REMHQ and 1x REMQ or 2x REMHQ outdoor units with rated cooling capacities ranging from 45 kW to 67 kW and rated heating capacities ranging from 50 kW to 75 kW.

For changing the refrigerant flow to indoor units, the REYQ-P system can be combined with BS units of the types BSVQ100P, BSVQ160P and BSVQ250P only. Other BS unit types will cause malfunctions when combined with the REYQ-P system.

The REM(H)Q-P units can be combined with Daikin VRV indoor units for air conditioning purposes suitable for R410A.

The present installation manual describes the procedures for unpacking, installing and connecting the REM(H)Q-P units. Installation of the indoor units is not described in this manual. Always refer to the installation manual supplied with these units for their installation.

1.1. Combination

The indoor units can be installed in the following range.

- Always use appropriate indoor units compatible with R410A. To learn which models of indoor units are compatible with R410A, refer to the product catalogs.
- Total capacity/quantity of indoor units

Standard combinations of outdoor units	Total capacity of indoor units
REYQ18 = REMQ8+REMQ10	225~585
REYQ20 = REMQ8+REMQ12	250~650
REYQ22 = REMQ10+REMQ12	275~715
REYQ24 = REMQ12+REMQ12	300~780
REYQ26 = REMQ10+REMQ16	325~845
REYQ28 = REMQ12+REMQ16	350~910
REYQ30 = REMQ14+REMQ16	375~975
REYQ32 = REMQ16+REMQ16	400~1040
REYQ34 = REMQ8+REMQ10+REMQ16	425~1105
REYQ36 = REMQ8+REMQ12+REMQ16	450~1170
REYQ38 = REMQ10+REMQ12+REMQ16	475~1235
REYQ40 = REMQ12+REMQ12+REMQ16	500~1300
REYQ42 = REMQ10+REMQ16+REMQ16	525~1365
REYQ44 = REMQ12+REMQ16+REMQ16	550~1430
REYQ46 = REMQ14+REMQ16+REMQ16	575~1495
REYQ48 = REMQ16+REMQ16+REMQ16	600~1560

Standard combinations of outdoor units	Total capacity of indoor units
REYHQ16 = REMQ8+REMQ8	200~520
REYHQ20 = REMQ8+REMHQ12	250~650
REYHQ22 = REMQ10+REMHQ12	275~715
REYHQ24 = REMHQ12+REMHQ12	300~780

NOTE



- When installing a multi outdoor system:
 - with **2** units: **BHFQ23P907** outdoor unit multi connection piping kit is required.
 - with **3** units: **BHFQ23P1357** outdoor unit multi connection piping kit is required.
- There are restrictions on the refrigerant pipe connection order between outdoor units during installation in case of a multiple outdoor unit system. Install according to the following restrictions. The capacities of outdoor units A, B, and C must fulfill the following restriction conditions: **A ≥ B ≥ C**.

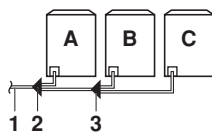

- To indoor units
- Multi outdoor unit connection piping kit (first branch)
- Multi outdoor unit connection piping kit (second branch)

- If the total capacity of the connected indoor units exceeds the capacity of the outdoor unit, cooling and heating performance may drop when running the indoor units. Refer to the section on performance characteristics in the Engineering Data Book for details.

1.2. Standard supplied accessories

See location 1 in figure 21 for reference to where following accessories are supplied with the unit.

Installation manual	1x
Operation manual	1x
Additional refrigerant charge label	1x
Installation information sticker	1x
Fluorinated greenhouse gases label	1x
Multilingual fluorinated greenhouse gases label	1x

See location 2 in figure 21 for reference to where following accessories are supplied with the unit.

Unit type	Suction gas side accessory pipe	HP/LP ^(a) gas side accessory pipe	Equalizer side accessory pipe
8+10	(1) 1x OD 22.2	8~12 (1) 1x OD 19.1	14+16 (1) 1x OD 22.2
	(2) 1x OD 22.2		
12~16	(1) 1x OD 28.6	8~16 (1) 1x OD 19.1	Accessory joint (angle of 90°)
	(2) 1x OD 28.6		
8~16	(1) 1x	8~16 (2) 1x OD 19.1	8~16 (1) 1x Ø25.4
	(2) 1x		

(a) HP/LP = High pressure/low pressure

1.3. Optional accessories

To install the above outdoor units, the following optional parts are also required.

- Refrigerant branching kit (for R410A only: Always use an appropriate kit dedicated for your system.)

Refnet header	
3 pipes	2 pipes
KHRQ23M29H	KHRQ22M29H
KHRQ23M64H	KHRQ22M64H
KHRQ23M75H	KHRQ22M75H

Refnet joint	
3 pipes	2 pipes
KHRQ23M20T	KHRQ22M20T
KHRQ23M29T9	KHRQ22M29T
KHRQ23M64T	KHRQ22M64T
KHRQ23M75T	KHRQ22M75T

- Outdoor unit multi connection piping kit (For R410A only: Always use an appropriate kit dedicated for your system.)

Number of outdoor units connected	
2	3
BHFQ23P907	BHFQ23P1357

To select an optimum refrigerant branching kit, refer to "6. Refrigerant piping" on page 5.

1.4. Technical and Electrical specifications

Refer to the Engineering Data Book for the complete list of specifications.

2. MAIN COMPONENTS

For main components and function of the main components, refer to the Engineering Data Book.

3. SELECTION OF LOCATION

This unit, both indoor and outdoor, is suitable for installation in a commercial and light industrial environment. If installed as a house-hold appliance it could cause electromagnetic interference, in which case the user may be required to take adequate measures.



- Make sure to provide for adequate measures in order to prevent that the outdoor unit be used as a shelter by small animals.
- Small animals making contact with electrical parts can cause malfunctions, smoke or fire. Please instruct the customer to keep the area around the unit clean.

Obtain the customer's permission before installing.

The inverter units should be installed in a location that meets the following requirements:

- 1 The foundation is strong enough to support the weight of the unit and the floor is flat to prevent vibration and noise generation.



If not, the unit may fall over and cause damage or injury.

- 2 The space around the unit is adequate for servicing and the minimum space for air inlet and air outlet is available. (Refer to [figure 1](#) and choose one of the possibilities).

A B C D Sides along the installation site with obstacles

➔ Suction side

- In case of an installation site where sides **A+B+C+D** have obstacles, the wall heights of sides **A+C** have no impact on service space dimensions. Refer to [figure 1](#) for impact of wall heights of sides **B+D** on service space dimensions.
 - In case of an installation site where only the sides **A+B** have obstacles, the wall heights have no influence on any indicated service space dimensions.
 - The installation space required as shown in [figure 1](#) is a reference for cooling operation when the outdoor temperature is 35°C.
If the outdoor temperature exceeds 35°C or the heat load exceeds the maximum capacity of the outdoor unit, increase the distances on the air intake side.
- 3 Make sure that there is no danger of fire due to leakage of inflammable gas.
 - 4 Ensure that water cannot cause any damage to the location in case it drips out the unit (e.g. in case of a blocked drain pipe).
 - 5 The piping length between the outdoor unit and the indoor unit may not exceed the allowable piping length. (Refer to ["6.6. Example of connection"](#) on [page 9](#))
 - 6 Select the location of the unit in such a way that neither the discharged air nor the sound generated by the unit disturbs anyone.
 - 7 Make sure that the air inlet and outlet of the unit are not positioned towards the main wind direction. Frontal wind will disturb the operation of the unit. If necessary, use a windscreen to block the wind.
 - 8 Do not install or operate the unit on locations where air contains high levels of salt, like e.g. in the vicinity of oceans. (Refer for further information to the engineering databook).
 - 9 During installation, avoid the possibility that anybody can climb on the unit or place objects on the unit.
Falls may result in injury.
 - 10 When installing the unit in a small room, take measures in order to keep the refrigerant concentration from exceeding allowable safety limits in the event of a refrigerant leak.



Excessive refrigerant concentrations in a closed room can lead to oxygen deficiency.

- 11 To prevent dripping water to form a puddle underneath the unit, install a drain pan (available as option kit).
- 12 The equipment is not intended for use in a potentially explosive atmosphere.



- The equipment described in this manual may cause electronic noise generated from radio-frequency energy. The equipment complies to specifications that are designed to provide reasonable protection against such interference. However, there is no guarantee that interference will not occur in a particular installation. It is therefore recommended to install the equipment and electric wires keeping proper distances away from stereo equipment, personal computers, etc...
(See [figure 2](#)).

- 1 Personal computer or radio
- 2 Fuse
- 3 Earth leakage breaker
- 4 Remote controller
- 5 Cool/heat selector
- 6 Indoor unit



In places with weak reception, keep distances of 3 m or more to avoid electromagnetic disturbance of other equipment and use conduit tubes for power and transmission lines.

- In heavy snowfall areas, select an installation site where snow will not affect the operation of the unit.
- The refrigerant R410A itself is nontoxic, nonflammable and is safe. If the refrigerant should leak however, its concentration may exceed the allowable limit depending on room size. Due to this, it could be necessary to take measures against leakage. Refer to the chapter ["15. Caution for refrigerant leaks"](#) on [page 28](#).
- Do not install in the following locations.
 - Locations where sulfurous acids and other corrosive gases may be present in the atmosphere. Copper piping and soldered joints may corrode, causing refrigerant to leak.
 - Locations where a mineral oil mist, spray or vapour may be present in the atmosphere. Plastic parts may deteriorate and fall off or cause water leakage.
 - Locations where equipment that produces electromagnetic waves is found. The electromagnetic waves may cause the control system to malfunction, preventing normal operation.
 - Locations where flammable gases may leak, where thinner, gasoline and other volatile substances are handled, or where carbon dust and other incendiary substances are found in the atmosphere. Leaked gas may accumulate around the unit, causing an explosion.
- When installing, take strong winds, typhoons or earthquakes into account. Improper installation may result in the unit turning over.

4. INSPECTING AND HANDLING THE UNIT

At delivery, the packing should be checked and any damage should be reported immediately to the carrier claims agent.

When handling the unit, take into account the following:

- 1  Fragile, handle the unit with care.
- 1  Keep the unit upright in order to avoid compressor damage.
- 2 Choose on beforehand the path along which the unit is to be brought in.
- 3 Bring the unit as close as possible to its final installation position in its original package to prevent damage during transport. (See figure 4)

- 1 Packaging material
- 2 Opening (large)
- 3 Belt sling
- 4 Opening (small) (40x45)
- 5 Protector

- 4 Lift the unit preferably with a crane and 2 belts of at least 8 m long. (See figure 4)

Always use protectors to prevent belt damage and pay attention to the position of the unit's centre of gravity.

NOTE  Use a belt sling of ≤ 20 mm wide that adequately bears the weight of the unit.

- 5 If a forklift is to be used, preferably transport the unit with pallet first, then pass the forklift arms through the large rectangular openings on the bottom of the unit. (See figure 5)
- 5.1 From the moment you use a forklift to move the unit to its final position, lift the unit under the pallet.
- 5.2 Once at final position, unpack the unit and pass the forklift arms through the large rectangular openings on the bottom of the unit.

NOTE  Use filler cloth on the forklift arms to prevent damaging the unit. If the paint on the bottom frame peels off, the anti corrosion effect may decrease.

5. UNPACKING AND PLACING THE UNIT

- Remove the four screws fixing the unit to the pallet.
- Make sure the unit is installed level on a sufficiently strong base to prevent vibration and noise.



Do not use stands to only support the corners. (See figure 8)

- X Not allowed
- O Allowed (units: mm)

- The height of the foundation must at least be 150 mm from the floor.
- The unit must be installed on a solid longitudinal foundation (steelbeam frame or concrete) and make sure the base under the unit is larger than the grey marked area as indicated in figure 3.

- 1 Hole for foundation bolt
- 2 Inner dimension of the base
- 3 Distance between foundation bolt holes
- 4 Depth of unit
- 5 Outer dimension of the base
- A Longitudinal foundation dimension
- B Distance between foundation bolt holes

Model	A	B
REMQ8~12	930	792
REMQ14+16 + REMHQ12	1240	1102

- Fasten the unit in place using four foundation bolts M12. It is best to screw in the foundation bolts until their length remains 20 mm above the foundation surface.

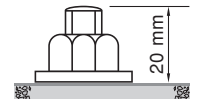

- Prepare a water drainage channel around the foundation to drain waste water from around the unit.
- If the unit is to be installed on a roof, check the strength of the roof and its drainage facilities first.
- If the unit is to be installed on a frame, install the waterproofing board within a distance of 150 mm under the unit in order to prevent infiltration of water coming from under the unit.
- When installed in a corrosive environment, use a nut with plastic washer (1) to protect the nut tightening part from rust.

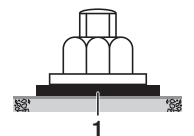

6. REFRIGERANT PIPING



Do not insert fingers, rods or other objects into the air inlet or outlet. When the fan is rotating at high speed, it will cause injury.



Use R410A to add refrigerant.

All field piping must be installed by a licensed refrigeration technician and must comply with relevant local and national regulations.

Caution to be taken when brazing refrigerant piping

Do not use flux when brazing copper-to-copper refrigerant piping. (Particularly for the HFC refrigerant piping) Therefore, use the phosphor copper brazing filler metal (BCuP) which does not require flux.

Flux has extremely harmful influence on refrigerant piping systems. For instance, if the chlorine based flux is used, it will cause pipe corrosion or, in particular, if the flux contains fluorine, it will damage the refrigerant oil.

Be sure to perform a nitrogen blow when brazing. Brazing without releasing nitrogen into the piping will create large quantities of oxidized film on the inside of the pipes, adversely affecting valves and compressors in the refrigerating system and preventing normal operation.

After completing the installation work, check that the refrigerant gas does not leak.

Do not open stop valves until all field wiring is according to the specifications (refer to "8. Field wiring" on page 12), the checking of the unit has been completed and all installation conditions are fulfilled (refer to "10. Checking of unit and installation conditions" on page 17).

Toxic gas may be produced if the refrigerant gas leaks into the room and comes in contact with a source of fire.

Ventilate the area immediately in the event of a leak.

In the event of a leak, do not touch the leaked refrigerant directly. Frostbite may be caused.

6.1. Installation tools

Make sure to use installation tools (gauge manifold charge hose, etc.) that are exclusively used for R410A installations to withstand the pressure and to prevent foreign materials (e.g. mineral oils such as SUNISO and moisture) from mixing into the system.

(The screw specifications differ for R410A and R407C.)

Use a 2-stage vacuum pump with a non-return valve which can evacuate to -100.7 kPa (5 Torr, -755 mm Hg).

NOTE



Make sure the pump oil does not flow oppositely into the system while the pump is not working.

6.2. Selection of piping material

- Foreign materials inside pipes (including oils for fabrication) must be 30 mg/10 m or less.
- Use the following material specification for refrigerant piping:
 - Size: determine the proper size referring to chapter "6.6. Example of connection" on page 9.
 - Construction material: phosphoric acid deoxidized seamless copper for refrigerant.
 - Temper grade: use piping with temper grade in function of the pipe diameter as listed in the table below.

Pipe Ø	Temper grade of piping material
≤15.9	O
≥19.1	1/2H

O = Annealed
1/2H = Half hard

- The pipe thickness of the refrigerant piping should comply with relevant local and national regulations. The minimal pipe thickness for R410A piping must be in accordance with the table below.

Pipe Ø	Minimal thickness t (mm)
6.4	0.80
9.5	0.80
12.7	0.80
15.9	0.99
19.1	0.80

Pipe Ø	Minimal thickness t (mm)
22.2	0.80
28.6	0.99
34.9	1.21
41.3	1.43

- Make sure to use the particular branches of piping that have been selected referring to chapter "6.6. Example of connection" on page 9.
- In case the required pipe sizes (inch sizes) are not available, it is also allowed to use other diameters (mm sizes), taken the following into account:
 - select the pipe size nearest to the required size.
 - use the suitable adapters for the change-over from inch to mm pipes (field supply).

6.3. Pipe connection

Be sure to perform a nitrogen blow when brazing and to read the paragraph "Caution to be taken when brazing refrigerant piping" on page 5 first.

NOTE



The pressure regulator for the nitrogen released when doing the brazing should be set to 0.02 MPa or less. (See figure 10)

- Refrigerant piping
- Location to be brazed
- Nitrogen
- Taping
- Manual valve
- Regulator
- Nitrogen



Do not use anti-oxidants when brazing the pipe joints. Residue can clog pipes and break equipment.

6.4. Connecting the refrigerant piping

1 Front connection or side connection

Installation of refrigerant piping is possible as front connection or side connection (when taken out from the bottom) as shown in the figure.

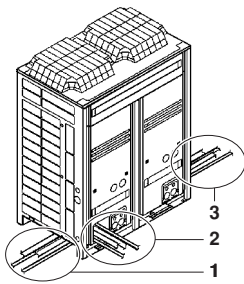

- 1 Left-side connection
- 2 Front connection
- 3 Right-side connection

NOTE



Precautions when knocking out knockout holes

- Be sure to avoid damaging the casing
- After knocking out the knockout holes, we recommend you remove the burrs and paint the edges and areas around the edges using repair paint to prevent rusting.
- When passing electrical wiring through the knockout holes, wrap the wiring with protective tape to prevent damage.

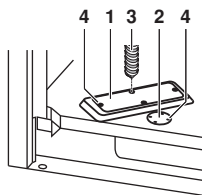

- 1 Large knockout hole
- 2 Small knockout hole
- 3 Drill
- 4 Points for drilling

2 Removing the pinched piping (See figure 6)



Never remove the pinched piping by brazing.

Any gas or oil remaining inside the stop valve may blow off the pinched piping.

Failure to observe the instructions in procedure below properly may result in property damage or personal injury, which may be serious depending on the circumstances.



Use the following procedure to remove the pinched piping:

- 1 Remove the valve lid and make sure that the stop valves are fully closed.



- 2 Connect a charge hose to service ports of all stop valves.
- 3 Recover gas and oil from the pinched piping by using a recovery unit.



Do not vent gases into the atmosphere.

- 4 When all gas and oil is recovered from the pinched piping, disconnect the charge hose and close the service ports.
- 5 In case the pinched piping lower part looks like detail **A** in figure 6, follow instructions as per procedure steps 7+8.

In case the pinched piping lower part looks like detail **B** in figure 6, follow instructions as per procedure steps 6+7+8.

- 6 Cut off the lower part of the smaller pinched piping with an appropriate tool (e.g. a pipe cutter, a pair of nippers, ...) so that a cross-section is open, allowing remaining oil to drip out in case the recovery was not complete. Wait until all oil is dripped out.
- 7 Cut the pinched piping off with a pipe cutter just above the brazing point or just above the marking in case there is no brazing point.



Never remove the pinched piping by brazing.



- 8 Wait until all oil is dripped out in case the recovery was not complete, and only then proceed with connection of the field piping.

See figure 6.

- 1 Service port
- 2 Stop valve
- 3 Point of pipe cutting just above brazing point or above marking
- A Pinched piping
- B Pinched piping



Precautions when connecting field piping.
Add brazing material as shown in the figure.

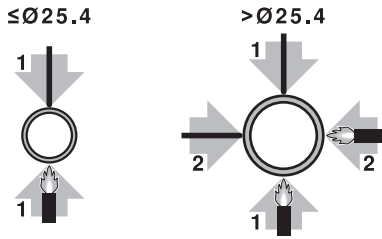

- Be sure to use the supplied accessory pipes when carrying out piping work in the field.
- Be sure that the field installed piping does not touch other pipes, the bottom panel or side panel. Especially for the bottom and side connection, be sure to protect the piping with suitable insulation, to prevent it from coming into contact with the casing.

3 Connecting refrigerant piping to outdoor units

NOTE All local interunit piping are field supplied except the accessory pipes.

- Front connection:**
Remove the stop valve cover to connect. (See figure 9) (A)
- Bottom connection:**
Remove the knockout holes on the bottom frame and route the piping under the bottom frame. (See figure 9) (B)

- Liquid pipe stop valve
- Suction gas pipe stop valve
- High pressure/low pressure gas pipe stop valve
- Equalizer pipe stop valve
- Brazing
- Liquid side accessory pipe (1)
- Suction gas side accessory pipe (1)
- High pressure/low pressure gas side accessory pipe (1)
- Equalizer side accessory pipe (1)
- Accessory joint (angle 90°) (1)
- Accessory joint (angle 90°) (2)
- Liquid side accessory pipe (2)
- Suction gas side accessory pipe (2)
- In case of REMQ8, REMQ10 or REMQ12:
High pressure/low pressure gas side accessory pipe (1)
(This pipe has to be cut at a length of 160 mm)
- In case of REMQ14, REMHQ12, or REMQ16:
High pressure/low pressure gas side accessory pipe (2)
- Equalizer side accessory pipe (2)

- Equalizer pipe:**
The equalizer pipe is used only to establish interconnection of outdoor units in a multi outdoor system.
When the equalizer pipe is used to establish interconnection of 3 outdoor units, refer to the installation manual of the outdoor unit multi connection piping kit.

NOTE Make sure that the onsite piping does not come in contact with other piping, the bottom frame or side panels of the unit.

3.1 Precautions when connecting piping between outdoor units (multiple outdoor unit system)

- To connect the piping between outdoor units, an optional multi connection piping kit BHFQ23P907/1357 is always required. When installing the piping, follow the instructions in the installation manual that comes with the kit.
- Only proceed with piping work after considering the limitations on installing listed here and in the chapter "6.4. Connecting the refrigerant piping" on page 6, always referring to the installation manual delivered with the kit.

3.2 Possible installation patterns and configurations

- The piping between the outdoor units must be routed level or slightly upward to avoid the risk of oil retention into the piping side.

Pattern 1

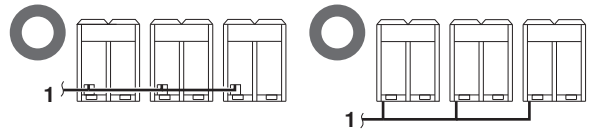

1 To indoor unit

Pattern 2

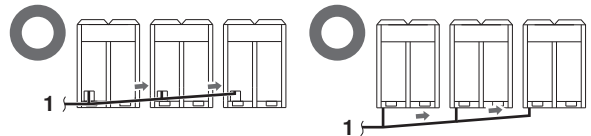

1 To indoor unit

Prohibited patterns: change to pattern 1 or 2.

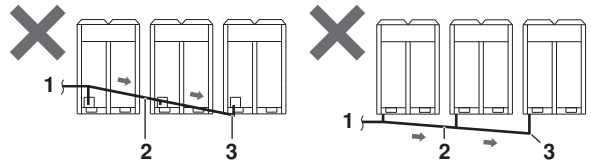

- To indoor unit
- Piping between outdoor units
- Oil remains in piping

- To avoid the risk of oil retention to the outmost outdoor unit, always connect the stop valve and the piping between outdoor units as shown in the 4 correct possibilities of the figure below.

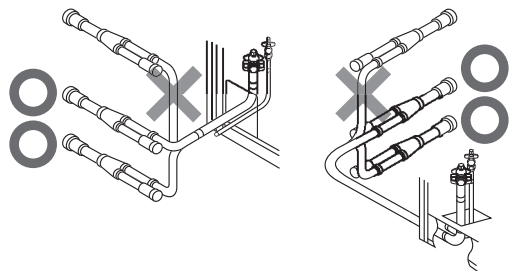

Prohibited patterns: change to pattern 1 or 2.

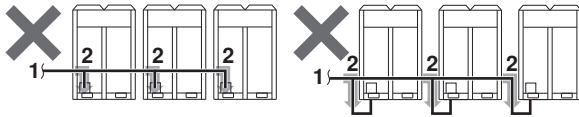

- 1 To indoor unit
- 2 Oil remains in piping

Change to configuration as in figures below

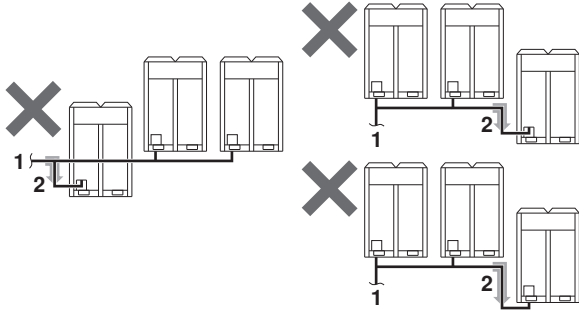

- 1 To indoor unit
- 2 Oil remains in piping when the system stops.

Correct configuration

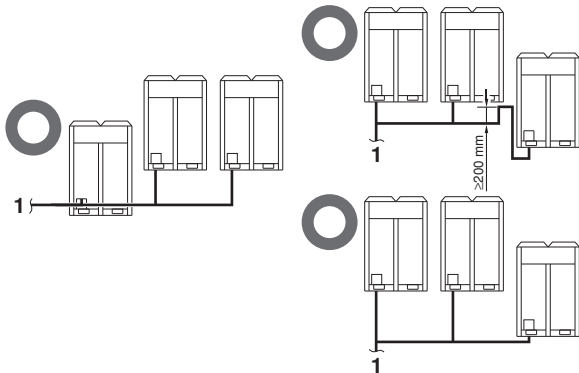

- 1 To indoor unit

- If the piping length between the outdoor units exceeds 2 m, create a rise of 200 mm or more in the suction gas line and high pressure/low pressure gas line within a length of 2 m from the kit.

- If ≤ 2 m

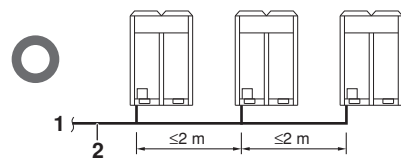

- 1 To indoor unit
- 2 Suction gas and HP/LP gas piping between outdoor units

- If ≥ 2 m

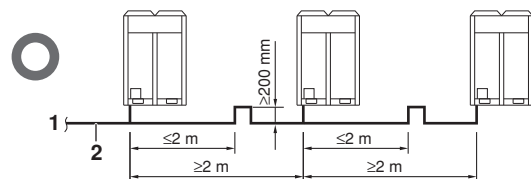

- 1 To indoor unit
- 2 Suction gas and HP/LP gas piping between outdoor units

4 Branching the refrigerant piping

- For installation of the refrigerant branching kit, refer to the installation manual delivered with the kit. (See figure 12)

- 1 Horizontal surface

Follow the conditions listed below:

- Mount the refnet joint so that it branches either horizontally or vertically.
- Mount the refnet header so that it branches horizontally.

- Installation of the multi connection piping kit (See figure 16)

- Install the joints horizontally, so that the caution label (1) attached to the joint comes to the top. Do not tilt the joint more than 15° (see view A). Do not install the joint vertically (see view B).
- Make sure that the total length of the piping connected to the joint is absolute straight for more than 500 mm. Only if a straight field piping of more than 120 mm is connected, more than 500 mm of straight section can be ensured.
- Improper installation may lead to malfunction of the outdoor unit.

5 Piping length restrictions

Make sure to perform the piping installation within the range of the maximum allowable pipe length, allowable level difference and allowable length after branching as indicated in "6.6. Example of connection" on page 9.

6.5. Protection against contamination when installing pipes

- Take measures to prevent foreign materials like moisture and contamination from mixing into the system.

	Installation period	Protection method
🏠	More than a month	Pinch the pipe
	Less than a month	Pinch or tape the pipe
🏠	Regardless of the period	

- Great caution is needed when passing copper tubes through walls.
- Block all gaps in the holes for passing out piping and wiring using sealing material (field supply). (The capacity of the unit will drop and small animals may enter the machine.)

Example: passing piping out through the front

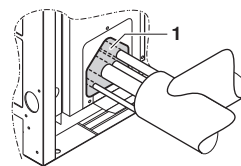

- 1 Plug the areas marked with "1". (When the piping is routed from the front panel.)



After all the piping has been connected, make sure there is no gas leak. Use nitrogen to perform a gas leak check.

6.6. Example of connection

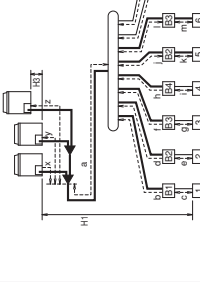
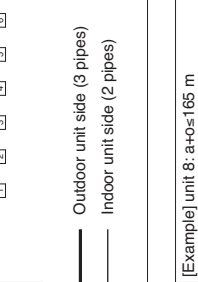
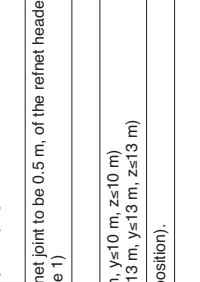
Example of connection (Connection of 8 indoor units)	Branch with refnet joint	Branch with refnet joint and refnet header	Branch with refnet header																									
<p>! Use the outdoor unit multi connection piping kit that is sold separately as an option (BHFQ23P907+1357) for the multi installation of outdoor units. Selection method is as shown in the right table.</p> <p>Outdoor unit side (3 pipes) Suction gas pipe — Gas pipe HP/LP gas pipe — Liquid pipe</p> <p>BS unit</p>	 <p>1 indoor unit refnet joint</p>	 <p>refnet header outdoor multi connection piping kit</p>	 <p>Outdoor unit side (3 pipes) Indoor unit side (2 pipes)</p>																									
<p>Install the joint part (◀ part in the figure) of the outdoor unit multi connection piping kit horizontally with attention to the installation restrictions described in "connecting the refrigerant piping". (* In case of multi combination, interpret the word "outdoor" as "first outdoor branch".</p>	<p>Pipe length between outdoor(*) and indoor units ≤165 m [Example] unit 6: a+b+l≤165 m, unit 8: a+n+p≤165 m</p> <p>Actual pipe length [Example] unit 6: a+b+l≤165 m, unit 8: a+n+p≤165 m</p> <p>Equivalent length Equivalent pipe length between outdoor(*) and indoor units ≤190 m (Assume equivalent pipe length of the refnet joint to be 0.5 m, of the refnet header to be 1.0 m, of the BSVQ100 and BSVQ160 to be 4 m and of the BSVQ250 to be 6 m (for calculation purposes)). (See note 1)</p> <p>Total extension length Total piping length from outdoor(*) to all indoor units ≤1000 m</p> <p>Actual and equivalent pipe length The actual pipe length from the first outdoor unit multi connection piping kit to the outdoor unit ≤10 m. (x≤10 m, y≤10 m, z≤10 m) The equivalent pipe length from the first outdoor unit multi connection piping kit to the outdoor unit ≤13 m. (x≤13 m, y≤13 m, z≤13 m)</p> <p>Allowable height difference Difference in height between outdoor and indoor units (H1)≤50 m (≤40 m if outdoor unit is located in a lower position). Difference in height between adjacent indoor units (H2)≤15 m Difference in height between adjacent outdoor units (H3)≤5 m</p>																											
<p>! Refrigerant branch kits can only be used with R410A.</p>	<p>Actual pipe length [Example] unit 6: b+h≤40 m, unit 8: m+n+p≤40 m</p> <p>How to select the refnet joint When using refnet joints at the first branch counted from the outdoor unit side, choose from the following table in accordance with the capacity of the outdoor unit (example: refnet joint A).</p> <table border="1" data-bbox="997 224 1117 504"> <thead> <tr> <th>Outdoor unit capacity type (Hp)</th> <th>Refrigerant branch kit name</th> </tr> </thead> <tbody> <tr> <td>8+10</td> <td>KHRQ23M29T</td> </tr> <tr> <td>12~22</td> <td>KHRQ23M64T</td> </tr> <tr> <td>≥24</td> <td>KHRQ23M75T</td> </tr> </tbody> </table> <p>For refnet joints other than the first branch, select the proper branch kit model based on the total capacity index of all indoor units connected after the refrigerant branch.</p> <table border="1" data-bbox="1117 224 1236 504"> <thead> <tr> <th rowspan="2">Indoor capacity type</th> <th colspan="2">Refrigerant branch kit name</th> </tr> <tr> <th>3 pipes</th> <th>2 pipes</th> </tr> </thead> <tbody> <tr> <td><200</td> <td>KHRQ23M20T</td> <td>KHRQ22M20T</td> </tr> <tr> <td>200<x<290</td> <td>KHRQ23M29T9</td> <td>KHRQ22M29T</td> </tr> <tr> <td>290<x<640</td> <td>KHRQ23M64T</td> <td>KHRQ22M64T</td> </tr> <tr> <td>≥640</td> <td>KHRQ23M75T</td> <td>KHRQ22M75T</td> </tr> </tbody> </table>			Outdoor unit capacity type (Hp)	Refrigerant branch kit name	8+10	KHRQ23M29T	12~22	KHRQ23M64T	≥24	KHRQ23M75T	Indoor capacity type	Refrigerant branch kit name		3 pipes	2 pipes	<200	KHRQ23M20T	KHRQ22M20T	200<x<290	KHRQ23M29T9	KHRQ22M29T	290<x<640	KHRQ23M64T	KHRQ22M64T	≥640	KHRQ23M75T	KHRQ22M75T
Outdoor unit capacity type (Hp)	Refrigerant branch kit name																											
8+10	KHRQ23M29T																											
12~22	KHRQ23M64T																											
≥24	KHRQ23M75T																											
Indoor capacity type	Refrigerant branch kit name																											
	3 pipes	2 pipes																										
<200	KHRQ23M20T	KHRQ22M20T																										
200<x<290	KHRQ23M29T9	KHRQ22M29T																										
290<x<640	KHRQ23M64T	KHRQ22M64T																										
≥640	KHRQ23M75T	KHRQ22M75T																										
<p>Outdoor unit multi connection piping kit and refrigerant branch kit selection</p>	<p>Pipe length from first refrigerant branch kit (either refnet joint or refnet header) to indoor unit ≤40 m (See note 2) [Example] unit 6: b+h≤40 m, unit 8: m+n+p≤40 m</p> <p>How to choose an outdoor multi connection piping kit (this is required when the system is a multiple outdoor unit system) Choose from the following table in accordance with the number of outdoor units</p> <table border="1" data-bbox="1077 224 1197 504"> <thead> <tr> <th rowspan="2">Number of outdoor units</th> <th colspan="2">Branch kit name</th> </tr> <tr> <th>3 pipes</th> <th>2 pipes</th> </tr> </thead> <tbody> <tr> <td>2</td> <td>BHFQ23P907</td> <td>KHRQ22M29H</td> </tr> <tr> <td>3</td> <td>BHFQ23P1357</td> <td>KHRQ22M29H</td> </tr> <tr> <td></td> <td></td> <td>KHRQ22M64H</td> </tr> <tr> <td></td> <td></td> <td>KHRQ22M75H</td> </tr> </tbody> </table>			Number of outdoor units	Branch kit name		3 pipes	2 pipes	2	BHFQ23P907	KHRQ22M29H	3	BHFQ23P1357	KHRQ22M29H			KHRQ22M64H			KHRQ22M75H								
Number of outdoor units	Branch kit name																											
	3 pipes	2 pipes																										
2	BHFQ23P907	KHRQ22M29H																										
3	BHFQ23P1357	KHRQ22M29H																										
		KHRQ22M64H																										
		KHRQ22M75H																										
<p>Example of downstream indoor units</p>	<p>Example of downstream indoor units in case of refnet joint C: indoor units 5+6+7+8 in case of refnet joint B: indoor units 7+8 in case of refnet header: indoor units 1+2+3+4+5+6+7+8</p>																											

Pipe size selection

For an outdoor unit multi installation (REYQ18~48P + REYHQ16~24), select the pipe size in accordance with the following figure.

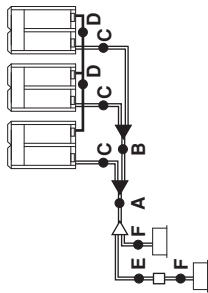

A. Piping between outdoor unit and refrigerant branch kit

Choose from the following table in accordance with the outdoor unit total capacity type, connected downstream.

Outdoor unit capacity type (Hp)	Piping outer diameter size (mm)		
	Suction gas pipe	HP/LP gas pipe	Liquid pipe
8	19.1	15.9	9.5
10	22.2	19.1	9.5
12	28.6	19.1	12.7
14+16	28.6	22.2	12.7
18	28.6	22.2	15.9
20+22	28.6	28.6	15.9
24	34.9	28.6	15.9
26~34	34.9	28.6	19.1
36	41.3	28.6	19.1
38~48	41.3	34.9	19.1

C. Piping between outdoor unit multi connection piping kit and outdoor unit

Choose from the following table in accordance with the capacity type of the connected outdoor unit.

Outdoor unit capacity type (Hp)	Piping outer diameter size (mm)		
	Suction gas pipe	HP/LP gas pipe	Liquid pipe
8+10	22.2	19.1	9.5
12	28.6	19.1	12.7
14+16	28.6	22.2	12.7

E. Piping between refrigerant branch kit and BS unit

Pipe size for direct connection to indoor unit must be the same as the connection size of indoor unit. Choose from the following table in accordance with the indoor unit total capacity type, connected downstream.

Indoor unit capacity type	Piping outer diameter size (mm)		
	Suction gas pipe	HP/LP gas pipe	Liquid pipe
<150	15.9	12.7	9.5
150≤x<200	19.1	15.9	9.5
200≤x<290	22.2	19.1	9.5
290≤x<420	28.6	19.1	12.7
420≤x<640	28.6	28.6	15.9
640≤x<920	34.9	28.6	19.1
≥920	41.3	28.6	19.1

F. Piping between refrigerant branch kit or BS unit and indoor unit

Choose from the following table in accordance with the capacity type of the connected indoor unit.

Indoor unit capacity type	Piping outer diameter size (mm)		
	Suction gas pipe	HP/LP gas pipe	Liquid pipe
20, 25, 32, 40, 50	12.7		6.4
63, 80, 100, 125	15.9		9.5
200	19.1		9.5
250	22.2		9.5

D. Equalizer piping (outdoor units only)

Piping outer diameter size (mm) 19.1

How to calculate the additional refrigerant to be charged
Additional refrigerant to be charged R (kg)
R should be rounded off in units of 0.1 kg

The refrigerant charge of the system must be less than 100 kg. This means that in case the calculated refrigerant charge is equal to or more than 95 kg you must divide your multiple outdoor system into smaller independent systems, each containing less than 95 kg refrigerant charge.
For factory charge, refer to the unit name plate.

$$R = \left[\left[(X1 \times 0.222) \times 0.37 \right] + \left[(X2 \times 0.191) \times 0.26 \right] + \left[(X3 \times 0.159) \times 0.18 \right] + \left[(X4 \times 0.127) \times 0.12 \right] + \left[(X5 \times 0.095) \times 0.059 \right] + \left[(X6 \times 0.064) \times 0.022 \right] \right] \times 1.02 + A + B$$

X₁₋₆ = Total length (m) of liquid piping size at Øa

A = Weight according to table A

B = Weight according to table B in function of indoor unit connection ratio



REYHQ	A
18+20 Hp	1.0 kg
22+24 Hp	1.5 kg
26 Hp	2.0 kg
28+30 Hp	2.5 kg
32+40 Hp	3.0 kg
42 Hp	3.5 kg
44+46 Hp	4.0 kg
48 Hp	4.5 kg
REYHQ	A
16 Hp	1.0 kg
20 Hp	1.5 kg
22+24 Hp	2.0 kg

REYHQ	B
16~32 Hp	>100% 0.5 kg ≤130%
>100%	>100% 0.5 kg ≤120%
34~48 Hp	>120% 1.0 kg ≤130%

Example for refrigerant branch using reifnet joint and reifnet header for REYQ34, REYQ34 = REMQ8+REMO10+REMO16, the indoor unit connection ratio = 120% and the piping lengths are as below.

a: Ø19.1x30 m	f: Ø9.5x10 m	k: Ø9.5x20 m	p: Ø6.4x10 m
b: Ø19.1x20 m	g: Ø9.5x10 m	l: Ø9.5x20 m	r: 1.27x3 m
c: Ø9.5x10 m	h: Ø9.5x10 m	m: Ø9.5x20 m	s: Ø9.5x3 m
d: Ø9.5x10 m	i: Ø9.5x10 m	n: Ø9.5x10 m	t: Ø9.5x3 m
e: Ø9.5x10 m	j: Ø9.5x10 m	o: Ø6.4x10 m	u: Ø15.9x1 m

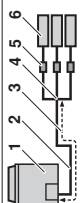
R = [(50x0.26)+(10.18)+(30.12)+(156x0.059)+(20x0.022)]x1.02+3.04+0.5 = 27.148 ⇒ R = 27.1 kg

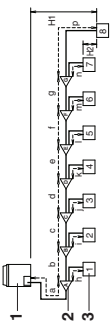
<p>Note 1</p> 	<p>When the equivalent pipe length between outdoor and indoor units is 90 m or more, the size of the main liquid pipe must be increased. Never increase suction gas pipe and HP/LP gas pipe sizes. Depending on the length of the piping, the capacity may drop, but even in such a case it is possible to increase the size of the main liquid pipe.</p>	<table border="1"> <tr> <th>REY(H)Q Ø</th> <th>REV(H)Q Ø</th> </tr> <tr> <td>8+10</td> <td>9.5 → 12.7</td> </tr> <tr> <td>12-16</td> <td>12.7 → 15.9</td> </tr> <tr> <td></td> <td>18-24</td> </tr> <tr> <td></td> <td>15.9 → 19.1</td> </tr> <tr> <td></td> <td>26-48</td> </tr> <tr> <td></td> <td>19.1 → 22.2</td> </tr> </table>	REY(H)Q Ø	REV(H)Q Ø	8+10	9.5 → 12.7	12-16	12.7 → 15.9		18-24		15.9 → 19.1		26-48		19.1 → 22.2	 <p>1 Outdoor unit 2 Main pipes 3 Increase only liquid pipe size 4 First refrigerant branch kit 5 BS unit 6 Indoor unit</p>							
REY(H)Q Ø	REV(H)Q Ø																							
8+10	9.5 → 12.7																							
12-16	12.7 → 15.9																							
	18-24																							
	15.9 → 19.1																							
	26-48																							
	19.1 → 22.2																							
<p>Note 2</p> 	<p>Required conditions</p> <p>Allowable length after the first refrigerant branch kit to indoor units is 40 m or less, however it can be extended up to 90 m if all the following conditions are fulfilled.</p> <p>It is necessary to increase the pipe size of the liquid and suction gas pipe if the pipe length between the first and the final branch kit is over 40 m (reducers must be procured on site). Increasing the HP/LP gas pipe size is not allowed.</p> <ul style="list-style-type: none"> If the increased liquid pipe size is larger than the pipe size of the main liquid pipe, then the pipe size of the main liquid pipe needs to be increased as well. If the increased suction gas pipe size is larger than the pipe size of the main suction gas pipe, then the allowable length after the first refrigerant branch kit may not be increased to 90 m. <p>Size-up of the main suction gas pipe may affect a good oil return to the outdoor unit due to influence of the HP/LP gas pipe.</p>	<p>Example drawings</p> <p>Indoor unit 8: $b+c+d+e+f+g+p \leq 90$ m increase the pipe size of b, c, d, e, f, g</p> <table border="1"> <thead> <tr> <th>Model</th> <th>Gas side</th> <th>Liquid side</th> </tr> </thead> <tbody> <tr> <td>REYQ18-22</td> <td>Ø28.6 → Ø31.8^(a)</td> <td>Ø9.5 → Ø12.7</td> </tr> <tr> <td>REYQ24</td> <td>Ø34.9</td> <td>Ø12.7 → Ø15.9</td> </tr> <tr> <td>REYQ26-34</td> <td>Ø34.9 → Ø38.1^(a)</td> <td>Ø15.9 → Ø19.1</td> </tr> <tr> <td>REYQ36-48</td> <td>Ø41.3</td> <td>Ø19.1 → Ø22.2</td> </tr> <tr> <td>REYHQ16+20+22</td> <td>Ø28.6 → Ø31.8^(a)</td> <td></td> </tr> <tr> <td>REYHQ24</td> <td>Ø34.9</td> <td></td> </tr> </tbody> </table> <p>— Increase is not allowed (a) If not available, increase is not allowed</p>	Model	Gas side	Liquid side	REYQ18-22	Ø28.6 → Ø31.8 ^(a)	Ø9.5 → Ø12.7	REYQ24	Ø34.9	Ø12.7 → Ø15.9	REYQ26-34	Ø34.9 → Ø38.1 ^(a)	Ø15.9 → Ø19.1	REYQ36-48	Ø41.3	Ø19.1 → Ø22.2	REYHQ16+20+22	Ø28.6 → Ø31.8 ^(a)		REYHQ24	Ø34.9		<p>1 Outdoor unit 2 Refnet joints (a-g) 3 Indoor units (1-8)</p> 
Model	Gas side	Liquid side																						
REYQ18-22	Ø28.6 → Ø31.8 ^(a)	Ø9.5 → Ø12.7																						
REYQ24	Ø34.9	Ø12.7 → Ø15.9																						
REYQ26-34	Ø34.9 → Ø38.1 ^(a)	Ø15.9 → Ø19.1																						
REYQ36-48	Ø41.3	Ø19.1 → Ø22.2																						
REYHQ16+20+22	Ø28.6 → Ø31.8 ^(a)																							
REYHQ24	Ø34.9																							
	<p>For calculation of total extension length, the actual length of above pipes must be doubled (except length of main pipes and of pipes which do not have an increased pipe size).</p> <p>Indoor unit to the nearest branch kit ≤ 40 m</p> <p>The difference between the distance of the outdoor unit to the farthest indoor unit and the distance of the outdoor unit to the nearest indoor unit ≤ 40 m</p>	<p>$a+b*2+c*2+d*2+e*2+f*2+g*2$ $+h+i+j+k+l+m+n+p \leq 1000$ m</p> <p>h, i, j, p ≤ 40 m</p> <p>The most remote indoor unit 8 The nearest indoor unit 1 $(a+b+c+d+e+f+g+p)-(a+h) \leq 40$ m</p>																						

7. LEAK TEST AND VACUUM DRYING

The units were checked for leaks by the manufacturer.

After connecting the field piping, perform the following inspections.

1 Preparations

Referring to figure 23, connect a nitrogen tank, a refrigerant tank and a vacuum pump to the outdoor unit and perform the airtightness test and the vacuum drying.

The refrigerant tank and the charge hose connected to the refrigerant charge port or valve A are needed to perform refrigerant charging.

- 1 Gauge manifold
- 2 Nitrogen
- 3 Measuring instrument
- 4 Refrigerant R410A tank (siphon system)
- 5 Vacuum pump
- 6 Charge hose
- 7 Equalizer pipe stop valve
- 8 High pressure/low pressure pipe stop valve
- 9 Suction gas line stop valve
- 10 Liquid line stop valve
- 11 Refrigerant charge port
- 12 Valve A
- 13 Valve B
- 14 Valve C
- 15 To BS unit or indoor unit
- 16 Stop valve
- 17 Service port
- 18 Field piping
- 19 Gas flow

2 Airtightness test and vacuum drying



NOTE

Make sure to perform airtightness test and vacuum drying using the service ports of the stop valves of the equalizer pipe, HP/LP gas pipe, suction gas pipe and liquid pipe. (For the service port location, refer to the "Caution" label attached on the front panel of the outdoor unit.)



- See "11.3. Stop valve operation procedure" on page 18 for details on handling the stop valve.
- To prevent entry of any contamination and to prevent insufficient pressure resistance, always use the special tools dedicated for working with R410A refrigerant.

■ Airtightness test:



NOTE Make sure to use nitrogen gas.

Pressurize the liquid pipe, the suction gas pipe, the high pressure/low pressure gas pipe and the equalizer pipe from the service ports of each stop valve to 4.0 MPa (40 bar) (do not pressurize more than 4.0 MPa (40 bar)). If the pressure does not drop within 24 hours, the system passes the test. If the pressure drops, check where the nitrogen leaks from.

- Vacuum drying: Use a vacuum pump which can evacuate to -100.7 kPa (5 Torr, -755 mm Hg)
1. Evacuate the system from the liquid pipe, the suction gas pipe, the high pressure/low pressure gas pipe and the equalizer pipe stop valve service ports by using a vacuum pump for more than 2 hours and bring the system to -100.7 kPa. After keeping the system under that condition for more than 1 hour, check if the vacuum gauge rises or not. If it rises, the system may either contain moisture inside or have leaks.
 2. Following should be executed if there is a possibility of moisture remaining inside the pipe (if piping work is carried out during the raining season or over a long period of time, rainwater may enter the pipe during work).
After evacuating the system for 2 hours, pressurize the system to 0.05 MPa (vacuum break) with nitrogen gas and evacuate the system again using the vacuum pump for 1 hour to -100.7 kPa (vacuum drying). If the system cannot be evacuated to -100.7 kPa within 2 hours, repeat the operation of vacuum break and vacuum drying.
Then, after leaving the system in vacuum for 1 hour, confirm that the vacuum gauge does not rise.

8. FIELD WIRING



All field wiring and components must be installed by a licensed electrician and must comply with relevant local and national regulations.

The field wiring must be carried out in accordance with the wiring diagrams and the instructions given below.

Be sure to use a dedicated power circuit. Never use a power supply shared by another appliance. This can lead to electric shock or fire.

Be sure to install an earth leakage circuit breaker. (Because this unit uses an inverter, install an earth leakage circuit breaker that is capable of handling high harmonics in order to prevent malfunctioning of the earth leakage breaker itself.)

Do not operate until refrigerant piping work is completed. (If operated before completion of the piping work, the compressor may break down.)

Never remove a thermistor, sensor, etc., when connecting power wiring and transmission wiring. (If operated without thermistor, sensor, etc., the compressor may break down.)

The reversed phase protection detector of this product only functions when the product starts up. Consequently, reversed phase detection is not performed during normal operation of the product.

The reversed phase protection detector is designed to stop the product in the event of an abnormality when the product is started up.

Replace two of the three phases (L1, L2, and L3) during reverse-phase protection circuit operation.

If the possibility of reversed phase exists after a momentary blackout and the power goes on and off while the product is operating, attach a reversed phase protection circuit locally. Running the product in reversed phase can break the compressor and other parts.

Means for disconnection must be incorporated in the field wiring in accordance with the wiring rules. (An all-pole disconnection switch must be available on the unit.)

8.1. Internal wiring – Parts table

Refer to the wiring diagram sticker on the unit. The abbreviations used are listed below:

A1P~A8P	Printed circuit board (main, noise filter, inverter, fan, sub, current sensor, current sensor, fan)
BS1~BS5	Push button switch (mode, set, return, test, reset)
C1,C63,C66	Capacitor
E1HC~E3HC	Crankcase heater
F1U	Fuse (DC 650 V, 8 A, B) (A4P, A8P)
F1U	Fuse (T, 3.15 A, 250 V) (A5P)
F1U,F2U	Fuse (T, 3.15 A, 250 V) (A1P)
F5U	Field fuse (field supply)
F400U	Fuse (T, 6.3 A, 250 V) (A2P)
H1P~H8P	Pilot lamp
	H2P: Under preparation or in test operation when blinking
	H2P: Malfunction detection when light up
HAP	Pilot lamp (service monitor - green) (A1P, A5P)
K1,K3	Magnetic relay
K1R	Magnetic relay (K2M~A1P, Y5S~A5P)
K2,K4	Magnetic contactor (M1C)
K2M	Magnetic contactor for M2C (only for REMQ10~16 + REMHQ12)
K2R	Magnetic relay (K3M~A1P, Y6S~A5P)
K3M	Magnetic contactor for M3C (only for REMQ14+16 + REMHQ12)
K3R~K5R	Magnetic relay (Y1S~Y3S~A1P)
K5R	Magnetic relay (for option~A5P)
K6R	Magnetic relay (Y7S~A5P)
K7R~K9R	Magnetic relay (E1HC~E3HC~A1P)
K11R	Magnetic relay (Y4S~A1P)
L1R	Reactor
M1C~M3C	Motor (compressor)
M1F,M2F	Motor (fan)
PS	Switching power supply (A1P,A3P)
Q1DI	Earth leakage breaker (field supply)
Q1RP	Phase reversal detection circuit
R1T	Thermistor (air~A1P, fin~A3P)
R3T~R9T	Thermistor (H/E gas, H/E-de-icer, sub cool H/E gas, sub cool H/E liquid, H/E liquid, suction, liquid)
R10	Resistor (current sensor) (A4P, A8P)
R31T~R33T	Thermistor (discharge) (M1C~M3C)
R50,R59	Resistor
R90	Resistor (current sensor)
R95	Resistor (current limiting)
S1NPH	Pressure sensor (high)
S1NPL	Pressure sensor (low)
S1PH~S3PH	Pressure switch (high)
SD1	Safety devices input
T1A	Current sensor (A6P, A7P)
V1R	Diode bridge (A3P)
V1R	Power module (A4P, A8P)
V2R	Power module (A3P)
X1A,X4A	Connector (M1F, M2F)
X1M	Terminal strip (power supply)
X1M	Terminal strip (control) (A1P)
Y1E~Y3E	Electronic expansion valve (main, charge, subcool)

Y1S~Y7S	Solenoid valve (RMTG, 4 way valve–PPE, 4 way valve–H/E gas, RMTL, hot gas, EV bypass, RMT0)
Z1C~Z10C	Noise filter (ferrite core)
Z1F	Noise filter (with surge absorber)
L1,L2,L3	Live
N	Neutral
	Field wiring
	Terminal strip
	Connector
	Terminal
	Protective earth (screw)
BLK	Black
BLU	Blue
BRN	Brown
GRN	Green
GRY	Grey
ORG	Orange
PNK	Pink
RED	Red
WHT	White
YLW	Yellow

NOTE



- This wiring diagram only applies to the outdoor unit.
- When using the option adaptor, refer to the installation manual.
- Refer to the installation manual, for connection wiring to indoor-outdoor transmission F1-F2, outdoor-outdoor transmission F1-F2, outdoor-multi transmission Q1-Q2 and on how to use BS1~BS5 and DS1, DS2 switch.
- Do not operate the unit by short-circuiting protection device S1PH~S3PH.

8.2. Optional parts connector

X7A	Operation output (A5P)
X9A	Power supply (adaptor) (A5P)

NOTE



- Use copper conductors only.
- For connection wiring to the central remote controller, refer to the installation manual of the central remote controller.
- Use insulated wire for the power cord.

8.3. Power circuit and cable requirements

A power circuit (see table below) must be provided for connection of the unit. This circuit must be protected with the required safety devices, i.e. a main switch, a slow blow fuse on each phase and an earth leakage breaker.

	Phase and frequency	Voltage	Minimum circuit ampere	Recommended fuses	Transmission line section
REYQ18	3N~50 Hz	400 V	40.1 A	50 A	0.75~1.25 mm ²
REYQ20	3N~50 Hz	400 V	41.2 A	50 A	0.75~1.25 mm ²
REYQ22	3N~50 Hz	400 V	44.3 A	50 A	0.75~1.25 mm ²
REYQ24	3N~50 Hz	400 V	45.4 A	50 A	0.75~1.25 mm ²
REYQ26	3N~50 Hz	400 V	53.1 A	63 A	0.75~1.25 mm ²
REYQ28	3N~50 Hz	400 V	54.2 A	63 A	0.75~1.25 mm ²
REYQ30	3N~50 Hz	400 V	63.0 A	80 A	0.75~1.25 mm ²
REYQ32	3N~50 Hz	400 V	63.0 A	80 A	0.75~1.25 mm ²
REYQ34	3N~50 Hz	400 V	71.6 A	80 A	0.75~1.25 mm ²
REYQ36	3N~50 Hz	400 V	72.7 A	80 A	0.75~1.25 mm ²
REYQ38	3N~50 Hz	400 V	75.8 A	80 A	0.75~1.25 mm ²
REYQ40	3N~50 Hz	400 V	76.9 A	80 A	0.75~1.25 mm ²
REYQ42	3N~50 Hz	400 V	84.6 A	100 A	0.75~1.25 mm ²
REYQ44	3N~50 Hz	400 V	85.7 A	100 A	0.75~1.25 mm ²
REYQ46	3N~50 Hz	400 V	94.5 A	100 A	0.75~1.25 mm ²
REYQ48	3N~50 Hz	400 V	94.5 A	100 A	0.75~1.25 mm ²

	Phase and frequency	Voltage	Minimum circuit ampere	Recommended fuses	Transmission line section
REYHQ16	3N~50 Hz	400 V	37 A	50 A	0.75~1.25 mm ²
REYHQ20	3N~50 Hz	400 V	50 A	63 A	0.75~1.25 mm ²
REYHQ22	3N~50 Hz	400 V	53.1 A	63 A	0.75~1.25 mm ²
REYHQ24	3N~50 Hz	400 V	63 A	80 A	0.75~1.25 mm ²

When using residual current operated circuit breakers, be sure to use a high-speed type 300 mA rated residual operating current.

Point for attention regarding quality of the public electric power supply

This equipment complies with respectively:

- EN/IEC 61000-3-11⁽¹⁾ provided that the system impedance Z_{sys} is less than or equal to Z_{max} and
- EN/IEC 61000-3-12⁽²⁾ provided that the short-circuit power S_{sc} is greater than or equal to the minimum S_{sc} value

at the interface point between the user's supply and the public system. It is the responsibility of the installer or user of the equipment to ensure, by consultation with the distribution network operator if necessary, that the equipment is connected only to a supply with respectively:

- Z_{sys} less than or equal to Z_{max} and
- S_{sc} greater than or equal to the minimum S_{sc} value.

(1) European/International Technical Standard setting the limits for voltage changes, voltage fluctuations and flicker in public low-voltage supply systems for equipment with rated current ≤ 75 A.

(2) European/International Technical Standard setting the limits for harmonic currents produced by equipment connected to public low-voltage systems with input current >16 A and ≤ 75 A per phase.

		Z_{max} (Ω)	Minimum S_{sc} value
REYQ18	= REMQ8+REMQ10	0.27	1748 kVA
REYQ20	= REMQ8+REMQ12	0.27	1759 kVA
REYQ22	= REMQ10+REMQ12	0.25	1687 kVA
REYQ24	= REMQ12+REMQ12	0.25	1698 kVA
REYQ26	= REMQ10+REMQ16	0.23	1711 kVA
REYQ28	= REMQ12+REMQ16	0.23	1722 kVA
REYQ30	= REMQ14+REMQ16	0.22	1746 kVA
REYQ32	= REMQ16+REMQ16	0.22	1746 kVA
REYQ34	= REMQ8+REMQ10+REMQ16	0.23	2621 kVA
REYQ36	= REMQ8+REMQ12+REMQ16	0.23	2632 kVA
REYQ38	= REMQ10+REMQ12+REMQ16	0.22	2560 kVA
REYQ40	= REMQ12+REMQ12+REMQ16	0.22	2571 kVA
REYQ42	= REMQ10+REMQ16+REMQ16	0.22	2584 kVA
REYQ44	= REMQ12+REMQ16+REMQ16	0.22	2595 kVA
REYQ46	= REMQ14+REMQ16+REMQ16	0.22	2619 kVA
REYQ48	= REMQ16+REMQ16+REMQ16	0.22	2619 kVA

		Z_{max} (Ω)	Minimum S_{sc} value
REYHQ16	= REMQ8+REMQ8	—	1820 kVA
REYHQ20	= REMQ8+REMHQ12	0.27	1783 kVA
REYHQ22	= REMQ10+REMHQ12	0.25	1711 kVA
REYHQ24	= REMHQ12+REMHQ12	0.24	1746 kVA

Be sure to install a main switch for the complete system.

NOTE



- Select the power supply cable in accordance with relevant local and national regulations.
- Wire size must comply with the applicable local and national code.
- Specifications for local wiring power cord and branch wiring are in compliance with IEC60245.
- WIRE TYPE H05VV(*)
*Only in protected pipes (use H07RN-F when protected pipes are not used).

8.4. General cautions

- Up to 3 units can be connected by crossover power source wiring between outdoor units. However, units of smaller capacity must be connected downstream. For details, refer to the technical data.
- When connecting several units in VRV combination, the power supply of each outdoor unit can also be connected separately. Refer to the field wiring on the engineering data book for further details.
- Make sure to connect the power source wire to the power source terminal block and to clamp it as shown in figure 19 and described in chapter "8.8. Field line connection: power wiring" on page 16.
- For conditional connections, refer to the Technical Data.
- As this unit is equipped with an inverter, installing a phase advancing capacitor not only will deteriorate power factor improvement effect, but also may cause capacitor abnormal heating accident due to high-frequency waves. Therefore, never install a phase advancing capacitor.
- Keep power imbalance within 2% of the supply rating.
 - Large imbalance will shorten the life of the smoothing capacitor.
 - As a protective measure, the product will stop operating and an error indication will be made, when power imbalance exceeds 4% of the supply rating.
- Follow the "electrical wiring diagram" supplied with the unit when carrying out any electrical wiring.
- Only proceed with wiring work after all power is shut off.
- Always ground wires. (In accordance with national regulations of the pertinent country.)

- Do not connect the ground wire to gas pipes, sewage pipes, lightning rods or telephone ground wires. This may cause electric shock.
 - Combustion gas pipes: can explode or catch fire if there is a gas leak.
 - Sewage pipes: no grounding effect is possible if hard plastic piping is used.
 - Telephone ground wires and lightning rods: dangerous when struck by lightning due to abnormal rise in electrical potential in the grounding.
- This unit uses an inverter and therefore generates noise, which will have to be reduced to avoid interfering with other devices. The outer casing of the product may take on an electrical charge due to leaked electrical current, which will have to be discharged with the grounding.
- Be sure to install an earth leakage breaker. (One that can handle high-frequency electrical noise.)
(This unit uses an inverter, which means that an earth leakage breaker capable of handling high-frequency electrical noise must be used in order to prevent malfunctioning of the earth leakage breaker itself.)
- Earth leakage breakers that are especially designed for protecting ground-faults must be used in conjunction with main switch and fuse for use with wiring.
- Never connect the power supply in reversed phase.
The unit can not operate normally in reversed phase. If you connect in reversed phase, replace two of the three phases.
- This unit has a reverse phase detection circuit. (If it is activated, only operate the unit after correcting the wiring.)
- Power supply wires must be attached securely.
- If the power supply has a missing or wrong N-phase, equipment will break down.
- Make sure that all wiring is secure, the specified wires are used, and no external forces act on the terminal connection or wires.
- Improper connections or installation may result in fire.
- When wiring the power supply and connecting the remote controller wiring and transmission wiring, position the wires so that the control box lid can be securely fastened.
Improper positioning of the control box lid may result in electric shocks, fire or overheating of the terminals.

8.5. System examples

(See figure 14)

- | | | | |
|---|--|----|-----------------------|
| 1 | Field power supply | 6 | Remote controller |
| 2 | Main switch | 7 | BS unit |
| 3 | Earth | 8 | Cool/heat selector |
| 4 | Outdoor unit | 9 | Earth leakage breaker |
| 5 | Indoor unit | 10 | Fuse |
| — | Power supply wiring (sheathed cable) (380~415 V) | | |
| — | Transmission wiring (sheathed cable) (16 V) | | |

8.6. Leading power line and transmission line

- Be sure to let the power line and the transmission line pass through a conduit hole.
 - Lead the power line from the upper hole on the left side plate, from the front position of the main unit (through the conduit hole of the wiring mounting plate) or from a knock out hole to be made in the unit's bottom plate. (See figure 17)
- 1 Electric wiring diagram. Printed on the back of the electric box lid.
 - 2 Power wiring and ground wiring between outdoor units (inside conduit)
(When the wiring is routed out through the lateral panel.)
 - 3 Transmission wiring
 - 4 Pipe opening
 - 5 Conduit
 - 6 Power wiring and ground wiring
 - 7 Cut off the shaded zones before use.
 - 8 Through hole cover

Precautions when knocking out knockout holes

- To punch a knockout hole, hit on it with a hammer.
- After knocking out the holes, we recommend you paint the edges and areas around the edges using repair paint to prevent rusting.
- When passing electrical wiring through the knockout holes, remove any burrs from the knockout hole edges. Wrap the wiring with protective tape in order to prevent damage to the wires, put the wires through field supplied protective wire conduits at that location, or install suitable field supplied wire nipples or rubber bushings into the knockout holes.

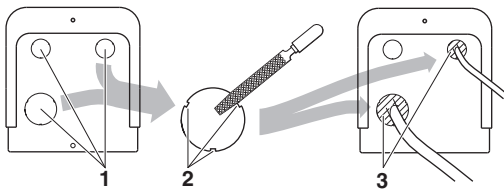

- 1 Knockout hole
- 2 Burr
- 3 If there are any possibilities that small animals enter the system through the knockout holes, plug the holes with packing materials (to be prepared on-site).



- Use a power wire pipe for the power wiring.
- Outside the unit, make sure the low voltage electric wiring (i.e. for the remote control, between units, etc.) and the high voltage electric wiring do not pass near each other, keeping them at least 50 mm apart. Proximity may cause electrical interference, malfunctions, and breakage.
- Be sure to connect the power wiring to the power wiring terminal block and secure it as described under "8.8. Field line connection: power wiring" on page 16.
- Inter-unit wiring should be secured as described in "8.7. Field line connection: transmission wiring" on page 15.
 - Secure the wiring with the accessory clamps so that it does not touch the piping and no external force can be applied to the terminal.
 - Make sure the cover and wiring are in their correct place and close the cover firmly.

8.7. Field line connection: transmission wiring

(See figure 18)

- 1 Master unit^(a)
- 2 Slave unit^(a)
- 3 Outdoor unit A
- 4 Outdoor unit B
- 5 Outdoor unit C
- 6 Never connect the power supply wire
- 7 To outdoor unit of other system
- 8 Use duplex wires (no polarity)
- 9 BS unit
- 10 Indoor unit
- 11 Indoor unit (cooling only)

(a) The outdoor unit that connect the transmission wiring to the BS unit is the master unit of the multi system, while the other units are slave units. (In this figure outdoor unit A is the master unit.)
Test operation, on site settings etc. are done by operating the PC-board (A1P) of the master unit.

- The interconnecting wiring between the outdoor units in the same piping system must be connected to the Q1/Q2 (Out Multi) terminals. Connecting the wires to the F1/F2 (Out-Out) terminals results in system malfunction.
- The wiring to other systems must be connected to the F1/F2 (Out-Out) terminals of the P-board in the outdoor unit to which the interconnecting wiring for the BS unit or indoor units is connected.
- The master unit is the outdoor unit to which the interconnecting wiring for the BS unit or indoor units is connected.

Fixing transmission wiring (See figure 20)

Inside switchbox

- 1 Fix to the indicated plastic brackets using field supplied clamping material.
- 2 Wiring between the units (Outdoor - outdoor) (F1+F2 right)
- 3 Wiring between the units (Indoor - outdoor) (F1+F2 left)
- 4 Wiring for multi connection (Q1+Q2)
- 5 Plastic bracket
- 6 Field supplied clamps

When connecting wires to the terminal block on the PC-board, too much heat or tightening could damage the PC-board. Attach with care.

See the table below for the tightening torque of the transmission wiring terminals.

Screw size	Tightening torque (N·m)
M3.5 (A1P)	0.80~0.96

Outside unit



- Be sure to follow the limits below. If the unit-to-unit cables are beyond these limits, it may result in malfunction of transmission.
 - Maximum wiring length: 1000 m
 - Total wiring length: 2000 m
 - Maximum interunit wiring length between outdoor units in the same system: 30 m
 - Maximum number of branches: 16
- Maximum number of independent interconnectable systems (TO OUT/D UNIT F1-F2): 10.
- Up to 16 branches are possible for unit-to unit cabling. No branching is allowed after branching. (See figure 15)

- 1 Outdoor unit
- 2 Indoor unit
- 3 Main line
- 4 Branch line 1
- 5 No branch is allowed after branch
- A Transmission wiring between outdoor unit and indoor unit(s)
- B Transmission wiring between outdoor units

- Never connect the power supply to transmission wiring terminal block. Otherwise the entire system may break down.
- Never connect 400 V to the terminal block of the interconnecting wiring. Doing so will break the entire system.
 - The wiring from the indoor units must be connected to the F1/F2 (In-Out) terminals on the PC board in the outdoor unit.
 - After installing the interconnecting wires inside the unit, wrap them along with the on-site refrigerant pipes using finishing tape, as shown in figure 11.

- 1 Liquid pipe
- 2 HP/LP gas pipe
- 3 Finishing tape
- 4 Suction gas pipe
- 5 Transmission wiring
- 6 Insulation material

For the above wiring, always use vinyl cords with 0.75 to 1.25 mm² sheath or cables (2-core wires).



- Be sure to keep the power line and transmission line apart from each other.
- Be careful about polarity of the transmission line.
- Make sure that the transmission line is clamped as shown in figure 20.
- Check that wiring lines do not make contact with refrigerant piping.
- Firmly close the lid and arrange the electrical wires as to prevent the lid or other parts from coming loose.
- When you do not use a wire conduit, be sure to protect the wires with vinyl tubes etc, to prevent the edge of the knock-out hole from cutting the wires.

8.8. Field line connection: power wiring

The power cord must be clamped to the plastic bracket using field supplied clamp material.

The green and yellow striped wrapped wires must be used for grounding. (See figure 19)

- 1 Power supply (380~415 V, 3N~ 50 Hz)
- 2 Earth leakage breaker
- 3 Fuse
- 4 Grounding wire
- 5 Power supply terminal block
- 6 Connect each power wire RED to L1, WHT to L2, BLK to L3 and BLU to N
- 7 Ground wire (GRN/YLW)
- 8 Clamp the power wire to the plastic bracket using a field supplied clamp to prevent external force being applied to the terminal.
- 9 Clamp (field supply)
- 10 Cup washer
- 11 When connecting the earth wire, it is recommended to perform curling.



- When routing ground wires, secure clearance of 50 mm or more away from compressor lead wires. Failure to observe this instruction properly may adversely effect correct operation of other units connected to the same ground.
- When connecting the power supply cord, the earth connection must be made before the current-carrying connections are established. When disconnecting the power supply cord, the current-carrying connections must be separated before the earth connection is. Length of the conductors between the power supply cord anchorage and the terminal block itself must be such that the current-carrying conductors are tightened before the earthing conductor is in case the power supply cord is pulled loose from the cord anchorage.



Precautions when laying power wiring

- Do not connect wiring of different thicknesses to the power terminal block. (Slack in the power wiring may cause abnormal heat.)
- When connecting wiring which is the same thickness, do as shown in the figure below.



- For wiring, use the designated power wire and connect firmly, then secure to prevent outside pressure being exerted on the terminal board.
- Use an appropriate screwdriver for tightening the terminal screws. A screwdriver with a small head will strip the head and make proper tightening impossible.
- Over-tightening the terminal screws may break them.
- See the table below for tightening torque for the terminal screws.

Tightening torque (N·m)	
M8 (Power terminal block)	5.5~7.3
M8 (Ground)	



Recommendations when connecting the ground

When pulling the ground wire out, wire it so that it comes through the cut out section of the cup washer. (An improper ground connection may prevent a good ground from being achieved.) (See figure 19)

8.9. Wiring example for wiring inside unit

See figure 22.

- 1 Power wiring
- 2 Wiring between units
- 3 Clamp to the electric box with field supplied clamps.
- 4 When routing out the power/ground wires from the right side:
- 5 When routing the remote control cord and inter-unit wiring, secure clearance of 50 mm or more from the power wiring. Ensure that the power wiring does not contact any heated sections ().
- 6 Clamp to the back of the column support with field supplied clamps.
- 7 When routing out the inter-unit wirings from the opening for piping or from the front:
- 8 When routing out the power/ground wires from the front:
- 9 When routing out the power/ground wires from the left side:
- 10 Grounding wire
- 11 When wiring, pay attention not to detach the acoustic insulators from the compressor.
- 12 Power supply
- 13 Fuse
- 14 Earth leakage breaker
- 15 Ground wire



Wire so that the ground wiring does not come into contact with the compressor lead wiring. If they touch, this may have an adverse effect on other devices.

9. PIPE INSULATION

After finishing the leak test and vacuum drying, the piping must be insulated. Take into account the following points:

- Make sure to insulate the connection piping and refrigerant branch kits entirely.
- Be sure to insulate liquid and gas piping (for all units).
- Use heat resistant polyethylene foam which can withstand a temperature of 70°C for liquid side piping and polyethylene foam which can withstand a temperature of 120°C for gas side piping.
- Reinforce the insulation on the refrigerant piping according to the installation environment.

Ambient temperature	Humidity	Minimum thickness
≤30°C	75% to 80% RH	15 mm
>30°C	≥80 RH	20 mm

Condensation might form on the surface of the insulation.

- If there is a possibility that condensation on the stop valve might drip down into the indoor unit through gaps in the insulation and piping because the outdoor unit is located higher than the indoor unit, this must be prevented by sealing up the connections. See figure 7.

- 1 Insulation material
- 2 Caulking, etc.



Be sure to insulate local pipes, as touching them can cause burns.

10. CHECKING OF UNIT AND INSTALLATION CONDITIONS

Be sure to check the following:

The piping work

- 1 Make sure piping size is correct.
See "6.2. Selection of piping material" on page 5.
- 2 Make sure insulation work is done.
See "9. Pipe insulation" on page 17.
- 3 Make sure there is no faulty refrigerant piping.
See "6. Refrigerant piping" on page 5.

The electrical work

- 1 Make sure there is no faulty power wiring or loose nuts.
See "8. Field wiring" on page 12.
- 2 Make sure there is no faulty transmission wiring or loose nuts.
See "8. Field wiring" on page 12.
- 3 Make sure the insulation resistance of the main power circuit is not deteriorated.
Measure the insulation resistance and check if the value is in accordance with relevant local and national regulations.

11. CHARGING REFRIGERANT

The outdoor unit is factory charged, but depending on the length of the piping when installed, the outdoor unit may require additional charging.

For charging the additional refrigerant follow the procedure as described in this chapter.



Refrigerant cannot be charged until all field wiring and field piping has been completed.
Refrigerant may only be charged after performing the leak test and the vacuum drying.



The refrigerant charge of the system must be less than 100 kg. This means that in case the calculated refrigerant charge is equal to or more than 95 kg you must divide your multiple outdoor system into smaller independent systems, each containing less than 95 kg refrigerant charge.

For factory charge, refer to the unit name plate.

11.1. Important information regarding the refrigerant used

This product contains fluorinated greenhouse gases covered by the Kyoto Protocol. Do not vent gases into the atmosphere.

Refrigerant type: R410A
GWP⁽¹⁾ value: 1975

⁽¹⁾ GWP = global warming potential

Please fill in with indelible ink,

- ① the factory refrigerant charge of the product,
- ② the additional refrigerant amount charged in the field and
- ①+② the total refrigerant charge

on the fluorinated greenhouse gases label supplied with the product.

The filled out label must be adhered on the inside of the product and in the proximity of the product charging port (e.g. on the inside of the service cover).

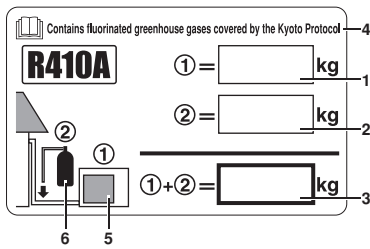

- 1 factory refrigerant charge of the product: see unit name plate⁽²⁾
- 2 additional refrigerant amount charged in the field
- 3 total refrigerant charge
- 4 contains fluorinated greenhouse gases covered by the Kyoto Protocol
- 5 outdoor unit
- 6 refrigerant cylinder and manifold for charging

⁽²⁾ In case of multiple outdoor systems, only 1 label must be adhered, mentioning the total factory refrigerant charge of all outdoor units connected on the refrigerant system.

NOTE



National implementation of EU regulation on certain fluorinated greenhouse gases may require to provide the appropriate official national language on the unit. Therefore, an additional multilingual fluorinated greenhouse gases label is supplied with the unit.

Sticking instructions are illustrated on the backside of that label.

11.2. Precautions when adding R410A

Be sure to charge the specified amount of refrigerant in liquid state to the liquid pipe.

Since this refrigerant is a mixed refrigerant, adding it in gas form may cause the refrigerant composition to change, preventing normal operation.

- Before charging, check whether the refrigerant cylinder is equipped with a siphon tube or not.

Charge the liquid refrigerant with the cylinder in upright position.

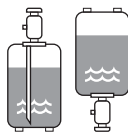

Charge the liquid refrigerant with the cylinder in up-side-down position.

- Be sure to use tools exclusively for R410A to ensure required pressure resistance and to prevent foreign materials from mixing into the system.



Charging with an unsuitable substance may cause explosions and accidents, so always make sure that the appropriate refrigerant (R410A) is charged.

Refrigerant containers must be opened slowly.

11.3. Stop valve operation procedure

Size of stop valve

The sizes of the stop valves connected to the system are as listed in the table below.

Type of stop valve	8 Hp	10 Hp	12 Hp	14 Hp	16 Hp
Liquid pipe		Ø9.5 ^(a)		Ø12.7	
Suction gas pipe			Ø25.4 ^(b)		
HP/LP gas pipe			Ø19.1 ^(c)		
Equalizer pipe			Ø19.1		

- (a) The 12 Hp model supports field piping of Ø12.7 on the accessory pipe supplied with the unit.
- (b) The 8 and 10 Hp models support field piping of Ø22.2 on the accessory pipe supplied with the unit. The 12~16 Hp models support field piping of Ø28.6 on the accessory pipe supplied with the unit.
- (c) The 14 and 16 Hp models support field piping of Ø22.2 on the accessory pipe supplied with the unit.



- Do not open the stop valve until all piping and electrical steps of "10. Checking of unit and installation conditions" on page 17 are completed. If the stop valve is left open without turning on the power, it may cause refrigerant to build up in the compressor, leading to insulation degradation.
- Always use a charge hose for service port connection.
- After tightening the cap, check that no refrigerant leaks are present.

Opening stop valve (See figure 13)

- 1 Service port
- 2 Cap
- 3 Hexagon hole
- 4 Shaft
- 5 Seal

1. Remove the cap and turn the valve counterclockwise with the hexagon wrench.
2. Turn it until the shaft stops.



Do not apply excessive force to the stop valve. Doing so may break the valve body.

3. Make sure to tighten the cap securely. Refer to the table below

Stop valve size	Tightening torque N·m (Turn clockwise to close)			
	Shaft		Cap (valve lid)	Service port
	Valve body	Hexagonal wrench		
Ø9.5	5.4~6.6	4 mm	13.5~16.5	11.5~13.9
Ø12.7	8.1~9.9		18.0~22.0	
Ø22.2	27.0~33.0	8 mm	22.5~27.5	
Ø25.4				

Closing stop valve (See figure 13)

1. Remove the cap and turn the valve clockwise with the hexagon wrench.
2. Securely tighten the valve until the shaft contacts the main body seal.
3. Make sure to tighten the cap securely. For the tightening torque, refer to the table above.

11.4. How to check how many units are connected

It is possible to find out how many indoor units are active and connected by operating the push-button switch on the printed circuit board (A1P) of the working outdoor unit. In a multiple outdoor unit system, you can find out how many outdoor units are connected to the system by using the same procedure.

Make sure that all the indoor units connected to the outdoor unit are active.

Follow the 5-step procedure as explained below.

- The LEDs on the A1P shows the operating status of the outdoor unit and the number of indoor units that are active.

● OFF ☀ ON ⚡ Blinking

- The number of units that are active can be read from the LED display in the "Monitor Mode" procedure below.

Example: in the following procedure there are 22 units active:

NOTE  Wherever during this procedure, press the **BS1 MODE** button if something becomes unclear.
You will return to setting mode 1 (H1P= ● "OFF").

1 Setting mode 1 (default system status)

Default status (normal)

H1P	H2P	H3P	H4P	H5P	H6P	H7P
●	●	☀	●	●	●	●

Press the **BS1 MODE** button to switch from setting mode 1 to monitor mode.

2 Monitor mode

Default status display

H1P	H2P	H3P	H4P	H5P	H6P	H7P
☀	●	●	●	●	●	●

To check the number of indoor units, press the **BS2 SET** button 5 times
To check the number of outdoor units, press the **BS2 SET** button 8 times

3 Monitor mode

Selection status of how many connected indoor units to display.

H1P	H2P	H3P	H4P	H5P	H6P	H7P
☀	●	●	●	☀	●	☀

OR

Selection status of how many connected outdoor units to display.

H1P	H2P	H3P	H4P	H5P	H6P	H7P
☀	●	●	☀	●	●	●

Pressing the **BS3 RETURN** button causes the LED display to show the data on the number of indoor units that are connected or how many outdoor units that are connected in a multiple outdoor unit system.

4 Monitor mode

Displaying the number of connected indoor units

H1P	H2P	H3P	H4P	H5P	H6P	H7P
☀	●	☀	●	☀	☀	●
		32	16	8	4	2
						1

Calculate the number of connected indoor units by adding the values of all (H2P~H7P) blinking (☀) LEDs together.
In this example: 16+4+2=22 units

Press the **BS1 MODE** button to return to step 1, setting mode 1 (H1P= ● "OFF").

11.5. Additional refrigerant charge

 Adding refrigerant using the automatic refrigerant charging function is recommended.

Follow the procedures below.

-  ■ When charging a system, charging over the permissible quantity can cause liquid hammer.
- Always use protective gloves and protect your eyes when charging refrigerant.
- When the refrigerant charging procedure is done or when pausing, close the valve of the refrigerant tank immediately.
 - The refrigerant charge port has a electric expansion valve and will be closed at the end of the refrigerant charging. However, the valve will be opened when operating the unit after refrigerant charging.
 - If the tank is left with the valve open, the amount of refrigerant which is properly charged may get off point. More refrigerant may be charged by any remaining pressure after the unit has stopped.



Electric shock warning

- Close the electric box lid before turning on the main power.
- Perform the settings on the circuit board (A1P) of the outdoor unit and check the LED display after the power is on via the service lid which is in the lid of the electric box.
Operate switches with an insulated stick (such as a ball-point pen) to avoid touching the life parts.
Make sure to re-attach the inspection cover into the switch box cover after the job is finished.



- If the power of some units is turned off, the charging procedure can not be finished properly.
- In case of a multiple outdoor system, turn on the power of all outdoor units.
- Make sure to turn ON the power 6 hours before starting the operation. This is necessary to warm the crankcase by the electric heater.
- If operation is performed within 12 minutes after the indoor, BS unit and outdoor units are turned on, the H2P-LED will be lit and the compressor will not operate.

NOTE



- See "11.3. Stop valve operation procedure" on page 18 for details on how to handle stop valves.
- The refrigerant charging port is connected to the piping inside the unit.
The unit's internal piping is already factory charged with refrigerant, so be careful when connecting the charge hose.
- After adding the refrigerant, do not forget to close the lid of the refrigerant charging port.
The tightening torque for the lid is 11.5 to 13.9 N·m.
- In order to ensure uniform refrigerant distribution, it may take the compressor ±10 minutes to start up after the unit has started operation. This is not a malfunction.

1 Procedure for additional refrigerant charge

The automatic refrigerant charging has limits as described below.

At out of limit, the system can not operate the automatic refrigerant charging.

Outdoor temperature	: 0°C DB~43°C DB
Indoor temperature	: 10°C DB~32°C DB
Total indoor unit capacity	: ≥80%

Pre-charging

To speed up the proces of charging refrigerant for large systems, it is recommended to first manually charge a portion of the refrigerant first before performing automatic charging.

- 1 Calculate how much refrigerant to be added using the formula explained in the chapter "How to calculate the additional refrigerant to be charged" on page 10.
- 2 The amount of pre-charging is 10 kg less than the calculated amount.
- 3 Open valve B (the valves A and C, the liquid pipe, the suction gas pipe, the high pressure/low pressure gas pipe and the equalizer pipe stop valves must be left closed) and charge the refrigerant in liquid form via the liquid pipe stop valve service port.

(See figure 24)

- 1 Measuring instrument
 - 2 Refrigerant tank (R410A, siphon system)
 - 3 Charge hose
 - 4 Equalizer pipe stop valve
 - 5 High pressure/low pressure gas pipe stop valve
 - 6 Suction gas pipe stop valve
 - 7 Liquid pipe stop valve
 - 8 Refrigerant charge port
 - 9 Valve A
 - 10 Valve B
 - 11 Valve C
 - 12 To BS unit, indoor unit
 - 13 Stop valve
 - 14 Service port
 - 15 Field piping
 - 16 Refrigerant flow when pre-charging through the liquid stop valve service port (refer to step 3 on page 19)
 - 17 Refrigerant flow when automatic charging through the charge port (refer to step 5 on page 20)
 - 18 The refrigerant will be charged with ± 30 kg in 1 hour at an outdoor temperature of 30°C DB (12 kg at 0°C DB). If you need to speed up in case of a multi system, connect the refrigerant tank to each outdoor unit.
- 4 If the calculated amount of pre-charging is reached, close valve B.



At least the unit should be charged with its original amount of refrigerant (refer to the nameplate on the unit), before starting the automatic charging.

NOTE



When the leak detection function is not required, complete charging when using the previous described method (unit is not operating) can be done.

If it is not possible to charge the entire quantity through the service port of the liquid pipe stop valve with the unit not operating, refer to "14. Additional refrigerant charging method" on page 27.

- 5 After pre-charging, perform the refrigerant charge operation as shown below and charge the remaining refrigerant of the additional charging amount through valve A. (See figure 24)

NOTE



For a multi outdoor unit system, it is not required to connect all charge ports to a refrigerant tank.

The refrigerant will be charged with ± 30 kg in 1 hour time at an outdoor temperature of 30°C DB or with ± 12 kg at an outdoor temperature of 0°C DB.

If you need to speed up in case of a multiple outdoor system, connect the refrigerant tanks to each outdoor unit as shown in figure 24.

1. Start of automatic charging refrigerant

- Open the liquid pipe, suction gas pipe, high pressure/low pressure gas pipe and equalizer pipe stop valves and the service port stop valve. (Valves A, B and C must be closed.)
 - Close all front panels except the electric box front panel and turn the power ON.
 - Make sure all indoor units are connected, refer to "11.4. How to check how many units are connected" on page 18.
 - If the H2P LED is not flashing (in 12 minutes time after turning on the power), make sure it is displayed as shown in the "2 Normal system display" on page 22.
- If the H2P LED is flashing, check the malfunction code on the remote controller "3 Remote controller malfunction code display" on page 22.



- If you perform the refrigerant charging operation within the refrigerant system with one or more units with power OFF, the refrigerant charging operation can not be accomplished properly. For confirming the number of outdoor units and indoor units with power ON, refer to "11.4. How to check how many units are connected" on page 18.
- In case of a multi system, turn the power ON to all outdoor units in the refrigerant system.
- To energize the crankcase heater, make sure to turn the power ON at least 6 hours before starting operation.

2. Press the **BS1 MODE** button once if the LEDs combination is not as in the figure below.

H1P	H2P	H3P	H4P	H5P	H6P	H7P
●	●	☀	●	●	●	●

3. Press the **BS4 TEST** button once.

H1P	H2P	H3P	H4P	H5P	H6P	H7P
☀	☀	☀	☀	☀	☀	☀

4. Hold the **BS4 TEST** button down for 5 seconds or more.
5. **Charging mode judgement**

However, if the indoor temperature is 10°C DB or lower, in some cases the unit will charge in heating mode to increase the indoor temperature.

The unit will automatically select the cooling mode or heating mode for charging.



- When charging in cooling mode, the unit will stop operating when the required amount of refrigerant is charged.
- During charging in heating mode, a person must manually close valve A before complete charging is finished. The required amount is the calculated amount (see "6.6. Example of connection" on page 9), therefore, the weight must be monitored constantly.

■ **Charging in heating mode**

6. Start up
Wait while the unit is preparing for charging in heating mode.

	H1P	H2P	H3P	H4P	H5P	H6P	H7P
Pressure control (for the first minute)	●	☀	●	●	●	●	☀
Start up control (for the next 2 minutes)	☀	☀	●	●	●	☀	●
Waiting for stable heating conditions (for the next ± 15 minutes (according to the system))	☀	☀	●	●	●	☀	☀

It takes about 2 to 10 minutes for the system to become stable. In case of a small charging amount, the system will start charging the refrigerant before the system reaches the stable state. It may disturb a correct decision and may cause overcharging.

7. Ready

H1P	H2P	H3P	H4P	H5P	H6P	H7P
☀	☀	●	●	☀	●	☀

Press the **BS4 TEST** button once within 5 minutes. If the **BS4 TEST** button is not pushed within 5 minutes, P2 will be displayed on the remote controller. Refer to "3 Remote controller malfunction code display" on page 22.

8. Operation
When the following LED display is shown, open valve A and close the front panel. If the front panel is left open, the system can not operate properly during the refrigerant charging.



When the refrigerant tank is not connected or is left with the valve closed for 30 minutes or more, the outdoor unit will stop operation and the P2 code will be displayed on the remote controller of the indoor unit. Follow the procedure as described in "3 Remote controller malfunction code display" on page 22.

H1P	H2P	H3P	H4P	H5P	H6P	H7P
☀	☀	*	*	*	*	*

* = The state of this LED is not important.



When a malfunction occurs, check the display of the remote controller and refer to "3 Remote controller malfunction code display" on page 22.

9. Complete

If the calculated amount of refrigerant is reached, close valve A and press the **BS3 RETURN** button once.

NOTE



Always close valve A and remove the refrigerant tank immediately after finishing the refrigerant charge operation.

H1P	H2P	H3P	H4P	H5P	H6P	H7P
☀	☀	☀	☀	☀	☀	☀

10. In case leak detection function is required

Press the **BS4 TEST** button once for post-processing with regard to the leak detection function and press the **BS1 MODE** button to confirm that charging is completed.

Record the amount that was added on the additional refrigerant charge label provided with the unit and attach it on the back side of the front panel.

Perform the procedure "11.6.Procedure for inputting the additional refrigerant charge weight into the PCB" as described on page 22.

10. In case leak detection function is not required

Press the **BS1 MODE** button once and the charging is complete. Record the amount that was added on the additional refrigerant charge label provided with the unit and attach it on the back side of the front panel.

Perform the procedure "11.6.Procedure for inputting the additional refrigerant charge weight into the PCB" as described on page 22.

■ Charging in cooling mode

6. Start up

Wait while the unit is preparing for charging in cooling mode.

Pressure control
(for the first minute)

H1P	H2P	H3P	H4P	H5P	H6P	H7P
●	☀	●	●	●	●	☀

Start up control
(for the next 2 minutes)

H1P	H2P	H3P	H4P	H5P	H6P	H7P
●	☀	●	●	●	☀	●

Waiting for stable cooling conditions
(for the next ±15 minutes (according to the system))

H1P	H2P	H3P	H4P	H5P	H6P	H7P
●	☀	●	●	●	☀	☀

It takes about 2 to 10 minutes for the system to become stable. In case of a small charging amount, the system will start charging the refrigerant before the system reaches the stable state. It may disturb a correct decision and may cause overcharging.

7. Ready

H1P	H2P	H3P	H4P	H5P	H6P	H7P
☀	☀	☀	●	☀	●	☀

Press the **BS4 TEST** button once within 5 minutes. If the **BS4 TEST** button is not pushed within 5 minutes, P2 will be displayed on the remote controller. Refer to "3 Remote controller malfunction code display" on page 22.

8. Operation

When the following LED display is shown, open valve A and close the front panel. If the front panel is left open, the system can not operate properly during the refrigerant charging.



When the refrigerant tank is not connected or is left with the valve closed for 30 minutes or more, the outdoor unit will stop operation and the P2 code will be displayed on the remote controller of the indoor unit. Follow the procedure as described in "3 Remote controller malfunction code display" on page 22.

H1P	H2P	H3P	H4P	H5P	H6P	H7P
☀	☀	*	*	*	*	*

* = The state of this LED is not important.



When a malfunction occurs, check the display of the remote controller and refer to "3 Remote controller malfunction code display" on page 22.

9. Complete

H1P	H2P	H3P	H4P	H5P	H6P	H7P
☀	☀	☀	☀	☀	☀	☀

The display on the remote controller shows a flashing PE code for signalling that automatic charging will be finished in about 10 minutes.

When the unit stops operating, close valve A immediately and check the LEDs and check if the P3 code is displayed on the remote controller.

NOTE



Always close valve A and remove the refrigerant tank immediately after finishing the refrigerant charge operation.

The refrigerant charge port of these units have electric expansion valves that will close automatically when refrigerant charging operation has finished. However, the electric expansion valves will be opened when other operations start after finishing refrigerant charging operation.

If the refrigerant tank is left with the valve open, the amount of refrigerant which is properly charged may be off the point.

H1P	H2P	H3P	H4P	H5P	H6P	H7P
☀	☀	☀	☀	☀	☀	☀

If it is not as shown above, correct the malfunction (as indicated in the display of the remote controller) and restart the complete charging procedure. When the charging amount is little, the PE code may not be displayed, but instead the P3 code will be displayed immediately.

10. In case leak detection function required

Press the **BS4 TEST** button once for post-processing with regard to the leak detection function and press the **BS1 MODE** button to confirm that charging is completed.

Record the amount that was added on the additional refrigerant charge label provided with the unit and attach it on the back side of the front panel.

Perform the procedure "11.6.Procedure for inputting the additional refrigerant charge weight into the PCB" as described on page 22.

10. In case leak detection function not required

Press the **BS1 MODE** button once and the charging is complete. Record the amount that was added on the additional refrigerant charge label provided with the unit and attach it on the back side of the front panel.

Perform the procedure "11.6.Procedure for inputting the additional refrigerant charge weight into the PCB" as described on page 22.

2 Normal system display

LED display (Default status before delivery)	Micro-computer operation monitor HAP	Mode H1P	Ready/Error H2P	Cooling/Heating changeover			Low noise H6P	Demand H7P	Multi H8P
				Individual H3P	Bulk (master) H4P	Bulk (slave) H5P			
Single outdoor unit system		●	●		●	●	●	●	●
Multiple outdoor unit system	Master unit ^(a)		●		●	●	●	●	
	Slave unit 1 ^(a)		●	●	●	●	●	●	
	Slave unit 2 ^(a)		●	●	●	●	●	●	●

(a) The state of the H8P (multi) LED in a multi-system shows which unit is the master unit () , slave 1 unit () or slave 2 unit () . Only the master unit is connected to the indoor units with interunit wiring.

3 Remote controller malfunction code display

Remote controller heating mode malfunction codes

Error code	Description	
P8 recharge operation	Close valve A immediately and press the TEST OPERATION button once. The operation will restart from the charging mode judgement onwards.	
P2 charge hold	Close valve A immediately. Check following items: - Check if the gas side stop valve is opened correctly - Check if the valve of the refrigerant cylinder is opened - Check if the air inlet and outlet of the indoor unit are not obstructed	After correcting the abnormality, restart the automatic charging procedure again.

Remote controller cooling mode malfunction codes

Error code	Description	
P _R , P _H , P _C replace cylinder	Close valve A and replace the empty cylinder. When renewed, open valve A (the outdoor unit will not stop operating). The code on the display shows the unit where a cylinder is to be renewed: P _R = master unit, P _H = slave unit 1, P _C = slave unit 2, flashing P _R , P _H and P _C = all units After replacing the cylinder, open valve A again and continue the work.	In case of an outdoor multi system, replacing the refrigerant tank of the outdoor unit during the refrigerant charging operation when the display on the remote controller is not showing P _R , P _H or P _C , may cause an abnormal stop of the refrigerant charging operation.
P8 recharge operation	Close valve A immediately. Restart the automatic charging procedure again.	
P2 charge hold	Close valve A immediately. Check following items: - Check if the high pressure/low pressure gas pipe, suction gas pipe, liquid pipes and equalizer pipe stop valves are opened correctly - Check if the valve of the refrigerant cylinder is opened - Check if the air inlet and outlet of the indoor unit are not obstructed	After correcting the abnormality, restart the automatic charging procedure again.
* abnormal stop	Close valve A immediately. Confirm the malfunction code by the remote controller and correct the abnormality by following the "Correcting after abnormal completion of the test operation" on page 26.	

11.6. Procedure for inputting the additional refrigerant charge weight into the PCB

Availability of the leak detection function feature requires input of the additional refrigerant charge amount immediately after finishing the automatic charging. The input must be executed before performing the test operation.



If a wrong value is inputted for the additional charged refrigerant weight, the accuracy of the leak detection function will decrease.

Procedure

- 1 Close the electric box lid and all front panels except the one on the side of the electric box.
- 2 Press and hold the **BS1 MODE** button for 5 seconds to enter into setting mode 2.

The H1P LED is on .

- 3 Press the **BS2 SET** button 14 times.

The LED display must be as follows:

H1P	H2P	H3P	H4P	H5P	H6P	H7P
	●	●				●

Press the **BS3 RETURN** button once as confirmation of the LEDs combination.

LEDs will be blinking in function of the last entered setting (factory setting = 0 kg).

- 4 The weighed and already recorded amount of additional refrigerant charge (not the total amount of refrigerant present in the system) must be entered by selecting the corresponding LED display.

Scroll through the possible LED combinations by pressing the **BS2 SET** button until the LED combination corresponds to the weight of additional refrigerant charge you must input.

Select the required input by pressing the **BS3 RETURN** button and confirm the input into the PCB by pressing the **BS3 RETURN** button again.

Possible LED combinations in function of weight of additional refrigerant charge (= x) to input;

	kg	H1P	H2P	H3P	H4P	H5P	H6P	H7P
0	x=0	☀	●	●	●	●	●	●
1	0<x<5	☀	●	●	●	●	●	☀
2	5≤x<10	☀	●	●	●	●	☀	●
3	10≤x<15	☀	●	●	●	●	☀	☀
4	15≤x<20	☀	●	●	●	☀	●	●
5	20≤x<25	☀	●	●	●	☀	●	☀
6	25≤x<30	☀	●	●	●	☀	☀	●
7	30≤x<35	☀	●	●	●	☀	☀	☀
8	35≤x<40	☀	●	●	☀	●	●	●
9	40≤x<45	☀	●	●	☀	●	●	☀
10	45≤x<50	☀	●	●	☀	●	☀	●
11	50≤x<55	☀	●	●	☀	●	☀	☀
12	55≤x<60	☀	●	●	☀	☀	●	●
13	60≤x<65	☀	●	●	☀	☀	●	☀
14	65≤x<70	☀	●	●	☀	☀	☀	●
15	70≤x<75	☀	●	●	☀	☀	☀	☀
16	75≤x<80	☀	●	☀	●	●	●	●
17	80≤x<85	☀	●	☀	●	●	●	☀
18	85≤x<90	☀	●	☀	●	●	☀	●
19	90≤x<95	☀	●	☀	●	●	☀	☀
20	95≤x<100	☀	●	☀	●	☀	●	●
21	100≤x	☀	●	☀	●	☀	●	☀

- 5 Return to setting mode 1 (= initial state) by pressing the **BS1 MODE** button.

NOTE If you get confused in the middle of the input process, press the **BS1 MODE** button to return to setting mode 1 (= initial state).
The H1P LED is off ●.
Resume the input procedure from step 2 onwards.

Perform a test operation as described in "12.4. Test operation" on page 26.

11.7. Checks after adding refrigerant

- Are the stop valves for both liquid and gas open?
- Is the amount of refrigerant, that has been added, recorded?

! Make sure to open the stop valves after charging the refrigerant.
Operating with the stop valves closed will damage the compressor.

12. BEFORE OPERATION

12.1. **!** Service precautions



WARNING: ELECTRIC SHOCK



Caution when performing service to inverter equipment

- 1 Do not open the electric box cover for 10 minutes after the power supply is turned off.
- 2 Measure the voltage between terminals on the terminal block for power supply with a tester and confirm that the power supply is shut off.

In addition, measure the points, as shown in the figure below, with a tester and confirm that the voltage of the capacitor in the main circuit is less than 50 V DC.

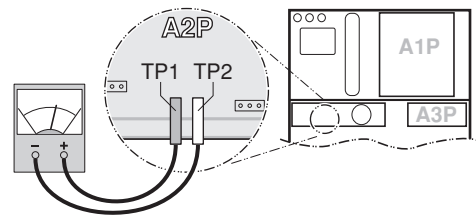

- 3 To prevent damaging the PC-board, touch a noncoated metal part to eliminate static electricity before pulling out or plugging in connectors.
- 4 The performing of the service to the inverter equipment must be started after the junction connectors X1A, X2A, X3A, X4A (X3A and X4A are for REYQ14+16 + REYHQ12 unit type only) for the fan motors in the outdoor unit are been pulled out. Be careful not to touch the live parts.
(If a fan rotates due to strong wind, it may store electricity in the capacitor or in the main circuit and cause electric shock.)
- 5 After the service is finished, plug the junction connector back in. Otherwise the error code E7 will be displayed on the remote controller and normal operation will not be performed.

For details refer to the wiring diagram labelled on the back of the electric box cover.

Pay attention to the fan. It is dangerous to inspect the unit while the fan is running. Be sure to turn off the main switch and to remove the fuses from the control circuit located in the outdoor unit.



NOTE Play it safe!

For protection of the PCB, touch the switch box casing by hand in order to eliminate static electricity from your body before performing service.

12.2. Checks before initial start-up

NOTE



Remark that during the first running period of the unit, required power input may be higher than stated on the nameplate of the unit. This phenomenon originates from the compressor that needs elapse of a 50 hours run in period before reaching smooth operation and stable power consumption.



- Make sure that the circuit breaker on the power supply panel of the installation is switched off.
- Attach the power wire securely.
- Introducing power with a missing N-phase or with a mistaken N-phase will break the equipment.

After the installation, check the following before switching on the circuit breaker:

- 1 The position of the switches that require an initial setting
Make sure that switches are set according to your application needs before turning the power supply on.
- 2 Power supply wiring and transmission wiring
Use a designated power supply and transmission wiring and make sure that it has been carried out according to the instructions described in this manual, according to the wiring diagrams and according to local and national regulations.
- 3 Pipe sizes and pipe insulation
Make sure that correct pipe sizes are installed and that the insulation work is properly executed.
- 4 Air tight test and vacuum drying
Make sure the air tight test and vacuum drying were completed.
- 5 Additional refrigerant charge
The amount of refrigerant to be added to the unit should be written on the included "Added Refrigerant" plate and attached to the rear side of the front cover.
- 6 Insulation test of the main power circuit
Measure the insulation resistance and check if the value is in accordance with relevant local and national regulations..
- 7 Installation date and field setting
Be sure to keep record of the installation date on the sticker on the rear of the upper front panel according to EN60335-2-40. and keep record of the contents of the field setting.

12.3. Field setting

If required, carry out field settings according to the following instructions. Refer to the service manual for more details.

Opening the switch box and handling the switches

When carrying out field settings, remove the inspection cover (1).

Operate the switches with an insulated stick (such as a ball-point pen) to avoid touching live parts.

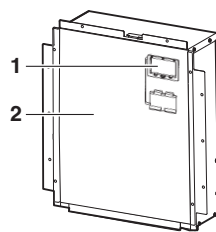

Make sure to re-attach the inspection cover (1) into the switch box cover (2) after the job is finished.

NOTE



Make sure that all outside panels, except for the panel on the electric box, are closed while working.

Close the lid of the electric box firmly before turning on the power.

Location of the dip switches, LEDs and buttons

- 1 LED H1~8P
- 2 Push button switches BS1~BS5
- 3 DIP switch 1 (DS1: 1~4)
- 4 DIP switch 2 (DS2: 1~4)
- 5 DIP switch 3 (DS3: 1~2)

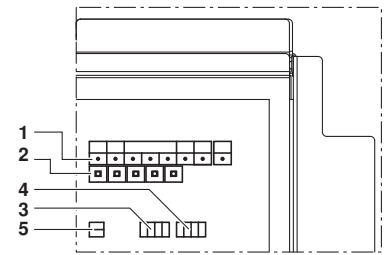

LED state

Throughout the manual the state of the LEDs is indicated as follows:

- OFF
- ☀ ON
- ⚡ Blinking

Setting the push button switch (BS1~5)

Function of the push button switch which is located on the outdoor unit PCB (A1P):

MODE	TEST: ☀	C/H SELECT				L.N.O.P	DEMAND	MULTI
	HWL: ☀	IND	MASTER	SLAVE				
● H1P	● H2P	☀ H3P	● H4P	● H5P	● H6P	● H7P	● H8P	

BS1 MODE	BS2 SET	BS3 RETURN	BS4 TEST	BS5 RESET
-------------	------------	---------------	-------------	--------------

- BS1 MODE** For changing the set mode
- BS2 SET** For field setting
- BS3 RETURN** For field setting
- BS4 TEST** For test operation
- BS5 RESET** For resetting the address when the wiring is changed or when an additional indoor unit is installed

The figure shows state of the LED indications when the unit is shipped from the factory.

Check operation procedure

- 1 Turn the power on for the outdoor unit and the indoor unit.
Be sure to turn the power on at least 6 hours before operation in order to have power running to the crankcase heater.
- 2 Make sure that transmission is normal by checking the LED display on the outdoor unit circuit board (A1P). (If transmission is normal, each LED will be displayed as shown below.)

LED display (Default status before delivery)	Micro-computer operation monitor	Mode	Ready/Error	Cooling/Heating changeover			Low noise	Demand	Multi
				Individual	Bulk (master)	Bulk (slave)			
	HAP	H1P	H2P	H3P	H4P	H5P	H6P	H7P	H8P
Single outdoor unit system	☀	●	●	☀	●	●	●	●	●
Multiple outdoor unit system	Master unit ^(a)	☀	●	☀	●	●	●	●	☀
	Slave unit 1 ^(a)	☀	●	●	●	●	●	●	⚡
	Slave unit 2 ^(a)	☀	●	●	●	●	●	●	●

(a) The state of the H8P (multi) LED in a multi-system shows which unit is the master unit (☀), slave 1 unit (⚡) or slave 2 unit (●). Only the master unit is connected to the indoor units with interunit wiring.

Setting the mode

The set mode can be changed with the **BS1 MODE** button according to the following procedure:

- **For setting mode 1:** Press the **BS1 MODE** button once, the H1P LED is off ●. This mode is not available for heat recovery units.
- **For setting mode 2:** Press the **BS1 MODE** button for 5 seconds, the H1P LED is on ☀.

If the H1P LED is blinking ☀ and the **BS1 MODE** button is pushed once, the setting mode will change to setting mode 1.

NOTE If you get confused in the middle of the setting process, push the **BS1 MODE** button. Then it returns to setting mode 1 (H1P LED is off).

Setting mode 2

The H1P LED is on.

Setting procedure

- 1 Push the **BS2 SET** button according to the required function (A~H). The LED indication that matches the required function is shown below in the field marked :

Possible functions

- A additional refrigerant charging operation.
- B refrigerant recovery operation/vacuuming operation.
- C automatic low noise operation setting at nighttime.
- D low noise operation level setting (**L.N.O.P**) via the external control adapter.
- E power consumption limitation setting (**DEMAND**) via the external control adapter.
- F enabling function of the low noise operation level setting (**L.N.O.P**) and/or power consumption limitation setting (**DEMAND**) via the external control adapter (DTA104A61/62).
- G high static pressure setting
- H evaporating temperature setting

	H1P	H2P	H3P	H4P	H5P	H6P	H7P
A	☀	●	☀	●	☀	●	●
B	☀	●	☀	●	☀	●	☀
C	☀	●	☀	●	☀	☀	●
D	☀	●	☀	☀	●	●	☀
E	☀	●	☀	☀	☀	☀	●
F	☀	●	●	☀	☀	●	●
G	☀	●	☀	●	●	☀	●
H	☀	●	●	☀	●	●	●

- 2 When the **BS3 RETURN** button is pushed, the current setting is defined.
 - 3 Push the **BS2 SET** button according to the required setting possibility as shown below in the field marked .
- 3.1 Possible settings for function A, B, F, and G are **ON** (ON) or **OFF** (OFF).

	H1P	H2P	H3P	H4P	H5P	H6P	H7P
ON	☀	●	●	●	●	☀	●
OFF ^(a)	☀	●	●	●	●	●	☀

(a) This setting = factory setting

3.2 Possible settings for function C

The noise of level 3 < level 2 < level 1 (▲1).

	H1P	H2P	H3P	H4P	H5P	H6P	H7P
OFF ^(a)	☀	●	●	●	●	●	●
▲1	☀	●	●	●	●	●	☀
▲2	☀	●	●	●	●	☀	●
▲3	☀	●	●	●	●	☀	☀

(a) This setting = factory setting

3.3 Possible settings for function D and E

For function D (**L.N.O.P**) only: the noise of level 3 < level 2 < level 1 (▲1).

For function E (**DEMAND**) only: the power consumption of level 1 < level 2 < level 3 (▲3).

	H1P	H2P	H3P	H4P	H5P	H6P	H7P
▲1	☀	●	●	●	●	●	☀
▲2 ^(a)	☀	●	●	●	●	☀	●
▲3	☀	●	●	●	☀	●	●

(a) This setting = factory setting

3.4 Possible settings for function H

The evaporating temperature level H (high) < level M (medium) < level L (low) (▲L).

	H1P	H2P	H3P	H4P	H5P	H6P	H7P
▲H	☀	●	●	●	●	●	☀
▲M ^(a)	☀	●	●	●	●	☀	●
▲L	☀	●	☀	●	●	●	●

(a) This setting = factory setting

- 4 Push the **BS3 RETURN** button and the setting is defined.
- 5 When the **BS3 RETURN** button is pushed again, the operation starts according to the setting.

Refer to the service manual for more details and for other settings.

Confirmation of the set mode

The following items can be confirmed by setting mode 1 (H1P LED is off)

Check the LED indication in the field marked .

- 1 Indication of the present operation state
 - ●, normal
 - ☀, abnormal
 - ☀, under preparation or under test operation

H1P	H2P	H3P	H4P	H5P	H6P	H7P
●	●	☀	●	●	●	●

- 2 Indication of low noise operation state **L.N.O.P**
 - ● standard operation (= factory setting)
 - ☀ **L.N.O.P** operation

H1P	H2P	H3P	H4P	H5P	H6P	H7P
●	●	☀	●	●	●	●

- 3 Indication of power consumption limitation setting **DEMAND**
 - ● standard operation (= factory setting)
 - ☀ **DEMAND** operation

H1P	H2P	H3P	H4P	H5P	H6P	H7P
●	●	☀	●	●	●	●

12.4. Test operation



Do not insert fingers, rods or other objects into the air inlet or outlet. When the fan is rotating at high speed, it will cause injury.



Do not perform the test operation while working on the indoor units.

When performing the test operation, not only the outdoor unit, but the connected indoor unit will operate as well. Working on a indoor unit while performing a test operation is dangerous.

- In case the unit is operated with the leak detection function available:
 - the outdoor temperature must be 0°C DB~43°C DB
 - the indoor temperature must be 20°C DB~32°C DB
 In case the unit is operated out of the temperature range as instructed above, the display of the remote controller shows U3 and the unit operates without the availability of the leak detection function.
- In the test operation, the following checks and judgement will be performed:
 - Check of the stop valve opening
 - Check for wrong wiring
 - Check of refrigerant overcharge
 - Initial refrigerant detection
- In case the leak detection function is available, the check operation will last 2 hours, otherwise it takes between 40 and 60 minutes to complete the check operation.
- Make sure to carry out the test operation after the first installation. Otherwise, the malfunction code U3 will be displayed on the remote controller and normal operation can not be carried out.
- In case of a multi system, check the settings and results on the master unit.
- Abnormalities on indoor units can not be checked for each unit individual. After the test operation is finished, check the indoor units one by one by performing a normal operation using the remote controller.

NOTE A test operation can not be carried out when the outdoor temperature is less than -5°C.

Test operation procedure

- 1 Close all front panels except the front panel of the electric box.
- 2 Turn ON the power to all outdoor units and the connected indoor units.
Be sure to turn on the power 6 hours before operation in order to have power running to the crank case heater and to protect the compressor.
- 3 Make the field setting as described in the paragraph "12.3. Field setting" on page 24.
- 4 Press the **BS1 MODE** button once, and set to the SETTING MODE (H1P LED = OFF).
- 5 **In case the leak detection function is required,** press and hold the **BS4 TEST** button down for 5 seconds or more. The unit will start the test operation.

In case the leak detection function is not required, go into setting mode 2 by pressing the **BS1 MODE** button for 5 seconds. The H1P LED is on \odot . Perform following steps.

1. Press the **BS2 SET** button 3 times.



2. Press the **BS3 RETURN** button once to confirm.



3. Press the **BS2 SET** button in order to change the LED display to the following display.



4. Press the **BS3 RETURN** button once to confirm.
5. Press the **BS3 RETURN** button a second time to start the test operation. The unit will start the test operation.

■ The test operation is automatically carried out in cooling mode, the H2P LED will light up and the messages "Test operation" and "Under centralized control" will display on the remote controller.

■ It may take 10 minutes to bring the state of the refrigerant uniform before the compressor starts.

■ During the test operation, the refrigerant running sound or the magnetic sound of a solenoid valve may become loud and the LED display may change, but these are not malfunctions.

■ During the test operation, it is not possible to stop the unit operation from a remote controller. To abort the operation, press the **BS3 RETURN** button. The unit will stop after ± 30 seconds.

- 6 Close the front panel in order to let it not be the cause of misjudgement.

- 7 Check the test operation results by the LED display on the outdoor unit.

	H1P	H2P	H3P	H4P	H5P	H6P	H7P
Normal completion	●	●	\odot	●	●	●	●
Abnormal completion	●	\odot	\odot	●	●	●	●

- 8 When the test operation is fully completed, normal operation will be possible after 5 minutes.

Otherwise, refer to "Correcting after abnormal completion of the test operation" on page 26 to take actions for correcting the abnormality.

Correcting after abnormal completion of the test operation

The test operation is only completed if there is no malfunction code displayed on the remote controller. In case of a displayed malfunction code, perform the following actions to correct the abnormality:

- Confirm the malfunction code on the remote controller

Installation error	Error code	Remedial action
The stop valve of an outdoor unit is left closed.	E3 E4 F3 F6 UF	Open the stop valve.
The phases of the power to the outdoor units are reversed.	U1	Exchange two of the three phases (L1, L2, L3) to make a positive phase connection.
No power is supplied to an outdoor or indoor unit (including phase interruption).	LC U1 U4	Check if the power wiring for the outdoor units are connected correctly.
Incorrect interconnections between units	UF	Check if the refrigerant line piping and the unit wiring are consistent with each other.
Refrigerant overcharge	E3 F6 UF	Recalculate the required amount of refrigerant from the piping length and correct the refrigerant charge level by recovering any excessive refrigerant with a refrigerant recovery machine.
Insufficient refrigerant	E4 F3	Check if the additional refrigerant charge has been finished correctly. Recalculate the required amount of refrigerant from the piping length and add an adequate amount of refrigerant.

Installation error	Error code	Remedial action
The refrigerant was not charged using the automatic charging function.	P7	Availability of the leak detection function requires the refrigerant to be charged using the automatic charging function. In case the leak detection function is required: see "Procedure for additional refrigerant charge" on page 19. In case the leak detection function is not required: see "12.4. Test operation" on page 26.
The added amount of refrigerant was not inputted after automatic charging.	PF	Availability of the leak detection function feature requires input of the additional refrigerant charge amount immediately after finishing the automatic charging. Refer to "11.6. Procedure for inputting the additional refrigerant charge weight into the PCB" on page 22.
In case the test operation was interrupted or the unit was operating out of the instructed temperature range, the initial refrigerant detection has failed.	U3	In case the test operation was interrupted, perform the test operation again. In case the unit was operating out of the instructed temperature range, the unit can still be operated normally, but the leak detection function will not be available. Perform the test operation again within the instructed temperature range.

- After correcting the abnormality, press the **BS3 RETURN** button and reset the malfunction code.
- Carry out the test operation again and confirm that the abnormality is properly corrected.

12.5. Final check after installation

After all installation works are completed, operate the unit normally and check the following:

- Make sure the indoor units and outdoor unit are operating normally.
- Operate each indoor unit separately and make sure the corresponding outdoor unit is also operating properly.
- Check if cold or hot air is coming out from the indoor unit.
- Push the fan direction and fan strength buttons on the remote controller to check if they are operating properly.

NOTE



- Heating is not possible if the outdoor temperature is 24°C or higher. Refer to the operation manual.
- If a knocking sound is heard in the liquid compression of the compressor, stop the unit immediately and then energize the crankcase heater for a sufficient length of time before restarting the operation.
- Once stopped, the compressor will not restart in about 5 minutes, even if the ON/OFF button on the remote controller is pushed.
- When the system operation is stopped by the remote controller, the outdoor unit may continue operation for a maximum of 5 minutes.
- The outdoor fan may rotate at low speeds in the night-time low noise setting or the external low noise level setting is made; but this is not a malfunction.

13. SERVICE MODE OPERATION

NOTE



Do not shut off the power and do not reset the setting of mode 2 when vacuuming or recovering refrigerant. Otherwise the expansion valves will close making it impossible to vacuum the system or to recover the refrigerant.

Vacuumping method

At the first installation, this vacuuming is not required. It is required only for repair purposes.

- 1 When the unit is at standstill and under the setting mode 2, set the required function B (refrigerant recovery operation/vacuumping operation) to **ON** (ON).
 - The indoor unit, BS unit and the outdoor unit expansion valves will fully open.
 - The H1P LED is on and the remote controller indicates **TEST** (test operation) and (external control) and the operation will be prohibited.
- 2 Evacuate the system with a vacuum pump.
- 3 Press the **BS1 MODE** button and reset the setting mode 2.

Refrigerant recovery operation method

by a refrigerant reclaimer

- 1 When the unit is at standstill and under the setting mode 2, set the required function B (refrigerant recovery operation/vacuumping operation) to **ON** (ON).
 - The indoor unit, BS unit and the outdoor unit expansion valves will fully open.
 - The H1P LED is on and the remote controller indicates **TEST** (test operation) and (external control) and the operation will be prohibited.
- 2 Recover the refrigerant by a refrigerant reclaimer. For details, see the operation manual delivered with the refrigerant reclaimer.
- 3 Press the **BS1 MODE** button and reset the setting mode 2.

14. ADDITIONAL REFRIGERANT CHARGING METHOD

When the leak detection function is not required and the entire refrigerant quantity can not be charged through the liquid pipe stop valve service port with the unit not operating (refer to "Pre-charging" on page 19), make sure to charge the remaining charging quantity using the following procedure:

- 1 Turn the power of the indoor unit, the BS unit and the outdoor unit on.
- 2 Make sure to open the stop valves of the suction gas pipe, the high pressure/low pressure gas pipe and the liquid pipe completely.
- 3 Connect the refrigerant charge hose to the refrigerant charging port (for additionally charging).
- 4 When the unit is not operating, push the **BS2 SET** button until the additional refrigerant charging operation function A in setting mode 2 can be defined (refer to "Setting the mode" on page 25), the H1P LED is on ().
- 5 The operation starts automatically.

The H2P LED will start flashing () and the messages "Test operation" and "Under centralized control" will display on the remote controller.

- 6 After charging the specified quantity of refrigerant, press the **BS3 RETURN** button to stop the operation.

The operation will stop within 30 minutes.

- If charging is not completed after 30 minutes, set and perform the additional refrigerant charging operation again.
- If the additional refrigerant charging operation stops before the passing of 30 minutes, the system may be overcharged.



Never charge extra refrigerant.

- 7 Disconnect the refrigerant charge hose.
- 8 Perform "11.7. Checks after adding refrigerant" as explained on page 23.

15. CAUTION FOR REFRIGERANT LEAKS

Introduction

The installer and system specialist shall secure safety against leakage according to local regulations or standards. The following standards may be applicable if local regulations are not available.

This system uses R410A as refrigerant. R410A itself is an entirely safe non-toxic, non-combustible refrigerant. Nevertheless care must be taken to ensure that air conditioning facilities are installed in a room which is sufficiently large. This assures that the maximum concentration level of refrigerant gas is not exceeded, in the unlikely event of major leak in the system and this in accordance to the local applicable regulations and standards.

Maximum concentration level

The maximum charge of refrigerant and the calculation of the maximum concentration of refrigerant is directly related to the humanly occupied space in to which it could leak.

The unit of measurement of the concentration is kg/m^3 (the weight in kg of the refrigerant gas in 1 m^3 volume of the occupied space).

Compliance to the local applicable regulations and standards for the maximum allowable concentration level is required.

According to the appropriate European Standard, the maximum allowed concentration level of refrigerant to a humanly space for R410A is limited to 0.44 kg/m^3 .

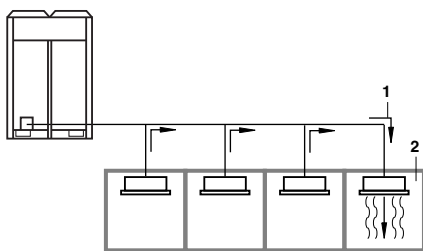

- 1 direction of the refrigerant flow
- 2 room where refrigerant leak has occurred (outflow of all the refrigerant from the system)

Pay special attention to places, such as a basements, etc. where refrigerant can stay, since refrigerant is heavier than air.

Procedure for checking maximum concentration

Check the maximum concentration level in accordance with steps 1 to 4 below and take whatever action is necessary to comply.

- 1 Calculate the amount of refrigerant (kg) charged to each system separately.

$$\begin{array}{l} \text{amount of} \\ \text{refrigerant in a} \\ \text{single unit system} \\ \text{(amount of} \\ \text{refrigerant with} \\ \text{which the system} \\ \text{is charged before} \\ \text{leaving the factory)} \end{array} + \begin{array}{l} \text{additional charging} \\ \text{amount (amount of} \\ \text{refrigerant added} \\ \text{locally in} \\ \text{accordance with} \\ \text{the length or} \\ \text{diameter of the} \\ \text{refrigerant piping)} \end{array} = \begin{array}{l} \text{total amount of} \\ \text{refrigerant (kg)} \\ \text{in the system} \end{array}$$

NOTE



Where a single refrigerant facility is divided into 2 entirely independent refrigerant systems, use the amount of refrigerant with which each separate system is charged.

- 2 Calculate the smallest room volume (m^3)

In a case such as the following, calculate the volume of (A), (B) as a single room or as the smallest room.

- A. Where there are no smaller room divisions

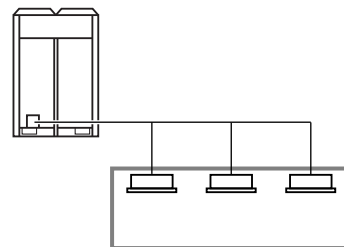

- B. Where there is a room division but there is an opening between the rooms sufficiently large to permit a free flow of air back and forth.

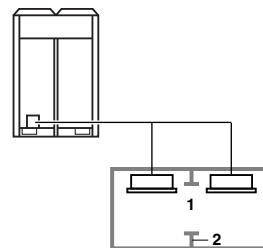

- 1 opening between rooms
- 2 partition
(Where there is an opening without a door or where there are openings above and below the door which are each equivalent in size to 0.15% or more of the floor area.)

- 3 Calculating the refrigerant density using the results of the calculations in steps 1 and 2 above.

$$\frac{\text{total volume of} \\ \text{refrigerant in the} \\ \text{refrigerant system}}{\text{size (m}^3\text{) of smallest} \\ \text{room in which there is} \\ \text{an indoor unit installed}} \leq \text{maximum concentration level} \\ \text{(kg/m}^3\text{)}$$

If the result of the above calculation exceeds the maximum concentration level then make similar calculations for the second then third smallest room and so until the result falls short of the maximum concentration.

- 4 Dealing with the situations where the result exceeds the maximum concentration level.

Where the installation of a facility results in a concentration in excess of the maximum concentration level then it will be necessary to revise the system. Please consult your supplier.

16. DISPOSAL REQUIREMENTS

Dismantling of the unit, treatment of the refrigerant, of oil and of other parts must be done in accordance with relevant local and national legislation.

NOTES

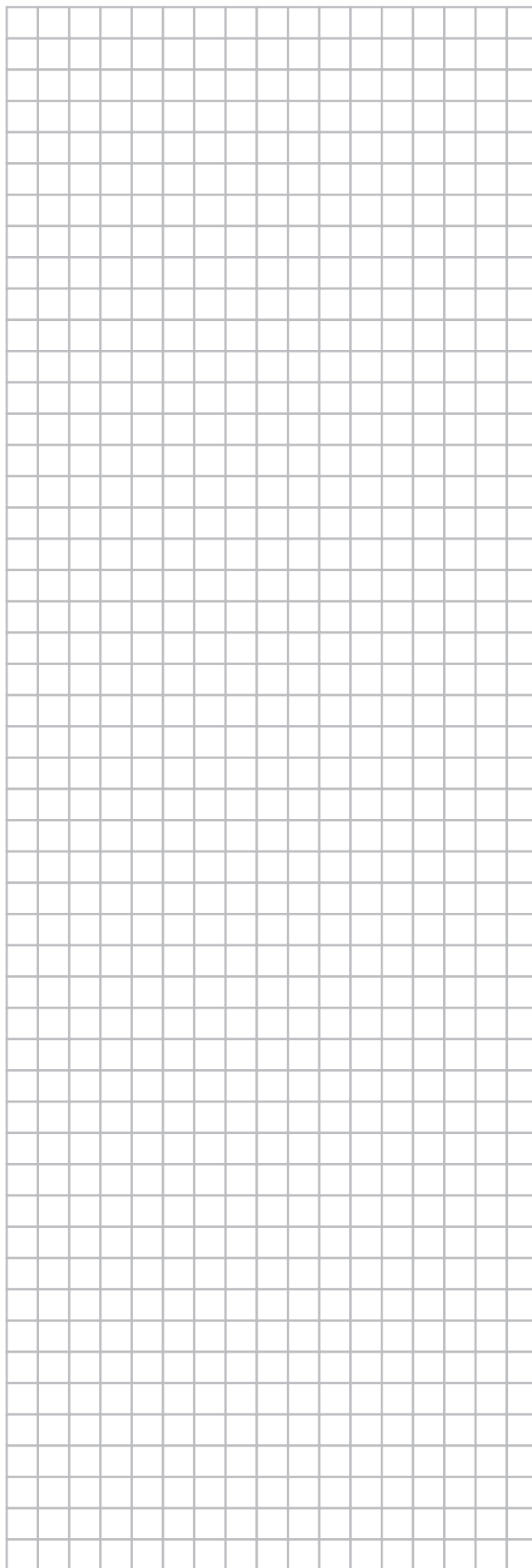
A large grid area for taking notes, consisting of 20 columns and 40 rows of small squares.

NOTES

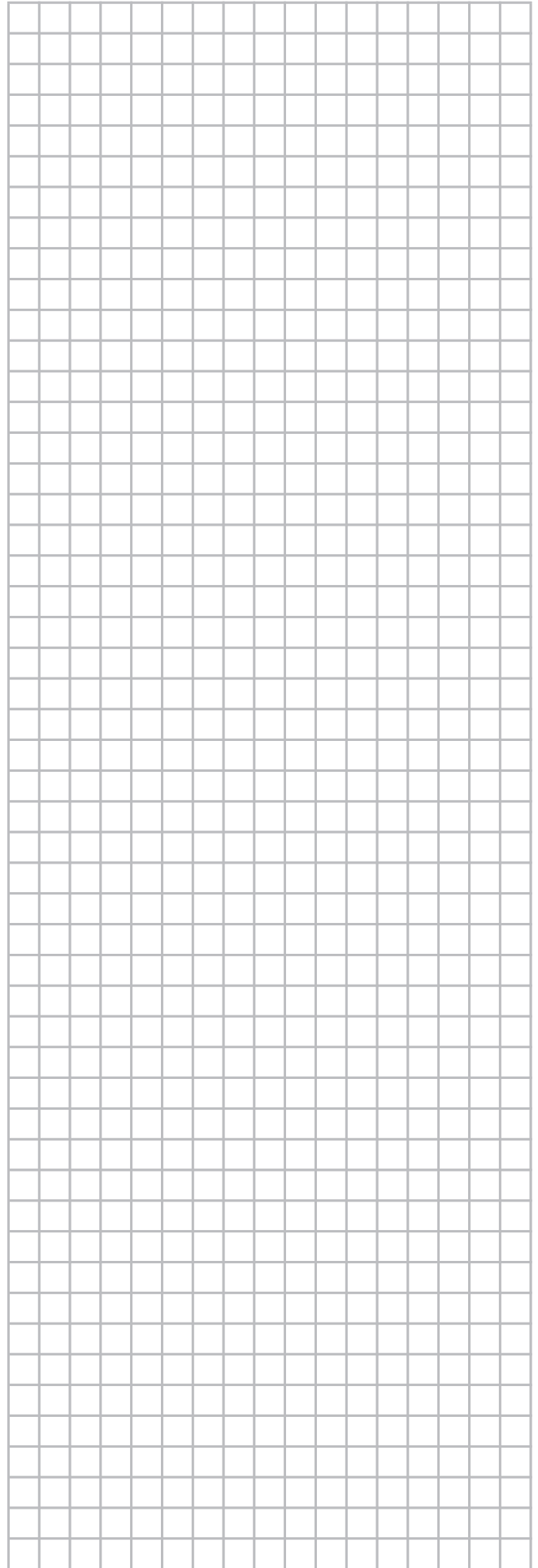
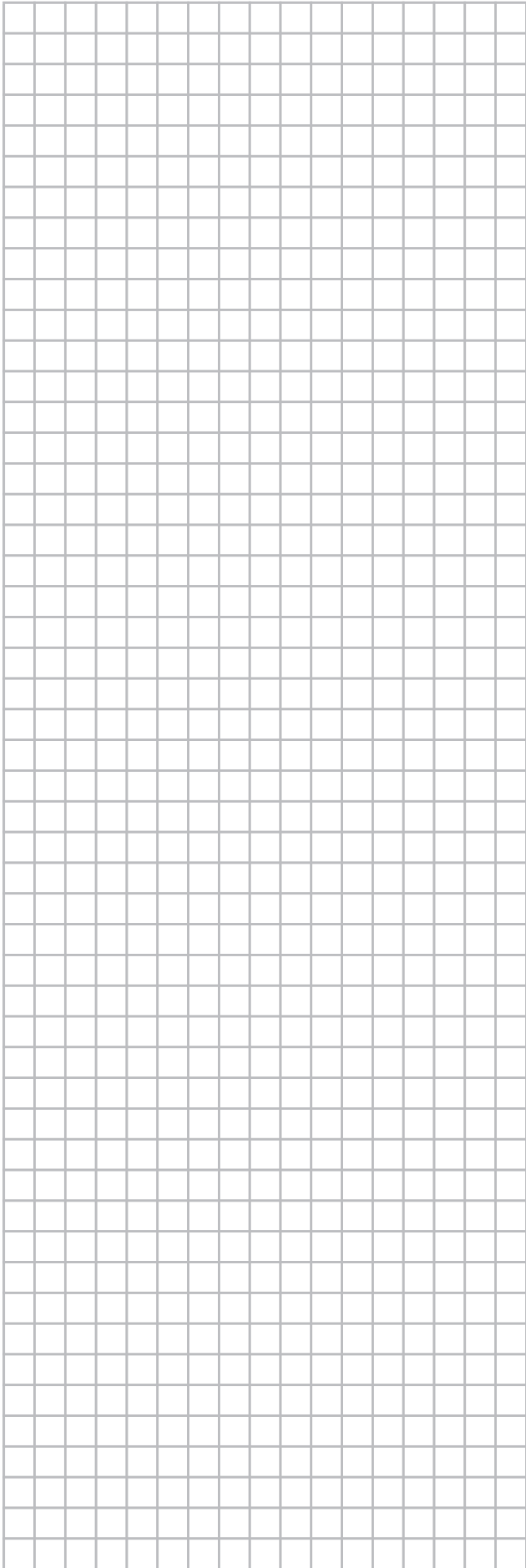



4PW48463-1 B 000000S

Copyright 2008 Daikin

DAIKIN EUROPE N.V.

Zandvoordestraat 300, B-8400 Oostende, Belgium

4PW48463-1B 07.2010